



**HF/50 MHz TRANSCEIVER**

**FTDX5000 SERIES**

**OPERATING MANUAL**



**VERTEX STANDARD CO., LTD.**

4-8 Nakameguro, Meguro-Ku, Tokyo 153-8644, Japan

**VERTEX STANDARD**

**US Headquarters**

10900 Walker Street, Cypress, CA 90630, U.S.A.

**YAESU UK LTD.**

Unit 12, Sun Valley Business Park, Winnall Close  
Winchester, Hampshire, SO23 0LB, U.K.

**VERTEX STANDARD HK LTD.**

Unit 5, 20/F., Seaview Centre, 139-141 Hoi Bun Road,  
Kwun Tong, Kowloon, Hong Kong

**VERTEX STANDARD (AUSTRALIA) PTY., LTD.**

Normanby Business Park, Unit 14/45 Normanby Road  
Notting Hill 3168, Victoria, Australia

---

---

## ABOUT THIS MANUAL . . .

---

---

The **FTdx5000** is a leading-edge transceiver with a number of new and exciting features, some of which may be unfamiliar to you. In order to gain the most enjoyment and operating efficiency from your **FTdx5000**, we recommend that you read this manual in its entirety, and keep it handy for reference as you explore the many capabilities of your new transceiver.

Before using your **FTdx5000**, be sure to read and follow the instructions in the “Before You Begin” section of this manual.

Congratulations on your purchase of the **FTdx5000** Yaesu amateur transceiver!

Whether this is your first rig, or Yaesu equipment is already the backbone of your station, rest assured this transceiver will provide many hours of operating pleasure for years to come.

The **FTdx5000** is an elite-class HF transceiver and will provide exceptional transmit and receive performance. The **FTdx5000** is designed for the most competitive operating situations, whether you operate in contests, DX, or digital-mode environments.

Built on the foundation of the popular **FTdx9000** transceiver, and carrying on the proud tradition of the **FT-1000** series, the **FTdx5000** provides up to 200 Watts of power output on SSB, CW, and FM (50 Watts AM carrier). Digital Signal Processing (DSP) is utilized throughout the design, providing leading edge performance on both transmit and receive.

Available as an option, the **DMU-2000** Data Management Unit will provide extensive display capabilities via a user-supplied computer monitor: Band Scope, Audio Scope, X-Y Oscilloscope, World Clock, Rotator Control, extensive transceiver status displays, and station logging capability.

The Yaesu-exclusive VRF (Variable RF Front-End Filter) provides exceptional protection from strong nearby signals, and serves as a high-performance Preselector, ideal for multi-operator contest environments. The filter is manually tuned, allowing the operator to optimize sensitivity or signal rejection with the turn of a knob. For the ultimate in receiver RF selectivity, the optional RF  $\mu$ -Tuning Kits may be connected via the rear panel, providing extraordinarily sharp selectivity and receiver protection from close-in interference on a crowded band.

Superb receiver performance is a direct legacy from the legendary **FTdx9000**, **FT-1000D**, and **FT-1000MP** transceivers. In the VFO-A receive front end, you may select one of two RF preamplifiers, or one of two IPO (Intercept Point Optimization) settings, and/or three levels of RF attenuation in 6-dB steps. The IPO settings provide direct feed to the first mixer (VFO-B has one IPO setting), Dual Receives are built into every **FTdx5000**. Both VFO-A and VFO-B receivers utilize DSP filtering, and incorporate many of the features of the **FTdx9000**, such as Variable Bandwidth, IF Shift, and Passband Contour tuning. Digital Noise Reduction and Digital Auto-Notch Filtering are also provided, along with a manually-tuned IF Notch filter. The Sub receiver, used for monitoring within the same band as the Main receiver, is ideal for watching both sides of a pile-up, or keeping an ear on a DX station that is working stations by call area, etc.

On the transmit side, the Yaesu-exclusive Three-Band Parametric Microphone Equalizer allows precise and flexible adjustment of the wave-form to complement your voice. The microphone Amplitude, Center Frequency, and Bandwidth may be adjusted independently for the low-frequency, mid-range, and high-audio-frequency spectra. The transmitted bandwidth may be adjusted, as well.

Advanced features include: Direct Keyboard Entry of frequency and Band Change, Speech Processor, IF Monitor for Voice modes, CW Pitch control, CW Spot switch, Full CW

QSK, adjustable IF Noise Blanker, and all-mode Squelch. Four TX/ RX antenna ports, plus a receive-only antenna port, are provided on the rear panel. The front and rear key jacks may be configured independently, for paddle input, connection to a straight key, or computer-driven keying interface. Both Digital Voice Recording and CW Message Memory are provided.

Three unique windows on the right side of the front panel, display the VFO-B frequency and graphically show the VFO-A and VFO-B DSP settings. In Menu Mode operation, these windows display the menu values, for easy setting.

Set up of frequency, band and mode is especially convenient on the **FTdx5000**. Besides direct frequency entry for both the Main and Sub VFOs, separate keys are provided for band selection. Each band key accesses three independent VFO frequency/mode/filter settings per band. You can establish separate VFO settings for three different parts of each band. The two (Main and Sub) VFOs allow simultaneous reception and display of two different frequencies, even in different modes and with different IF bandwidths. The Dual Receiver audio can be combined, or partially mixed in each headphone, or monitored separately in each ear.

In addition, 99 memories are provided to store: frequency, IF filter selection, clarifier offset, and scan-skip status. What's more, five quick-recall ("QMB") memories can instantly store operational settings at the push of a button.

The built-in automatic antenna tuner includes 100 memories of its own, to automatically store antenna matching settings for quick recall later.

Dedicated AFSK and FSK connection jacks on the rear panel provide simple Interfacing for digital modes. Optimization of the Passband filters, DSP settings, carrier insertion point, and display offset are all possible via the Menu programming system.

The Yaesu CAT system provides a direct link to the transceiver CPU for computer control and customization of tuning, scanning, and other operating functions. The **FTDX5000** includes a built-in data level converter for direct connection to a personal computer serial port. Yaesu products are supported by most of the leading contest and DX logging programs. The extensive programming protocol is described in the CAT System, if you wish to write your own software!

Advanced technology is only part of the **FTdx5000** story. Vertex Standard stands behind our products with a worldwide network of dealers and service centers. We greatly appreciate your investment in the **FTdx5000**, and we look forward to helping you get the most enjoyment from your new transceiver.

Please feel free to contact your nearest dealer, or one of Vertex Standard's national headquarters offices, for technical advice, interfacing assistance, or accessory recommendation.

Watch the Vertex Standard U.S.A. Home Page for late breaking information about Vertex, Standard Horizon, and Yaesu products: <http://www.vertexstandard.com>.

Please read this manual thoroughly, to gain maximum understanding of the full capability of the **FTdx5000**. We thank you again for your purchase!

# TABLE OF CONTENTS

<b>General Description</b> .....	1	<b>Advanced Interference-Suppression Features:</b>	
<b>Accessories &amp; Options</b> .....	4	<b>RF Front End</b> .....	54
Supplied Accessories .....	4	Using the VRF (Variable RF Front-end Filter) .....	54
Available Options .....	4	<b>Interference Rejection</b>	
<b>Before You Begin</b> .....	6	<b>(Signals Off Frequency by Just a Few kHz)</b> .....	56
Connecting AC Power .....	6	R.FLT (Roofing Filters) .....	56
Extending the Front Feet .....	6	<b>Interference Rejection (Signals within 3 kHz)</b> .....	58
Adjusting the Main Tuning Dial Torque .....	6	CONTOUR Control Operation .....	58
Resetting the Microprocessor .....	7	IF SHIFT Operation .....	60
Resetting Memories (Only) .....	7	WIDTH (IF DSP Bandwidth) Tuning .....	61
Menu Resetting .....	7	Using IF Shift and Width Together .....	62
Full Reset .....	7	IF Notch Filter Operation .....	63
<b>Installation and Interconnections</b> .....	8	Digital Noise Reduction (DNR) Operation .....	64
Antenna Considerations .....	8	Digital Notch Filter (DNF) Operation .....	64
About Coaxial Cable .....	8	NARROW (NAR) One-Touch IF Filter Selection .....	65
Grounding .....	9	IF Noise Blanker (NB) Operation .....	66
Connection of Antenna and Power Cables .....	10	<b>Tools for Comfortable and Effective Reception</b> .....	67
Connection of Microphone and Headphone .....	11	AGC (Automatic Gain Control) .....	67
Key, Keyer, and Computer-Driven Keying		SLOPED AGC Operation .....	68
Interconnections .....	12	Mute Feature (VFO-A Band) .....	69
VL-1000 Linear Amplifier Interconnections .....	13	Adjustable Receiver Audio Filter .....	69
Interfacing to Other Linear Amplifiers .....	14	<b>SSB/AM Mode Transmission</b> .....	70
<b>Plug/Connector Pinout Diagrams</b> .....	15	<b>Using the Automatic Antenna Tuner</b> .....	72
<b>Front Panel Controls &amp; Switches</b> .....	16	ATU Operation .....	72
<b>Display Indications</b> .....	30	About ATU Operation .....	73
<b>Rear Panel</b> .....	33	<b>Enhancing Transmit Signal Quality</b> .....	74
<b>FH-2 Switches</b> .....	36	Parametric Microphone Equalizer .....	74
<b>Basic Operation: Receiving on Amateur Bands</b> .....	37	Using the Speech Processor .....	76
CLAR (Clarifier) Operation on Main (VFO-A) .....	40	Adjusting the SSB Transmitted Bandwidth .....	77
LOCK .....	41	Low-Distortion CLASS-A Operation .....	78
DIM .....	41	<b>Transmitter Convenience Features</b> .....	80
Operation on 60-Meter (5 MHz) Band		Voice Memory .....	80
(U.S. version only) .....	41	VOX (Automatic TX/RX Switching using Voice Control) .....	81
<b>Convenience Features</b> .....	42	MONITOR .....	81
Dual Receive .....	42	Split Operation Using the TX Clarifier .....	82
Using Headphones for Dual Receive .....	43	Split-Frequency Operation .....	83
Sideband Diversity Reception .....	43	VFO Tracking Feature .....	83
Bandwidth Diversity Reception .....	44	Quick Split Operation .....	84
P.BACK (Audio Playback) from			
Main (VFO-A) Receiver .....	45		
“MY Bands” Operation .....	46		
Band Stack Operation .....	47		
C.S (Custom Switch) .....	47		
Rotator Control Functions .....	48		
More Frequency Navigation Techniques .....	49		
Keyboard Frequency Entry .....	49		
Using the [▲(UP)]/[▼(DOWN)] Buttons .....	49		
Using the UP/DOWN switches of			
the supplied MH-31B8 Hand Microphone .....	49		
Receiver Operation (Front End Block Diagram) ...	50		
IPO (Intercept Point Optimization) .....	51		
ATT .....	52		
RF Gain (SSB/CW/AM Modes) .....	53		

# TABLE OF CONTENTS

<b>CW Mode Operation</b> .....	<b>86</b>	<b>VFO and Memory Scanning</b> .....	<b>107</b>
Setup for Straight Key		VFO Scanning .....	107
(and Straight Key emulation) Operation .....	86	Memory Scan .....	108
Using the Built-in Electronic Keyer .....	88	<b>PMS</b> .....	<b>109</b>
Full Break-in (QSK) Operation .....	89	<b>Packet Operation</b> .....	<b>110</b>
Setting the Keyer Weight		Packet Setup (Including Subcarrier Frequency) ..	110
(Dot/Space:Dash) Ratio .....	90	Basic Setup .....	110
Selecting the Keyer Operating Mode .....	90	<b>RTTY (Radio Teletype) Operation</b> .....	<b>111</b>
<b>CW Convenience Features</b> .....	<b>91</b>	Setting Up for RTTY Operation .....	111
CW Spotting (Zero-Beating) .....	91	Basic Setup .....	111
Using CW Reverse .....	92	<b>Miscellaneous AFSK-Based Data Modes</b> .....	<b>112</b>
Audio Peak Filter .....	92	<b>About the Transverter Output Terminal</b> .....	<b>114</b>
CW Delay Time Setting .....	93	Setup .....	114
CW Pitch Adjustment .....	93	Operation .....	115
Contest Memory Keyer .....	94	<b>Menu Mode</b> .....	<b>116</b>
Message Memory .....	94	Using the Menu .....	116
Transmitting in the Beacon Mode .....	95	Menu Mode Reset .....	116
TEXT Memory .....	96	AGC Group .....	121
Contest Number Programming .....	97	DISPLAY Group .....	121
Decrementing the Contest Number .....	97	DVS Group .....	122
<b>FM Mode Operation</b> .....	<b>98</b>	KEYER Group .....	123
Basic Operation .....	98	GENERAL Group .....	124
Repeater Operation .....	99	MODE-AM Group .....	125
<b>Memory Operation</b> .....	<b>100</b>	MODE-CW Group .....	126
Convenient Memory functions .....	100	MODE-DAT Group .....	127
QMB (Quick Memory Bank) .....	101	MODE-FM Group .....	128
Regular Memory Operation .....	102	MODE-RTY Group .....	128
Memory Storage .....	102	MODE-SSB Group .....	129
Memory Channel Recall .....	102	RX AUDIO Group .....	130
Checking a Memory Channel's Status .....	103	RX GNRL Group .....	130
Erasing Memory Channel Data .....	103	RX DSP Group .....	131
Moving Memory Data to the VFO-A .....	104	SCOPE Group .....	132
Memory Tune Operation .....	104	TUNING Group .....	133
Memory Groups .....	105	TX AUDIO Group .....	134
Memory Group Assignment .....	105	TX GNRL Group .....	136
Choosing the Desired Memory Group .....	105	<b>Specifications</b> .....	<b>138</b>
<b>Operation on Alaska Emergency Frequency:</b>		<b>Installation of the Optional Roofing Filter</b> .....	<b>140</b>
<b>5167.5 kHz (U.S. Version Only)</b> .....	<b>106</b>	<b>Index</b> .....	<b>142</b>

# ACCESSORIES & OPTIONS

---

---

## SUPPLIED ACCESSORIES

---

---

Hand Microphone ( <b>MH-31B8</b> )	1 pc	A07890001
Remote Control Keypad ( <b>FH-2</b> )	1 pc	A07890001
AC Power Cord	1 pc	T9017882: USA T9013285: Europe T9013283A: Australia
4-pin DIN Plug	1 pc	P0091004
5-pin DIN Plug	1 pc	P0091006
1/4-inch 3-contact Plug	1 pcs	P0091513
3.5 mm 3-contact Plug	1 pcs	P0091046
3.5 mm 2-contact Plug	1 pcs	P0090034
RCA Plug	2 pcs	P0091365
Operating Manual	1 pc	
Warranty Card	1 pc	
<b>SM-5000</b> Station Monitor	1 pc	( <b>FTDx5000MP</b> and <b>FTDx5000D</b> version only)

---

---

## AVAILABLE OPTIONS

---

---

<b>MD-200A8X</b>	Ultra-High-Fidelity Desk-Top Microphone
<b>YH-77STA</b>	Lightweight Stereo Headphone
<b>SM-5000</b>	Station Monitor (It is attached with <b>FTDx5000MP</b> and <b>FTDx5000D</b> )
<b>SP-2000</b>	External Speaker with Audio Filter
<b>VL-1000/VP-1000</b>	Linear Amplifier/AC Power Supply
<b>DMU-2000</b>	Data Management Unit
<b>RF <math>\mu</math>Tuning Kit A</b>	For 160 m Band
<b>RF <math>\mu</math>Tuning Kit B</b>	For 80/40 m Bands
<b>RF <math>\mu</math>Tuning Kit C</b>	For 30/20 m Bands
<b>FH-2</b>	Remote Control Keypad
<b>YF-126CN</b>	CW Narrow Filter (C/F: 9 MHz, B/W: 300 Hz) (It is installed with <b>FTDx5000MP</b> )
<b>T9101556</b>	Antenna Rotator Connection Cable



# BEFORE YOU BEGIN

## CONNECTING AC POWER

The **FTDx5000** is equipped with a universal power supply supporting 100 V to 264 V AC.

Therefore, the **FTDx5000** will operate on a voltage range from 100V to 264 V without changing a voltage select switch. Just use the power plug that matches your wall outlet.

## EXTENDING THE FRONT FEET

In order to elevate the front panel for easy viewing, the front left and right feet of the bottom case may be extended.

- ① Pull the front legs outward from the bottom panel.
- ② Rotate the legs counter-clockwise to lock them in the extended position. Be sure the legs have locked securely in place, because the transceiver is quite heavy and an unlocked leg could result in damage, should the transceiver move suddenly.

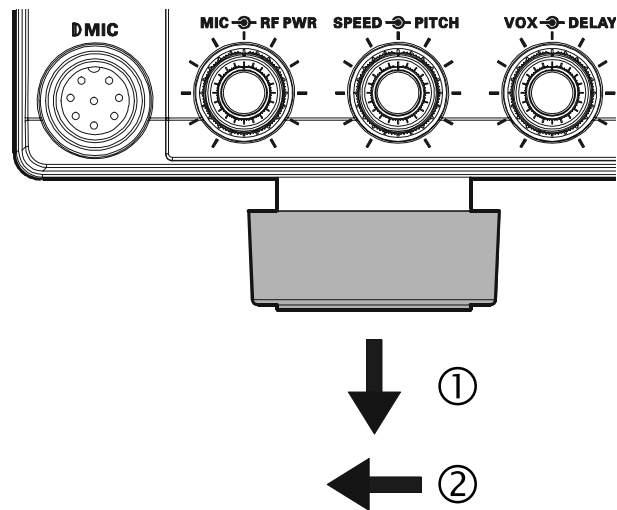

### Retracting the Front Feet

- ① Rotate the legs clockwise, and push them inward while rotating to the right.
- ② The front feet should now be locked in the retracted position.

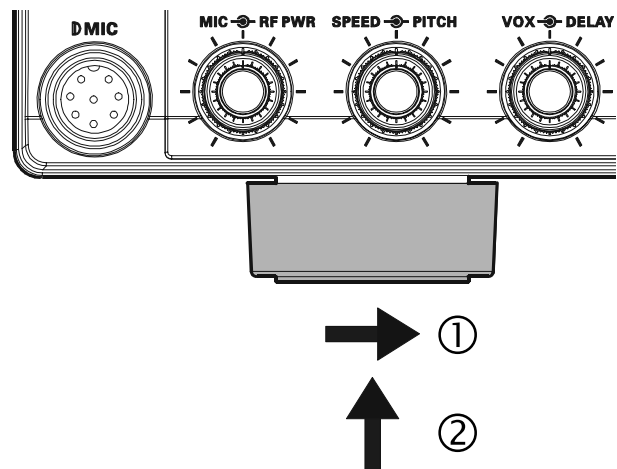

## ADJUSTING THE MAIN TUNING DIAL TORQUE

The torque (drag) of the Main Tuning Dial knob may be adjusted according to your preferences. Simply hold down the rear skirt of the knob, and while holding it in place rotate the knob itself to the right to reduce the drag or to the left to increase the drag.

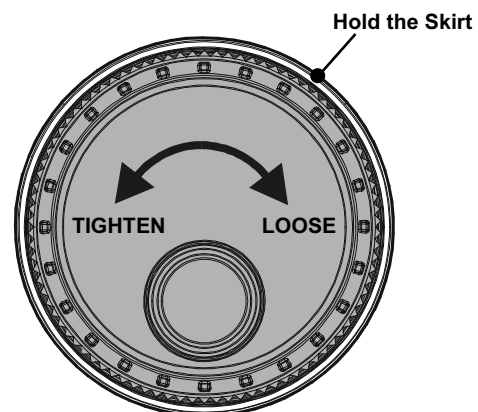



## RESETTING THE MICROPROCESSOR

### RESETTING MEMORIES (ONLY)

Use this procedure to reset (clear out) the previously stored Memory channels, without affecting any configuration changes you may have made to the Menu settings.

1. Press the front panel **[POWER]** switch to turn the transceiver off.
2. Press and hold in the **[A▶M]** button; while holding it in, press and hold in the front panel **[POWER]** switch to turn the transceiver on. Once the transceiver comes on, release the buttons.

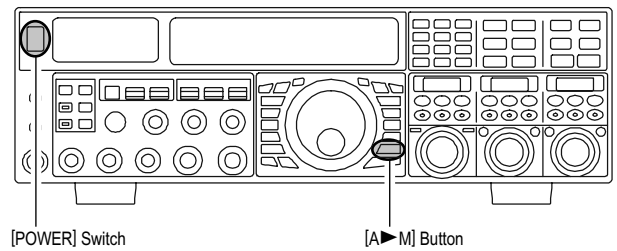

### MENU RESETTING

Use this procedure to restore the Menu settings to their factory defaults, without affecting the memories you have programmed.

1. Press the front panel **[POWER]** switch to turn the transceiver off.
2. Press and hold in the **[MENU]** button; while holding it in, press and hold in the front panel **[POWER]** switch to turn the transceiver on. Once the transceiver comes on, release the buttons.

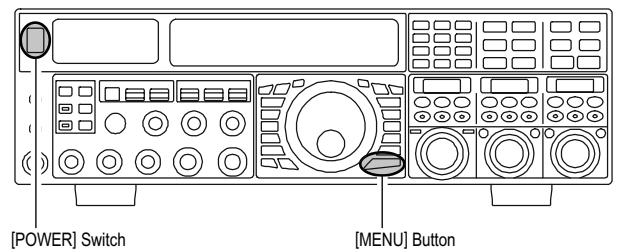

### FULL RESET

Use this procedure to restore all Menu and Memory settings to their original factory defaults. All Memories will be cleared out by this procedure.

1. Press the front panel **[POWER]** switch to turn the transceiver off.
2. Press and hold in the **[FAST]** and **[LOCK]** buttons; while holding them in, press and hold in the front panel **[POWER]** switch to turn the transceiver on. Once the transceiver comes on, release the switches.

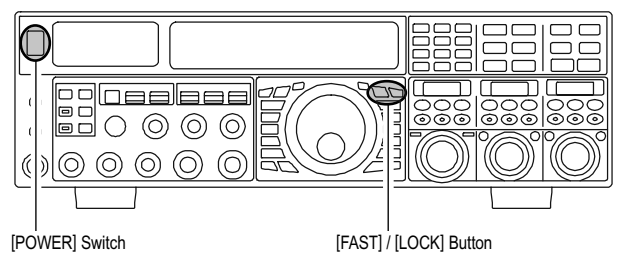

# INSTALLATION AND INTERCONNECTIONS

## ANTENNA CONSIDERATIONS

The **FTdx5000** is designed for use with any antenna system providing a 50 Ohm resistive impedance at the desired operating frequency. While minor excursions from the 50-Ohm specification are of no consequence, if the Standing Wave Ratio (SWR) present at the Antenna jack is greater than 3:1, the Antenna Tuner may not be able to reduce the impedance mismatch to an acceptable value.

It is very important, therefore, to ensure that the impedance of the antenna system utilized with the **FTdx5000** be as close as possible to the specified 50-Ohm value.

Note that the "G5RV" type antenna does not provide a 50-Ohm impedance on all HF Amateur bands, and an external wide range antenna coupler must be used with this antenna type.

Any antenna to be used with the **FTdx5000** must, ultimately, be fed with 50 Ohm coaxial cable. Therefore, when using a "balanced" antenna such as a dipole, remember that a balun or other matching/balancing device must be used to ensure proper antenna performance.

The same precautions apply to any additional (receive-only) antennas connected to the RX ANT jack; if your receive-only antennas do not have an impedance near 50 Ohms at the operating frequency, you may need to install an external antenna tuner to obtain optimum performance.

## ABOUT COAXIAL CABLE

Use high-quality 50-Ohm coaxial cable for the lead-in to your **FTdx5000** transceiver. All efforts at providing an efficient antenna system will be wasted if poor quality, lossy coaxial cable is used. This transceiver utilizes standard "M" ("PL-259") type connectors, except for the "RX OUT" BNC connector.

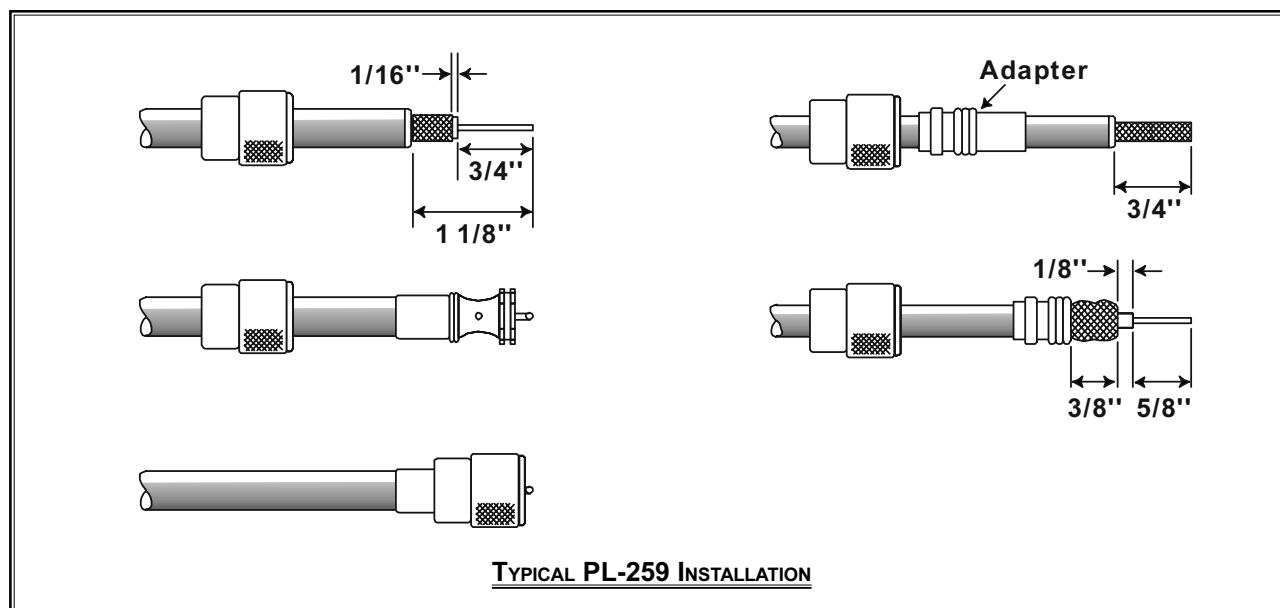

# INSTALLATION AND INTERCONNECTIONS

## GROUNDING

The **FTdx5000** transceiver, like any other HF communications apparatus, requires an effective ground system for maximum electrical safety and best communications effectiveness. A good ground system can contribute to station efficiency in a number of ways:

- It can minimize the possibility of electrical shock to the operator.
- It can minimize RF currents flowing on the shield of the coaxial cable and the chassis of the transceiver; such currents may lead to radiation which can cause interference to home entertainment devices or laboratory test equipment.
- It can minimize the possibility of erratic transceiver/accessory operation caused by RF feedback and/or improper current flow through logic devices.

An effective earth ground system may take several forms; for a more complete discussion, see an appropriate RF engineering text. The information below is intended only as a guideline.

Typically, the ground connection consists of one or more copper-clad steel rods, driven into the ground. If multiple ground rods are used, they should be positioned in a “V” configuration, and bonded together at the apex of the “V” which is nearest the station location. Use a heavy, braided cable (such as the discarded shield from type RG-213 coaxial cable) and strong cable clamps to secure the braided cable(s) to the ground rods. Be sure to weatherproof the connections to ensure many years of reliable service. Use the same type of heavy, braided cable for the connections to the station ground bus (described below).

Inside the station, a common ground bus consisting of a copper pipe of at least 25 mm (1”) diameter should be used. An alternative station ground bus may consist of a wide copper plate (single-sided circuit board material is ideal) secured to the bottom of the operating desk. Grounding connections from individual devices such as transceivers, power supplies, and data communications devices (TNCs, etc.) should be made directly to the ground bus using a heavy, braided cable.

Do not make ground connections from one electrical device to another, and thence to the ground bus. This so-called “Daisy-Chain” grounding technique may nullify any attempt at effective radio frequency grounding. See the drawing below for examples of proper grounding techniques.

Inspect the ground system inside and outside of the station, on a regular basis to ensure maximum performance and safety.

Besides following the above guidelines carefully, note that household or industrial gas lines must never be used in an attempt to establish an electrical ground. Cold water pipes may, in some instances, help in the grounding effort, but gas lines represent a significant explosion hazard, and must never be used.

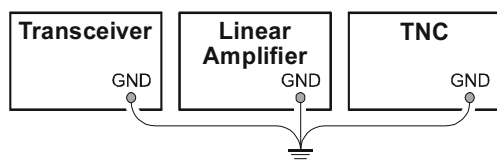

**PROPER GROUND CONNECTION**

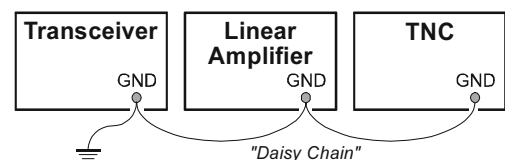

**IMPROPER GROUND CONNECTION**

# INSTALLATION AND INTERCONNECTIONS

## CONNECTION OF ANTENNA AND POWER CABLES

Follow the below illustration and advice regarding the proper connection of antenna coaxial cables, ground cable, and the AC power cable.

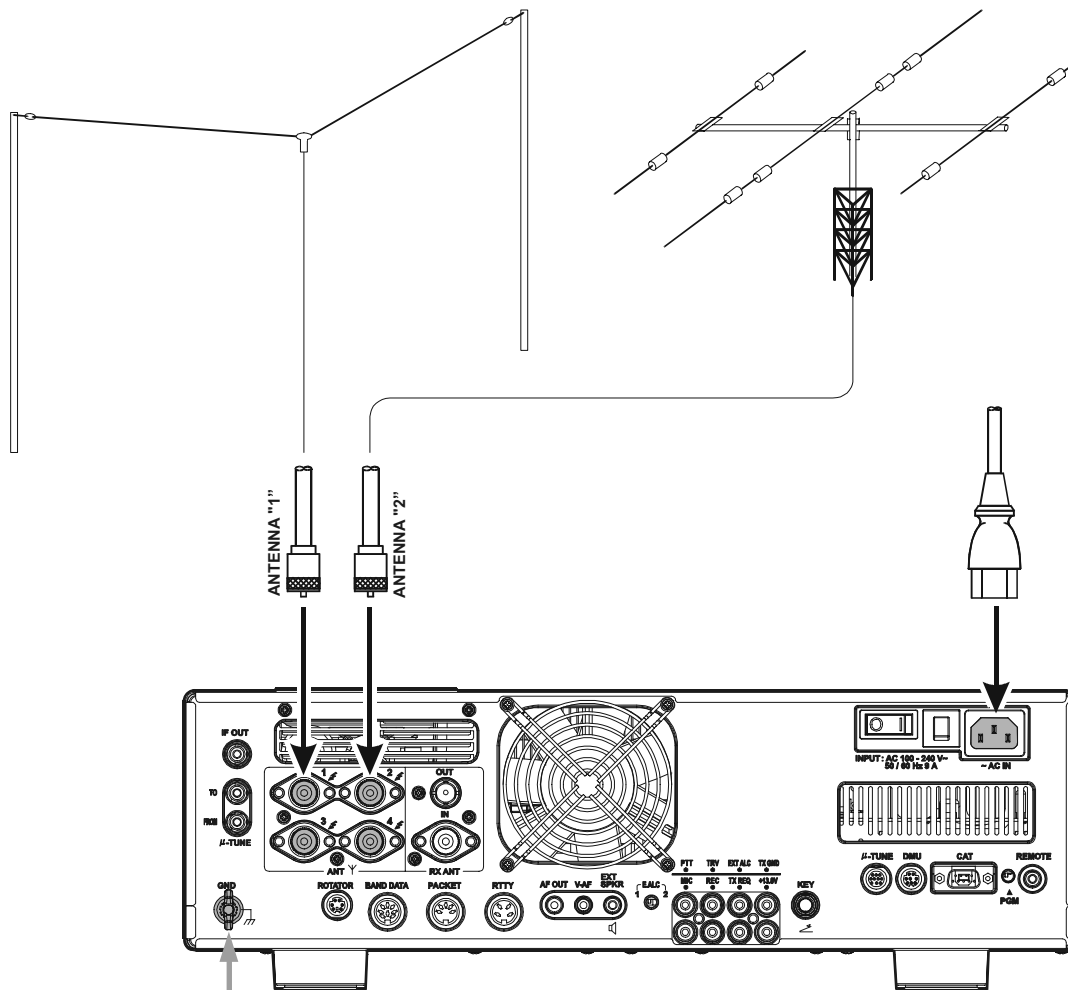

Use a short, thick, braided cable to connect your station equipment to the buried ground rod (or alternative earth ground system).

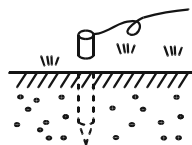

### ADVICE:

- Do not place the transceiver in a location with direct exposure to sunshine.
- Do not place the transceiver in a location exposed to dust and/or high humidity.
- Ensure adequate ventilation around the transceiver, to prevent heat build-up and possible reduction of performance due to high heat.
- Do not install the transceiver in a mechanically-unstable location, or where objects may fall onto this product from above.
- To minimize the possibility of interference to home entertainment devices, take all precautionary steps including separation of TV/FM antennas from Amateur transmitting antennas to the greatest extent possible. Keep transmitting coaxial cables separated from cables connected to home entertainment devices.
- Ensure that the AC power cord is not subject to undue stress or bending, which could damage the cable or cause it to be accidentally unplugged from the rear panel AC input jack.
- Be absolutely certain to install your transmitting antenna(s) such that they cannot possibly come in contact with TV/FM radio or other antennas, nor with outside power or telephone lines.

# INSTALLATION AND INTERCONNECTIONS

## CONNECTION OF MICROPHONE AND HEADPHONE

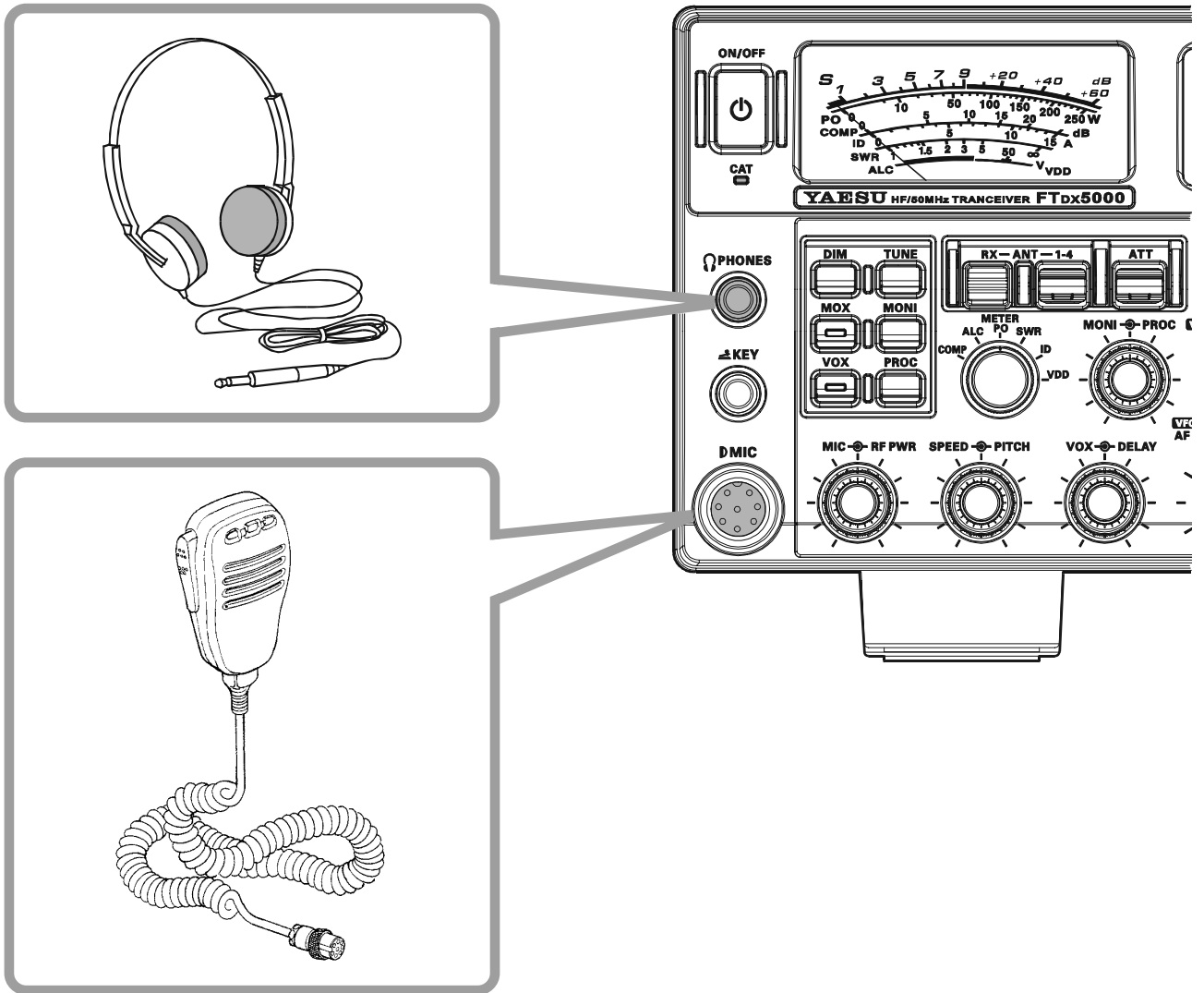

# INSTALLATION AND INTERCONNECTIONS

## KEY, KEYSER, AND COMPUTER-DRIVEN KEYING INTERCONNECTIONS

The **FTDx5000** includes a host of features for the CW operator. These functions will be detailed in the “Operation” section later. An Electronic Keyer is built-in, and two key jacks are provided, one on the front and one on the rear panel, for convenient connection to keying devices.

The Menu system allows you to configure the front and rear panel **KEY** jacks according to the device you wish to connect. For example, you may connect your keyer paddle to the front panel **KEY** jack, and use Menu item “054 A1A F-TYPE” for paddle input, while connecting the rear panel **KEY** jack to the keying line from your personal computer (which emulates a “straight key” for connection purposes), and configure the rear panel jack using Menu item “056 A1A R-TYPE”.

Both **KEY** jacks on the **FTDx5000** utilize “Positive” keying voltage. Key-up voltage is approximately +5V DC, and key-down current is approximately 1 mA. When connecting a key or other device to the **KEY** jacks, use *only* a 3-pin (“stereo”) 1/4” phone plug; a 2-pin plug will place a short between the ring and (grounded) shaft of the plug, resulting in a constant “key-down” condition in some circumstances.

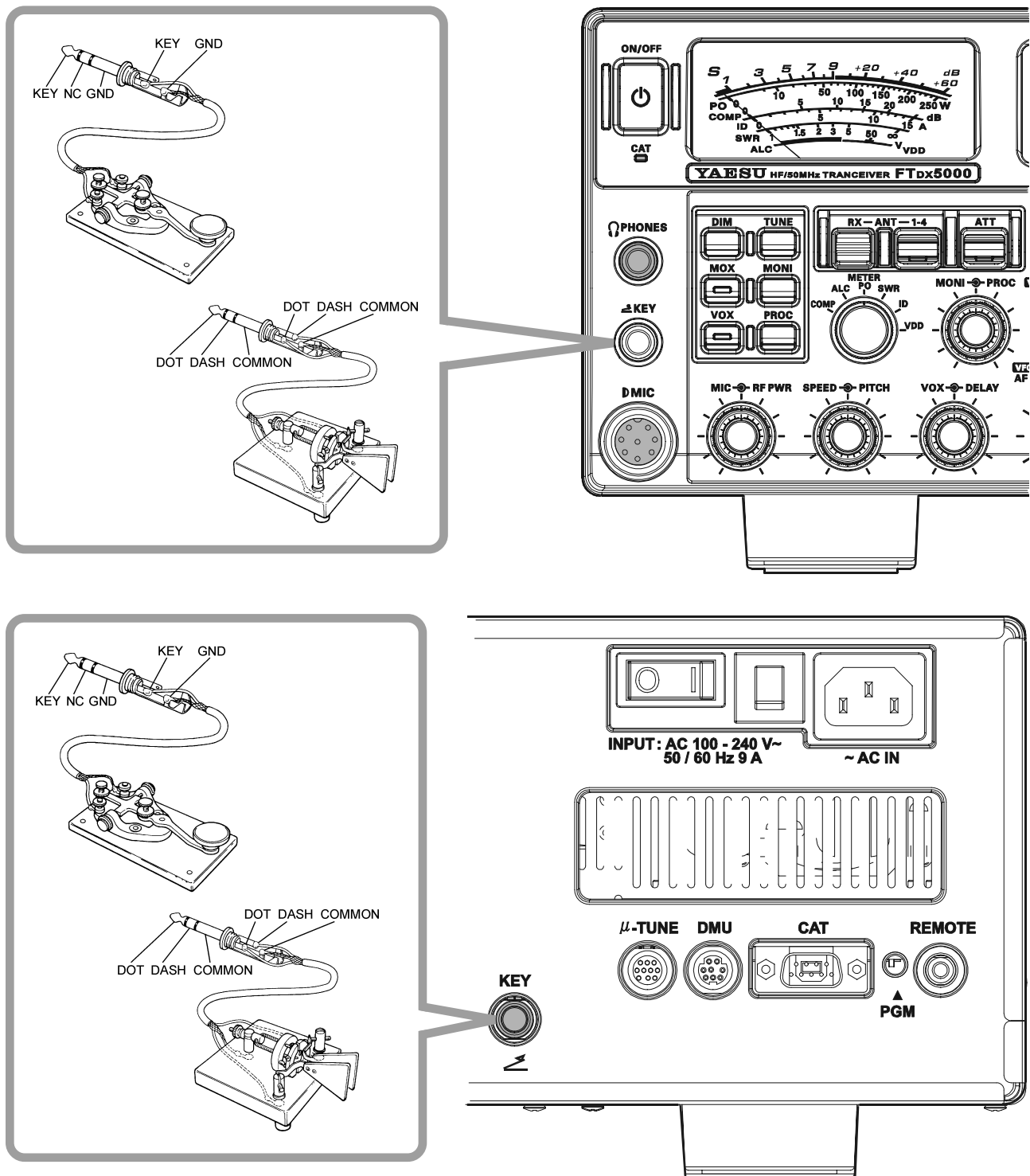

# INSTALLATION AND INTERCONNECTIONS

## VL-1000 LINEAR AMPLIFIER INTERCONNECTIONS

Be sure both the **FTDx5000** and **VL-1000** are turned off, then follow the installation recommendations contained in the illustration.

### NOTE:

- ❑ Refer to the **VL-1000** Operating Manual for details regarding amplifier operation.
- ❑ Do not attempt to connect or disconnect coaxial cables when your hands are wet.

### About the CONTROL Cable

The VL-1000 may be operated with the FTDx5000 whether or not the CONTROL Cable is connected; however, the CONTROL Cable allows you to tune up the amplifier automatically by just pressing the [F SET] or [TUNE] key on the VL-1000, to transmit a carrier for tuning purposes.

To link the FTDx5000 and VL-1000 Power switches, set the VL-1000 REMOTE switch to the "ON" position.

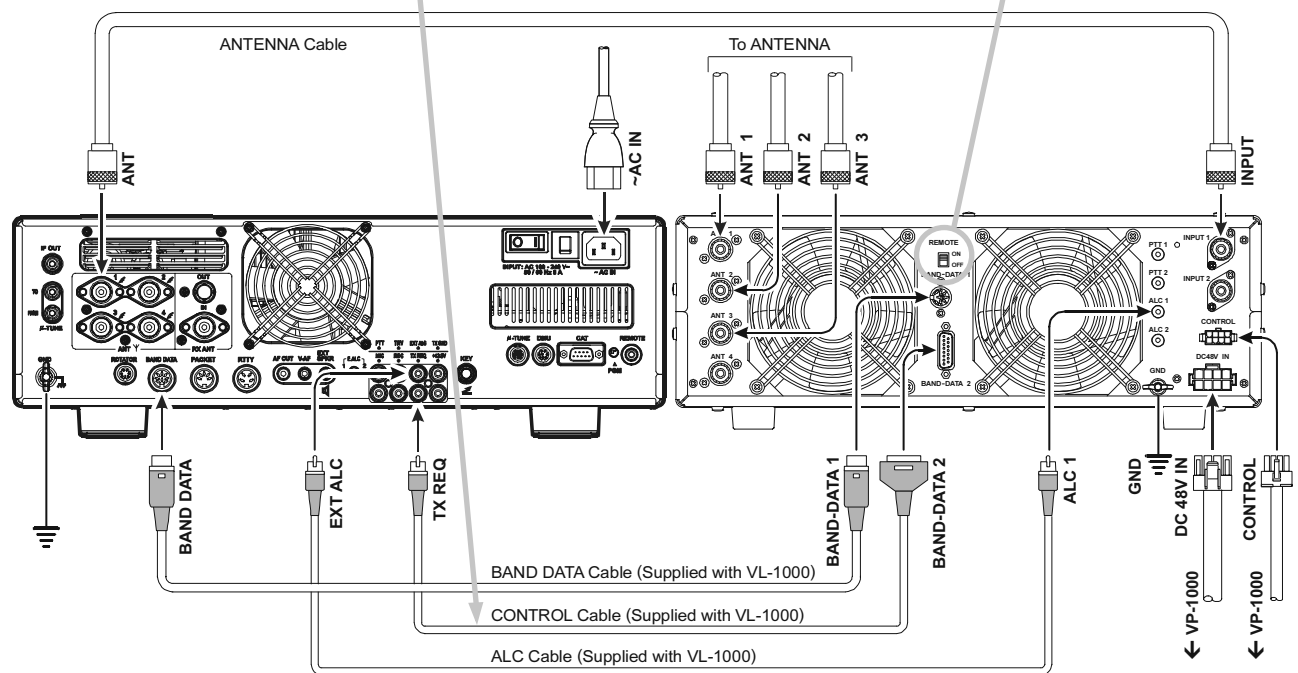

# INSTALLATION AND INTERCONNECTIONS

## INTERFACING TO OTHER LINEAR AMPLIFIERS

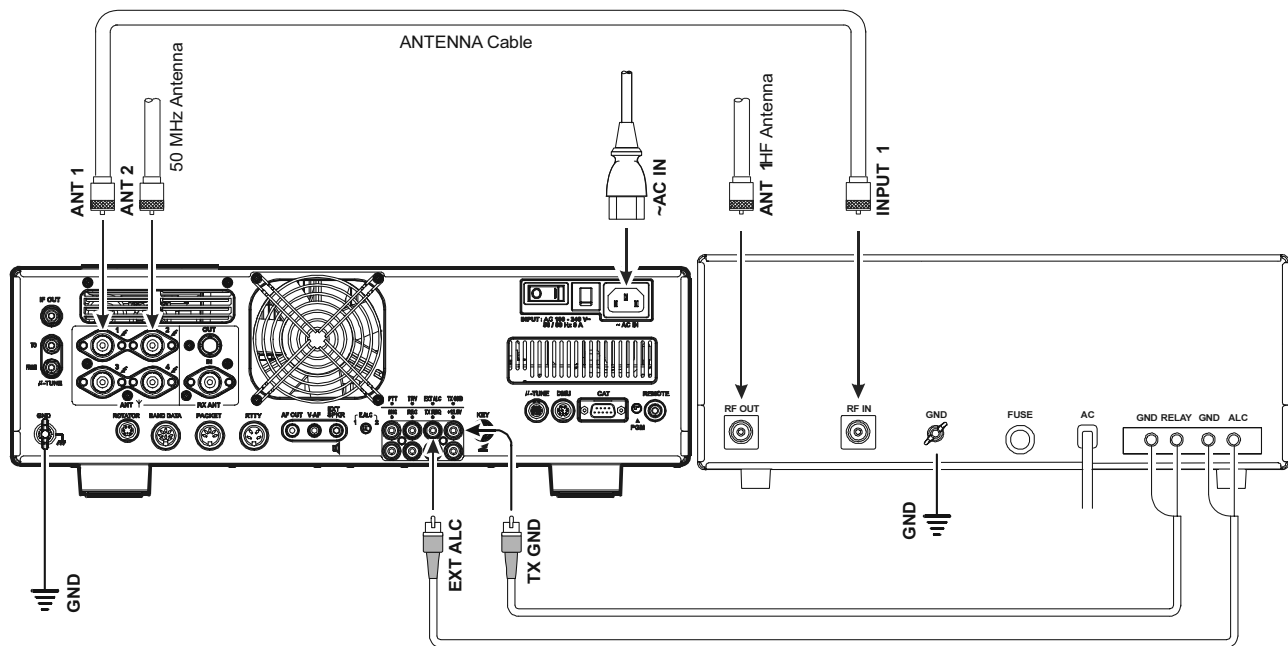





### NOTE

- ❑ The TX/RX switching in the linear amplifier is controlled by switching components in the transceiver. The relay circuit of the **FTdx5000** used for this switching is capable of switching AC voltage of 100 Volts at up to 300 mA, or DC voltages of 60 V at 200 mA or 30 V at up to 1 Amp. To activate the amplifier switching relay, set Menu item “172 TGEN ETX-GND” to “ENABLE”.
- ❑ The specified range for ALC voltage to be used with the **FTdx5000** is 0 to -4 Volts DC.
- ❑ Amplifier systems utilizing different ALC voltages will not work correctly with the **FTdx5000**, and their ALC lines must not be connected if this is the case.

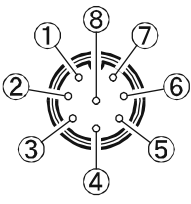
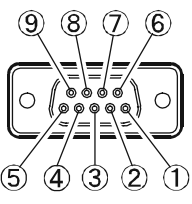
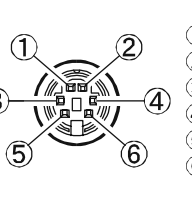
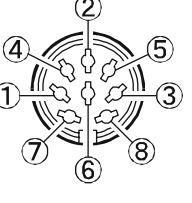
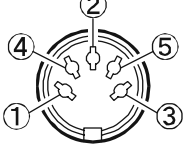

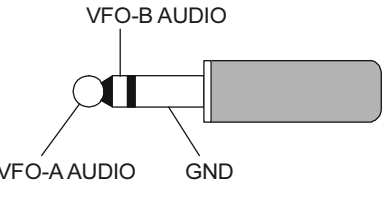
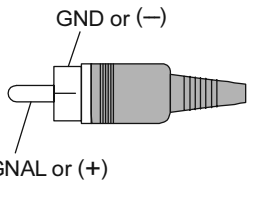
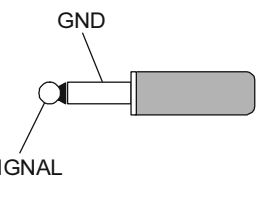
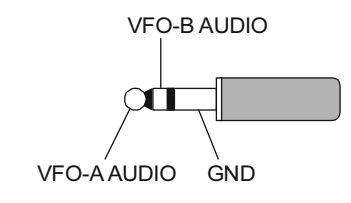
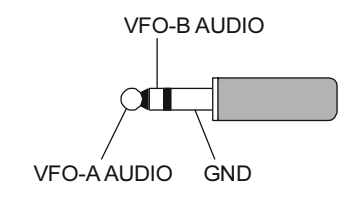
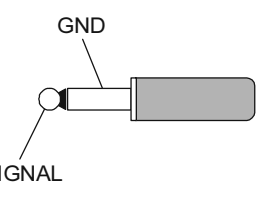
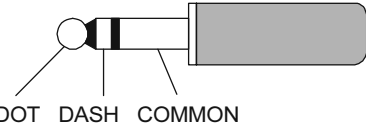
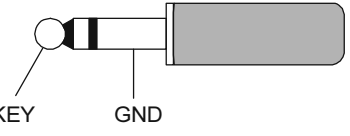
# PLUG/CONNECTOR PINOUT DIAGRAMS

MIC	CAT	ROTATOR
 <ul style="list-style-type: none"> <li>① UP</li> <li>② +5V</li> <li>③ DOWN</li> <li>④ FAST</li> <li>⑤ GND</li> <li>⑥ PTT</li> <li>⑦ MIC GND</li> <li>⑧ MIC</li> </ul> <p>(as viewed from front panel)</p>	 <ul style="list-style-type: none"> <li>① N/A</li> <li>② SERIAL OUT</li> <li>③ SERIAL IN</li> <li>④ N/A</li> <li>⑤ GND</li> <li>⑥ N/A</li> <li>⑦ RTS</li> <li>⑧ CTS</li> <li>⑨ NC</li> </ul> <p>(as viewed from rear panel)</p>	 <ul style="list-style-type: none"> <li>① CW ROTATION</li> <li>② CCW ROTATION</li> <li>③ SPEED</li> <li>④ DIRECTION</li> <li>⑤ GND</li> <li>⑥ NC</li> </ul> <p>(as viewed from rear panel)</p>
BAND DATA	PACKET	RTTY
 <ul style="list-style-type: none"> <li>① +13V</li> <li>② TX GND</li> <li>③ GND</li> <li>④ BAND DATA A</li> <li>⑤ BAND DATA B</li> <li>⑥ BAND DATA C</li> <li>⑦ BAND DATA D</li> <li>⑧ TX INH</li> </ul> <p>(as viewed from rear panel)</p>	 <ul style="list-style-type: none"> <li>① DATA IN</li> <li>② GND</li> <li>③ PACKET PTT</li> <li>④ DATA OUT</li> <li>⑤ BUSY</li> </ul> <p>(as viewed from rear panel)</p>	 <ul style="list-style-type: none"> <li>① SHIFT</li> <li>② RX OUT</li> <li>③ PTT</li> <li>④ GND</li> </ul> <p>(as viewed from rear panel)</p>
PHONE	RCA PLUG	REMOTE
 <p>VFO-B AUDIO</p> <p>VFO-A AUDIO      GND</p>	 <p>GND or (-)</p> <p>SIGNAL or (+)</p>	 <p>GND</p> <p>SIGNAL</p>
V-AF	AF OUT	EXT SPKR
 <p>VFO-B AUDIO</p> <p>VFO-A AUDIO      GND</p>	 <p>VFO-B AUDIO</p> <p>VFO-A AUDIO      GND</p>	 <p>GND</p> <p>SIGNAL</p>
KEY		
<p><b>For Internal Keyer</b></p>  <p>DOT      DASH      COMMON</p>		<p><b>For Straight Key</b></p>  <p>KEY      GND</p>
<p style="text-align: right;"> Do not use 2-conductor type plug</p>		

## IMPORTANT NOTE:

The  $\mu$ -TUNE and DMU use special connectors for this transceiver. Do not connect any accessory or other device not specifically approved by Vertex Standard. Failure to observe this precaution may cause damage not covered by the Limited Warranty on this apparatus.

# FRONT PANEL CONTROLS & SWITCHES

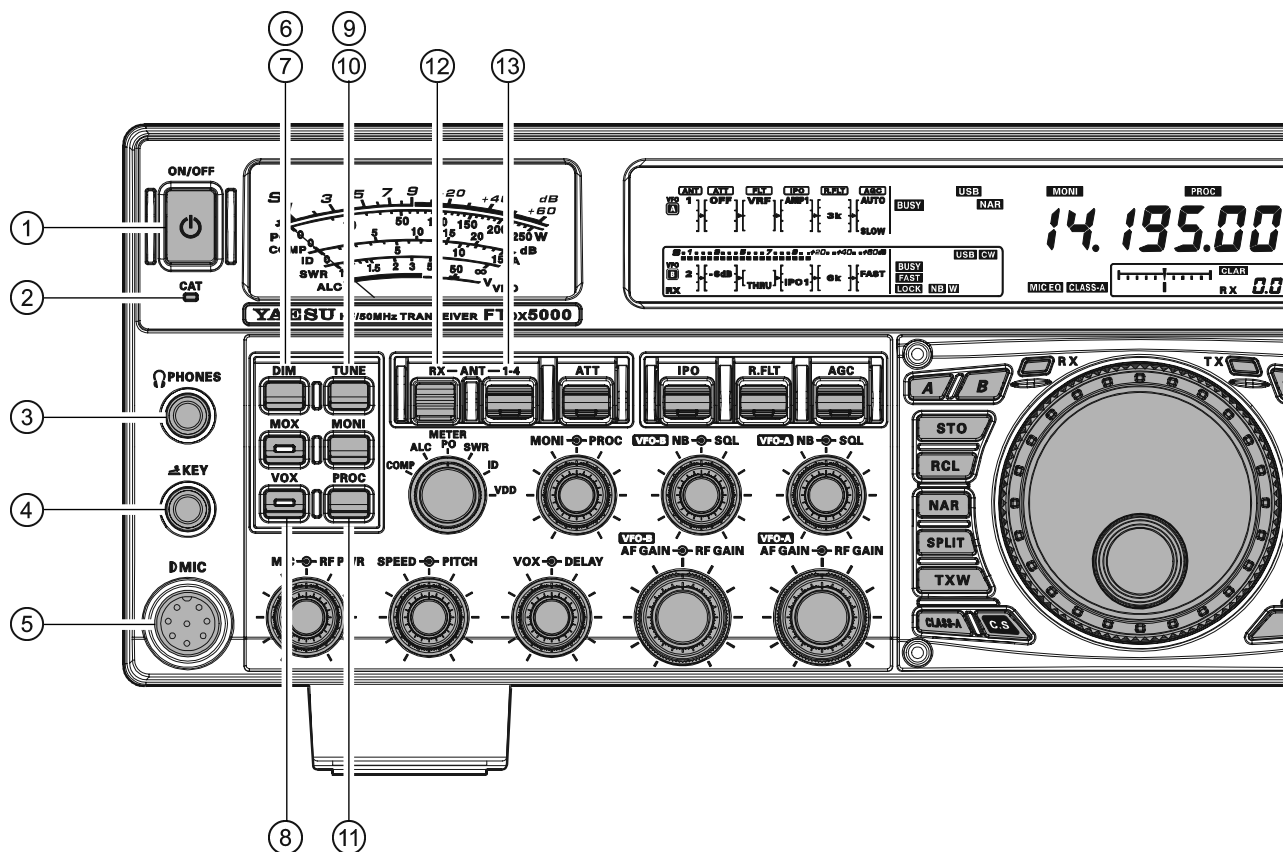

## ① [POWER] Switch

Press this switch in for two seconds to turn the transceiver on. Alternately, press this switch for two seconds to turn the transceiver off. If the rear panel [MAIN POWER] switch is set to the “O” (OFF) position, the front panel [POWER] switch will not function.

### ADVICE:

- ❑ If you press this switch briefly while the transceiver is turned on, the transceiver audio will be muted for three seconds.
- ❑ This is the actual power On/Off switch for turning the transceiver on. In the MP version, when the rear panel [MAIN POWER] switch is set to the “I” (ON) position, power is supplied to the OCXO to stabilize the reference oscillator. The remainder of the transceiver is set in a “stand-by” mode. For further information on the rear panel [MAIN POWER] switch, please see the discussion on page 35.

## ② CAT Indicator

This LED indicator will flash red when serial CAT command signals are being exchanged.

### ADVICE:

You may disable the LED CAT command signal flashing function, via Menu item “035 GENE CAT IND.” See page 124 for details.

## ③ PHONES Jack

A 1/4-inch, 3-contact jack accepts either monaural or stereo headphones with 2- or 3-contact plugs. When a plug is inserted, the loudspeaker is disabled. With stereo headphones such as the optional YH-77STA, you can monitor both VFO-A and VFO-B receiver channels at the same time during Dual Receive operation.

### NOTE:

When wearing headphones, we recommend that you turn the AF Gain levels down to their lowest settings before turning power on, to minimize the impact of any audio “pops” on your hearing during switch-on.

## ④ KEY Jack

This 1/4-inch, 3-contact jack accepts a CW key or keyer paddles (for the built-in electronic keyer), or output from an external electronic keyer. Pinout is shown on page 15. Key up voltage is 5 V, and key down current is 1 mA. This jack may be configured for keyer, “Bug,” “straight key,” or computer interface keying operation via Menu item “057 A1A F-TYPE” (see page 126). There is another KEY jack on the rear panel, and it may be configured independently for Internal Keyer or pseudo-straight-key operation.

### NOTE:

You cannot use a 2-contact plug in this jack (to do so produces a constant “key down” condition).

## ⑤ Microphone Connector

This 8-pin jack accepts input from a microphone utilizing a traditional YAESU HF-transceiver pinout.

# FRONT PANEL CONTROLS & SWITCHES

## ⑥ [DIM] Switch

Press this button to lower the illumination intensity of the analog meter and the frequency display. Press it once more to restore full brightness.

### ADVICE:

The following Menu items allow you to configure the dimming levels of each display independently to customize the brightness levels.

**008 DISP DIM MTR:** for analog meter

**009 DISP DIM VFD:** for frequency display

**010 DISP DIM OLE:** **SUB DISPLAY** windows

**011 DISP DIM ELCD:** for Spectrum Scope display of the optional **SM-5000** Station Monitor

## ⑦ [MOX] Switch

Pressing this button engages the PTT (Push to Talk) circuit, to activate the transmitter. The LED inside the button will glow red during transmit. It must be turned off (the red LED will be off) for reception. This button replicates the action of the Push to Talk (PTT) switch on the microphone. When engaging the [MOX] button or otherwise starting a transmission, be certain you have either an antenna or 50-Ohm dummy load connected to the selected Antenna jack.

## ⑧ [VOX] Switch

This button enables automatic voice-actuated transmitter switching in the SSB, AM, and FM modes. While activated, the LED inside the button glows red. Proper adjustment of the front panel [VOX] and [DELAY] knobs will make hands-free voice-actuated operation possible.

## ⑨ [TUNE] Switch

This is the on/off switch for the **FTdx5000**'s Automatic Antenna Tuner.

Pressing this button briefly, places the antenna tuner in line between the transmitter final amplifier and the antenna jack (The "**TUNER**" icon will appear in the display). Reception is not affected.

Pressing this button for 1/2 second, while receiving in an amateur band, activates the transmitter for a few seconds while the automatic antenna tuner rematches the antenna system impedance for minimum SWR. The resulting setting is automatically stored in one of the antenna tuner's 100 memories, for instant automatic recall later when the receiver is tuned near the same frequency.

Pressing this button briefly, while the Tuner is engaged, will take the Automatic Antenna tuner out of the transmit line.

### NOTE:

A signal is being transmitted while the tuner is matching the antenna impedance. Therefore, be certain there is a dummy load or antenna connected to the selected antenna jack before initiating the tuning sequence.

## ⑩ [MONI] (Monitor) Switch

This button enables the transmit monitor in all modes. While activated, the "**MONI**" icon appears in the display. Use the [MONI] knob to adjust the Monitor level.

### ADVICE:

The Monitor is highly useful for making adjustments to the Parametric Equalizer, or other voice characteristic adjustments, while listening with headphones. The voice quality heard in the headphones is a "natural" reproduction of the transmitted audio.

## ⑪ [PROC] (Processor) Switch

This button enables the Speech Processor for SSB transmission. While activated, the "**PROC**" icon appears in the display. Adjustment of the Processor level is accomplished using the [PROC] knob.

### ADVICE:

The Speech Processor uses a compression technique to increase the average power output. However, if the [PROC] knob is advanced too far, the increase in compression becomes counter-productive, and intelligibility will suffer. We recommend that you monitor the sound of your signal using the Monitor (with headphones).

When the optional **DMU-2000** Data Management Unit is connected, you may use the Audio Scope/Oscilloscope function to help you adjust the setting of the Speech Processor compression level for optimum performance with your voice and microphone.

## ⑫ [RX ANT] Switch

Press this button to use an antenna connected to the RX ANT jack on the rear panel for receive.

The "**RX**" icon appears in the display when the RX ANT is used.

## ⑬ [ANT 1-4] Switch

Move this knob up or down to conveniently select one of the four antenna jacks on the rear panel. The selected antenna jack is indicated in the ANT column of the Block Diagram Display.

### ADVICE:

Press this knob in briefly to quickly select the ANT 1 jack.

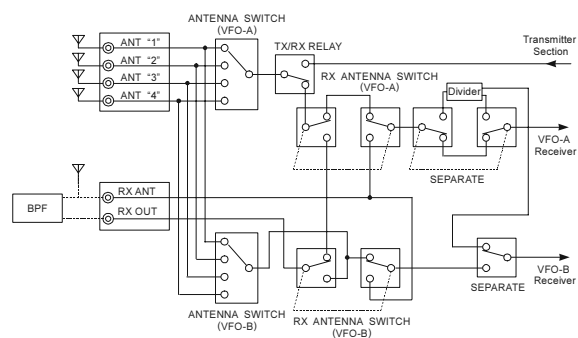

# FRONT PANEL CONTROLS & SWITCHES

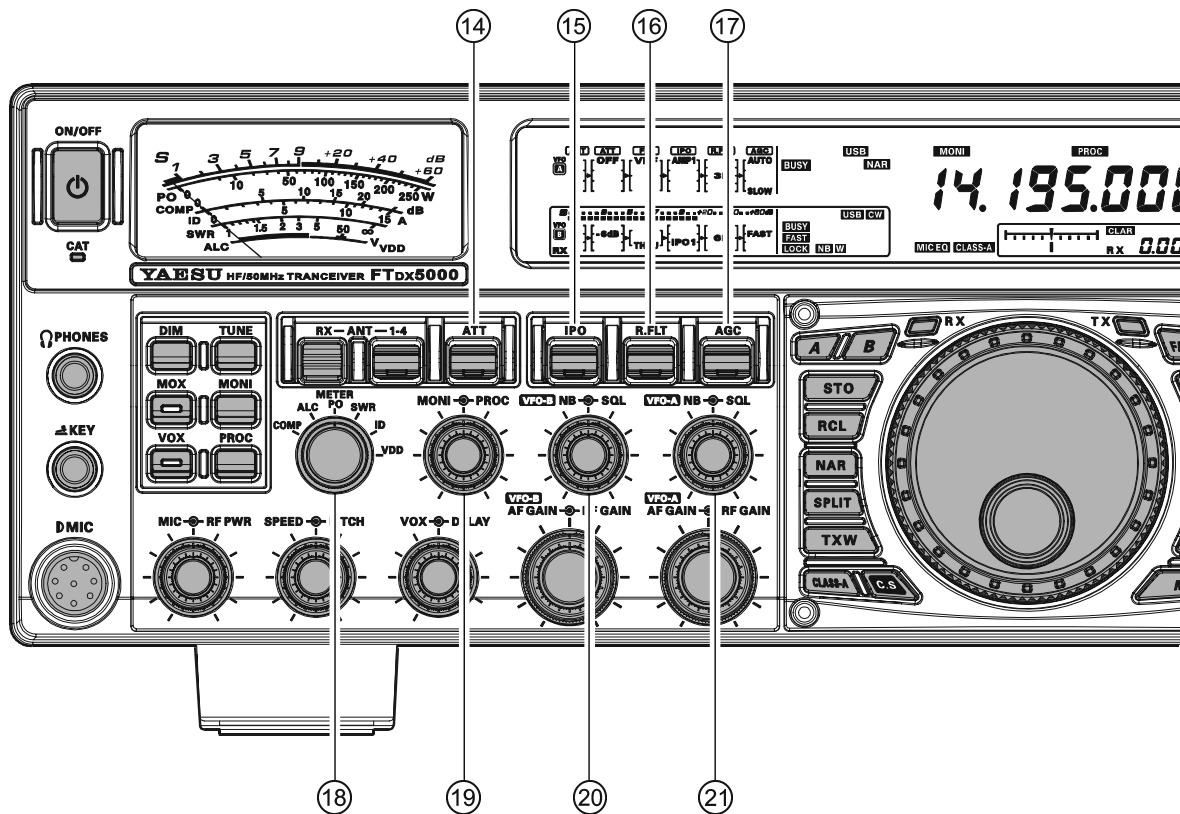

## 14 [ATT] Switch

Move this knob up or down to select the degree of Attenuation to be applied to the receiver input. Available selections are “-6 dB”, “-12 dB”, “-18 dB”, or “OFF”. The selected attenuation level appears in the ATT column of the Block Diagram Display.

### ADVICE:

- Press this knob in briefly, to quickly turn the attenuation level off.
- The Attenuator may be used in conjunction with the [IPO] switch to provide additional gain reduction when an extremely strong signal is being received.

## 15 [IPO] (INTERCEPT POINT OPTIMIZATION) Switch

Move this knob up or down to select the optimum front end characteristics of the receiver circuit. Available selections are “AMP 1”, “AMP 2”, “IPO 1”, or “IPO 2”.

Normally, IPO is set to “AMP1”. If you want to increase the sensitivity, use “AMP2”. When set to “IPO1”, the IPO performance of the receivers is improved. When set to “IPO2”, the RF preamplifier is bypassed, yielding direct feed to the first mixer. As a result, the IPO is improved more.

### ADVICE:

- Press this knob in briefly to quickly select the “AMP1” IPO setting.
- “IPO 2” can not be selected for VFO-B.

## 16 [R.FLT] Switch

Move this knob up or down to select the bandwidth of the first IF Roofing Filter. Available selections are “300 Hz”, “600 Hz”, “3 kHz”, “6 kHz”, “15 kHz”, or “AUTO” (“300 Hz” and “600 Hz” are available only in VFO-A. The “300 Hz” filter is optional, except in the MP version). The selected bandwidth appears in the R.FLT column of the Block Diagram Display.

### ADVICE:

- Press this knob in briefly to quickly select “AUTO”.
- Because the roofing filter is in the first IF, the protection it provides against interference is quite significant. When set to “AUTO”, the SSB bandwidth is 6 kHz, CW is 3 kHz, and FM/RTTY are 15 kHz. However, on a crowded SSB band, you may wish to select the 3 kHz filter, for the maximum possible interference rejection.

# FRONT PANEL CONTROLS & SWITCHES

## ⑰ [AGC] Switch

Move this knob up and down to select the receiver AGC characteristics (receiver-recovery time). Available selections are FAST, MID, SLOW, or AUTO, and the selected receiver-recovery time appears in the AGC column of the Block Diagram Display.

Hold this knob up or down for two seconds to disable the AGC (for testing or weak-signal reception).

### ADVICE:

- Press this knob in briefly to quickly select “AUTO”.
- If the AGC is disabled by holding the [AGC] knob up or down, the S-meter will no longer deflect. Additionally, you will likely encounter distortion on stronger signals, as the IF amplifiers and the following stages may be overloaded.

## ⑱ [METER] Switch

This control switch determines the function of the meter during transmission.

**COMP:** Indicates the speech compression level (SSB mode only).

**ALC:** Indicates the relative ALC voltage.

**PO:** Indicates the average power output level.

**SWR:** Indicates the Standing Wave Ratio (Forward: Reflected).

**ID:** Indicates the final amplifier drain current.

**VDD:** Indicates the final amplifier drain voltage.

## ⑲ [MONI] → [PROC] Knobs

### [MONI] Knob

The inner [MONI] knob adjusts the audio level of the transmit RF monitor during transmission (relative to the AF GAIN control), when activated by the [MONI] button.

### [PROC] Knob

The outer [PROC] knob sets the compression (input) level of the transmitter Speech Processor in the SSB, AM, and FM modes, when activated by the [PROC] button.

### ADVICE:

The relative compression level of the Speech Processor will show for 3-seconds in the lower right corner of the Main Display whenever the outer [PROC] knob is turned.

Alternately, the 3-second display feature may be changed to show in the **SUB DISPLAY-III** window via Menu item “018 DISP INDI”. Additionally, you may disable the 3-second display feature via Menu item “017 DISP LVL IND” See page 122 for details.

## ⑳ (VFO-B) [NB] → [SQL] Knobs

### [NB] Knob

The inner [NB] knob adjusts the noise blanking level when the VFO-B (analog) IF noise blanker is activated by pressing the [NB] button.

### [SQL] Knob

The outer [SQL] knob sets the signal level threshold at which the VFO-B receiver audio is muted, in all modes. The squelch is very useful during local rag-chews, to eliminate noise between incoming transmissions. This control is normally kept fully counter-clockwise (off), except when scanning and during FM operation.

## ㉑ (VFO-A) [NB] → [SQL] Knobs

### [NB] Knob

The inner [NB] knob adjusts the noise blanking level when the VFO-A (analog) IF noise blanker is activated by pressing the [NB] button.

### [SQL] Knob

The outer [SQL] knob sets the signal level threshold at which the VFO-A receiver audio is muted, in all modes. The squelch is very useful during local rag-chews, to eliminate noise between incoming transmissions. This control is normally kept fully counter-clockwise (off), except when scanning and during FM operation.

# FRONT PANEL CONTROLS & SWITCHES

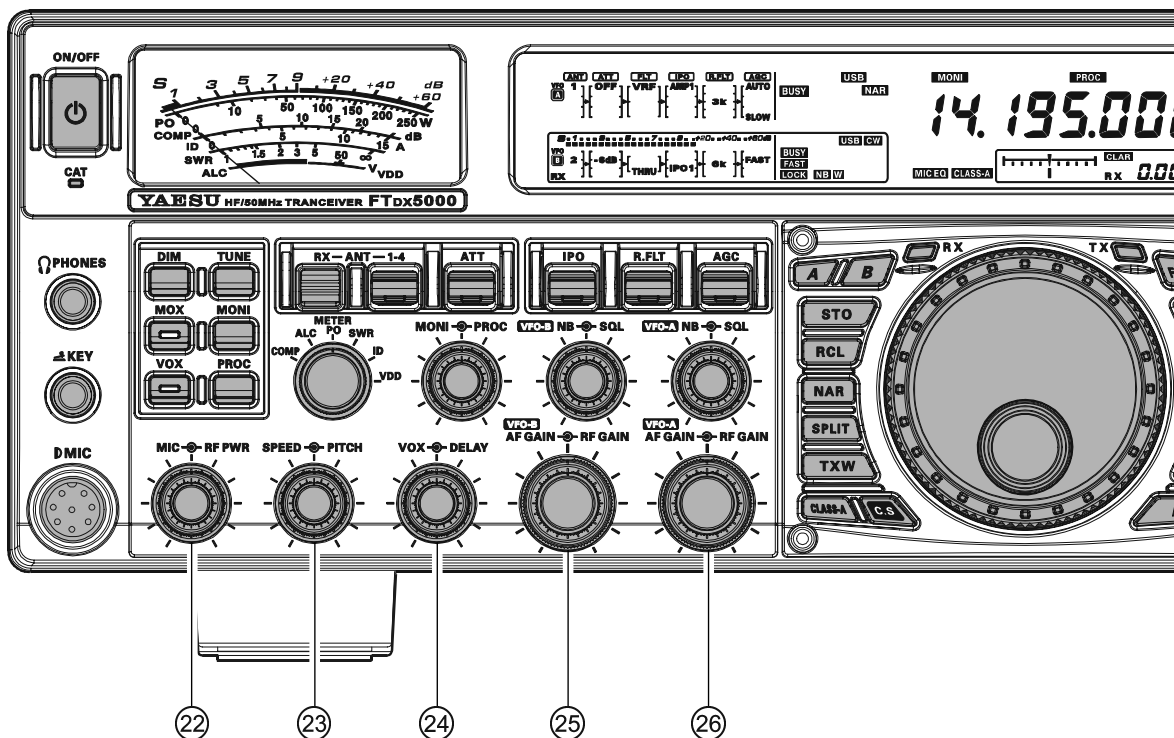

## 22 [MIC]↔[RF PWR] Knobs

### [MIC] Knob

The inner [MIC] knob adjusts the microphone input level for (non-processed) SSB transmission.

#### ADVICE:

- ❑ Adjust the MIC Gain while speaking in a somewhat-louder-than-normal voice. Watch the ALC level and adjust the MIC Gain so that the ALC indication reaches just to the right edge of the scale. Then, when you speak in a normal voice level, you will not over-driving the mic amplifier stage.
- ❑ The relative Microphone Gain level will show for 3-seconds in the lower right corner of the Main Display whenever the inner [MIC] knob is turned.

Alternately, the 3-second display feature may be changed to show in the **SUB DISPLAY-III** window via Menu item “018 DISP INDI”. Additionally, you may disable the 3-second display feature via Menu item “017 DISP LVL IND” See page 122 for details.

### [RF PWR] Knob

The outer [RF PWR] knob is the main RF Power output control for the transceiver. It is active in all operating modes. Clockwise rotation increases the power output. Adjust this control for the desired power output from the **FTDx5000**.

#### ADVICE:

The RF Power output will show for 3 seconds in the lower right corner of the Main Display whenever the outer [RF PWR] knob is turned.

Alternately, the 3-second display feature may be changed to show in the **SUB DISPLAY-III** window via Menu item “018 DISP INDI”. Additionally, you may disable the 3-second display feature via Menu item “017 DISP LVL IND” See page 122 for details.

# FRONT PANEL CONTROLS & SWITCHES

## ②③ [SPEED]↔[PITCH] Knobs

### [SPEED] Knob

The inner [SPEED] knob adjusts the keying speed of the internal CW keyer (4 ~ 60 WPM). Clockwise rotation increases the sending speed.

The keying speed will show for 3 seconds in the lower right corner of the Main Display while the [KEYER] button is held depressed for more than one second.

#### **ADVICE:**

The keying speed will show for 3 seconds in the lower right corner of the Main Display whenever the outer [SPEED] knob is turned.

Alternately, the 3-second display feature may be changed to show in the **SUB DISPLAY-III** window via Menu item “018 DISP INDI”. Additionally, you may disable the 3-second display feature via Menu item “017 DISP LVL IND” See page 122 for details.

### [PITCH] Knob

The outer [PITCH] knob selects your preferred CW tone pitch (from 300 ~ 1050 Hz, in 50 Hz increments). The TX sidetone, the receiver IF passband, and the display offset from the BFO (carrier) frequency are all affected simultaneously. The Pitch control setting also affects the operation of the CW Tuning Indicator, as the center frequency of the CW Tuning Indicator will follow the setting of this control.

#### **ADVICE:**

The CW tone pitch frequency will show for 3 seconds in the lower right corner of the Main Display whenever the outer [SPEED] knob is turned.

Alternately, the 3-second display feature may be changed to show in the **SUB DISPLAY-III** window via Menu item “018 DISP INDI”. Additionally, you may disable the 3-second display feature via Menu item “017 DISP LVL IND” See page 122 for details.

## ②④ [VOX]↔[DELAY] Knobs

### [VOX] Knob

The inner [VOX] knob sets the level of microphone audio needed to activate the transmitter during voice operation when the [VOX] switch is actuated.

### [DELAY] Knob

The outer [DELAY] knob sets the hang time of the VOX circuit for voice operation, and the keying delay for CW operation.

For voice operation, this knob sets the hang time, between the moment you stop speaking, and the time the transmit is switched back to receive. For smooth operation, adjust the VOX so the transmit switches to receive when your comments have ended.

For CW, this knob sets the automatic transmit to receive keying delay for “Semi-break-in” operation. Adjust this just long enough to prevent the receiver from being restored during word spaces at your preferred sending speed.

#### **ADVICE:**

The hang time of the VOX circuit will show for 3 seconds in the lower right corner of the Main Display whenever the outer [SPEED] knob is turned. Alternately, the 3-second display feature may be changed to show in the **SUB DISPLAY-III** window via Menu item “018 DISP INDI”. Additionally, you may disable the 3-second display feature via Menu item “017 DISP LVL IND” See page 122 for details.

## ②⑤ (VFO-B)[AF GAIN]↔[RF GAIN] Knobs

### [AF GAIN] Knob

The inner [AF GAIN] knob sets the audio level of the VFO-B receiver. Typically, you will operate with this control set between the 9 o'clock and 10 o'clock positions.

### [RF GAIN] Knob

The outer [RF GAIN] knob sets the gain of the RF and IF amplifier stages of the VFO-B receiver. This control is normally left in the fully clockwise position.

## ②⑥ (VFO-A) [AF GAIN]↔[RF GAIN] Knobs

### [AF GAIN] Knob

The inner [AF GAIN] knob sets the audio level of the VFO-A receiver. Typically, you will operate with this control set between the 9 o'clock and 10 o'clock positions.

### [RF GAIN] Knob

The outer [RF GAIN] knob sets the gain of the RF and IF amplifier stages of the VFO-A receiver. This control is normally left in the fully clockwise position.

# FRONT PANEL CONTROLS & SWITCHES

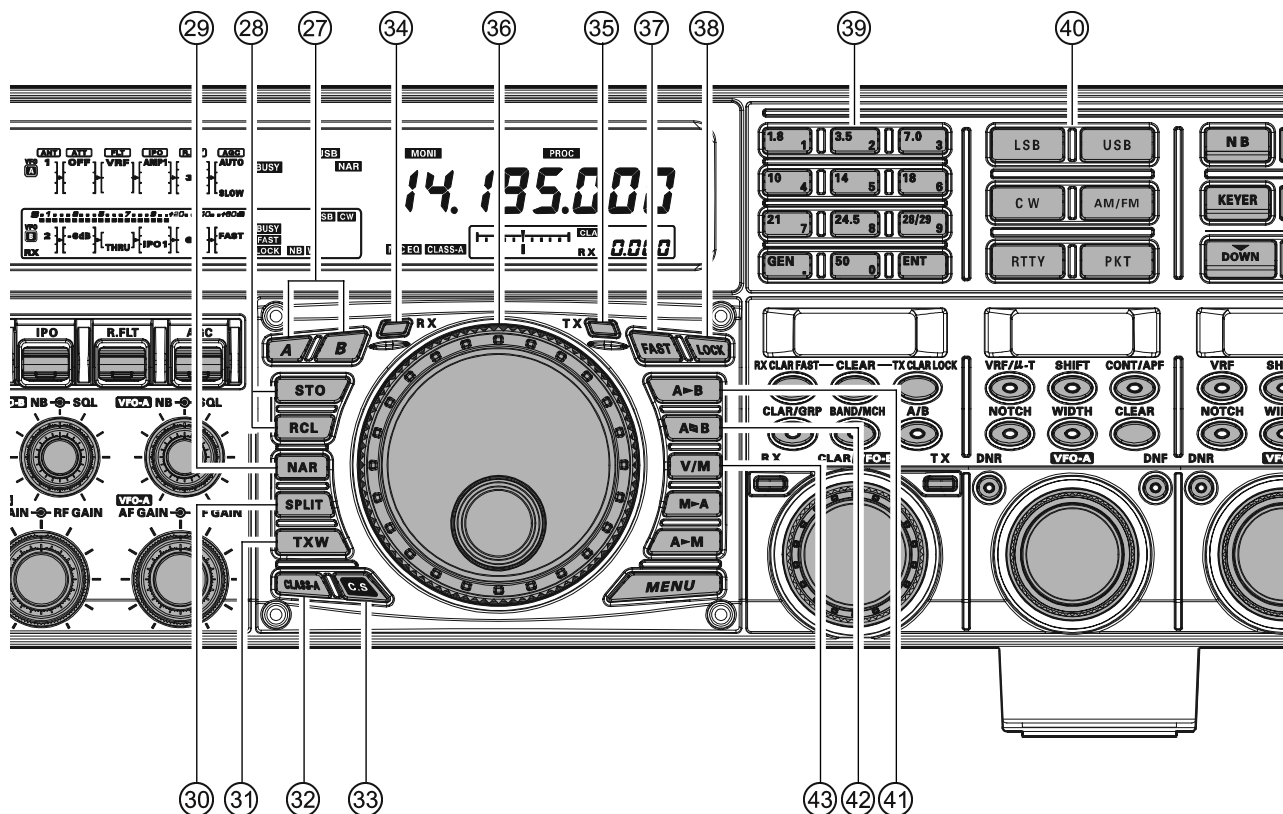

## 27 [A], [B] Switches

Pressing the [A] or [B] button will illuminate the respective switch, and allow adjustment of the major functions (such as mode and band selection etc) on the VFO-A or VFO-B receiver. Usually, the [A] button will glow red, and the VFO-A functions may be adjusted. Similarly, pressing the [B] button will cause its indicator glow orange, signifying the VFO-B functions may be adjusted.

### ADVICE:

The [A]/[B] switches affect the following functions:

- [RX ANT] switch
- [ANT 1-4] switch
- [ATT] switch
- [IPO] switch
- [R.FLT] switch
- [AGC] switch
- [NAR] switch
- [BAND] switches
- [MODE] switches
- [NB] switch
- [RX ANT] switch

## 28 QMB (Quick Memory Bank) Switches

### [STO] (Store) Button

Pressing this button, copies the operating information for frequency, mode, and bandwidth, into consecutive QMB Memories. Repeater shift/direction, frequency and CTCSS functions, are also copied in the FM mode.

### [RCL] (Recall) Button

Pressing this button recalls one of the five Quick Memory Bank memories for operation.

## 29 [NAR] (Narrow) Switch

This button is used to set the DSP (digital) filters to narrow bandwidths. The default values are as follows:

MODE	NAR SWITCH	
	OFF	ON
LSB/USB	2.4 kHz* (1.8 kHz - 4.0 kHz / 16 steps)	1.8 kHz* (200 Hz - 1.8 kHz / 9 steps)
CW	2.4 kHz* (500 Hz - 2.4 kHz / 7 steps)	500 Hz* (50 Hz - 500 Hz / 10 steps)
RTTY (LSB)	500 Hz* (500 Hz - 2.4 kHz / 7 steps)	300 Hz* (50 Hz - 500 Hz / 10 steps)
PKT (LSB/USB)	500 Hz* (500 Hz - 2.4 kHz / 7 steps)	300 Hz* (50 Hz - 500 Hz / 10 steps)
PKT (FM)	25 kHz (±5.0 kHz Deviation)	12.5 kHz (±2.5 kHz Deviation)
AM	9 kHz	6 kHz
FM	25 kHz (±5.0 kHz Deviation)	12.5 kHz (±2.5 kHz Deviation)

\*: You may enable the [WIDTH] knob to adjust the bandwidth.



# FRONT PANEL CONTROLS & SWITCHES

## ③⑩ [SPLIT] Switch

Press this button briefly to activate split frequency operation between the VFO-A receiver and the VFO-B, transmit. Press and hold in this button for two seconds to engage the “Quick Split” feature, whereby VFO-B will automatically be set to a frequency 5 kHz higher than the VFO-A frequency with the same operating mode, and the transceiver will be placed in the Split mode.

## ③① [TXW] (TX Watch) Switch

Press and hold this button to monitor the transmit frequency when split frequency operation is engaged. Release the button to return to normal operation.

## ③② [CLASS-A] Switch

Press this button to engage the Class-A transmit capability. The power output will be reduced to a maximum of 75 Watts. However, Class-A operation provides an ultra-clean SSB waveform. When Class-A operation is engaged, the “CLASS-A” icon appears in the display. Press this button once more to return to Class-AB operation at a maximum power output of 200 Watts; the “CLASS-A” icon disappears to confirm Class-AB operation.

### ADVICE:

You may adjust the bias level between “Class-AB” and “Class-A” via Menu item “169 TGEN BAIS”. See page 136 for details.

## ③③ [C.S] Switch

Press this button briefly to recall a favorite Menu Selection directly.

To assign a Menu selection as the short-cut, press the [MENU] button to enter the Menu, then select the Menu item. Now press and hold in the [C.S] button for two seconds to lock the selected Menu item as the short-cut.

## ③④ (VFO-A)[RX] Indicator/Switch

Press this button to engage the VFO-A receiver; the button will glow green when the VFO-A receiver is active.

When the VFO-A receiver is active, pressing this button briefly will mute the receiver, and the indicator will blink. Pressing the button once more will restore receiver operation, and the indicator will glow green steadily.

## ③⑤ (VFO-A)[TX] Indicator/Switch

When this button is pressed, the button indicator will glow red and the transmitter frequency and mode will be controlled by VFO-A (subject to any Clarifier offset, of course).

### ADVICE:

If this indicator is not illuminated, it means that VFO-B TX has been selected (In this case, The VFO-B TX indicator will glow red and the transmitter frequency and mode will be controlled by VFO-B).

## ③⑥ Main Tuning Dial Knob

This large knob adjusts the operating frequency of VFO-A or a recalled memory. Clockwise rotation of the knob increases the frequency. Default tuning increments are 10 Hz (100 Hz in AM and FM modes); when the [FAST] button is pressed, the tuning steps increase. The available steps are:

OPERATING MODE	1 STEP	1 DIAL ROTATION
LSB/USB/CW/RTTY/PKT(SSB)	10 Hz (100 Hz)	10 kHz (100 kHz)
AM/FM/PKT(FM)	100 Hz (1 kHz)	100 kHz (1 MHz)

Numbers in parentheses indicate steps when the [FAST] button is On.

### ADVICE:

- The tuning steps for the Main Tuning Dial knob are set, at the factory, to 10 Hz per step. Via Menu item “142 TUN DIAL STEP”, however, you may change this setting from 10 Hz to 5 Hz or 1 Hz instead. When the [FAST] button is pressed, the tuning step change to 100 Hz.
- You may lock the Main Tuning Dial knob in the AM and FM mode via Menu items “147 TUN AM D.LCK” and “148 TUN FM D.LCK”.

## ③⑦ [FAST] Switch

Pressing this button will change the VFO-A tuning step to 100 Hz.

When this function is activated, the “FAST” icon appears in the display.

## ③⑧ [LOCK] Switch

This button toggles locking of the Main Tuning Dial knob, to prevent accidental frequency changes. When the button is active, the Main Tuning Dial knob can still be turned, but the VFO-A frequency will not change, and the “LOCK” icon appears in the display.

## ③⑨ [BAND] Keys

These buttons allow one-touch selection of the desired amateur band (1.8 ~ 50 MHz).

What’s more, these buttons may be used for direct entry of a desired operating frequency during VFO operation.

## ④⑩ [MODE] Switches

Pressing one of these buttons, selects the operating mode. Repeated presses of a particular switch will toggle to the alternate mode, or step through the available selections, as shown in the chart below.

SWITCH	VARIABLE MODE SELECTION
LSB	LSB
USB	USB
CW	CW (LSB)↔CW (USB)
AM/FM	AM↔FM
RTTY	RTTY (LSB)↔RTTY (USB)
PKT	PKT (LSB)→PKT (USB)→PKT (FM) .....

# FRONT PANEL CONTROLS & SWITCHES

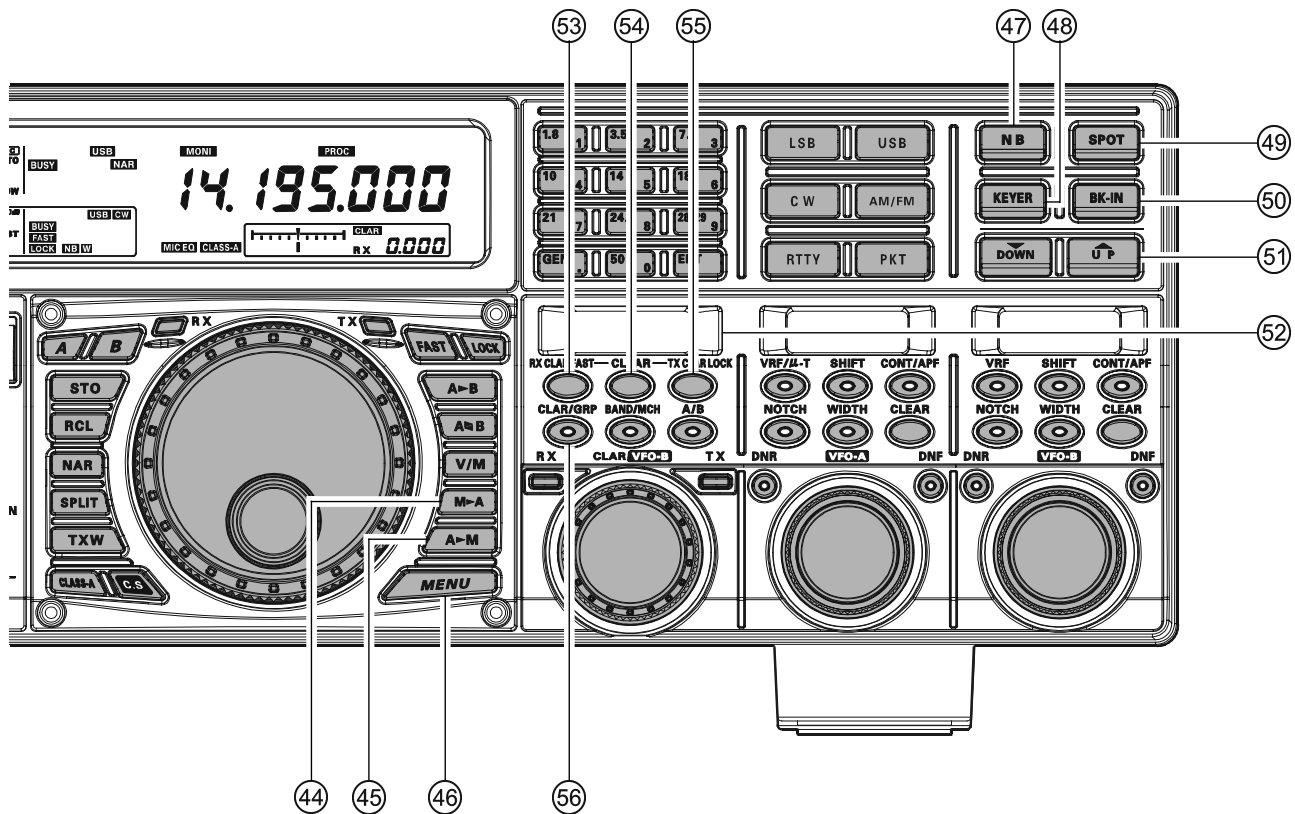

## 41 [A▶B] Switch

Press this button briefly to transfer data from the VFO-A frequency (or a recalled memory channel) to VFO-B, overwriting any previous contents in VFO-B. Use this button to set both VFO-A and VFO-B receivers to the same frequency and mode.

## 42 [A▶B] Switch

Pressing this button briefly, exchanges the contents of the VFO-A (or a recalled memory channel) and the VFO-B.

## 43 [V/M] Switch

This button toggles VFO-A receiver operation between the memory system and the VFO. Either “**MR**” or “**MT**” will be displayed under the main frequency display field to indicate the current selection. If you have tuned off of a Memory channel frequency (MT), pressing this button returns the display to the original memory contents (MR), and pressing it once more returns operation to VFO-A (no icon).

## 44 [M▶A] Switch

Press this button briefly, to display the contents of the currently-selected memory channel for three seconds. Holding this button in for 2 seconds copies the data from the currently-selected memory to VFO-A, as two beeps sound. Previous data in VFO-A will be overwritten.

## 45 [A▶M] Switch

Pressing and holding in this button for 1/2 second (until the double beep), copies the current operating data from VFO-A into the currently selected memory channel, overwriting any previous data stored there. See page 102 for details.

Also, pressing and holding in this button after recalling a memory, without first retuning, causes the memory channel to be “masked,” and repeating the process restores the masked memory.

## 46 [MENU] Switch

This button is used to access the Menu system, for configuring various transceiver characteristics. Menu operation is described in detail, in this manual, beginning on page 116.

### IMPORTANT NOTE:

Pressing this button briefly activates the Menu, and the Menu items will appear on the **SUB DISPLAY** windows. Once you are finished, you must press and hold in the [MENU] button for two seconds to save any configuration changes (briefly press the [MENU] button to exit without saving the changes).

# FRONT PANEL CONTROLS & SWITCHES

## ④7 [NB] Switch

This button turns the IF Noise Blanker on and off. Press this button briefly to reduce a short-duration pulse noise; the “**NB**” icon will appear in the display. Press this button once more to reduce a longer-duration man-made pulse noise; the “**W**” icon will appear at the right of the “**NB**” icon. Press this button again to disable the noise blanker; the “**NB**” and “**W**” icon will disappear.

## ④8 [KEYER] Switch

This button toggles the internal CW keyer on and off. While activated, the “**KEYER**” icon appears in the display. The keyer sending speed is adjusted via the front panel [SPEED] knob, and the CW Hang Time is adjusted via the front panel [DELAY] knob.

### ADVICE:

When this button is held for more than one second, the keying speed will be displayed in the lower right corner of the Main Display until the button is released. Alternately, the 3-second display feature may be changed to show in the **SUB DISPLAY-III** window via Menu item “**018 DISP INDI**”. See page 122 for details.

## ④9 [SPOT] Switch

This button turns on the CW receiver spotting tone; by matching the SPOT tone to that of the incoming CW signal (precisely the same pitch), you will be “zero beating” your transmitted signal with the frequency of the other station.

### ADVICE:

The offset tone frequency will be displayed in the lower right corner of the Main Display when this button is pressed. Alternately, the 3-second display feature may be changed to show in the **SUB DISPLAY-III** window via Menu item “**018 DISP INDI**”. See page 122 for details.

## ⑤0 [BK-IN] Switch

This button turns the CW break-in capability on and off. While the CW break-in is activated, the “**BK-IN**” icon appears in the display.

## ⑤1 [▼(DOWN)]/[▲(UP)] Switches

These buttons adjust the operating frequency of the VFO or a recalled memory in 100 kHz steps.

## ⑤2 SUB DISPLAY-I

This OLED (Organic Light Emitting Diode) display shows the VFO-B frequency, and it indicates the Menu List while the Menu Mode is active.

## ⑤3 [RX CLAR(FAST)] Switch

The function of this button differs with the setting of the [A/B] button (described later).

*When the LED in the [A/B] button is turned off*, pressing this button activates the RX Clarifier, to allow offsetting the VFO-A receiving frequency temporarily. Press this button once more to return the Main receiver to the frequency shown on the main frequency display field; the Clarifier offset will still be present, though, in case you want to use it again. To cancel the Clarifier offset, press the [CLEAR] button.

*When [A/B] button glows orange*, pressing this button will change the VFO-B tuning step to 100 Hz.

When this function is activated, the “**FAST**” icon appears in the display.

## ⑤4 [CLEAR] Switch

Pressing this button clears out any frequency offset you have programmed into the Clarifier register (thereby setting the offset to “Zero”).

## ⑤5 [TX CLAR/LOCK] Switch

The function of this button is changed by the setting of the [A/B] button (described later).

*When the [A/B] button is turned off*, pressing the [TX CLAR/LOCK] button activates the TX Clarifier, to allow offsetting the VFO-A transmit frequency temporarily. Press the button once more to return the transmitter to the VFO-A frequency shown on the main frequency display field; the Clarifier offset will still be present, though, in case you want to use it again. To cancel the Clarifier offset, press the [CLEAR] button.

*When the [A/B] button glows orange*, the [TX CLAR/LOCK] button toggles locking of the [CLAR(VFO-B)] knob, to prevent accidental frequency changes. When the lock is active, the [CLAR(VFO-B)] knob can still be turned, but the VFO-B frequency will not change, and the “**LOCK**” icon appears in the display.

# FRONT PANEL CONTROLS & SWITCHES

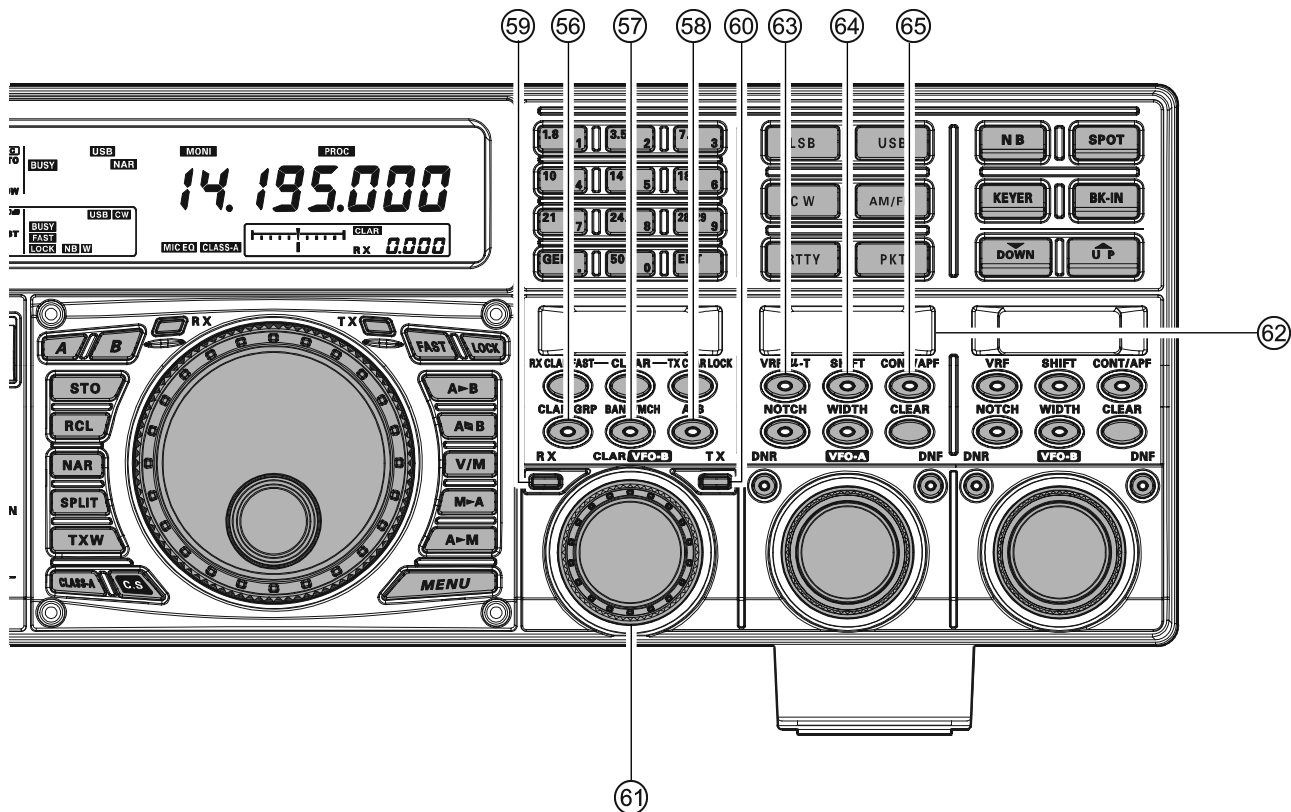

## 56 [CLAR/GRP] Switch

This button has two functions.

**Pressing this button briefly**, the [CLAR/VFO-B] knob will be enabled as an “offset tuning” control to allow tuning away from the VFO-A frequency, and the [CLAR/GRP] button will glow red.

**Pressing and holding this button for one second**, allows you to select the memory group using the [CLAR(VFO-B)] knob, and the [CLAR/GRP] button will glow yellow.

## 57 [BAND(MCH)] Switch

This button has two functions.

**Pressing this button briefly**, enables the [CLAR(VFO-B)] knob to select the VFO-A operating Amateur Band. The [CLAR/GRP] button glows red.

**Pressing and holding this button for one second**, allows you to select the memory channel using the [CLAR(VFO-B)] knob, and the [CLAR/GRP] button is glows yellow.

## 58 [A/B] Switch

This button switches the actions of the [CLAR(VFO-B)] knob between VFO-A and VFO-B.

Pressing this button once causes the button to glow yellow; in this case, rotation of the [CLAR(VFO-B)] knob affects operation on VFO-B (tuning, etc.). Pressing this button once more causes the button to turn off; in this instance, rotation of the [CLAR(VFO-B)] knob affects operations associated with the VFO-A (Clarifier function, etc.).

## 59 (VFO-B)[RX] Indicator/Switch

This is the button that turns the VFO-B receiver “On” and “Off”. When the VFO-B receiver is active, the button will glow green. Pressing this button again will disable VFO-B receiver, and the imbedded green LED will turn off.

## 60 (VFO-B)[TX] Indicator/Switch

This button turns the VFO-B transmitter “On” and “Off”. When this button is pressed, it will glow red and VFO-B will control the transmitter frequency and mode. Pressing this button once more will transfer frequency/mode control back to VFO-A, and the red LED in the button will turn off.

## 61 [CLAR(VFO-B)] Knob

The function of this knob differs according to the settings of the three switches located above the knob. See the next page for details.

## 62 SUB DISPLAY-II

This OLED (Organic Light Emitting Diode) display shows the characteristics of the VFO-A receiver DSP functions selected by five of the buttons located below of this display. The (VFO-A)[SELECT] knob located below this window is an adjustment knob for the function displayed in this window. Alternately, when the Menu Mode is activated, this OLED displays the selected Menu item.

# FRONT PANEL CONTROLS & SWITCHES

## 63 (VFO-A)[VRF/μ-T] Switch

This button turns the VFO-A receiver VRF filter “on” and “off”, and allows you to adjust the center frequency of the VRF filter with the (VFO-A)[SELECT] knob. While activated, the red LED in this button will light up, and the “**VRF**” icon will appear in the FLT column of the Block Diagram Display.

### ADVICE:

When an optional RF μTuning Kit is connected, pressing this button will engage the μ-Tuning filter. The μTuning Kit provides much better RF selectivity than any other RF filter in the Amateur industry, yielding outstanding protection from high RF levels not far removed from the current operating frequency.

## 64 (VFO-A)[SHIFT] Switch

Pressing this button allows you to move the IF DSP bandwidth of VFO-A “higher” or “lower” with the (VFO-A)[SELECT] knob. When the IF passband is shifted, the red LED imbedded in this button will light up. To the contrary, when the IF passband is just centered, the red LED in this button turns off.

## 65 (VFO-A) [CONT/APF] Switch

*In the SSB, AM, and FM modes*, this button turns the VFO-A receiver contour filter “on” and “off”, and allows you to adjust the center frequency of the contour filter with the (VFO-A)[SELECT] knob. When the contour filter is activated, the red LED in this button will light up.

*In the CW mode*, this button turns the VFO-A receiver APF (Audio Peak Filter) “on” and “off”, and allows you to adjust the bandwidth of the APF filter with the (VFO-A)[SELECT] knob. When the APF filter is activated, the red LED in this button will light up.

## [CLAR(VFO-B)] Knob Functions

### When the LED in the [A/B] button is turned “off”

In this case, the [CLAR(VFO-B)] knob is used for Clarifier tuning, as well as Up/Down selection of the Amateur band, Memory Channels, 1 MHz tuning steps, or Memory Groups.

#### Clarifier Operation

When the [CLAR/GRP] button is pressed briefly, the imbedded LED in the button will glow red, and the [CLAR(VFO-B)] knob may be used to program an offset of up to  $\pm 9.999$  kHz from the VFO-A frequency. However, this offset is only applied to the receive or transmit frequency if the [RX CLAR/FAST] button and/or [TX CLAR/LOCK] button, respectively, have been pushed.

To apply the programmed frequency offset to the Receive frequency, press the [RX CLAR/FAST] button briefly. To return to the VFO-A frequency, without the offset, press the [RX CLAR/FAST] button once more. To apply the programmed frequency offset to the Transmit frequency, press the [TX CLAR/LOCK] button briefly. To return the transmitter to the VFO-A frequency, without the offset, press the [TX CLAR/LOCK] button once more.

To reset the Clarifier frequency offset to “0”, press the [CLEAR] button.

#### BAND Up / Down Control

When the [BAND/MCH] button is pressed briefly, the LED in the button will glow red, and enable the use of the [CLAR(VFO-B)] knob to select the desired amateur band. If you have engaged the “My Bands” feature via Menu #145, the [CLAR(VFO-B)] knob will select just from the amateur bands that you have included in the “My Bands” list.

#### Memory Channel / Memory Group Control

Press and hold in the [BAND/MCH] button for two seconds, the LED in the button will glow yellow, and the [CLAR(VFO-B)] knob may be used to select the desired Memory Channel.

Press and hold in the [CLAR/GRP] button for two seconds, the LED in the button will glow yellow, and you may use the [CLAR(VFO-B)] knob to select the desired Memory Group.

### When the LED in the [A/B] button glows orange

When the [A/B] button is pressed, the LED in the button will glow orange, and the [CLAR(VFO-B)] knob will control functions associated with the VFO-B frequency control register.

#### VFO-B FAST Tuning

When the [RX CLAR/FAST] button is pressed, the “**FAST**” icon appears in the display, and the VFO-B tuning step changes to 100 Hz. Press the [RX CLAR/FAST] button once more to return to the normal tuning rate.

#### VFO-B Dial Lock

When the [TX CLAR/LOCK] button is pressed, the “**LOCK**” icon appears in the display, and the [CLAR(VFO-B)] knob is locked. Press the [RX CLAR/FAST] button once more to disable the lock feature.



# FRONT PANEL CONTROLS & SWITCHES

## ⑦⑤ (VFO-B)[CONT/APF] Switch

*In the SSB, AM, and FM modes*, this button turns the VFO-B Receiver Contour Filter “on” and “off”, and enables adjustment of the Contour Filter center frequency with the (VFO-B)[SELECT] knob. When the Contour Filter is activated, the orange LED in the button will light up.

*In the CW mode*, this button turns the VFO-B Receiver APF (Audio Peak Filter) “on” and “off”, and allows you to adjust the bandwidth of the APF filter with the (VFO-B)[SELECT] knob. When the APF filter is activated, the orange LED in the button will light up.

## ⑦⑥ (VFO-B)[NOTCH] Switch

This button turns the VFO-B Receiver IF notch filter “on” and “off”, and enables adjustment of the notch filter center frequency with the (VFO-B)[SELECT] knob. When the notch filter is activated, the orange LED in the button will light up.

## ⑦⑦ (VFO-B)[WIDTH] Switch

Pressing this button allows you to adjust the overall bandwidth of the VFO-B receiver IF DSP filter with the (VFO-B)[SELECT] knob. When the bandwidth is set to other than the factory default, the orange LED in the button will light up. Alternately, when the bandwidth is set to default, the orange LED in the button turns off.

## ⑦⑧ (VFO-B)[CLEAR] Switch

Pressing this button will reset the function selected by the five buttons above and left of the button to factory default.

## ⑦⑨ (VFO-B)[DNR] Switch

This button toggles the VFO-B Receiver Digital Noise Reduction circuit “on” and “off”, and allows you to adjust the noise reduction level with the (VFO-B)[SELECT] knob. When the Digital Noise Reduction is activated, the orange LED in the button will light up.

## ⑧① (VFO-B)[SELECT] Knob

This knob is used to adjust status of the functions selected by the five buttons located above the knob.

## ⑧① (VFO-A)[DNF] Switch

This button toggles the VFO-A Receiver Digital Notch Filter “on” and “off”. When the Digital Notch Filter is activated, the orange LED in the button will light up. This is an automatic circuit, and there is no adjustment knob for the DNF.

# DISPLAY INDICATIONS (LEFT SIDE)

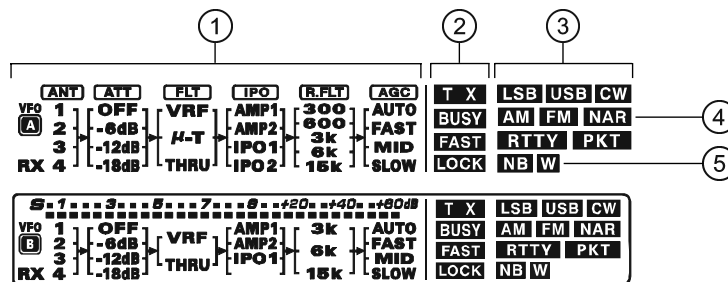

## ① (VFO-A) Block Diagram Display

### ANT (1, 2, 3, 4, RX):

Indicates the antenna selected for operation by the front panel [ANT 1-4] and [RX ANT] switches.

### ATT (OFF, -6 dB, -12 dB, -18 dB):

Indicates the attenuation level selected for operation by the front panel [ATT] button.

### FLT (VRF, $\mu$ -TUNE, THRU):

Indicates the RF filter selected for operation by the front panel (VFO-A)[VRF/ $\mu$ -T] button.

#### ADVICE:

The  $\mu$ -TUNE filter is an option. The “ $\mu$ -TUNE” icon will not appear when the optional  $\mu$ -TUNE unit is not connected.

### IPO (AMP1, AMP2, IPO1, IPO2):

Indicates the front end RF amplifier selected for operation by the front panel [IPO] button.

### R.FLT (300, 600, 3k, 6k, 15k):

Indicates the 1st IF Roofing Filter selected for operation with the front panel [R.FLT] button.

#### ADVICE:

The 300 Hz Roofing Filter is an option except the MP version. The “300” icon will not appear when the optional 300 Hz Roofing Filter is not installed.

### AGC (AUTO, FAST, MID, SLOW):

Indicates the AGC decay time selected for operation by the front panel [AGC] switch.

## ② (VFO-A) Status Indicator

### T X :

This indicator appears during transmission on the VFO-A frequency.

### BUSY :

This indicator appears whenever the VFO-A receiver squelch is open. If this indicator is not showing, and reception seems to have been lost on the VFO-A receiver for no apparent reason, check the position of the (VFO-A)[SQL] knob, and rotate it fully counter-clockwise to restore reception.

### FAST :

This indicator appears when the Main Tuning Dial tuning rate is selected to fast.

### LOCK :

This indicator appears when the Main Tuning Dial knob is locked.

## ③ LSB, USB, CW, AM, FM, RTTY, PKT

Displays the currently-selected operating mode for VFO-A.

## ④ NAR

This indicator appears whenever the VFO-A receiver's narrow IF DSP filter is engaged.

## ⑤ NB W

The “NB” icon appears when the VFO-A receiver's (short duration) Noise Blanker is activated.

The “NB W” icon appears when the VFO-A receiver's (longer-pulse) Noise Blanker is activated.



# DISPLAY INDICATIONS (LEFT SIDE)

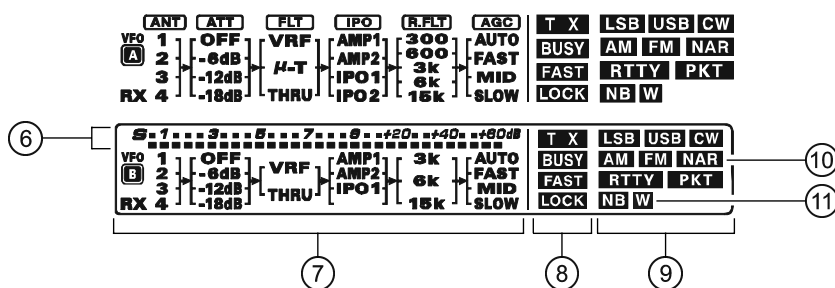

## ⑥ (VFO-B) Block Diagram Display

### ANT (1, 2, 3, 4, RX):

Indicates the antenna selected for operation by the front panel [ANT 1-4] and [RX ANT] switches.

### ATT (OFF, -6 dB, -12 dB, -18 dB):

Indicates the attenuation level selected for operation by the front panel [ATT] button.

### FLT (VRF, THRU):

Indicates the RF filter selected for operation by the front panel (VFO-A)[VRF] button.

### ADVICE:

The  $\mu$ -TUNE filter is an option. The “ $\mu$ -TUNE” icon will not appear when the optional  $\mu$ -TUNE unit is not connected.

### IPO (AMP1, AMP2, IPO1):

Indicates the front end RF amplifier selected for operation by the front panel [IPO] button.

### R.FLT (3k, 6k, 15k):

Indicates the 1st IF Roofing Filter selected for operation by the front panel [R.FLT] button.

### AGC (AUTO, FAST, MID, SLOW):

Indicates the AGC decay time selected for operation by the front panel [AGC] switch.

This indicator appears whenever the Digital Noise Reduction feature is activated.

## ⑦ (VFO-B) Receiver S-Meter

Displays the strength of signals received on VFO-B.

## ⑧ (VFO-B) Status Indicator

### T X:

This indicator appears during transmission on the VFO-B frequency.

### BUSY:

This indicator appears whenever the VFO-B receiver squelch is open. If this indicator is not showing, and reception seems to have been lost on the VFO-B receiver for no apparent reason, check the position of the (VFO-B)[SQL] knob and rotate it fully counter-clockwise to restore reception.

### FAST:

This indicator appears when the [CLAR(VFO-B)] knob's tuning rate is selected to fast.

### LOCK:

This indicator appears when the [CLAR(VFO-B)] knob is locked.

## ⑨ LSB, USB, CW, AM, FM, RTTY, PKT

Displays the currently-selected operating mode for VFO-B.

## ⑩ NAR

This indicator appears whenever the VFO-B receiver's narrow IF DSP filter is engaged.

## ⑪ NB W

The “NB” icon appears when the VFO-B receiver's (short duration) Noise Blanker is activated.

The “NB W” icon appears when the VFO-B receiver's (longer-pulse) Noise Blanker is activated.

# DISPLAY INDICATIONS (RIGHT SIDE)

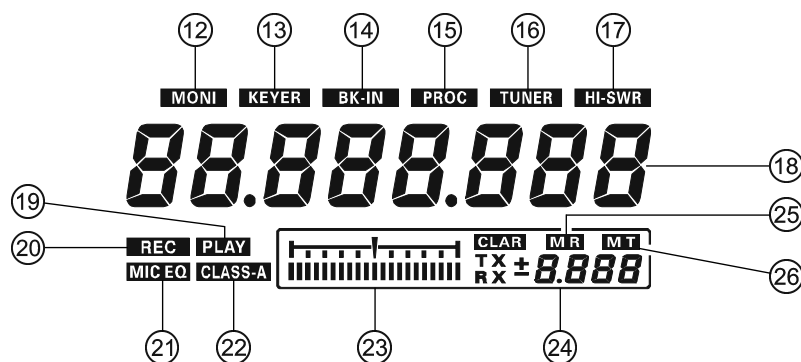

## 12 MONI

This indicator appears when the transmit monitor circuit is activated.

## 13 KEYER

This indicator appears when the internal CW keyer is activated.

## 14 BK-IN

This indicator appears when CW break-in operation is activated.

## 15 PROC

This indicator appears when the DSP Speech Processor is activated.

## 16 TUNER

This indicator appears when the internal Automatic Antenna Tuner is activated.

## 17 HI-SWR

This indicator appears if the directional coupler and microprocessor detect an abnormally high SWR condition (over 3.0:1) that cannot be resolved by the Automatic Antenna Tuner.

### NOTE:

If this indicator appears, check to be sure that you have the correct antenna selected on the current operating band. If so, you will need to check the condition of the antenna, its coaxial cable, and/or the connectors on the cable, to locate and correct the fault.

## 18 VFO-A Frequency Display

This is the VFO-A frequency display.

## 19 PLAY

This indicator appears while the voice recorder is playing back the recorded audio, and/or the memory is playing back the recorded CW or voice message.

## 20 REC

This indicator appears while the voice recorder is recording the receiver audio, and/or the memory is recording your CW or voice message.

## 21 MICEQ

This indicator appears when the Three-Band Parametric Microphone Equalizer is activated via the Menu.

## 22 CLASS-A

This indicator appears when Class-A operation is engaged.

## 23 Tuning Offset Indicator

This is a tuning scale that, as configured from the factory, provides a visual CW tuning indication of the incoming signal's offset from your transceiver's CW carrier frequency, as programmed by the relative clarifier offset, or the peak position of the VRF/ $\mu$ -TUNE filter.

## 24 CLAR

This indicator appears when the Clarifier function is activated.

### ADVISE:

When adjusting some knobs, the current value will appear in this area.

## 25 MR

This indicator appears when the transceiver is in the Memory Recall mode.

## 26 MT

This indicator appears when the transceiver is in the Memory Tune mode to indicate that the memory contents have been temporarily changed.

# REAR PANEL CONNECTIONS

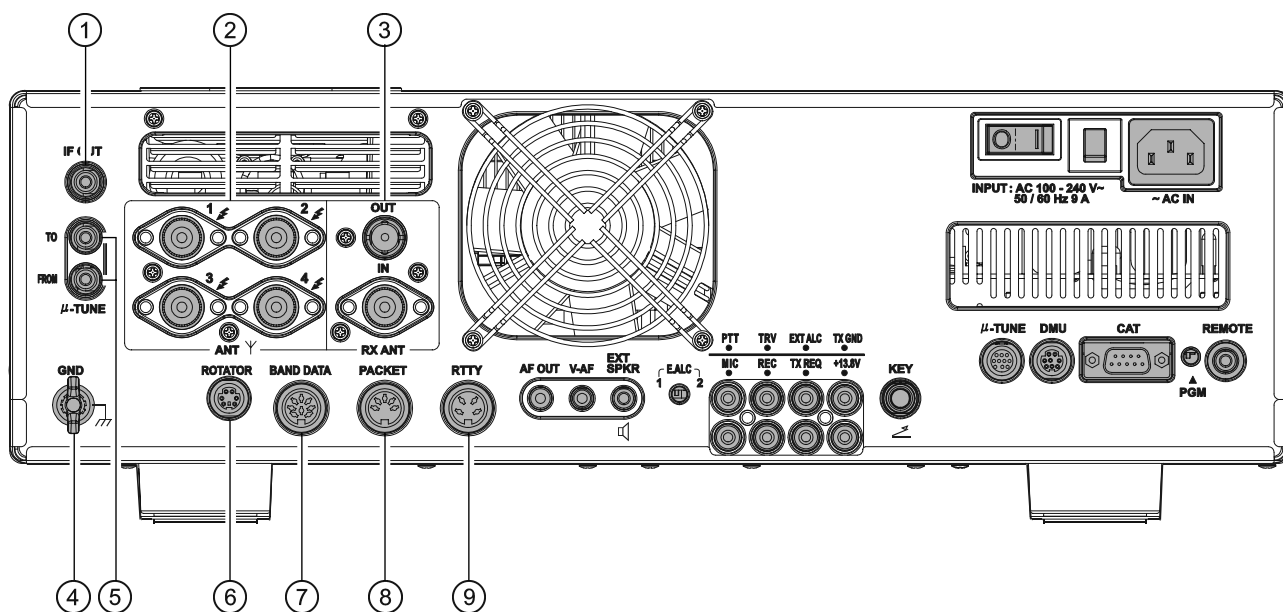

## ① IF OUT Jacks

This RCA jack outputs the 9 MHz IF signal of the received signal when Menu item “109 RGEN IF OUT” is set to “ENABLED”. This signal does not pass through the roofing filter.

## ② ANT 1, 2, 3, 4 Jacks

Connect your main antenna(s) here, using a type-M (PL-259) plug and coaxial feedline for each. These antenna ports are always used for transmission. They are also used for reception, unless a separate receive antenna is connected to the **RX ANT IN** jack and used for the receiver. The internal antenna tuner affects only the antenna(s) connected here, and only during transmission.

## ③ RX ANT IN Jack

The BNC jack provides output of the receiver signal from the Antenna jacks, which are connected to the “RX” side of the transceiver T/R switching circuitry. The type-M jack is for a separate, receive-only antenna. An antenna connected here can be used when the [RX ANT] button on the front panel is pressed.

If you want to use some special kind of external bandpass filter or preamplifier, you may connect it between the “RX ANT OUT” and “RX ANT IN” jacks.

## ④ GND

Use this terminal to connect the transceiver to a good earth ground, for safety and optimum performance. Use a large diameter, short braided cable for making ground connections. Please refer to page 9 for other notes about proper grounding.

## ⑤ μ-TUNE Jacks

These jacks are used for signal input/output of the optional RF μTuning Kits.

## ⑥ ROTATOR Jack

This 6-pin MINI-DIN Jack accepts a cable connected to a YAESU **G-800DXA/-1000DXA/-2800DXA** Antenna Rotator (listed models are current as of early 2010). You may control the antenna azimuth rotation (and rotation speed) using the Function buttons on the front panel.

## ⑦ BAND DATA Jack

This 8-pin output jack provides band selection data which may be used for control of optional accessories such as the **VL-1000** Solid-state Linear Amplifier.

## ⑧ PACKET Jack

This 5-pin input/output jack provides receiver audio and squelch signals, and accepts transmit (AFSK) audio and PTT control, from an external Packet TNC. Pinout is shown on page 15. The receiver audio level at this jack is approximately 100 mVp-p (@600 Ohms).

## ⑨ RTTY Jack

This 4-pin input/output jack provides connections for an RTTY terminal unit. Pinout is shown on page 15. The receiver audio level at this jack is at a constant 100-mV (@600 Ohms) level. FSK keying at this jack is accomplished by a closure of the SHIFT line to ground by the terminal unit.

# REAR PANEL CONNECTIONS

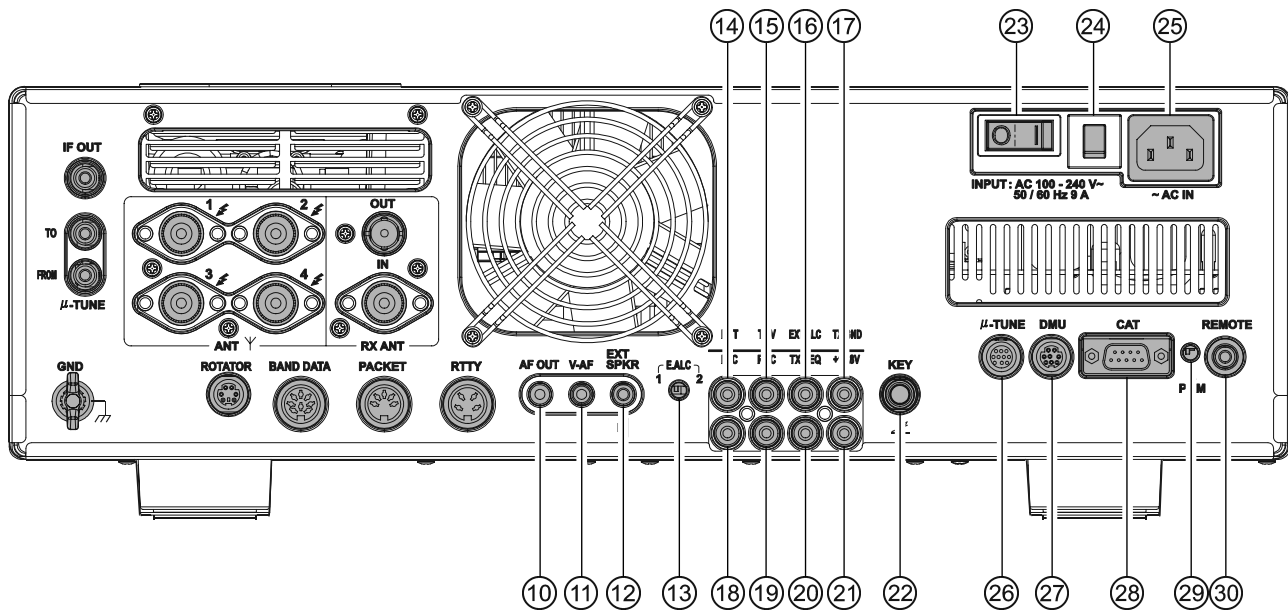

## ⑩ AF OUT Jack

This 3.5-mm, 3-contact jack provides dual-channel low-level receiver output, for recording or external amplification. Peak signal level is 300 mVp-p at 10 k-Ohms. The VFO-A receiver audio is on the left channel (tip), and the VFO-B receiver audio is on the right channel (ring). A stereo amplifier or recorder is recommended, to record each receiver's audio separately when dual reception is enabled (audio from either receiver, or both, may be used). The front panel [AF GAIN] knobs do not affect the signals at this jack.

## ⑪ V-AF Jack

This 3.5-mm, 3-contact jack is used for connection to the optional **SM-5000** Station Monitor.

## ⑫ EXT SPKR Jack

This 3.5-mm, 2-contact jack provides receiving audio output from the VFO-A and VFO-B receivers for an external loudspeaker or speakers, such as the **SP-2000**. Inserting a plug into the jack disables the internal loudspeaker. Impedance is 4 ~ 8 Ohms.

## ⑬ E.ALC Switch

This slide switch is used to select the recovery time of the ALC. Set this switch to the "1" position when the transceiver is connected to the optional **VL-1000** Solid-state Linear Amplifier.

## ⑭ PTT Jack

This RCA input jack may be used to provide manual transmitter activation using a footswitch or other switching device. Its function is identical to the [MOX] button on the front panel. The same line is available at the **PACKET** and **RTTY** jacks for TNC control. Open circuit voltage is +13.5 VDC, and closed-circuit current is 5 mA.

## ⑮ TRV Jack

This RCA jack provides a low level RF output for use with a transverter. Maximum output is approximately -10 dBm (0.1 mW) at 50 Ohms.

## ⑯ EXT ALC Jack

This RCA input jack accepts negative-going external ALC (Automatic Level Control) voltage from a linear amplifier, to prevent over-excitation by the transceiver. Acceptable input voltage range is 0 to -4 VDC.

## ⑰ TX GND Jack

This RCA jack is closed to ground while the transmitter is engaged. It may be used for control of a peripheral device, most typically a linear amplifier. To enable the jack, set Menu item "172 TGEN ETX-GND" to the "ENABLE".

The relay circuit used for this jack is capable of switching an AC voltage of 100 Volts at up to 300 mA, or a DC voltage of 60 V at 200 mA, or DC 30 V at up to 1 Amp.

## ⑱ MIC (PATCH) Jack

This RCA input jack accepts either AFSK or voice audio, for transmission. This line is mixed with the microphone audio input line, so the microphone should be disconnected if using this jack and mixing is not desired. The optimum impedance is 500 ~ 600 Ohms, and the nominal input level should be 5 mV.

## ⑲ REC Jack

This RCA jack provides low-level receiver audio output and transmit (monitor) audio (requires the [MONI] button is turned on), for external recording or external amplification. Peak signal level is 30 mVp-p at 10 k-Ohms.

## ⑳ TX REQ Jack

When this RCA jack is shorted to ground, it puts the transceiver into the transmit mode, and sends out a steady CW carrier, for linear amplifier or manual antenna tuner adjustment.

## ㉑ +13.8 V Jack

This RCA output jack provides regulated, separately fused 13.8 VDC at up to 200 mA, to power an external device such as a packet TNC. Make sure your device does not require more current (if it does, use a separate power source).

## ㉒ KEY Jack

This 1/4-inch phone jack accepts a CW key or keyer paddle. A 2-contact plug cannot be used in this jack. Key-up voltage is +5 V, and key-down current is 1 mA. Plug wiring is shown on page 15, and the jack may be configured for keyer, “Bug,” “straight key,” or computer keying interface operation via Menu item “059 A1A R-TYPE.”

## ㉓ Main Power Switch

This is the main power “on” (I)/“off” (O) switch of the transceiver. Always turn this switch on before turning on the front panel [POWER] button.

If this switch is not turned “on”, the front panel [POWER] switch will not function.

## ㉔ Circuit Breaker Switch

This circuit breaker shuts off in the event of dangerously high current consumption by the transceiver.

### ADVICE:

If the Circuit Breaker interrupts power, by all means try to determine the cause of the over-current condition before re-applying power. To restore the Circuit Breaker after verifying that all is normal, push the switch in until you hear a “click”.

## ㉕ ~AC IN Jack

Connect the supplied 3-wire AC line cord to this socket. AC voltages of 100-240 V may be accommodated by the transceiver without any sort of modification (universal voltage input).

## ㉖ μ-TUNE Jack

This 10-pin MINI-DIN jack is used for control of the optional RF μTuning Kits.

## ㉗ DMU Jack

This 8-pin MINI-DIN jack accepts a cable connected to an optional **DMU-2000** Data Management Unit or **SM-5000** Station Monitor.

## ㉘ CAT Jack

This 9-pin serial DB-9 jack allows external computer control of the transceiver. Connect a serial cable here and to the RS-232C COM port on your personal computer (no external interface is required).

## ㉙ PGM (PROGRAM) Switch

This slide switch is used for updating the transceiver’s firmware. The update software and instructions are available for download from the Vertex Standard website (<http://www.yaesu.com/>).

## ㉚ REMOTE Jack

By plugging the supplied **FH-2** Remote Control Keypad into this jack, direct access to the CPU is provided, for control of functions such as the audio playback feature, and the contest memory keyer, plus frequency and function control.

# FH-2 SWITCHES

The supplied Remote Control Keypad “**FH-2**” can be used to control the voice memory capability for the SSB/AM/FM modes, and the contest memory keyer for the CW mode. You can also play-back up to 15 seconds of incoming received audio, for verification of a missed callsign or other purposes. Some specific capabilities of the **FH-2** are:

- On SSB/AM/FM modes, five channels of storage and playback of voice memory (20 seconds each), using your own voice for recording (see page 80).
- On CW mode, the **FH-2** provides storage and recall of CW messages for repetitive CQ and contest number transmissions (see pages 94 and 96).
- Play-back of the last 15 seconds of incoming receiver audio (see page 45).

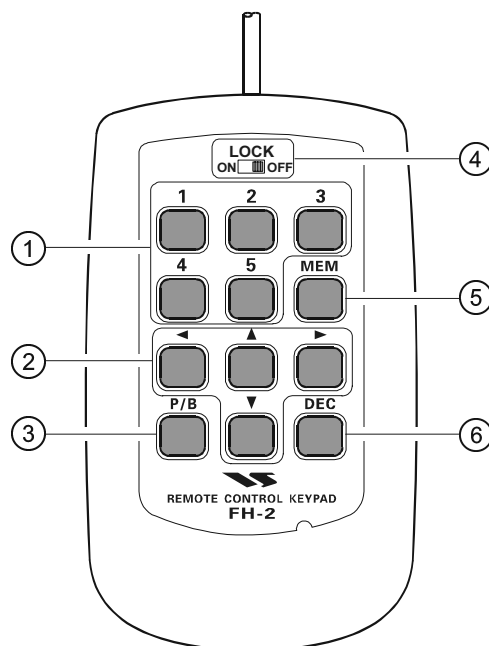

## ① [1], [2], [3], [4], [5] Switches

These buttons work as the Voice Memory and CW Message Memory Selection Key.

In the case of Voice Memory, up to 20 seconds of audio may be stored on each channel.

For CW Messages and CW Text Messages, up to 50 characters (“PARIS” specification) may be stored into each channel.

## ② [◀], [▶], [▲], [▼] Switches

These buttons are used for navigation when selecting text characters for the programming of Contest and Text memories.

## ③ [P/B] Switch

This button is used for playing back the last 15 seconds of recorded receiver audio.

## ④ [LOCK] Switch

This button may be used to lock out the **FH-2** key buttons, to prevent accidental activation of **FH-2** operations.

## ⑥ [MEM] Switch

Press this button to store either a Voice Memory, or a Contest Keyer Memory.

## ⑦ [DEC] Switch

When utilizing the sequential contest number capability of the Contest Keyer, press this button to decrement (decrease) the current Contest Number by one digit (i.e. to back up from #198 to #197, etc.).

# ***BASIC OPERATION: RECEIVING ON AMATEUR BANDS***

---

Before turning on main power, please verify the following precautions once more.

- Verify all ground connections are secure. See page 9 for details.
- Connect the antenna(s) to the rear-panel Antenna jack(s). See page 10 for details.
- Connect the microphone (and/or key or paddle). See pages 11 and 12 for details.
- If using a linear amplifier, verify the interconnections have been successfully completed? See pages 13 and 14 for details.
- Rotate both [**AF GAIN**] controls to their fully counter-clockwise positions, to avoid a loud blast of audio when the transceiver turns on. See page 21 for details.
- Rotate the [**RF PWR**] control fully counter-clockwise, to set minimum power to begin. See page 20 for details.
- If your AC mains power should suffer a significant fluctuation or interruption, we recommend that you go through a complete power-up cycle, in order to ensure that all circuits are properly initialized. To do this, be sure the front panel [**POWER**] switch is turned off, then set the rear panel main power switch to the “**●**” position. Now unplug the AC cable from the rear panel, and wait ten seconds before continuing with the start-up procedure described on the next page.

# BASIC OPERATION: RECEIVING ON AMATEUR BANDS

Here is the typical start-up procedure for normal operation:

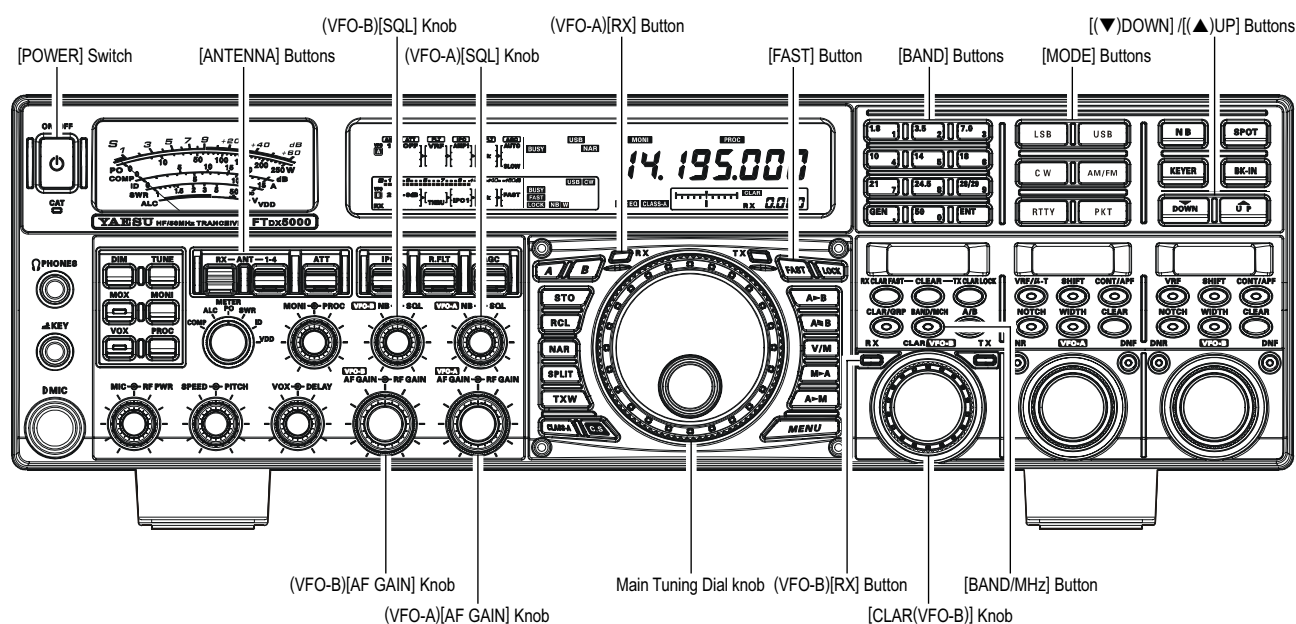

1. Plug the AC cable back in, set the rear panel main power switch to the “I” position.
2. Press and hold in the front panel [POWER] switch for one second to turn the transceiver on.
3. The transceiver will start up on 7.000.00 MHz LSB, and normal operation may begin.

**NOTE:**

To turn power off, press and hold in the front panel [POWER] switch for one second.

4. Rotate the (VFO-A)[AF GAIN] knob to set a comfortable audio level on incoming signals or noise. Clockwise rotation of the (VFO-A)[AF GAIN] knob increases the volume level.

**NOTE:**

When using headphones, start by rotating the (VFO-A)[AF GAIN] knob counter-clockwise, then bring the volume level up after you put the headphones on. This will minimize the chance of damage to your hearing caused by an unexpectedly-high audio level.

5. Press the (VFO-A)[RX] button to engage the VFO-A receiver; the imbedded LED will glow green.

**ADVICE:**

- If you press the (VFO-A)[RX] button when the LED is already glowing green, the LED will begin blinking; this indicates that the VFO-A receiver is temporarily muted. Press the (VFO-A) [RX] button once more to restore VFO-A receiver operation.

- Press the (VFO-B)[RX] button to engage Dual Reception (using the VFO-B receiver in addition to the VFO-A receiver). When you press the (VFO-B)[RX] button, it will glow green; pressing the button once more will turn the VFO-B receiver off, and the LED will go dark. Use the (VFO-B)[AF GAIN] knob to adjust the VFO-B receiver volume level.

6. Press the [BAND] button corresponding to the Amateur band you wish to operate on.

**ADVICE:**

- One-touch selection of each Amateur band between 1.8 and 50 MHz is provided.
- The FTDX5000 utilizes a triple band-stack VFO selection technique. This permits you to store up to three favorite frequencies and modes for each band in the VFO registers. For example, you may store one frequency for 14 MHz CW, one for RTTY, and one for USB, then recall each VFO by successive, momentary presses of the [14] MHz band button. Each Amateur band button has three frequency/mode settings associated with it.



# BASIC OPERATION: RECEIVING ON AMATEUR BANDS

- ❑ If you press the [BAND/MCH] button briefly, the button glows red, and the [CLAR(VFO-B)] knob may be used as the band selection knob.

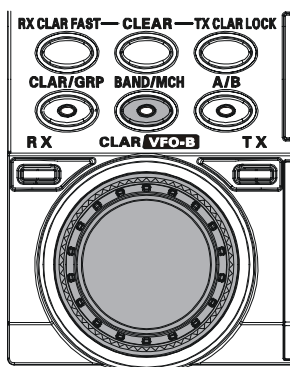

- Press the [▼(DOWN)]/[▲(UP)] buttons to tune the VFO-A frequency in 1 MHz steps.



**ADVICE:**

You may change the tuning step to 100 kHz via Menu item “144 TUN MHz SEL”. See page 133.

- Move the [ANT 1-4] button up or down to select the appropriate antenna for the band in use. Alternatively, you may also press the [RX ANT] button to select the receive antenna, if one is connected. Up to four TX/RX antennas and one RX-only antenna may be connected.

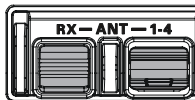

**ADVICE:**

- ❑ Your antenna selection is “remembered” (in conjunction with the frequency and mode) in the VFO register in use, when you choose that particular antenna.
- ❑ When VFO-A and VFO-B are switched to the same antenna jack, VFO-B receiver will be automatically connected to the RX ANT jack.
- ❑ When both VFO-A and VFO-B are switched to the RX ANT, the signal output from the RX OUT jack is connected to the VFO-A receiver.

- Press the appropriate [MODE] button to select the desired operating mode.

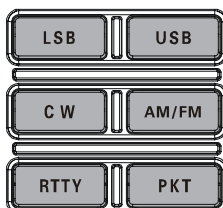

**ADVICE:**

- ❑ By convention in the Amateur bands, LSB is used on the 7 MHz and lower bands (with the exception of 60 meters), while USB is utilized on the 14 MHz and higher bands.
- ❑ When changing modes from SSB to CW, you will observe a frequency shift on the display. This shift represents the BFO offset between the “zero beat” frequency and the audible CW pitch (tone) you can hear (the pitch is programmed by the [PITCH] knob), even though the actual tone that you hear is not changing. If you do not want this frequency shift to appear when changing modes, you may change the BFO offset setting in Menu item “066 A1A FRQ DISP”, described on page 127.

- ❑ When operating on the FM mode in the VFO-A, rotate the (VFO-A)[SQL] (Squelch) knob clockwise just to the point where the background noise is silenced. This is the point of maximum sensitivity to weak signals. Excessive advancement of the Squelch knob will degrade the ability of the receiver to detect weak signals. Adjustment of the VFO-B Squelch is accomplished using the (VFO-B)[SQL] knob.

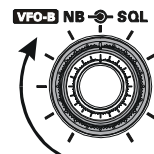
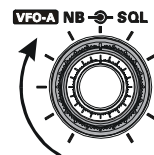

- Rotate the Main Tuning Dial knob to tune around the band, and begin normal operation.

**ADVICE:**

- ❑ Clockwise rotation of the Main Tuning Dial knob increases the operating frequency, one “step” of the synthesizer at a time; similarly, counter-clockwise rotation of the Main Tuning Dial knob will decrease the frequency.

A “normal” and a “fast” step choice is available on each operating mode. Pressing the [FAST] button engages the “Fast” tuning selection.

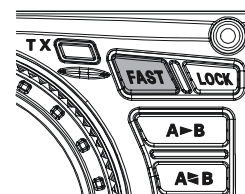

OPERATING MODE	1 STEP	1 DIAL ROTATION
LSB, USB, CW, RTTY, PKT (LSB)	10Hz [100Hz]	10kHz [100kHz]
AM, FM, PKT (FM)	100Hz [1kHz]	100kHz [1MHz]

[ ] : [FAST] switch set to “ON”

- ❑ It is possible to set the frequency dial rotation steps separately, solely for CW mode operation, using Menu items “142 TUN DIAL STP”, and “143 TUN CW FINE”. See page 133.
- ❑ If you want to navigate frequency change quickly, there are several techniques available:
  - Direct keyboard entry of the frequency (see page 49).
  - Use of the microphone [UP]/[DWN] scanning keys, if your microphone is so equipped (see page 49).

**ANTENNA CIRCUIT DIAGRAM**

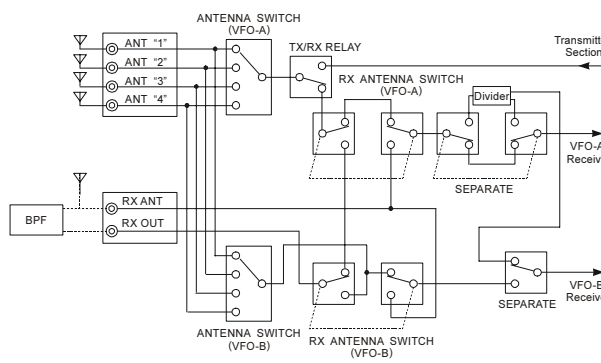

# BASIC OPERATION: RECEIVING ON AMATEUR BANDS

## CLAR (CLARIFIER) OPERATION ON VFO-A

The [RX CLAR/FAST], [CLEAR], [TX CLAR/LOCK] buttons, and the [CLAR(VFO-B)] knob are used to offset the receive, the transmit, or both frequencies from their settings on VFO-A (the Clarifier does not affect VFO-B). The four small numbers on the LCD display show the current Clarifier offset. The Clarifier controls on the FTdx5000 are designed to allow you to preset an offset up to  $\pm 9.999$  kHz without actually retuning, and then activate it using the Clarifier [RX CLAR/FAST] and [TX CLAR/LOCK] buttons. This feature is ideal for following a drifting station, or for setting the small frequency offsets sometimes utilized in DX “Split” operation.

Here is the technique for utilizing the Clarifier:

1. Press the [RX CLAR/FAST] button. The “**CLAR**” and “**RX**” icons will appear in the display, and the programmed offset will be applied to the receive frequency.



### ADVICE:

If the “**CLAR**” and “**RX**” icons do not appear, check to see if the [A/B] button glows orange. If so, press the [A/B] button to cause the LED in the [A/B] button to go out. Now, press the [RX CLAR/FAST] button to begin clarifier operation.

2. Rotation of the [CLAR(VFO-B)] knob will allow you to modify the initial offset on the fly. Offsets of up to  $\pm 9.999$  kHz may be set using the Clarifier.



To cancel Clarifier operation, press the [RX CLAR/FAST] button. The “**CLAR**” and “**RX**” icons will disappear from the display.

### ADVICE:

Turning the clarifier “off” simply cancels the application of the programmed offset from the receive and/or transmit frequencies. To clear out the programmed clarifier offset altogether, and reset it to “zero,” press the [CLEAR] button.

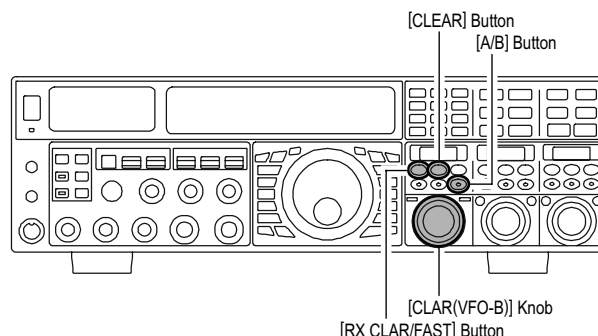

### TX CLAR

Without changing the receive frequency, you may alternatively apply the Clarifier offset to the transmit frequency (typically, for “split” DX pile-ups). See page 82 for details.

### The Tuning Offset Indicator provides a graphical representation of the Clarifier offset.

In CW mode, the Tuning Offset Indicator depicts the CW Center Tuning, instead of the Clarifier Offset, this is the factory default setting. If you wish to change this, so that the Clarifier Offset is also displayed on CW, use the following procedure:

1. Press the [MENU] button to enter the Menu mode.
2. Rotate the (VFO-A)[SELECT] knob to select Menu item “012 DISP BAR SEL”.
3. Rotate the (VFO-B)[SELECT] knob to select “CLAR (Clarifier)” (replacing the default “CW TUNE (CW TUNING)” selection).
4. Press and hold in the [MENU] button for two seconds to save the new setting and exit to normal operation.

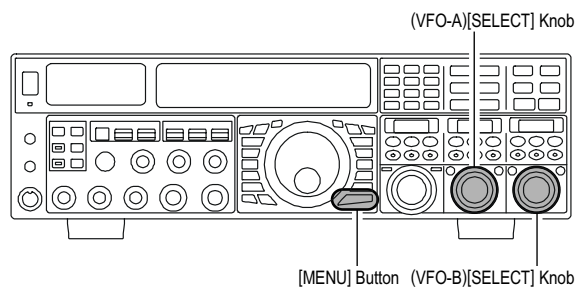
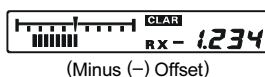
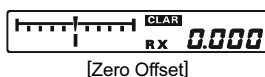
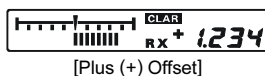

# BASIC OPERATION: RECEIVING ON AMATEUR BANDS

## LOCK

You may lock the setting of the Main Tuning Dial knob, to prevent accidental frequency change.

To lock out the Main Tuning Dial knob, just press the **[LOCK]** button that is located to the right of the Main Tuning Dial knob. To unlock the Dial setting, and restore normal tuning, just press the **[LOCK]** button once more.

When the Main Tuning Dial knob is “locked”, the blue **“LOCK”** icon will appear on the display.

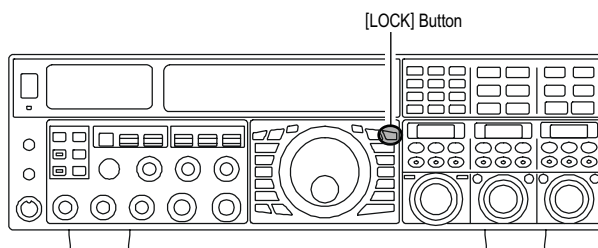

## DIM

The illumination level of the analog meter and frequency display may be reduced, if you are using the transceiver in a dark environment where high brightness is not desired.

To reduce the illumination level, press the **[DIM]** button, located to the left of the analog meter. To restore full brightness, press the **[DIM]** button once more.

### ADVICE:

The amount of brightness may be customized for different front panel areas. The following menu settings are effective when the **[DIM]** button is depressed:

- 008 DISP DIM MTR:** for analog meter
- 009 DISP DIM VFD:** for frequency display
- 010 DISP DIM OLE:** **SUB DISPLAY** windows
- 011 DISP DIM ELCD:** for Spectrum Scope display of the optional **SM-5000** Station Monitor

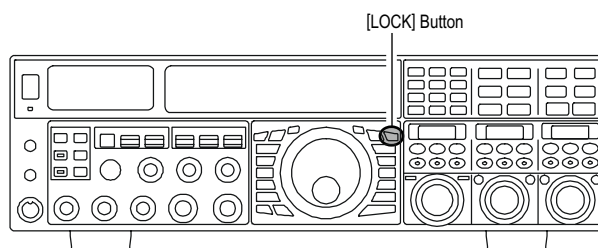

## OPERATION ON 60-METER (5 MHz) BAND (U.S. VERSION ONLY)

The recently-released 60-meter band is covered, in the **FTDX5000**, by five special, fixed memory channels. These channels are set to USB, and they appear between the “last” PMS channel (“P-9U”) and the first “regular” memory channel (Channel 1).

To operate on the 60-meter (5 MHz) band:

1. Press the **[V/M]** button once, if necessary, to enter the “Memory” mode (the **“MR”** icon will appear on the display).
2. Press and hold in the **[BAND/MCH]** button for two seconds. The button will glow yellow to signify that rotation of the **[CLAR(VFO-B)]** knob will allow selection of the memory channel.
3. Memory channels “US-1” through “US-5” are pre-programmed, at the factory, with the permitted frequencies in the 5 MHz band, and the USB mode is automatically selected on these channels.
4. To exit from 60-meter operation and return to the VFO mode, just press the **[V/M]** button.

### NOTE:

The frequencies and operating mode for 5 MHz band operation are both fixed, and may not be changed.

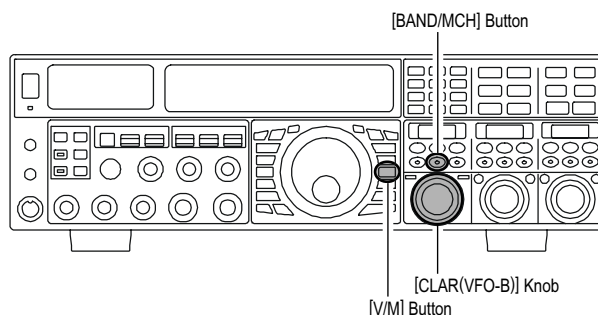

CHANNEL NUMBER	FREQUENCY
US-1	5.3320 MHz
US-2	5.3480 MHz
US-3	5.3680 MHz
US-4	5.3730 MHz
US-5	5.4050 MHz

# CONVENIENCE FEATURES

## DUAL RECEIVE

The **FTdx5000** is capable of simultaneous reception on the *same amateur band*, using the VFO-A and VFO-B receivers, in the “Dual Receive” mode. This is especially useful for DX work, here is the operating procedure for Dual Receive operation.

1. While receiving on VFO-A, engage the VFO-B receiver by pressing the **(VFO-B)[RX]** button, located to the upper left of the **[CLAR(VFO-B)]** knob. You will now be receiving on the two frequencies shown on the LCD display (for VFO-A) and **SUB DISPLAY-1** (for VFO-B).
2. Adjusting the volume:  
To adjust the VFO-A audio level, rotate the **(VFO-A)[AF GAIN]** knob. To adjust the VFO-B audio level, rotate the **(VFO-B)[AF GAIN]** knob. In both cases, clockwise rotation of the knob will increase the volume level.
3. Press the **[B]** button, located to the upper left of the Main Tuning Dial knob. The **[B]** button will glow orange, and you may now change the operating mode of the VFO-B receiver by pressing the appropriate **[MODE]** selection button.
4. You may also press the **[BAND]** buttons to select the operating band for the VFO-B receiver.
5. To return the mode and band selections to VFO-A, press the **[A]** button, located to the left of the **[B]** button. The **[A]** button will glow red, and you may now change the operating mode and band of the VFO-A receiver.
6. Rotate the Main Tuning Dial knob to adjust the Main VFO-A frequency, and rotate the **[CLAR(VFO-B)]** knob to adjust the VFO-B frequency.

### ADVICE:

- If the VFO-B frequency does not change, check to see if the orange LED in the **[A/B]** button is illuminated. If not, pressing the **[A/B]** button will cause the **[A/B]** button to glow orange. Now, rotate the **[CLAR(VFO-B)]** knob to adjust the VFO-B frequency.
7. To cancel Dual Receive operation, and receive only on the VFO-A receiver, press the **(VFO-B)[RX]** button; the imbedded green LED will go out, and monoband operation on the VFO-A receiver will resume.

### NOTE:

Remember that, while the **[B]** button glows orange, any mode or band changes will still be applied to the VFO-B receiver, whether or not Dual Receive is engaged.

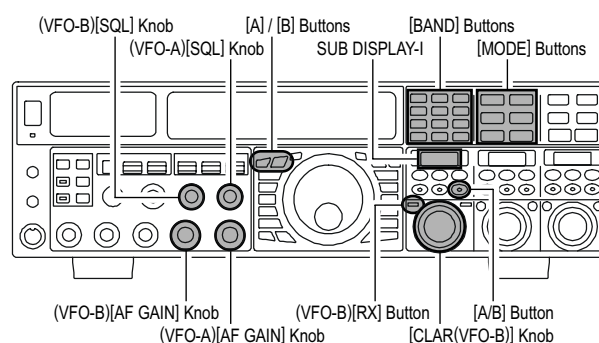

### QUICK POINTS:

By convention in the amateur bands, LSB is used on the 7 MHz and lower bands (with the exception of 60 meters), while USB is utilized on the 14 MHz and higher bands.

### ADVICE:

- When operating in Dual Receive, the manner in which the audio is fed to the left and right headphones (Stereo, Monaural, or Mixed) may be configured using Menu item “**108 ROUT HEADPHN**” (see page 130).
- When changing modes from SSB to CW, you will observe a frequency shift on the display. This shift represents the BFO offset between the “zero beat” frequency and the audible CW pitch (tone) you can hear (the pitch is programmed by the **[PITCH]** knob), even though the actual tone that you hear is not changing. If you do not want this frequency shift to appear when changing modes, you may change the BFO offset setting in Menu item “**066 A1A FRQ DISP**”, described on page 127.
- When operating on the FM mode on the VFO-B receiver, rotate the **(VFO-B)[SQL]** knob clockwise just to the point where the background noise is silenced. This is the point of maximum sensitivity to weak signals. Excessive advancement of the **(VFO-B)[SQL]** knob will degrade the ability of the receiver to detect weak signals. Adjustment of the VFO-A squelch is accomplished using the **(VFO-A)[SQL]** knob.

## DUAL RECEIVE

### Using Headphones for Dual Receive

To take advantage of dual reception, you will want to connect stereo headphones to the **PHONES** jack. In addition to the **AF GAIN** controls, headphone audio mixing can also be configured as desired from Menu item “**108 ROUT HEADPHN**”. Three audio mixing schemes are selectable as follows:

**SEPARATE:** Audio from the VFO-A receiver is heard only in the left ear, and VFO-B receiver audio solely in the right ear.

**COMBINE1:** Audio from both VFO-A and VFO-B receivers can be heard in both ears, but VFO-B audio is attenuated in the left ear and VFO-A audio is attenuated in the right ear.

**COMBINE2:** Audio from both VFO-A and VFO-B receivers are combined and heard equally in both ears (“Monaural” mode).

### VFO Tracking Feature

You may lock VFO-B to track in unison with VFO-A when the main tuning dial is adjusted. See page 83 for details.

Go to Menu item “**038 GENE TRACK**” to set the tracking function as follows:

**OFF:** VFO-A and VFO-B tune independently (Default)

**BAND:** Band Change operations will be applied to VFO-A and VFO-B simultaneously.

**FREQ:** VFO-A and VFO-B tune in unison when The Main Tuning dial is adjusted. However, VFO-B may be adjusted separately.

### Sideband Diversity Reception

Here you receive a single AM signal through the two receivers, each receiving the opposite sideband. Skywave-propagated signals often show phase distortion in this mode, but it gives you a view of the entire passband, from which you can then select the best sideband for listening (or for SWL Dx’ing, you may want to listen to both sidebands at the same time, to get the best copy). On groundwave signals, where the phase of the sidebands is likely to be the same, there is an interesting sense of depth to the signal.

To tune in a signal using this mode, you should have stereo headphones connected to the front panel **PHONES** jack.

- Set VFO-A to either LSB or USB mode, and tune for zero beat on the desired signal.
- Press the [**A►B**] button to copy this mode and frequency into VFO-B, then press the [**MODE**] button to select the opposite sideband for VFO-A.
- If using headphones, set the headphone mixing scheme to the “COMBINE1” mode via Menu item “**108 ROUT HEADPHN**”, and activate dual reception.
- Adjust the [**AF GAIN**] knob(s) to balance the volume of the two receivers.
- If interference is present on one of the channels, you may have to turn its [**AF GAIN**] knob to suppress that channel (or press the green [**RX**] button to disable the receiver with the sideband experiencing interference). Otherwise, try changing the headphone audio mixing scheme to “COMBINE2” or “SEPARATE” in the Menu item “**108 ROUT HEADPHN**”, for different effects (or try settings with similar effects, if you use an external audio amplifier). Although you don’t get the “stereophonic” effect in the monaural mode, the two signals are still mixed, offering the potential for much better copy than in regular AM or even single-sideband ECSS modes.

# CONVENIENCE FEATURES

## DUAL RECEIVE

### Bandwidth Diversity Reception

This mode involves receiving the same signal through two different bandpass filters. The frequency and mode of both VFO-A and VFO-B are the same. VFO-A can be set up for a wide bandpass, using the [WIDTH] knobs, and VFO-B for a narrow bandpass, resulting in a spatial perception of the channel. Although any mode (except FM) can be used, CW offers the widest array of choices, and perhaps the most startling effects on crowded channels.

Stereo headphones or external stereo speakers are recommended for this mode. To set up the transceiver for bandwidth diversity reception:

- Select the desired mode on VFO-A.
- Tune to the signal of interest.
- Press the [A►B] button to copy this mode and frequency into the VFO-B.
- If using headphones, set the headphone mixing scheme to the "COMBINE1" mode via Menu item "108 ROUT HEADPHN", and activate dual reception.
- Adjust the [AF GAIN] knob(s) to balance the volume of the two receivers.
- Now try manipulating the [SHIFT] and [WIDTH] knobs to observe the interesting effects of bandwidth diversity.

### Polarity Diversity

Similar in concept to the bandwidth diversity just described, another interesting capability of the **FTDX5000** dual reception, is the ability to use two different antennas on the same frequency. For example, you might have a horizontal Yagi on the main band, and a vertical antenna on the sub band, then lock the two frequencies together and engage dual reception.

Frequently, the fading observed on the HF bands is not so much a change in ionization level, but rather a shift in the polarization of the signal as it travels to and from the ionosphere. Having an opposite-polarization antenna available can fill in the signal during deep fades. You may then transmit on whichever antenna is providing the strongest signal at the moment (see the discussion below on Split Frequency operation).

## P.BACK (AUDIO PLAYBACK) FROM MAIN (VFO-A) RECEIVER

When Audio Playback is engaged by the operator, the **FTdx5000** begins automatically recording the last 15 seconds of incoming receiver audio on VFO-A. Recording is controlled with the supplied **FH-2** Remote Control Keypad, plugged into the rear panel **REMOTE** jack. This capability is especially useful for confirming a callsign that may have been difficult to copy due to noise or QRM, etc.

### Recording

- ❑ Press and hold in the **FH-2**'s **[P/B]** key for two seconds to initiate recording. The “**REC**” icon will appear in the display to confirm that recording is in progress.
- ❑ Press the **FH-2**'s **[P/B]** key briefly to halt recording; the “**REC**” icon will go out.

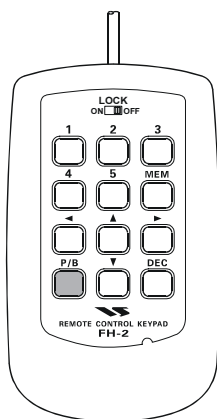

### Playback

- ❑ Press the **FH-2**'s **[P/B]** key *briefly*, after recording has been halted, to begin playback of the recorded audio; the “**PLAY**” icon will appear in the display to confirm that playback is in progress. The last 15 seconds of audio will be heard in the speaker or headphones. If you do not intervene, the entire 15 seconds will be played back, repeating endlessly.
- ❑ To halt playback at any time, just press the **[P/B]** key briefly again. The next time you press the **[P/B]** key, it will pick up the playback where you left off.

### ADVICE

You may adjust the playback level of the recording with the main **[AF GAIN]** knob.

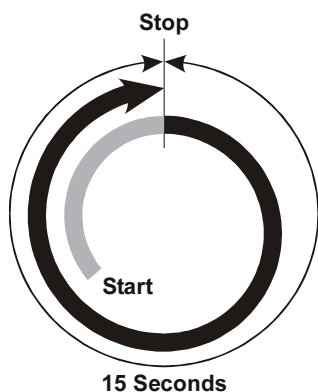



# CONVENIENCE FEATURES

## “MY BANDS” OPERATION

When operating on an amateur band, it is possible to use the [CLAR(VFO-B)] knob to change the selected operating band. The “My Bands” feature allows you to designate several amateur bands, and make *only* those bands available for selection with the [CLAR(VFO-B)] knob.

This feature can be *very* useful in a contest, where the 10/18/24 MHz bands are not used, or if you do not have antennas for some bands.

### “My Bands” Setup

1. Press the [MENU] button to engage the Menu mode.
2. Rotate the (VFO-A)[SELECT] knob to select Menu item “150 TUN MY BAND”.
3. Rotate the (VFO-B)[SELECT] knob to choose a band that you wish to *skip* (omit) from the band-selection loop (when using the [CLAR(VFO-B)] knob for band selection). The available choices are 1.8M/3.5M/7M/10M/14M/18M/21M/24M/28M/50M/GEN(General Band)/T14M(Transverter “1”)/T28M(Transverter “2”)/T50M(Transverter “3”).
4. Press the [ENT] button (one of the [BAND] buttons) to set the selected band to “skipped”. The “ON” notation at the right of the band notation will change to “OFF”.
5. Repeat steps 3 and 4 to select (“ON”) or deselect (“OFF”) as many bands as you like.
6. Press and hold in the [MENU] button for two seconds to lock in the new configuration and exit to normal operation.

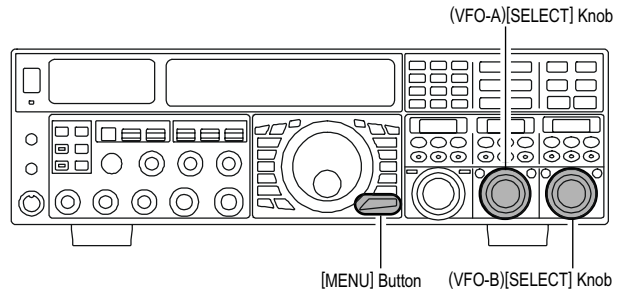

### ADVICE:

The “My Band” feature affects *only* VFO-A band.

### “My Band” Operation

1. Press the [V/M] button once, if necessary, to enter the “VFO” mode.
2. Press the [BAND/MCH] button briefly; the button will glow Red.
3. Rotate the [CLAR(VFO-B)] knob to choose the amateur band on which you wish to operate. Only those amateur bands that have not been skipped will appear as you scroll through the bands.

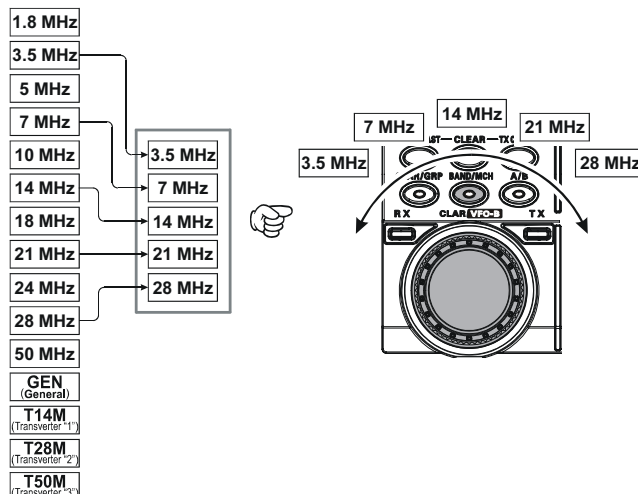
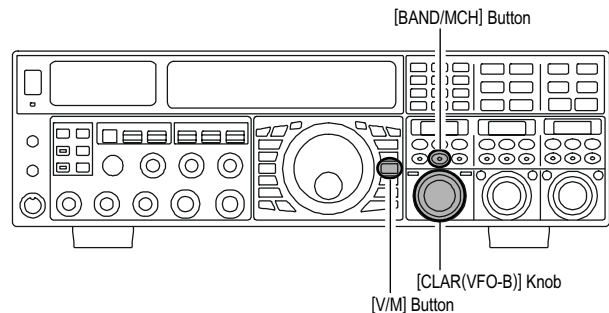



## BAND STACK OPERATION

The **FTdx5000** utilizes a triple band-stack VFO selection technique that permits you to store up to three favorite frequencies and modes onto each band's VFO register. For example, you may store one frequency each on 14 MHz CW, RTTY, and USB, then recall each VFO by successive, momentary presses of the [**14**] MHz band button. Each Amateur band key may similarly have up to three frequency/mode settings applied. Both the VFO-A and VFO-B systems have their own, independent, band stacks.

A typical setup, for the 14 MHz band, might be arranged like this:

1. Program 14.025 MHz, CW Mode, then press the [**14**] MHz band button;
2. Program 14.080 MHz, RTTY Mode, then press the [**14**] MHz band button;
3. Program 14.195 MHz, SSB Mode, then press the [**14**] MHz band button.

With this configuration, successive momentary presses of the [**14**] MHz band button will allow you to toggle sequentially through these three VFO configurations.

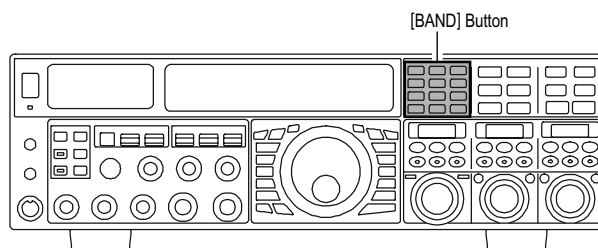

## C.S (CUSTOM SWITCH)

An often-used Menu mode selection may be programmed to the front panel [**C.S**] button.

### C.S Setup

1. Press the [**MENU**] button to engage the Menu mode; the Menu list will appear on the **SUB DISPLAY** windows.
2. Rotate the (**VFO-A**)[**SELECT**] knob to select the Menu item you want to be able to access via the [**C.S**] button.
3. Press and hold in the [**C.S**] button for two seconds to lock in your selection.
4. Press and hold in the [**MENU**] button for two seconds to save the new configuration and exit to normal operation.

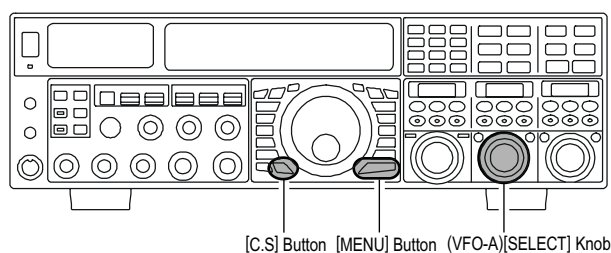

### Menu Selection Recall via [**C.S**] button

1. Press the [**C.S**] button. The programmed Menu item will appear on the display.
2. You may now rotate the (**VFO-B**)[**SELECT**] knob to change the setting of this menu item.
3. Press the [**MENU**] button for two seconds, when you are done, to save the new configuration and exit to normal operation.

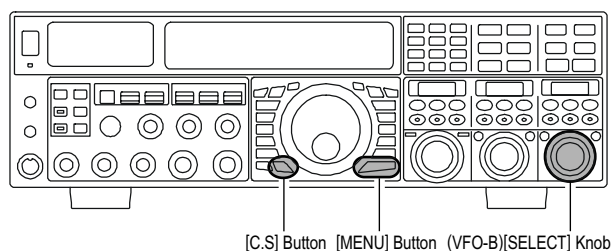

# CONVENIENCE FEATURES

## ROTATOR CONTROL FUNCTIONS

When using a YAESU model **G-800DXA**, **G-1000DXA**, or **G-2800DXA** rotator (not supplied), it is possible to control it from the front panel of the **FTDx5000**.

- 1 Press and hold in the **[ENT]** button (one of the **[BAND]** buttons) for two seconds. The **SUB DISPLAY** windows will change, and display the “Rotator Control” configuration.
- 2 Press either the **[3.5(2)]** button or the **[7.0(3)]** button to rotate the antenna. Pressing the **[3.5(2)]** button will cause rotation to the left (counter-clockwise), while pressing the **[7.0(3)]** button will cause rotation to the right (clockwise).
- 3 Press the **[14(5)]** button or the **[18(6)]** button to control the speed of rotation. Pressing the **[14(5)]** button will cause slower rotation, while pressing the **[18(6)]** button will speed up rotation. Usually, you will be using the “100%” setting.

When you are through exercising rotator control, press the **[ENT]** button briefly. The **SUB DISPLAY** windows will return to the normal display.

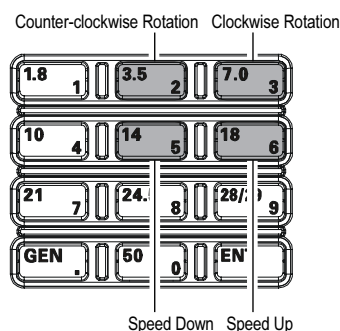
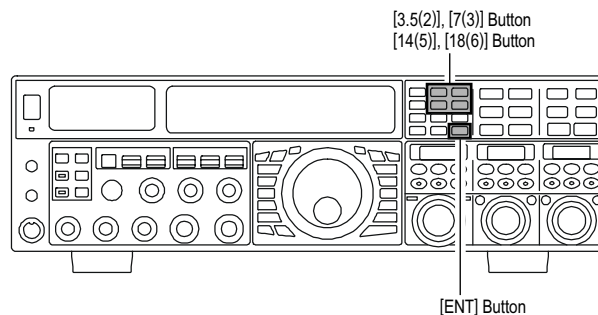

### IMPORTANT NOTE

- ❑ Set the **FTDx5000** to match the starting point of your rotator control indicator needle via Menu item “**014 DISP RTR STU**”. The default setting is “0°” (north). If your controller starting point is south, the Menu item “**014 DISP RTR STU**” must be set to “180°”. If not set properly the **FTDx5000** display will not show the correct direction.
- ❑ When the rotator control indicator needle does not indicate the precise antenna direction, adjust the indicator needle precisely to the antenna direction via Menu item “**015 DISP RTR ADJ**”.

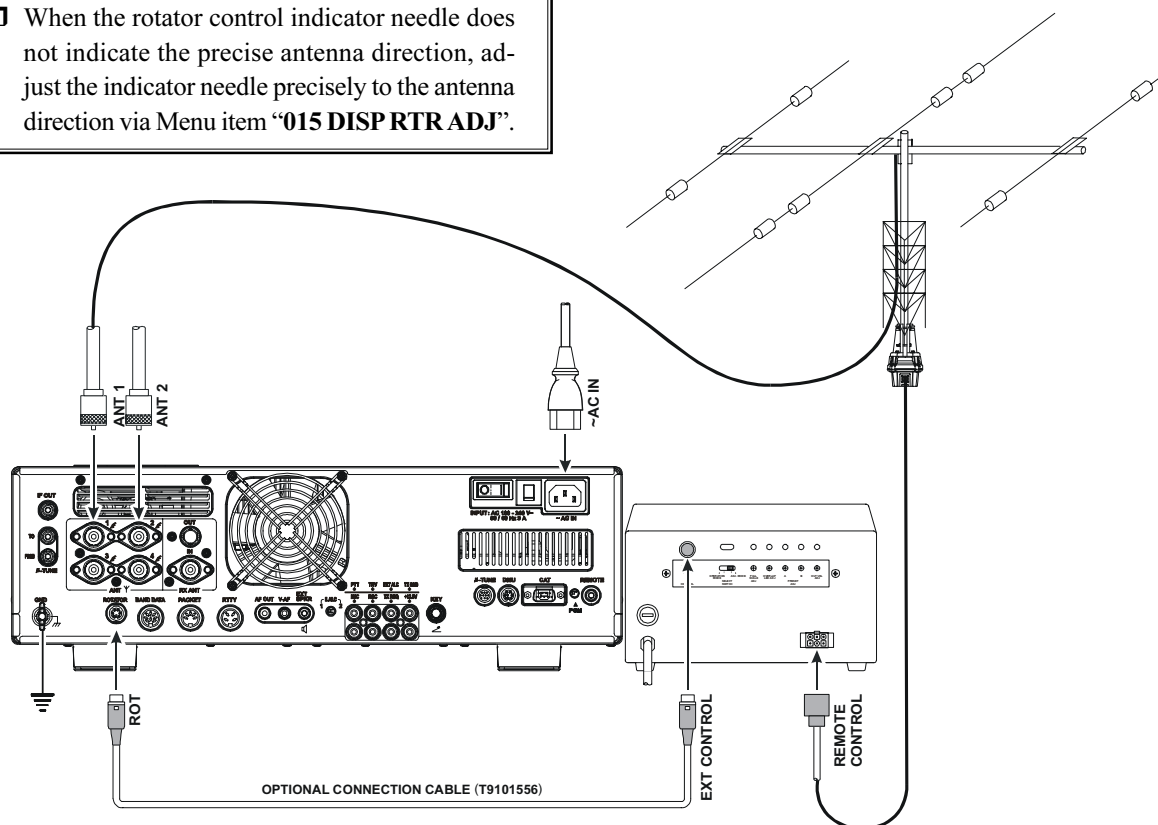

## MORE FREQUENCY NAVIGATION TECHNIQUES

### Keyboard Frequency Entry

You may enter operating frequencies, for either the VFO-A or VFO-B bands, using the front panel band/frequency selection keys.

#### Example 1: Enter 14.250.000 MHz into VFO-A

- Press the **[ENT]** button to engage the direct frequency entry process. Now, beginning with the “10 MHz” digit of the frequency (the leftmost digit), we will enter the required digits of the frequency.
 
- Press, in order, the digits of the operating frequency, using the **[BAND]** buttons (which have the frequency-entry digit or decimal point on the right side of the slash bar). In this example, enter **[1.8/1]** → **[10/4]** → **[GEN./.]** → **[3.5/2]** → **[14/5]** → **[50/0]** → **[50/0]** → **[50/0]** → **[50/0]**. The decimal point after the “MHz” portion of the frequency must be entered, but no decimal point is required after the “kHz” portion.
- Press the **[ENT]** button once more. A short “beep” will confirm that the frequency entry was successful, and the new operating frequency will appear on the Main (VFO-A) frequency display fields.

#### Example 2: Enter 7.100.000 MHz into VFO-B

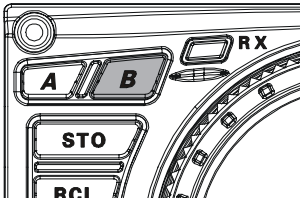
- Press the **[B]** button, located to the upper left of the Main Tuning Dial knob. The **[B]** button will glow orange.
 
- Press the **[ENT]** button to engage the direct frequency entry process. Now, beginning with the “10 MHz” digit of the frequency (the leftmost digit), we will enter the required digits of the frequency to be entered into the VFO-B register.
- Press, in order, the digits of the operating frequency, using the **[BAND]** buttons (which have the frequency-entry digit or decimal point on the right side of the slash bar). In this example, enter **[21/7]** → **[GEN./.]** → **[1.8/1]** → **[50/0]** → **[50/0]** → **[50/0]** → **[50/0]** → **[50/0]**.
- Press the **[ENT]** button once more. A short “beep” will confirm that the frequency entry was successful, and the new operating frequency will appear on the VFO-B frequency display, **SUB DISPLAY-I** window.

#### ADVICE:

If you attempt to enter a frequency outside the operating range of 30 kHz ~ 60 MHz, the microprocessor will ignore the attempt, and you will be returned to your previous operating frequency. If this happens, please try again, taking care not to repeat the error in the frequency entry process.

### Using the [▼(DOWN)]/[▲(UP)] Buttons

- To tune the VFO-A frequency in 1 MHz step. Press the **[▲(UP)]** or **[▼(DOWN)]** button.
 
- To tune the VFO-B frequency in 1 MHz step. Press the **[B]** button first (The **[B]** button will glow orange), then press the **[▲(UP)]** or **[▼(DOWN)]** button.

#### ADVICE:

You may change the tuning step of the **[▲(UP)]**/**[▼(DOWN)]** buttons to 100 kHz via the Menu item “144 TUN MHz SEL”. See page 133.

### Using the [UP]/[DWN] Switches of the Supplied MH-31B8 Hand Microphone

The **[UP]/[DWN]** switches on the supplied **MH-31B8** Hand Microphone may also be used for manually scanning upward or downward in frequency.

The microphone **[UP]/[DWN]** switches utilize the tuning steps of the Main Tuning Dial knob; moreover, when the microphone **[FAST]** key is pressed, the tuning rate will change to 100 Hz, similar to the effect of the transceiver front-panel **[FAST]** button.

#### ADVICE:

In the AM and FM modes, you may independently set the tuning steps when using the **[UP]/[DWN]** switches. To set new tuning steps, use Menu items “145 TUN AM STEP” and “146 TUN FM STEP”.

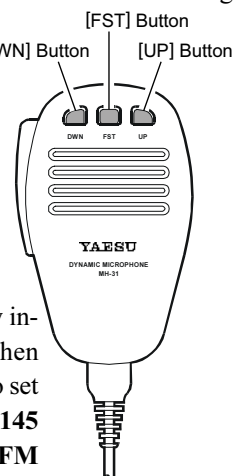

# CONVENIENCE FEATURES

## RECEIVER OPERATION (FRONT END BLOCK DIAGRAM)

The **FTdx5000** includes a wide range of special features to suppress the many types of interference that may be encountered on the HF bands. However, real world interference conditions are constantly changing, so optimum setting of the controls is somewhat of an art, requiring familiarity with the types of interference and the subtle effects of some of the controls. Therefore, the following information is provided as a general guideline for typical situations, and a starting point for your own experimentation.

Yaesu provides the optional RF- $\mu$ TUNING Unit (Narrow-bandwidth High-Q RF Filter) for additional protection from strong signal interference.

### VRF (SEE PAGE 54)

On the 1.9 - 28 MHz amateur bands, Yaesu's powerful VRF (Variable RF Filter) preselector circuit provides excellent suppression of out-of-band interference. The pass-band is much narrower than that provided by traditional fixed bandpass filters.

### R. FLT (IF Roofing Filters) (SEE PAGE 56)

On the VFO-A receiver, Roofing filters, in bandwidths of 15 kHz, 6 kHz, 3 kHz, 600Hz, and 300 Hz (optional in some models), are provided in the 9 MHz First IF, right after the first mixer. These filters provide narrow-band selectivity to protect the following IF and DSP stages. The 15 kHz, 6 kHz, or 3 kHz filters are automatically selected for typical operating modes, and may be manually changed by the operator, if desired, for special operating circumstances.

The VFO-B receiver 40 MHz IF includes three Roofing filters, with bandwidths of 15 kHz, 6 kHz, and 3 kHz.

### CONTOUR Filter (SEE PAGE 58)

The DSP Contour filter is a unique capability of the **FTdx5000**, providing either nulling or peaking of tunable segments of the receiver passband. The Contour filter can suppress interference, or excessive frequency components on an incoming signal, or it can peak those tunable frequency segments. The amount of nulling/peaking, and the bandwidth over which it is applied, are adjustable via the Menu.

### IF SHIFT (SEE PAGE 60)

The passband center frequency response of the IF DSP filtering may be adjusted using this control.

### IF WIDTH (SEE PAGE 61)

The width of the IF DSP filtering may be adjusted using this control.

### IF NOTCH (SEE PAGE 63)

The IF Notch filter is a high-Q notch filter that can significantly reduce, or eliminate, an interfering carrier. The Q (sharpness) of the filter may be adjusted using the Menu.

### DNR (DIGITAL NOISE REDUCTION) (SEE PAGE 64)

The DSP's Digital Noise Reduction (DNR) feature utilizes sixteen different mathematical algorithms to analyze and suppress different noise profiles encountered on the HF/50 MHz bands. Choose the selection that provides the best noise suppression, which concurrently will allow the signal to rise up out of the noise.

### DNF (DIGITAL NOTCH FILTER) (SEE PAGE 64)

When multiple interfering carriers are encountered during reception, the Digital Notch Filter can significantly reduce the level of these signals.

### AGC (SEE PAGE 67)

The AGC system is highly adaptable to changing signal and fading characteristics, making reception possible under the most difficult conditions.

### SLOPED AGC (SEE PAGE 68)

Instead of limiting a wide range of audio output signals to a fixed upper bound, the sloped AGC system actually allows the audio output to rise, very gently, with ever-increasing signal strength. This capability allows you to mentally separate signals, according to signal strength, in addition to slight frequency differences.

### IF Filter Quality Adjustment (SEE PAGE 131)

The "Q" (quality factor) of the IF DSP filters may be adjusted using the Menu.

### Variable IF Filter Shape Factor (SEE PAGE 131)

You may adjust the shape factor of the receiver IF DSP filters using the Menu.

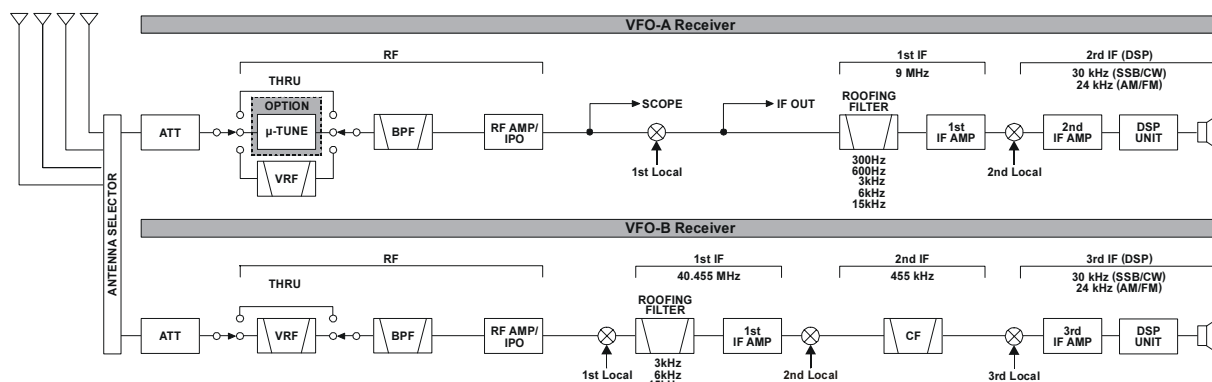

## IPO (INTERCEPT POINT OPTIMIZATION)

The IPO feature allows the operator to optimize the characteristics of the receiver front end, depending on the current noise level and the strength of incoming signals.

### VFO-A IPO Setup

- Press the **[A]** button to activate VFO-A receiver (The **[A]** button will glow red).
- Move the **[IPO]** knob up or down to set the desired characteristic of the VFO-A receiver front end, per the chart below.

**AMP1:** Amplifies the incoming signal, using a low distortion RF preamplifier (normally, the IPO is set to this position).

**AMP2:** Increases receiver sensitivity.

**IPO1:** Improves the IPO.

**IPO2:** Bypasses the RF preamplifier, yielding direct feed to the first mixer. As a result, the IPO is improved more.

The selected receiver RF preamplifier will be indicated in the IPO column of the Block Diagram Display.

ANT	ATT	FLT	IPO	R.FLT	AGC
VFO 1	OFF	VRF	AMP1	300	AUTO
VFO 2	-6dB	H-T	AMP2	600	FAST
VFO 3	-12dB	THRU	IPO1	3k	MID
RX 4	-18dB		IPO2	6k	SLOW
				15k	

- Press the **[IPO]** knob briefly, to quickly set the IPO to "AMP1".

### VFO-B IPO Setup

- Press the **[B]** button to activate VFO-B receiver (The **[B]** button will glow orange).
- Move the **[IPO]** knob up or down to set the desired characteristic of the VFO-B receiver front end, per the chart below.

**AMP1:** Amplifies the incoming signal, using a low distortion RF preamplifier (normally, the IPO is set to this position).

**AMP2:** Increases receiver sensitivity.

**IPO1:** Improves the IPO.

The selected receiver RF preamplifier will be indicated in the IPO column of the Block Diagram Display.

S=1	3	5	7	9	+20	+40	+60dB
VFO 1	OFF	VRF	AMP1	3k	AUTO		
VFO 2	-6dB	THRU	AMP2	6k	FAST		
VFO 3	-12dB		IPO1	15k	MID		
RX 4	-18dB				SLOW		

- Press the **[IPO]** knob briefly, to quickly set the IPO to "AMP1".

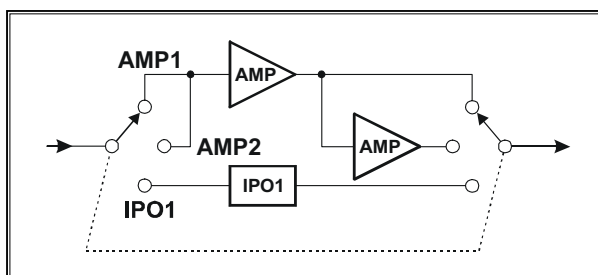
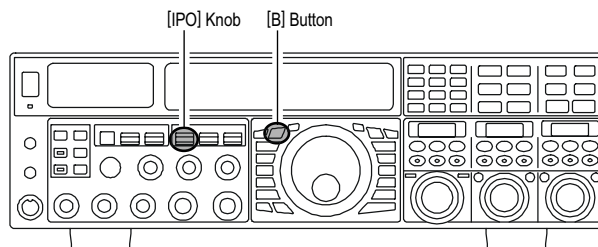
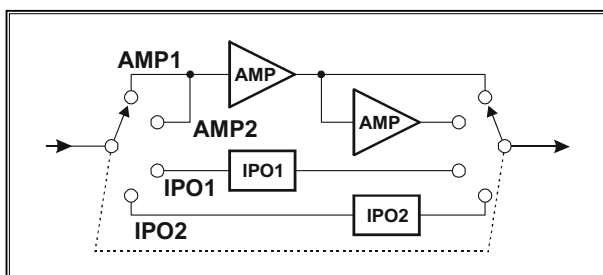
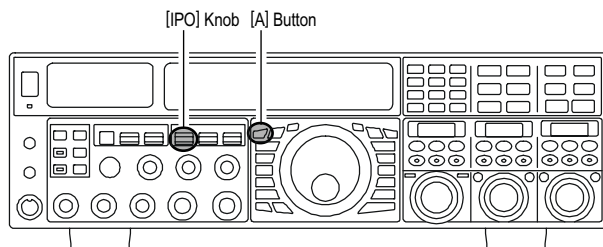

### ADVICE:

On the 10 MHz and lower bands, it generally is not necessary to use any preamplifier at all; selecting the "IPO" position as described above will increase the strong-signal-handling capability of the receiver, and usually result in more pleasant reception due to reduced noise. If you can hear band noise with the preamplifiers disengaged, then a preamplifier is generally not needed.



# CONVENIENCE FEATURES

## ATT

Even with the IPO function on, extremely strong local signals or high noise can still degrade reception. In such situations, you can use the **[ATT]** button to insert 6, 12, or 18-dB of RF attenuation in front of the RF amplifier.

### VFO-A IPO Setup

- Press the **[A]** button to activate VFO-A receiver (The **[A]** button will glow red).
- Move the **[ATT]** knob up or down to set the desired attenuation level of the VFO-A receiver, per the chart below.

OFF: Attenuator is Off  
 -6 dB: The incoming signal power is reduced by 6 dB (Signal voltage reduced by 1/2)  
 -12 dB: The incoming signal power is reduced by 12 dB (Signal voltage reduced to 1/4)  
 -18 dB: The incoming signal power is reduced by 18 dB (Signal voltage reduced to 1/8)

The selected attenuation level will be indicated in the ATT column of the Block Diagram Display.



- To quickly restore full signal strength through the Attenuator circuit, press the **[ATT]** knob in briefly to restore the ATT display to the “OFF”.

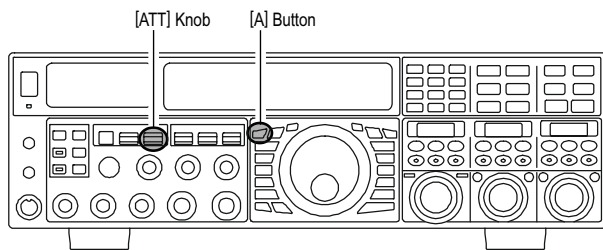

### VFO-B IPO Setup

- Press the **[B]** button to activate VFO-B receiver (The **[B]** button will glow orange).
- Move the **[ATT]** knob up or down to set the desired attenuation level of the VFO-B receiver, per the chart below.

OFF: Attenuator is Off  
 -6 dB: The incoming signal power is reduced by 6 dB (Signal voltage reduced by 1/2)  
 -12 dB: The incoming signal power is reduced by 12 dB (Signal voltage reduced to 1/4)  
 -18 dB: The incoming signal power is reduced by 18 dB (Signal voltage reduced to 1/8)

The selected attenuation level will be indicated in the ATT column of the Block Diagram Display.

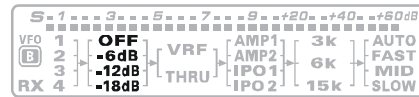

- To quickly restore full signal strength through the Attenuator circuit, press the **[ATT]** knob in briefly to restore the ATT display to the “OFF”.

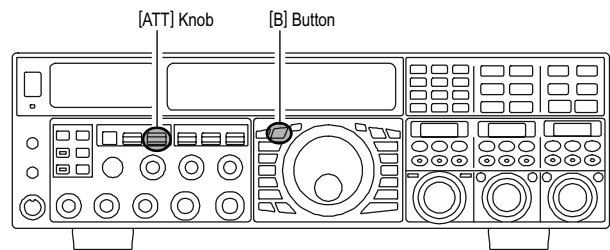

### ADVICE:

If background noise causes the S-meter to deflect on clear frequencies, move the **[ATT]** knob until the S-meter drops to about “S-1”. This setting optimizes the trade-offs between sensitivity, noise, and interference immunity. Also, once you have tuned in a station you want to work, you may want to reduce sensitivity further (or add more attenuation) by moving the **[ATT]** knob to a greater setting. This reduces the strength of all signals (and noise) and can make reception more comfortable, important especially during long QSOs. When looking for weak signals on a quiet band, you will want maximum sensitivity, so the IPO should be disabled and the **[ATT]** knob should be set to “OFF” by pressing the **[ATT]** knob. This situation is typical during quiet times on frequencies above 21 MHz, and when using a small or negative-gain receiving antenna on other bands.

## RF GAIN (SSB/CW/AM MODES)

The RF Gain controls permit manual adjustment of the receiver RF and IF stages gain levels, to account for noise and/or signal strength conditions.

### VFO-A Receiver RF GAIN Adjustment

The (VFO-A)[RF GAIN] knob should, be rotated, initially, to the clockwise position. This is the point of maximum sensitivity, and counter-clockwise rotation will gradually reduce the receiver RF gain.

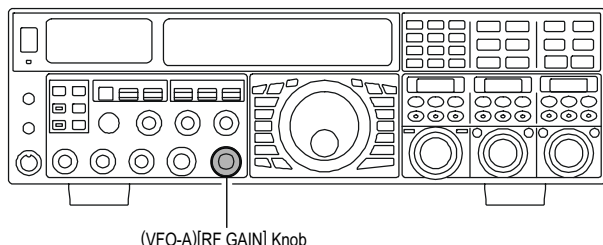

### VFO-B Receiver RF GAIN Adjustment

The VFO-B receiver RF Gain operates identically to the VFO-A receiver RF Gain.

- Press the (VFO-B)[RX] button to engage the Dual Receive operation. The (VFO-B)[RX] button will glow green.
- Always utilize the fully clockwise position of the (VFO-B)[RF GAIN] knob as the starting point for operation.

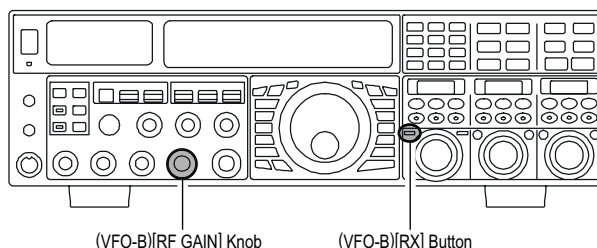

### ADVICE:

- As the [RF GAIN] knob is rotated counterclockwise to reduce the gain, the S-meter reading will rise. This indicates that the AGC voltage being applied to the receiver is increasing (which causes a *reduction* in receiver gain).
- Rotating the [RF GAIN] knob control to the fully counter-clockwise position will essentially disable the receiver, as the gain will be greatly reduced. In this case, as well, the S-meter will appear to be “pegged” against the right edge of the analog S-meter scale.
- The (VFO-B)[RF GAIN] knob operates identically to the (VFO-A)[RF GAIN] knob. The effects of counter-clockwise rotation of the VFO-B receiver RF Gain control may be observed visually on the VFO-B S-meter.

### QUICK POINT:

- Reception can often be optimized by rotating the [RF GAIN] knob slightly counter-clockwise, to the point where the S-meter stationary needles position is just about the same as the receiver noise level. This setting ensures incoming signals will be heard with minimal noise. The S/N (signal to noise) of the receiver will be improved, without so much gain reduction that weak signals cannot be heard.
- The RF GAIN control, along with the IPO and ATT (attenuator) features, all affect the system receiver gain in different ways. As a first step in dealing with high noise or a crowded, high-level signal environment, the IPO generally should be the first feature engaged, if the frequency is low enough to allow the preamplifier to be bypassed. Thereafter, the RF GAIN and ATT (attenuator) features may be employed to provide precise, delicate adjustment of the receiver, and fully optimize performance.

# ADVANCED INTERFERENCE-SUPPRESSION FEATURES: RF FRONT END

The **FTdx5000** includes an unmatched array of RF selectivity-enhancing features. Please study the following material carefully, to understand the many interference tools and techniques completely.

## USING THE VRF (VARIABLE RF FRONT-END FILTER)

The VRF system is a high-performance RF front-end preselector that has a high Q factor and low insertion loss. VRF provides outstanding rejection of out-of-band signals, it can also significantly improve receiver performance when located near other transmitters, such as a contest or DX-pedition station. The **FTdx5000** VRF system affects the 1.8 - 28 MHz amateur bands only.

### VFO-A VRF Setup

- Press the **(VFO-A)[VRF]** button. The button will glow red, and the “**VRF**” icon will appear at the FLT column of the Block Diagram Display. The VRF system will be engaged and centered on the currently operating amateur band. The **(VFO-A)[SELECT]** knob will now function as the VRF adjusting knob.



- You may rotate the **(VFO-A)[SELECT]** knob to change the VRF system tuning, relative to your operating frequency.

#### ADVICE:

- You may observe the relative skew of the VRF system in the **SUB DISPLAY-II** window.
- After moving the passband of the VRF system manually, you may re-center it on the current Amateur band by pressing the **(VFO-A)[CLEAR]** button.
- To switch VRF off, press the **(VFO-A)[VRF]** button until the “**VRF**” icon shows “**THRU**” in the FLT column of the Block Diagram Display; this confirms that the VRF circuit has been removed from the incoming received signal path.

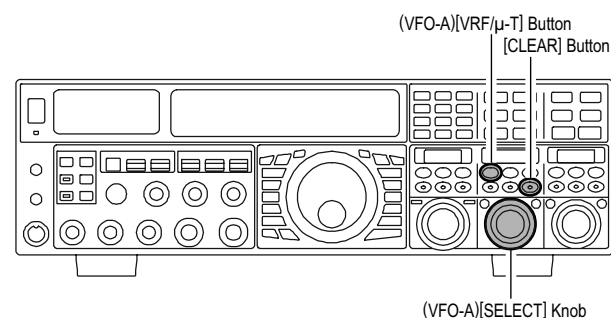

### VFO-B VRF Setup

- Press the **(VFO-B)[RX]** button to engage Dual Receive operation. The button will glow green.
- Press the **(VFO-B)[VRF]** button. The **(VFO-B)[VRF]** button will glow red, and the “**VRF**” icon will appear at the FLT column of the Block Diagram Display. The VRF system will be engaged and centered on the current operating amateur band. The **(VFO-B)[SELECT]** knob will now function as the VRF adjusting knob.

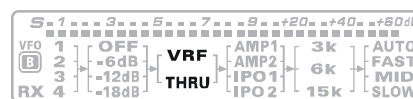

- You may rotate the **(VFO-B)[SELECT]** knob to change the VRF system tuning, relative to your operating frequency.

#### ADVICE:

- You may observe the relative skew of the VRF system in the **SUB DISPLAY-III** window.
- After moving the passband of the VRF system manually, you may re-center it on the current Amateur band by pressing the **(VFO-B)[CLEAR]** button.
- To switch VRF off, press the **(VFO-B)[VRF]** button. The “**VRF**” icon shows “**THRU**” in the FLT column of the Block Diagram Display; this confirms that the VRF circuit has been removed from the incoming received signal path.

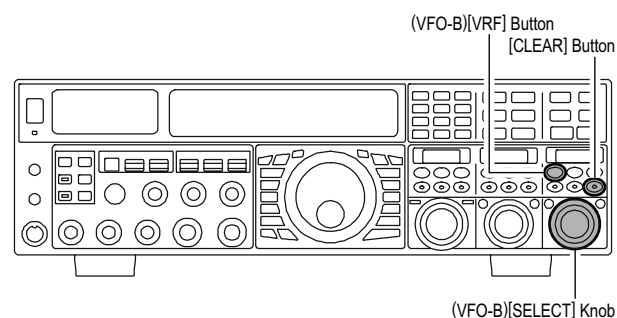



## USING THE VRF (VARIABLE RF FRONT-END FILTER)

### ADVICE:

- ❑ The VRF system tuning is relatively broad, although it is still much narrower than the fixed bandpass filter. You may not hear much difference in the background noise or signal quality when you make minor adjustments. However, if you have receiving problems associated with a very strong signal, rotation of the **[SELECT]** knob may help reduce the strength of the interfering station, allowing improved reception of the desired signal, if receiver overload was degrading reception.
- ❑ The VRF Filter operational status will be memorized independently on each VFO in the VFO stack.
- ❑ You may select the display pattern shown in the **SUB DISPLAY** window from three patterns via Menu item **"019 DISP SELECT"**. See page 122 for details.

### QUICK POINT:

The VRF filter utilizes high-quality coils and capacitors that provide high Q, and yield a passband that is approximately 20% to 30% the width of a traditional, fixed bandpass filter. As a result, significantly more "unwanted" signal rejection is provided. Within each amateur band, the following adjustment steps are provided, if you wish to skew the response in a particular direction to enhance interference rejection even more. The actual "sound" of the signal you are listening to will remain unchanged, however.

AMATEUR BAND	VRF ADJUSTMENT STEPS
1.8 MHz	62 steps
3.5 MHz	62 steps
5 MHz	62 steps
7 MHz	62 steps
10 MHz	30 steps
14 MHz	30 steps
18 MHz	20 steps
21 MHz	20 steps
24.5 MHz	20 steps
28 MHz	20 steps



# ***INTERFERENCE REJECTION (SIGNALS OFF FREQUENCY BY JUST A FEW KHZ)***

---

## **NOTE**

---

---

## CONTOUR CONTROL OPERATION

The Contour Filter system produces a gentle perturbation of the IF filter passband. The different frequency components of the signal can be suppressed or enhanced, thus improving the sound and/or readability of the received signal.

### VFO-A Contour Operation

- ❑ Press the **(VFO-A)[CONT/APF]** button. The button will glow red and the position of the “null” (or “Peak”) of the contour filter will be indicated in the **SUB DISPLAY-II** window. The **(VFO-A)[SELECT]** knob will now function as the contour knob.
- ❑ Rotate the **(VFO-A)[SELECT]** knob to achieve the most pleasing audio reproduction of the incoming signal.
- ❑ Press the **(VFO-A)[CLEAR]** button in briefly, to quickly move the “null” (or “Peak”) position to center.
- ❑ To cancel Contour tuning, press the **(VFO-A)[CONT/APF]** button once more.

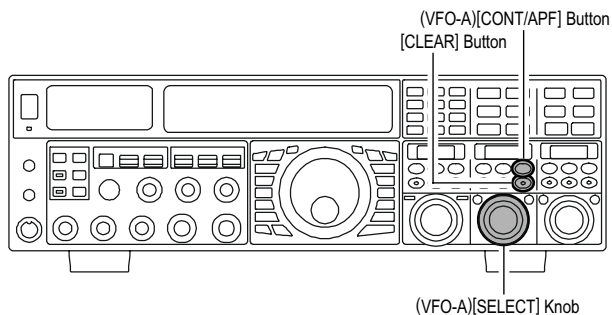

### VFO-B Contour Operation

- ❑ Press the **(VFO-B)[CONT/APF]** button. The button will glow red and the current “null” (or “Peak”) position of the contour filter will be indicated in the **SUB DISPLAY-III** window. The **(VFO-B)[SELECT]** knob will now function as the contour knob.
- ❑ Rotate the **(VFO-B)[SELECT]** knob to achieve the most natural-sounding audio reproduction of the incoming signal.
- ❑ Press the **(VFO-B)[CLEAR]** button in briefly, to quickly move the “null” (or “Peak”) position to center.
- ❑ To cancel Contour tuning, press the **(VFO-A)[CONT/APF]** button once more.

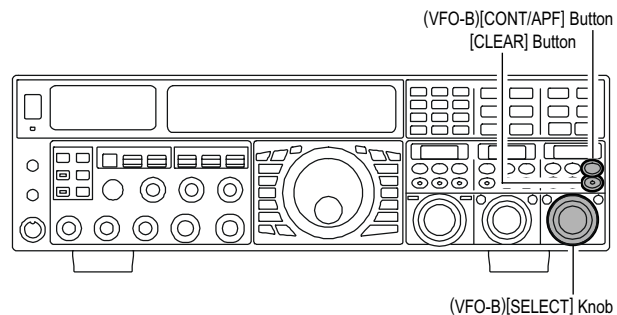

### ADVICE:

- ❑ The contour filter null or peaking level may be adjusted using Menu item “**112 RDSP CNTR LV**”. The factory default null setting is “-15” (dB).
- ❑ The bandwidth over which the contour null or peaking affect is applied may be adjusted using Menu item “**113 RDSP CNTR WI**”. The factory default setting is “10”.
- ❑ You may select the display pattern shown in the **SUB DISPLAY** window from three patterns via Menu item “**019 DISP SELECT**”. See page 122 for details.
- ❑ When the optional **DMU-2000** Data Management Unit is connected, the Audio Scope (on the **DMU-2000** “Oscilloscope” page) is particularly useful when adjusting the Contour controls. You can see the affect of the Contour system on the signal levels, and the position of the null/peak with respect to frequency components of interest. On the Audio Scope, you may visually observe the affect of the Contour Controls while listening to the signal, this will help build your intuition on how best to use Contour tuning in the future.

### QUICK POINT:

When adjusted aggressively, the steep slopes of the DSP filtering can impart an unnatural sound to an incoming signal. Often, a narrow bandwidth is not the key to improved copy. The incoming signal itself may have undesirable or excessive frequency components, especially in the low frequency range around 100-400 Hz. By judicious use of the Contour filter, the “shoulder” of the passband response may be altered, or components removed from within the passband, allowing the desired signal to rise above the background noise and interference in a manner not obtainable with other filtering systems.

## CONTOUR CONTROL OPERATION

Refer to Figure “B”, and notice the initial position of the contour when the [CONT] button is pushed. Observe the “indentation” in the receiver passband where the contour filter is placing a low-Q “notch” (according to the setting of Menu item “112 RDSP CNTR LV”, as described on the previous page). Counter-clockwise rotation of the [SELECT](contour) knob causes the indentation to move toward a lower frequency (to the left) within the passband, while clockwise rotation causes the indentation to move toward a higher frequency (to the right) within the passband. By removing the interference or unwanted frequency components on the incoming signal, it is possible to make the desired signal rise out of the background noise/interference, and significantly enhance intelligibility.

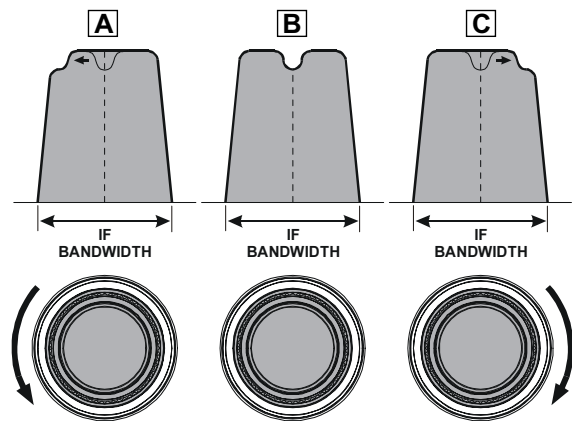

# INTERFERENCE REJECTION (SIGNALS WITHIN 3 KHZ)

## IF SHIFT OPERATION (SSB/CW/RTTY/PKT/AM MODES)

The IF Shift allows you to vary the DSP filter passband higher or lower, (without changing the pitch of the incoming signal) to reduce or eliminate interference. Because the carrier tuning frequency is not varied, there is no need to re-tune the operating frequency when using the IF Shift to eliminating the interference. The total passband tuning range for the IF Shift system is  $\pm 1$  kHz.

### VFO-A IF SHIFT Operation

- ❑ Press the **(VFO-A)[SHIFT]** button. The center position of the IF passband will be indicated in the **SUB DISPLAY-II** window. The **(VFO-A)[SELECT]** knob will now function as the IF SHIFT knob.
- ❑ Rotate the **(VFO-A)[SELECT]** knob to the left or right to reduce the interference.
- ❑ Press the **(VFO-A)[CLEAR]** button in briefly to quickly move the filter passband to center. When the filter passband is set to band center, the **(VFO-A)[SHIFT]** button will glow red.

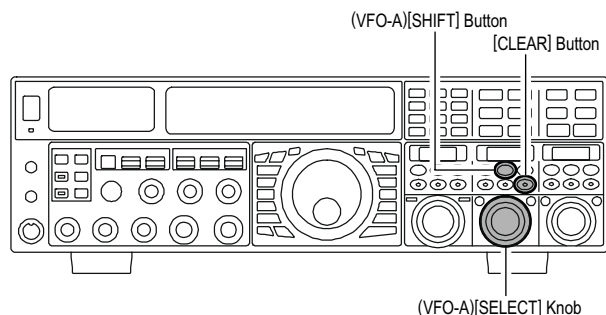

### VFO-B IF SHIFT Operation

- ❑ Press the **(VFO-B)[SHIFT]** button. The center position of the IF passband will be indicated in the **SUB DISPLAY-III** window. The **(VFO-B)[SELECT]** knob will now function as the VFO-B IF SHIFT knob.
- ❑ Rotate the **(VFO-B)[SELECT]** knob to the left or right to reduce the interference.
- ❑ Press the **(VFO-B)[CLEAR]** button in briefly to quickly move the filter passband to center. When the filter passband is set to band center, the **(VFO-B)[SHIFT]** button will glow red.

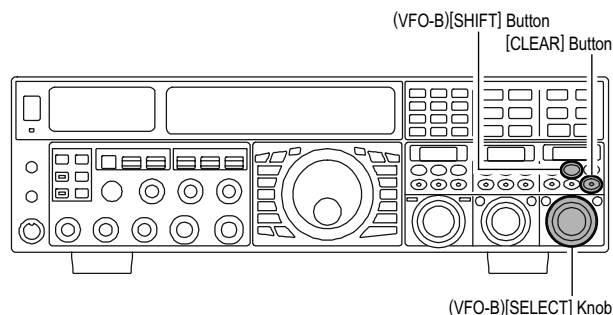

Refer to Figure "A" and notice the depiction of the IF DSP filter as a thick line in the center of the passband, no shift (the **[SHIFT]** button glows red). In Figure "B", an interfering signal has appeared inside the original passband. In Figure "C", you can see the effect of rotating the **[SELECT]**(shift) knob and moving the filter so that the interference is outside of the passband.

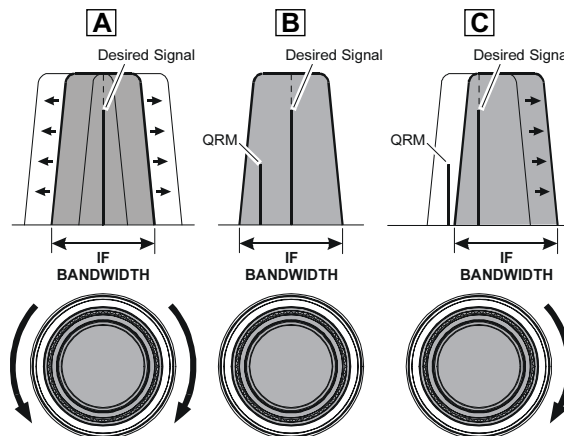

### ADVICE:

You may select the display pattern shown in the **SUB DISPLAY** window from three patterns via Menu item "019 DISP SELECT". See page 122 for details.

## WIDTH (IF DSP BANDWIDTH) TUNING (SSB/CW/RTTY/PKT MODES)

The IF Width tuning system allows you to vary the width of the DSP IF filter passband, to eliminate interference. Moreover, the bandwidth may actually be *expanded* from its default setting, should you wish to enhance incoming signal fidelity when interference on the band is low.

### VFO-A WIDTH Operation

- ❑ Press the (VFO-A)[WIDTH] button. The current bandwidth will appear in the **SUB DISPLAY-II** window. The (VFO-A)[SELECT] knob will now function as the WIDTH knob.
- ❑ Rotate the (VFO-A)[SELECT] knob to the left or right to reduce the interference.
- ❑ Press the (VFO-A)[CLEAR] button in briefly, to set the bandwidth to default. When the bandwidth is set to default, the (VFO-A)[WIDTH] button glows red.

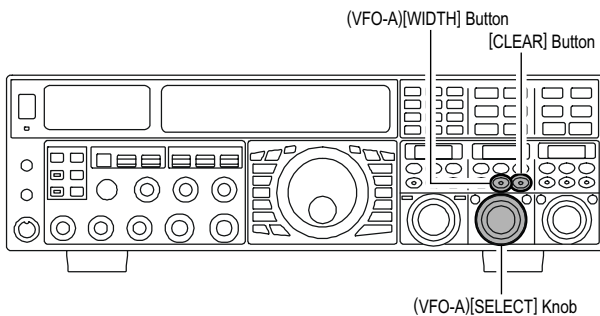

### VFO-B WIDTH Operation

- ❑ Press the (VFO-B)[WIDTH] button. The current bandwidth will appear in the **SUB DISPLAY-III** window. The (VFO-B)[SELECT] knob will now function as the WIDTH knob.
- ❑ Rotate the (VFO-B)[SELECT] knob to the left or right to reduce the interference.
- ❑ Press the (VFO-B)[CLEAR] button in briefly, to set the bandwidth to default. When the bandwidth is set to default, the (VFO-B)[WIDTH] button glows red.

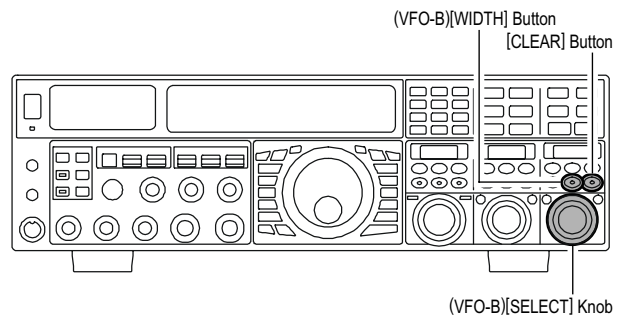

Referring to Figure “B”, you can see the default bandwidth (the [WIDTH] button glows red).

By rotating the [SELECT](width) knob to the left, the bandwidth will narrow (see Figure “A”). Rotation of the [SELECT](width) knob to the right, as depicted in Figure “C,” will widen the bandwidth.

The default bandwidth, and total bandwidth adjustment range, will vary according to the operating mode and the [NAR] button setting:

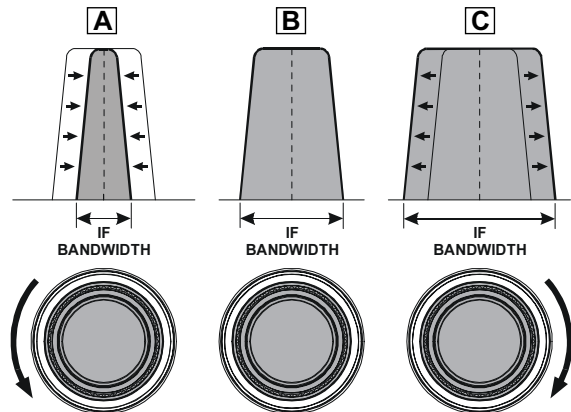

MODE	NAR SWITCH	
	OFF	ON
LSB/USB	1.8 kHz - 4.0 kHz / 16 steps (2.4 kHz*)	200 Hz - 1.8 kHz / 9 steps (1.8 kHz*)
CW	500 Hz - 2.4 kHz / 7 steps (2.4 kHz*)	50 Hz - 500 Hz / 10 steps (500 Hz*)
RTTY(LSB)	500 Hz - 2.4 kHz / 7 steps (500 Hz*)	50 Hz - 500 Hz / 10 steps (300 Hz*)
PKT(LSB/USB)	500 Hz - 2.4 kHz / 7 steps (500 Hz*)	50 Hz - 500 Hz / 10 steps (300 Hz*)

\*: Default (the [WIDTH] button glows red)

#### ADVICE:

You may select the display pattern shown in the **SUB DISPLAY** window from three patterns via Menu item “019 DISP SELECT”. See page 122 for details.

#### NOTE:

When rotating the [SELECT](WIDTH) knob counter-clockwise, the transition between 50 Hz and 25 Hz bandwidth may be accompanied by a “ping” sound, depending on the amount of noise present. This is a normal condition, and you should turn down the volume, when wearing headphones, to minimize the amplitude of this momentary sound.

# INTERFERENCE REJECTION (SIGNALS WITHIN 3 KHZ)

## USING IF SHIFT AND WIDTH TOGETHER (SSB/CW/RTTY/PKT/AM MODES)

The IF Shift and Variable IF Width features, together, form a very effective interference-fighting filter system.

For example, in Figure “A” you can see how interference has appeared both on the high and low sides of the desired signal. By pressing the [WIDTH] button (the button will glow red) and then rotating the [SELECT](width) knob, as shown in Figure “B”, the interference from one side can be eliminated, then press the [SHIFT] button to change the function of the [SELECT] knob to the SHIFT knob (the [SHIFT] button glows red. However, the IF Width adjustment is not changed). Now, by re-positioning the [SELECT](shift) knob (Figure “C”), the interference on the opposite side can be removed, without re-introducing the interference previously eliminated in Figure “B”.

### ADVICE:

The Width and Shift features are the primary tools you should use for best interference reduction. After narrowing the bandwidth (width) and/or adjusting the center of the passband (shift), the Contour control may also yield further signal-enhancement benefits on the net residual bandwidth. Additionally, the IF Notch Filter (see the next section) may be utilized, in conjunction with the three other filter systems, to significant advantage.

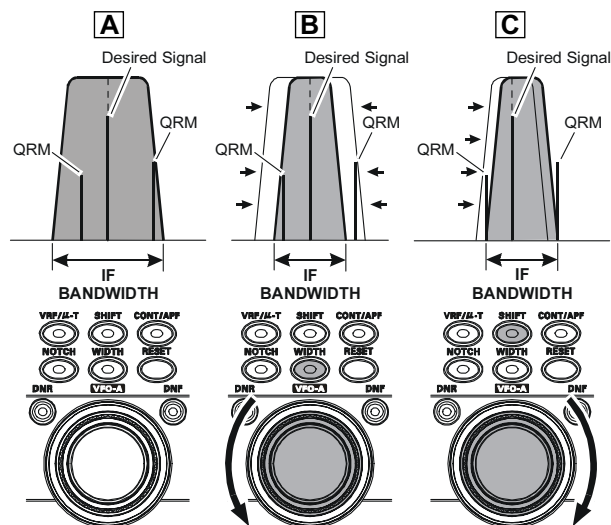



## IF NOTCH FILTER OPERATION (SSB/CW/RTTY/PKT/AM MODES)

The IF Notch filter is a highly effective system that allows you to slice out an interfering beat note or other carrier signal from inside the receiver passband.

### VFO-A IF Notch Operation

- Press the **(VFO-A)[NOTCH]** button. The **(VFO-A)[NOTCH]** button glows red, and the current “null” (or “Peak”) position of the IF notch filter will appear in the **SUB DISPLAY-II** window. The **(VFO-A)[SELECT]** knob will now function as the notch adjustment knob.
- Rotate the **(VFO-A)[SELECT]** knob to adjust the center frequency of the IF notch filter.
- Press the **(VFO-A)[CLEAR]** button to move the “null” position to center.
- To switch the IF notch filter off, press the **(VFO-A)[NOTCH]** button once more.

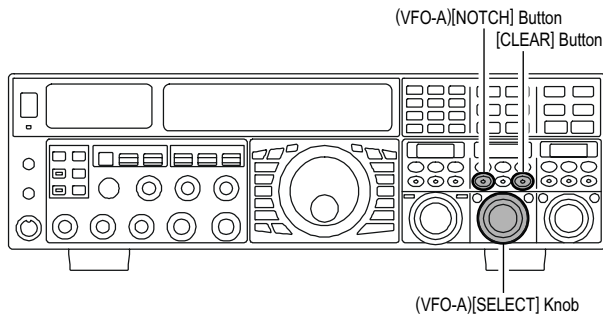

### VFO-B IF Notch Operation

- Press the **(VFO-B)[NOTCH]** button. The **(VFO-B)[NOTCH]** button glows red, and current “null” (or “Peak”) position of the IF notch filter will be indicated in the **SUB DISPLAY-III** window. The **(VFO-B)[SELECT]** knob will now function as the notch adjustment knob.
- Rotate the **(VFO-B)[SELECT]** knob to adjust the center frequency of the IF notch filter.
- Press the **(VFO-B)[CLEAR]** button to move the “null” position to center.
- To switch the IF notch filter off, press the **(VFO-B)[NOTCH]** button once more.

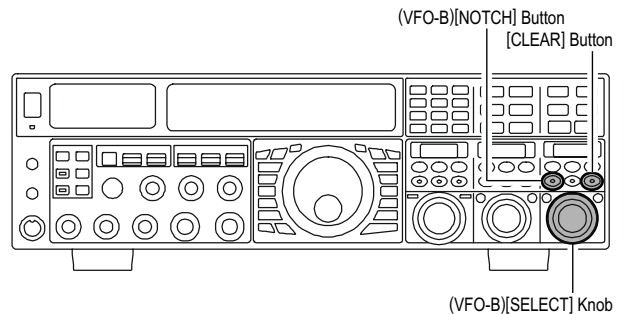

### ADVICE:

- The width of the IF notch null may be adjusted using Menu item “**110 RDSP NOTCH WI**”. Both “Wide” and “Narrow” selections are available, with “Narrow” providing the least disruption of the “desired” signal.
- You may select the display pattern shown in the **SUB DISPLAY** window from three patterns via Menu item “**019 DISP SELECT**”. See page 122 for details.
- When the optional **DMU-2000** Data Management Unit is connected, the effect of the IF notch filter may be observed using the Audio Scope (on the “Oscilloscope” page). The notch will be seen as a “dip” in the noise platform observed. What’s more, the “Waterfall” display may be used to observe the effect of the IF notch filter, which will appear as a white area in the colored background. The tuning rate for the IF notch is somewhat slow while you adjust the **[SELECT](notch)** knob, so the use of the Waterfall display to confirm proper adjustment is highly recommended.

The affect of rotation of the **[SELECT](notch)** knob on the performance of the IF notch filter is depicted in Figure “A”. In Figure “B”, you can see the notching effect of the IF notch filter as you rotate the **[SELECT](notch)** knob to eliminate the incoming interference.

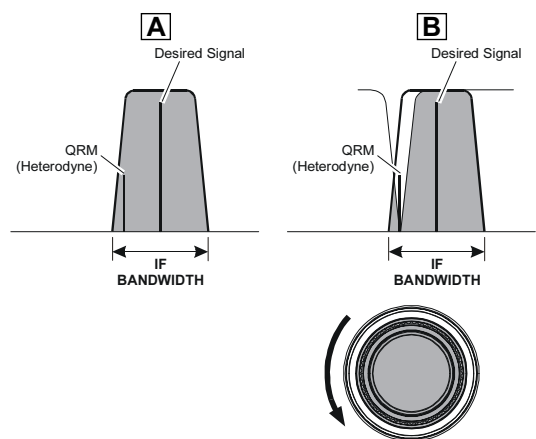

# INTERFERENCE REJECTION (SIGNALS WITHIN 3 KHZ)

## DIGITAL NOISE REDUCTION (DNR) OPERATION

The Digital Noise Reduction (DNR) system is designed to reduce the level of random noise found on the HF and 50 MHz bands. It is especially effective during SSB operation. By rotating the [DNR] knob, any of 15 different noise-reduction algorithms can be selected; each of these algorithms was created for dealing with a different noise profile, and you will want to experiment with the DNR system to find the best setting according to the noise currently being experienced.

### VFO-A DNR Operation

- Press the (VFO-A)[DNR] button. The button will glow red, and the current noise-reduction algorithm will appear in the **SUB DISPLAY-II** window. The (VFO-A)[SELECT] knob will now function as the notch adjustment knob.
- Rotate the (VFO-A)[SELECT] knob to select the setting that most effectively reduces the noise level.
- Press the (VFO-A)[CLEAR] button to set the noise-reduction algorithm to default.
- To switch the DNR system off, press the (VFO-A)[NOTCH] button once more.

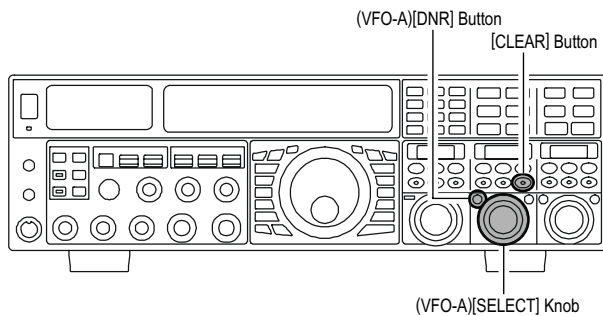

### VFO-B DNR Operation

- Press the (VFO-B)[DNR] button. The (VFO-B)[DNR] button glows red, and the current noise-reduction algorithm will appear in the **SUB DISPLAY-II** window. The (VFO-B)[SELECT] knob will now function as the notch adjustment knob.
- Rotate the (VFO-B)[SELECT] knob to select the setting that most effectively reduces the noise level.
- Press the (VFO-B)[CLEAR] button to set the noise-reduction algorithm to default.
- To switch the DNR system off, press the (VFO-B)[NOTCH] button once more.

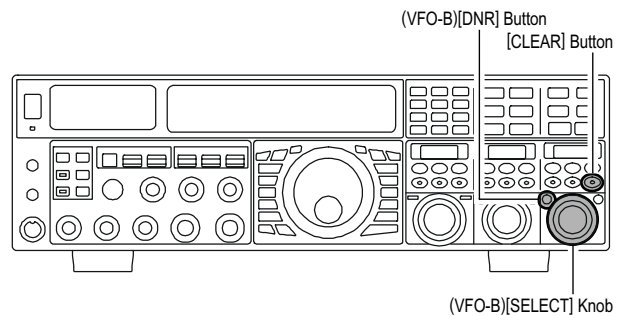

#### ADVICE:

You may select the display pattern shown in the **SUB DISPLAY** window from three patterns via Menu item "019 DISP SELECT". See page 122 for details.

## DIGITAL NOTCH FILTER (DNF) OPERATION

The Digital Notch Filter (DNF) is an effective beat-canceling filter that can null out a number of interfering beat notes inside the receiver passband. Because this is an Auto-Notch feature, there is no adjustment knob associated with this filter.

#### ADVICE:

If a very strong interfering carrier is encountered, we recommend you first use the IF notch filter, as it is the most effective notching tool in the receiver section.

### VFO-A DNF Operation

- Press the (VFO-A)[DNF] button. The button glows red, confirming that the DNF system is engaged.
- To switch the DNF system off, press the (VFO-A)[DNF] button once more.

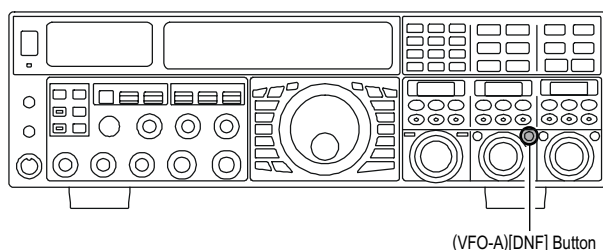

### VFO-B DNF Operation

- Press the (VFO-B)[DNF] button. The button glows red, confirming that the DNF system is engaged.
- To switch the DNF system off, press the (VFO-B)[DNF] button once more.

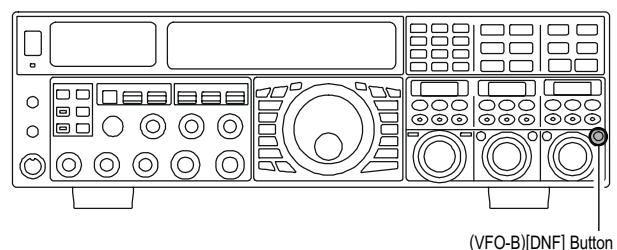

## NARROW (NAR) ONE-TOUCH IF FILTER SELECTION

### VFO-A “One-Touch Narrow” Operation

- Press the [A] button to activate VFO-A (the button will glow red).
- Pressing the [NAR] button engages a narrow IF DSP filter, specific to the mode in use, and not related to the setting of the [WIDTH] knob.
- Pressing the [NAR] button once more returns the bandwidth control to the Width/Shift system. The factory default of the bandwidth is as shown below.

#### ADVICE:

When the narrow bandwidth is selected, the “**NAR**” icon will appear in the display, and the bandwidth depiction in the **SUB DISPLAY-II** window will be narrowed (if **SUB DISPLAY-II** window is showing the bandwidth).

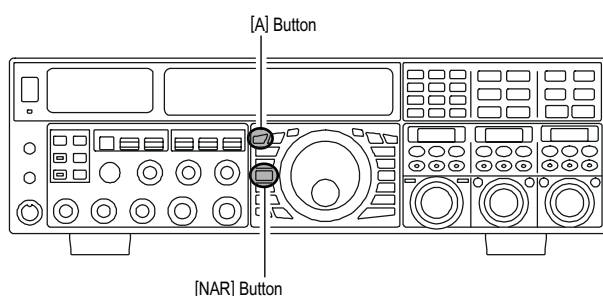

### VFO-B “One-Touch Narrow” Operation

- Press the [B] button (the button glows orange).
- Pressing the [NAR] button engages a narrow IF DSP filter, specific to the mode in use, and not related to the setting of the [WIDTH] knob.
- Pressing the [NAR] button once more returns bandwidth control to the Width/Shift system. The factory default settings of the bandwidth are as shown in the table below.

#### ADVICE:

When the narrow bandwidth is selected, the “**NAR**” icon will appear in the display, and the bandwidth on the **SUB DISPLAY-III** will be reduced, (if the **SUB DISPLAY-III** window indicates the bandwidth).

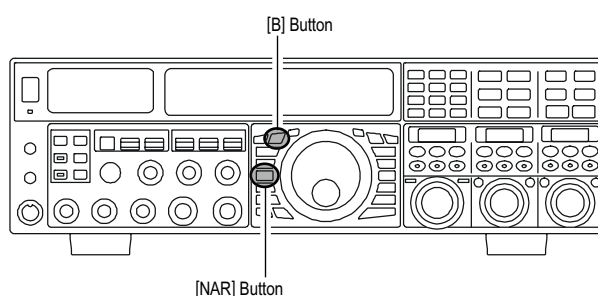

MODE	NAR BUTTON	
	OFF	ON
LSB/USB	2.4 kHz (1.8 kHz - 4.0 kHz / 16 steps*)	1.8 kHz (200 Hz - 1.8 kHz / 9 steps*)
CW	2.4 kHz (500 Hz - 2.4 kHz / 7 steps*)	500 Hz (50 Hz - 500 Hz / 10 steps*)
RTTY(LSB)	500 Hz (500 Hz - 2.4 kHz / 7 steps*)	300 Hz (50 Hz - 500 Hz / 10 steps*)
PKT(LSB/USB)	500 Hz (500 Hz - 2.4 kHz / 7 steps*)	300 Hz (50 Hz - 500 Hz / 10 steps*)
PKT(FM)	25 kHz (±5.0 kHz Deviation)	12.5 kHz (±2.5 kHz Deviation)
AM	9 kHz	6 kHz
FM	25 kHz (±5.0 kHz Deviation)	12.5 kHz (±2.5 kHz Deviation)

#### ADVICE:

You may select the display pattern shown in the **SUB DISPLAY** window from three patterns via Menu item “**019 DISP SELECT**”. See page 122 for details.

## IF NOISE BLANKER (NB) OPERATION

The **FTdx5000** includes an effective IF Noise Blanker, which can significantly reduce pulse noise like that caused by automotive ignition systems.

### VFO-A NB Operation

- Press the **[A]** button (the button glows red), if needed to enable VFO-A.
- Press the **[NB]** button briefly to reduce *short duration pulse noise* such as from switching transients, automobile ignitions and power lines. The “**NB**” icon will appear in the display to confirm that the Narrow-NB is operating.
- Press the **[NB]** button again to reduce *longer-duration man-made pulse noise*. The “**NB W**” icon will blink for three seconds, and thereafter will appear continuously, to confirm that the Wide-NB is operating.
- Rotate the **(VFO-A)[NB]** knob to the point where the offending noise is best reduced or eliminated.
- To end Noise Blanker operation, press the **[NB]** button once more. The “**NB**” (or “**NB W**”) icon will turn off, confirming that the Noise Blanker is no longer in operation.

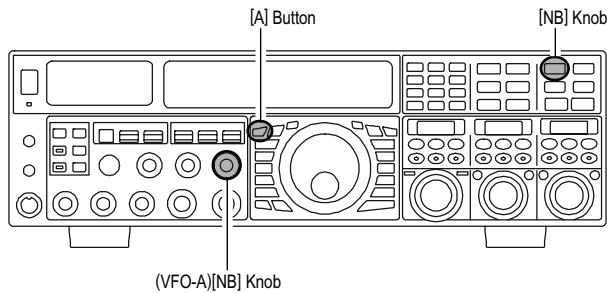

### VFO-B NB Operation

- Press the **[B]** button (the **[B]** button glows orange).
- Press the **[NB]** button briefly to reduce *short duration pulse noise* such as from switching transients, automobile ignitions and power lines. The “**NB**” icon will appear in the display to confirm that the Narrow-NB is operating.
- Press the **[NB]** button again to reduce *longer-duration man-made pulse noise*. The “**NB W**” icon will blink for three seconds, and thereafter will appear continuously, to confirm that the Wide-NB is operating.
- Rotate the **(VFO-B)[NB]** knob to the point where the offending noise is best reduced or eliminated.
- To end Noise Blanker operation, press the **[NB]** button once more. The “**NB**” (or “**NB W**”) icon will turn off, confirming that the Noise Blanker is no longer in operation.

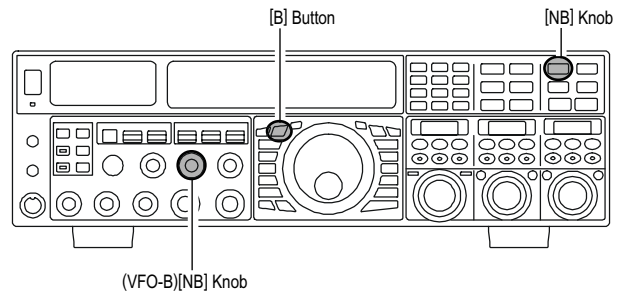

# TOOLS FOR COMFORTABLE AND EFFECTIVE RECEPTION

## AGC (AUTOMATIC GAIN CONTROL)

The AGC system is designed to help compensate for fading and other propagation effects, with characteristics that can be of particular value on each operating mode. The basic objective of AGC is to maintain a constant audio output level once a certain minimum threshold of signal strength is achieved.

### VFO-A AGC Selection

- Press the [A] button briefly to enable VFO-A (the LED in the [A] button will glow red).
- Move the [AGC] knob up or down to set the desired receiver recovery time constant of the VFO-A receiver. The selected recovery time will be indicated in the AGC column of the Block Diagram Display.
- Hold the [AGC] knob up or down for two seconds to disable the AGC (for testing or weak-signal reception).
- For most operations, we recommend using the “AUTO” mode by pressing the [AGC] knob in briefly, or moving the [AGC] knob to set the ATT display to the “AUTO” position.

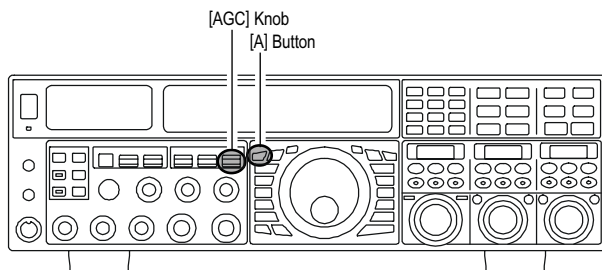

### VFO-B AGC Selection

- Press the [B] button (the [B] button glows orange).
- Move the [AGC] knob up and down to set the desired receiver recovery time constant of the VFO-B receiver. The selected recovery time will be indicated in the AGC column of the Block Diagram Display.
- Hold the [AGC] knob up or down for two seconds to disable the AGC (for testing or weak-signal reception).
- For most operations, we recommend using the “AUTO” mode by pressing the [AGC] knob in briefly, or moving the [AGC] knob to set the ATT display to the “AUTO” position.

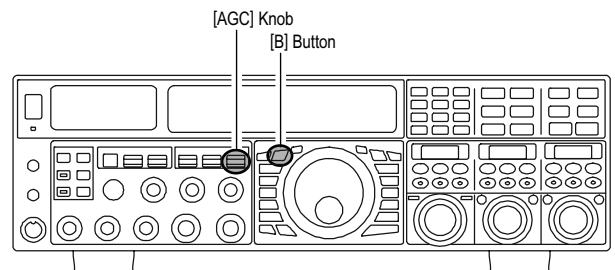

### NOTE:

- When the AGC receiver recovery time is set to “OFF”, the S-meter will no longer deflect. Additionally, you will likely encounter distortion on stronger signals, as the IF amplifiers and the following stages are probably being overloaded.
- Normally, the AGC “AUTO” selection is satisfactory for most situations, but in the event of operation on a crowded band where you wish to receive a weak signal, you may change the setting (to “FAST”, for example). The AGC “AUTO” mode selections are:

OPERATING MODE	AUTO AGC SELECTION
LSB	SLOW
USB	SLOW
CW	FAST
AM	FAST
FM	FAST
RTTY	SLOW
PKT (FM)	FAST
PKT (LSB)	SLOW

### ADVICE:

When a received signal becomes degraded due to pulse type noise, you may improve signal readability by setting Menu items “002 AGC FST HLD”, “004 AGC MID HLD”, and “006 AGC SLW HLD” to “0 msec”.

### QUICK POINT

Several aspects of AGC performance may be configured via the Menu. However, because AGC can have such a profound impact on overall receiver performance, we generally do not recommend any changes to the AGC Menu selections until you are thoroughly familiar with the performance of the FTdx5000.

### TERMINOLOGY:

Automatic Gain Control, or AGC, is a circuit that senses the incoming signal strength, and then limits the gains of the RF and IF stages, to maintain the output audio volume at a more-or-less constant level. AGC also protects the RF, IF, Audio, and DSP stages from overload, by limiting the signal strength applied to circuits, regardless of the input signal level.

## AGC (AUTOMATIC GAIN CONTROL)

### SLOPED AGC Operation

In traditional AGC systems, the audio output from the transceiver becomes essentially constant, once the threshold for AGC action is reached (usually several dozen dB above the no-signal noise floor). The **FTdx5000**, however, includes an innovative Sloped AGC system on the VFO-A receiver that allows the audio volume to rise and fall slightly according to signal strength. Although the rise/fall slope is not dramatic, it is sufficient to allow you to use your ear to discern and separate signals according to signal strength, not just audio frequency.

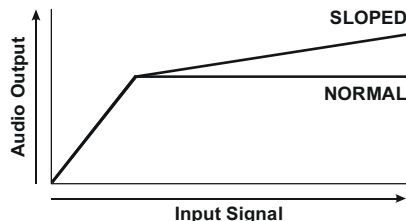

#### Using Sloped AGC

1. Press the **[MENU]** button briefly to enter the Menu mode.
2. Use the **(VFO-A)[SELECT]** knob to select Menu item “**107 ROUT AGC SLP**”.
3. Rotate the **(VFO-B)[SELECT]** knob to change the setting to “**SLOPE**”.
4. Press and hold in the **[MENU]** button for two seconds to save the new setting and exit to normal operation. You will now be using the Sloped AGC system.

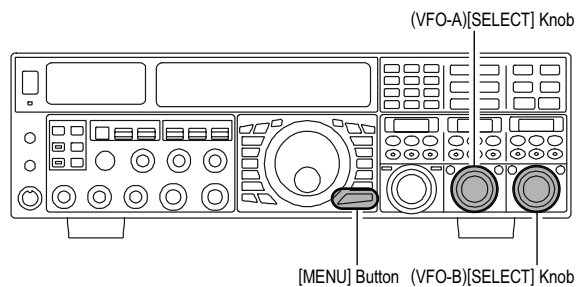



# TOOLS FOR COMFORTABLE AND EFFECTIVE RECEPTION

## MUTE FEATURE (VFO-A BAND)

There may be occasions during Dual Receive operation when you want to silence the VFO-A receiver temporarily, to concentrate on the signal being received on the VFO-B receiver. The Mute feature makes this simple to accomplish.

Press the **(VFO-A)[RX]** button briefly, located to the upper left of the Main Tuning Dial knob. The VFO-A receiver will be silenced, and the green LED in the **(VFO-A)[RX]** button will blink.

To restore reception on the VFO-A receiver, just press the blinking **(VFO-A)[RX]** button once more.

### ADVICE:

If you press the **[POWER]** switch briefly while the transceiver is turned on, the transceiver audio will be muted for three seconds.

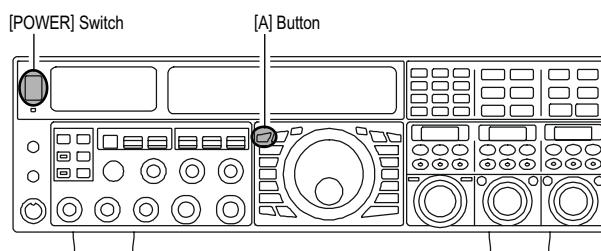

## ADJUSTABLE RECEIVER AUDIO FILTER

The **FTDX5000** includes a adjustable receiver audio filter, that provides precise, independent control of the low- and upper-ranges.

1. Press the **[MENU]** button briefly, to enter the Menu mode.
2. Rotate the **(VFO-A)[SELECT]** knob to find Menu items "047" through "050"; these parameters apply to the adjustment of the receiver audio filter in the AM mode, Menu items "053" through "056" apply to the adjustment of the RX audio filter in the CW mode, Menu items "075" through "078" apply to the adjustment of the RX audio filter in the FM mode, Menu items "089" through "092" apply to the adjustment of the RX audio filter in the RTTY mode, and Menu items "099" through "102" apply to the adjustment of the RX audio filter in the SSB mode.

3. Rotate the **(VFO-B)[SELECT]** knob to perform adjustments to a particular Menu item.

You may confirm the change of the sound quality from the speaker or headphones.

4. When you have completed all adjustments, press and hold in the **[MENU]** button for two seconds to save the new settings and exit to normal operation. If you only press the **[MENU]** button momentarily to exit, any changes you performed will not be stored.

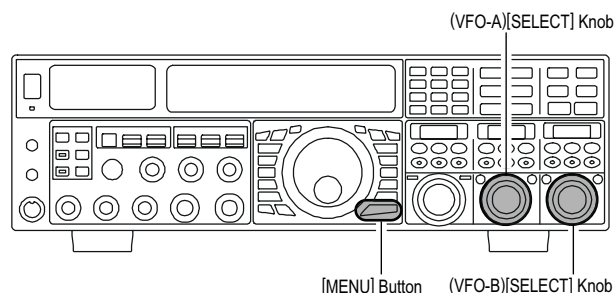

AM	047 A3E LCUT FRQ	OFF / 100 (Hz) ~ 1000 (Hz)
	048 A3E LCUT SLP	6dB/oct or 18dB/oct
	049 A3E HCUT FRQ	700 (Hz) ~ 4000 (Hz) / OFF
	050 A3E HCUT SLP	6dB/oct or 18dB/oct
CW	053 A1A LCUT FRQ	OFF / 100 (Hz) ~ 1000 (Hz)
	054 A1A LCUT SLP	6dB/oct or 18dB/oct
	055 A1A HCUT FRQ	700 (Hz) ~ 4000 (Hz) / OFF
	056 A1A HCUT SLP	6dB/oct or 18dB/oct
FM	075 F3E LCUT FRQ	OFF / 100 (Hz) ~ 1000 (Hz)
	076 F3E LCUT SLP	6dB/oct or 18dB/oct
	077 F3E HCUT FRQ	700 (Hz) ~ 4000 (Hz) / OFF
	078 F3E HCUT SLP	6dB/oct or 18dB/oct
RTTY	089 RTTY LCUT FRQ	OFF / 100 (Hz) ~ 1000 (Hz)
	090 RTTY LCUT SLP	6dB/oct or 18dB/oct
	091 RTTY HCUT FRQ	700 (Hz) ~ 4000 (Hz) / OFF
	092 RTTY HCUT SLP	6dB/oct or 18dB/oct
SSB	099 A3J LCUT FRQ	OFF / 100 (Hz) ~ 1000 (Hz)
	100 A3J LCUT SLP	6dB/oct or 18dB/oct
	101 A3J HCUT FRQ	700 (Hz) ~ 4000 (Hz) / OFF
	102 A3J HCUT SLP	6dB/oct or 18dB/oct

# SSB/AM MODE TRANSMISSION

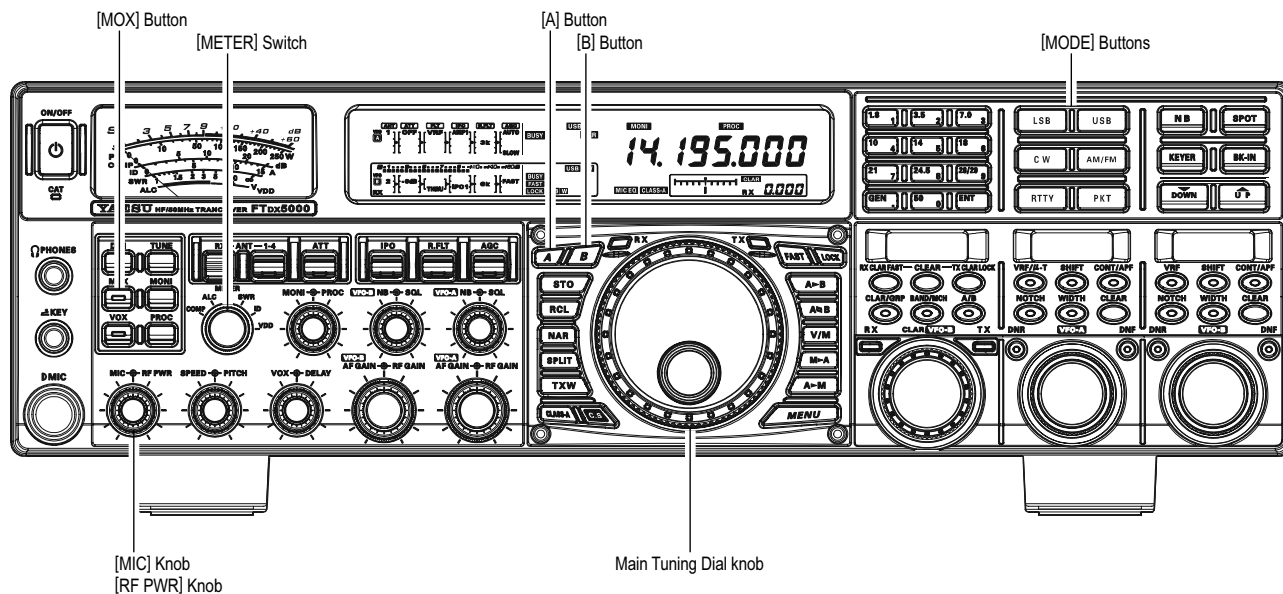

1. The operating mode is selected using the **[MODE]** buttons. The VFO (A or B) to which the selection is applied is selected by the **[A]** or **[B]** button located to the upper left of the Main Tuning Dial knob. Usually, the **[A]** button glows red, signifying that VFO-A is being adjusted. Similarly, pressing the **[B]** button will cause the **[B]** button to glow orange, signifying VFO-B adjustment. Press the **[A]** or **[B]** button to select the desired VFO. Then press the **[LSB]** or **[USB]** button briefly to select one of the SSB modes. For AM operation, press the **[AM/FM]** button repeatedly until the “**AM**” icon appears in the display.

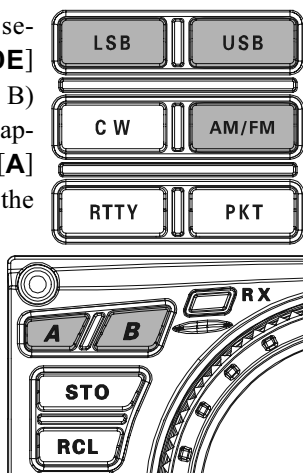

### QUICK POINT:

By convention, LSB is used in the 7 MHz and lower Amateur bands for SSB communication, and USB is used on the 14 MHz and higher bands (the 10 MHz band is used for CW and data modes only).

2. Rotate the Main Tuning Dial knob to adjust the operating frequency. Alternatively, you may use the **[UP]/[DWN]** scanning buttons on the **MH-31B8** Hand Microphone to sweep up or down the current band.
3. Press the microphone's **PTT** (Push To Talk) switch to begin transmission; speak into the microphone in a normal voice level.

### ADVICE:

- The “**TX**” indicator will light up in the frequency display area, confirming that transmission is in progress.
- When transmitting in the AM mode, rotate the **[RF PWR]** knob to set a maximum (carrier) power output of 50 Watts.

4. In the SSB mode, adjust the microphone amplifier gain to match the microphone and your voice level. set the **[METER]** switch to the “**ALC**” position and close the **PTT** switch. Speak into the microphone in a normal voice level, and adjust the **[MIC]** (gain) knob so that the ALC voltage stays within the blue ALC zone of the meter (up to 2/3 of full scale deflection) on voice peaks.

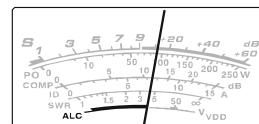
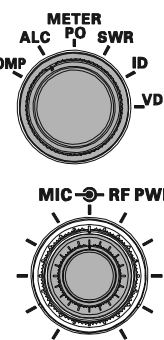

### ADVICE:

- The microphone gain of the AM mode has been programmed at the factory to a level that should be satisfactory for most situations. However, using Menu item “**051 A3E MIC GAIN**”, you may set a different fixed value, or choose the “**MCVR**” option, which then lets you use the front panel **[MIC]** knob to set the microphone gain in the AM mode. In this case, the **[MIC]** knob should not be advanced to the point where the ALC meter deflects. In many cases, the same setting used on SSB will be satisfactory.
  - The relative Microphone Gain level will show for 3 seconds in the lower right corner of the Main Display whenever the inner **[MIC]** knob is turned. Alternately, the 3-second display feature may be changed to show in the **SUB DISPLAY-III** window via Menu item “**018 DISP INDI**”. Additionally, you may disable the 3-second display feature via Menu item “**017 DISP LVL IND**” See page 122 for details.
5. Release the **PTT** switch at the end of your transmission. The transceiver will return to the receive mode.



# SSB/AM MODE TRANSMISSION

## ADVICE:

- ❑ ALC meter deflection may be caused by excessive drive power, and also by reflected power detected in the antenna system. If the impedance presented to the transceiver is other than 50 Ohms, the ALC meter action observed may not be related to the proper setting of the **[MIC]** (gain) knob. Therefore, we recommend that you make **[MIC]** gain adjustments into a dummy load or an antenna system presenting an impedance very close to 50 Ohms.

- ❑ Rotate the **[RF PWR]** knob to set the desired power output. Clockwise rotation of the **[RF PWR]** knob will increase the power. The adjustment range is between 10 Watts and 200 Watts, and you should always use the minimum power necessary for maintaining reliable communications.

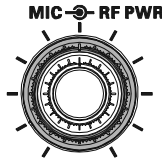

The RF Power Output will show for 3 seconds in the lower right corner of the Main Display whenever the outer **[RF PWR]** knob is turned.

Alternately, the 3-second display feature may be changed to show in the **SUB DISPLAY-III** window via Menu item "**018 DISP INDI**". Additionally, you may disable the 3-second display feature via Menu item "**017 DISP LVL IND**". See page 122 for details.

- ❑ The analog PO meter indicates the average power output level. SSB transmit average talk power is normally 10% to 50% of the peak power output. Voice characteristics, microphone qualities, parametric equalizer and compression settings affect actual talk power output.
- ❑ When performing transmitter tests for setup of the **[MIC]** or **[RF PWR]** knobs, be sure to monitor the frequency before transmitting, to avoid interference to others who may already be using the frequency.
- ❑ Four techniques for initiating Transmit/Receive control are provided on the **FTDx5000**. You may choose the technique(s) that best suit your operating needs:
  - Pressing the microphone **PTT** switch will engage the transmitter.
  - The rear panel **PTT** jack may be connected to a foot switch or other manual switching device in order to engage the transmitter.
  - Pressing the front panel **[MOX]** button will lock the transmitter on. Press the **[MOX]** button again to return to receive.
  - The VOX (Voice Operated Xmit) circuit will engage the transmitter automatically when you speak into the microphone. For VOX operation details, see page 81.

# USING THE AUTOMATIC ANTENNA TUNER

The Automatic Antenna Tuner (“ATU”) built into each **FTDx5000** is crafted to ensure a 50-Ohm load for the final amplifier stage of the transmitter. We recommend the ATU be used whenever you operate the **FTDx5000**.

## ADVICE:

- ❑ The ATU of the **FTDx5000**, being located inside the station, only adjusts the impedance presented to the transmitter at the station end of your coaxial cable feedline. It does not “tune” the SWR at the antenna feedpoint itself. When designing and building your antenna system, we recommend that every effort be made to ensure a low SWR at the antenna feedpoint.
- ❑ The ATU of the **FTDx5000** includes 100 memories for tuning data. Eleven of these memories are allocated, one per Amateur band, so that each band has at least one setting preset for use on that band. The remaining 89 memories are reserved for the 89 most-recent tuning points, allowing quick frequency change without the need to retune the ATU.
- ❑ The ATU in the **FTDx5000** is designed to match impedances within the range of 16.5 Ohms to 150 Ohms, corresponding to an SWR of 3:1 or less on the HF amateur bands (6 meter amateur band: 25 Ohms to 100 Ohms, corresponding to an SWR of 2:1 or less). Accordingly, simple non-resonant whip antennas, along with random-length wires and the “G5RV” antenna (on most bands) may not be within the impedance matching range of the ATU.

---

## ATU OPERATION

---

1. Rotate the [RF PWR] knob fully clockwise (to the right).
2. Use the Main Tuning Dial knob to set the radio to the desired operating frequency within the Amateur band.
3. Press the [TUNE] button briefly to place the ATU in the transmit line (no adjustment/tuning will occur yet). The “**TUNER**” icon will appear in the display.

### QUICK POINT:

The brief press of the [TUNE] button will turn the tuner on, and the microprocessor will automatically select the tuning point closest to the current operating frequency.

4. Press and hold in the [TUNE] button for two seconds to begin automatic tuning. The transmitter will be engaged, and the “**TUNER**” icon will blink while tuning is in progress. When the optimum tuning point has been reached, the radio will return to receive, and the “**TUNER**” icon will again glow steadily (instead of blinking).
5. While tuning around the band using the Main Tuning Dial knob, you will observe that the “**TUNER**” icon blinks momentarily every 10 kHz. This momentary blinking indicates that a new tuning window has been entered. If you want to save tuning data associated with each 10 kHz window, repeat step 4 (above) for each of the windows. On bands like 1.8 MHz where the impedance may change rapidly, the storage of a number of tuning points is recommended.
6. To disconnect the ATU from the transmit line, press the [TUNE] button briefly. The “**TUNER**” icon will turn off, confirming that the ATU has been turned off. In the “Off” mode, the transceiver will be directly connected to the coaxial cable connected to your antenna, and it will operate based on whatever impedance is present at the station end of the coax.

[TUNE] Button

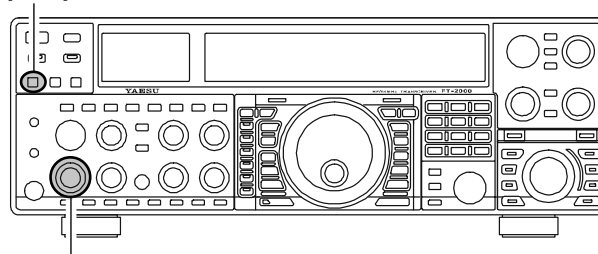

[RF PWR] Knob

## ADVICE:

The ATU circuit is located between the final amplifier and the rear-panel antenna jack; reception is not affected by the ATU.

## QUICK POINT:

- ❑ As shipped from the factory, only one ATU alignment point is saved on each Amateur band. This was memorized during the final alignment and performance verification stages on the production line.
- ❑ The momentary flickering of the “**TUNER**” icon occurs whenever you cross over into a new 10 kHz ATU memory window.

## NOTE:

Please check the operating frequency before beginning the tuning process, to be sure you are not interfering with others who may already be using the frequency.

## TERMINOLOGY:

**Antenna Tuner Memories:** The microprocessor of the ATU makes a note of the positions of the tuning capacitors and the selected inductors, and stores the data for each 10 kHz window in which tuning has occurred. This eliminates the need to re-tune every time you return to a frequency on which you already have completed the tuning process.

# USING THE AUTOMATIC ANTENNA TUNER

## ABOUT ATU OPERATION

Figure 1 depicts a situation where normal tuning of the ATU has been successfully completed, and the tuning data has been stored in the ATU memory. The antenna system as seen by the transmitter is shown.

In Figure 2, the operator has changed frequency, and the “**HI-SWR**” icon is shown. The operator presses and holds in the [TUNE] button for two seconds to begin impedance matching using the ATU.

If a high SWR condition exists (above 3:1), corrective action must be taken in the antenna system to bring the impedance closer to 50 Ohms. The ATU will refuse to memorize settings on frequencies where the SWR exceeds 3:1. The high SWR may indicate a mechanical failure in the antenna or feed system, and such failures can lead to the generation of spurious signals causing TVI, etc.

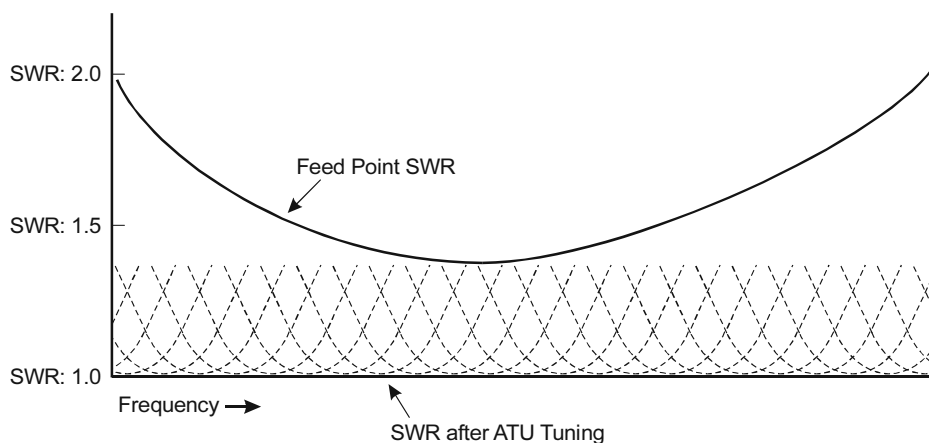

**FIGURE 1**

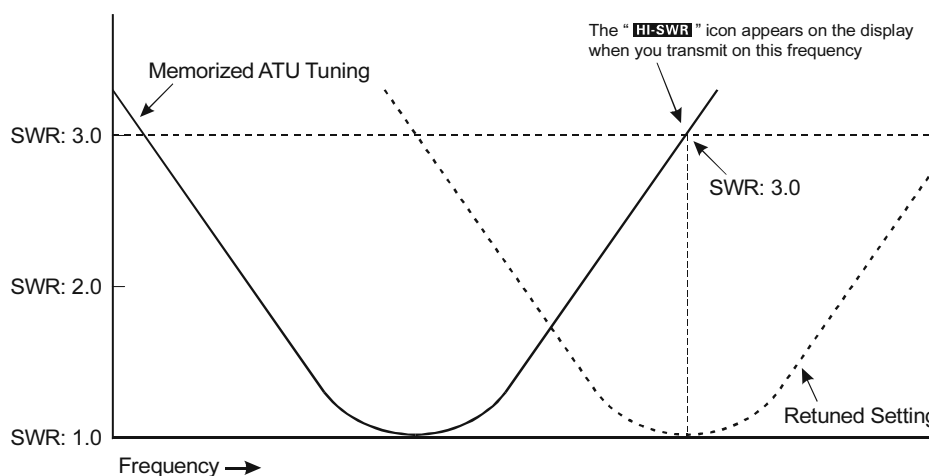

**FIGURE 2**

### About ATU Memories

#### SWR (Post-tuning) Less than 1.5:1

The tuning settings are committed to the ATU memory.

#### SWR (Post-tuning) Greater than 1.5:1

Tuning data will not be retained in memory. If you return to the same frequency, the tuning process must be repeated.

#### SWR (Post-tuning) Greater than 3:1

The “**HI-SWR**” icon will light up, and tuning settings, if achieved, will not be memorized. Please investigate and resolve the high SWR condition before attempting further operation using this antenna.