



TEST REPORT PERTAINING TO:

Equipment Under Test	Model Number(s)
S-Band Satellite Modem	ICO MCAP User Equipment

CONFIGURATION

Satellite Modem operating in the S-band
connected to a Hughes Network Systems antenna with four RF cables

MEASUREMENTS PERFORMED IN ACCORDANCE WITH THE FOLLOWING STANDARD (S)

Regulatory Standard(s)

FCC CFR 47, PART 15 SUBPART B CLASS B



Certificate Number: 1111.01

PREPARED FOR:

Hughes Network Systems
9605 Scranton Road, Suite 500
San Diego, California 92121
Contact(s): Mr. Dave Couchman

PREPARED BY:

Aegis Labs, Inc.
8 Rancho Circle
Lake Forest, CA 92630
Agent(s): Mr. Rick Candelas
Mr. Johnny Candelas



Test Report #: HUGNT-080302F

Test Report Revision: NONE

	REPORT BODY	APPENDICES				TOTAL PAGES
		A	B	C	D	
PAGES	12	3	3	1	6	25

The contents of this report shall not be reproduced except in full, without the written approval of Aegis Labs, Inc.
The Hughes Network Systems logo is used for identification purposes only and is a registered trademark of Hughes Network Systems



TABLE OF CONTENTS

SECTION	TITLE	PAGE
	COVER SHEET.....	01
	TABLE OF CONTENTS.....	02
1.0	REGULATORY COMPLIANCE GUIDELINES.....	03
1.1	Guidelines For Testing To Emissions Standards.....	03
2.0	SUMMARY OF REGULATORY LIMITS.....	04
3.0	ADMINISTRATIVE DATA AND TEST DESCRIPTION.....	05
4.0	DESCRIPTION OF EUT CONFIGURATION.....	06
4.1	Arrangement and Location of EUT and Host Equipment.....	06
4.2	EUT Description and Configuration.....	07
4.2.1	Product Description.....	07
4.2.2	EUT Configuration.....	07
4.3	List of EUT Sub-Assemblies and Host Equipment.....	08
4.4	Signal Line Cable Description And Connection Location.....	09
4.5	EMC Test Hardware and Software Measurement Equipment.....	10
5.0	CONDITIONS DURING EMISSIONS MEASUREMENTS.....	11
5.1	General.....	11
5.2	Conducted Emissions Test Setup.....	11
5.3	Radiated Emissions Test Setup.....	12

APPENDICES

A	Test Data
B	Photographs – Test Setups
C	Modifications Required
D	Accreditation Certificate



1.0 REGULATORY COMPLIANCE GUIDELINES

Aegis Labs, Inc. operates as both a Nevada and California Corporation with no organizational or financial relationship with any company, institution, or private individual. Testing and engineering functions provided by Aegis Labs were furnished by RF technicians and engineers with accredited qualifications and training credentials to carry out their duties.

The object of this report was to publish verifiable test results of an EUT subjected to the tests outlined in the standard listed on the cover page of this report.

1.1 Guidelines For Testing To Emissions Standards

These global standards for EMC emission requirements apply to electrical equipment for Information Technology Equipment (ITE). Compliance to these standards and in combination with the other standards listed in this test report can be used to demonstrate presumption of compliance with the protection requirements of the appropriate agency standard.

The purpose of these standards is to specify minimum requirements for emissions regarding electromagnetic compatibility (EMC) and protect the radio frequency spectrum 9 kHz. – 400 GHz. from unwanted interference generated from electrical/digital systems that intentionally or unintentionally generated RF energy. The emissions standards, normative documents and/or publications were used to conduct all tests performed on the equipment herein referred to as “Equipment Under Test”.



2.0 SUMMARY OF TEST RESULTS

Emissions

Index	Standard	Test Limits / Levels			Results
1	FCC PART 15	A.C. Mains Port; Conducted Emissions; 0.150 MHz to 30 MHz			Not Tested (Note 1)
		Frequency	Q-P Limit	AVG Limit	
		0.150 – 0.5 MHz	66 dBuV	56 dBuV	
		0.5 – 5	56 dBuV	46 dBuV	
		5 – 30	60 dBuV	50 dBuV	
	FCC PART 15	R.F. Electromagnetic Fields, 30 to 1000 MHz			PASSED
		Frequency	Limit	Distance	
		30 – 230 MHz	30 dBuV/m	10m	
230 – 1000 MHz		37 dBuV/m	10m		

Note 1: Test not administered since device is DC powered.

ANALYSIS AND CONCLUSIONS

Based upon the measurement results we find that this equipment is within the limits of the global standards listed on the cover page of this test report. All results are based on a test of one sample. If any significant changes are made to the unit, the changes shall be evaluated and a retest may be required.

Approval Signatories

Test and Report Completed By:

Johnny Candelas **01/19/09**
Date:
Test Technician
Aegis Labs, Inc.

Report Approved By:

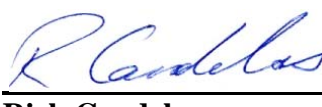
Rick Candelas **01/19/09**
Date:
Quality Assurance & EMC Lab Manager
Aegis Labs, Inc.



3.0 ADMINISTRATIVE DATA AND TEST DESCRIPTION

DEVICE TESTED:	ITE Type: S-Band Satellite Modem Model Number(s): ICO MCAP User Equipment Serial Number: 3500212-0001
DATE EUT RECEIVED:	November 10 th , 2008
TEST DATE(S):	November 11 th , 2008
ORIGIN OF TEST SAMPLE(S):	Pre-Production
EQUIPMENT CLASS:	EUT tested as CLASS B device
RESPONSIBLE PARTY:	Hughes Network Systems 9605 Scranton Road, Suite 500 San Diego, California 92121
CLIENT CONTACT:	Mr. Dave Couchman
MANUFACTURER:	Hughes Network Systems
TEST LOCATION:	Aegis Labs, Inc. 32231 Trabuco Creek Road Trabuco Canyon, CA 92678 Open Area Test Site #1
ACCREDITATION CERTIFICATE(S):	A2LA Certificate Number: 1111.01, Valid through February 28, 2010
PURPOSE OF TEST:	To demonstrate compliance with the standards as described in Sections 1.0 & 2.0 of this report.
UNCERTAINTY BUDGET:	Proficiency Testing and Uncertainty Calculations for all tests indicated in this report have been conducted in accordance with ISO 17025: 2005 requirements Section 5.4.6, and 5.9. Uncertainty Budgets and Proficiency Test results available upon request.
STATEMENT OF CALIBRATION:	All accredited equipment calibrations were performed by Liberty Labs, Inc. and World Cal. with typical calibration uncertainty estimates derived from ISO Guide to the determination of uncertainties with a Coverage Factor of k=2 for 95% level of confidence.

4.0 DESCRIPTION OF EUT CONFIGURATION

4.1 Arrangement and Location of EUT and Host Equipment

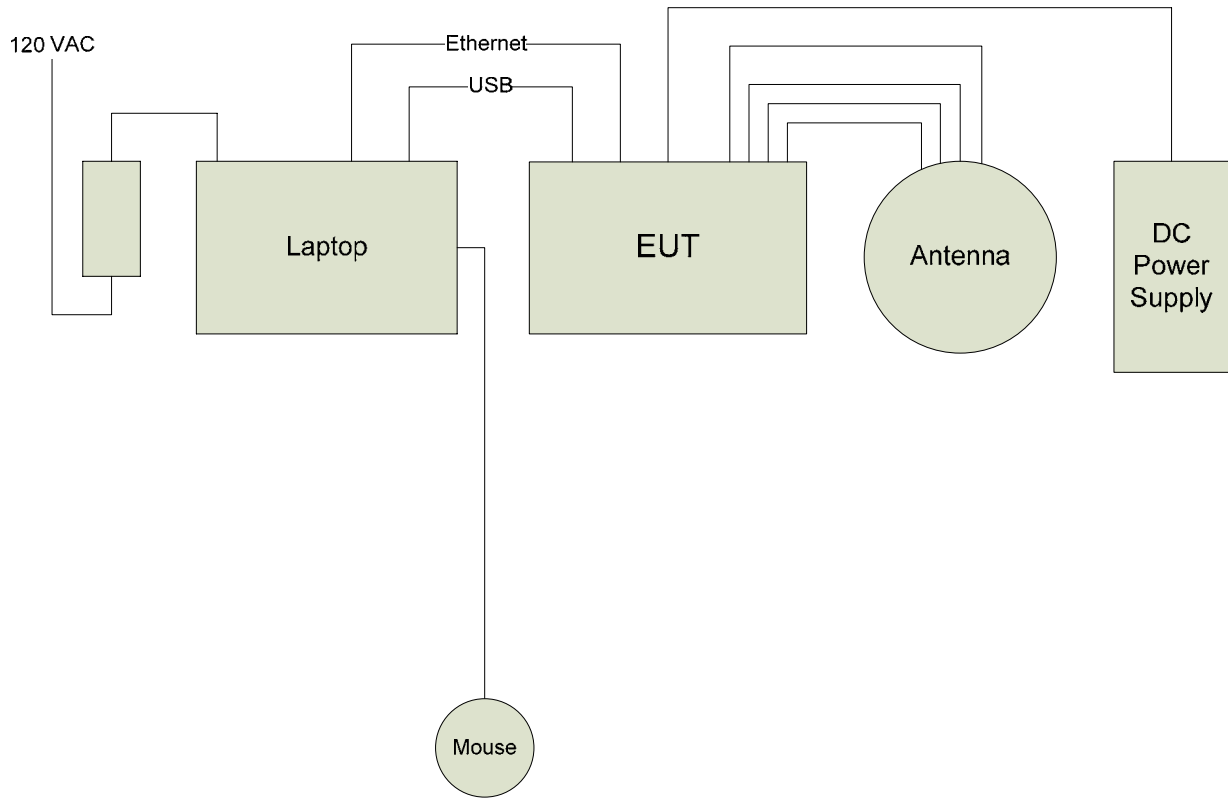

4.2 EUT Description and Configuration

Equipment Under Test (EUT): S-Band Satellite Modem	
Test Routine Software Programs used during testing of EUT and Peripherals:	Hughes Network Systems Software
Number of External Test Ports Exercised:	4 Antenna Ports & 1 Power Port
Power Supply Voltage applied to EUT during qualification measurements:	12 VDC
Clocks and/or Crystal Oscillator(s):	N/A

4.2.1 Product Description

The ICO MCAP User Equipment is a satellite modem operating in the S-Band spectrum (2000 - 2020MHz (Tx) & 2180 - 2200 MHz (Rx)).

4.2.2 EUT Configuration

The ICO MCAP USER EQUIPMENT is connected to a Hughes Network Systems antenna with four RF cables. The satellite modem is powered by a 12VDC vehicle supply. The antenna is powered by a DC feed from the satellite modem via the DVB/GRM port through 1 of the RF cables.

The satellite modem and Hughes Network Systems antenna were tested as a standalone device along with a host notebook computer and DC power supply. Data can be found in Appendix A of the test report.

The low, middle, and high channels were tested. The EUT was placed in continuous transmit mode by a program provided by the manufacturer.



4.3 List of EUT, Sub-Assemblies and Host Equipment

Equipment Under Test			
Manufacturer	Equipment Name	Model or Part Number	Serial Number
Hughes Network Systems	S-Band Satellite Modem	ICO MCAP User Equipment	3500212-0001

EUT Sub-Assemblies			
Manufacturer	Equipment Name	Model or Part Number	Serial Number
Hughes Network Systems	Antenna	3500215	N/A

Remotely Located Support Equipment			
Manufacturer	Equipment Name	Model or Part Number	Serial Number
Protek	DC Power Supply	3003B	AG4334
Toshiba	Notebook Computer	PP714U	20455807U-3
Toshiba	Notebook Power Supply	PA2450U	0649172
Dell	Mouse	M-UK	N/A

NOTE: All the power cords of the above support equipment are standard and non-shielded.

4.4 Signal Line Cable Description and Connection Location

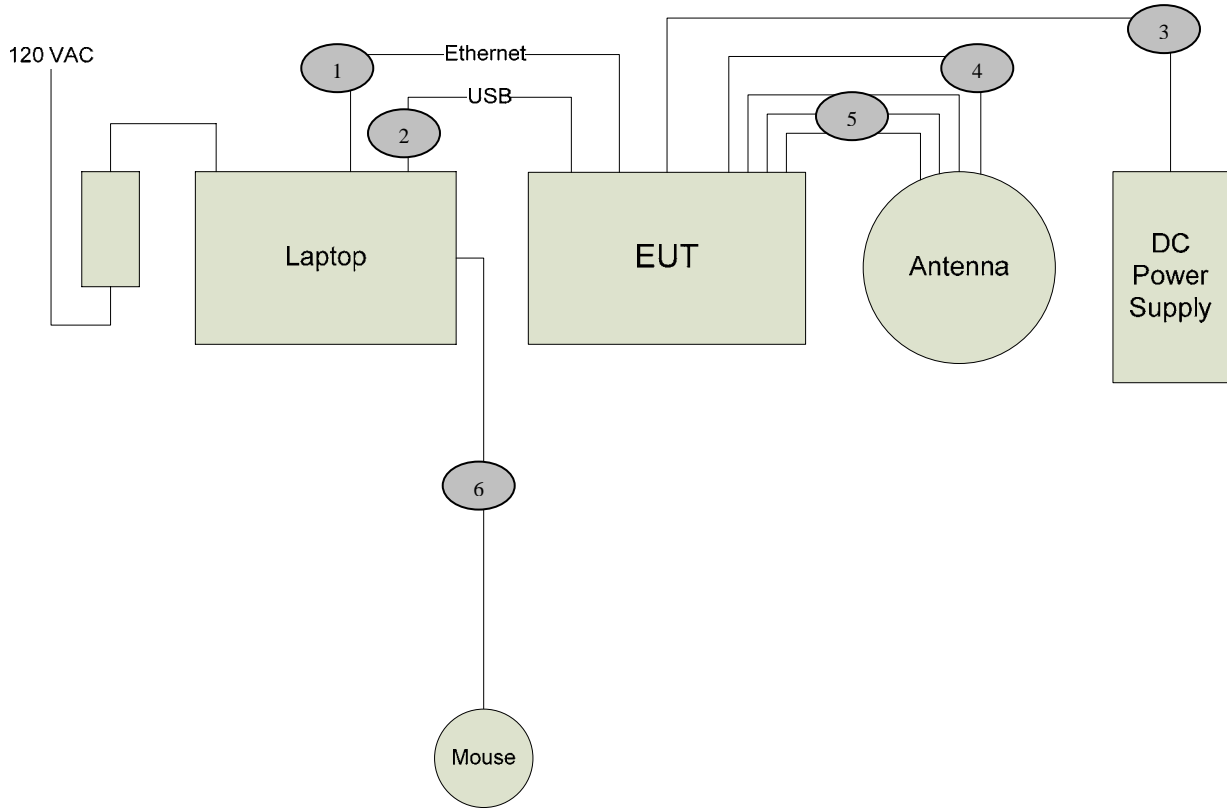

Signal Line Cable Description

Cable	Length	Construction	Source Connector	Destination Connector	Bundled Length	Ferrite Attached	Note
1	1.0m	Unshielded twisted pair	EUT: Plastic RJ-45	Laptop: Plastic RJ-45	N/A	N/A	N/A
2	3.0m	Round, Braid & Foil Shielded	EUT: Metallic USB	Laptop: Metallic USB	1m	N/A	N/A
3	1.0m	Round, Braid & Foil Shielded	EUT: Hardwired	DC Power Source: Banana Ports	N/A	N/A	N/A
4	4.5m	Round, Braid & Foil Shielded	EUT: Metallic DVB/GRM Antenna Port	Antenna: SMA Antenna Port	1m	N/A	N/A
5	4.5m	Round, Braid & Foil Shielded	EUT: Metallic SMA Antenna Ports (3ea.)	Antenna: DVB Antenna Ports (3ea.)	1m	N/A	N/A
6	1.0m	Round, Braid & Foil Shielded	Laptop: Metallic USB	Mouse: Hardwired	N/A	N/A	N/A



4.5 EMC Test Hardware and Software Measurement Equipment

TEST EQUIPMENT LIST					
Equipment Name	Manufacturer	Model Number	Serial Number	Calibration Due Date	Maintenance Calibration Cycle
EMI Receiver - RF Section	Hewlett Packard	8546A	3325A00137	04/26/09	1 Year
EMI Receiver - RF Filter Section	Hewlett Packard	85460A	3330A00138	04/26/09	1 Year
10 dB Attenuator	Pasternack	PE7014-10	N/A	09/05/09	1 Year
LISN (EUT)	Fisher Custom Communications	FCC-LISN-50-25-2	9931	03/30/09	1 Year
LISN (Access)	EMCO	3825/2	9108-1848	03/30/09	1 Year
Antenna - Biconical	EMCO	3110B	3383	03/20/09	1 Year
Antenna - Log Periodic	EMCO	3148	47943	03/20/09	1 Year

5.0 CONDITIONS DURING EMISSIONS MEASUREMENTS

5.1 General

All measurements were made according to the procedures defined in or referred to by the standard listed on the cover page of this report. The measurements were made in the operating mode producing the largest emissions consistent with normal operation and connected to the minimum configuration of auxiliary devices.

5.2 Conducted Emissions Test Setup

The following was the test configuration.

EUT signal cables that hung closer than 40 cm to the horizontal metal ground plane were folded back and forth forming a bundle 30 cm to 40 cm long. The power cord of the EUT was also bundled in the center and plugged into one of the artificial mains network (AMN). All peripheral equipment was powered from a second AMN via a multiple outlet strip placed at a distance on 10cm from each other. The AMN and ISN were positioned 80cm from the EUT. Signal cables that were not connected to an AE were terminated using the correct termination. If applicable, the current probe was placed at 0.1 m from the ISN.

Peak, quasi-peak and/or average detectors were used for testing performed between 150 kHz and 30 MHz. A swept frequency scan was performed for both Line 1 and Line 2. The six highest readings were compared against the limit and recorded in the data sheet along with a snapshot image of the sweep scan. The graphical scans in Appendix A only reflect peak readings while the tabulated data sheets reflect peak, average, and/or quasi-peak measurements.

Climatic Conditions:

The EUT was tested within its intended operating and climatic conditions.

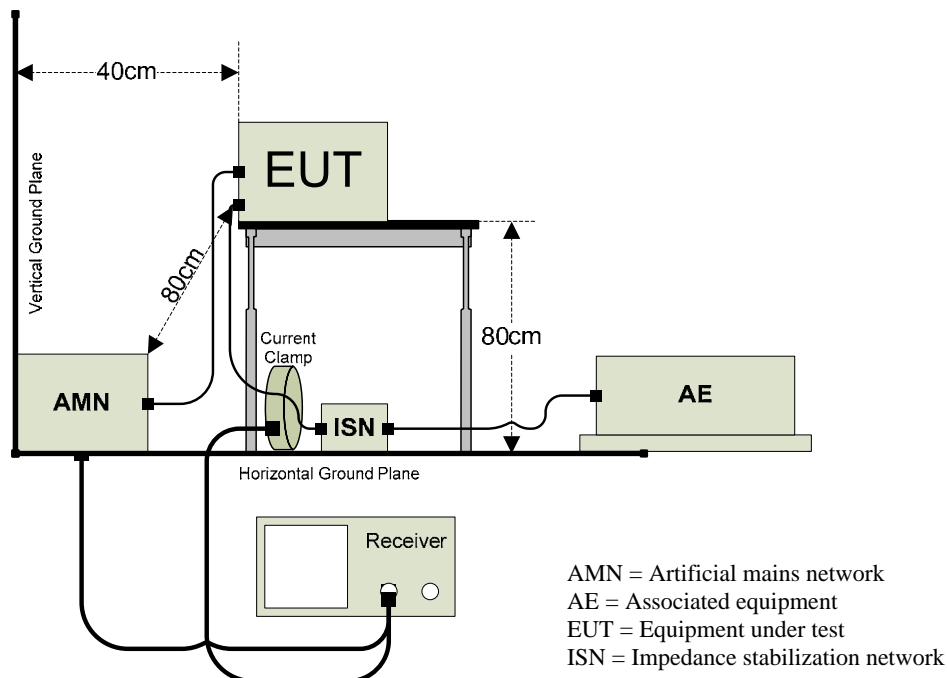

5.3 Radiated Emissions Test Setup

The Open Area Test Site (OATS) was used for radiated emission testing. The receiving (Rx) antenna(s) was placed 10m from the nearest side of the EUT facing the Rx antenna. The EUT (if floor-standing) was placed directly on the flush-mounted 360 degree rotating turntable. The EUT (if table-top) was placed directly on an 80cm high non-metallic table, and the table was placed on the rotating turntable. During the initial EMI scan, all the suspect frequencies, i.e.; harmonics, broadband signals were checked with the Rx broadband antennas in both vertical and horizontal polarities. The biconical Rx, log periodic Rx, and horn Rx antennas were used from 30MHz – 300MHz, 300MHz – 1000MHz, and 1GHz – 18GHz respectively.

Upon completion of all harmonic and broadband measurements, the balance of any remaining frequencies was checked between 30MHz – 18GHz. Any signals appearing within 20 dB of the classification limit was measured. Each signal was maximized by first rotating the turntable at least 360 degrees and recording the azimuth in the data sheet. Lastly, the Rx antenna was raised and/or lowered to maximize the signal elevation. If the measured signal was obtained using the peak detector and that signal appeared within 3 dB of the regulatory limit line, then the same signal was re-measured using the quasi-peak detector on the EMI receiver. Both meter readings if necessary were recorded on the data sheet.

Climatic Conditions:

The EUT was tested within its intended operating and climatic conditions.

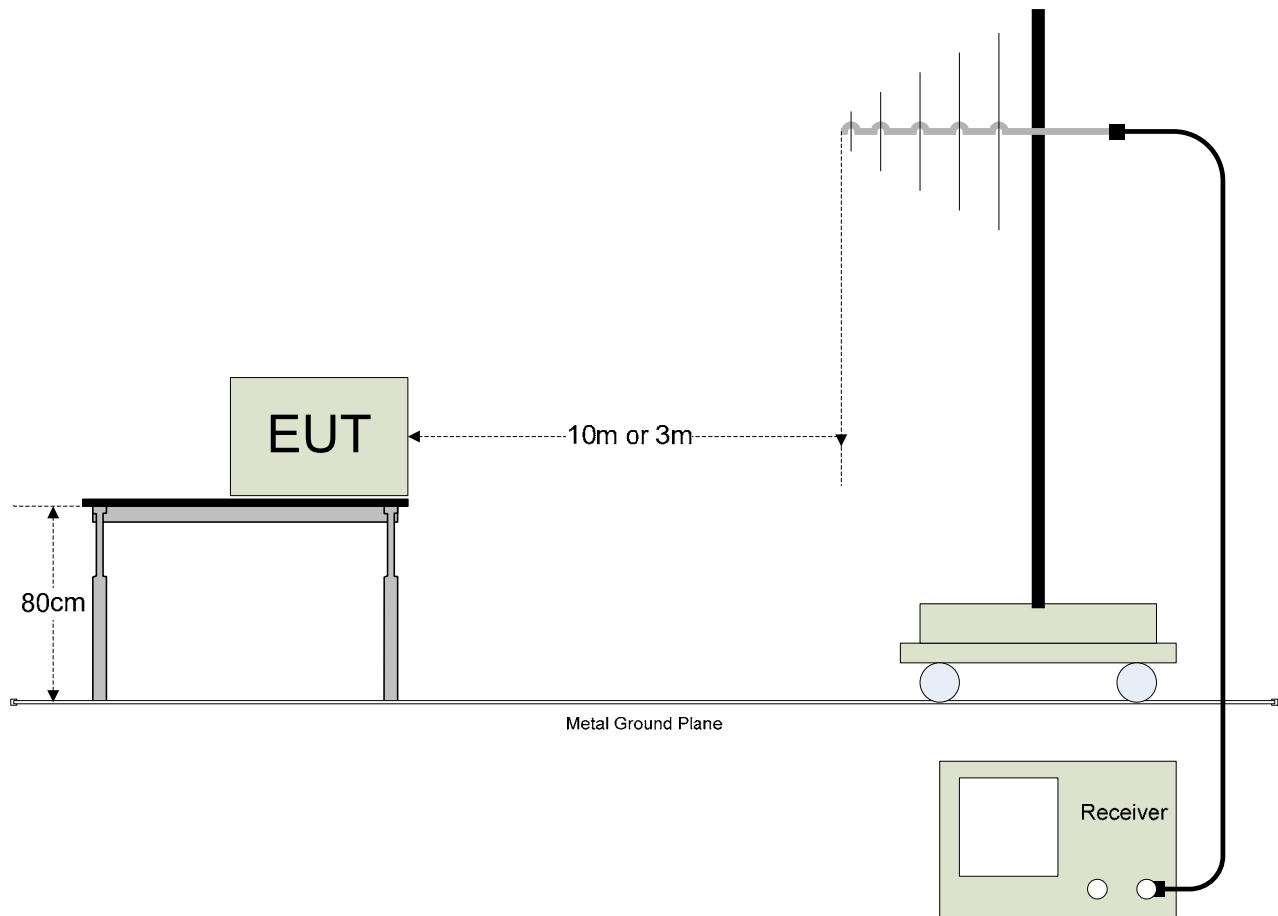



APPENDIX A

TEST DATA



RADIATED EMISSIONS TEST RESULTS

CLIENT:	Hughes Network Systems	DATE:	11/11/08
EUT:	S-Band Satellite Modem	PROJECT NUMBER:	HUGNT-080301
MODEL NUMBER:	ICO MCAP User Equipment	TEST ENGINEER:	JC
SERIAL NUMBER:	3500212-0001	SITE #:	1
CONFIGURATION:	Tested according to section 4.4 of this report	TEMPERATURE:	18 deg. C
		HUMIDITY:	50%
		TIME:	9:30 AM

Description:	Radiated RF Emissions (30 MHz – 1000 MHz)
Results:	PASSED Horizontal and Vertical Antenna Polarizations Class B Limits
Note:	Radiated Emissions Measurements were performed on the EUT with the power supply set at the following voltage and frequency. <ul style="list-style-type: none"> • 120VAC / 60 Hz.

Radiated Emissions Sample Calculations

$$\text{Corrected Meter Reading} = \text{Meter Reading} + F + C - D$$

Where, F = Antenna Factor

C = Cable Factor

G = Amplifier Gain

D = Distance Factor (if applicable)

Therefore, the equation for determining the Corrected Meter Reading Limit (CML) is:

$$\text{CML} = \text{Specification Limit} - F - C + D$$



Radiated Emissions Test Results (Continued)

Continuously Transmitting @ 120VAC/60Hz (HUGNT-080301-01)

Horizontal Open Field Maximized Data										
Freq. (MHz)	Meter Reading (dBuV)	Antenna Height (cm)	Azimuth (degrees)	Quasi pk or AVG (dBuV)		Cable Factor (dB)	Antenna Factor (dB)	Corrected Reading (dBuV/m)	Limits (dBuV/m)	Diff (dB) +/-FAIL
31.44	9.23	400	180	6.54	Q	1.83	18.20	26.56	30.00	-3.44
49.89	7.45	400	45			1.99	11.54	20.98	30.00	-9.02
59.35	9.51	400	135			2.06	8.32	19.89	30.00	-10.11
130.67	10.34	400	180	5.29	Q	2.38	14.13	21.81	30.00	-8.19
149.95	7.17	400	315			2.50	15.40	25.07	30.00	-4.93
168.53	10.46	400	135	6.40	Q	2.60	15.86	24.86	30.00	-5.14
195.98	10.87	400	225	6.68	Q	2.73	17.04	26.45	30.00	-3.55
250.02	7.72	400	135			2.91	17.90	28.53	37.00	-8.47
300.01	11.66	300	315			3.12	13.90	28.68	37.00	-8.32
324.98	7.19	300	225			3.22	15.10	25.51	37.00	-11.49
349.99	8.37	300	45			3.33	15.00	26.70	37.00	-10.30
375.00	11.30	250	45			3.44	15.10	29.84	37.00	-7.16
399.99	6.68	300	180			3.55	15.10	25.33	37.00	-11.67
432.01	8.49	200	225			3.65	16.24	28.38	37.00	-8.62
499.98	7.86	200	225			3.92	18.60	30.38	37.00	-6.62
575.05	10.44	200	0	7.85	Q	4.17	19.30	31.31	37.00	-5.69

Vertical Open Field Maximized Data										
Freq. (MHz)	Meter Reading (dBuV)	Antenna Height (cm)	Azimuth (degrees)	Quasi pk or AVG (dBuV)		Cable Factor (dB)	Antenna Factor (dB)	Corrected Reading (dBuV/m)	Limits (dBuV/m)	Diff (dB) +/-FAIL
30.00	12.79	100	315	7.79	Q	1.81	17.90	27.50	30.00	-2.50
69.54	9.41	100	135			2.13	6.29	17.82	30.00	-12.18
130.66	14.40	100	270	9.28	Q	2.38	13.95	25.61	30.00	-4.39
149.95	9.93	100	225	5.65	Q	2.50	14.80	22.95	30.00	-7.05
168.55	10.10	100	270	6.57	Q	2.60	16.00	25.17	30.00	-4.83
195.98	11.42	100	315	7.96	Q	2.73	16.80	27.49	30.00	-2.51
300.00	13.35	100	180			3.12	14.40	30.87	37.00	-6.13
319.99	7.71	100	135			3.20	15.60	26.51	37.00	-10.49
349.96	8.30	100	180			3.33	15.50	27.13	37.00	-9.87
375.00	8.06	100	180			3.44	15.50	27.00	37.00	-10.00
400.02	8.91	100	315			3.55	15.10	27.56	37.00	-9.44
432.00	8.15	100	135			3.65	16.49	28.29	37.00	-8.71
499.98	10.04	100	225	7.48	Q	3.92	18.10	29.50	37.00	-7.50
575.05	10.86	100	45	8.26	Q	4.17	19.20	31.63	37.00	-5.37



APPENDIX B

PHOTOGRAPHS – (TEST SETUPS)



RADIATED EMISSIONS – FRONT VIEW

FOR

EUT: S-Band Satellite Modem

MODEL NUMBER: ICO MCAP User Equipment



RADIATED EMISSIONS – REAR VIEW

FOR

EUT: S-Band Satellite Modem

MODEL NUMBER: ICO MCAP User Equipment



APPENDIX C

MODIFICATIONS REQUIRED

1.0	NONE



APPENDIX D

ACCREDITATION CERTIFICATE (S)



THE AMERICAN ASSOCIATION FOR
LABORATORY ACCREDITATION

ACCREDITED LABORATORY

A2LA has accredited

AEGIS LABS, INC.
Trabuco Canyon, CA

for technical competence in the field of

Electrical Testing

This laboratory is accredited in accordance with the recognized International Standard ISO/IEC 17025:2005 *General Requirements for the Competence of Testing and Calibration Laboratories*. This accreditation demonstrates technical competence for a defined scope and the operation of a laboratory quality management system (refer to joint ISO-ILAC-IAF Communiqué dated 18 June 2005).

Presented this 11th day of June 2008.

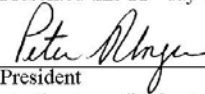

President
For the Accreditation Council
Certificate Number 1111.01
Valid to February 28, 2010



For the tests or types of tests to which this accreditation applies,
please refer to the laboratory's Electrical Scope of Accreditation.



SCOPE OF ACCREDITATION TO ISO/IEC 17025:2005

AEGIS LABS, INC.¹
32231 Trabuco Creek Road
Trabuco Canyon, CA 92678
Rick Candelas Phone: 949-459-7886

ELECTRICAL (EMC)

Valid To: February 28, 2010

Certificate Number: 1111.01

In recognition of the successful completion of the A2LA evaluation process, accreditation is granted to this laboratory to perform the following electromagnetic compatibility tests:

<u>Technology</u>	<u>Test Method(s)</u>
<i>Emissions</i>	
<i>Radiated and Conducted</i>	CFR 47, FCC Part 15 (ANSI C63.4:2003) CFR 47, FCC Part 18 (ANSI C63.4:2003) ICES-001 ICES-003 ICES-005 VCCI V-3 CNS13438: 2006 EN 55011: 1998 + A1: 1999 + A2: 2002 EN 55011: 2007 + A2: 2007 EN 55014-1: 2000 + A1: 2001 + A2: 2002 EN 55014-1: 2006 EN 55014-2: 1997 + A1: 2001 EN 55022: 1998 + A1: 2000 + A2: 2003 EN 55022: 2006 CISPR 11: 1997 + A1: 1999 + A2: 2002 CISPR 11: 2003 + A1: 2004 + A2: 2006 CISPR 13: 2001 + A1: 2003 + A2: 2006 CISPR 14-1: 2000 + A1: 2001 + A2: 2002 CISPR 14-1: 2005 CISPR 14-2: 1997 + A1: 2001 CISPR 22: 1997 + A1: 2000 + A2: 2003 CISPR 22: 2005 AS/NZS CISPR 11: 2004 AS/NZS CISPR 14.1: 2005 AS/NZS CISPR 14.2: 2003 AS/NZS CISPR 22: 2006

¹ This accreditation covers testing performed at the main laboratory listed above, and the satellite laboratory indicated.

**Technology****Emissions (cont'd)****Radiated and Conducted****Test Method(s)**

SABS CISPR 11

SABS CISPR 13

SANS 222: 2006/CISPR22: 2006 (SABS CISPR: 2006)

SII 961-6-1: 2002

KN11

KN13

KN14

KN22

RRL Notice No. 2008-4 (February 11, 2008)

RRL Notice No. 2008-5 (February 11, 2008)

SS IEC CISPR22:

IDA TS EMC

***Product Family and
Generic Standards***

EN 61000-6-1: 2001, 2007

EN 61000-6-2: 2001, 2005

EN 61000-6-3: 2001 + A11: 2004, 2007

EN 61000-6-4: 2001, 2007

EN 50130-4: 1995 + A1:998 + A2: 2003

EN 55103-1: 1996

EN 55103-2: 1996

EN 60601-1-2: 2001

EN 61326: 1997 + A1: 1998 + A2: 2001 + A3: 2003

EN 61326-1: 2006

EN 55020: 2002 +A1: 2003 + A2: 2005

EN 55020: 2007

IEC 61000-6-1: 1997, 2005

IEC 61000-6-2: 1999, 2005

IEC 61000-6-3: 1996, 2006

IEC 61000-6-4: 1997, 2006

IEC 60601-1-2: 2001

IEC 61326: 1997 + A1: 1998 + A2: 2000 + A3: 2002

IEC 61326-1: 2005

CISPR 20: 2002 +A1: 2002 + A2: 2005

CISPR 20: 2006

KN 20

AS/NZS 4251.1: 1999

AS/NZS 4251.2: 1999

AS/NZS 61000.6.1: 2006

AS/NZS 61000.6.2: 2006



<u>Technology</u>	<u>Test Method(s)</u>
<i>Radio Communications</i>	CFR 47, FCC Part 27 (ANSI C63.4:2003) AS/NZS 4771: 2000 + A1: 2003 AS/NZS 4268: 2003 + A1: 2005 + A2: 2006 RSS-GEN RSS-210 RSS-310 IDA TS SRD EN 300 220-1, EN 300 220-2, EN 300 220-3 EN 300 328-1, EN 300 328-2, EN 300 328 EN 300 386 EN 300 440-1, EN 300 440-2 EN 301 489-1 (Excluding Section 9.6) EN 301 489-3 EN 301 489-4 EN 301 489-17 EN 301 893 (Excluding DFS testing)
<i>Harmonics</i>	EN 61000-3-2: 2000 + A2: 2005 EN 61000-3-2: 2006 IEC 61000-3-2: 2000 + A1: 2001 + A2: 2004 AS/NZS 61000.3.2
<i>Flickers</i>	EN 61000-3-3: 1995 + A1: 2001 + A2: 2005 IEC 61000-3-3: 1994 + A1: 2001 + A2: 2005 AS/NZS 61000.3.3

AEGIS LABS, Inc.
 8 Rancho Circle
 Lake Forest, CA 92360
 949 454 8295

<u>Technology</u>	<u>Test Method(s)</u>
<i>Immunity</i>	EN 55024: 1998 + A1: 2001 + A2: 2003 EN 61000-4-2 EN 61000-4-3 EN 61000-4-4 EN 61000-4-5, ITU-T K.20 EN 61000-4-6 EN 61000-4-8 EN 61000-4-11



Technology

Immunity (cont'd)

Test Method(s)

CISPR 24: 1997 + A1: 2001 + A2: 2002
IEC 61000-4-2
IEC 61000-4-3
IEC 61000-4-4
IEC 61000-4-5
IEC 61000-4-6
IEC 61000-4-8
IEC 61000-4-11
KN 24 with RRL Notice No. 2007-99 (2007.12.26) & RRL Notice No.
2007-101 (2007.12.26)
KN 61000-4-2
KN 61000-4-3
KN 61000-4-4
KN 61000-4-5
KN 61000-4-6
KN 61000-4-8
KN 61000-4-11
AS/NZS 61000.4.2
AS/NZS 61000.4.3
AS/NZS 61000.4.4
AS/NZS 61000.4.5
AS/NZS 61000.4.6
AS/NZS 61000.4.8
AS/NZS 61000.4.11

Avionics / Military

RTCA/DO-160 (Sections 15-22 & 25)
RTCA/DO-301 (Sections 2.3.13 – 2.3.19)
MIL-STD-461
MIL-STD-462
MIL-STD-704 (MIL-HDBK-704-1, MIL-HDBK-704-7, MIL-HDBK-
704-8)
BOEING D6-16050-4
BOEING D6-16050-5
BOEING 787B3-0147 (Section 3)
AIRBUS ABD0100.1.8 (Section 1.2, 1.3, 2)