



Specific Absorption Rate (SAR) Test Report
for
Dialogue Technology Corp.
on the
FLYBOOK

Report No. : FA6O2516-04-1-2-01
Trade Name : DIALOGUE
Model Name : V5W1BB
FCC ID : JYV-V5W1BB
Date of Testing : Aug. 17, 2007
Date of Report : Aug. 21, 2007
Date of Review : Aug. 21, 2007

- The test results refer exclusively to the presented test model / sample only.
- Without written approval of SPORTON International Inc., the test report shall not be reproduced except in full.
- Report Version: Rev. 01

SPORTON International Inc.

6F, No.106, Sec. 1, Hsin Tai Wu Rd., Hsi Chih, Taipei Hsien, Taiwan, R.O.C.



Table of Contents

- 1. Statement of Compliance..... 1**
- 2. Administration Data..... 2**
 - 2.1 Testing Laboratory..... 2
 - 2.2 Detail of Applicant..... 2
 - 2.3 Detail of Manufacturer 2
 - 2.4 Application Detail..... 2
- 3. Scope..... 3**
 - 3.1 Description of Device Under Test (DUT)..... 3
 - 3.2 Product Photo..... 4
 - 3.3 Applied Standards: 5
 - 3.4 Device Category and SAR Limits 6
 - 3.5 Test Conditions..... 6
 - 3.5.1 Ambient Condition:..... 6
 - 3.5.2 Test Configuration: 6
- 4. Specific Absorption Rate (SAR) 7**
 - 4.1 Introduction..... 7
 - 4.2 SAR Definition 7
- 5. SAR Measurement Setup..... 8**
 - 5.1 DASY4 E-Field Probe System..... 9
 - 5.1.1 EX3DV3 E-Field Probe Specification 10
 - 5.1.2 ET3DV6 & EX3DV3 E-Field Probe Calibration..... 10
 - 5.2 DATA Acquisition Electronics (DAE) 11
 - 5.3 Robot..... 12
 - 5.4 Measurement Server..... 12
 - 5.5 SAM Twin Phantom 12
 - 5.6 Data Storage and Evaluation..... 14
 - 5.6.1 Data Storage 14
 - 5.6.2 Data Evaluation..... 14
 - 5.7 Test Equipment List 17
- 6. Tissue Simulating Liquids 18**
- 7. Uncertainty Assessment 19**
- 8. SAR Measurement Evaluation 21**
 - 8.1 Purpose of System Performance check 21
 - 8.2 System Setup 21
 - 8.3 Validation Results..... 23
- 9. Description for DUT Testing Position 24**
- 10. Measurement Procedures 25**
 - 10.1 Spatial Peak SAR Evaluation 25
 - 10.2 Scan Procedures..... 26
 - 10.3 SAR Averaged Methods 26
- 11. SAR Test Results..... 27**
 - 11.1 Notebook Bottom Touch with Main Antenna 27
 - 11.2 Notebook Bottom Touch with Aux. Antenna..... 27
- 12. Reference..... 28**

Appendix A – System Performance Check Data

Appendix B – SAR Measurement Data

Appendix C – Calibration Data

Appendix D - Product Photo

Appendix E - Setup Photo



1. Statement of Compliance

The Specific Absorption Rate (SAR) maximum result found during testing for the Dialogue Technology Corp. FLYBOOK V5W1BB on the 5GHz band body SAR are as follows (with expanded uncertainty 25.9% for 5GHz band):

5250 ~ 5350 MHz <Band II> Body SAR (W/kg)
0.241

The co-location of WLAN and Bluetooth were also checked. It is in compliance with Specific Absorption Rate (SAR) for general population/uncontrolled exposure limits specified in FCC 47 CFR part 2 (2.1093) and ANSI/IEEE C95.1-1999 and had been tested in accordance with the measurement methods and procedures specified in OET Bulletin 65 Supplement C (Edition 01-01).

Approved by

Jones Tsai
Manager



2. Administration Data

2.1 Testing Laboratory

Company Name : Sporton International Inc.
Department : Antenna Design/SAR
Address : No.52, Hwa-Ya 1st RD., Hwa Ya Technology Park, Kwei-Shan Hsiang, Tao Yuan Hsien, Taiwan, R.O.C.
Telephone Number : 886-3-327-3456
Fax Number : 886-3-327-0973

2.2 Detail of Applicant

Company Name : Dialogue Technology Corp.
Address : 10F, No. 196, Sec. 2, Jungshing Rd., Shindian City, Taipei 231, Taiwan, R.O.C.
Telephone Number : 886-2-8911-5121
Fax Number : 886-2-8911-6151

2.3 Detail of Manufacturer

Company Name : Dialogue Technology Corp.
Address : 10F, No. 196, Sec. 2, Jungshing Rd., Shindian City, Taipei 231, Taiwan, R.O.C.

2.4 Application Detail

Date of reception of application: Aug. 08, 2007
Start of test : Aug. 17, 2007
End of test : Aug. 17, 2007



3. Scope

3.1 Description of Device Under Test (DUT)

DUT Type :	FLYBOOK
Model Name :	V5W1BB
FCC ID :	JYV-V5W1BB
Type of Modulation :	802.11a : OFDM 802.11b/g : DSSS / OFDM BT : GFSK
Frequency Range :	802.11a : 5150 ~ 5350MHz (Band I,II) / 5725MHz ~ 5850MHz (Band III) 802.11b/g : 2400MHz ~ 2483.5MHz BT : 2400MHz ~ 2483.5MHz
Maximum Output Power to Antenna :	802.11a : 16.93 dBm (Band I) / 15.07 dBm (Band II) / 18.09 dBm (Band III) 802.11b : 18.12 dBm / 802.11g: 19.55dBm BT : 1.99 dBm
Antenna Type :	PIFA Antenna
Antenna Connector :	I-PEX
Application Type :	Certification



3.2 Product Photo

Please refer to Appendix D



3.3 Applied Standards:

The Specific Absorption Rate (SAR) testing specification, method and procedure for this FLYBOOK is in accordance with the following standards:

47 CFR Part 2 (2.1093),
IEEE C95.1-1999,
IEEE C95.3-2002,
IEEE P1528 -2003, and
OET Bulletin 65 Supplement C (Edition 01-01)



3.4 Device Category and SAR Limits

This device belongs to portable device category because its radiating structure is allowed to be used within 20 centimeters of the body of the user.

Limit for General Population/Uncontrolled exposure should be applied for this device and it is 1.6 W/kg as averaged over any 1 gram of tissue.

3.5 Test Conditions

3.5.1 Ambient Condition:

Ambient Temperature (°C)	20 ~ 24
Tissue simulating liquid temperature (°C)	21.8
Humidity (%)	< 60%

3.5.2 Test Configuration:

The data rates for SAR testing is 6 Mbps for 802.11a. Engineering testing software installed on the EUT can provide continuous transmitting RF signal. This RF signal utilized in SAR measurement has almost 100% duty cycle and its crest factor is 1.



4. Specific Absorption Rate (SAR)

4.1 Introduction

SAR is related to the rate at which energy is absorbed per unit mass in an object exposed to a radio field. The SAR distribution in a biological body is complicated and is usually carried out by experimental techniques or numerical modeling. The FCC recommends limits for two tiers of groups, occupational/controlled and general population/uncontrolled, based on a person’s awareness and ability to exercise control over his or her exposure. In general, occupational/controlled exposure limits are higher than the limits for general population/uncontrolled.

4.2 SAR Definition

The SAR definition is the time derivative (rate) of the incremental energy (dW) absorbed by (dissipated in) an incremental mass (dm) contained in a volume element (dv) of a given density.

). The equation description is as below:

$$\mathbf{SAR} = \frac{d}{dt} \left(\frac{dW}{dm} \right) = \frac{d}{dt} \left(\frac{dW}{\rho dv} \right)$$

SAR is expressed in units of Watts per kilogram (W/kg)

SAR measurement can be either related to the temperature elevation in tissue by

$$\mathbf{SAR} = C \frac{\delta T}{\delta t}$$

, where C is the specific head capacity, δT is the temperature rise and δt the exposure duration,

or related to the electrical field in the tissue by

$$\mathbf{SAR} = \frac{\sigma |E|^2}{\rho}$$

, where σ is the conductivity of the tissue, ρ is the mass density of the tissue and E is the rms electrical field strength.

However for evaluating SAR of low power transmitter, electrical field measurement is typically applied.

5. SAR Measurement Setup

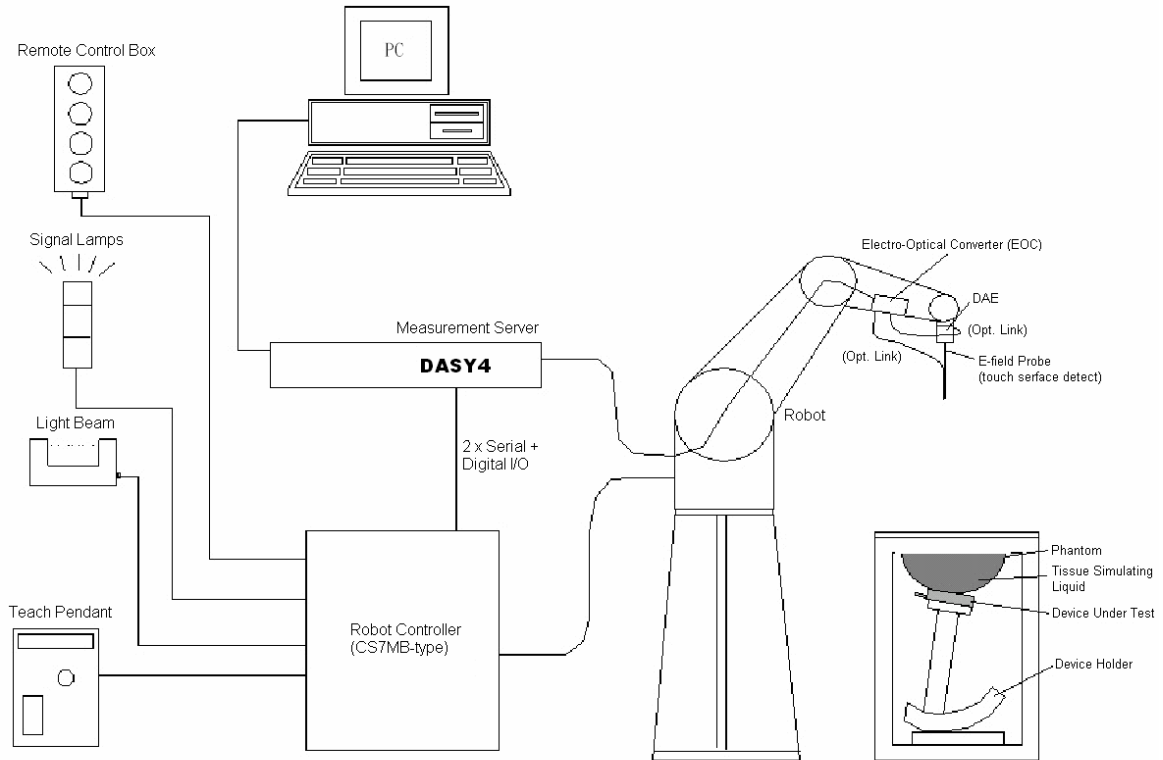

Fig. 5.1 DASY4 system



The DASY4 system for performance compliance tests is illustrated above graphically. This system consists of the following items:

- A standard high precision 6-axis robot with controller, a teach pendant and software
- A data acquisition electronic (DAE) attached to the robot arm extension
- A dosimetric probe equipped with an optical surface detector system
- The electro-optical converter (ECO) performs the conversion between optical and electrical signals
- A measurement server performs the time critical tasks such as signal filtering, control of the robot operation and fast movement interrupts.
- A probe alignment unit which improves the accuracy of the probe positioning
- A computer operating Windows XP
- DASY4 software
- Remove control with teach pendant and additional circuitry for robot safety such as warning lamps, etc.
- The SAM twin phantom
- A device holder
- Tissue simulating liquid
- Dipole for evaluating the proper functioning of the system

Some of the components are described in details in the following sub-sections.

5.1 DASY4 E-Field Probe System

The SAR measurement is conducted with the dosimetric probe EX3DV3 (manufactured by SPEAG). The probe is specially designed and calibrated for use in liquid with high permittivity. The dosimetric probe has special calibration in liquid at different frequency.



5.1.1 EX3DV3 E-Field Probe Specification

<EX3DV3 Probe>

Construction	Symmetrical design with triangular core Built-in shielding against static charges PEEK enclosure material (resistant to organic solvents)
Calibration	Basic Broad Band Calibration in air: 10-3000 MHz Conversion Factors (CF) for HSL 900 and HSL 1800 Additional CF for other liquids and frequencies upon request
Frequency	10 MHz to > 6 GHz; Linearity: ± 0.2 dB (30 MHz to 3 GHz)
Directivity	± 0.3 dB in HSL (rotation around probe axis) ± 0.5 dB in tissue material (rotation normal to probe axis)
Dynamic Range	10 μ W/g to > 100 mW/g; Linearity: ± 0.2 dB (noise: typically < 1 μ W/g)
Dimensions	Overall length: 330 mm (Tip: 20 mm) Tip diameter: 2.5 mm (Body: 12 mm) Typical distance from probe tip to dipole centers: 1 mm
Application	High precision dosimetric measurements in any exposure scenario (e.g., very strong gradient fields). Only probe which enables compliance testing for frequencies up to 6 GHz with precision of better 30%.



Fig. 5.2 EX3DV3 E-field Probe

5.1.2 ET3DV6 & EX3DV3 E-Field Probe Calibration

Each probe needs to be calibrated according to a dosimetric assessment procedure with accuracy better than $\pm 10\%$. The spherical isotropy shall be evaluated and within ± 0.25 dB. The sensitivity parameters (NormX, NormY, and NormZ), the diode compression parameter (DCP) and the conversion factor (ConvF) of the probe are tested. The calibration data are as below:



Sensitivity	X axis : 0.660 μ V	Y axis : 0.690 μ V	Z axis : 0.570 μ V	
Diode compression point	X axis : 95 mV	Y axis : 93 mV	Z axis : 96 mV	
Conversion factor (Body)	Frequency (MHz)	X axis	Y axis	Z axis
	5100~5300	4.31	4.31	4.31
	5400~5600	4.09	4.09	4.09
	5700~5900	4.16	4.16	4.16
Boundary effect (Body)	Frequency (MHz)	Alpha	Depth	
	5100~5300	0.35	1.70	
	5400~5600	0.35	1.70	
	5700~5900	0.35	1.70	

NOTE: The probe parameters have been calibrated by the SPEAG.

5.2 DATA Acquisition Electronics (DAE)

The data acquisition electronics (DAE4) consists of a highly sensitive electrometer-grade preamplifier with auto-zeroing, a channel and gain-switching multiplexer, a fast 16 bit AD-converter and a command decoder and control logic unit. Transmission to the measurement server is accomplished through an optical downlink for data and status information as well as an optical uplink for commands and the clock.

The mechanical probe mounting device includes two different sensor systems for frontal and sideways probe contacts. They are used for mechanical surface detection and probe collision detection.

The input impedance of the DAE4 is 200M Ohm; the inputs are symmetrical and floating. Common mode rejection is above 80dB.



5.3 Robot

The DASY4 system uses the high precision robots RX90BL type out of the newer series from Stäubli SA (France). For the 6-axis controller DASY4 system, the CS7MB robot controller version from Stäubli is used. The RX robot series have many features that are important for our application:

- High precision (repeatability 0.02 mm)
- High reliability (industrial design)
- Jerk-free straight movements
- Low ELF interference (the closed metallic construction shields against motor control fields)
- 6-axis controller

5.4 Measurement Server

The DASY4 measurement server is based on a PC/104 CPU board with
166 MHz CPU
32 MB chipset and
64 MB RAM.

Communication with
the DAE4 electronic box
the 16-bit AD-converter system for optical detection and digital I/O interface.

The measurement server performs all the real-time data evaluation for field measurements and surface detection, controls robot movements and handles safety operations.

5.5 SAM Twin Phantom

The SAM twin phantom is a fiberglass shell phantom with 2mm shell thickness (except the ear region where shell thickness increases to 6mm). It has three measurement areas:

- Left head
- Right head
- Flat phantom

The bottom plate contains three pair of bolts for locking the device holder. The device holder positions are adjusted to the standard measurement positions in the three sections.

A white cover is provided to tap the phantom during off-periods to prevent water evaporation and changes in the liquid parameters.

On the phantom top, three reference markers are provided to identify the phantom position with respect to the robot.

The phantom can be used with the following tissue simulating liquids:

*Water-sugar based liquid

*Glycol based liquids

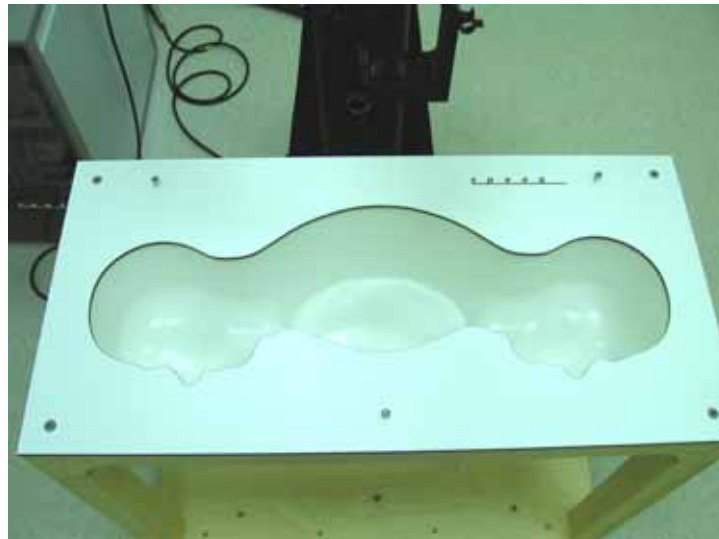

Fig. 5.3 Top view of twin phantom



Fig. 5.4 Bottom view of twin phantom



5.6 Data Storage and Evaluation

5.6.1 Data Storage

The DASY4 software stores the assessed data from the data acquisition electronics as raw data (in microvolt readings from the probe sensors), together with all the necessary software parameters for the data evaluation (probe calibration data, liquid parameters and device frequency and modulation data) in measurement files with the extension .DA4. The post-processing software evaluates the desired unit and format for output each time the data is visualized or exported. This allows verification of the complete software setup even after the measurement and allows correction of erroneous parameter settings. For example, if a measurement has been performed with an incorrect crest factor parameter in the device setup, the parameter can be corrected afterwards and the data can be reevaluated.

The measured data can be visualized or exported in different units or formats, depending on the selected probe type (e.g., [V/m], [A/m], [mW/g]). Some of these units are not available in certain situations or give meaningless results, e.g., a SAR-output in a non-loss media, will always be zero. Raw data can also be exported to perform the evaluation with other software packages.

5.6.2 Data Evaluation

The DASY4 post-processing software (SEMCAD) automatically executes the following procedures to calculate the field units from the microvolt readings at the probe connector. The parameters used in the evaluation are stored in the configuration modules of the software :

- Probe parameters :**
 - Sensitivity Norm_i, a_{i0}, a_{i1}, a_{i2}
 - Conversion factor ConvF_i
 - Diode compression point dcp_i
- Device parameters :**
 - Frequency f
 - Crest factor cf
- Media parameters :**
 - Conductivity
 - Density

These parameters must be set correctly in the software. They can be found in the component documents or they can be imported into the software from the configuration files issued for the DASY components. In the direct measuring mode of the multi-meter option, the parameters of the actual system setup are used. In the scan visualization and export modes, the parameters stored in the corresponding document files are used. The first step of the evaluation is a linearization of the filtered input signal to account for the compression characteristics of the detector diode. The compensation depends on the input signal, the diode type and the DC-transmission factor from the diode to the evaluation electronics. If the exciting field is pulsed, the crest factor of the signal must be known to correctly compensate for peak power. The formula for each channel



can be given as :

$$V_i = U_i + U_i^2 \cdot \frac{cf}{dcp_i}$$

with $V_i =$ compensated signal of channel i ($i = x, y, z$)
 $U_i =$ input signal of channel i ($i = x, y, z$)
 $cf =$ crest factor of exciting field (DASY parameter)
 $dcp_i =$ diode compression point (DASY parameter)

From the compensated input signals, the primary field data for each channel can be evaluated :

E-field probes : $E_i = \sqrt{\frac{V_i}{Norm_i ConvF}}$

H-field probes : $H_i = \sqrt{V_i \frac{a_{i0} + a_{i1}f + a_{i2}f^2}{f}}$

with $V_i =$ compensated signal of channel i ($i = x, y, z$)
 $Norm_i =$ sensor sensitivity of channel i ($i = x, y, z$)
 $\mu V/(V/m)^2$ for E-field Probes
 $ConvF =$ sensitivity enhancement in solution
 $a_{ij} =$ sensor sensitivity factors for H-field probes
 $f =$ carrier frequency [GHz]
 $E_i =$ electric field strength of channel i in V/m
 $H_i =$ magnetic field strength of channel i in A/m

The RSS value of the field components gives the total field strength (Hermitian magnitude) :

$$E_{tot} = \sqrt{E_x^2 + E_y^2 + E_z^2}$$

The primary field data are used to calculate the derived field units.

$$SAR = E_{tot}^2 \cdot \frac{\sigma}{\rho \cdot 1000}$$

with $SAR =$ local specific absorption rate in mW/g
 $E_{tot} =$ total field strength in V/m
 $\sigma =$ conductivity in [mho/m] or [Siemens/m]
 $\rho =$ equivalent tissue density in g/ cm³



* Note that the density is set to 1, to account for actual head tissue density rather than the density of the tissue simulating liquid.

The power flow density is calculated assuming the excitation field to be a free space field.

$$P_{pwe} = \frac{E_{tot}^2}{3770} \quad \text{or} \quad P_{pwe} = H_{tot}^2 \cdot 37.7$$

with P_{pwe} = equivalent power density of a plane wave in mW/cm²
 E_{tot} = total electric field strength in V/m
 H_{tot} = total magnetic field strength in A/m



5.7 Test Equipment List

Manufacture	Name of Equipment	Type/Model	Serial Number	Calibration	
				Last Cal.	Due Date
SPEAG	Dosimetric E-Filed Probe	ET3DV6	1788	Feb. 21, 2007	Feb. 21, 2008
SPEAG	5GHz System Validation Kit	D5GHzV2	1006	Feb. 10, 2006	Feb. 10, 2008
SPEAG	Data Acquisition Electronics	DAE3	577	Nov. 21, 2006	Nov. 21, 2007
SPEAG	Device Holder	N/A	N/A	NCR	NCR
SPEAG	Phantom	QD 000 P40 C	TP-1150	NCR	NCR
SPEAG	Robot	Staubli RX90BL	F03/5W15A1/A/01	NCR	NCR
SPEAG	Software	DASY4 V4.7 Build 53	N/A	NCR	NCR
SPEAG	Software	SEMCAD V1.8 Build 172	N/A	NCR	NCR
SPEAG	Measurement Server	SE UMS 001 BA	1021	NCR	NCR
Agilent	ENA Series Network Analyzer	E5071C	MY46100746	Feb. 21, 2007	Feb. 21, 2008
Agilent	Dielectric Probe Kit	85070D	US01440205	NCR	NCR
Agilent	Dual Directional Coupler	778D	50422	NCR	NCR
Agilent	Power Amplifier	8449B	3008A01917	NCR	NCR
Agilent	Power Meter	E4416A	GB41292344	Feb. 08, 2007	Feb. 08, 2008
Agilent	Power Sensor	E9327A	US40441548	Feb. 08, 2007	Feb. 08, 2008
Agilent	Signal Generator	E8247C	MY43320596	Mar. 01, 2006	Mar. 01, 2008

Table 5.1 Test Equipment List



6. Tissue Simulating Liquids

For the measurement of the field distribution inside the SAM phantom with DASY4, the phantom must be filled with around 25 liters of homogeneous body tissue simulating liquid. The liquid height from the bottom of the phantom body is 15.2 centimeters.

The dielectric parameters of the liquids were verified prior to the SAR evaluation using an Agilent 85070D Dielectric Probe Kit and an Agilent Network Analyzer.

Table 6.1 shows the Measurement for Muscle Simulating Liquid.

Bands	Frequency(MHz)	Permittivity (ϵ_r)	Conductivity (σ)	Measurement date
5250 ~ 5350 MHz <Band II>	5260	5.26	48.4	Aug. 17, 2007
	5280	5.28	48.4	
	5300	5.31	48.4	

Table 6.1 Measurement for Muscle Simulating Liquid

The measuring data are consistent with $\epsilon_r = 49.0 \pm 5\%$ and $\sigma = 5.30 \pm 5\%$ for 5GHz band 2.



7. Uncertainty Assessment

The component of uncertainty may generally be categorized according to the methods used to evaluate them. The evaluation of uncertainty by the statistical analysis of a series of observations is termed a Type A evaluation of uncertainty. The evaluation of uncertainty by means other than the statistical analysis of a series of observation is termed a Type B evaluation of uncertainty. Each component of uncertainty, however evaluated, is represented by an estimated standard deviation, termed standard uncertainty, which is determined by the positive square root of the estimated variance.

A Type A evaluation of standard uncertainty may be based on any valid statistical method for treating data. This includes calculating the standard deviation of the mean of a series of independent observations; using the method of least squares to fit a curve to the data in order to estimate the parameter of the curve and their standard deviations; or carrying out an analysis of variance in order to identify and quantify random effects in certain kinds of measurement.

A type B evaluation of standard uncertainty is typically based on scientific judgment using all of the relevant information available. These may include previous measurement data, experience and knowledge of the behavior and properties of relevant materials and instruments, manufacture’s specification, data provided in calibration reports and uncertainties assigned to reference data taken from handbooks. Broadly speaking, the uncertainty is either obtained from an outdoor source or obtained from an assumed distribution, such as the normal distribution, rectangular or triangular distributions indicated in Table 7.1

Uncertainty Distribution Type	Normal	Rectangular	Triangular	U-shape
Multiplying factor ^(a)	1/k (b)	1/ 3	1/ 6	1/ 2

(a) standard uncertainty is determined as the product of the multiplying factor and the estimated range of variations in the measured quantity
(b) is the coverage factor

Table 7.1 Multiplying Factor for Various Distribution Model

The combined standard uncertainty of the measurement result represents the estimated standard deviation of the result. It is obtained by combining the individual standard uncertainties of both Type A and Type B evaluation using the usual “root-sum-squares” (RSS) methods of combining standard deviations by taking the positive square root of the estimated variances.

Expanded uncertainty is a measure of uncertainty that defines an interval about the measurement result within which the measured value is confidently believed to lie. It is obtained by multiplying the combined standard uncertainty by a coverage factor. Typically, the coverage factor ranges from 2 to 3. Using a coverage factor allows the true value of a measured quantity to be specified with a defined probability within the specified uncertainty range. For purpose of this document, a coverage factor two is used, which corresponds to confidence interval of about 95 %. The DASY4 uncertainty Budget is showed in Table 7.2.



Error Description	Uncertainty Value	Probability Distribution	Divisor	Ci (1g)	Standard Unc. (1g)	vi or Veff
Measurement System						
Probe Calibration	±6.8 %	Normal	1	1	±6.8 %	∞
Axial Isotropy	±4.7 %	Rectangular	√3	0.7	±1.9 %	∞
Hemispherical Isotropy	±9.6 %	Rectangular	√3	0.7	±3.9 %	∞
Boundary Effect	±2.0 %	Rectangular	√3	1	±1.2 %	∞
Linearity	±4.7 %	Rectangular	√3	1	±2.7 %	∞
System Detection Limit	±1.0 %	Rectangular	√3	1	±0.6 %	∞
Readout Electronics	±0.3 %	Normal	1	1	±0.3 %	∞
Response Time	±0.8 %	Rectangular	√3	1	±0.5 %	∞
Integration Time	±2.6 %	Rectangular	√3	1	±1.5 %	∞
RF Ambient Noise	±3.0 %	Rectangular	√3	1	±1.7 %	∞
RF Ambient Reflections	±3.0 %	Rectangular	√3	1	±1.7 %	∞
Probe Positioner	±0.8 %	Rectangular	√3	1	±0.5 %	∞
Probe Positioning	±9.9 %	Rectangular	√3	1	±5.7 %	∞
Max. SAR Eval.	±4.0 %	Rectangular	√3	1	±2.3 %	∞
Test Sample Related						
Device Positioning	±2.9 %	Normal	1	1	±2.9 %	145
Device Holder	±3.6 %	Normal	1	1	±3.6 %	5
Power Drift	±5.0 %	Rectangular	√3	1	±2.9 %	∞
Phantom and Setup						
Phantom Uncertainty	±4.0 %	Rectangular	√3	1	±2.3 %	∞
Liquid Conductivity (target)	±5.0 %	Rectangular	√3	0.64	±1.8 %	∞
Liquid Conductivity (meas.)	±2.5 %	Normal	1	0.64	±1.6 %	∞
Liquid Permittivity (target)	±5.0 %	Rectangular	√3	0.6	±1.7 %	∞
Liquid Permittivity (meas.)	±2.5 %	Normal	1	0.6	±1.5 %	∞
Combined Std. Uncertainty					±12.9 %	330
Coverage Factor for 95%	Kp=2					
Expanded STD Uncertainty					±25.9 %	

Table 7.2 Uncertainty Budget of DASY4 for 5GHz Band

8. SAR Measurement Evaluation

Each DASY system is equipped with one or more system validation kits. These units, together with the predefined measurement procedures within the DASY software, enable the user to conduct the system performance check and system validation. System validation kit includes a dipole, tripod holder to fix it underneath the flat phantom and a corresponding distance holder.

8.1 Purpose of System Performance check

The system performance check verifies that the system operates within its specifications. System and operator errors can be detected and corrected. It is recommended that the system performance check be performed prior to any usage of the system in order to guarantee reproducible results. The system performance check uses normal SAR measurements in a simplified setup with a well characterized source. This setup was selected to give a high sensitivity to all parameters that might fail or vary over time. The system check does not intend to replace the calibration of the components, but indicates situations where the system uncertainty is exceeded due to drift or failure.

8.2 System Setup

In the simplified setup for system evaluation, the DUT is replaced by a calibrated dipole and the power source is replaced by a continuous wave which comes from a signal generator at frequency 5200 MHz. The calibrated dipole must be placed beneath the flat phantom section of the SAM twin phantom with the correct distance holder. The distance holder should touch the phantom surface with a light pressure at the reference marking and be oriented parallel to the long side of the phantom. The equipment setup is shown below:

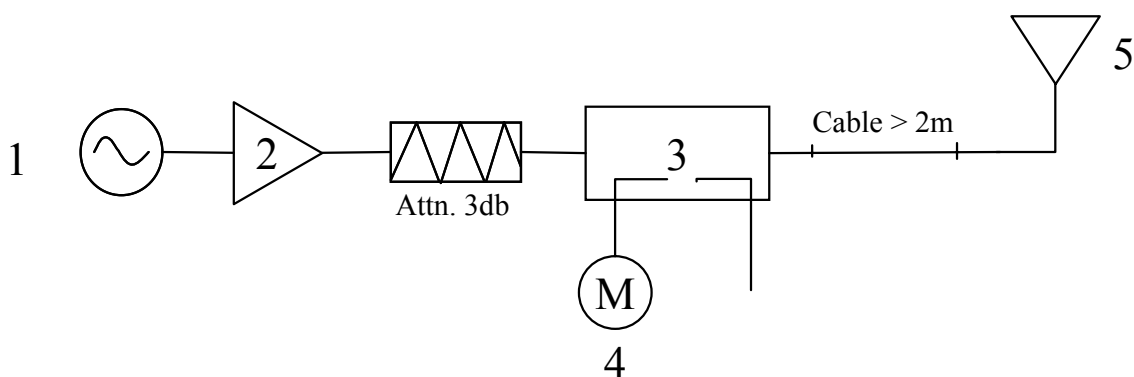

Fig. 8.1 System Setup for System Evaluation



1. Signal Generator
2. Amplifier
3. Directional Coupler
4. Power Meter
5. 5200 MHz Dipole

The output power on dipole port must be calibrated to 100 mW (20 dBm) before dipole is connected.



Fig 8.2 Dipole Setup



8.3 Validation Results

Comparing to the original SAR value provided by SPEAG, the validation data should be within its specification of 10 %. Table 8.1 shows the Target and Measured SAR After Normalization to 1W input power.

Band	SAR	Target (W/kg)	Measurement data (W/kg)	Variation	Measurement date
802.11a Band II (5200 MHz)	SAR (1g)	73.7	76.5	3.8 %	Aug. 17, 2007
	SAR (10g)	20.6	21.5	4.4 %	

Table 8.1 Target and Measured SAR After Normalization

The table above indicates the system performance check can meet the variation criterion.



9. Description for DUT Testing Position

This DUT was tested in the position “Notebook Bottom Touch”. The DUT faces to the phantom with 0 mm separation distance.

Remark: Please refer to Appendix E for the test setup photo.



10. Measurement Procedures

The measurement procedures are as follows:

- Using engineering software to transmit RF power continuously (continuous Tx) in the low channel
- Placing the DUT in the positions described in the last section
- Setting scan area, grid size and other setting on the DASY4 software
- Taking data for the low channel
- Repeat the previous steps for the middle and high channels.

According to the IEEE P1528 draft standard, the recommended procedure for assessing the peak spatial-average SAR value consists of the following steps:

- Power reference measurement
- Area scan
- Zoom scan
- Power reference measurement

10.1 Spatial Peak SAR Evaluation

The procedure for spatial peak SAR evaluation has been implemented according to the IEEE1528-2003 standard. It can be conducted for 1g and 10g, as well as for user-specific masses. The DASY4 software includes all numerical procedures necessary to evaluate the spatial peak SAR value.

Base on the Draft: SCC-34, SC-2, WG-2-Computational Dosimetry, P1528/D1.2 (Recommended Practice for Determining the Peak Spatial-Average Specific Absorption Rate (SAR) in the Human Head from Wireless Communications Devices: Measurement Techniques), a new algorithm has been implemented. The spatial-peak SAR can be computed over any required mass.

The base for the evaluation is a "cube" measurement. The measured volume must include the 1g and 10g cubes with the highest averaged SAR values. For that purpose, the center of the measured volume is aligned to the interpolated peak SAR value of a previously performed area scan.



The entire evaluation of the spatial peak values is performed within the post-processing engine (SEMCAD). The system always gives the maximum values for the 1g and 10g cubes. The algorithm to find the cube with highest averaged SAR is divided into the following stages:

- extraction of the measured data (grid and values) from the Zoom Scan
- calculation of the SAR value at every measurement point based on all stored data (A/D values and measurement parameters)
- generation of a high-resolution mesh within the measured volume
- interpolation of all measured values from the measurement grid to the high-resolution grid
- extrapolation of the entire 3-D field distribution to the phantom surface over the distance from sensor to surface
- calculation of the averaged SAR within masses of 1g and 10g

10.2 Scan Procedures

First Area Scan is used to locate the approximate location(s) of the local peak SAR value(s). The measurement grid within an Area Scan is defined by the grid extent, grid step size and grid offset. Next, in order to determine the EM field distribution in a three-dimensional spatial extension, Zoom Scan is required. The Zoom Scan measures 5x5x7 points with step size 8, 8 and 5 mm for 2.45GHz Band and 8x8x8 points with step size 4.3, 4.3 and 3 mm for 5GHz Band. The Zoom Scan is performed around the highest E-field value to determine the averaged SAR-distribution over 1 g.

10.3 SAR Averaged Methods

In DASY4, the interpolation and extrapolation are both based on the modified Quadratic Shepard's method. The interpolation scheme combines a least-square fitted function method and a weighted average method which are the two basic types of computational interpolation and approximation.

Extrapolation routines are used to obtain SAR values between the lowest measurement points and the inner phantom surface. The extrapolation distance is determined by the surface detection distance and the probe sensor offset. The uncertainty increases with the extrapolation distance. To keep the uncertainty within 1% for the 1 g and 10 g cubes, the extrapolation distance should not be larger than 5 mm.



11. SAR Test Results

11.1 Notebook Bottom Touch with Main Antenna

Mode	Chan.	Freq (MHz)	Modulation type	Conducted Power (dBm)	Power Drift (dB)	Measured 1g SAR (W/kg)	Limits (W/Kg)	Results
802.11a <Band II>	52	5260(Low)	OFDM	15.07	-0.121	0.24	1.6	Pass
	56	5280(Mid)	OFDM	14.62	-0.123	0.174	1.6	Pass
	60	5300(High)	OFDM	14.17	-0.133	0.144	1.6	Pass
802.11a <Band II> with BT On	52	5260(Low)	OFDM	15.07	-0.126	0.241	1.6	Pass

11.2 Notebook Bottom Touch with Aux. Antenna

Mode	Chan.	Freq (MHz)	Modulation type	Conducted Power (dBm)	Power Drift (dB)	Measured 1g SAR (W/kg)	Limits (W/Kg)	Results
802.11a <Band II>	52	5260(Low)	OFDM	15.07	-	-	-	-
	56	5280(Mid)	OFDM	14.62	0.147	0.026	1.6	Pass
	60	5300(High)	OFDM	14.17	-	-	-	-

Test Engineer : John Tsai, Eric Huang and Jsaon Wang



12. Reference

- [1] FCC 47 CFR Part 2 “Frequency Allocations and Radio Treaty Matters; General Rules and Regulations”
- [2] IEEE Std. P1528-2003, “Recommended Practice for Determining the Peak Spatial-Average Specific Absorption Rate (SAR) in the Human Head from Wireless Communications Devices: Measurement Techniques”, April 21,2003.
- [3] Supplement C (Edition 01-01) to OET Bulletin 65 (Edition 97-01), “Additional Information for Evaluating Compliance of Mobile and Portable Devices with FCC Limits for Human Exposure to RF Emissions”, June 2001
- [4] IEEE Std. C95.3-2002, “IEEE Recommended Practice for the Measurement of Potentially Hazardous Electromagnetic Fields-RF and Microwave”, 2002
- [5] IEEE Std. C95.1-1999, “IEEE Standard for Safety Levels with Respect to Human Exposure to Radio Frequency Electromagnetic Fields, 3 kHz to 300 GHz”, 1999
- [6] Robert J. Renka, “Multivariate Interpolation Of Large Sets Of Scattered Data”, University of North Texas ACM Transactions on Mathematical Software, vol. 14, no. 2, June 1988, pp. 139-148
- [7] DAYS4 System Handbook



Appendix A - System Performance Check Data

Test Laboratory: Sporton International Inc. SAR Testing Lab

Date : 2007/8/17

System Check_Body_5200MHz

DUT: Dipole 5GHz

Communication System: CW; Frequency: 5200 MHz; Duty Cycle: 1:1

Medium: MSL_5G Medium parameters used: $f = 5200$ MHz; $\sigma = 5.19$ mho/m; $\epsilon_r = 48.5$; $\rho = 1000$ kg/m³

Ambient Temperature : 23.1 °C; Liquid Temperature : 21.8 °C

DASY4 Configuration:

- Probe: EX3DV3 - SN3514; ConvF(4.31, 4.31, 4.31); Calibrated: 2007/2/21
- Sensor-Surface: 2mm (Mechanical Surface Detection)
- Electronics: DAE3 Sn577; Calibrated: 2006/11/21
- Phantom: SAM-A; Type: QD 000 P40 C; Serial: TP-1303
- Measurement SW: DASY4, V4.7 Build 53; Postprocessing SW: SEMCAD, V1.8 Build 172

Pin=100mW/Area Scan (91x91x1): Measurement grid: dx=10mm, dy=10mm

Maximum value of SAR (interpolated) = 10.4 mW/g

Pin=100mW/Zoom Scan (8x8x8)/Cube 0: Measurement grid: dx=4.3mm, dy=4.3mm, dz=3mm

Reference Value = 45.7 V/m; Power Drift = -0.012 dB

Peak SAR (extrapolated) = 31.2 W/kg

SAR(1 g) = 7.65 mW/g; SAR(10 g) = 2.15 mW/g

Maximum value of SAR (measured) = 9.56 mW/g

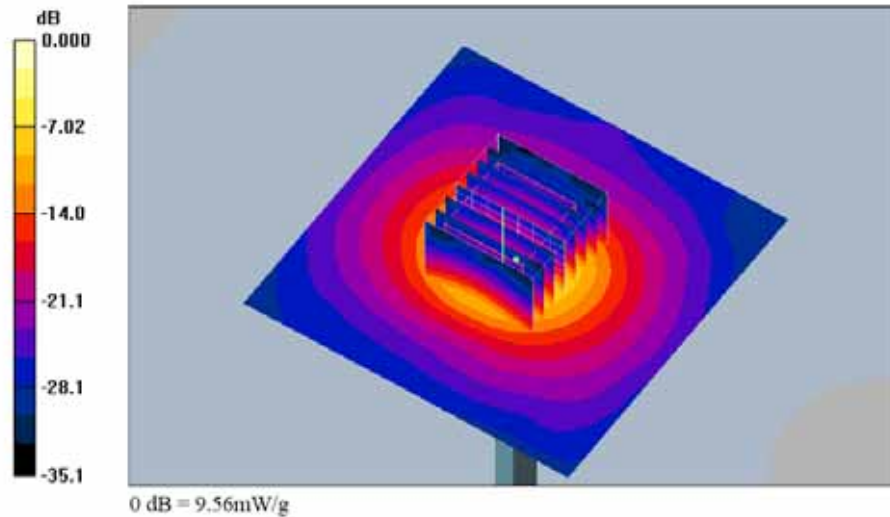



Appendix B - SAR Measurement Data

Test Laboratory: Sporton International Inc. SAR Testing Lab Date: 2007/8/17

Body_802.11a Ch52_Notebook Bottom Touch_Main Ant

DUT: 6O2516-04

Communication System: 802.11a; Frequency: 5260 MHz; Duty Cycle: 1:1
Medium: MSL_5G Medium parameters used: $f = 5260$ MHz; $\sigma = 5.26$ mho/m; $\epsilon_r = 48.4$; $\rho = 1000$ kg/m³
Ambient Temperature : 23.1 °C; Liquid Temperature : 21.8 °C

DASY4 Configuration:

- Probe: EX3DV3 - SN3514; ConvF(4.31, 4.31, 4.31); Calibrated: 2007/2/21
- Sensor-Surface: 2mm (Mechanical Surface Detection)
- Electronics: DAE3 Sn577; Calibrated: 2006/11/21
- Phantom: SAM-A; Type: QD 000 P40 C; Serial: TP-1303
- Measurement SW: DASY4, V4.7 Build 53; Postprocessing SW: SEMCAD, V1.8 Build 172

Ch52/Area Scan (141x261x1): Measurement grid: dx=10mm, dy=10mm
Maximum value of SAR (interpolated) = 0.309 mW/g

Ch52/Zoom Scan (8x8x8)/Cube 0: Measurement grid: dx=4.3mm, dy=4.3mm, dz=3mm
Reference Value = 7.24 V/m; Power Drift = -0.121 dB
Peak SAR (extrapolated) = 0.267 W/kg
SAR(1 g) = 0.240 mW/g; SAR(10 g) = 0.226 mW/g
Maximum value of SAR (measured) = 0.267 mW/g

Ch52/Zoom Scan (8x8x8)/Cube 1: Measurement grid: dx=4.3mm, dy=4.3mm, dz=3mm
Reference Value = 7.24 V/m; Power Drift = -0.121 dB
Peak SAR (extrapolated) = 0.232 W/kg
SAR(1 g) = 0.201 mW/g; SAR(10 g) = 0.194 mW/g
Maximum value of SAR (measured) = 0.232 mW/g

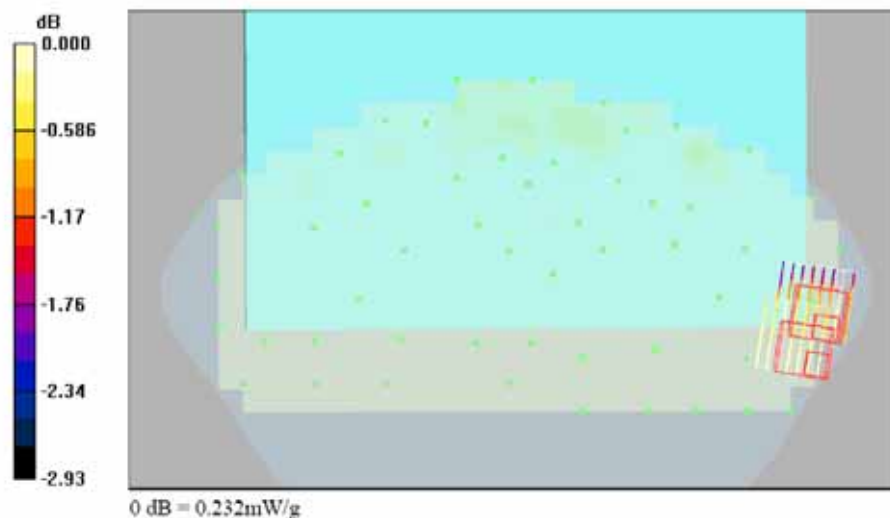



Test Laboratory: Sporton International Inc. SAR Testing Lab

Date: 2007/8/17

Body_802.11a_Ch56_Notebook Bottom Touch_Aux Ant

DUT: 6O2516-04

Communication System: 802.11a; Frequency: 5280 MHz; Duty Cycle: 1:1

Medium: MSL_5G Medium parameters used: $f = 5280$ MHz; $\sigma = 5.28$ mho/m; $\epsilon_r = 48.4$; $\rho = 1000$ kg/m³

Ambient Temperature : 23.1 °C; Liquid Temperature : 21.8 °C

DASY4 Configuration:

- Probe: EX3DV3 - SN3514; ConvF(4.31, 4.31, 4.31); Calibrated: 2007/2/21
- Sensor-Surface: 2mm (Mechanical Surface Detection)
- Electronics: DAE3 Sn577; Calibrated: 2006/11/21
- Phantom: SAM-A; Type: QD 000 P40 C; Serial: TP-1303
- Measurement SW: DASY4, V4.7 Build 53; Postprocessing SW: SEMCAD, V1.8 Build 172

Ch56/Area Scan (141x261x1): Measurement grid: dx=10mm, dy=10mm

Maximum value of SAR (interpolated) = 0.033 mW/g

Ch56/Zoom Scan (8x8x8)/Cube 0: Measurement grid: dx=4.3mm, dy=4.3mm, dz=3mm

Reference Value = 1.26 V/m; Power Drift = 2.97 dB

Peak SAR (extrapolated) = 0.028 W/kg

SAR(1 g) = 0.023 mW/g; SAR(10 g) = 0.020 mW/g

Maximum value of SAR (measured) = 0.028 mW/g

Ch56/Zoom Scan (8x8x8)/Cube 1: Measurement grid: dx=4.3mm, dy=4.3mm, dz=3mm

Reference Value = 1.26 V/m; Power Drift = 0.147 dB

Peak SAR (extrapolated) = 0.043 W/kg

SAR(1 g) = 0.026 mW/g; SAR(10 g) = 0.022 mW/g

Maximum value of SAR (measured) = 0.043 mW/g

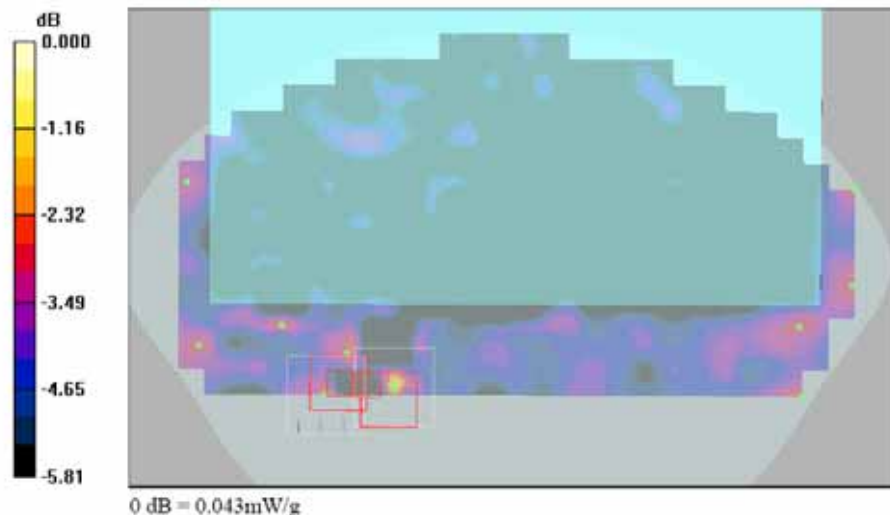



Test Laboratory: Sporton International Inc. SAR Testing Lab

Date: 2007/8/17

Body_802.11a_Ch52_Notebook_Bottom_Touch_Main_Ant_Bluetooth_On

DUT: 6O2516-04

Communication System: 802.11a; Frequency: 5260 MHz; Duty Cycle: 1:1

Medium: MSL_5G Medium parameters used: $f = 5260$ MHz; $\sigma = 5.26$ mho/m; $\epsilon_r = 48.4$; $\rho = 1000$ kg/m³

Ambient Temperature : 23.1 °C; Liquid Temperature : 21.8 °C

DASY4 Configuration:

- Probe: EX3DV3 - SN3514; ConvF(4.31, 4.31, 4.31); Calibrated: 2007/2/21
- Sensor-Surface: 2mm (Mechanical Surface Detection)
- Electronics: DAE3 Sn577; Calibrated: 2006/11/21
- Phantom: SAM-A; Type: QD 000 P40 C; Serial: TP-1303
- Measurement SW: DASY4, V4.7 Build 53; Postprocessing SW: SEMCAD, V1.8 Build 172

Ch52/Area Scan (141x261x1): Measurement grid: dx=10mm, dy=10mm

Maximum value of SAR (interpolated) = 0.278 mW/g

Ch52/Zoom Scan (8x8x8)/Cube 0: Measurement grid: dx=4.3mm, dy=4.3mm, dz=3mm

Reference Value = 7.24 V/m; Power Drift = -0.126 dB

Peak SAR (extrapolated) = 0.284 W/kg

SAR(1 g) = 0.241 mW/g; SAR(10 g) = 0.223 mW/g

Maximum value of SAR (measured) = 0.284 mW/g

Ch52/Zoom Scan (8x8x8)/Cube 2: Measurement grid: dx=4.3mm, dy=4.3mm, dz=3mm

Reference Value = 7.24 V/m; Power Drift = -0.126 dB

Peak SAR (extrapolated) = 0.267 W/kg

SAR(1 g) = 0.235 mW/g; SAR(10 g) = 0.227 mW/g

Maximum value of SAR (measured) = 0.267 mW/g





Test Laboratory: Sporton International Inc. SAR Testing Lab

Date: 2007/8/17

Body_802.11a_Ch52_Notebook Bottom Touch_Main Ant_Bluetooth On_2D

DUT: 6O2516-04

Communication System: 802.11a; Frequency: 5260 MHz; Duty Cycle: 1:1
Medium: MSL_5G Medium parameters used: $f = 5260$ MHz; $\sigma = 5.26$ mho/m; $\epsilon_r = 48.4$; $\rho = 1000$ kg/m³
Ambient Temperature : 23.1 °C; Liquid Temperature : 21.8 °C

DASY4 Configuration:

- Probe: EX3DV3 - SN3514; ConvF(4.31, 4.31, 4.31); Calibrated: 2007/2/21
- Sensor-Surface: 2mm (Mechanical Surface Detection)
- Electronics: DAE3 Sn577; Calibrated: 2006/11/21
- Phantom: SAM-A; Type: QD 000 P40 C; Serial: TP-1303
- Measurement SW: DASY4, V4.7 Build 53; Postprocessing SW: SEMCAD, V1.8 Build 172

Ch52/Area Scan (141x261x1): Measurement grid: dx=10mm, dy=10mm

Maximum value of SAR (interpolated) = 0.278 mW/g

Ch52/Zoom Scan (8x8x8)/Cube 0: Measurement grid: dx=4.3mm, dy=4.3mm, dz=3mm

Reference Value = 7.24 V/m; Power Drift = -0.126 dB

Peak SAR (extrapolated) = 0.284 W/kg

SAR(1 g) = 0.241 mW/g; SAR(10 g) = 0.223 mW/g

Maximum value of SAR (measured) = 0.284 mW/g

Ch52/Zoom Scan (8x8x8)/Cube 2: Measurement grid: dx=4.3mm, dy=4.3mm, dz=3mm

Reference Value = 7.24 V/m; Power Drift = -0.126 dB

Peak SAR (extrapolated) = 0.267 W/kg

SAR(1 g) = 0.235 mW/g; SAR(10 g) = 0.227 mW/g

Maximum value of SAR (measured) = 0.267 mW/g

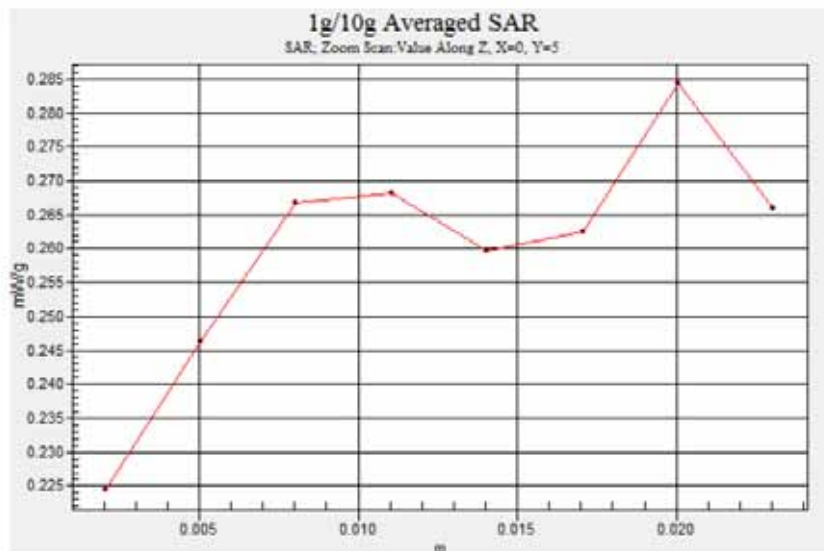



Appendix C – Calibration Data

Calibration Laboratory of Schmid & Partner Engineering AG Zeughausstrasse 43, 8004 Zurich, Switzerland



S Schweizerischer Kalibrierdienst
C Service suisse d'étalonnage
S Servizio svizzero di taratura
S Swiss Calibration Service

Accredited by the Swiss Federal Office of Metrology and Accreditation The Swiss Accreditation Service is one of the signatories to the EA Multilateral Agreement for the recognition of calibration certificates

Accreditation No.: SCS 108

Client Sporton (Auden)

Certificate No: D5GHzV2-1006_Feb06

CALIBRATION CERTIFICATE

Object D5GHzV2 - SN: 1006

Calibration procedure(s) QA CAL-22.v1 Calibration procedure for dipole validation kits between 3-6 GHz

Calibration date: February 10, 2006

Condition of the calibrated item In Tolerance

This calibration certificate documents the traceability to national standards, which realize the physical units of measurements (SI). The measurements and the uncertainties with confidence probability are given on the following pages and are part of the certificate.

All calibrations have been conducted in the closed laboratory facility: environment temperature (22 ± 3)°C and humidity < 70%.

Calibration Equipment used (M&TE critical for calibration)

Table with 4 columns: Primary Standards, ID #, Cal Date (Calibrated by, Certificate No.), Scheduled Calibration. Rows include Power meter E4419B, Power sensor E4412A, Reference 20 dB Attenuator, Reference 10 dB Attenuator, Reference Probe EX3DV4, DAE4.

Table with 4 columns: Secondary Standards, ID #, Check Date (in house), Scheduled Check. Rows include Power sensor HP 8481A, Power meter E4419B, RF generator R&S SMT-06, Network Analyzer HP 8753E.

Calibrated by: Name Katja Pokovic, Function Technical Manager, Signature [Handwritten]

Approved by: Name Niels Kuster, Quality Manager, Signature [Handwritten]

Issued: February 17, 2006

This calibration certificate shall not be reproduced except in full without written approval of the laboratory.



Calibration Laboratory of
Schmid & Partner
Engineering AG
Zeughausstrasse 43, 8004 Zurich, Switzerland



S Schweizerischer Kalibrierdienst
C Service suisse d'étalonnage
S Servizio svizzero di taratura
S Swiss Calibration Service

Accredited by the Swiss Federal Office of Metrology and Accreditation
The Swiss Accreditation Service is one of the signatories to the EA
Multilateral Agreement for the recognition of calibration certificates

Accreditation No.: SCS 108

Glossary:

TSL tissue simulating liquid
ConvF sensitivity in TSL / NORM x,y,z
N/A not applicable or not measured

Calibration is Performed According to the Following Standards:

- a) IEC Std 62209 Part 2, "Evaluation of Human Exposure to Radio Frequency Fields from Handheld and Body-Mounted Wireless Communication Devices in the Frequency Range of 30 MHz to 6 GHz: Human models, Instrumentation, and Procedures"; Part 2: "Procedure to determine the Specific Absorption Rate (SAR) for including accessories and multiple transmitters", Draft Version 0.9, December 2004
- b) Federal Communications Commission Office of Engineering & Technology (FCC OET), "Evaluating Compliance with FCC Guidelines for Human Exposure to Radiofrequency Electromagnetic Fields; Additional Information for Evaluating Compliance of Mobile and Portable Devices with FCC Limits for Human Exposure to Radiofrequency Emissions", Supplement C (Edition 01-01) to Bulletin 65

Additional Documentation:

- c) DASY4 System Handbook

Methods Applied and Interpretation of Parameters:

- *Measurement Conditions:* Further details are available from the Validation Report at the end of the certificate. All figures stated in the certificate are valid at the frequency indicated.
- *Antenna Parameters with TSL:* The dipole is mounted with the spacer to position its feed point exactly below the center marking of the flat phantom section, with the arms oriented parallel to the body axis.
- *Feed Point Impedance and Return Loss:* These parameters are measured with the dipole positioned under the liquid filled phantom. The impedance stated is transformed from the measurement at the SMA connector to the feed point. The Return Loss ensures low reflected power. No uncertainty required.
- *Electrical Delay:* One-way delay between the SMA connector and the antenna feed point. No uncertainty required.
- *SAR measured:* SAR measured at the stated antenna input power.
- *SAR normalized:* SAR as measured, normalized to an input power of 1 W at the antenna connector.
- *SAR for nominal TSL parameters:* The measured TSL parameters are used to calculate the nominal SAR result.



Measurement Conditions

DASY system configuration, as far as not given on page 1.

DASY Version	DASY4	V4.6
Extrapolation	Advanced Extrapolation	
Phantom	Modular Flat Phantom V5.0	
Distance Dipole Center - TSL	10 mm	with Spacer
Area Scan resolution	dx, dy = 10 mm	
Zoom Scan Resolution	dx, dy = 4.3 mm, dz = 3 mm	
Frequency	5200 MHz ± 1 MHz 5500 MHz ± 1 MHz 5800 MHz ± 1 MHz	

Body TSL parameters at 5200 MHz

The following parameters and calculations were applied.

	Temperature	Permittivity	Conductivity
Nominal Body TSL parameters	22.0 °C	49.0	5.30 mho/m
Measured Body TSL parameters	(22.0 ± 0.2) °C	49.1 ± 6 %	5.11 mho/m ± 6 %
Body TSL temperature during test	(22.0 ± 0.2) °C	----	----

SAR result with Body TSL at 5200 MHz

SAR averaged over 1 cm ³ (1 g) of Body TSL	condition	
SAR measured	250 mW input power	1840 mW / g
SAR normalized	normalized to 1W	73.6 mW / g
SAR for nominal Body TSL parameters ¹	normalized to 1W	73.7 mW / g ± 19.9 % (k=2)

SAR averaged over 10 cm ³ (10 g) of Body TSL	condition	
SAR measured	250 mW input power	5.16 mW / g
SAR normalized	normalized to 1W	20.6 mW / g
SAR for nominal Body TSL parameters ¹	normalized to 1W	20.6 mW / g ± 19.5 % (k=2)



Body TSL parameters at 5500 MHz

The following parameters and calculations were applied.

	Temperature	Permittivity	Conductivity
Nominal Body TSL parameters	22.0 °C	48.6	5.65 mho/m
Measured Body TSL parameters	(22.0 ± 0.2) °C	48.4 ± 6 %	5.50 mho/m ± 6 %
Body TSL temperature during test	(22.0 ± 0.2) °C	----	----

SAR result with Body TSL at 5500 MHz

SAR averaged over 1 cm ³ (1 g) of Body TSL	condition	
SAR measured	250 mW input power	18.8 mW / g
SAR normalized	normalized to 1W	75.2 mW / g
SAR for nominal Body TSL parameters ¹	normalized to 1W	75.0 mW / g ± 19.9 % (k=2)

SAR averaged over 10 cm ³ (10 g) of Body TSL	condition	
SAR measured	250 mW input power	5.26 mW / g
SAR normalized	normalized to 1W	21.0 mW / g
SAR for nominal Body TSL parameters ¹	normalized to 1W	21.0 mW / g ± 19.5 % (k=2)

Body TSL parameters at 5800 MHz

The following parameters and calculations were applied.

	Temperature	Permittivity	Conductivity
Nominal Body TSL parameters	22.0 °C	48.2	6.00 mho/m
Measured Body TSL parameters	(22.0 ± 0.2) °C	47.8 ± 6 %	5.88 mho/m ± 6 %
Body TSL temperature during test	(22.0 ± 0.2) °C	----	----

SAR result with Body TSL at 5800 MHz

SAR averaged over 1 cm ³ (1 g) of Body TSL	condition	
SAR measured	250 mW input power	17.5 mW / g
SAR normalized	normalized to 1W	70.0 mW / g
SAR for nominal Body TSL parameters ¹	normalized to 1W	69.8 mW / g ± 19.9 % (k=2)

SAR averaged over 10 cm ³ (10 g) of Body TSL	condition	
SAR measured	250 mW input power	4.94 mW / g
SAR normalized	normalized to 1W	19.8 mW / g
SAR for nominal Body TSL parameters ¹	normalized to 1W	19.7 mW / g ± 19.5 % (k=2)



Appendix

Antenna Parameters with Body TSL at 5200 MHz

Impedance, transformed to feed point	48.3 Ω - 2.2j Ω
Return Loss	-31.1 dB

Antenna Parameters with Body TSL at 5500 MHz

Impedance, transformed to feed point	54.1 Ω - 9.4j Ω
Return Loss	-20.1 dB

Antenna Parameters with Body TSL at 5800 MHz

Impedance, transformed to feed point	56.3 Ω + 8.3j Ω
Return Loss	-20.1 dB

General Antenna Parameters and Design

Electrical Delay (one direction)	1.202 ns
----------------------------------	----------

After long term use with 40 W radiated power, only a slight warming of the dipole near the feedpoint can be measured.

The dipole is made of standard semirigid coaxial cable. The center conductor of the feeding line is directly connected to the second arm of the dipole. The antenna is therefore short-circuited for DC-signals.

No excessive force must be applied to the dipole arms, because they might bend or the soldered connections near the feedpoint may be damaged.

Additional EUT Data

Manufactured by	SPEAG
Manufactured on	August 28, 2003



DASY4 Validation Report for Body TSL

Date/Time: 10.02.2006 21:06:10

Test Laboratory: SPEAG, Zurich, Switzerland

DUT: Dipole 5GHz; Type: D5GHz; Serial: D5GHzV2 - SN:1006

Communication System: CW-5GHz; Frequency: 5800 MHz Frequency: 5500 MHz Frequency: 5200 MHz;
Duty Cycle: 1:1

Medium: MSL 5800 MHz;

Medium parameters used: $f = 5800$ MHz; $\sigma = 5.88$ mho/m; $\epsilon_r = 47.8$; $\rho = 1000$ kg/m³ Medium parameters

used: $f = 5500$ MHz; $\sigma = 5.5$ mho/m; $\epsilon_r = 48.4$; $\rho = 1000$ kg/m³ Medium parameters used: $f = 5200$ MHz; $\sigma = 5.11$ mho/m; $\epsilon_r = 49.1$; $\rho = 1000$ kg/m³

Phantom section: Flat Section

Measurement Standard: DASY4 (High Precision Assessment)

DASY4 Configuration:

- Probe: EX3DV4 - SN3503; ConvF(4.69, 4.69, 4.69)ConvF(4.78, 4.78, 4.78)ConvF(5.18, 5.18, 5.18); Calibrated: 19.03.2005
- Sensor-Surface: 2mm (Mechanical Surface Detection)
- Electronics: DAE4 Sn601; Calibrated: 15.12.2005
- Phantom: Flat Phantom 5.0 (back); Type: QD000P50AA
- Measurement SW: DASY4, V4.6 Build 47; Postprocessing SW: SEMCAD, V1.8 Build 160

d=10mm, Pin=250mW, f=5200 MHz/Zoom Scan (8x8x8), dist=2mm (8x8x8)/Cube 0:

Measurement grid: dx=4.3mm, dy=4.3mm, dz=3mm

Reference Value = 77.8 V/m; Power Drift = -0.025 dB

Peak SAR (extrapolated) = 65.4 W/kg

SAR(1 g) = 18.4 mW/g; SAR(10 g) = 5.16 mW/g

Maximum value of SAR (measured) = 37.8 mW/g

d=10mm, Pin=250mW, f=5500 MHz/Zoom Scan (8x8x8), dist=2mm (8x8x8)/Cube 0:

Measurement grid: dx=4.3mm, dy=4.3mm, dz=3mm

Reference Value = 73.9 V/m; Power Drift = 0.003 dB

Peak SAR (extrapolated) = 72.9 W/kg

SAR(1 g) = 18.8 mW/g; SAR(10 g) = 5.26 mW/g

Maximum value of SAR (measured) = 39.6 mW/g

d=10mm, Pin=250mW, f=5800 MHz/Zoom Scan (8x8x8), dist=2mm (8x8x8)/Cube 0:

Measurement grid: dx=4.3mm, dy=4.3mm, dz=3mm

Reference Value = 69.5 V/m; Power Drift = -0.024 dB

Peak SAR (extrapolated) = 70.0 W/kg

SAR(1 g) = 17.5 mW/g; SAR(10 g) = 4.94 mW/g

Maximum value of SAR (measured) = 36.7 mW/g



Impedance Measurement Plot for Body TSL

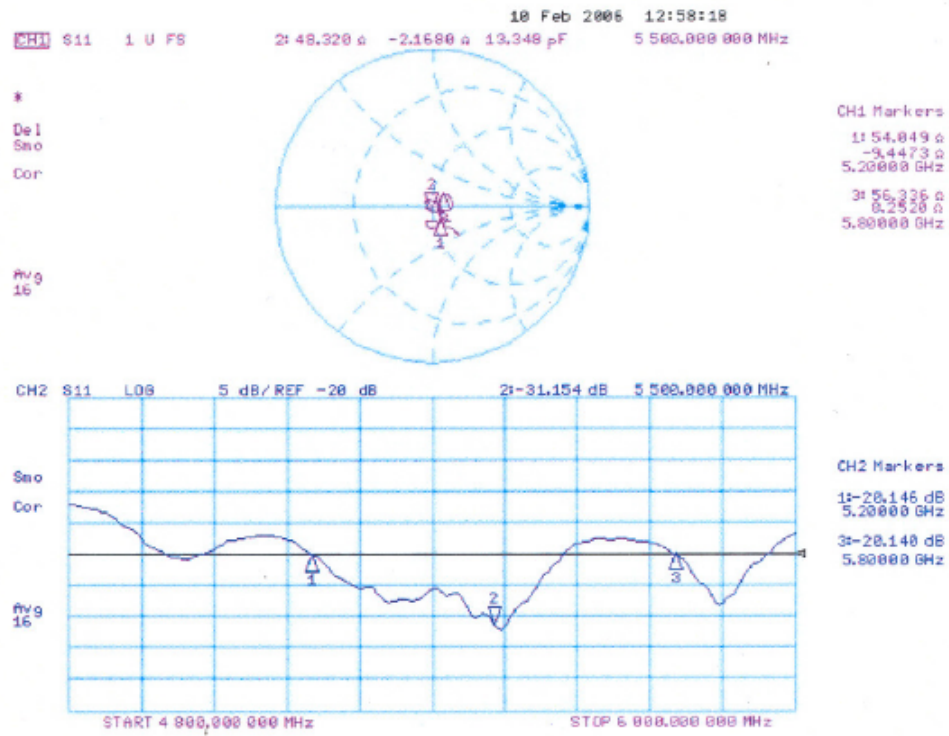



Calibration Laboratory of Schmid & Partner Engineering AG



S Schweizerischer Kalibrierdienst
C Service suisse d'etalonnage
S Servizio svizzero di taratura
S Swiss Calibration Service

Accredited by the Swiss Federal Office of Metrology and Accreditation
The Swiss Accreditation Service is one of the signatories to the EA Multilateral Agreement for the recognition of calibration certificates

Accreditation No.: SCS 108

Client Sporton (Auden)

Certificate No: EX3-3514_Feb07

CALIBRATION CERTIFICATE

Object: EX3DV3 - SN:3514
Calibration procedure(s): QA CAL-01.v5 and QA CAL-14.v3
Calibration procedure for dosimetric E-field probes
Calibration date: February 21, 2007
Condition of the calibrated item: In Tolerance

This calibration certificate documents the traceability to national standards, which realize the physical units of measurements (SI). The measurements and the uncertainties with confidence probability are given on the following pages and are part of the certificate.

All calibrations have been conducted in the closed laboratory facility; environment temperature (22 ± 3)°C and humidity < 70%.

Calibration Equipment used (M&TE:optical for calibration)

Table with 4 columns: Primary Standards, ID #, Cal Date (Calibrated by, Certificate No.), Scheduled Calibration. Lists various power meters, sensors, and attenuators with their respective IDs and calibration dates.

Table with 4 columns: Secondary Standards, ID #, Check Date (in house), Scheduled Check. Lists RF generator and Network Analyzer with their IDs and check dates.

Calibrated by: Krnja Polovic, Technical Manager
Approved by: Nils Kuster, Quality Manager

Issued: February 22, 2007

This calibration certificate shall not be reproduced except in full without written approval of the laboratory.



Calibration Laboratory of
Schmid & Partner
Engineering AG
Zaughausstrasse 43, 8004 Zurich, Switzerland



S Schweizerischer Kalibrierdienst
C Service suisse d'étalonnage
S Servizio svizzero di taratura
S Swiss Calibration Service

Accredited by the Swiss Federal Office of Metrology and Accreditation
The Swiss Accreditation Service is one of the signatories to the EA
Multilateral Agreement for the recognition of calibration certificates

Accreditation No.: SCS 108

Glossary:

TSL	tissue simulating liquid
NORM _{x,y,z}	sensitivity in free space
ConF	sensitivity in TSL / NORM _{x,y,z}
DCP	diode compression point
Polarization φ	φ rotation around probe axis
Polarization ϑ	ϑ rotation around an axis that is in the plane normal to probe axis (at measurement center), i.e., $\vartheta = 0$ is normal to probe axis

Calibration is Performed According to the Following Standards:

- a) IEEE Std 1528-2003, "IEEE Recommended Practice for Determining the Peak Spatial-Averaged Specific Absorption Rate (SAR) in the Human Head from Wireless Communications Devices: Measurement Techniques", December 2003
- b) CENELEC EN 50381, "Basic standard for the measurement of Specific Absorption Rate related to human exposure to electromagnetic fields from mobile phones (300 MHz - 3 GHz), July 2001

Methods Applied and Interpretation of Parameters:

- **NORM_{x,y,z}**: Assessed for E-field polarization $\vartheta = 0$ ($f \leq 900$ MHz in TEM-cell; $f > 1800$ MHz: R22 waveguide). NORM_{x,y,z} are only intermediate values, i.e., the uncertainties of NORM_{x,y,z} does not effect the E²-field uncertainty inside TSL (see below *ConvF*).
- **NORM(f)_{x,y,z}** = NORM_{x,y,z} * *frequency_response* (see Frequency Response Chart). This linearization is implemented in DASY4 software versions later than 4.2. The uncertainty of the frequency response is included in the stated uncertainty of *ConvF*.
- **DCP_{x,y,z}**: DCP are numerical linearization parameters assessed based on the data of power sweep (no uncertainty required). DCP does not depend on frequency nor media.
- **ConvF and Boundary Effect Parameters**: Assessed in flat phantom using E-field (or Temperature Transfer Standard for $f \leq 800$ MHz) and inside waveguide using analytical field distributions based on power measurements for $f > 800$ MHz. The same setups are used for assessment of the parameters applied for boundary compensation (alpha, depth) of which typical uncertainty values are given. These parameters are used in DASY4 software to improve probe accuracy close to the boundary. The sensitivity in TSL corresponds to NORM_{x,y,z} * *ConvF* whereby the uncertainty corresponds to that given for *ConvF*. A frequency dependent *ConvF* is used in DASY version 4.4 and higher which allows extending the validity from ± 50 MHz to ± 100 MHz.
- **Spherical Isotropy (3D deviation from isotropy)**: in a field of low gradients realized using a flat phantom exposed by a patch antenna.
- **Sensor Offset**: The sensor offset corresponds to the offset of virtual measurement center from the probe tip (on probe axis). No tolerance required.



EX3DV3 SN:3514

February 21, 2007

Probe EX3DV3

SN:3514

Manufactured:	December 15, 2002
Last calibrated:	February 17, 2006
Recalibrated:	February 21, 2007

Calibrated for DASY Systems

(Note: non-compatible with DASY2 system!)



EX3DV3 SN:3514

February 21, 2007

DASY - Parameters of Probe: EX3DV3 SN:3514

Sensitivity in Free Space ^A			Diode Compression ^B	
NormX	0.660 ± 10.1%	μV/(V/m) ²	DCP X	95 mV
NormY	0.690 ± 10.1%	μV/(V/m) ²	DCP Y	93 mV
NormZ	0.570 ± 10.1%	μV/(V/m) ²	DCP Z	96 mV

Sensitivity in Tissue Simulating Liquid (Conversion Factors)

Please see Page 8.

Boundary Effect

TSL	5200 MHz	Typical SAR gradient: 25 % per mm		
	Sensor Center to Phantom Surface Distance		2.0 mm	3.0 mm
	SAR _{iso} [%]	Without Correction Algorithm	3.7	0.6
	SAR _{iso} [%]	With Correction Algorithm	0.0	0.0
TSL	5800 MHz	Typical SAR gradient: 30 % per mm		
	Sensor Center to Phantom Surface Distance		2.0 mm	3.0 mm
	SAR _{iso} [%]	Without Correction Algorithm	1.7	0.5
	SAR _{iso} [%]	With Correction Algorithm	0.0	0.0

Sensor Offset

Probe Tip to Sensor Center 1.0 mm

The reported uncertainty of measurement is stated as the standard uncertainty of measurement multiplied by the coverage factor k=2, which for a normal distribution corresponds to a coverage probability of approximately 95%.

^A The uncertainties of NormX,Y,Z do not affect the E²-field uncertainty inside TSL (see Page 8).

^B Numerical linearization parameter; uncertainty not required.



EX3DV3 SN:3514

February 21, 2007

Frequency Response of E-Field

(TEM-Cell:ifi110 EXX, Waveguide: R22)

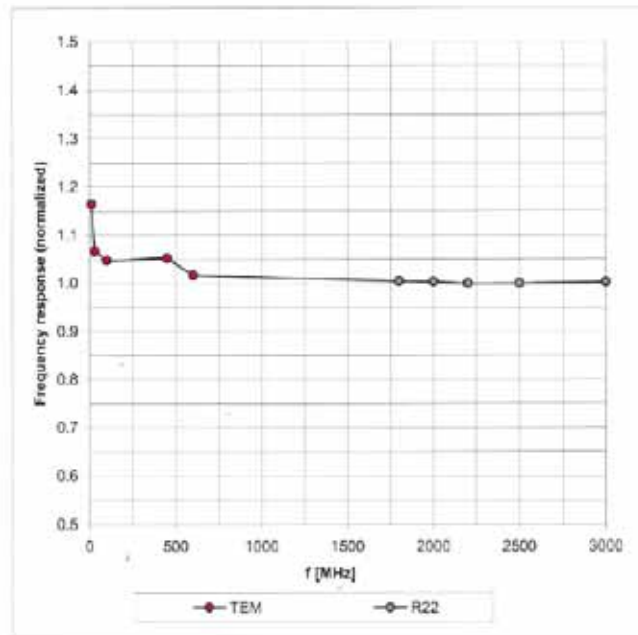

Uncertainty of Frequency Response of E-field: $\pm 5.3\%$ (k=2)



EX3DV3 SN:3514

February 21, 2007

Receiving Pattern (ϕ), $\vartheta = 0^\circ$

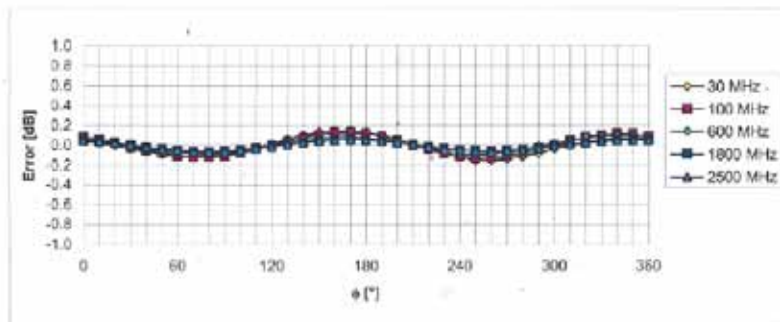
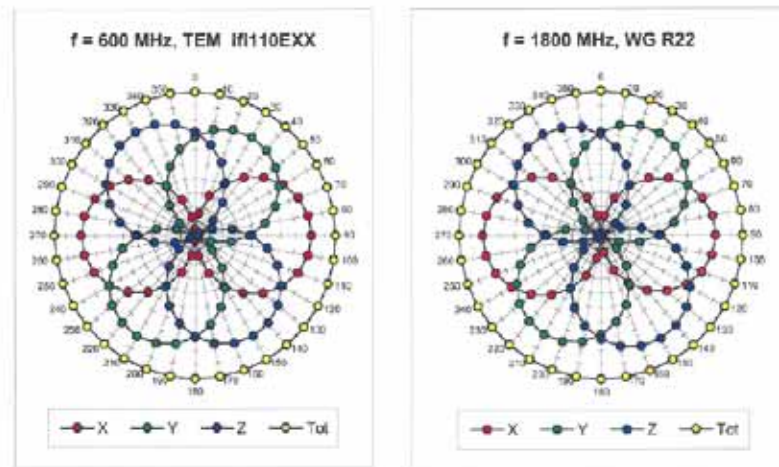

Uncertainty of Axial Isotropy Assessment: $\pm 0.5\%$ (k=2)



EX3DV3 SN:3514

February 21, 2007

Dynamic Range f(SAR_{head}) (Waveguide R22, f = 1800 MHz)

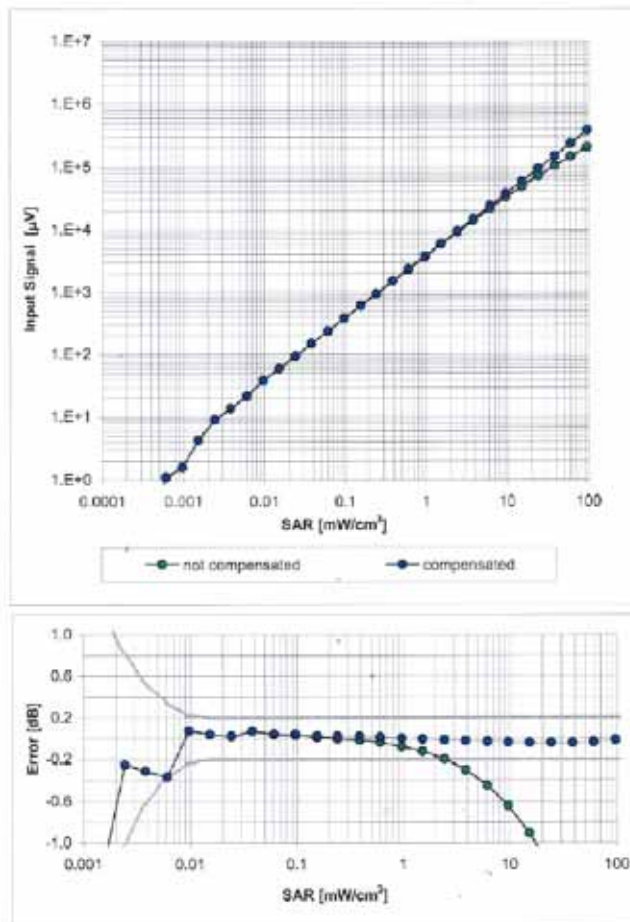

Uncertainty of Linearity Assessment: ± 0.6% (k=2)



EX3DV3 SN:3514

February 21, 2007

Conversion Factor Assessment

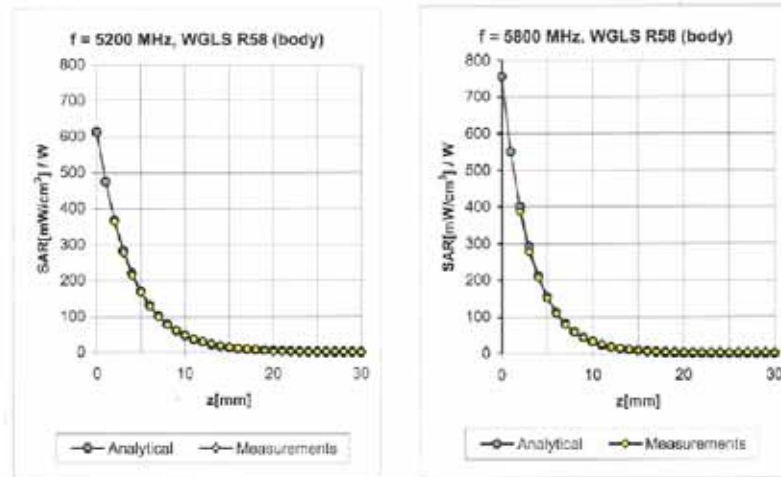

f [MHz]	Validity [MHz] ⁶	TSL	Permittivity	Conductivity	Alpha	Depth	ConvF Uncertainty
5200	± 50 / ± 100	Body	49.0 ± 5%	5.30 ± 5%	0.35	1.70	4.31 ± 13.1% (k=2)
5500	± 50 / ± 100	Body	49.6 ± 5%	5.65 ± 5%	0.35	1.70	4.09 ± 13.1% (k=2)
5800	± 50 / ± 100	Body	48.2 ± 5%	6.00 ± 5%	0.35	1.70	4.16 ± 13.1% (k=2)

⁶ The validity of ± 100 MHz only applies for DASy v6.4 and higher (see Page 2). The uncertainty is the RSS of the ConvF uncertainty at calibration frequency and the uncertainty for the indicated frequency band.



EX3DV3 SN:3514

February 21, 2007

Deviation from Isotropy in HSL Error (ϕ , θ), f = 900 MHz

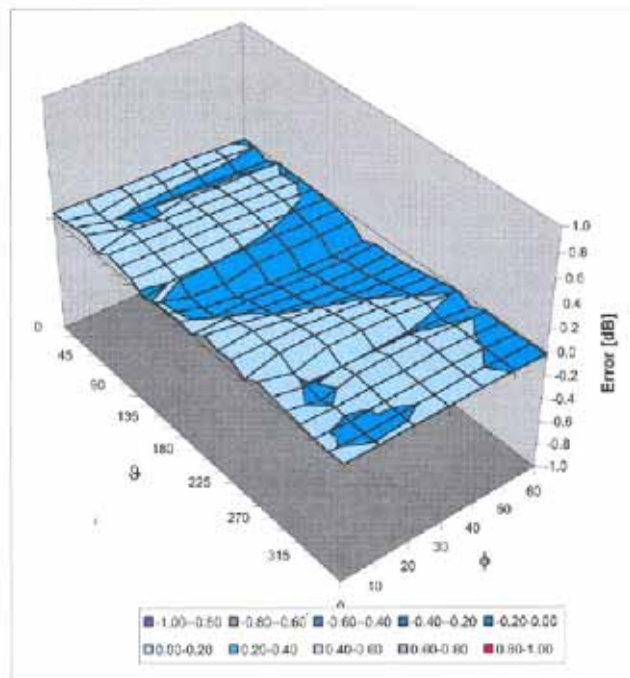

Uncertainty of Spherical Isotropy Assessment: $\pm 2.6\%$ (k=2)



Calibration Laboratory of
Schmid & Partner
Engineering AG
Zeughausstrasse 43, 8004 Zurich, Switzerland



S Schweizerischer Kalibrierdienst
S Service suisse d'étalonnage
S Servizio svizzero di taratura
S Swiss Calibration Service

Accredited by the Swiss Federal Office of Metrology and Accreditation
The Swiss Accreditation Service is one of the signatories to the EA
Multilateral Agreement for the recognition of calibration certificates

Accreditation No.: SCS 108

Client Sporton (Auden)

Certificate No: DAE3-577_Nov06

CALIBRATION CERTIFICATE

Object: DAE3 - SD 000 D03 AA - SN: 577

Calibration procedure(s): QA CAL-06.v12
Calibration procedure for the data acquisition electronics (DAE)

Calibration date: November 21, 2006

Condition of the calibrated item: In Tolerance

This calibration certificate documents the traceability to national standards, which realize the physical units of measurements (SI). The measurements and the uncertainties with confidence probability are given on the following pages and are part of the certificate.

All calibrations have been conducted in the closed laboratory facility; environment temperature (22 ± 3)°C and humidity < 70%.

Calibration Equipment used (M&TE critical for calibration)

Primary Standards	ID #	Cal Date (Calibrated by, Certificate No.)	Scheduled Calibration
Fluke Process Calibrator Type 702	SN: 6295303	13-Oct-06 (Elcal AG, No: 5492)	Oct-07
Kethley Multimeter Type 2001	SN: 0810278	03-Oct-06 (Elcal AG, No: 5478)	Oct-07
Secondary Standards	ID #	Check Date (in house)	Scheduled Check
Calibrator Box V1.1	SE UMS 006 AB 1002	15-Jun-06 (SPEAG, in house check)	In house check Jun-07

	Name	Function	Signature
Calibrated by:	Eric Hainfeld	Technician	
Approved by:	Fin Bornholt	R&D Director	

Issued: November 21, 2006

This calibration certificate shall not be reproduced except in full without written approval of the laboratory.



Calibration Laboratory of
Schmid & Partner
Engineering AG
Zeughausstrasse 43, 8004 Zurich, Switzerland



S Schweizerischer Kalibrierdienst
C Service suisse d'étalonnage
S Servizio svizzero di taratura
S Swiss Calibration Service

Accredited by the Swiss Federal Office of Metrology and Accreditation
The Swiss Accreditation Service is one of the signatories to the EA
Multilateral Agreement for the recognition of calibration certificates

Accreditation No.: SCS 108

Glossary

DAE data acquisition electronics
Connector angle information used in DASY system to align probe sensor X to the robot coordinate system.

Methods Applied and Interpretation of Parameters

- **DC Voltage Measurement:** Calibration Factor assessed for use in DASY system by comparison with a calibrated instrument traceable to national standards. The figure given corresponds to the full scale range of the voltmeter in the respective range.
- **Connector angle:** The angle of the connector is assessed measuring the angle mechanically by a tool inserted. Uncertainty is not required.
- The following parameters contain technical information as a result from the performance test and require no uncertainty.
- **DC Voltage Measurement Linearity:** Verification of the Linearity at +10% and -10% of the nominal calibration voltage. Influence of offset voltage is included in this measurement.
- **Common mode sensitivity:** Influence of a positive or negative common mode voltage on the differential measurement.
- **Channel separation:** Influence of a voltage on the neighbor channels not subject to an input voltage.
- **AD Converter Values with Inputs shorted:** Values on the internal AD converter corresponding to zero input voltage
- **Input Offset Measurement:** Output voltage and statistical results over a large number of zero voltage measurements.
- **Input Offset Current:** Typical value for information; Maximum channel input offset current, not considering the input resistance.
- **Input resistance:** DAE input resistance at the connector, during internal auto-zeroing and during measurement.
- **Low Battery Alarm Voltage:** Typical value for information. Below this voltage, a battery alarm signal is generated.
- **Power consumption:** Typical value for information. Supply currents in various operating modes.



DC Voltage Measurement

A/D - Converter Resolution nominal

High Range: 1LSB = 6.1 μ V , full range = -100...+300 mV
Low Range: 1LSB = 81nV , full range = -1.....+3mV

DASY measurement parameters: Auto Zero Time: 3 sec; Measuring time: 3 sec

Calibration Factors	X	Y	Z
High Range	404.355 \pm 0.1% (k=2)	403.806 \pm 0.1% (k=2)	404.276 \pm 0.1% (k=2)
Low Range	3.92854 \pm 0.7% (k=2)	3.93862 \pm 0.7% (k=2)	3.93591 \pm 0.7% (k=2)

Connector Angle

Connector Angle to be used in DASY system	268 $^{\circ}$ \pm 1 $^{\circ}$
---	-----------------------------------



Appendix

1. DC Voltage Linearity

High Range	Input (μ V)	Reading (μ V)	Error (%)
Channel X + Input	200000	199999.5	0.00
Channel X + Input	20000	20005.07	0.03
Channel X - Input	20000	-19998.71	-0.01
Channel Y + Input	200000	200000	0.00
Channel Y + Input	20000	20004.22	0.02
Channel Y - Input	20000	-20003.23	0.02
Channel Z + Input	200000	200000.8	0.00
Channel Z + Input	20000	20005.24	0.03
Channel Z - Input	20000	-20001.80	0.01

Low Range	Input (μ V)	Reading (μ V)	Error (%)
Channel X + Input	2000	1999.9	0.00
Channel X + Input	200	200.27	0.13
Channel X - Input	200	-200.73	0.36
Channel Y + Input	2000	2000.1	0.00
Channel Y + Input	200	199.22	-0.39
Channel Y - Input	200	-200.86	0.43
Channel Z + Input	2000	1999.9	0.00
Channel Z + Input	200	199.28	-0.36
Channel Z - Input	200	-200.94	0.47

2. Common mode sensitivity

DASY measurement parameters: Auto Zero Time: 3 sec; Measuring time: 3 sec

	Common mode Input Voltage (mV)	High Range Average Reading (μ V)	Low Range Average Reading (μ V)
Channel X	200	14.24	12.49
	-200	-12.13	-12.92
Channel Y	200	-6.51	-7.06
	-200	6.05	5.81
Channel Z	200	1.09	0.88
	-200	-2.88	-2.63

3. Channel separation

DASY measurement parameters: Auto Zero Time: 3 sec; Measuring time: 3 sec

	Input Voltage (mV)	Channel X (μ V)	Channel Y (μ V)	Channel Z (μ V)
Channel X	200	-	2.51	0.09
Channel Y	200	0.43	-	3.37
Channel Z	200	-0.55	0.98	-



4. AD-Converter Values with inputs shorted

DASY measurement parameters: Auto Zero Time: 3 sec; Measuring time: 3 sec

	High Range (LSB)	Low Range (LSB)
Channel X	15970	16306
Channel Y	15851	16305
Channel Z	16208	17068

5. Input Offset Measurement

DASY measurement parameters: Auto Zero Time: 3 sec; Measuring time: 3 sec

Input 10MΩ

	Average (μV)	min. Offset (μV)	max. Offset (μV)	Std. Deviation (μV)
Channel X	-0.51	-1.55	0.47	0.50
Channel Y	-2.06	-4.32	-0.65	0.60
Channel Z	-1.63	-2.56	-0.15	0.35

6. Input Offset Current

Nominal input circuitry offset current on all channels: <25fA

7. Input Resistance

	Zeroing (MOhm)	Measuring (MOhm)
Channel X	0.2000	199.8
Channel Y	0.2000	200.7
Channel Z	0.2000	199.8

8. Low Battery Alarm Voltage (verified during pre test)

Typical values	Alarm Level (VDC)
Supply (+ Vcc)	+7.9
Supply (- Vcc)	-7.6

9. Power Consumption (verified during pre test)

Typical values	Switched off (mA)	Stand by (mA)	Transmitting (mA)
Supply (+ Vcc)	+0.0	+5	+14
Supply (- Vcc)	-0.01	-8	-9



Appendix D - Product Photo





Appendix E - Test Setup Photo



Notebook Bottom Touch