

## FCC Test Report

**Report No.:** RF170625E01

**FCC ID:** JNZMR0065

**Test Model:** M-R0065

**Received Date:** June 25, 2017

**Test Date:** June 28 to July 04, 2017

**Issued Date:** July 10, 2017

**Applicant:** LOGITECH FAR EAST LTD.

**Address:** #2 Creation Rd. 4, Science-Based Ind. Park Hsinchu Taiwan, R.O.C.

**Issued By:** Bureau Veritas Consumer Products Services (H.K.) Ltd., Taoyuan Branch  
Hsin Chu Laboratory

**Lab Address:** E-2, No.1, Li Hsin 1st Road, Hsinchu Science Park, Hsinchu City 300,  
Taiwan R.O.C.

**Test Location (1):** E-2, No.1, Li Hsin 1st Road, Hsinchu Science Park, Hsinchu City 300,  
Taiwan R.O.C.

**Test Location (2):** No. 49, Ln. 206, Wende Rd., Shangshan Tsuen, Chiung Lin Hsiang, Hsin  
Chu Hsien 307, Taiwan R.O.C.



This report is for your exclusive use. Any copying or replication of this report to or for any other person or entity, or use of our name or trademark, is permitted only with our prior written permission. This report sets forth our findings solely with respect to the test samples identified herein. The results set forth in this report are not indicative or representative of the quality or characteristics of the lot from which a test sample was taken or any similar or identical product unless specifically and expressly noted. Our report includes all of the tests requested by you and the results thereof based upon the information that you provided to us. You have 60 days from date of issuance of this report to notify us of any material error or omission caused by our negligence, provided, however, that such notice shall be in writing and shall specifically address the issue you wish to raise. A failure to raise such issue within the prescribed time shall constitute your unqualified acceptance of the completeness of this report, the tests conducted and the correctness of the report contents. Unless specific mention, the uncertainty of measurement has been explicitly taken into account to declare the compliance or non-compliance to the specification. The report must not be used by the client to claim product certification, approval, or endorsement by TAF or any government agencies.

## Table of Contents

<b>Release Control Record</b> .....	<b>4</b>
<b>1 Certificate of Conformity</b> .....	<b>5</b>
<b>2 Summary of Test Results</b> .....	<b>6</b>
2.1 Measurement Uncertainty .....	6
2.2 Modification Record .....	6
<b>3 General Information</b> .....	<b>7</b>
3.1 General Description of EUT .....	7
3.2 Description of Test Modes .....	8
3.2.1 Test Mode Applicability and Tested Channel Detail .....	9
3.3 Duty Cycle of Test Signal .....	11
3.4 Description of Support Units .....	12
3.4.1 Configuration of System under Test .....	13
3.5 General Description of Applied Standards .....	14
<b>4 Test Types and Results</b> .....	<b>15</b>
4.1 Radiated Emission and Bandedge Measurement .....	15
4.1.1 Limits of Radiated Emission and Bandedge Measurement .....	15
4.1.2 Test Instruments .....	16
4.1.3 Test Procedures .....	17
4.1.4 Deviation from Test Standard .....	17
4.1.5 Test Setup .....	18
4.1.6 EUT Operating Conditions .....	19
4.1.7 Test Results .....	20
4.2 Conducted Emission Measurement .....	24
4.2.1 Limits of Conducted Emission Measurement .....	24
4.2.2 Test Instruments .....	24
4.2.3 Test Procedures .....	25
4.2.4 Deviation from Test Standard .....	25
4.2.5 Test Setup .....	25
4.2.6 EUT Operating Conditions .....	25
4.2.7 Test Results (Mode 1) .....	26
4.2.8 Test Results (Mode 2) .....	28
4.3 6dB Bandwidth Measurement .....	30
4.3.1 Limits of 6dB Bandwidth Measurement .....	30
4.3.2 Test Setup .....	30
4.3.3 Test Instruments .....	30
4.3.4 Test Procedure .....	30
4.3.5 Deviation from Test Standard .....	30
4.3.6 EUT Operating Conditions .....	30
4.3.7 Test Result .....	31
4.4 Conducted Output Power Measurement .....	32
4.4.1 Limits of Conducted Output Power Measurement .....	32
4.4.2 Test Setup .....	32
4.4.3 Test Instruments .....	32
4.4.4 Test Procedures .....	32
4.4.5 Deviation from Test Standard .....	32
4.4.6 EUT Operating Conditions .....	32
4.4.7 Test Results .....	33
4.5 Power Spectral Density Measurement .....	34
4.5.1 Limits of Power Spectral Density Measurement .....	34
4.5.2 Test Setup .....	34
4.5.3 Test Instruments .....	34
4.5.4 Test Procedure .....	34
4.5.5 Deviation from Test Standard .....	34

4.5.6 EUT Operating Condition .....	34
4.5.7 Test Results .....	35
4.6 Conducted Out of Band Emission Measurement .....	36
4.6.1 Limits of Conducted Out of Band Emission Measurement.....	36
4.6.2 Test Setup.....	36
4.6.3 Test Instruments .....	36
4.6.4 Test Procedure .....	36
4.6.5 Deviation from Test Standard .....	36
4.6.6 EUT Operating Condition .....	36
4.6.7 Test Results .....	36
<b>5 Pictures of Test Arrangements.....</b>	<b>38</b>
<b>Appendix – Information on the Testing Laboratories .....</b>	<b>39</b>

### Release Control Record

Issue No.	Description	Date Issued
RF170625E01	Original release.	July 10, 2017

## 1 Certificate of Conformity

**Product:** Wireless Trackball

**Brand:** Logitech

**Test Model:** M-R0065

**Sample Status:** ENGINEERING SAMPLE

**Applicant:** LOGITECH FAR EAST LTD.

**Test Date:** June 28 to July 04, 2017

**Standards:** 47 CFR FCC Part 15, Subpart C (Section 15.247)  
ANSI C63.10: 2013

The above equipment has been tested by **Bureau Veritas Consumer Products Services (H.K.) Ltd., Taoyuan Branch**, and found compliance with the requirement of the above standards. The test record, data evaluation & Equipment Under Test (EUT) configurations represented herein are true and accurate accounts of the measurements of the sample's EMC characteristics under the conditions specified in this report.

**Prepared by :** Cindy Hsin , **Date:** July 10, 2017  
Cindy Hsin / Specialist

**Approved by :** May Chen , **Date:** July 10, 2017  
May Chen / Manager

## 2 Summary of Test Results

47 CFR FCC Part 15, Subpart C (SECTION 15.247)			
FCC Clause	Test Item	Result	Remarks
15.207	AC Power Conducted Emission	PASS	Meet the requirement of limit. Minimum passing margin is -7.84dB at 0.48594MHz.
15.205 / 15.209 / 15.247(d)	Radiated Emissions and Band Edge Measurement	PASS	Meet the requirement of limit. Minimum passing margin is -8.5dB at 4948.00MHz.
15.247(d)	Antenna Port Emission	PASS	Meet the requirement of limit.
15.247(a)(2)	6dB bandwidth	PASS	Meet the requirement of limit.
15.247(b)	Conducted power	PASS	Meet the requirement of limit.
15.247(e)	Power Spectral Density	PASS	Meet the requirement of limit.
15.203	Antenna Requirement	PASS	No antenna connector is used.

### 2.1 Measurement Uncertainty

Where relevant, the following measurement uncertainty levels have been estimated for tests performed on the EUT as specified in CISPR 16-4-2:

Measurement	Frequency	Expanded Uncertainty (k=2) ( $\pm$ )
Conducted Emissions at mains ports	150kHz ~ 30MHz	1.84 dB
Radiated Emissions up to 1 GHz	30MHz ~ 1GHz	5.30 dB
Radiated Emissions above 1 GHz	1GHz ~ 6GHz	4.78 dB
	6GHz ~ 18GHz	4.52 dB
	18GHz ~ 40GHz	5.08 dB

### 2.2 Modification Record

There were no modifications required for compliance.

### 3 General Information

#### 3.1 General Description of EUT

Product	Wireless Trackball
Brand	Logitech
PMN	MX ERGO
Test Model	M-R0065
Status of EUT	ENGINEERING SAMPLE
Power Supply Rating	DC 3.7V from battery DC 5V from USB interface
Modulation Type	GFSK
Transfer Rate	2Mbps
Operating Frequency	2405MHz ~ 2474MHz
Number of Channel	12
Output Power	2.028mW
Antenna Type	Refer to Note
Antenna Connector	Refer to Note
Accessory Device	NA
Cable Supplied	USB to Micro USB cable x 1 (1.2m, shielded)

Note:

1. The EUT may have a lot of colors for marketing requirement.
2. BT-LE and GFSK technology cannot transmit at same time.
3. The EUT could be supplied with a battery as the following table:

No.	Brand	Model No.	Spec.
1	SYNERGY SCIENTECH CORP or Logitech	AHB572535PJT or 533-000120	3.7Vdc, 500mAh, 2.0Wh
2	SPRINGPOWER TECHNOLOGY SHENZHEN CO LTD or Logitech	652535 or 533-000121	3.7Vdc, 500mAh, 1.85Wh

4. The antenna provided to the EUT, please refer to the following table:

Brand	Model	Antenna Gain (dBi)	Frequency range(GHz)	Antenna Type	Connecter Type	Cable Length
NA	NA	-0.30	2.4-2.4835	Ceramic Chip Antenna	NA	NA

5. The EUT was pre-tested under following test modes:

Pre-test Mode	Power
Mode A	Power from battery
<b>Mode B</b>	<b>Power from USB interface (adapter)</b>

From the above modes, the worst radiated emission was found in **Mode B**. Therefore only the test data of the modes were recorded in this report.

6. The above EUT information is declared by manufacturer and for more detailed features description, please refer to the manufacturer's specifications or user's manual.

### 3.2 Description of Test Modes

12 channels are provided to this EUT:

Channel	Frequency	Channel	Frequency
1	2405	7	2441
2	2408	8	2444
3	2414	9	2462
4	2417	10	2465
5	2432	11	2471
6	2435	12	2474



### 3.2.1 Test Mode Applicability and Tested Channel Detail

EUT CONFIGURE MODE	APPLICABLE TO				DESCRIPTION
	RE $\geq$ 1G	RE<1G	PLC	APCM	
1	√	√	√	√	Power from USB interface (adapter)
2	-	-	√	-	Power from USB interface (Laptop)

Where RE $\geq$ 1G: Radiated Emission above 1GHz & Bandedge Measurement  
 RE<1G: Radiated Emission below 1GHz  
 PLC: Power Line Conducted Emission  
 APCM: Antenna Port Conducted Measurement

**NOTE:** "-" means no effect.

#### **Radiated Emission Test (Above 1GHz):**

- Pre-Scan has been conducted to determine the worst-case mode from all possible combinations between available modulations, data rates and antenna ports (if EUT with antenna diversity architecture).
- Following channel(s) was (were) selected for the final test as listed below.

AVAILABLE CHANNEL	TESTED CHANNEL	MODULATION TYPE
1 to 12	1, 8, 12	GFSK

#### **Radiated Emission Test (Below 1GHz):**

- Pre-Scan has been conducted to determine the worst-case mode from all possible combinations between available modulations, data rates and antenna ports (if EUT with antenna diversity architecture).
- Following channel(s) was (were) selected for the final test as listed below.

AVAILABLE CHANNEL	TESTED CHANNEL	MODULATION TYPE
1 to 12	1	GFSK

#### **Power Line Conducted Emission Test:**

- Pre-Scan has been conducted to determine the worst-case mode from all possible combinations between available modulations, data rates and antenna ports (if EUT with antenna diversity architecture).
- Following channel(s) was (were) selected for the final test as listed below.

AVAILABLE CHANNEL	TESTED CHANNEL	MODULATION TYPE
1 to 12	1	GFSK

**Antenna Port Conducted Measurement:**

- This item includes all test value of each mode, but only includes spectrum plot of worst value of each mode.
- Pre-Scan has been conducted to determine the worst-case mode from all possible combinations between available modulations, data rates and antenna ports (if EUT with antenna diversity architecture).
- Following channel(s) was (were) selected for the final test as listed below.

AVAILABLE CHANNEL	TESTED CHANNEL	MODULATION TYPE
1 to 12	1, 8, 12	GFSK

**Test Condition:**

APPLICABLE TO	ENVIRONMENTAL CONDITIONS	INPUT POWER (SYSTEM)	TESTED BY
RE $\geq$ 1G	23deg. C, 66%RH	120Vac, 60Hz	Weiwei Lo
RE<1G	22deg. C, 69%RH	120Vac, 60Hz	Weiwei Lo
PLC	24deg. C, 74%RH	120Vac, 60Hz	Andy Ho
APCM	25deg. C, 60%RH	120Vac, 60Hz	Robert Cheng

### 3.3 Duty Cycle of Test Signal

Duty cycle of test signal is < 98 %, duty factor shall be considered.

Duty cycle =  $0.1 \text{ ms} / 9.994 \text{ ms} = 0.01 \text{ * } 100 \text{ \%} = 1 \text{ \%}$

Duty factor =  $10 \text{ * } \log(1/\text{duty cycle}) = 10 \text{ * } \log(1/(0.1 / 9.994)) = 20 \text{ dB}$

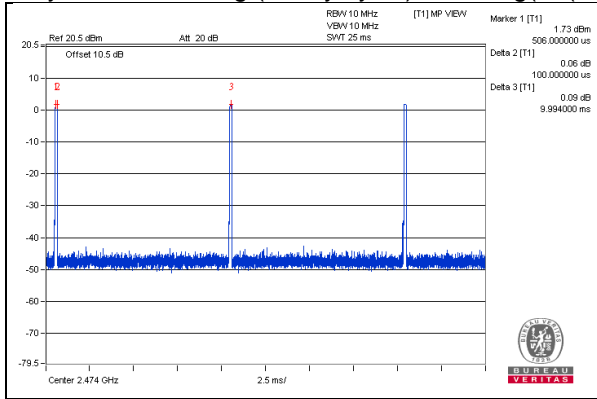

### 3.4 Description of Support Units

The EUT has been tested as an independent unit together with other necessary accessories or support units. The following support units or accessories were used to form a representative test configuration during the tests.

ID	Product	Brand	Model No.	Serial No.	FCC ID	Remarks
A.	USB Adapter	ASUS	EXA1205UA	NA	NA	Provided by Lab
B.	Laptop	DELL	E5430	HYV4VY1	FCC DoC	Provided by Lab

Note:

1. All power cords of the above support units are non-shielded (1.8m).

ID	Descriptions	Qty.	Length (m)	Shielding (Yes/No)	Cores (Qty.)	Remarks
1.	Micro USB Cable	1	1.2	Yes	0	Supplied by client

### 3.4.1 Configuration of System under Test

For Mode 1:

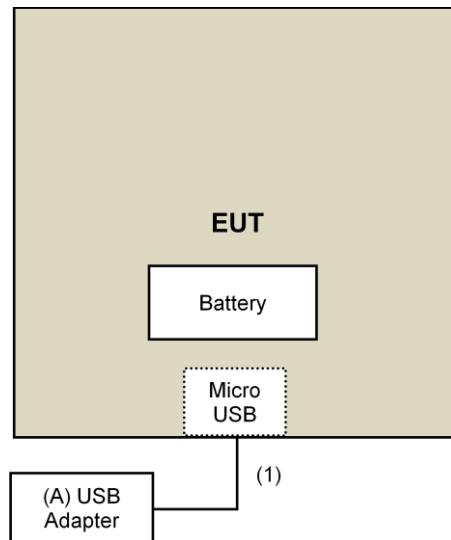

For Mode 2:

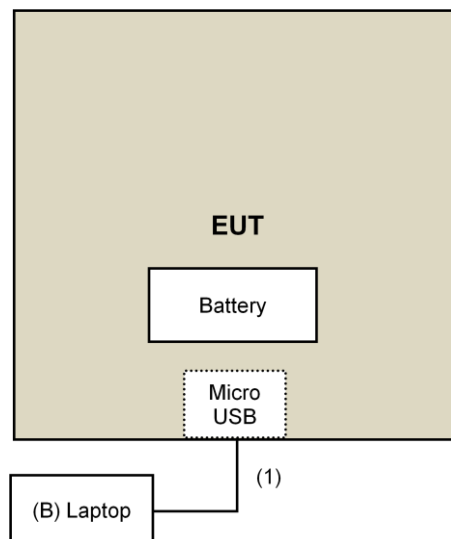

### 3.5 General Description of Applied Standards

The EUT is a RF Product. According to the specifications of the manufacturer, it must comply with the requirements of the following standards:

**FCC Part 15, Subpart C (15.247)**  
**KDB 558074 D01 DTS Meas Guidance v4**  
**ANSI C63.10-2013**

All test items have been performed and recorded as per the above standards.

## 4 Test Types and Results

### 4.1 Radiated Emission and Bandedge Measurement

#### 4.1.1 Limits of Radiated Emission and Bandedge Measurement

Radiated emissions which fall in the restricted bands must comply with the radiated emission limits specified as below table. Other emissions shall be at least 20dB below the highest level of the desired power:

Frequencies (MHz)	Field Strength (microvolts/meter)	Measurement Distance (meters)
0.009 ~ 0.490	2400/F(kHz)	300
0.490 ~ 1.705	24000/F(kHz)	30
1.705 ~ 30.0	30	30
30 ~ 88	100	3
88 ~ 216	150	3
216 ~ 960	200	3
Above 960	500	3

**NOTE:**

1. The lower limit shall apply at the transition frequencies.
2. Emission level (dBuV/m) = 20 log Emission level (uV/m).
3. For frequencies above 1000MHz, the field strength limits are based on average detector, however, the peak field strength of any emission shall not exceed the maximum permitted average limits, specified above by more than 20dB under any condition of modulation.

## 4.1.2 Test Instruments

DESCRIPTION & MANUFACTURER	MODEL NO.	SERIAL NO.	CALIBRATED DATE	CALIBRATED UNTIL
Test Receiver Keysight	N9038A	MY54450088	July 20, 2016	July 19, 2017
Pre-Amplifier <sup>(*)</sup> EMCI	EMC001340	980142	Jan. 20, 2016	Jan. 19, 2018
Loop Antenna <sup>(*)</sup> Electro-Metrics	EM-6879	264	Dec. 16, 2016	Dec. 15, 2018
RF Cable	NA	LOOPCAB-001 LOOPCAB-002	Jan. 17, 2017	Jan. 16, 2018
Pre-Amplifier Mini-Circuits	ZFL-1000VH2B	AMP-ZFL-01	Nov. 10, 2016	Nov. 09, 2017
Trilog Broadband Antenna SCHWARZBECK	VULB 9168	9168-406	Dec. 13, 2016	Dec. 12, 2017
RF Cable	8D	966-4-1 966-4-2 966-4-3	Apr. 01, 2017	Mar. 31, 2018
Fixed attenuator Mini-Circuits	UNAT-5+	PAD-3m-4-01	Oct. 05, 2016	Oct. 04, 2017
Horn_Antenna SCHWARZBECK	BBHA 9120D	9120D-783	Dec. 27, 2016	Dec. 26, 2017
Pre-Amplifier EMCI	EMC12630SE	980385	Feb. 02, 2017	Feb. 01, 2018
RF Cable	EMC104-SM-SM-1200 EMC104-SM-SM-2000 EMC104-SM-SM-5000	160923 150318 150321	Feb. 02, 2017 Mar. 29, 2017 Mar. 29, 2017	Feb. 01, 2018 Mar. 28, 2018 Mar. 28, 2018
Pre-Amplifier EMCI	EMC184045SE	980387	Feb. 02, 2017	Feb. 01, 2018
Horn_Antenna SCHWARZBECK	BBHA 9170	BBHA9170608	Dec. 15, 2016	Dec. 14, 2017
RF Cable	SUCOFLEX 102	36432/2 36433/2	Jan. 15, 2017	Jan. 14, 2018
Software	ADT_Radiated_V8.7.08	NA	NA	NA
Antenna Tower & Turn Table Max-Full	MF-7802	MF780208410	NA	NA
Boresight Antenna Fixture	FBA-01	FBA-SIP02	NA	NA
Spectrum Analyzer R&S	FSP40	100060	May 11, 2017	May 10, 2018
Power meter Anritsu	ML2495A	1014008	May 11, 2017	May 10, 2018
Power sensor Anritsu	MA2411B	0917122	May 11, 2017	May 10, 2018

**Note:**

1. The calibration interval of the above test instruments is 12 months and the calibrations are traceable to NML/ROC and NIST/USA.
2. The horn antenna, preamplifier (model: 8449B) are used only for the measurement of emission frequency above 1GHz if tested.
3. The test was performed in 966 Chamber No. 4.
4. The FCC Site Registration No. is 292998
5. The CANADA Site Registration No. is 20331-2
6. Tested Date: June 30, 2017



#### 4.1.3 Test Procedures

##### **For Radiated emission below 30MHz**

- a. The EUT was placed on the top of a rotating table 0.8 meters above the ground at a 3 meter chamber room. The table was rotated 360 degrees to determine the position of the highest radiation.
- b. The EUT was set 3 meters away from the interference-receiving antenna, which was mounted on the top of a variable-height antenna tower.
- c. Both X and Y axes of the antenna are set to make the measurement.
- d. For each suspected emission, the EUT was arranged to its worst case and the rotatable table was turned from 0 degrees to 360 degrees to find the maximum reading.
- e. The test-receiver system was set to Quasi-Peak Detect Function and Specified Bandwidth with Maximum Hold Mode.

##### **NOTE:**

1. The resolution bandwidth and video bandwidth of test receiver/spectrum analyzer is 9kHz at frequency below 30MHz.

##### **For Radiated emission above 30MHz**

- a. The EUT was placed on the top of a rotating table 0.8 meters (for 30MHz ~ 1GHz) / 1.5 meters (for above 1GHz) above the ground at 3 meter chamber room for test. The table was rotated 360 degrees to determine the position of the highest radiation.
- b. The EUT was set 3 meters away from the interference-receiving antenna, which was mounted on the top of a variable-height antenna tower.
- c. The height of antenna is varied from one meter to four meters above the ground to determine the maximum value of the field strength. Both horizontal and vertical polarizations of the antenna are set to make the measurement.
- d. For each suspected emission, the EUT was arranged to its worst case and then the antenna was tuned to heights from 1 meter to 4 meters and the rotatable table was turned from 0 degrees to 360 degrees to find the maximum reading.
- e. The test-receiver system was set to quasi-peak detect function and specified bandwidth with maximum hold mode when the test frequency is below 1 GHz.
- f. The test-receiver system was set to peak and average detect function and specified bandwidth with maximum hold mode when the test frequency is above 1 GHz. If the peak reading value also meets average limit, measurement with the average detector is unnecessary.

##### **Note:**

1. The resolution bandwidth and video bandwidth of test receiver/spectrum analyzer is 120kHz for Quasi-peak detection (QP) at frequency below 1GHz.
2. The resolution bandwidth of test receiver/spectrum analyzer is 1 MHz and the video bandwidth is 3 MHz for Peak detection (PK) at frequency above 1GHz.
3. The resolution bandwidth of test receiver/spectrum analyzer is 1 MHz and the video bandwidth is 3 MHz for Average detection (AV) at frequency above 1GHz.
4. All modes of operation were investigated and the worst-case emissions are reported.

#### 4.1.4 Deviation from Test Standard

No deviation.

#### 4.1.5 Test Setup

##### For Radiated emission below 30MHz

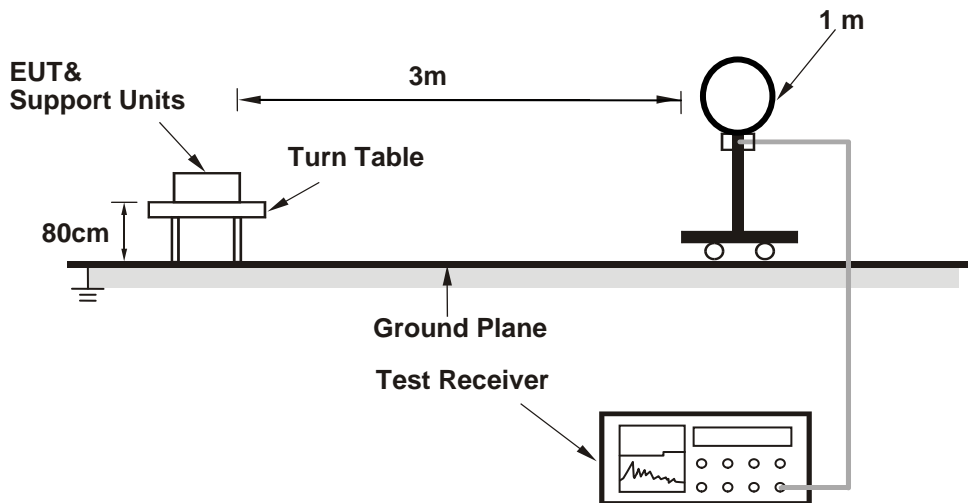

##### For Radiated emission 30MHz to 1GHz

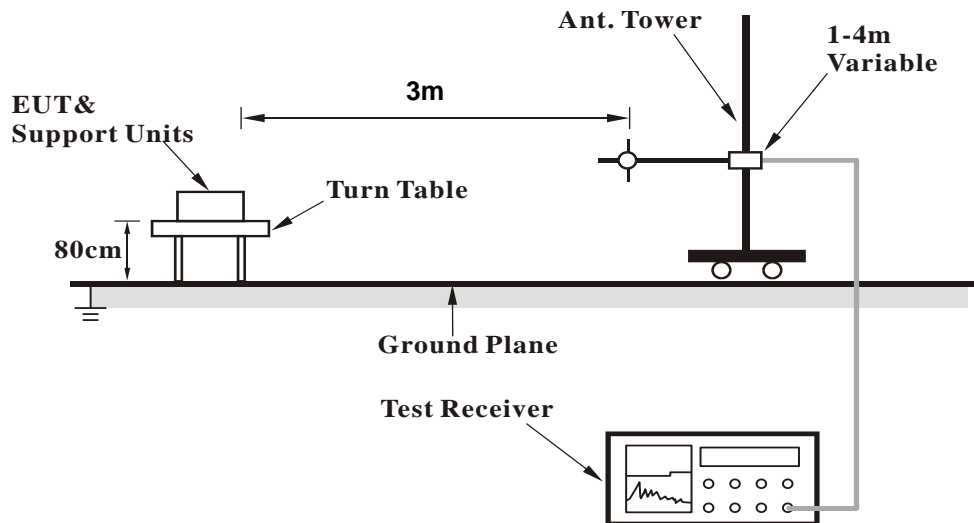

### For Radiated emission above 1GHz

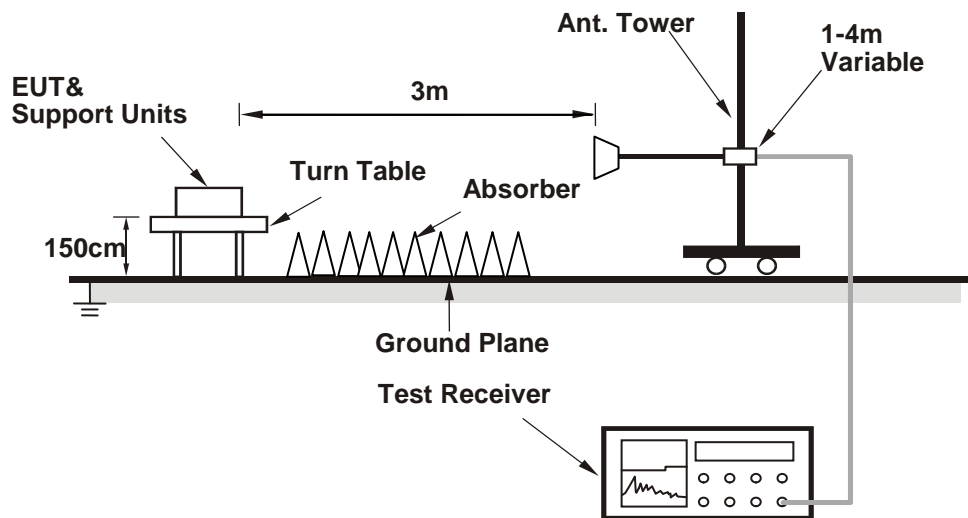

For the actual test configuration, please refer to the attached file (Test Setup Photo).

#### 4.1.6 EUT Operating Conditions

- a. Controlling software (RF Sample with Receiver C-U0007[Number Lock]) has been activated to set the EUT on specific status.

#### 4.1.7 Test Results

##### Above 1GHz Data:

<b>CHANNEL</b>	TX Channel 1	<b>DETECTOR FUNCTION</b>	Peak (PK)
<b>FREQUENCY RANGE</b>	1GHz ~ 25GHz		Average (AV)

#### ANTENNA POLARITY & TEST DISTANCE: HORIZONTAL AT 3 M

NO.	FREQ. (MHz)	EMISSION LEVEL (dBuV/m)	LIMIT (dBuV/m)	MARGIN (dB)	ANTENNA HEIGHT (m)	TABLE ANGLE (Degree)	RAW VALUE (dBuV)	CORRECTION FACTOR (dB/m)
1	2390.00	52.9 PK	74.0	-21.1	1.48 H	137	54.2	-1.3
2	2390.00	37.0 AV	54.0	-17.0	1.48 H	137	38.3	-1.3
3	*2405.00	96.6 PK			1.50 H	130	97.7	-1.1
4	*2405.00	95.8 AV			1.50 H	130	96.9	-1.1
5	4810.00	49.5 PK	74.0	-24.5	2.40 H	228	46.3	3.2
6	4810.00	45.3 AV	54.0	-8.7	2.40 H	228	42.1	3.2

#### ANTENNA POLARITY & TEST DISTANCE: VERTICAL AT 3 M

NO.	FREQ. (MHz)	EMISSION LEVEL (dBuV/m)	LIMIT (dBuV/m)	MARGIN (dB)	ANTENNA HEIGHT (m)	TABLE ANGLE (Degree)	RAW VALUE (dBuV)	CORRECTION FACTOR (dB/m)
1	2390.00	54.8 PK	74.0	-19.2	2.45 V	67	56.1	-1.3
2	2390.00	37.3 AV	54.0	-16.7	2.45 V	67	38.6	-1.3
3	*2405.00	92.7 PK			2.43 V	54	93.8	-1.1
4	*2405.00	92.1 AV			2.43 V	54	93.2	-1.1
5	4810.00	45.3 PK	74.0	-28.7	3.17 V	336	42.1	3.2
6	4810.00	42.9 AV	54.0	-11.1	3.17 V	336	39.7	3.2

#### REMARKS:

1. Emission Level(dBuV/m) = Raw Value(dBuV) + Correction Factor(dB/m)
2. Correction Factor(dB/m) = Antenna Factor(dB/m) + Cable Factor(dB) – Pre-Amplifier Factor(dB)
3. The other emission levels were very low against the limit.
4. Margin value = Emission Level – Limit value
5. " \* ": Fundamental frequency.

<b>CHANNEL</b>	TX Channel 8	<b>DETECTOR FUNCTION</b>	Peak (PK)
<b>FREQUENCY RANGE</b>	1GHz ~ 25GHz		Average (AV)

**ANTENNA POLARITY & TEST DISTANCE: HORIZONTAL AT 3 M**

NO.	FREQ. (MHz)	EMISSION LEVEL (dBuV/m)	LIMIT (dBuV/m)	MARGIN (dB)	ANTENNA HEIGHT (m)	TABLE ANGLE (Degree)	RAW VALUE (dBuV)	CORRECTION FACTOR (dB/m)
1	*2444.00	95.4 PK			1.41 H	144	96.6	-1.2
2	*2444.00	94.6 AV			1.41 H	144	95.8	-1.2
3	4888.00	49.3 PK	74.0	-24.7	2.40 H	242	45.8	3.5
4	4888.00	45.2 AV	54.0	-8.8	2.40 H	242	41.7	3.5
5	7332.00	45.4 PK	74.0	-28.6	1.44 H	287	35.6	9.8
6	7332.00	36.4 AV	54.0	-17.6	1.44 H	287	26.6	9.8

**ANTENNA POLARITY & TEST DISTANCE: VERTICAL AT 3 M**

NO.	FREQ. (MHz)	EMISSION LEVEL (dBuV/m)	LIMIT (dBuV/m)	MARGIN (dB)	ANTENNA HEIGHT (m)	TABLE ANGLE (Degree)	RAW VALUE (dBuV)	CORRECTION FACTOR (dB/m)
1	*2444.00	93.2 PK			2.34 V	50	94.4	-1.2
2	*2444.00	92.4 AV			2.34 V	50	93.6	-1.2
3	4888.00	44.3 PK	74.0	-29.7	3.17 V	315	40.8	3.5
4	4888.00	42.1 AV	54.0	-11.9	3.17 V	315	38.6	3.5
5	7332.00	43.8 PK	74.0	-30.2	1.76 V	310	34.0	9.8
6	7332.00	32.6 AV	54.0	-21.4	1.76 V	310	22.8	9.8

**REMARKS:**

1. Emission Level(dBuV/m) = Raw Value(dBuV) + Correction Factor(dB/m)
2. Correction Factor(dB/m) = Antenna Factor(dB/m) + Cable Factor(dB) – Pre-Amplifier Factor(dB)
3. The other emission levels were very low against the limit.
4. Margin value = Emission Level – Limit value
5. " \* ": Fundamental frequency.

<b>CHANNEL</b>	TX Channel 12	<b>DETECTOR FUNCTION</b>	Peak (PK)
<b>FREQUENCY RANGE</b>	1GHz ~ 25GHz		Average (AV)

**ANTENNA POLARITY & TEST DISTANCE: HORIZONTAL AT 3 M**

NO.	FREQ. (MHz)	EMISSION LEVEL (dBuV/m)	LIMIT (dBuV/m)	MARGIN (dB)	ANTENNA HEIGHT (m)	TABLE ANGLE (Degree)	RAW VALUE (dBuV)	CORRECTION FACTOR (dB/m)
1	*2474.00	94.7 PK			1.52 H	131	95.7	-1.0
2	*2474.00	94.2 AV			1.52 H	131	95.2	-1.0
3	2483.50	50.2 PK	74.0	-23.8	1.41 H	125	51.2	-1.0
4	2483.50	38.8 AV	54.0	-15.2	1.41 H	125	39.8	-1.0
5	4948.00	50.0 PK	74.0	-24.0	2.46 H	225	46.4	3.6
<b>6</b>	<b>4948.00</b>	<b>45.5 AV</b>	<b>54.0</b>	<b>-8.5</b>	<b>2.46 H</b>	<b>225</b>	<b>41.9</b>	<b>3.6</b>
7	7422.00	45.0 PK	74.0	-29.0	1.46 H	328	35.1	9.9
8	7422.00	36.2 AV	54.0	-17.8	1.46 H	328	26.3	9.9

**ANTENNA POLARITY & TEST DISTANCE: VERTICAL AT 3 M**

NO.	FREQ. (MHz)	EMISSION LEVEL (dBuV/m)	LIMIT (dBuV/m)	MARGIN (dB)	ANTENNA HEIGHT (m)	TABLE ANGLE (Degree)	RAW VALUE (dBuV)	CORRECTION FACTOR (dB/m)
1	*2474.00	91.8 PK			2.36 V	55	92.8	-1.0
2	*2474.00	91.5 AV			2.36 V	55	92.5	-1.0
3	2483.50	50.4 PK	74.0	-23.6	2.42 V	54	51.4	-1.0
4	2483.50	39.0 AV	54.0	-15.0	2.42 V	54	40.0	-1.0
5	4948.00	45.2 PK	74.0	-28.8	3.15 V	343	41.6	3.6
6	4948.00	42.9 AV	54.0	-11.1	3.15 V	343	39.3	3.6
7	7422.00	43.5 PK	74.0	-30.5	1.65 V	302	33.6	9.9
8	7422.00	32.2 AV	54.0	-21.8	1.65 V	302	22.3	9.9

**REMARKS:**

1. Emission Level(dBuV/m) = Raw Value(dBuV) + Correction Factor(dB/m)
2. Correction Factor(dB/m) = Antenna Factor(dB/m) + Cable Factor(dB) – Pre-Amplifier Factor(dB)
3. The other emission levels were very low against the limit.
4. Margin value = Emission Level – Limit value
5. " \* ": Fundamental frequency.

**Below 1GHz Data:**

<b>CHANNEL</b>	TX Channel 1	<b>DETECTOR FUNCTION</b>	Quasi-Peak (QP)
<b>FREQUENCY RANGE</b>	9kHz ~ 1GHz		

**ANTENNA POLARITY & TEST DISTANCE: HORIZONTAL AT 3 M**

NO.	FREQ. (MHz)	EMISSION LEVEL (dBuV/m)	LIMIT (dBuV/m)	MARGIN (dB)	ANTENNA HEIGHT (m)	TABLE ANGLE (Degree)	RAW VALUE (dBuV)	CORRECTION FACTOR (dB/m)
1	32.09	29.5 QP	40.0	-10.5	1.11 H	298	38.9	-9.4
2	59.90	26.0 QP	40.0	-14.0	1.00 H	212	34.5	-8.5
3	129.74	20.2 QP	43.5	-23.3	1.34 H	50	29.6	-9.4
4	162.16	22.2 QP	43.5	-21.3	1.45 H	55	30.2	-8.0
5	463.83	22.2 QP	46.0	-23.8	1.77 H	333	25.6	-3.4
6	676.31	24.5 QP	46.0	-21.5	1.88 H	167	24.0	0.5

**ANTENNA POLARITY & TEST DISTANCE: VERTICAL AT 3 M**

NO.	FREQ. (MHz)	EMISSION LEVEL (dBuV/m)	LIMIT (dBuV/m)	MARGIN (dB)	ANTENNA HEIGHT (m)	TABLE ANGLE (Degree)	RAW VALUE (dBuV)	CORRECTION FACTOR (dB/m)
1	32.04	29.4 QP	40.0	-10.6	1.00 V	156	38.8	-9.4
2	58.78	27.6 QP	40.0	-12.4	1.00 V	124	35.9	-8.3
3	99.28	22.5 QP	43.5	-21.0	1.00 V	279	35.3	-12.8
4	150.93	23.3 QP	43.5	-20.2	1.20 V	148	31.5	-8.2
5	250.00	19.8 QP	46.0	-26.2	1.00 V	227	29.3	-9.5
6	571.41	23.9 QP	46.0	-22.1	1.20 V	77	25.3	-1.4

**REMARKS:**

1. Emission Level(dBuV/m) = Raw Value(dBuV) + Correction Factor(dB/m)
2. Correction Factor(dB/m) = Antenna Factor(dB/m) + Cable Factor(dB) – Pre-Amplifier Factor(dB)
3. The other emission levels were very low against the limit.
4. Margin value = Emission Level – Limit value

## 4.2 Conducted Emission Measurement

### 4.2.1 Limits of Conducted Emission Measurement

Frequency (MHz)	Conducted Limit (dBuV)	
	Quasi-peak	Average
0.15 - 0.5	66 - 56	56 - 46
0.50 - 5.0	56	46
5.0 - 30.0	60	50

Note: 1. The lower limit shall apply at the transition frequencies.

2. The limit decreases in line with the logarithm of the frequency in the range of 0.15 to 0.50MHz.

### 4.2.2 Test Instruments

DESCRIPTION & MANUFACTURER	MODEL NO.	SERIAL NO.	CALIBRATED DATE	CALIBRATED UNTIL
Test Receiver R&S	ESCS 30	847124/029	Oct. 24, 2016	Oct. 23, 2017
Line-Impedance Stabilization Network (for EUT) R&S	ESH3-Z5	848773/004	Oct. 26, 2016	Oct. 25, 2017
Line-Impedance Stabilization Network (for Peripheral) R&S	ENV216	100072	June 03, 2017	June 02, 2018
50 ohms Terminator	N/A	EMC-02	Sep. 29, 2016	Sep. 28, 2017
RF Cable	5D-FB	COCCAB-001	Sep. 30, 2016	Sep. 29, 2017
10 dB PAD Mini-Circuits	HAT-10+	CONATT-004	June 18, 2017	June 17, 2018
Software BVADT	BVADT_Cond_ V7.3.7.4	NA	NA	NA

**Note:**

1. The calibration interval of the above test instruments are 12 months and the calibrations are traceable to NML/ROC and NIST/USA.
2. The test was performed in Shielded Room No. 1.
3. Tested Date: July 04, 2017



#### 4.2.3 Test Procedures

- The EUT was placed 0.4 meters from the conducting wall of the shielded room with EUT being connected to the power mains through a line impedance stabilization network (LISN). Other support units were connected to the power mains through another LISN. The two LISNs provide 50 ohm/ 50uH of coupling impedance for the measuring instrument.
- Both lines of the power mains connected to the EUT were checked for maximum conducted interference.
- The frequency range from 150kHz to 30MHz was searched. Emission levels under (Limit - 20dB) was not recorded.

**NOTE:** The resolution bandwidth and video bandwidth of test receiver is 9kHz for quasi-peak detection (QP) and average detection (AV) at frequency 0.15MHz-30MHz.

#### 4.2.4 Deviation from Test Standard

No deviation.

#### 4.2.5 Test Setup

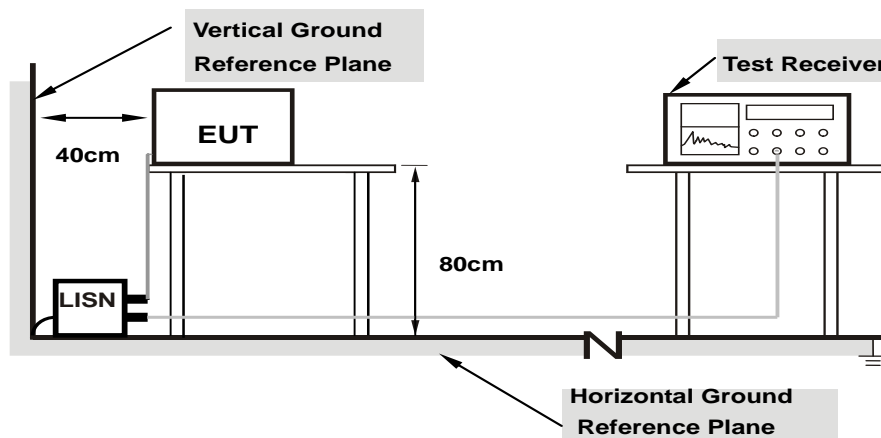

**Note:** 1.Support units were connected to second LISN.

For the actual test configuration, please refer to the attached file (Test Setup Photo).

#### 4.2.6 EUT Operating Conditions

Same as 4.1.6.

#### 4.2.7 Test Results (Mode 1)

Phase	Line (L)	Detector Function	Quasi-Peak (QP) / Average (AV)
-------	----------	-------------------	--------------------------------

Phase Of Power : Line (L)										
No	Frequency (MHz)	Correction Factor (dB)	Reading Value (dBuV)		Emission Level (dBuV)		Limit (dBuV)		Margin (dB)	
			Q.P.	AV.	Q.P.	AV.	Q.P.	AV.	Q.P.	AV.
1	0.15391	10.08	32.52	18.60	42.60	28.68	65.79	55.79	-23.19	-27.11
2	0.16562	10.08	32.19	21.72	42.27	31.80	65.18	55.18	-22.91	-23.38
3	0.57578	10.13	31.26	21.21	41.39	31.34	56.00	46.00	-14.61	-14.66
4	0.98984	10.16	25.09	14.27	35.25	24.43	56.00	46.00	-20.75	-21.57
5	1.78125	10.17	21.76	12.75	31.93	22.92	56.00	46.00	-24.07	-23.08
6	14.18359	11.12	15.80	8.33	26.92	19.45	60.00	50.00	-33.08	-30.55

**Remarks:**

1. Q.P. and AV. are abbreviations of quasi-peak and average individually.
2. The emission levels of other frequencies were very low against the limit.
3. Margin value = Emission level – Limit value
4. Correction factor = Insertion loss + Cable loss
5. Emission Level = Correction Factor + Reading Value

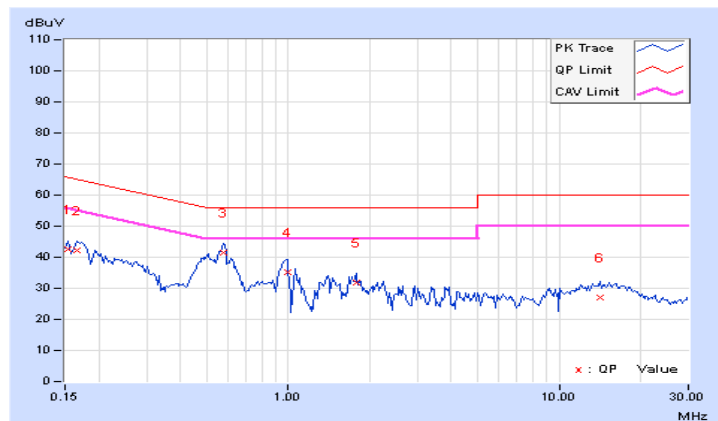

Phase	Neutral (N)	Detector Function	Quasi-Peak (QP) / Average (AV)
-------	-------------	-------------------	--------------------------------

Phase Of Power : Neutral (N)										
No	Frequency (MHz)	Correction Factor (dB)	Reading Value (dBuV)		Emission Level (dBuV)		Limit (dBuV)		Margin (dB)	
			Q.P.	AV.	Q.P.	AV.	Q.P.	AV.	Q.P.	AV.
1	0.15000	10.07	33.45	17.02	43.52	27.09	66.00	56.00	-22.48	-28.91
2	0.18125	10.05	30.40	12.54	40.45	22.59	64.43	54.43	-23.98	-31.84
3	0.58750	10.12	23.33	12.42	33.45	22.54	56.00	46.00	-22.55	-23.46
4	0.99766	10.12	18.93	8.33	29.05	18.45	56.00	46.00	-26.95	-27.55
5	1.69922	10.18	15.48	6.08	25.66	16.26	56.00	46.00	-30.34	-29.74
6	12.67578	10.86	10.20	3.16	21.06	14.02	60.00	50.00	-38.94	-35.98

**Remarks:**

1. Q.P. and AV. are abbreviations of quasi-peak and average individually.
2. The emission levels of other frequencies were very low against the limit.
3. Margin value = Emission level – Limit value
4. Correction factor = Insertion loss + Cable loss
5. Emission Level = Correction Factor + Reading Value

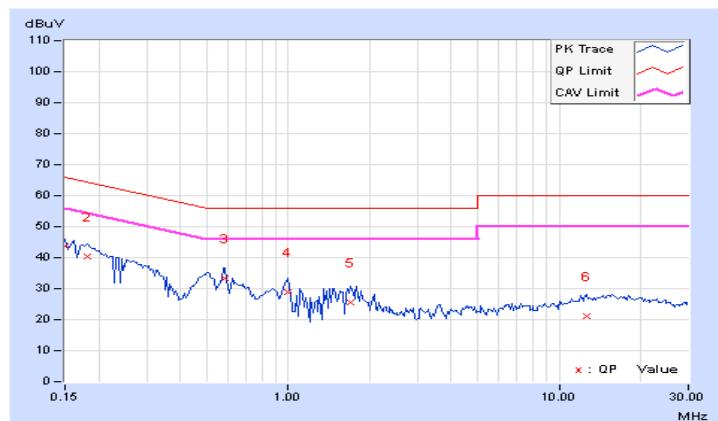

#### 4.2.8 Test Results (Mode 2)

Phase	Line (L)	Detector Function	Quasi-Peak (QP) / Average (AV)
-------	----------	-------------------	--------------------------------

Phase Of Power : Line (L)										
No	Frequency (MHz)	Correction Factor (dB)	Reading Value (dBuV)		Emission Level (dBuV)		Limit (dBuV)		Margin (dB)	
			Q.P.	AV.	Q.P.	AV.	Q.P.	AV.	Q.P.	AV.
1	0.15244	10.07	33.37	11.71	43.44	21.78	65.87	55.87	-22.43	-34.09
2	0.15781	10.07	30.55	10.24	40.62	20.31	65.58	55.58	-24.96	-35.27
3	0.18125	10.06	36.80	29.99	46.86	40.05	64.43	54.43	-17.57	-14.38
<b>4</b>	<b>0.48594</b>	<b>10.11</b>	<b>34.72</b>	<b>28.29</b>	<b>44.83</b>	<b>38.40</b>	<b>56.24</b>	<b>46.24</b>	<b>-11.41</b>	<b>-7.84</b>
5	2.79297	10.20	24.33	17.75	34.53	27.95	56.00	46.00	-21.47	-18.05
6	10.58203	10.65	22.18	16.77	32.83	27.42	60.00	50.00	-27.17	-22.58

**Remarks:**

1. Q.P. and AV. are abbreviations of quasi-peak and average individually.
2. The emission levels of other frequencies were very low against the limit.
3. Margin value = Emission level – Limit value
4. Correction factor = Insertion loss + Cable loss
5. Emission Level = Correction Factor + Reading Value

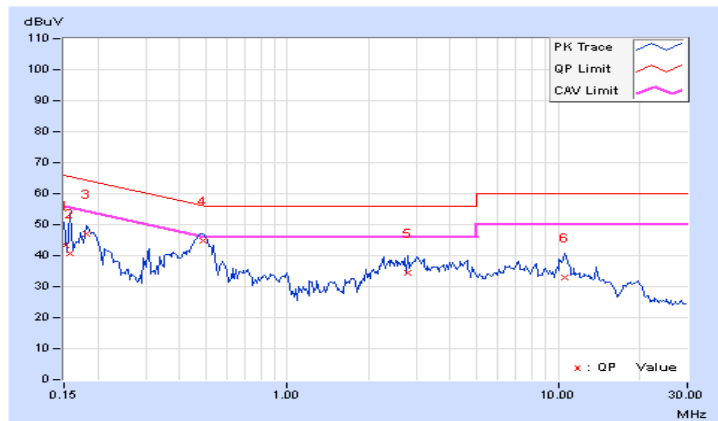

Phase	Neutral (N)	Detector Function	Quasi-Peak (QP) / Average (AV)
-------	-------------	-------------------	--------------------------------

Phase Of Power : Neutral (N)										
No	Frequency (MHz)	Correction Factor (dB)	Reading Value (dBuV)		Emission Level (dBuV)		Limit (dBuV)		Margin (dB)	
			Q.P.	AV.	Q.P.	AV.	Q.P.	AV.	Q.P.	AV.
1	0.15000	10.06	38.21	28.36	48.27	38.42	66.00	56.00	-17.73	-17.58
2	0.16953	10.05	30.63	11.43	40.68	21.48	64.98	54.98	-24.30	-33.50
3	0.48594	10.10	34.54	26.98	44.64	37.08	56.24	46.24	-11.60	-9.16
4	0.87266	10.11	22.60	15.37	32.71	25.48	56.00	46.00	-23.29	-20.52
5	10.37891	10.57	21.10	15.48	31.67	26.05	60.00	50.00	-28.33	-23.95
6	20.03906	11.01	15.91	11.35	26.92	22.36	60.00	50.00	-33.08	-27.64

**Remarks:**

1. Q.P. and AV. are abbreviations of quasi-peak and average individually.
2. The emission levels of other frequencies were very low against the limit.
3. Margin value = Emission level – Limit value
4. Correction factor = Insertion loss + Cable loss
5. Emission Level = Correction Factor + Reading Value

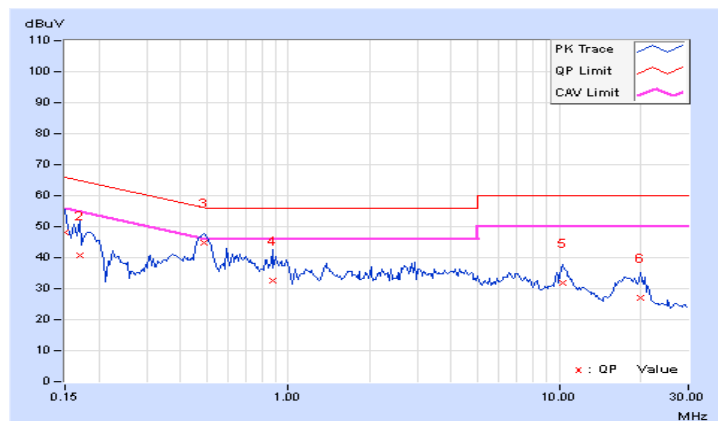

### 4.3 6dB Bandwidth Measurement

#### 4.3.1 Limits of 6dB Bandwidth Measurement

The minimum of 6dB Bandwidth Measurement is 0.5 MHz.

#### 4.3.2 Test Setup

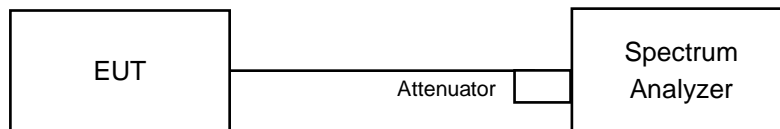

#### 4.3.3 Test Instruments

Refer to section 4.1.2 to get information of above instrument.

#### 4.3.4 Test Procedure

- a. Set resolution bandwidth (RBW) = 100kHz
- b. Set the video bandwidth (VBW)  $\geq 3 \times$  RBW, Detector = Peak.
- c. Trace mode = max hold.
- d. Sweep = auto couple.
- e. Measure the maximum width of the emission that is constrained by the frequencies associated with the two amplitude points (upper and lower) that are attenuated by 6 dB relative to the maximum level measured in the fundamental emission

#### 4.3.5 Deviation from Test Standard

No deviation.

#### 4.3.6 EUT Operating Conditions

The software provided by client to enable the EUT under transmission condition continuously at lowest, middle and highest channel frequencies individually.

### 4.3.7 Test Result

Channel	Frequency (MHz)	6dB Bandwidth (MHz)	Minimum Limit (MHz)	Pass / Fail
1	2405	0.88	0.5	PASS
8	2444	0.91	0.5	PASS
12	2474	0.87	0.5	PASS

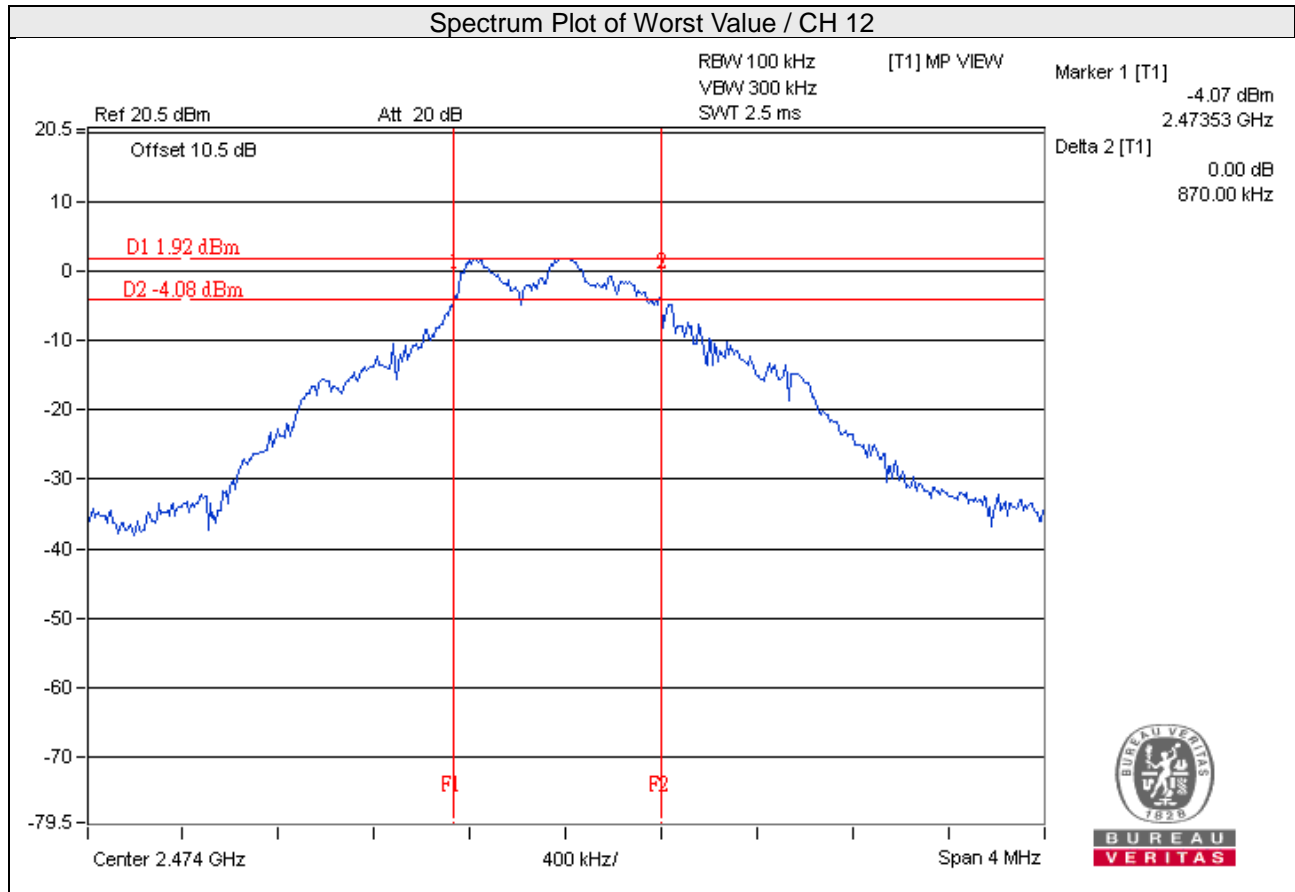

#### 4.4 Conducted Output Power Measurement

##### 4.4.1 Limits of Conducted Output Power Measurement

For systems using digital modulation in the 2400–2483.5 MHz bands: 1 Watt (30dBm)

##### 4.4.2 Test Setup

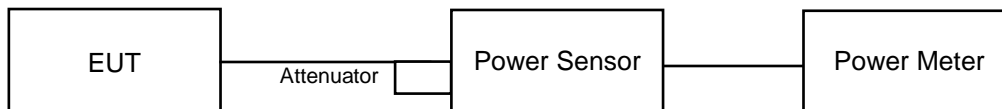

##### 4.4.3 Test Instruments

Refer to section 4.1.2 to get information of above instrument.

##### 4.4.4 Test Procedures

A peak / average power sensor was used on the output port of the EUT. A power meter was used to read the response of the peak / average power sensor. Record the power level.

##### 4.4.5 Deviation from Test Standard

No deviation.

##### 4.4.6 EUT Operating Conditions

Same as Item 4.3.6.



#### 4.4.7 Test Results

##### FOR PEAK POWER

Channel	Frequency (MHz)	Peak Power (mW)	Peak Power (dBm)	Limit (dBm)	Pass/Fail
1	2405	2.028	3.07	30	Pass
8	2444	1.888	2.76	30	Pass
12	2474	1.786	2.52	30	Pass

##### FOR AVERAGE POWER

Channel	Frequency (MHz)	Average Power (mW)	Average Power (dBm)
1	2405	2.009	3.03
8	2444	1.871	2.72
12	2474	1.766	2.47

## 4.5 Power Spectral Density Measurement

### 4.5.1 Limits of Power Spectral Density Measurement

The Maximum of Power Spectral Density Measurement is 8dBm.

### 4.5.2 Test Setup

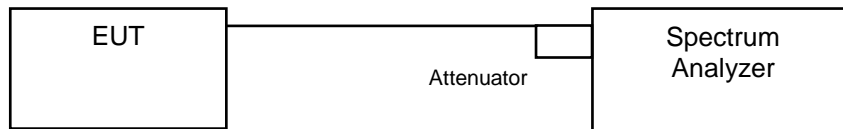

### 4.5.3 Test Instruments

Refer to section 4.1.2 to get information of above instrument.

### 4.5.4 Test Procedure

- a. Set analyzer center frequency to DTS channel center frequency.
- b. Set the span to 1.5 times the DTS bandwidth.
- c. Set the RBW to:  $3 \text{ kHz} \leq \text{RBW} \leq 100 \text{ kHz}$ .
- d. Set the VBW  $\geq 3 \times \text{RBW}$ .
- e. Detector = peak.
- f. Sweep time = auto couple.
- g. Trace mode = max hold.
- h. Allow trace to fully stabilize.
- i. Use the peak marker function to determine the maximum amplitude level within the RBW.

### 4.5.5 Deviation from Test Standard

No deviation.

### 4.5.6 EUT Operating Condition

Same as Item 4.3.6

#### 4.5.7 Test Results

Channel	Freq. (MHz)	PSD (dBm/3kHz)	Limit (dBm/3kHz)	Pass /Fail
1	2405	-11.21	8	Pass
8	2444	-12.00	8	Pass
12	2474	-12.34	8	Pass

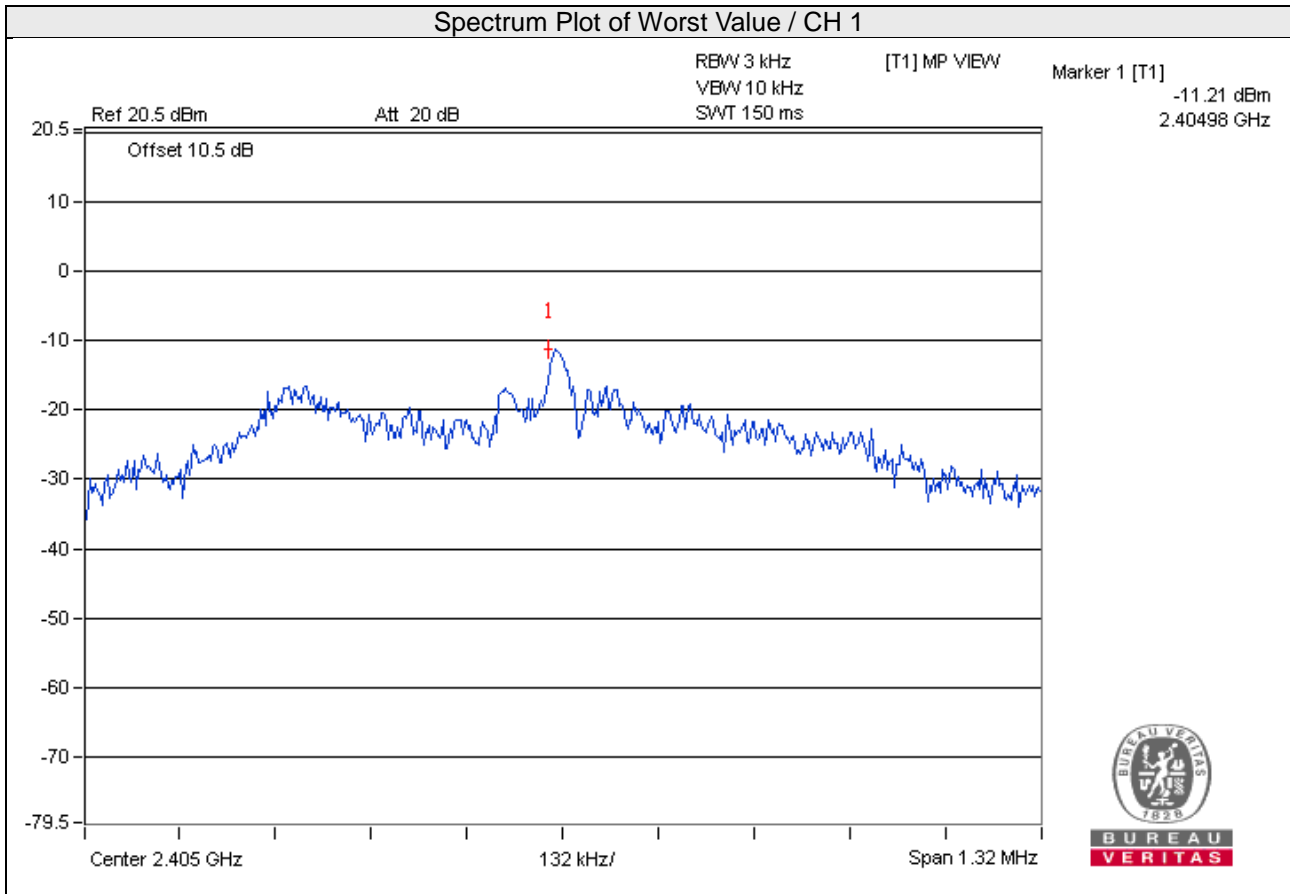

## 4.6 Conducted Out of Band Emission Measurement

### 4.6.1 Limits of Conducted Out of Band Emission Measurement

Below 20dBc of the highest emission level of operating band (in 100kHz Resolution Bandwidth).

### 4.6.2 Test Setup

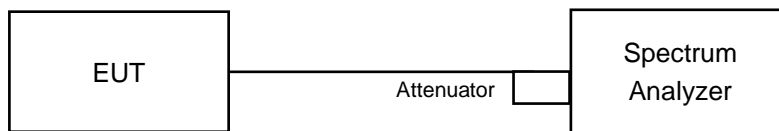

### 4.6.3 Test Instruments

Refer to section 4.1.2 to get information of above instrument.

### 4.6.4 Test Procedure

#### MEASUREMENT PROCEDURE REF

1. Set the RBW = 100 kHz.
2. Set the VBW  $\geq$  300 kHz.
3. Detector = peak.
4. Sweep time = auto couple.
5. Trace mode = max hold.
6. Allow trace to fully stabilize.
7. Use the peak marker function to determine the maximum power level in any 100 kHz band segment within the fundamental EBW.

#### MEASUREMENT PROCEDURE OOB

1. Set RBW = 100 kHz.
2. Set VBW  $\geq$  300 kHz.
3. Detector = peak.
4. Sweep = auto couple.
5. Trace Mode = max hold.
6. Allow trace to fully stabilize.
7. Use the peak marker function to determine the maximum amplitude level.

### 4.6.5 Deviation from Test Standard

No deviation.

### 4.6.6 EUT Operating Condition

Same as Item 4.3.6

### 4.6.7 Test Results

The spectrum plots are attached on the following pages. D1 line indicates the highest level, and D2 line indicates the 20dB offset below D1. It shows compliance with the requirement.

### CH 1

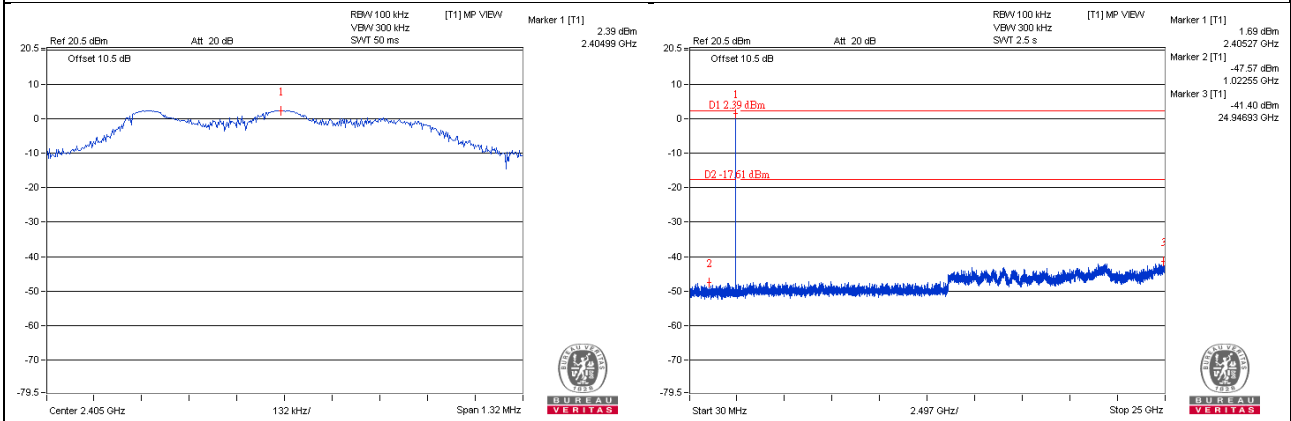

### CH 8

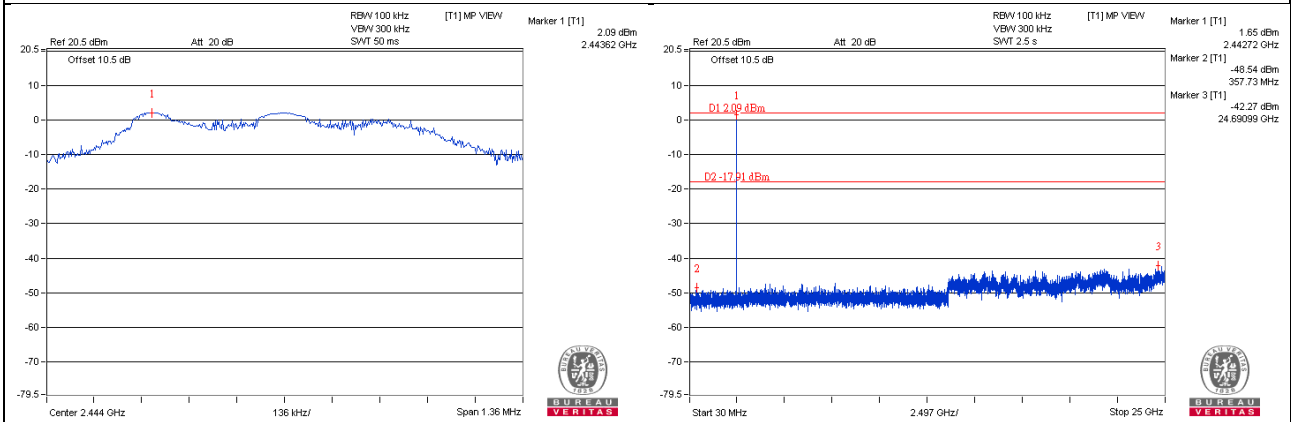

### CH 12

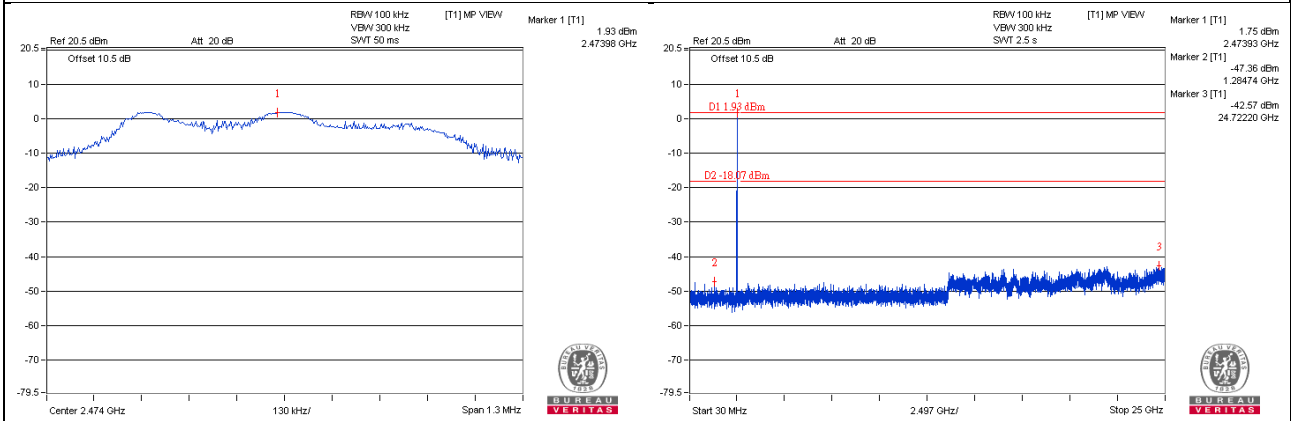

### CH 1 Band edge

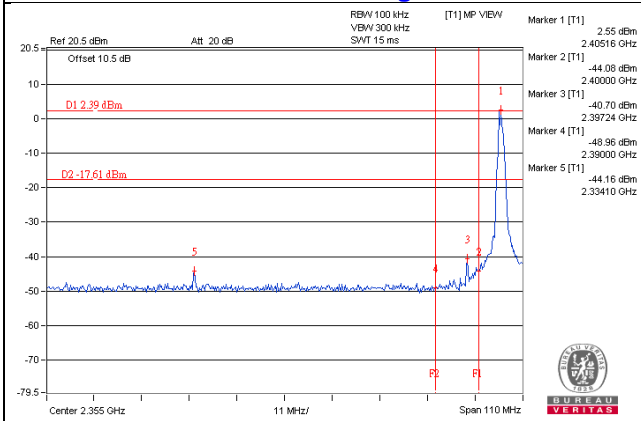

### CH 12 Band edge

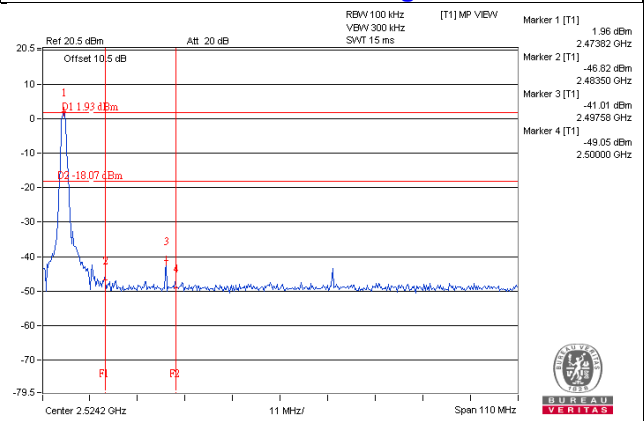

## 5 Pictures of Test Arrangements

Please refer to the attached file (Test Setup Photo).

## Appendix – Information on the Testing Laboratories

We, Bureau Veritas Consumer Products Services (H.K.) Ltd., Taoyuan Branch, were founded in 1988 to provide our best service in EMC, Radio, Telecom and Safety consultation. Our laboratories are accredited and approved according to ISO/IEC 17025.

If you have any comments, please feel free to contact us at the following:

**Linko EMC/RF Lab**

Tel: 886-2-26052180

Fax: 886-2-26051924

**Hsin Chu EMC/RF/Telecom Lab**

Tel: 886-3-6668565

Fax: 886-3-6668323

**Hwa Ya EMC/RF/Safety Lab**

Tel: 886-3-3183232

Fax: 886-3-3270892

**Email:** [service.adt@tw.bureauveritas.com](mailto:service.adt@tw.bureauveritas.com)

**Web Site:** [www.bureauveritas-adt.com](http://www.bureauveritas-adt.com)

The address and road map of all our labs can be found in our web site also.

--- END ---