



849 NW STATE ROAD 45  
NEWBERRY, FL 32669 USA  
PH: 888.472.2424 OR 352.472.5500  
FAX: 352.472.2030  
EMAIL: [INFO@TIMCOENGR.COM](mailto:INFO@TIMCOENGR.COM)  
[HTTP://WWW.TIMCOENGR.COM](http://WWW.TIMCOENGR.COM)

**FCC PART 74  
AND INDUSTRY CANADA RSS-123  
LOW POWER LICENSED TRANSMITTER  
TEST REPORT**

APPLICANT	AUDIO TECHNICA CORPORATION 2206 NARUSE, MACHIDA TOKYO 194 JAPAN
FCC ID	JFZT210AD
IC CERT	1752B-T210AD
MODEL NUMBER	ATW-T210aD
PRODUCT DESCRIPTION	BODYPACK WIRELESS MICROPHONE TRANSMITTER
DATE SAMPLE RECEIVED	3/2/2010
DATE TESTED	3/15/2010
TESTED BY	Nam Nguyen
APPROVED BY	Mario R. de Aranzeta
TIMCO REPORT NO.	457AUT10TestReport.doc
TEST RESULTS	<input checked="" type="checkbox"/> PASS <input type="checkbox"/> FAIL

**THE ATTACHED REPORT SHALL NOT BE REPRODUCED EXCEPT IN FULL  
WITHOUT THE WRITTEN APPROVAL OF TIMCO ENGINEERING, INC.**



Certificate # 0955-01

## TABLE OF CONTENTS

GENERAL REMARKS.....	3
GENERAL INFORMATION.....	4
TEST PROCEDURES .....	6
RF POWER OUTPUT.....	7
MODULATION CHARACTERISTICS .....	8
VOICE MODULATED COMMUNICATION EQUIPMENT.....	9
AUDIO INPUT VERSUS MODULATION .....	10
OCCUPIED BANDWIDTH.....	11
SPURIOUS EMISSIONS AT ANTENNA TERMINALS (CONDUCTED).....	13
FIELD STRENGTH OF SPURIOUS EMISSIONS .....	14
FREQUENCY STABILITY.....	16
EMC EQUIPMENT LIST .....	17

Applicant: AUDIO TECHNICA CORPORATION  
FCC ID: JFZT210AD  
IC #: 1752B-T210AD  
MODEL #: ATW-T210aD  
REPORT: A\AudioTechnica\_JFZ\457AUT10\457AUT10TestReport.doc

## GENERAL REMARKS

The attached report shall not be reproduced except in full without the written permission of Timco Engineering Inc.

The test results relate only to the items tested.

## Summary

The device under test does:

- fulfill the general approval requirements as identified in this test report  
 not fulfill the general approval requirements as identified in this test report

## Attestations

This equipment has been tested in accordance with the standards identified in this test report. To the best of my knowledge and belief, these tests were performed using the measurement procedures described in this report.

All instrumentation and accessories used to test products for compliance to the indicated standards are calibrated regularly in accordance with ISO 17025 requirements.



Certificate # 0955-01

I attest that the necessary measurements were made, under my supervision, at:

Timco Engineering Inc.  
849 NW State Road 45  
Newberry, Fl 32669



## Authorized Signatory Name:

Mario de Aranzeta C.E.T.  
Compliance Engineer/ Lab. Supervisor

**Date: 5/5/2010**

Applicant: AUDIO TECHNICA CORPORATION  
FCC ID: JFZT210AD  
IC #: 1752B-T210AD  
MODEL #: ATW-T210aD  
REPORT: A\AudioTechnica\_JFZ\457AUT10\457AUT10TestReport.doc

**GENERAL INFORMATION**

**RULES PART 2.1033**

**DUT TECHNICAL DESCRIPTION**

<b>DUT Description</b>	BODYPACK WIRELESS MICROPHONE TRANSMITTER
<b>FCC ID</b>	JFZT210AD
<b>IC Certification</b>	1752B-T210AD
<b>Model Number</b>	ATW-T210aD
<b>Modulation</b>	FM
<b>Type of Emission</b>	110KOF3E Bn = 2M+2DK M = 15000 D = 45 kHz (Peak Deviation) K = 1 Bn = 2(15k) + 2(45k)(1) = 120k
<b>Frequency Range</b>	(656.125 – 678.50) MHz
<b>Test Frequencies</b>	(656.12 , 669.75, and 678.50) MHz
<b>Maximum Output Power</b>	0.030W Conducted
<b>DUT Power Source</b>	<input type="checkbox"/> 110–120Vac/50– 60Hz
	<input type="checkbox"/> DC Power
	<input checked="" type="checkbox"/> Battery Operated Exclusively
<b>Test Item</b>	<input type="checkbox"/> Prototype
	<input checked="" type="checkbox"/> Pre-Production
	<input type="checkbox"/> Production
<b>Type of Equipment</b>	<input type="checkbox"/> Fixed
	<input type="checkbox"/> Mobile
	<input checked="" type="checkbox"/> Portable

Applicant: AUDIO TECHNICA CORPORATION  
 FCC ID: JFZT210AD  
 IC #: 1752B-T210AD  
 MODEL #: ATW-T210aD  
 REPORT: A\AudioTechnica\_JFZ\457AUT10\457AUT10TestReport.doc

**GENERAL INFORMATION**

<b>Test Facility</b>	Timco Engineering, Inc. 849 NW State Road 45, Newberry, FL 32669
<b>Test Condition</b>	The temperature was 26°C with a relative humidity of 50%.
<b>Modifications</b>	None
<b>Test Exercise (e.g software description, test signal, etc.)</b>	The DUT was placed in continuous transmit mode of operation.
<b>Applicable Standards</b>	ANSI/TIA 603-C:2004, FCC CFR 47 Parts 2 and 74, RSS-123 Issue 1, Rev. 2

Applicant: AUDIO TECHNICA CORPORATION  
 FCC ID: JFZT210AD  
 IC #: 1752B-T210AD  
 MODEL #: ATW-T210aD  
 REPORT: A\AudioTechnica\_JFZ\457AUT10\457AUT10TestReport.doc

## TEST PROCEDURES

**Power Line Conducted Interference:** The procedure used was ANSI/TIA 603-C:2004 using a 50uH LISN. Both lines were observed with the UUT transmitting. The bandwidth of the spectrum analyzer was 10 kHz with an appropriate sweep speed.

**Bandwidth 20 dB:** The measurements were made with the spectrum analyzer's resolution bandwidth (RBW) = 1 MHz and the video bandwidth (VBW) = 3 MHz and the span set as shown on plot.

**Power Output:** For a device with a fixed antenna, RF power is measured as ERP as the antenna is permanently attached. The substitution method was used as described in ANSI/TIA-603-C:2004.

**Antenna Conducted Emissions:** The RBW = 100 kHz, VBW = 300 kHz and the span set to 10.0 MHz and the spectrum was scanned from 30 MHz to the 10<sup>th</sup> Harmonic of the fundamental. Above 1 GHz the resolution bandwidth was 1 MHz and the VBW = 3 MHz and the span to 50 MHz.

**Radiation Interference:** The test procedure used was ANSI/TIA 603-C:2004 using an Agilent spectrum receiver with preselector. The bandwidth (RBW) of the spectrum receiver was 100 kHz up to 1 GHz and 1 MHz above 1 GHz with an appropriate sweep speed. The VBW above 1 GHz was 3 MHz. The analyzer was calibrated in dB above a microvolt at the output of the antenna.

Applicant: AUDIO TECHNICA CORPORATION  
FCC ID: JFZT210AD  
IC #: 1752B-T210AD  
MODEL #: ATW-T210aD  
REPORT: A\AudioTechnica\_JFZ\457AUT10\457AUT10TestReport.doc

## RF POWER OUTPUT

**Rule Part No.:** Part 2.1046(a), Part 74, RSS-123 Issue 1, Rev. 2

**Method of Measurement:** This device has an integrated antenna; RF power was measured as conducted. With a nominal battery voltage and the transmitter properly adjusted the RF output measures:

### Test Setup Diagram:

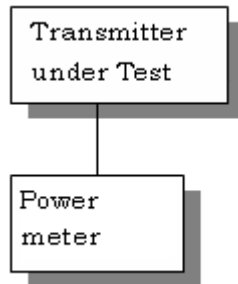

### Test Data:

OUTPUT POWER: 0.030 WATTS (High)  
0.010 WATTS (Low)

### Part 2.1033 (C)(8) DC Input into the final amplifier

INPUT POWER:  $(3.0V)(0.18A) = 0.54$  Watts  
 $(3.0V)(0.15A) = 0.45$  Watts

Applicant: AUDIO TECHNICA CORPORATION  
FCC ID: JFZT210AD  
IC #: 1752B-T210AD  
MODEL #: ATW-T210aD  
REPORT: A\AudioTechnica\_JFZ\457AUT10\457AUT10TestReport.doc

## MODULATION CHARACTERISTICS

**Rule Part No.:** Part 2.1047(a)(b), RSS-123 Issue 1, Rev. 2

### Method of Measurement:

*Audio frequency response*

The audio frequency response was measured in accordance with ANSI/TIA 603-C:2004 with no exception. A curve or equivalent data showing the frequency response of the audio modulating circuit over a range of 100 – 5000Hz shall be submitted. The audio frequency response curve is shown below.

### AUDIO FREQUENCY RESPONSE PLOT

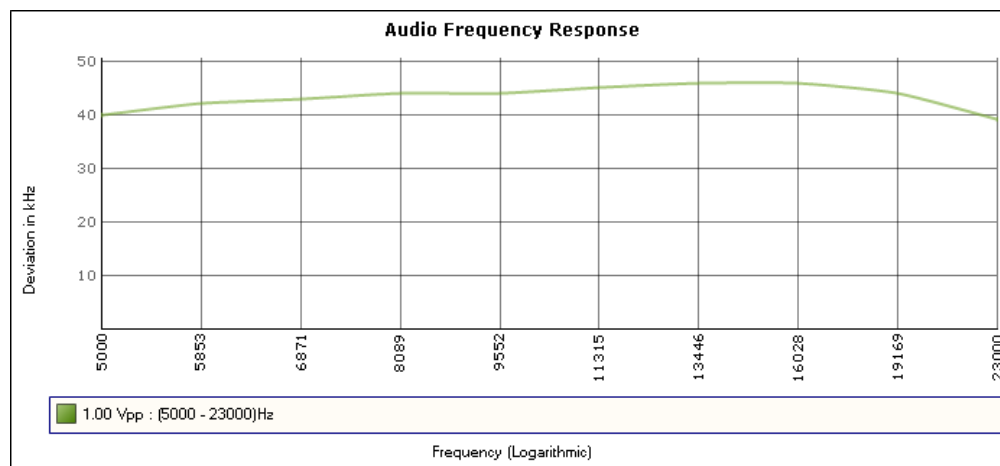
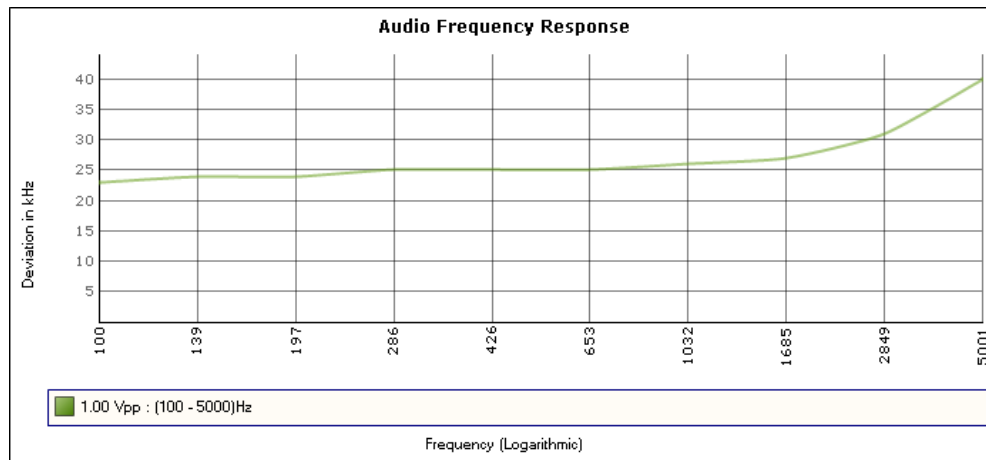

Applicant: AUDIO TECHNICA CORPORATION  
 FCC ID: JFZT210AD  
 IC #: 1752B-T210AD  
 MODEL #: ATW-T210aD  
 REPORT: A\AudioTechnica\_JFZ\457AUT10\457AUT10TestReport.doc



## **VOICE MODULATED COMMUNICATION EQUIPMENT**

**Part 2.1047(a) Voice modulated communication equipment:** For equipment required to have an audio low-pass filter, a curve showing the frequency response of the filter, or of all the circuitry installed between the modulation limiter and the modulated stage shall be submitted.

Audio low pass filter is not required in this unit.

Applicant: AUDIO TECHNICA CORPORATION  
FCC ID: JFZT210AD  
IC #: 1752B-T210AD  
MODEL #: ATW-T210aD  
REPORT: A\AudioTechnica\_JFZ\457AUT10\457AUT10TestReport.doc

## AUDIO INPUT VERSUS MODULATION

**Rule Part No.:** Part 2.1047(b) & 74, RSS-123 Issue 1, Rev. 2

### Test Requirements:

**Method of Measurement:** **Modulation cannot exceed 100%**, The audio input level needed for a particular percentage of modulation was measured in accordance with ANSI/TIA 603-C:2004. The audio input curves versus modulation are shown below. Curves are provided for audio input frequencies of 300, 1000, and 3000 Hz.

### Test data:

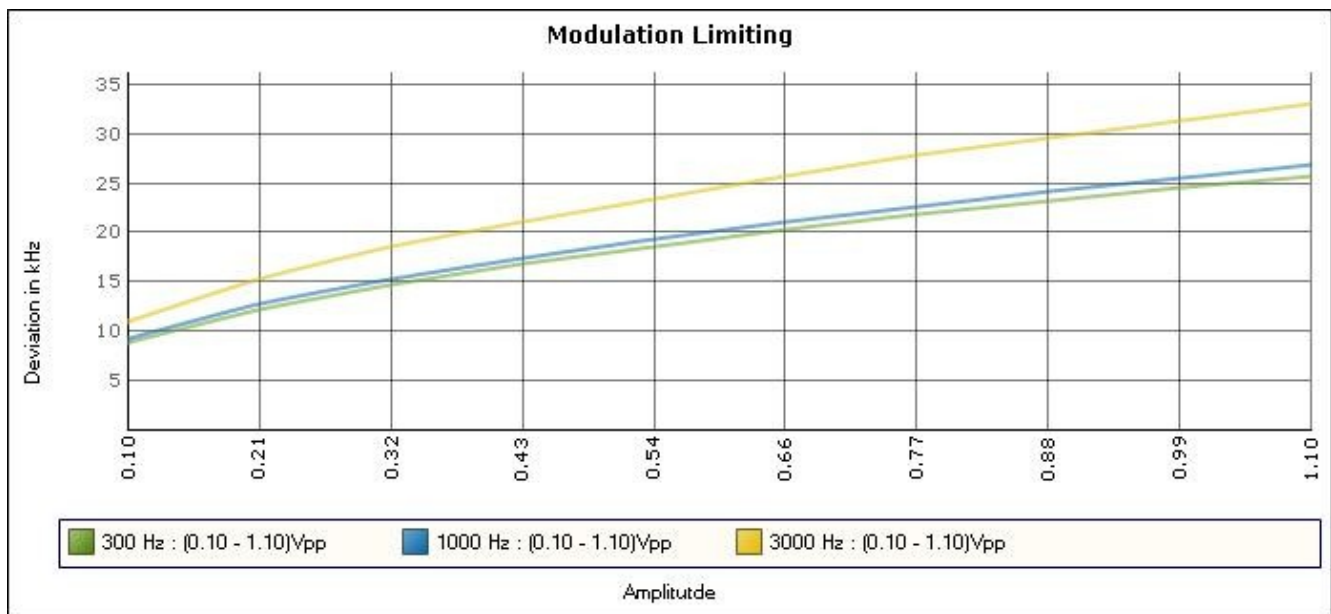

Applicant: AUDIO TECHNICA CORPORATION  
 FCC ID: JFZT210AD  
 IC #: 1752B-T210AD  
 MODEL #: ATW-T210aD  
 REPORT: A\AudioTechnica\_JFZ\457AUT10\457AUT10TestReport.doc

**OCCUPIED BANDWIDTH**

Data in the plots show that all sidebands between 50 & 100% for the authorized bandwidth are attenuated by at least 25dB. From 100 to 250% of the authorized bandwidth they are attenuated by at least 35dB and beyond 250% 43 log(Po) dB. The plot shows the transmitter modulated with 15000 Hz(the highest modulation frequency), adjusted for 50% modulation plus 16 dB. The spectrum analyzer was set with the unmodulated carrier at the top of the screen. The test procedure diagram and occupied bandwidth plot follows.

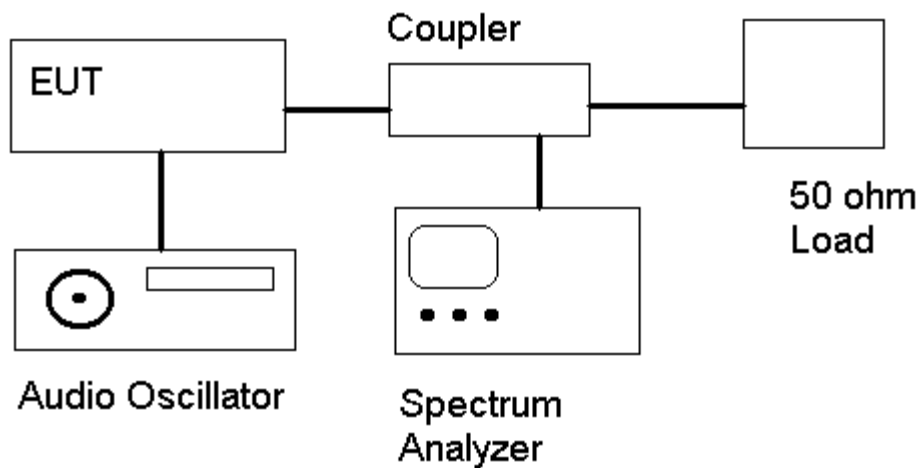

**OCCUPIED BANDWIDTH MEASUREMENT**

Applicant: AUDIO TECHNICA CORPORATION  
 FCC ID: JFZT210AD  
 IC #: 1752B-T210AD  
 MODEL #: ATW-T210aD  
 REPORT: A\AudioTechnica\_JFZ\457AUT10\457AUT10TestReport.doc

## OCCUPIED BANDWIDTH PLOT

**NOTES:**

AUDIO TECHNICA CORPORATION - FCC ID: JFZT210AD  
OCCUPIED BANDWIDTH PLOT

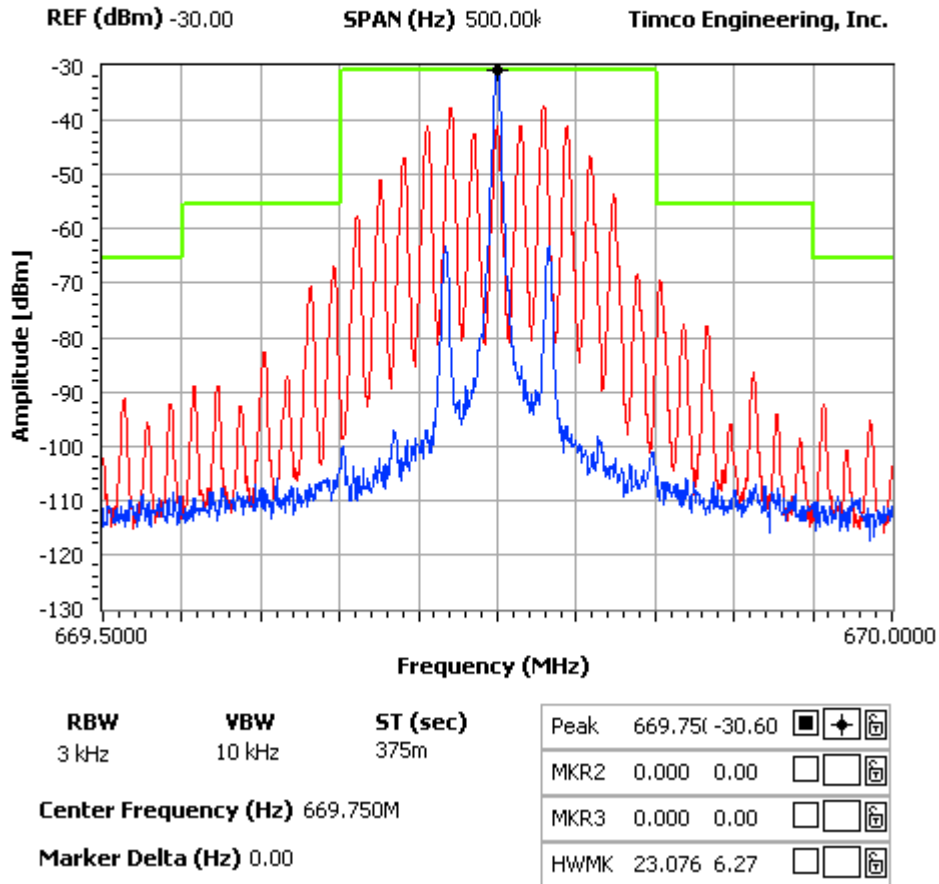

Applicant: AUDIO TECHNICA CORPORATION  
 FCC ID: JFZT210AD  
 IC #: 1752B-T210AD  
 MODEL #: ATW-T210aD  
 REPORT: A\AudioTechnica\_JFZ\457AUT10\457AUT10TestReport.doc



**SPURIOUS EMISSIONS AT ANTENNA TERMINALS (CONDUCTED)**

Not Applicable, no antenna connector.

Applicant: AUDIO TECHNICA CORPORATION  
FCC ID: JFZT210AD  
IC #: 1752B-T210AD  
MODEL #: ATW-T210aD  
REPORT: A\AudioTechnica\_JFZ\457AUT10\457AUT10TestReport.doc

**FIELD STRENGTH OF SPURIOUS EMISSIONS**

**Rule Parts. No.:** Part 2.1053, RSS-123 Issue 1, Rev. 2

**Requirements:** Emissions must be  $43 + 10\log(P_o)$  dB below the mean power output of the transmitter.

High Power:  $43 + 10 \log(0.030) = 27.8\text{dB}$

Low power:  $43 + 10 \log(0.010) = 23.0 \text{ dB}$

**METHOD OF MEASUREMENTS:** The tabulated data shows the results of the radiated field strength emissions test. The spectrum was scanned from 30 MHz to at least the tenth harmonic of the fundamental. This test was conducted per ANSI/TIA 603-C:2004 using the substitution method. Measurements were made at the test site of Timco Engineering, Inc. located at 849 NW State Road 45, Newberry, FL 32669.

**Test Setup Diagram:**

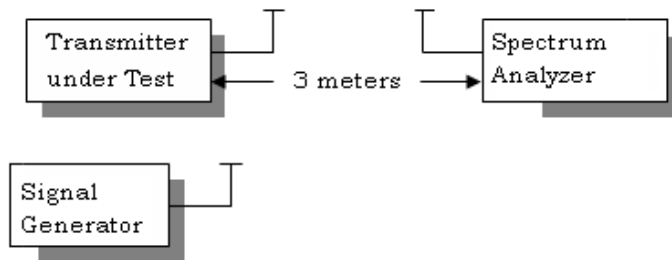

**Test Data:**

**High power:**

Emission Frequency MHz	Ant. Polarity	dB Below Carrier (dBc)
656.12	V	0
1312.23	V	49.50
1968.35	V	65.40
2624.46	V	68.80
3280.58	V	66.20
3936.69	V	53.10
4592.81	V	57.40
5248.92	V	65.90
5905.04	V	62.50
6561.15	V	61.40

Emission Frequency MHz	Ant. Polarity	dB Below Carrier (dBc)
669.75	V	0
1339.50	V	50.39
2009.25	V	67.19
2679.00	V	67.09
3348.75	V	64.19
4018.50	V	53.99
4688.25	V	57.69
5358.00	V	64.39
6027.75	V	62.39
6697.50	V	61.39

Emission Frequency MHz	Ant. Polarity	dB Below Carrier (dBc)
678.50	V	0
1357.00	V	52.96
2035.50	V	69.16
2714.00	V	66.66
3392.50	V	63.16
4071.00	V	52.16
4749.50	V	61.16
5428.00	V	65.66
6106.50	V	63.56
6785.00	V	62.36

Applicant: AUDIO TECHNICA CORPORATION  
 FCC ID: JFZT210AD  
 IC #: 1752B-T210AD  
 MODEL #: ATW-T210aD  
 REPORT: A\AudioTechnica\_JFZ\457AUT10\457AUT10TestReport.doc

**Low power:**

Emission Frequency MHz	Ant. Polarity	dB Below Carrier (dBc)
656.12	V	0
1312.23	V	48.20
1968.35	V	62.80
2624.46	V	64.30
3280.58	V	60.10
3936.69	V	58.30
4592.81	V	53.20
5248.92	V	62.50
5905.04	V	58.50
6561.15	V	57.60

Emission Frequency MHz	Ant. Polarity	dB Below Carrier (dBc)
669.75	V	0
1339.50	V	45.19
2009.25	V	63.39
2679.00	V	63.19
3348.75	V	60.89
4018.50	V	44.09
4688.25	V	59.89
5358.00	V	60.79
6027.75	V	58.79
6697.50	V	58.59

Emission Frequency MHz	Ant. Polarity	dB Below Carrier (dBc)
678.50	V	0
1357.00	V	49.86
2035.50	V	65.66
2714.00	V	64.76
3392.50	V	61.96
4071.00	V	46.46
4749.50	V	59.36
5428.00	V	60.86
6106.50	V	60.16
6785.00	V	58.36

Applicant: AUDIO TECHNICA CORPORATION  
 FCC ID: JFZT210AD  
 IC #: 1752B-T210AD  
 MODEL #: ATW-T210aD  
 REPORT: A\AudioTechnica\_JFZ\457AUT10\457AUT10TestReport.doc

**FREQUENCY STABILITY**

**Rule Parts. No.:** Part 2.1055, Part 74.861, RSS-123 Issue 1, Rev. 2

**Requirements:** Temperature and voltage tests were performed to verify that the frequency remains within the .0050%,(50 ppm)

**Method of Measurements:** ANSI/TIA 603-C:2004.

**The test was conducted as follows:** The transmitter was placed in the temperature chamber at 25 °C and allowed to stabilize for one hour. The transmitter was keyed ON for one minute during which four frequency readings were recorded at 15-second intervals. The worse case number used in the table below. The assigned channel frequency was considered to be the reference frequency. The temperature was then reduced to -30 °C after which the transmitter was again allowed to stabilize for one hour. The transmitter was keyed ON for one minute, and again frequency readings were noted at 15-second intervals. The worst-case number was again used in the table below. This procedure was repeated in 10-degree increments up to + 50 degrees C.

**Test Data:**

<b>Assigned Frequency (Ref. Frequency) (MHz)</b>		<b>669.749604</b>
<b>Temperature (°C)</b>	<b>Frequency (MHz)</b>	<b>Frequency Stability (PPM)</b>
-30	669.746582	-4.51
-20	669.749498	-0.16
-10	669.750904	1.94
0	669.751209	2.40
+10	669.750836	1.84
+20	669.750214	0.91
+30	669.749509	-0.14
+40	669.749219	-0.57
+50	669.749686	0.12

<b>Assigned Frequency (Ref. Frequency) (MHz)</b>		
<b>Battery %</b>	<b>Frequency (MHz)</b>	<b>Frequency Stability (PPM)</b>
-15%	669.749604	0.00
0	669.749604	0.00
+15%	669.749603	0.00

Applicant: AUDIO TECHNICA CORPORATION  
 FCC ID: JFZT210AD  
 IC #: 1752B-T210AD  
 MODEL #: ATW-T210aD  
 REPORT: A\AudioTechnica\_JFZ\457AUT10\457AUT10TestReport.doc



## EMC EQUIPMENT LIST

Device	Manufacturer	Model	Serial Number	Cal/Char Date	Due Date
3-Meter Semi-Anechoic Chamber	Panashield	N/A	N/A	Listed 3/10/10	3/10/12
AC Voltmeter	HP	400FL	2213A14499	CAL 3/23/09	3/23/11
Antenna: Dipole Kit	Electro-Metrics	TDA-30/1-4	153	CHAR 6/10/09	6/10/11
Frequency Counter	HP	5385A	3242A07460	CAL 5/26/09	5/26/11
Hygro-Thermometer	Extech	445703	0602	CAL 1/30/09	1/30/11
Modulation Analyzer	HP	8901A	3435A06868	CAL 5/26/09	5/26/11
Digital Multimeter	Fluke	FLUKE-77-3	79510405	CAL 5/18/09	5/18/11
Analyzer Tan Tower Preamplifier	HP	8449B-H02	3008A00372	CAL 11/21/09	11/21/11
Analyzer Tan Tower Quasi-Peak Adapter	HP	85650A	3303A01690	CAL 11/22/09	11/22/11
Analyzer Tan Tower RF Preselector	HP	85685A	3221A01400	CAL 11/21/09	11/21/11
Analyzer Tan Tower Spectrum Analyzer	HP	8566B Opt 462	3138A07786 3144A20661	CAL 11/24/09	11/24/11
Temperature Chamber	Tenney Engineering	TTRC	11717-7	CHAR 4/25/10	4/25/12

Applicant: AUDIO TECHNICA CORPORATION  
 FCC ID: JFZT210AD  
 IC #: 1752B-T210AD  
 MODEL #: ATW-T210aD  
 REPORT: A\AudioTechnica\_JFZ\457AUT10\457AUT10TestReport.doc