



Willow Run Test Labs, LLC
8501 Beck Road, Building 2227
Belleville, Michigan 48111 USA
Tel: (734) 252-9785
Fax: (734) 926-9785
e-mail: info@wrtest.com

Testing of

Electromagnetic Emissions

per



USA: CFR Title 47, Part 15.231 (Emissions)
USA: CFR Title 47, Part 2.1091;2.1093 (Exposure)
Canada: ISED RSS-210/GENe (Emissions)
Canada: ISED RSS-102 (Exposure)

are herein reported for

Martec Access Products Inc. GDA100

Test Report No.: 20160803-RPTMART10002Ar0
Copyright © 2016

Applicant/Provider:
Martec Access Products Inc.
60 Kingsbridge Road, Piscataway New Jersey 08854 USA
Phone: +1 (908) 233-0691, Fax: +1 (908) 233-576
Contact Person: Menashe Ben-David; mbendavid@marsint.com

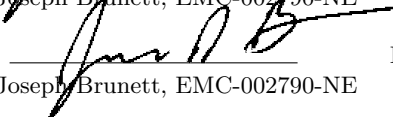
Measured by:		Report Approved by:	
	Dr. Joseph Brunett, EMC-002790-NE		Dr. Joseph Brunett, EMC-002790-NE
Report by:		Report Date of Issue:	August 3, 2016
	Dr. Joseph Brunett, EMC-002790-NE		

Results of testing completed on (or before) June 15, 2016 are as follows.

Emissions: The transmitter intentional emissions **COMPLY** with the regulatory limit(s) by no less than 5.7 dB.
Transmit chain spurious or harmonic emissions **COMPLY** by no less than 1.0 dB.

Revision History

Rev. No.	Date	Details	Revised By
r0	August 3, 2016	Initial Release.	J. Brunett

Contents

Revision History	2
Table of Contents	2
1 Test Specifications, Procedures, Location, and Equipment List	4
1.1 Test Specification and General Procedures	4
1.2 Test Location	5
1.3 Equipment Used	5
2 Configuration and Identification of the Equipment Under Test	6
2.1 Description and Declarations	6
2.1.1 EUT Configuration	6
2.1.2 Modes of Operation	6
2.1.3 Variants	6
2.1.4 Test Samples	7
2.1.5 Functional Exerciser	7
2.1.6 Modifications Made	7
2.1.7 Production Intent	7
2.1.8 Declared Exemptions and Additional Product Notes	7
3 Emissions	8
3.1 General Test Procedures	8
3.1.1 Radiated Test Setup and Procedures	8
3.1.2 Conducted Emissions Test Setup and Procedures	10
3.1.3 Power Supply Variation	10
3.1.4 Thermal Variation	10
3.2 Intentional Emissions	11
3.2.1 Fundamental Emission Pulsed Operation	11
3.2.2 Fundamental Emission Bandwidth	13
3.2.3 Fundamental Emission Field Strength	15
3.2.4 Exposure and Potential Health Hazard	16
3.3 Unintentional Emissions	17
3.3.1 Transmit Chain Spurious Emissions	17
4 Measurement Uncertainty	18

List of Tables

1	Test Site List.	5
2	Equipment List.	5
3	EUT Declarations.	6
4	Fundamental Emission Pulsed Operation.	11
5	Fundamental Emission Bandwidth.	13
6	Fundamental Emission Field Strength.	15
7	Electromagnetic Field Exposure.	16

8 Transmit Chain Spurious Emissions. 17
9 Measurement Uncertainty. 18

List of Figures

1 Photos of EUT. 6
2 EUT Test Configuration Diagram. 7
3 Radiated Emissions Diagram of the EUT. 8
4 Radiated Emissions Test Setup Photograph(s). 9
5 Fundamental Emission Pulsed Operation. 12
6 Fundamental Emission Bandwidth. 14

1 Test Specifications, Procedures, Location, and Equipment List

1.1 Test Specification and General Procedures

The ultimate goal of Martec Access Products Inc. is to demonstrate that the Equipment Under Test (EUT) complies with the Rules and/or Directives below. Detailed in this report are the results of testing the Martec Access Products Inc. GDA100 for compliance to:

Country/Region	Rules or Directive	Referenced Section(s)
United States	Code of Federal Regulations	CFR Title 47, Part 15.231
Canada	ISED Canada	ISED RSS-210/GENe

Martec Access Products Inc. has determined that the equipment under test is subject to the rules and directives above at the date of this testing. In conjunction with these rules and directives, the following specifications and procedures are followed herein to demonstrate compliance (in whole or in part) with these regulations.

ANSI C63.4:2014	"Methods of Measurement of Radio-Noise Emissions from Low-Voltage Electrical and Electronic Equipment in the Range of 9 kHz to 40 GHz"
ANSI C63.10:2013 (USA)	"American National Standard of Procedures for Compliance Testing of Unlicensed Wireless Devices"
CFR 47 2.1091/1093	"447498 D01 General RF Exposure Guidance v06: RF Exposure Procedures and Equipment Authorization Policies for Mobile and Portable Devices"
ISED Canada	"The Measurement of Occupied Bandwidth"
ISED Canada RSS-102	"Radio Frequency (RF) Exposure Compliance of Radiocommunication Apparatus (All Frequency Bands)"

1.2 Test Location

The EUT was fully tested by **Willow Run Test Labs, LLC**, 8501 Beck Road, Building 2227, Belleville, Michigan 48111 USA. Test Facility description and attenuation characteristics are on file with the FCC Laboratory, Columbia, Maryland (FCC Reg. No: 688478) and with ISED Canada, Ottawa, ON (File Ref. No: IC 8719A-1). Table 1 lists all site(s) employed herein. Specific test sites utilized are also listed in the test results sections of this report.

Table 1: Test Site List.

Description	Location	Quality Num.
OATS (3 meter)	8501 Beck Rd. Bldg 2227, Belleville MI 48111	OATSA

1.3 Equipment Used

Pertinent test equipment used for measurements at this facility is listed in Table 2. The quality system employed at Willow Run Test Labs, LLC has been established to ensure all equipment has a clearly identifiable classification, calibration expiry date, and that all calibrations are traceable to the SI through NIST, other recognized national laboratories, accepted fundamental or natural physical constants, ratio type of calibration, or by comparison to consensus standards.

Table 2: Equipment List.

Description	Manufacturer/Model	SN	Quality Num.	Last Cal By / Date Due
Spectrum Analyzer	Rhode-Schwarz / FSV30	101660	RSFSV30001	RS / May-2018
Biconical	EMCO / 93110B	9802-3039	BICEMCO01	Lib. Labs / Aug-2017
Log Periodic Antenna	EMCO / 3146	9305-3614	LOGEMCO01	Lib. Labs / April-2017
Dipole Set (20-1000 MHz)	EMCO / 3121C	9504-1121	DIPEMCO01	Lib. Labs / Sep-2016
Quad Ridge Horn	ETS Lind. / 3164-04	00066988	HRNQR316401	Lib. Labs / April-2017

2 Configuration and Identification of the Equipment Under Test

2.1 Description and Declarations

The equipment under test is a Wireless Garage Door Opener transmitter. The EUT is approximately 6.5 x 4 x 1.5 cm (approx.) in dimension, and is depicted in Figure 1. It is powered by a 2 x 3 VDC Lithium coin cell batteries. In use, this device is hand held or clipped onto a vehicle visor. Table 3 outlines provider declared EUT specifications.

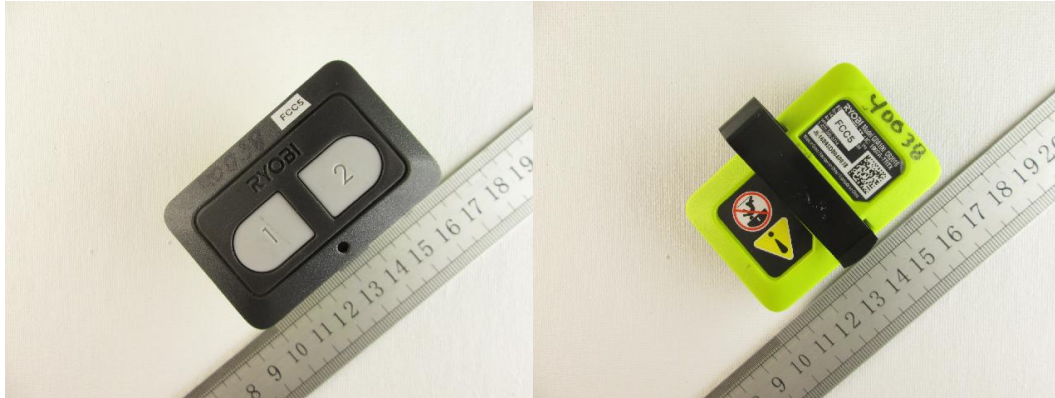

Figure 1: Photos of EUT.

Table 3: EUT Declarations.

General Declarations			
Equipment Type:	Garage Door Transmitter	Country of Origin:	USA
Nominal Supply:	2 x 3 VDC	Oper. Temp Range:	Not Declared
Frequency Range:	372 MHz	Antenna Dimension:	Not Declared
Antenna Type:	PCB trace (Integral)	Antenna Gain:	Not Declared
Number of Channels:	1	Channel Spacing:	Not Applicable
Alignment Range:	Not Declared	Type of Modulation:	ASK
United States			
FCC ID Number:	JCQTTI-TX	Classification:	DSC
Canada			
IC Number:	1907A-TTITX	Classification:	Remote Control Device

2.1.1 EUT Configuration

The EUT is configured for testing as depicted in Figure 2.

2.1.2 Modes of Operation

The EUT transmits in only a single mode, when its button is pressed.

2.1.3 Variants

There is only a single variant of the EUT.

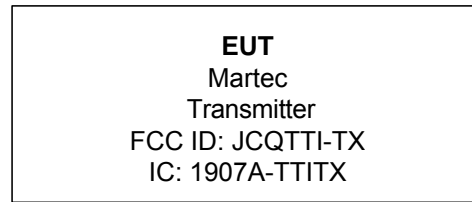

Figure 2: EUT Test Configuration Diagram.

2.1.4 Test Samples

Two samples in total were provided. One sample set for CW transmission and one normal operating sample capable of manually activated transmissions via button press.

2.1.5 Functional Exerciser

Normal operating EUT functionality was verified by observation of transmitted signal.

2.1.6 Modifications Made

There were no modifications made to the EUT by this laboratory.

2.1.7 Production Intent

The EUT appears to be a pre-production prototype. Manufacturer declares that the PCB is final production and that the plastic material used to fabricate the chassis is representative of the final product's material.

2.1.8 Declared Exemptions and Additional Product Notes

None.

3 Emissions

3.1 General Test Procedures

3.1.1 Radiated Test Setup and Procedures

Radiated electromagnetic emissions from the EUT are first pre-scanned in our shielded anechoic chamber or GTEM test cell. Spectrum and modulation characteristics of all emissions are recorded. Instrumentation, including spectrum analyzers and other test equipment as detailed in Section 1.2 are employed. After pre-scan, emission measurements are made on the test site of record. If the EUT connects to auxiliary equipment and is table or floor standing, the configurations prescribed in relevant test standards are followed. Alternatively, a layout closest to normal use (as declared by the provider) is employed if the resulting emissions appear to be worst-case in such a configuration. See Figure 3. All intentionally radiating elements that are not fixed-mounted in use are placed on the test table lying flat, on their side, and on their end (3-axes) and the resulting worst case emissions are recorded. If the EUT is fixed-mounted in use, measurements are made with the device oriented in the manner consistent with installation and then emissions are recorded.

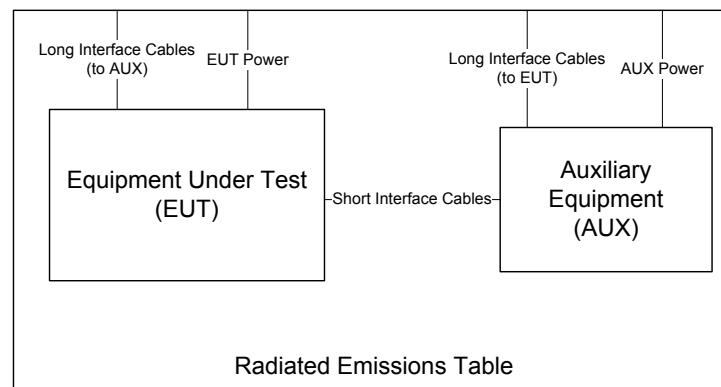

Figure 3: Radiated Emissions Diagram of the EUT.

If the EUT exhibits spurious emissions due to internal receiver circuitry, such emissions are measured with an appropriate carrier signal applied. For devices with intentional emissions below 30 MHz, a shielded loop antenna is used. It is placed at a 1 meter receive height. Emissions between 30 MHz and 1 GHz are measured using tuned dipoles and/or calibrated broadband antennas. For both horizontal and vertical polarizations, the test antenna is raised and lowered from 1 to 4 m in height until a maximum emission level is detected. The EUT is then rotated through 360° in azimuth until the highest emission is detected. The test antenna is then raised and lowered one last time from 1 to 4 m and the worst case value is recorded. Emissions above 1 GHz are characterized using standard gain horn or broadband ridge-horn antennas on our OATS with a 4 × 5 m rectangle of H-4 absorber placed over the ground screen covering the OATS ground screen. Care is taken to ensure that test receiver resolution and video bandwidths meet the regulatory requirements, and that the emission bandwidth of the EUT is not reduced. Photographs of the test setup employed are depicted in Figure 4.

Where regulations allow for direct measurement of field strength, power values (dBm) measured on the test receiver / analyzer are converted to dBμV/m at the regulatory distance, using

$$E_{dist} = 107 + P_R + K_A - K_G + K_E - C_F$$

where P_R is the power recorded on spectrum analyzer, in dBm, K_A is the test antenna factor in dB/m, K_G is the combined pre-amplifier gain and cable loss in dB, K_E is duty correction factor (when applicable) in dB, and C_F is a distance conversion (employed only if limits are specified at alternate distance) in dB. This field strength value is then compared with the regulatory limit. If effective isotropic radiated power (EIRP) is computed, it is computed as

$$EIRP(dBm) = E_{3m}(dB\mu V/m) - 95.2.$$

When presenting data at each frequency, the highest measured emission under all possible EUT orientations (3-axes) is reported.

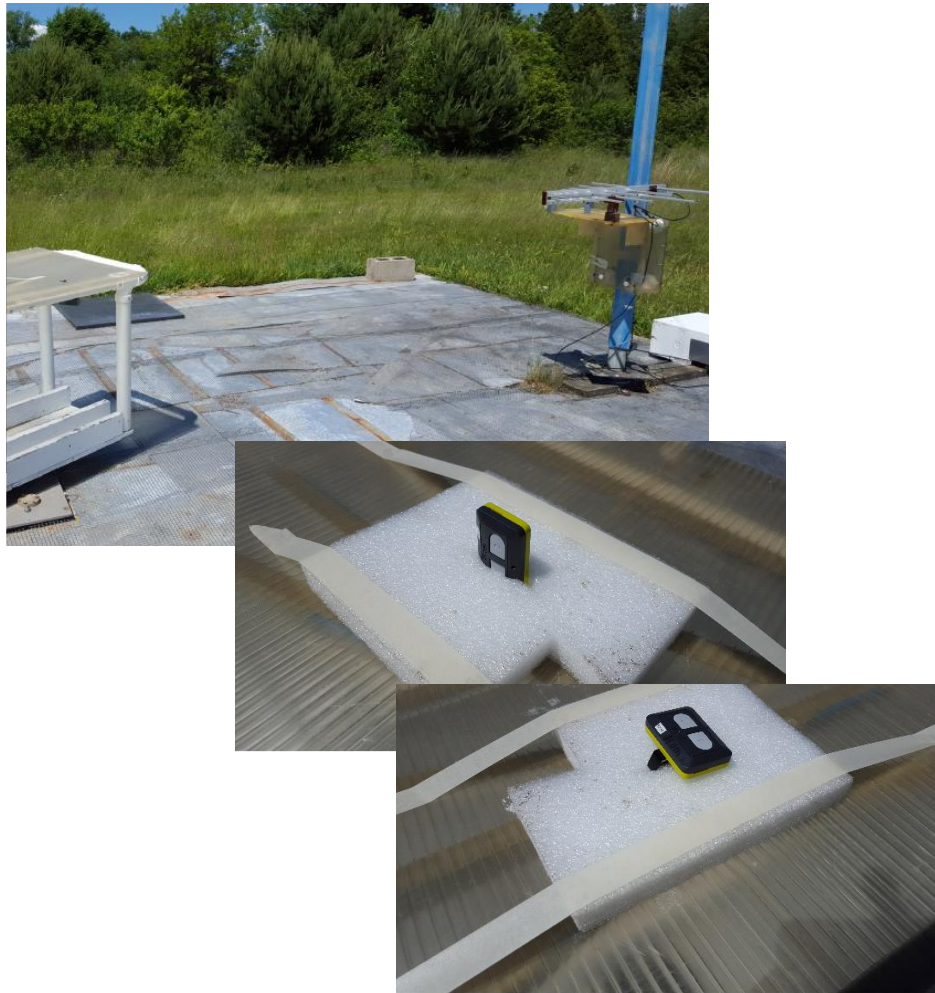

Figure 4: Radiated Emissions Test Setup Photograph(s).

3.1.2 Conducted Emissions Test Setup and Procedures

Battery Power Conducted Spurious The EUT is not subject to measurement of power line conducted emissions as it is powered solely by its internal battery.

3.1.3 Power Supply Variation

Tests at extreme supply voltages are made if required by the the procedures specified in the test standard, and results of this testing are detailed in this report.

In the case the EUT is designed for operation from a battery power source, the extreme test voltages are evaluated over the range specified in the test standard; no less than $\pm 10\%$ of the nominal battery voltage declared by the manufacturer. For all battery operated equipment, worst case intentional and spurious emissions are re-checked employing a new (fully charged) battery.

3.1.4 Thermal Variation

Tests at extreme temperatures are made if required by the procedures specified in the test standard, and results of this testing are detailed in this report. The provider has declared that the EUT is designed for operation over the temperature range Not Declared. Before any temperature measurements are made, the equipment is allowed to reach a thermal balance in the test chamber, temperature and humidity are recorded, and thermal balance is verified via a thermocouple-based probe.

3.2 Intentional Emissions

3.2.1 Fundamental Emission Pulsed Operation

Test Setup & Procedure The test equipment and facilities were setup in accordance with the standards and procedures listed in Section 1.1. Environmental conditions were set at the appropriate temperature and thermal balance was checked with a thermocouple based probe. Duty cycle is reported for all relevant modes of operation. The test equipment employed includes RSFSV30001, DIPEMC001.

Measurement Results The details and results of testing the EUT are summarized in Table 4. Plots showing the measurements made to obtain these values are provided in Figure 5.

Table 4: Fundamental Emission Pulsed Operation.

Detector	Span	IF Bandwidth	Video Bandwidth	Test Date:	18-Jun-16
Pk	0	1 MHz	3 MHz	Test Engineer:	Joseph Brunett
				EUT:	Martec 372MHz
				EUT Mode:	Modulated
				Meas. Distance:	10 cm

FCC/IC									
#	EUT Test Mode*	Overall Transmission			Internal Frame Characteristics			Computed Duty Cycle	
		Min. Repetition Rate (sec)	Max. No. of Frames	Total Transmission Length (sec)	Max. Frame Length (ms)	Min. Frame Period (ms)	Frame Encoding	(%)	(dB)
1	Worst-Case Manual Button Press	Single	10	<5	48.0000	103.0	When manually actuated by momentary button press the EUT transmits 10 frames ASK data. Each frame is 48 ms in duration, with a period of 103 ms. Frames consist of 4.7 ms of 50% duty cycle wake-up followed by 68 PWM pulses with a maximum bit width of 0.41 ms each.	30.2	-10.4

Example Calculation: Worst Case Duty (%) = (4.7ms x 0.5 + 68 x 0.41 ms) / 100 ms = 30.2 %
 Equipment Used: DIPEMC001, RSFSV30001

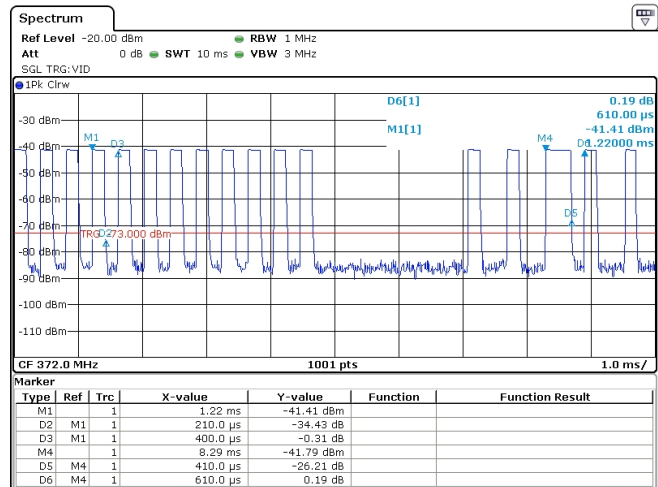
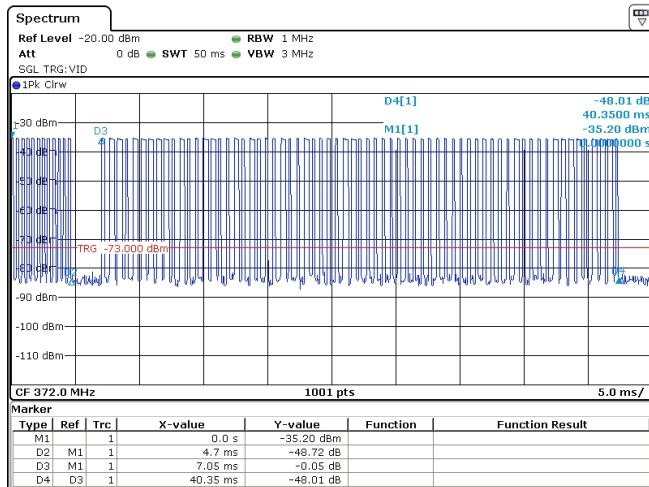
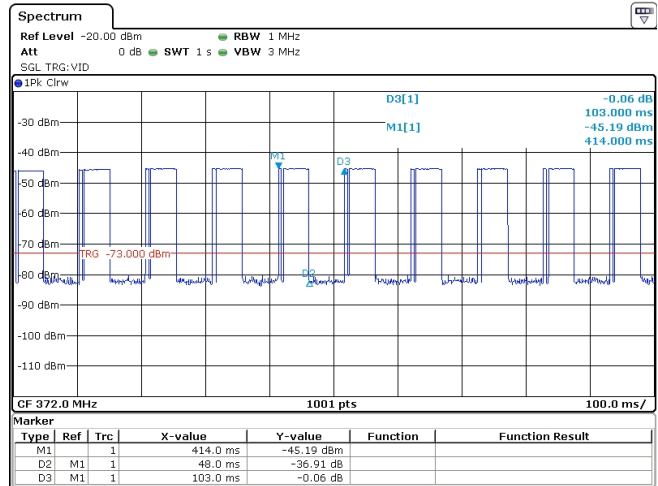
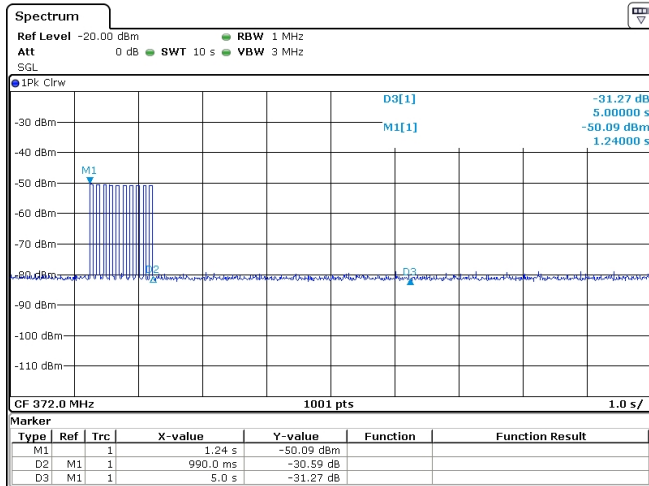

Figure 5: Fundamental Emission Pulsed Operation.

3.2.2 Fundamental Emission Bandwidth

Test Setup & Procedure The test equipment and facilities were setup in accordance with the standards and procedures listed in Section 1.1. Environmental conditions were set at the appropriate temperature and thermal balance was checked with a thermocouple based probe. Emission bandwidth (EBW) of the EUT is measured with the device placed in the test mode(s) with the shortest available frame length and minimum frame spacing. The 20 dB EBW is measured as the max-held peak-detected signal when the IF bandwidth is greater than or equal to 1% of the receiver span. For complex modulations other than ASK and FSK, the 99% emission bandwidth per IC test procedures has a different result, and is also reported. The test equipment employed includes RSFSV30001, DIPEMC001.

Measurement Results The details and results of testing the EUT are summarized in Table 5. Plots showing the measurements made to obtain these values are provided in Figure 6.

Table 5: Fundamental Emission Bandwidth.

Detector	IF Bandwidth	Video Bandwidth	Test Date:	31-May-16
Pk	10 kHz	30 kHz	Test Engineer:	Joseph Brunett
			EUT:	Martec 372MHz
			EUT Mode:	Modulated
			Meas. Distance:	10 cm

							FCC/IC
#	Modulation	Center Frequency (MHz)	20 dB EBW (MHz)	EBW Limit (MHz)	99% EBW (MHz)		
1	ASK	372	0.0609	0.9300	0.1528		
2							

Equipment Used: DIPEMC001, RSFSV30001

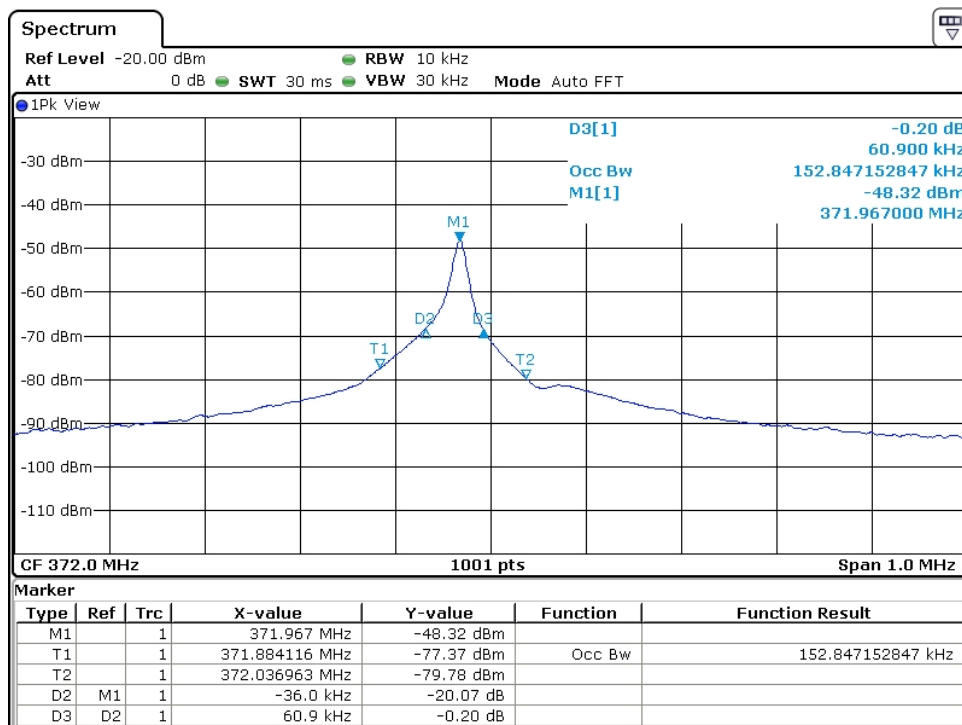

Figure 6: Fundamental Emission Bandwidth.

3.2.3 Fundamental Emission Field Strength

Test Setup & Procedure The test equipment and facilities were setup in accordance with the standards and procedures listed in Section 1.1. Environmental conditions were set at the appropriate temperature and thermal balance was checked with a thermocouple based probe. Fundamental emissions are measured at the regulatory distance on our OATS. The test equipment employed includes RSFSV30001, DIPEMC001.

Measurement Results The details and results of testing the EUT are summarized in Table 6.

Table 6: Fundamental Emission Field Strength.

Frequency Range	Det	IF Bandwidth	Video Bandwidth	Test Date:	18-Jun-16
25 MHz f 1 000 MHz	Pk/QPk	120 kHz	300 kHz	Test Engineer:	Joseph Brunett
f > 1 000 MHz	Pk	1 MHz	3 MHz	EUT:	Martec 372MHz
f > 1 000 MHz	Avg	1 MHz	10 kHz	EUT Mode:	CW
				Meas. Distance:	3 meters

													FCC/IC	
#	Freq. MHz	Ant. Used	Ant. Pol.	Pr (Pk) dBm	Pr (Avg)* dBm	Ka dB/m	Kg dB	E3(Pk) dBµV/m	E3(Avg) dBµV/m	FCC/IC E3(Avg) Lim. dBµV/m	Pass dB	Comments		
1	With Visor Clip													
2	372.0	LOGP	H	-8.5	-18.9	15.2	31.0	82.7	72.3	78.5	6.2	flat		
3	372.0	LOGP	V	-11.3	-21.7	15.2	31.0	79.9	69.5	78.5	9.0	side		
4	Without Visor Clip													
5	372.0	LOGP	H	-8.0	-18.4	15.2	31.0	83.2	72.8	78.5	5.7	flat		
6	372.0	LOGP	V	-11.7	-22.1	15.2	31.0	79.5	69.1	78.5	9.4	side		
7														
8														
9														
#	Freq. MHz	DC Supply Voltage		Relative Pr (Pk) dBm**										
10	372.0	2.60		-8.8										
11	372.0	2.80		-8.2										
12	372.0	3.00		-8.0										
13	372.0	3.15		-7.9										
14	372.0	3.30		-7.6										

*Avg data computed from Peak Measured Data and EUT Duty Cycle. EUT in CW mode.

Equipment Used: DIPEMC001, RSFSV30001

3.2.4 Exposure and Potential Health Hazard

To demonstrate compliance with with regulations that place limitations on human electromagnetic field exposure for both the general public and for workers, we compute EIRP from measured emission data. These levels are compared with limits placed by the directives and recommendations detailed in Section 1.1. Table 7 details the results of these computations.

Table 7: Electromagnetic Field Exposure.

USA REF: 2.1091/1093, 447498 D01 General RF Exposure Guidance v06	Test Date: 18-Jun-16
IC REF: RSS-102 Issue 5	Test Engineer: Joseph Brunett
Min. Sep. Distance: <5mm	EUT: Martec 372MHz
	EUT Mode: CW
	Meas. Distance: 3 meters

Freq. MHz	E3(Pk)* dBμV/m	Duty Factor dB	E3(Avg)** dBuV/m	EIRP(Avg)** dBm	EIRP(Avg)** mW
372.00	83.2	.0	83.2	-12.0	.0632337
Canada			USA		
Calculated SAR Threshold (Avg) mW	1-g SAR Body Power Threshold Exclusion Limit (Avg) mW	10-g SAR Extremity Power Threshold Exclusion Limit (Avg) mW	Calculated SAR Threshold (Avg)	1-g SAR Body Power Threshold Exclusion Limit (Avg)	10-g SAR Extremity Power Threshold Exclusion Limit (Avg)
.0632337	61.9	154.7	.0077135	3.0	7.5

*As Measured / Computed from highest fundamental emission, see fundamental emission section of this report.

**Only RMS level is required, RMS/6min << Pk, Peak emission employed to demonstrate compliance.

3.3 Unintentional Emissions

3.3.1 Transmit Chain Spurious Emissions

Test Setup & Procedure The test equipment and facilities were setup in accordance with the standards and procedures listed in Section 1.1. Environmental conditions were set at the appropriate temperature and thermal balance was checked with a thermocouple based probe. Spurious radiated emissions measurements are performed to 10 times the highest fundamental operating frequency. The test equipment employed includes RSFSV30001, HRNQR316401.

Measurement Results The details and results of testing the EUT are summarized in Table 8.

Table 8: Transmit Chain Spurious Emissions.

Frequency Range	Det	IF Bandwidth	Video Bandwidth	Test Date:	31-May-16
25 MHz f 1 000 MHz	Pk/QPk	120 kHz	300 kHz	Test Engineer:	Joseph Brunett
f > 1 000 MHz	Pk	1 MHz	3 MHz	EUT:	Martec 372MHz
f > 1 000 MHz	Avg	1 MHz	10kHz	EUT Mode:	CW
				Meas. Distance:	3 meters

Transmitter Unintentional Spurious Emissions												FCC/IC
#	Freq. MHz	Ant. Used	Ant. Pol.	Pr (Pk) dBm	Pr (Avg)* dBm	Ka dB/m	Kg dB	E3(Pk) dBµV/m	E3(Avg) dBµV/m	FCC/IC E3lim (Avg) dBµV/m	Pass dB	Comments
1 With Visor Clip												
2	744.0	LOGP	H	-37.2	-47.6	20.9	28.0	62.7	52.3	58.5	6.2	max all
3	744.0	LOGP	V	-42.9	-53.3	20.9	28.0	57.0	46.6	58.5	11.9	max all
4	1116.0	R-Horn	H/V	-68.0	-78.4	24.2	-0.2	63.4	53.0	54.0	1.0	max all
5	1488.0	R-Horn	H/V	-81.9	-92.3	27.0	-0.2	52.3	41.9	54.0	12.1	max all
6	1860.0	R-Horn	H/V	-78.9	-89.3	29.3	-0.2	57.6	47.2	58.5	11.4	max all
7	2232.0	R-Horn	H/V	-79.3	-89.7	31.0	-0.3	59.0	48.6	54.0	5.4	max all
8	2604.0	R-Horn	H/V	-90.3	-100.7	33.8	-0.3	50.8	40.4	58.5	18.1	max all
9	2976.0	R-Horn	H/V	-77.3	-87.7	36.3	-0.3	66.3	55.9	58.5	2.6	max all
10	3348.0	R-Horn	H/V	-86.2	-96.6	36.4	-0.4	57.6	47.2	54.0	6.8	max all
11	3720.0	R-Horn	H/V	-86.4	-96.8	34.8	-0.4	55.7	45.3	54.0	8.7	max all
12 Without Visor Clip												
13	744.0	LOGP	H	-37.2	-47.6	20.9	28.0	62.7	52.3	58.5	6.2	max all
14	744.0	LOGP	V	-42.9	-53.3	20.9	28.0	57.0	46.6	58.5	11.9	max all
15	1116.0	R-Horn	H/V	-75.1	-85.5	24.2	-0.2	56.3	45.9	54.0	8.1	max all
16	1488.0	R-Horn	H/V	-79.5	-89.9	27.0	-0.2	54.7	44.3	54.0	9.7	max all
17	1860.0	R-Horn	H/V	-77.7	-88.1	29.3	-0.2	58.8	48.4	58.5	10.2	max all
18	2232.0	R-Horn	H/V	-80.3	-90.7	31.0	-0.3	58.0	47.6	54.0	6.4	max all
19	2604.0	R-Horn	H/V	-89.8	-100.2	33.8	-0.3	51.3	40.9	58.5	17.6	max all
20	2976.0	R-Horn	H/V	-75.9	-86.3	36.3	-0.3	67.7	57.3	58.5	1.2	max all
21	3348.0	R-Horn	H/V	-91.2	-101.6	36.4	-0.4	52.6	42.2	54.0	11.8	max all
22	3720.0	R-Horn	H/V	-87.4	-97.8	34.8	-0.4	54.7	44.3	54.0	9.7	max all
23												

*Avg data computed from Peak Measured Data and EUT Duty Cycle. EUT in CW mode.

Equipment Used: DIPEMC001, UMHORN005, RSFSV30001

4 Measurement Uncertainty

The maximum values of measurement uncertainty for the laboratory test equipment and facilities associated with each test are given in the table below. This uncertainty is computed for a 95.45% confidence level based on a coverage factor of $k = 2$.

Table 9: Measurement Uncertainty.

Measured Parameter	Measurement Uncertainty [†]
Radio Frequency	$\pm(f_{Mkr}/10^7 + RBW/10 + (SPN/(PTS - 1))/2 + 1 \text{ Hz})$
Conducted Emm. Amplitude	$\pm 1.8 \text{ dB}$
Radiated Emm. Amplitude (30 – 200 MHz)	$\pm 2.7 \text{ dB}$
Radiated Emm. Amplitude (200 – 1000 MHz)	$\pm 2.5 \text{ dB}$
Radiated Emm. Amplitude ($f > 1000 \text{ MHz}$)	$\pm 3.7 \text{ dB}$
DC and Low Frequency Voltages	$\pm 2\%$
Temperature	$\pm 0.5^\circ\text{C}$
Humidity	$\pm 5\%$

[†]Ref: CISPR 16-4-2:2011+A1:2014