



**FCC 47 CFR PART 15 SUBPART C AND ANSI C63.4:2003
TEST REPORT**

For

HK250

Model : HK250

Trade Name : Motorola

Issued for

Motorola Mobility Inc.

8000W.Sunrise Blvd,Suite A. Plantation,FL 33322 U.S.A.

Issued by

**Compliance Certification Services Inc.
Hsinchu Lab.**

**NO. 989-1 Wen Shan Rd., Shang Shan Village,
Qionglin Shiang Hsinchu County 30741, Taiwan, R.O.C**

TEL: +886-3-5921698

FAX: +886-3-5921108

<http://www.ccsrf.com>

E-Mail : service@ccsrf.com

Issued Date: January 02, 2012



Note: *This report shall not be reproduced except in full, without the written approval of Compliance Certification Services Inc. This document may be altered or revised by Compliance Certification Services Inc. personnel only, and shall be noted in the revision section of the document. The client should not use it to claim product endorsement by TAF or any government agencies. The test results of this report relate only to the tested sample identified in this report.*



Revision History

Rev.	Issue Date	Revisions	Effect Page	Revised By
00	12/19/2011	Initial Issue	All Page 83	Winnie Chen
01	01/02/2012	Revised the product name.	Page 1, 4, 5, 61 ~ 67	Winnie Chen



TABLE OF CONTENTS

TITLE	PAGE NO.
1. TEST REPORT CERTIFICATION	4
2. EUT DESCRIPTION	5
3. DESCRIPTION OF TEST MODES	6
4. TEST METHODOLOGY	7
5. FACILITIES AND ACCREDITATION	8
5.1 FACILITIES	8
5.2 ACCREDITATIONS.....	8
5.3 MEASUREMENT UNCERTAINTY	9
6. SETUP OF EQUIPMENT UNDER TEST.....	10-11
7. FCC PART 15.247 REQUIREMENTS	12
7.1 DUTY CYCLE CORRECTION FACTOR.....	12
7.2 20dB BANDWIDTH FOR HOPPING	13-18
7.3 MAXIMUM PEAK OUTPUT POWER	19-24
7.4 HOPPING CHANNEL SEPARATION.....	25-30
7.5 NUMBER OF HOPPING FREQUENCY USED	31-33
7.6 DWELL TIME ON EACH CHANNEL.....	34-48
7.7 CONDUCTED SPURIOUS EMISSION	49-56
7.8 RADIATED EMISSION.....	57-75
7.9 CONDUCTED EMISSION.....	76-78
APPENDIX SETUP PHOTOS	79-83



1. TEST REPORT CERTIFICATION

Applicant : Motorola Mobility Inc.
Address : 8000W.Sunrise Blvd,Suite A. Plantation,FL 33322 U.S.A.
Equipment Under Test : HK250
Model : HK250
Trade Name : Motorola
Tested Date : December 12 ~ 16, 2011

APPLICABLE STANDARD	
Standard	Test Result
FCC Part 15 Subpart C AND ANSI C63.4:2003	PASS

WE HEREBY CERTIFY THAT: The above equipment has been tested by Compliance Certification Services Inc., and found compliance with the requirements set forth in the technical standards mentioned above. The results of testing in this report apply only to the product/system, which was tested. Other similar equipment will not necessarily produce the same results due to production tolerance and measurement uncertainties.

Approved by:

Sb Lu
Sr. Engineer

Reviewed by:

Gundam Lin
Sr. Engineer



2. EUT DESCRIPTION

Product Name	HK250
Model Number	HK250
Identify Number	T11121230701
Received Date	December 12, 2011
Frequency Range	2402MHz to 2480MHz $f = 2402 + n\text{MHz}$, $n = 0, \dots, 78$
Transmit Power	1.738 dBm (0.0015W)
Channel Spacing	1MHz
Channel Number	79 Channels
Transmit Data Rate	GFSK (1Mbps), $\pi/4$ -DQPSK (2Mbps), 8-DPSK (3Mbps)
Type of Modulation	Frequency Hopping Spread Spectrum
Frequency Selection	by software / firmware
Transmitter Classification	portable device
Antenna Type	PCB Antenna, Antenna Gain : 2.56dBi
Power Source	3.7Vdc (Battery Powered) 5.0Vdc (From Notebook PC, Powered From Host Device & Power Adapter)
RF Exposure Evaluation	Since the EUT is classed portable device, and the maximum peak power is 1.738 dBm (<13.6dBm), the MPE evaluation is not required and no SAR consideration applied.
DC Power Cord Type	Non-shielded Cable, 1.9m (Non-detachable) Shielded Micro USB Cable 1m x 2 (Detachable)
I/O Port	Micro USB Port x 1

Power Adapter :

No.	Manufacturer	Model No.	Power Input	Power Output
1	MOTOROLA	DC4050US0301 (SPN5504A)	100~240Vac, 50/60Hz, 0.2A	5.1Vdc, 850mA
2	MOTOROLA	SSW-2222US (SPN5504A)	100~240Vac, 50/60Hz, 0.2A	5.1Vdc, 850mA
3	MOTOROLA	FMP5541A (SPN5547A)	100~240Vac, 50/60Hz, 0.15A	5.0Vdc, 500mA
4	MOTOROLA	SSW-2285US (SPN5674A)	100~240Vac, 50/60Hz, 0.15A	5.0Vdc, 500mA

Remark :

1. The sample selected for test was engineering sample that approximated to production product and was provided by manufacturer.
2. For more details, please refer to the User's manual of the EUT.
3. This submittal(s) (test report) is intended for FCC ID: IHDT6NC1 filing to comply with Section 15.207, 15.209 and 15.247 of the FCC Part 15, Subpart C Rules.



3. DESCRIPTION OF TEST MODES

The EUT (HK250) had been tested under operating condition.

There are three channels have been tested as following :

Channel	Frequency (MHz)
Low	2402
Middle	2441
High	2480

Radiated Emission (Below 1 GHz) and Conducted Emission Test:

1. The following test modes were scanned during the preliminary test:

No.	Pre-Test Mode
1	Normal Mode

2. After the preliminary scan, the following test mode was found to produce the highest emission level.

Final Test Mode		
Emission	Radiated Emission	Normal Mode
	Conducted Emission	N/A

Remark : Then, the above highest emission mode of the configuration of the EUT and cable was chosen for all final test items.

Radiated Emission Test (Above 1 GHz):

Pre-Scan has been conducted to determine the worst-case mode from all possible combinations between available modulations, data rates and antenna ports (if EUT with antenna diversity architecture).

Following channel(s) was (were) selected for the final test as listed below.

Tested Channel	Modulation Technology	Modulation Type	Packet Type
Low, Mid, High	FHSS	GFSK	DH5
Low, Mid, High	FHSS	8-DPSK	3-DH5



Bandedge Measurement :

Pre-Scan has been conducted to determine the worst-case mode from all possible combinations between available modulations, data rates and antenna ports (if EUT with antenna diversity architecture).

Following channel(s) was (were) selected for the final test as listed below.

Tested Channel	Modulation Technology	Modulation Type	Packet Type
Low, High	FHSS	GFSK	DH5
Low, High	FHSS	8-DPSK	3-DH5

Antenna Port Conducted Measurement :

Pre-Scan has been conducted to determine the worst-case mode from all possible combinations between available modulations, data rates and antenna ports (if EUT with antenna diversity architecture).

Following channel(s) was (were) selected for the final test as listed below.

Tested Channel	Modulation Technology	Modulation Type	Packet Type
Low, Mid, High	FHSS	GFSK	DH5
Low, Mid, High	FHSS	8-DPSK	3-DH5

Remark : The field strength of spurious emission was measured in the following position: EUT stand-up position(Z axis), lie-down position(X, Y axis). The worst emission was found in stand-up position(Z axis) and the worst case was recorded.

4. TEST METHODOLOGY

The tests documented in this report were performed in accordance with ANSI C63.4: 2003 and FCC CFR 47, 15.207, 15.209 and 15.247.



5. FACILITIES AND ACCREDITATION

5.1 FACILITIES

All measurement facilities used to collect the measurement data are located at

NO. 989-1 Wen Shan Rd., Shang Shan Village,
Qionglin Shiang Hsinchu County 30741, Taiwan, R.O.C

The sites are constructed in conformance with the requirements of ANSI C63.4:2003 and CISPR 22. All receiving equipment conforms to CISPR 16-1-1, CISPR 16-1-2, CISPR 16-1-3, CISPR 16-1-4, CISPR 16-1-5.

5.2 ACCREDITATIONS

Our laboratories are accredited and approved by the following approval agencies according to ISO/IEC 17025.

Taiwan	TAF
---------------	-----

The measuring facility of laboratories has been authorized or registered by the following approval agencies.

Canada	INDUSTRY CANADA
Japan	VCCI
Taiwan	BSMI
USA	FCC MRA

Copies of granted accreditation certificates are available for downloading from our web site, <http://www.ccsrf.com>



5.3 MEASUREMENT UNCERTAINTY

The following table is for the measurement uncertainty, which is calculated as per the document CISPR 16-4-2.

PARAMETER	UNCERTAINTY
Semi Anechoic Chamber (966 Chamber_B) / Radiated Emission, 30 to 1000 MHz	+/- 3.5189
Semi Anechoic Chamber (966 Chamber_B) / Radiated Emission, 1 to 18GHz	+/- 2.5164
Semi Anechoic Chamber (966 Chamber_B) / Radiated Emission, 18 to 26 GHz	+/- 2.4967
Semi Anechoic Chamber (966 Chamber_B) / Radiated Emission, 26 to 40 GHz	+/- 2.7655
Conducted Emission (Mains Terminals), 9kHz to 30MHz	+/- 1.5923

This uncertainty represents an expanded uncertainty expressed at approximately the 95% confidence level using a coverage factor of $k=2$.

Consistent with industry standard (e.g. CISPR 22: 2006, clause 11, Measurement Uncertainty) determining compliance with the limits shall be base on the results of the compliance measurement. Consequently the measure emissions being less than the maximum allowed emission result in this be a compliant test or passing test.

The acceptable measurement uncertainty value without requiring revision of the compliance statement is base on conducted and radiated emissions being less than U_{CISPR} which is 3.6dB and 5.2dB respectively. CCS values (called U_{Lab} in CISPR 16-4-2) is less than U_{CISPR} as shown in the table above. Therefore, MU need not be considered for compliance.



6. SETUP OF EQUIPMENT UNDER TEST

SUPPORT EQUIPMENT

No.	Product	Manufacturer	Model No.	Serial No.	FCC ID
1	Notebook PC	HP	ProBook 4421s	CNF03242PJ	DoC

SETUP DIAGRAM FOR TESTS

EUT & peripherals setup diagram is shown in appendix setup photos.

EUT OPERATING CONDITION

RF Mode

1. Setup all computers like the setup diagram.
2. Run test software.
3. Select the following settings
 - 7.3: Host Controller & Baseband Commands (3 key)
 - Reset
 - 7.4: Informational Parameters (4 key)
 - Read_BD_ADDR
 - 0: Vendor-specific Commands (0 key)
4. TX mode(GFSK)
 - 0: Vendor-specific Commands (0 key)
 - TX_Test
 - Hopping_Mode: Single frequency
 - Frequency: 2402, 2441, 2480
 - Modulation_Type: PRES9 Pattern
 - Logical_Channel: ACL Basic
 - BB_Packet_Type: DH5 / 3-DH5
 - BB_Packet_Length: 339
 - Tx_Power_Level: 0dBm
 - TX mode(8-DPSK)
 - 0: Vendor-specific Commands (0 key)
 - TX_Test
 - Hopping_Mode: Single frequency
 - Frequency: 2402, 2441, 2480
 - Modulation_Type: PRES9 Pattern
 - Logical_Channel: ACL EDR



BB_Packet_Type: DH5 / 3-DH5

BB_Packet_Length: 1021

Tx_Power_Level: 0dBm

5. All of the functions are under run.
6. Start test.

Normal Mode

1. Setup whole system for test as shown on diagram.
2. Power on all equipments.
3. Build up a connection between EUT and notebook.
4. All of the functions are under run.
5. Start test.



7. FCC PART 15.247 REQUIREMENTS

7.1 DUTY CYCLE CORRECTION FACTOR

LIMITS

Limit : N/A

TEST EQUIPMENT

Name of Equipment	Manufacturer	Model	Serial Number	Calibration Due
Spectrum Analyzer	Agilent	E4407B	US41443108	08/09/2012

Remark: Each piece of equipment is scheduled for calibration once a year.

TEST SETUP

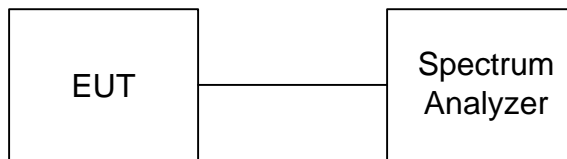

TEST PROCEDURE

1. Set center frequency of spectrum analyzer = operating frequency.
2. Set the spectrum analyzer as RBW, VBW=100KHz, Span = 0Hz.
3. Repeat above procedures until all frequency measured were complete.

TEST RESULTS

$T_p = 100(\text{ms})$

$T_{on} = 2.88 (\text{ms})$

Duty Cycle Correction Factor = $20 * \log (T_{on} / T_p)$

$$= 20 * \log (2.88 / 100) = -30.81$$

The test graph please refer to chapter 7.6.



7.2 20dB BANDWIDTH FOR HOPPING

LIMITS

Limit : N/A

TEST EQUIPMENT

Name of Equipment	Manufacturer	Model	Serial Number	Calibration Due
Spectrum Analyzer	Agilent	E4407B	US41443108	08/09/2012

Remark: Each piece of equipment is scheduled for calibration once a year.

TEST SETUP



TEST PROCEDURE

The 20dB band width was measured with a spectrum analyzer connected to RF antenna connector(conducted measurement) while EUT was operating in transmit mode at the appropriate center frequency. The analyzer center frequency was set to the EUT carrier frequency, using the analyzer. Display Line and Marker Delta functions, the 20dB band width of the emission was determined.



TEST RESULTS

Modulation Type: GFSK, CFG PKT Packet Type: 15 Packet Size: 339 (DH5)

Channel	Channel Frequency (MHz)	20dB Bandwidth (MHz)	Result
Low	2402	0.924	N/A
Middle	2441	0.924	N/A
High	2480	0.927	N/A

Modulation Type: 8-DPSK, CFG PKT Packet Type: 31 Packet Size: 1021 (3-DH5)

Channel	Channel Frequency (MHz)	20dB Bandwidth (MHz)	Result
Low	2402	1.344	N/A
Middle	2441	1.347	N/A
High	2480	1.344	N/A



20dB BANDWIDTH

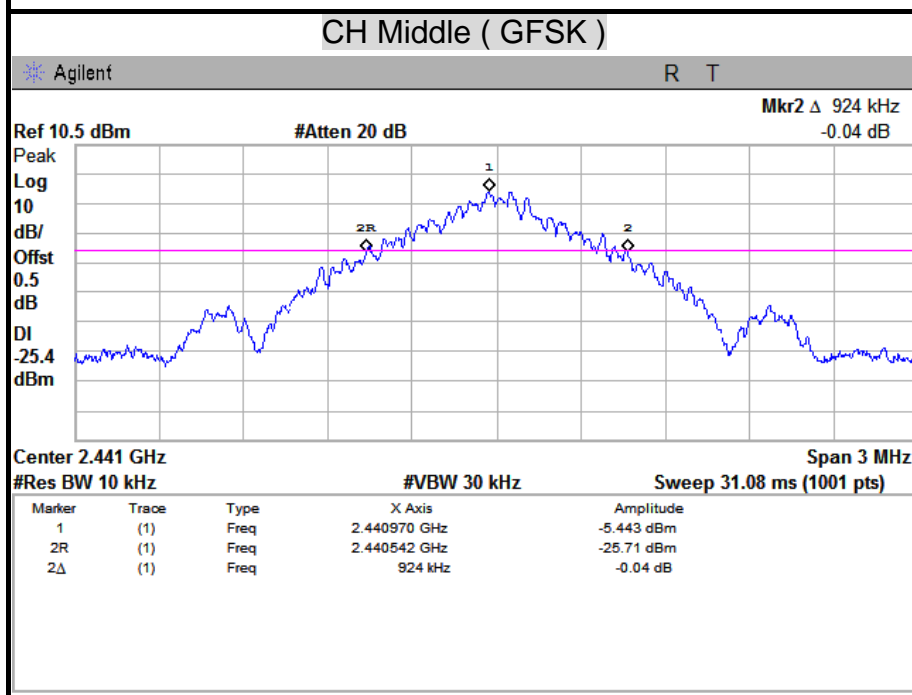
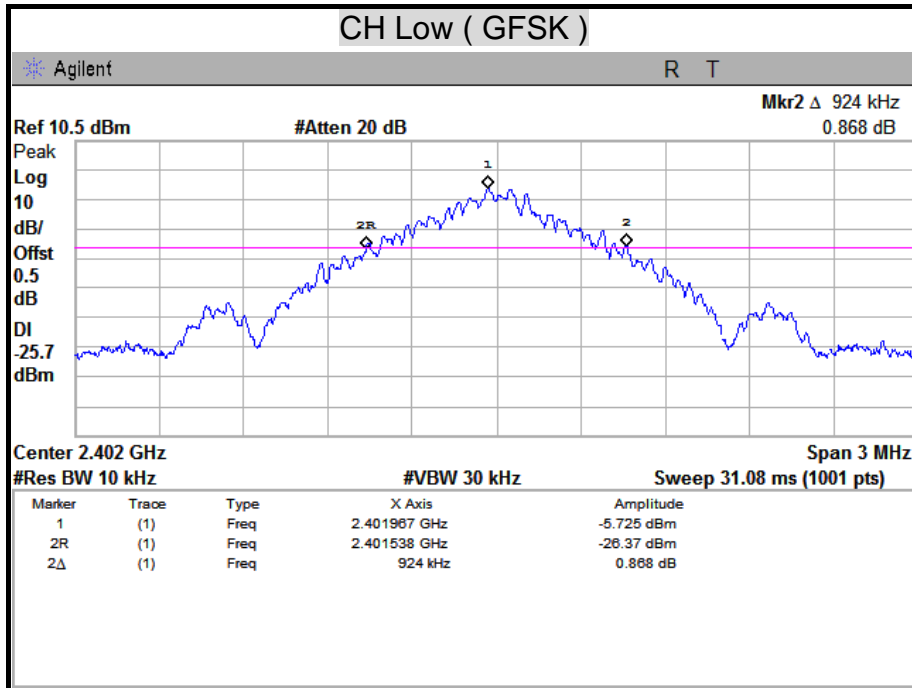

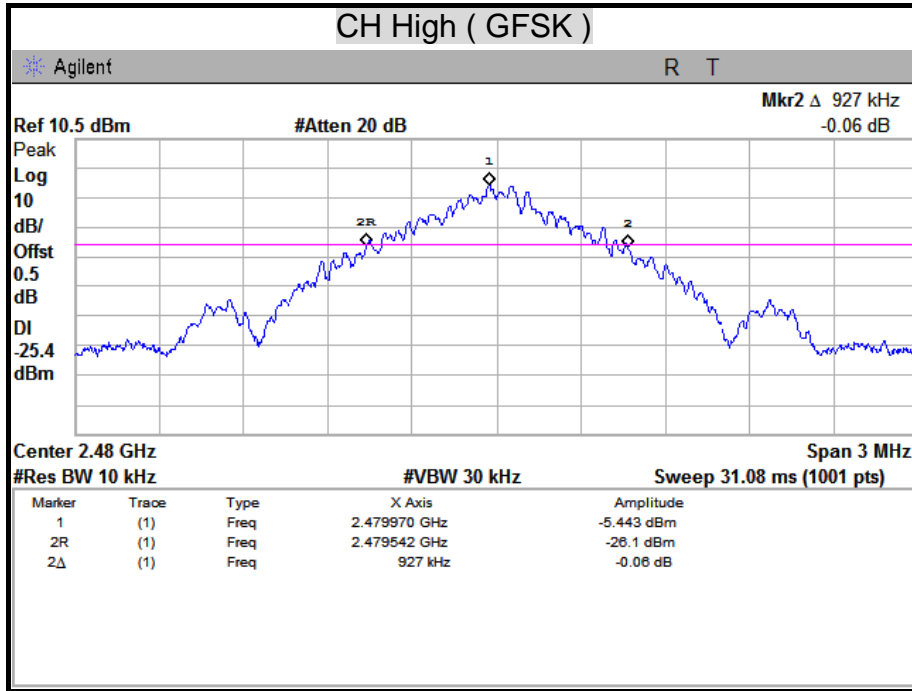

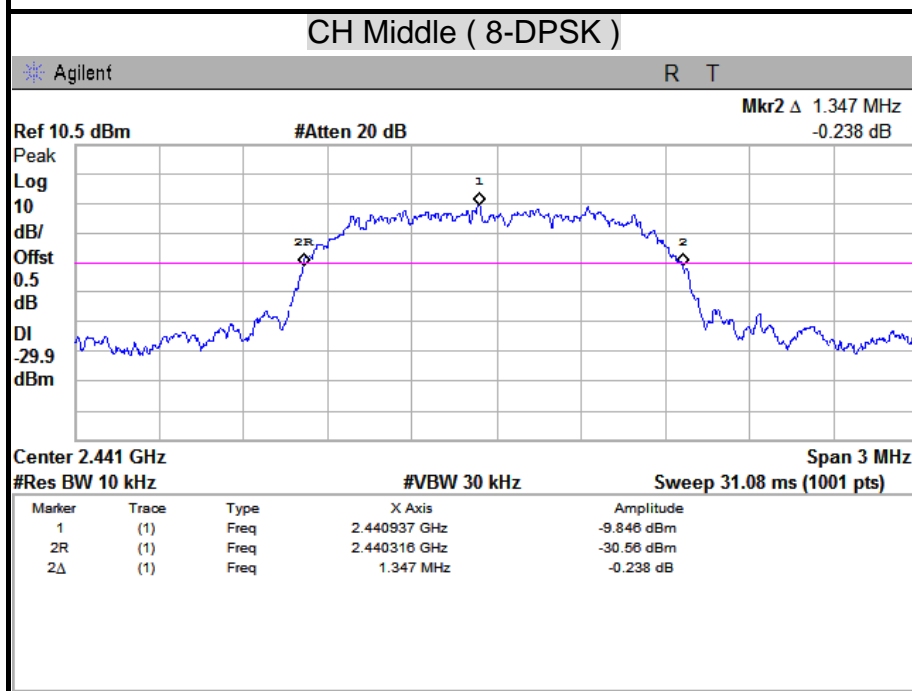
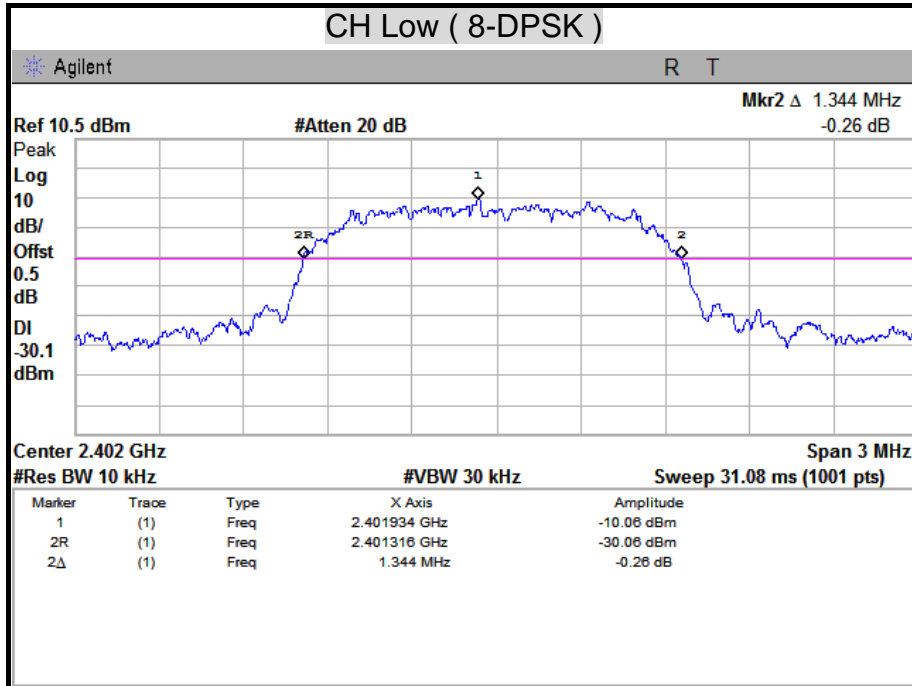

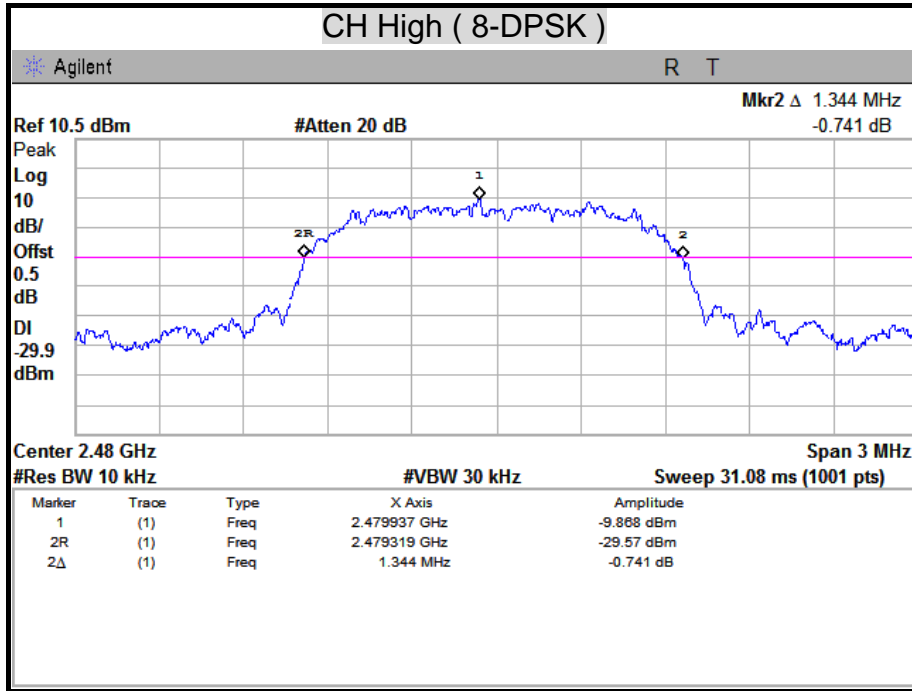



7.3 MAXIMUM PEAK OUTPUT POWER

LIMITS

§15.247(b)(1) For frequency hopping systems operating in the 2400-2483.5 MHz band employing at least 75 non-overlapping hopping channels, and all frequency hopping systems in the 5725-5850 MHz band: 1 watt. For all other frequency hopping systems in the 2400-2483.5 MHz band: 0.125 watts.

TEST EQUIPMENT

Name of Equipment	Manufacturer	Model	Serial Number	Calibration Due
Spectrum Analyzer	Agilent	E4407B	US41443108	08/09/2012

Remark: Each piece of equipment is scheduled for calibration once a year.

TEST SETUP

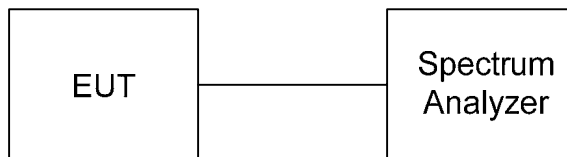

TEST PROCEDURE

The RF power output was measured with a spectrum analyzer connected to the RF Antenna connector (conducted measurement) while EUT was operating in transmit mode at the appropriate center frequency, a spectrum analyzer was used to record the shape of the transmit signal.



TEST RESULTS

Modulation Type: GFSK ,CFG PKT Packet Type: 15 Packet Size: 339 (DH5)

Channel	Channel Frequency (MHz)	Peak Power		Peak Power Limit		Result
		(dBm)	(W)	(dBm)	(W)	
Low	2402	-0.588	0.0009	20.97	0.125	PASS
Middle	2441	-0.199	0.0010	20.97	0.125	PASS
High	2480	-0.284	0.0009	20.97	0.125	PASS

Remark: The cable assembly insertion loss of 0.5dB was Entered as an offset in the spectrum analyzer to allow for direct reading of power.

Modulation Type: 8-DPSK ,CFG PKT Packet Type: 31 Packet Size: 1021 (3-DH5)

Channel	Channel Frequency (MHz)	Peak Power		Peak Power Limit		Result
		(dBm)	(W)	(dBm)	(W)	
Low	2402	1.484	0.0014	20.97	0.125	PASS
Middle	2441	1.738	0.0015	20.97	0.125	PASS
High	2480	1.657	0.0015	20.97	0.125	PASS

Remark: The cable assembly insertion loss of 0.5dB was Entered as an offset in the spectrum analyzer to allow for direct reading of power.



MAXIMUM PEAK OUTPUT POWER

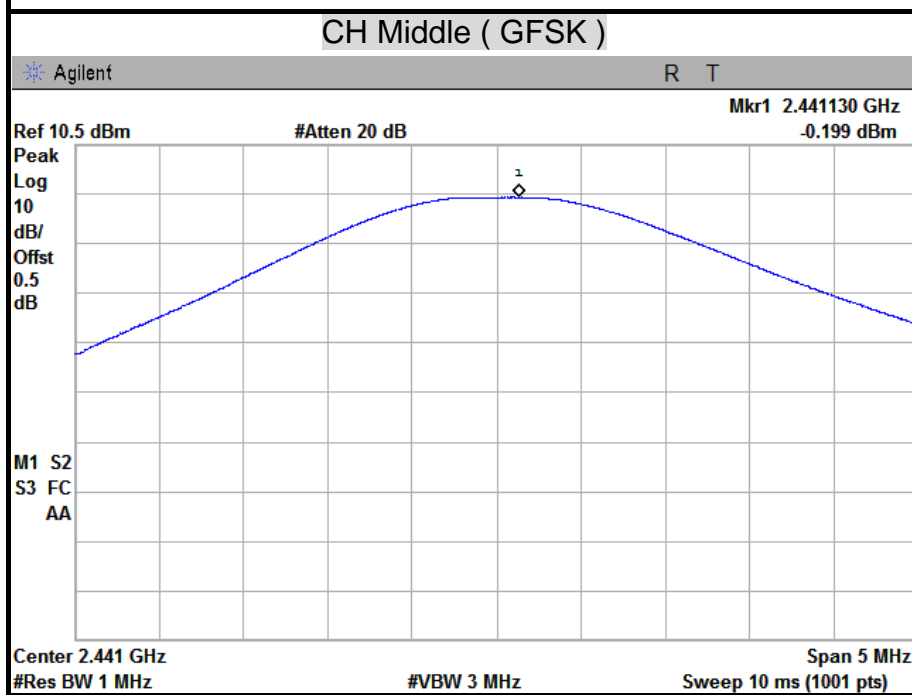
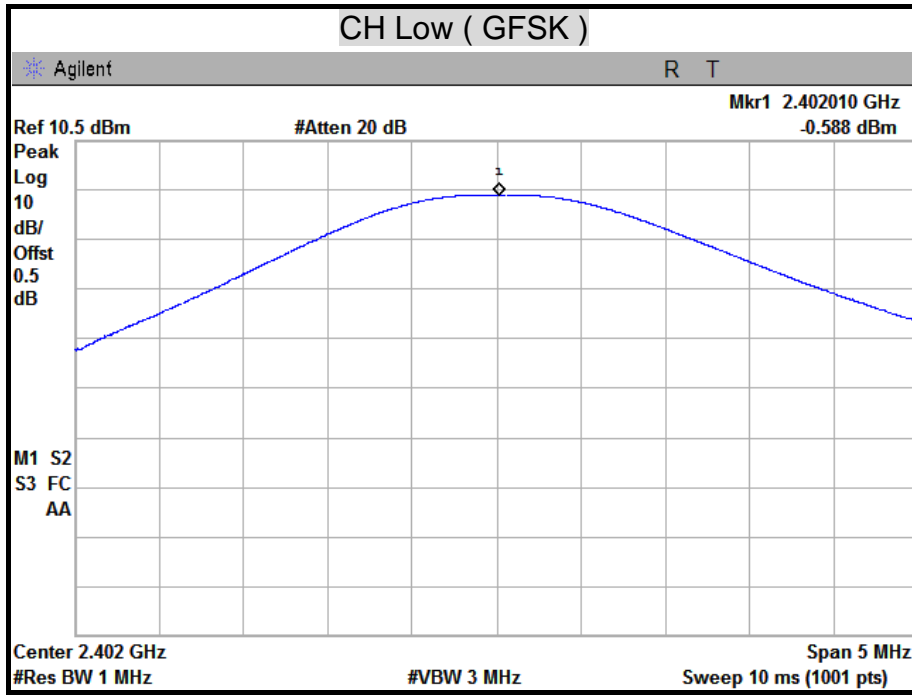

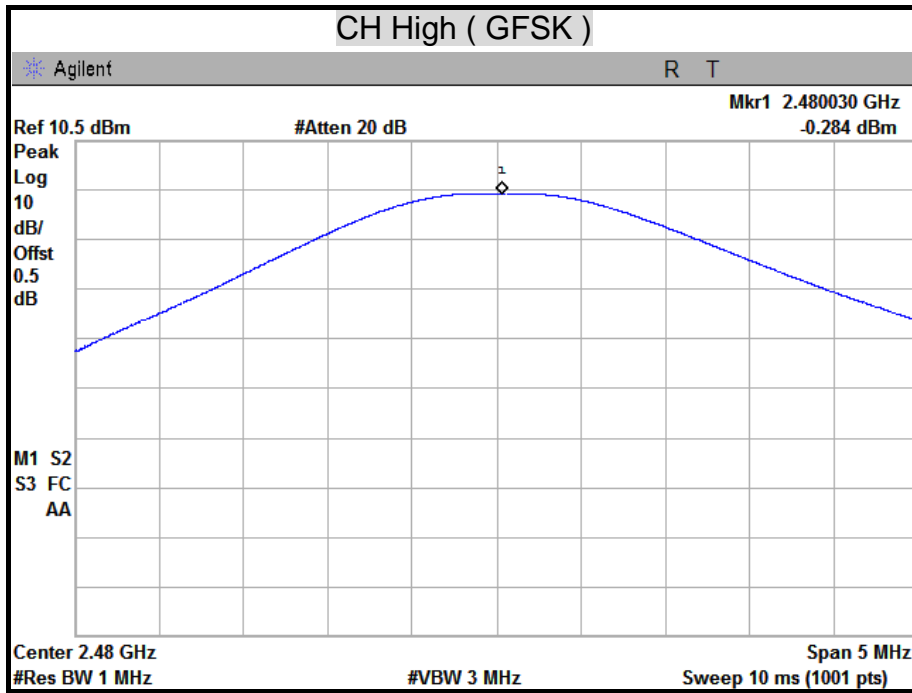

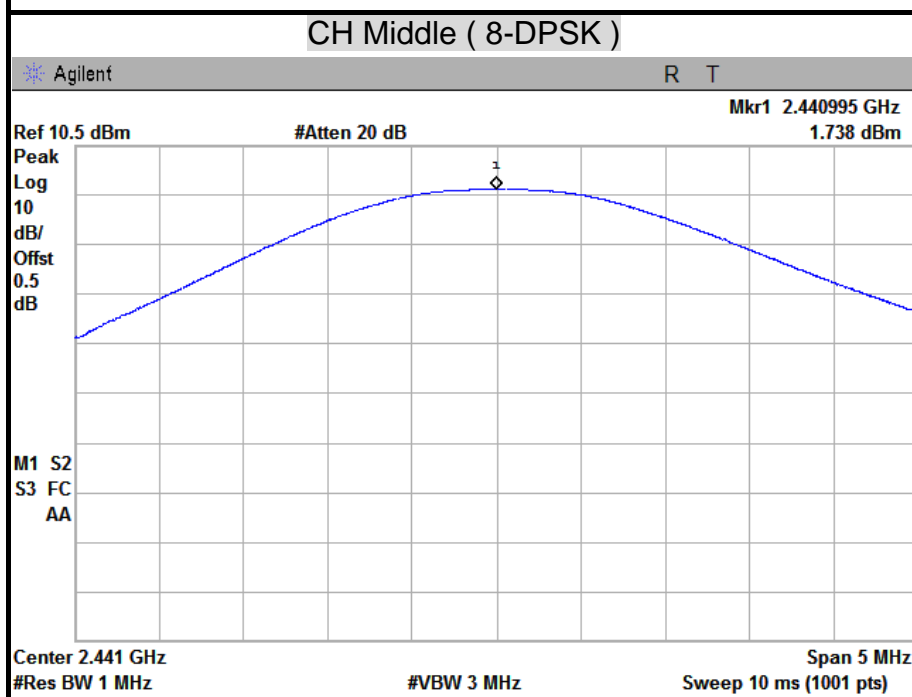
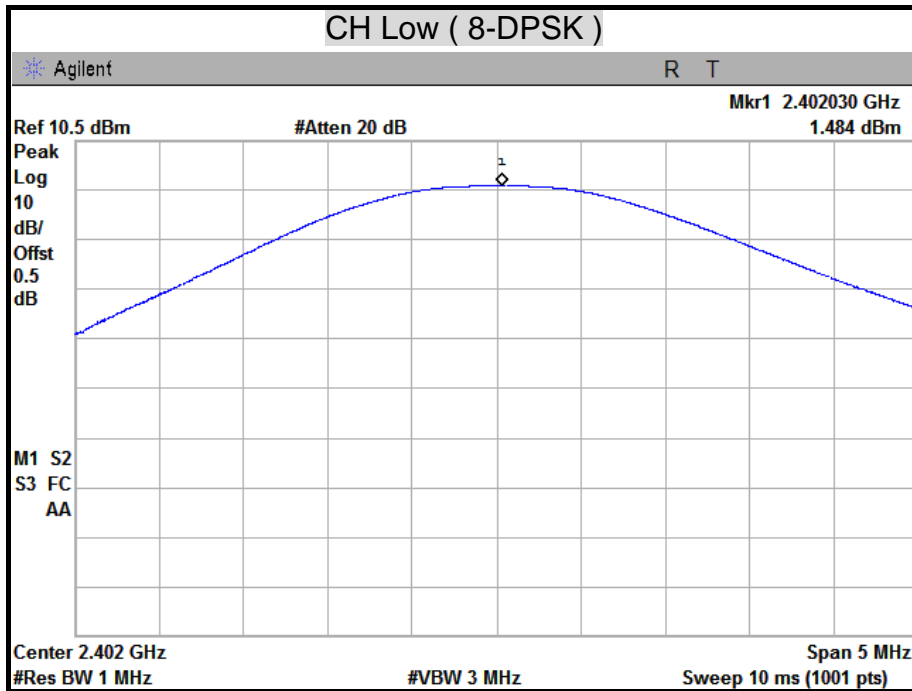

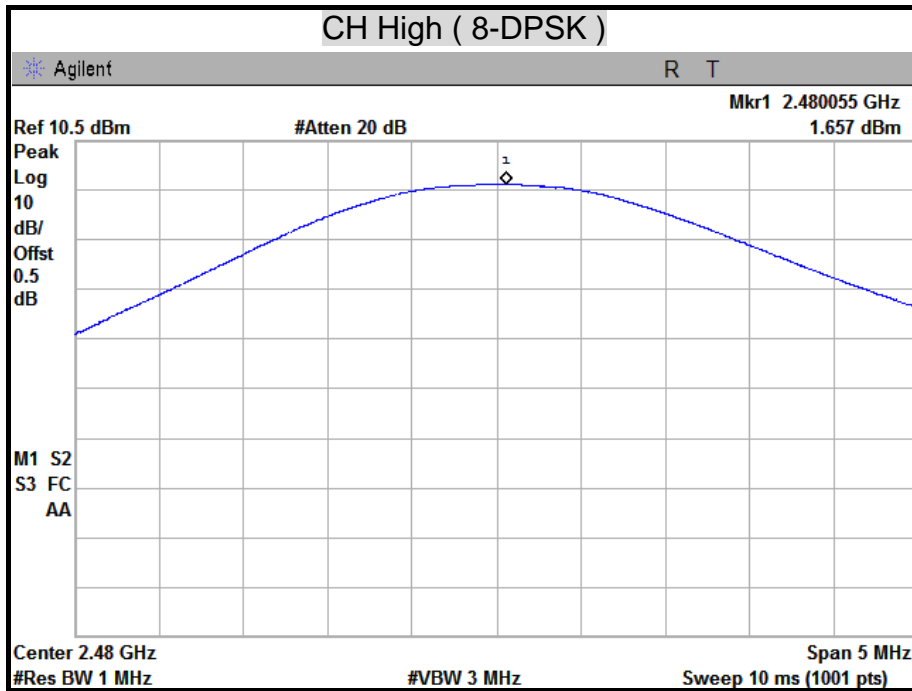



7.4 HOPPING CHANNEL SEPARATION

LIMITS

§15.247(a)(1) Frequency hopping systems shall have hopping channel carrier frequencies separated by a minimum of 25 kHz or the 20 dB bandwidth of the hopping channel, whichever is greater. Alternatively, frequency hopping systems operating in the 2400-2483.5 MHz band may have hopping channel carrier frequencies that are separated by 25 kHz or two-thirds of the 20 dB bandwidth of the hopping channel, whichever is greater, provided the systems operate with an output power no greater than 125 mW. The system shall hop to channel frequencies that are selected at the system hopping rate from a pseudorandomly ordered list of hopping frequencies. Each frequency must be used equally on the average by each transmitter. The system receivers shall have input bandwidths that match the hopping channel bandwidths of their corresponding transmitters and shall shift frequencies in synchronization with the transmitted signals.

TEST EQUIPMENT

Name of Equipment	Manufacturer	Model	Serial Number	Calibration Due
Spectrum Analyzer	Agilent	E4407B	US41443108	08/09/2012

Remark: Each piece of equipment is scheduled for calibration once a year.

TEST SETUP



TEST PROCEDURE

1. Check the calibration of the measuring instrument using either an internal calibrator or a known signal from an external generator.
2. Position the EUT as shown in test setup without connection to measurement instrument. Turn on the EUT and connect it to measurement instrument. Then set it to any one convenient frequency within its operating range.
3. By using the MaxHold function record the separation of adjacent channels.
4. Measure the frequency difference of these two adjacent channels by spectrum analyzer MARK function. And then plot the result on spectrum analyzer screen.
5. Repeat above procedures until all frequencies measured were complete.



TEST RESULTS

Refer to section 8.1, 20dB bandwidth measurement, the measured channel separation should be greater than two-third of 20dB bandwidth or Minimum bandwidth.

Modulation Type: GFSK, CFG PKT Packet Type: 15 Packet Size: 339 (DH5)

Channel	Channel Frequency (MHz)	Adjacent Hopping Channel Separation (kHz)	Two –third of 20dB bandwidth (kHz)	Minimum Bandwidth	Result
Low	2402	1000	616.00	25 kHz	PASS
Middle	2441	1000	616.00	25 kHz	PASS
High	2480	1000	618.00	25 kHz	PASS

Modulation Type: 8-DPSK, CFG PKT Packet Type: 31 Packet Size: 1021 (3-DH5)

Channel	Channel Frequency (MHz)	Adjacent Hopping Channel Separation (kHz)	Two –third of 20dB bandwidth (kHz)	Minimum Bandwidth	Result
Low	2402	1000	896.00	25 kHz	PASS
Middle	2441	1000	898.00	25 kHz	PASS
High	2480	1000	896.00	25 kHz	PASS



HOPPING CHANNEL SEPARATION

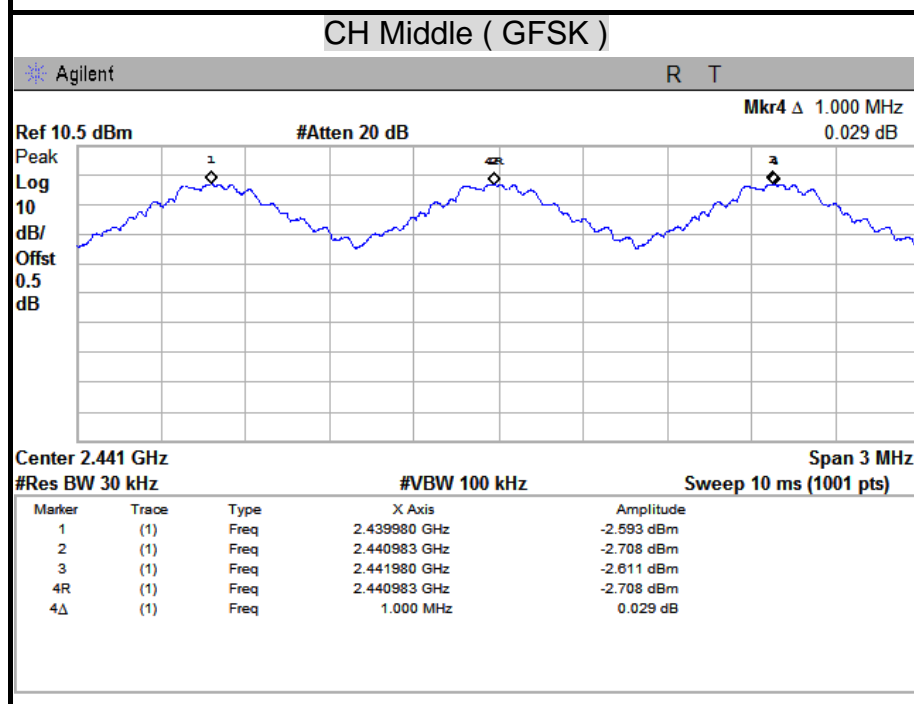
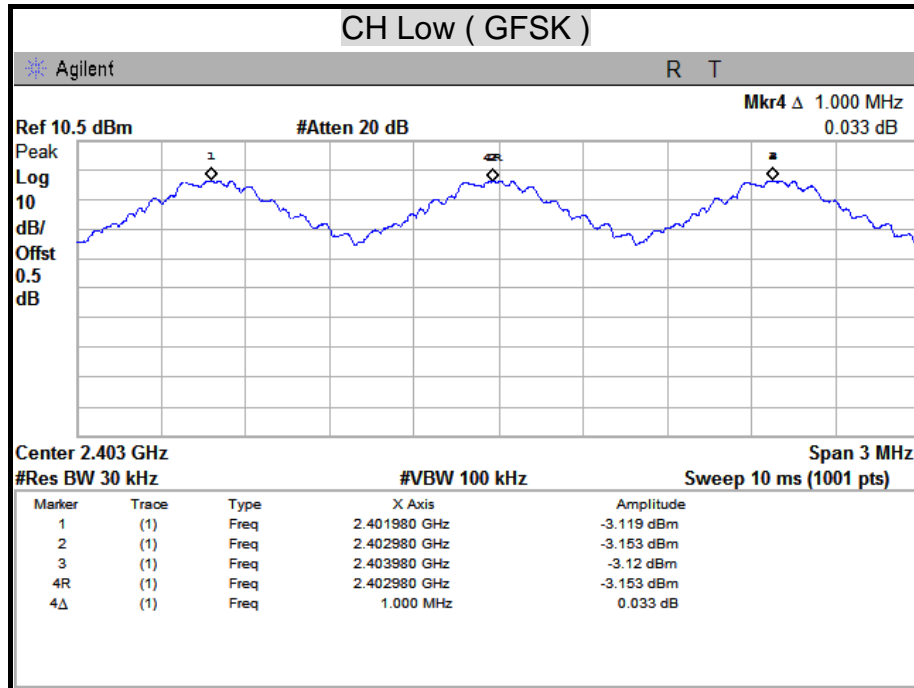

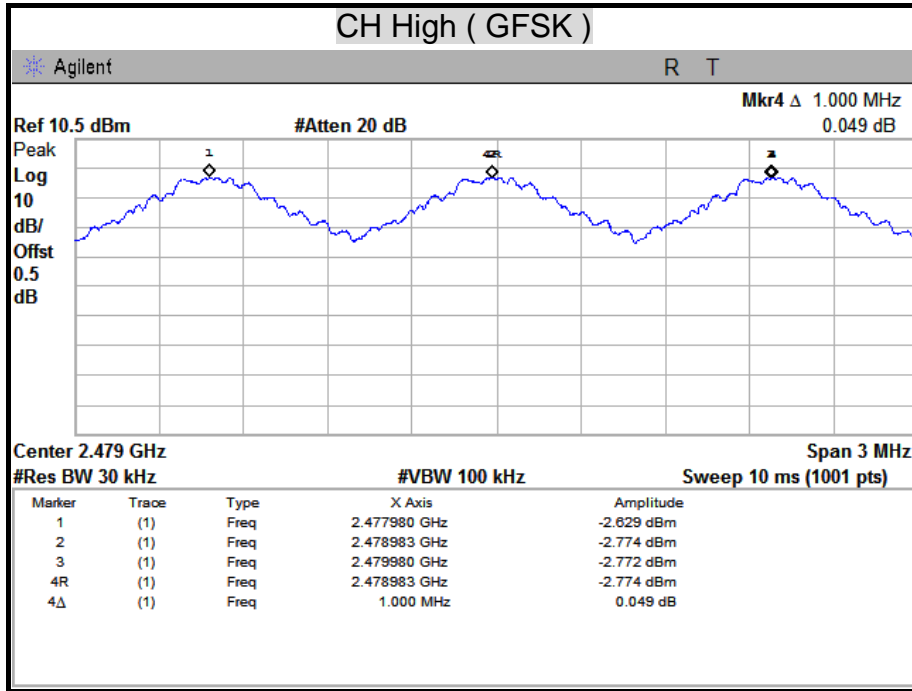

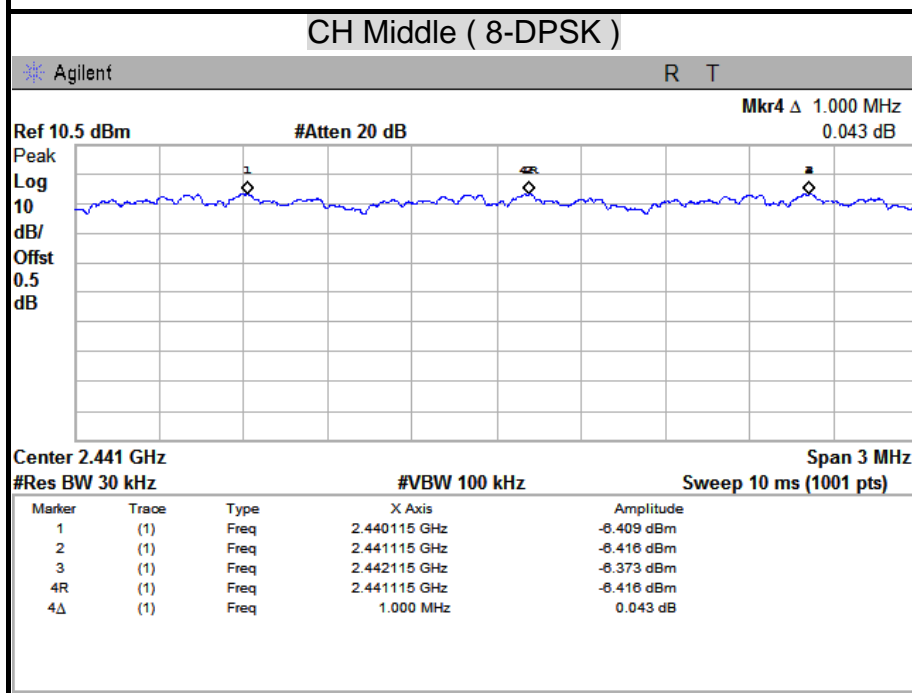
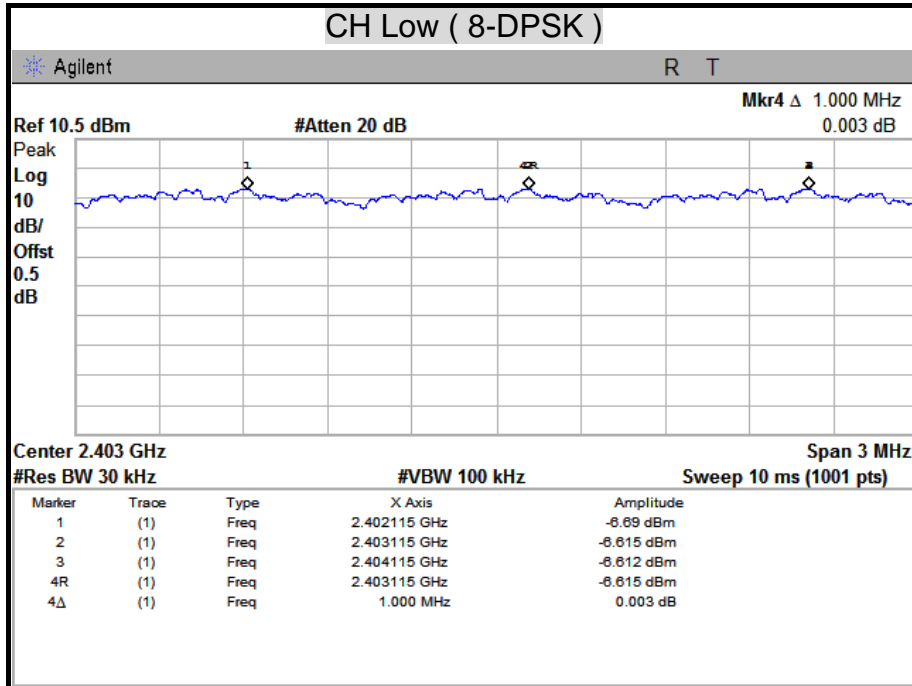

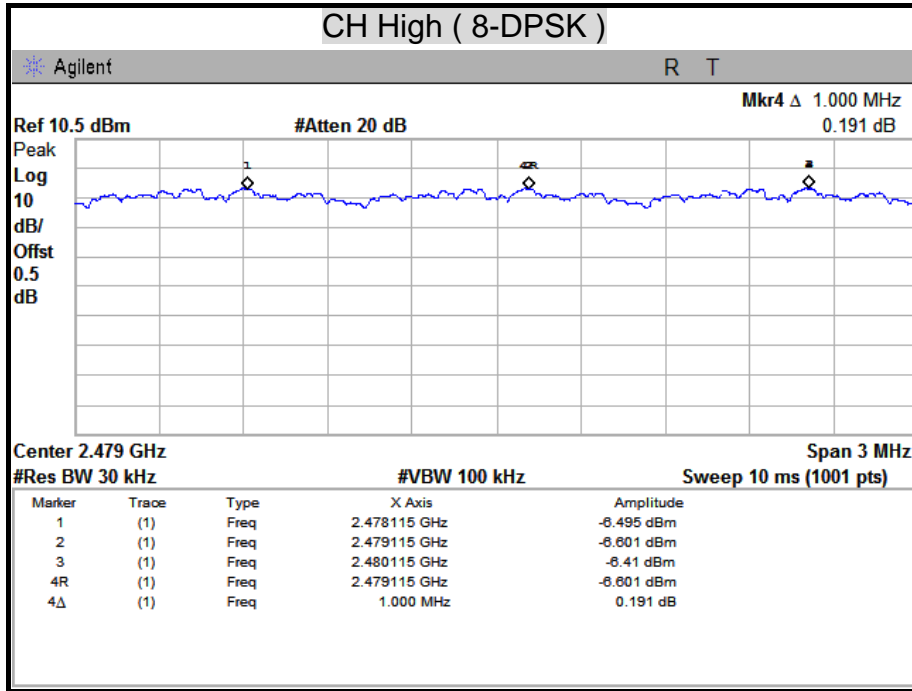



7.5 NUMBER OF HOPPING FREQUENCY USED

LIMITS

§15.247(a)(1)(iii) For frequency hopping systems in the 2400-2483.5 MHz band shall use at least 15 channels.

TEST EQUIPMENT

Name of Equipment	Manufacturer	Model	Serial Number	Calibration Due
Spectrum Analyzer	Agilent	E4407B	US41443108	08/09/2012

Remark: Each piece of equipment is scheduled for calibration once a year.

TEST SETUP

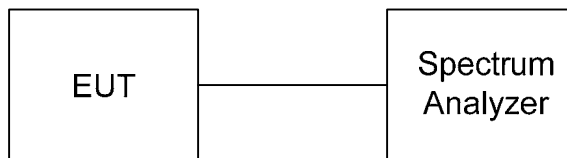

TEST PROCEDURE

1. Check the calibration of the measuring instrument (spectrum analyzer) using either an internal calibrator or a known signal from an external generator.
2. Position the EUT as shown in test setup without connection to measurement instrument. Turn on the EUT and connect its antenna terminal to measurement instrument via a low loss cable. Then set it to any one measured frequency within its operating range and make sure the instrument is operated in its linear range.
3. Set the spectrum analyzer on MaxHold Mode, and then keep the EUT in hopping mode. Record all the signals from each channel until each one has been recorded.
4. Set the spectrum analyzer on View mode and then plot the result on spectrum analyzer screen.
5. Repeat above procedures until all frequencies measured were complete.

TEST RESULTS

Refer to the attached plot.
There are 79 hopping frequencies in a hopping sequence.



NUMBER OF HOPPING FREQUENCY USED

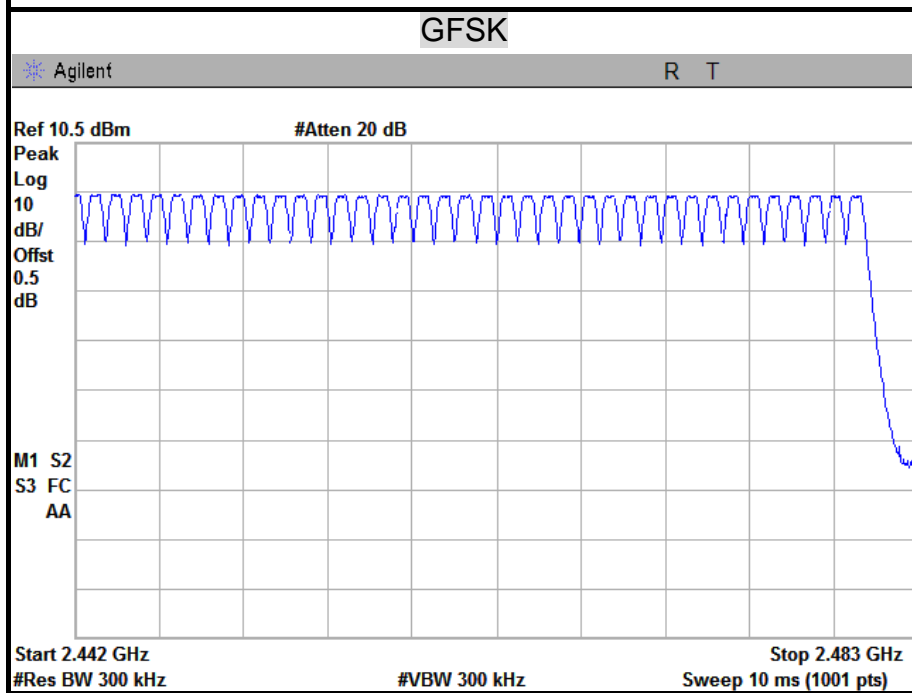
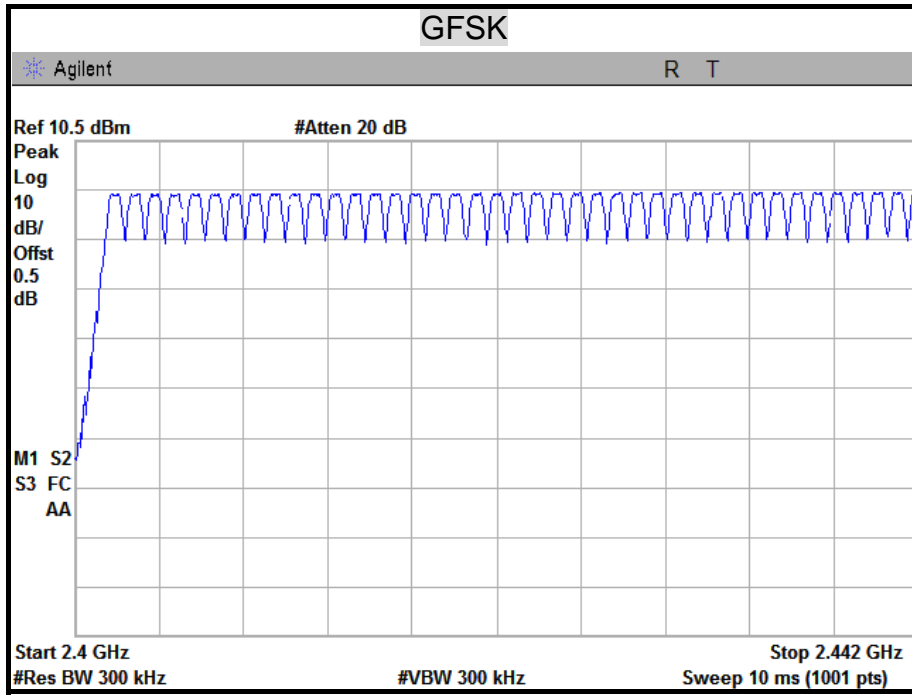

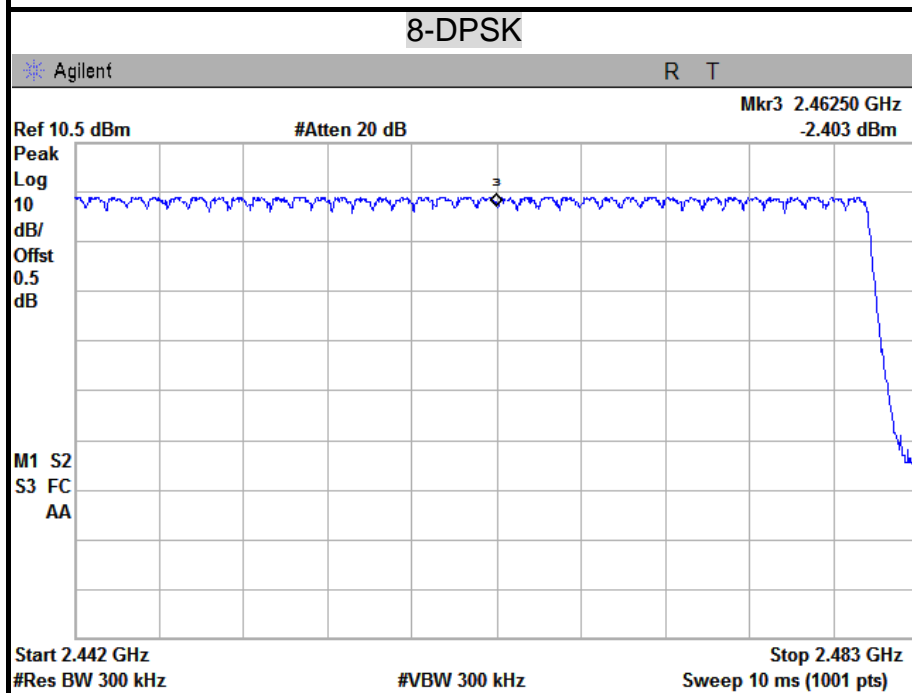
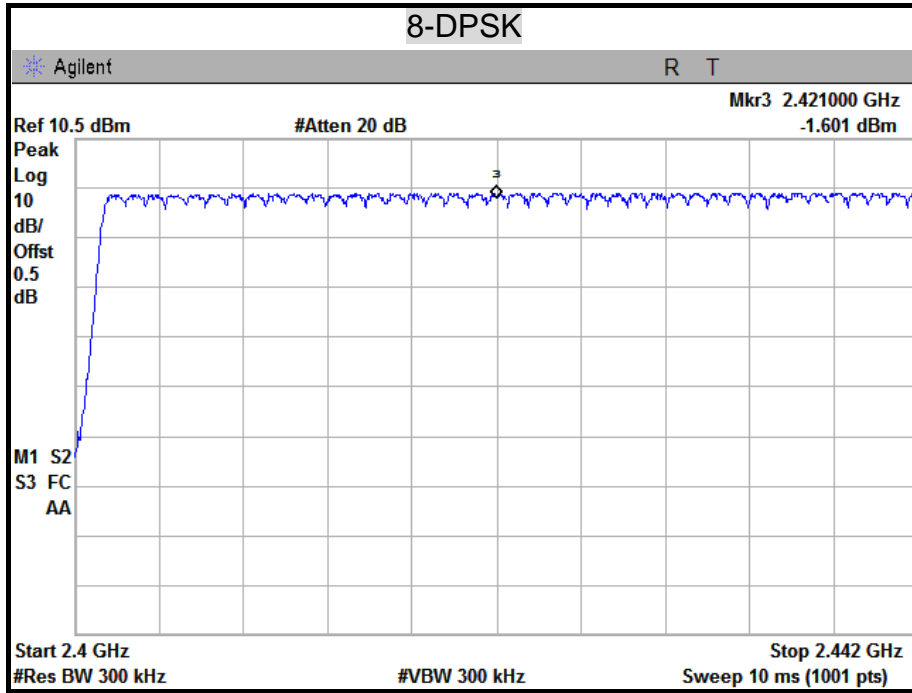



7.6 DWELL TIME ON EACH CHANNEL

LIMITS

§15.247(a)(1)(iii) For frequency hopping system operating in the 2400-2483.5MHz band, the average time of occupancy on any frequency shall not be greater than 0.4 second within a 31.6 second period.

TEST EQUIPMENT

Name of Equipment	Manufacturer	Model	Serial Number	Calibration Due
Spectrum Analyzer	Agilent	E4407B	US41443108	08/09/2012

Remark: Each piece of equipment is scheduled for calibration once a year.

TEST SETUP

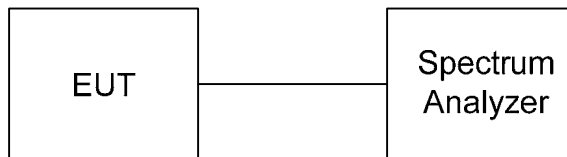

TEST PROCEDURE

1. Check the calibration of the measuring instrument using either an internal calibrator or a known signal from an external generator.
2. Position the EUT as shown in test setup without connection to measurement instrument. Turn on the EUT and connect its antenna terminal to measurement instrument via a low loss cable. Then set it to any one measured frequency within its operating range and make sure the instrument is operated in its linear range.
3. Adjust the center frequency of spectrum analyzer on any frequency be measured and set spectrum analyzer to zero span mode. And then, set RBW and VBW of spectrum analyzer to proper value.
4. Measure the time duration of one transmission on the measured frequency. And then plot the result with time difference of this time duration.
5. Repeat above procedures until all frequencies measured were complete.
6. The EUT has 3 type of payload, DH1, DH3, DH5. The hopping rate is 1600 per second. The longer the payload is, the slower the hopping rate is.



TEST RESULTS

Time of occupancy on the TX channel in 31.6sec = time domain slot length x hop rate ÷ number of hop per channel x 31.6

Refer to the attached graph.

The hopping rates of Bluetooth devices change with different types of payload. The longer the payload is, the slower the hopping rate. The hopping rate scenario is defined in Bluetooth core specification.

Modulation Type: GFSK, CFG PKT Packet Type: 15 Packet Size: 339 (DH5)

Channel	Channel Frequency (MHz)	Packet Type	Pulse Time (ms)	Time Of Occupancy On The TX Channel In 31.6sec (ms)	Limit For Time Of Occupancy On The TX Channel In 31.6sec (ms)	Results
Low	2402	DH1	0.38	121.60	400	PASS
	2402	DH3	1.64	262.40	400	PASS
	2402	DH5	2.88	307.20	400	PASS
Middle	2441	DH1	0.38	121.60	400	PASS
	2441	DH3	1.64	262.40	400	PASS
	2441	DH5	2.88	307.20	400	PASS
High	2480	DH1	0.38	121.60	400	PASS
	2480	DH3	1.64	262.40	400	PASS
	2480	DH5	2.88	307.20	400	PASS

Remark:

Ch Low

DH1 : 0.38 ms x (1600÷2) ÷ 79 x 31.6 = 121.60 (ms)

DH3 : 1.64 ms x (1600÷4) ÷ 79 x 31.6 = 262.40 (ms)

DH5 : 2.88 ms x (1600÷6) ÷ 79 x 31.6 = 307.20 (ms)

Ch Middle

DH1 : 0.38 ms x (1600÷2) ÷ 79 x 31.6 = 121.60 (ms)

DH3 : 1.64 ms x (1600÷4) ÷ 79 x 31.6 = 262.40 (ms)

DH5 : 2.88 ms x (1600÷6) ÷ 79 x 31.6 = 307.20 (ms)

Ch High

DH1 : 0.38 ms x (1600÷2) ÷ 79 x 31.6 = 121.60 (ms)

DH3 : 1.64 ms x (1600÷4) ÷ 79 x 31.6 = 262.40 (ms)

DH5 : 2.88 ms x (1600÷6) ÷ 79 x 31.6 = 307.20 (ms)



Modulation Type: 8-DPSK, CFG PKT Packet Type: 31 Packet Size: 1021 (3-DH5)

Channel	Channel Frequency (MHz)	Packet Type	Pulse Time (ms)	Time Of Occupancy On The TX Channel In 31.6sec (ms)	Limit For Time Of Occupancy On The TX Channel In 31.6sec (ms)	Results
Low	2402	DH1	0.38	121.60	400	PASS
	2402	DH3	1.64	262.40	400	PASS
	2402	DH5	2.88	307.20	400	PASS
Middle	2441	DH1	0.38	121.60	400	PASS
	2441	DH3	1.64	262.40	400	PASS
	2441	DH5	2.88	307.20	400	PASS
High	2480	DH1	0.38	121.60	400	PASS
	2480	DH3	1.64	262.40	400	PASS
	2480	DH5	2.88	307.20	400	PASS

Remark:

Ch Low

DH1 : $0.38\text{ ms} \times (1600 \div 2) \div 79 \times 31.6 = 121.60\text{ (ms)}$

DH3 : $1.64\text{ ms} \times (1600 \div 4) \div 79 \times 31.6 = 262.40\text{ (ms)}$

DH5 : $2.88\text{ ms} \times (1600 \div 6) \div 79 \times 31.6 = 307.20\text{ (ms)}$

Ch Middle

DH1 : $0.38\text{ ms} \times (1600 \div 2) \div 79 \times 31.6 = 121.60\text{ (ms)}$

DH3 : $1.64\text{ ms} \times (1600 \div 4) \div 79 \times 31.6 = 262.40\text{ (ms)}$

DH5 : $2.88\text{ ms} \times (1600 \div 6) \div 79 \times 31.6 = 307.20\text{ (ms)}$

Ch High

DH1 : $0.38\text{ ms} \times (1600 \div 2) \div 79 \times 31.6 = 121.60\text{ (ms)}$

DH3 : $1.64\text{ ms} \times (1600 \div 4) \div 79 \times 31.6 = 262.40\text{ (ms)}$

DH5 : $2.88\text{ ms} \times (1600 \div 6) \div 79 \times 31.6 = 307.20\text{ (ms)}$



DWELL TIME ON EACH PAYLOAD

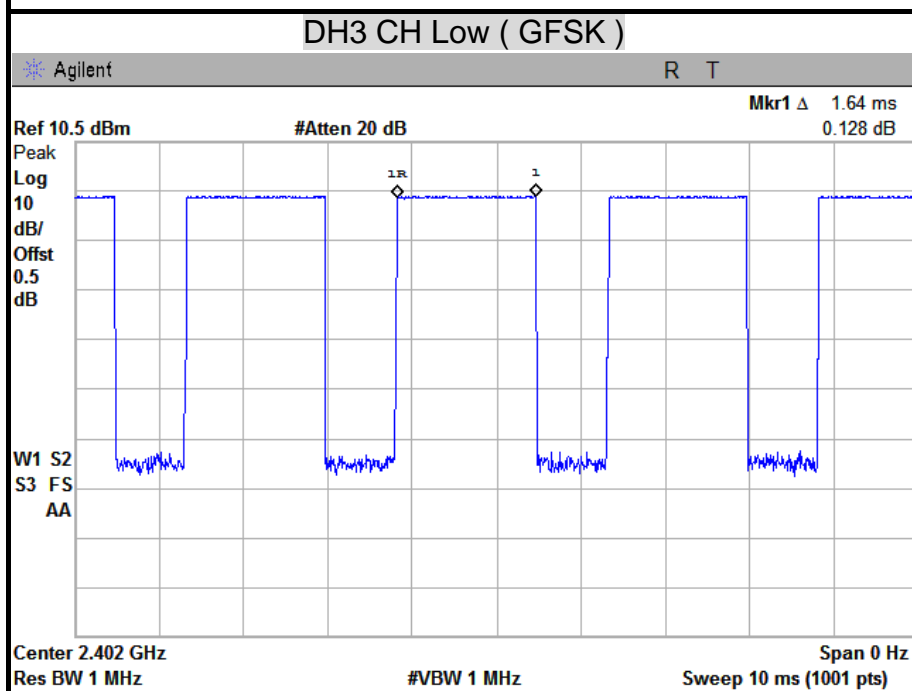
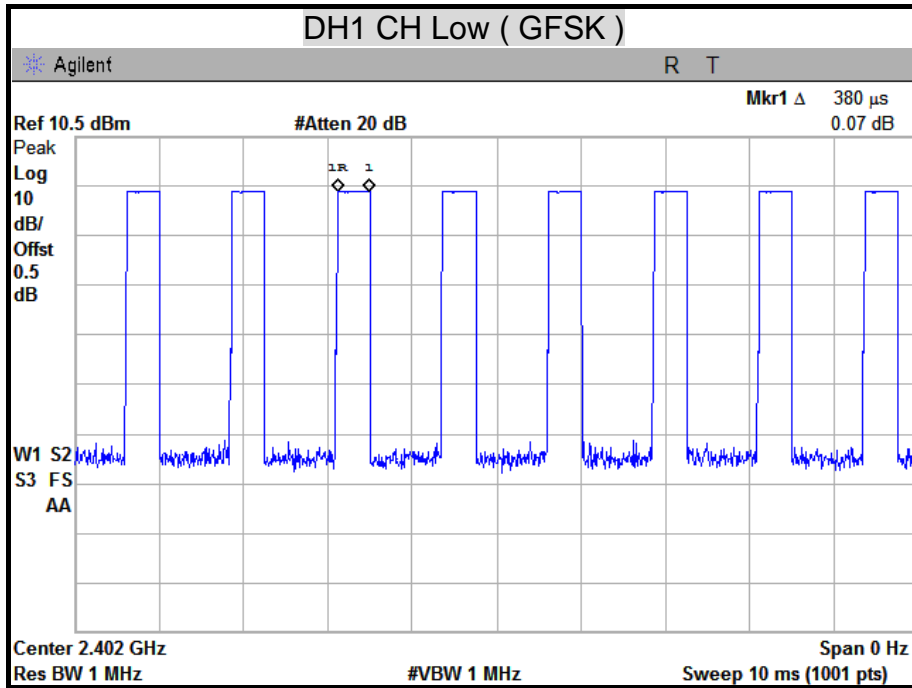

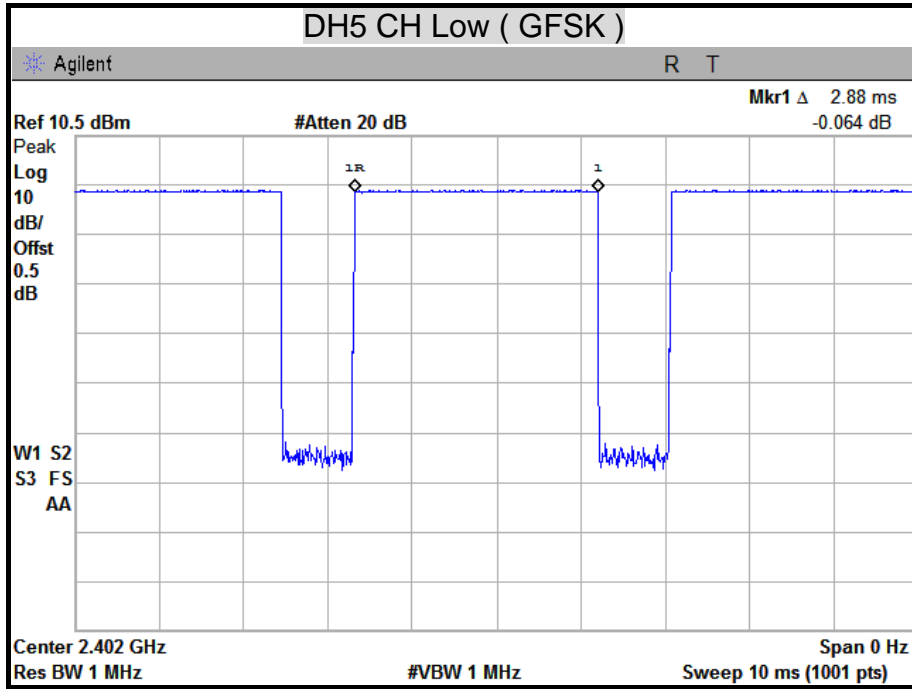

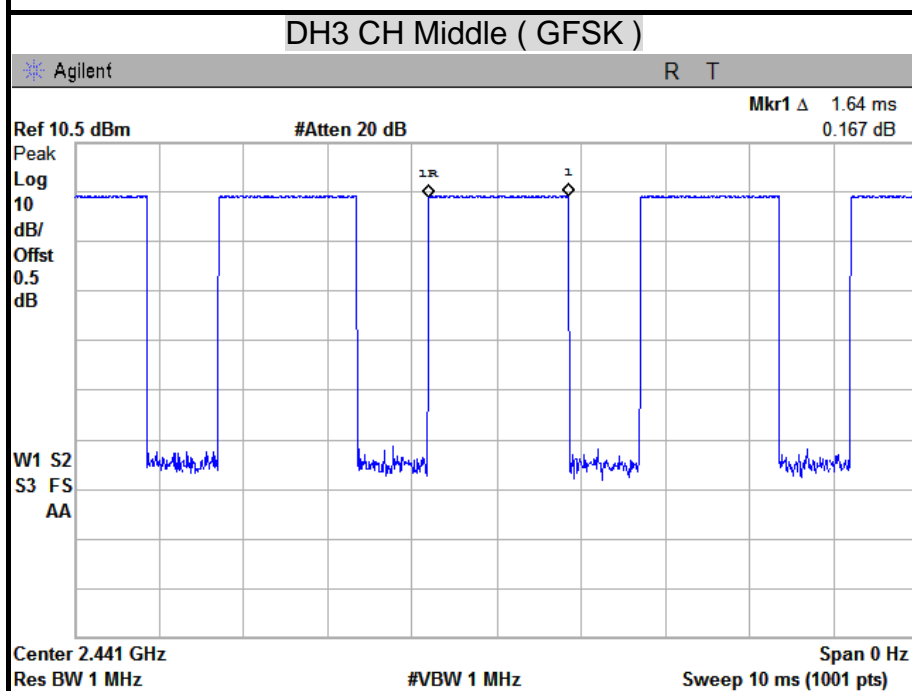
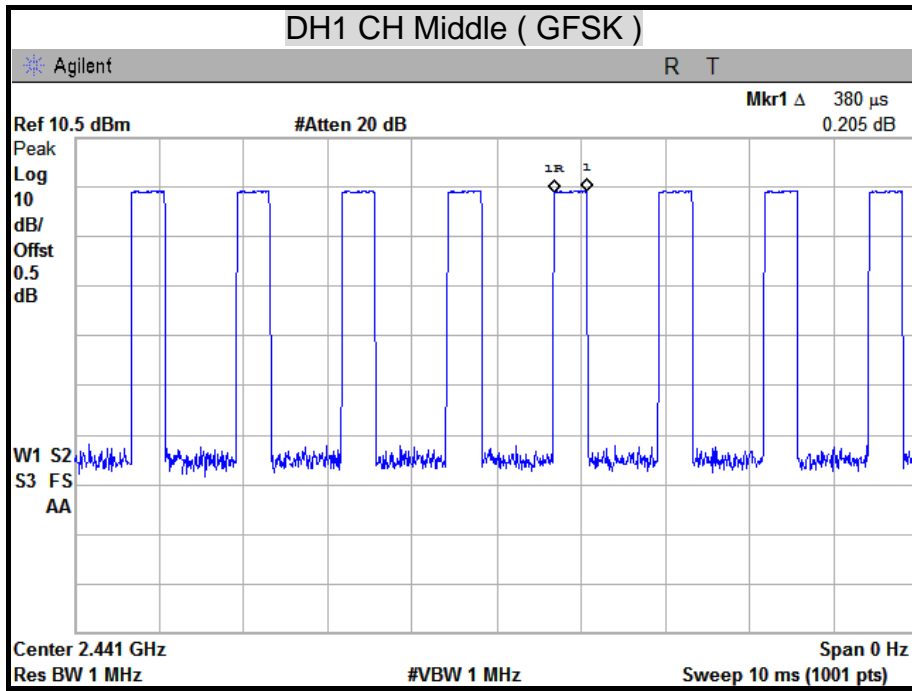

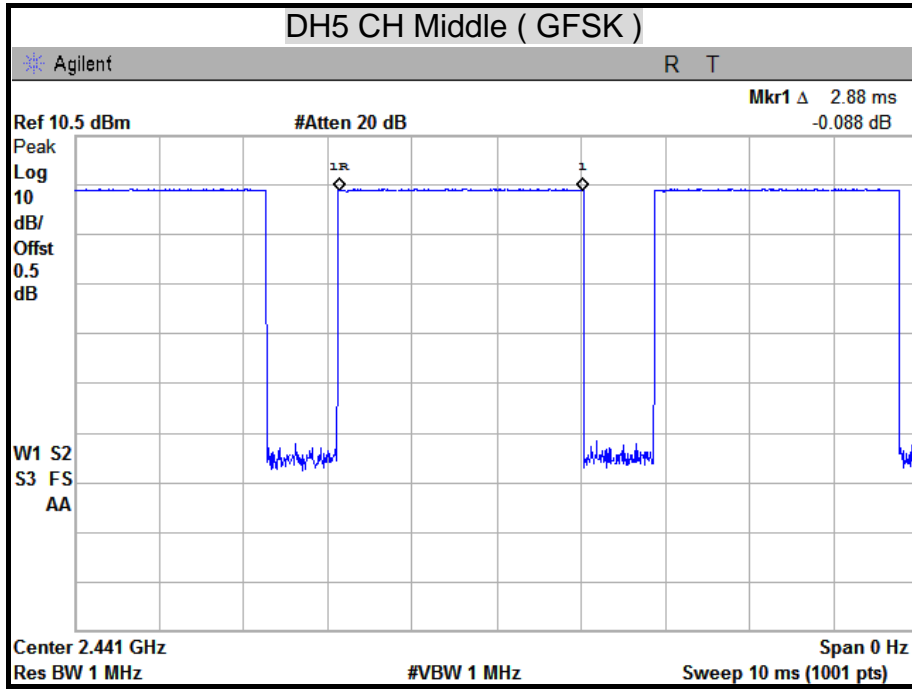

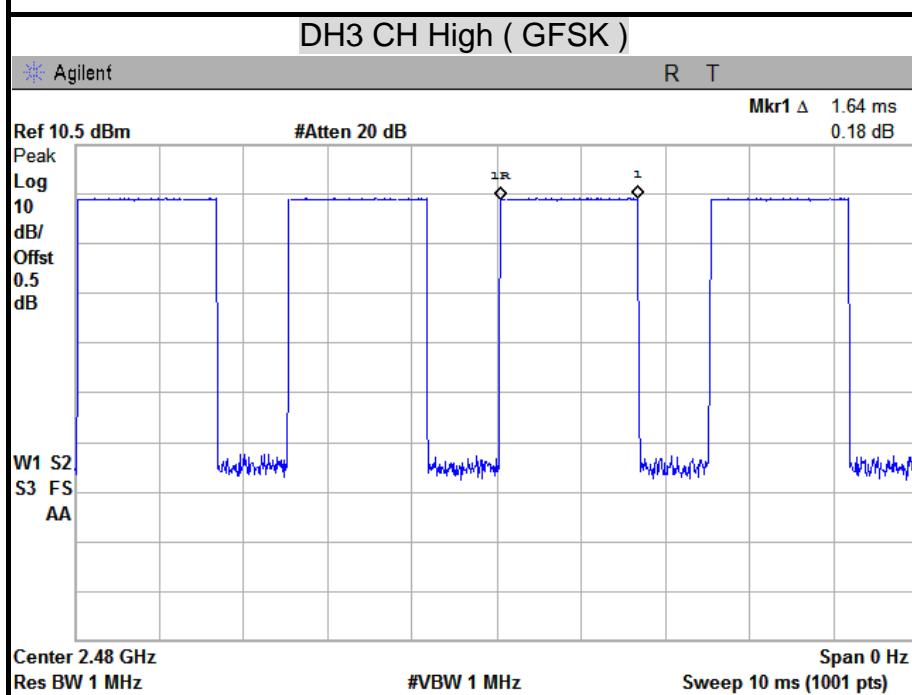
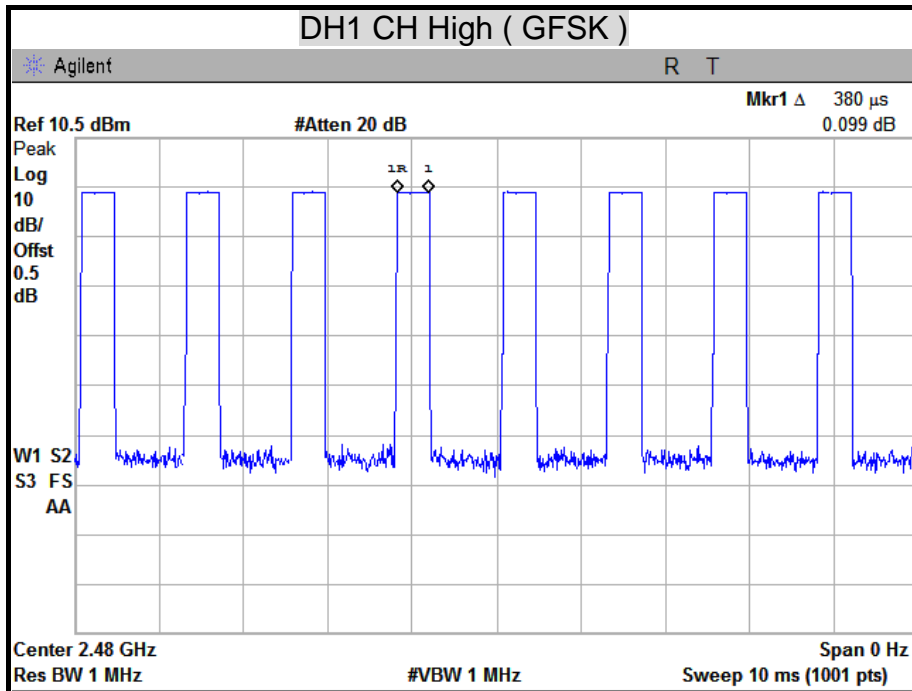

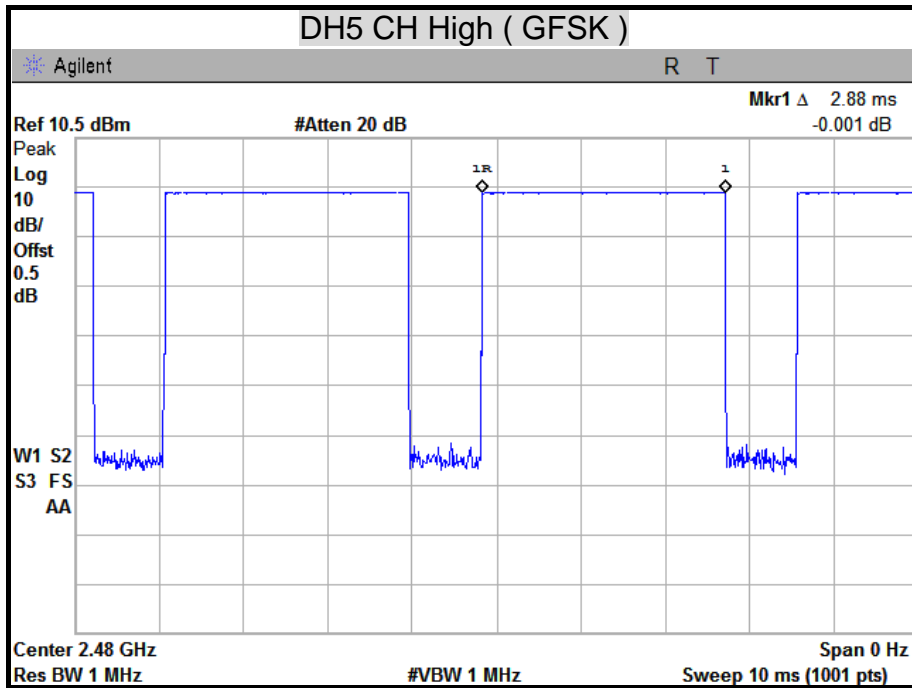

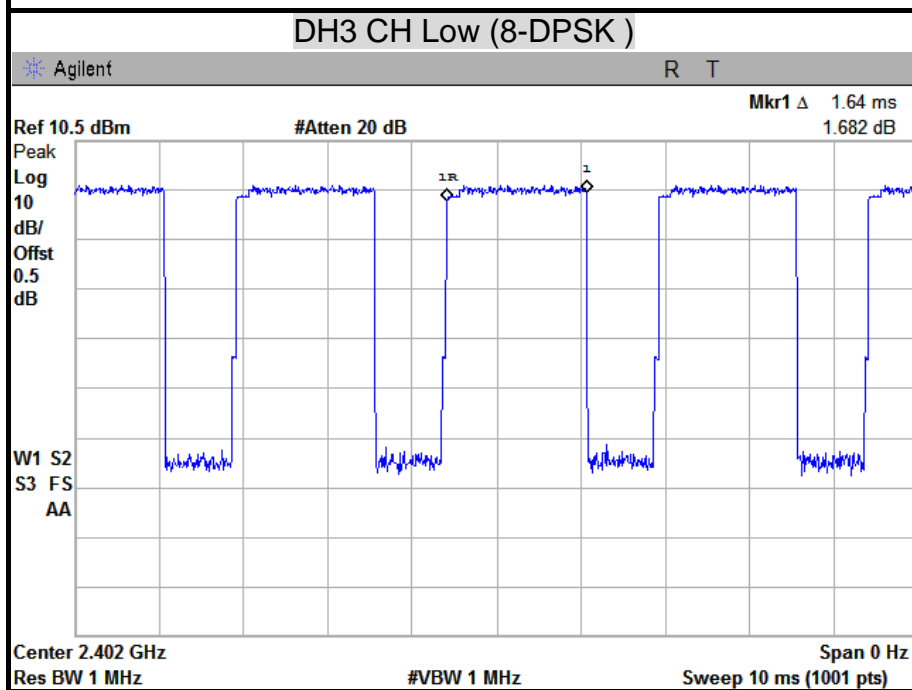
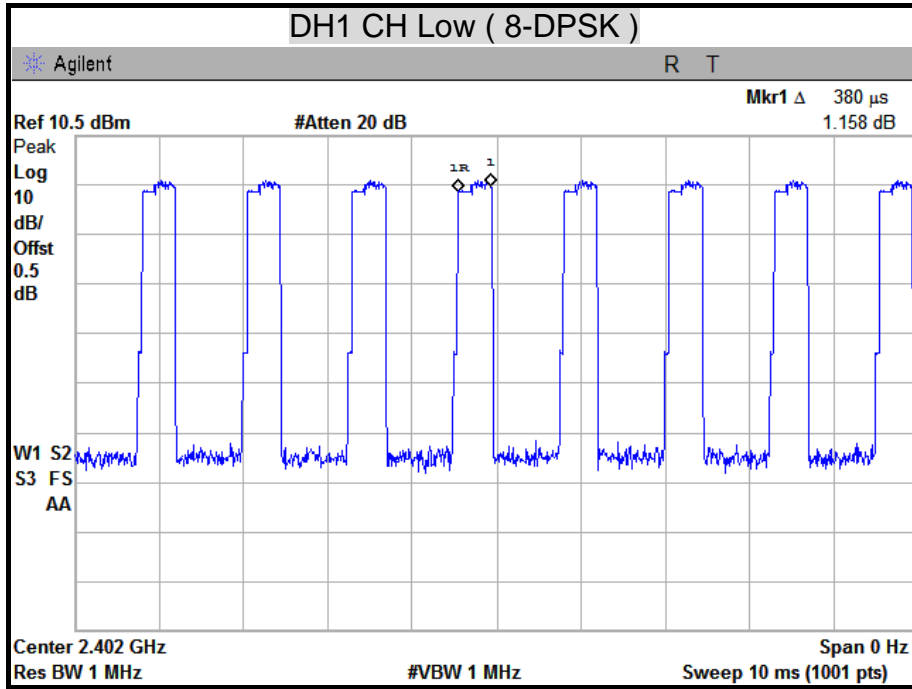

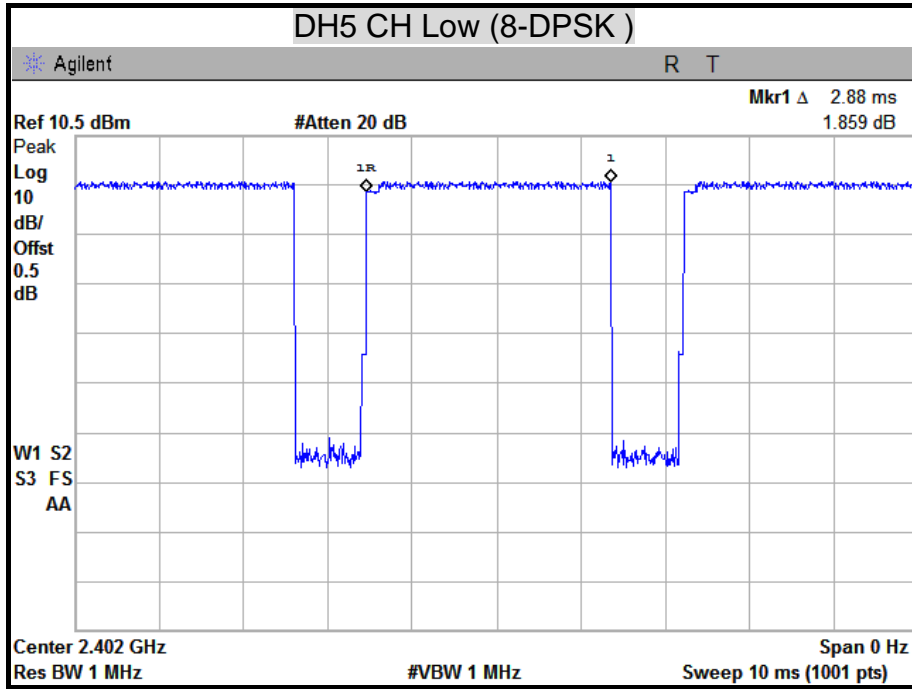

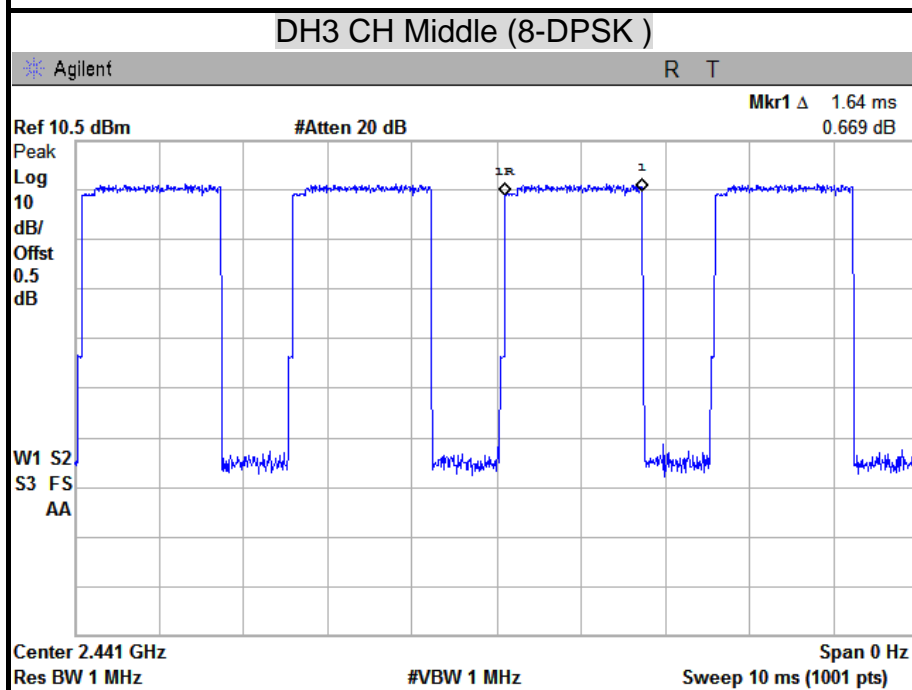
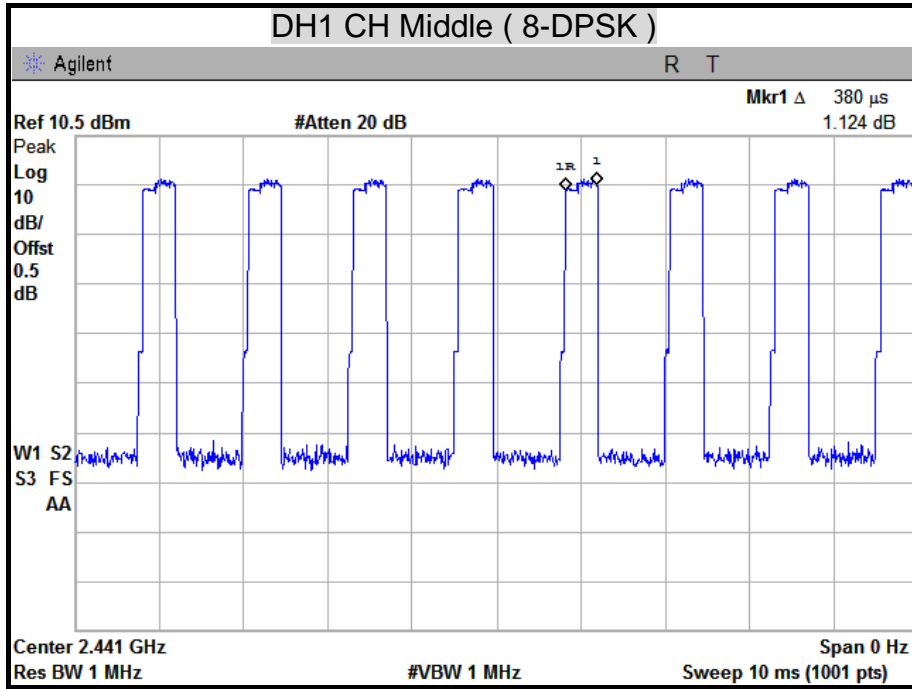

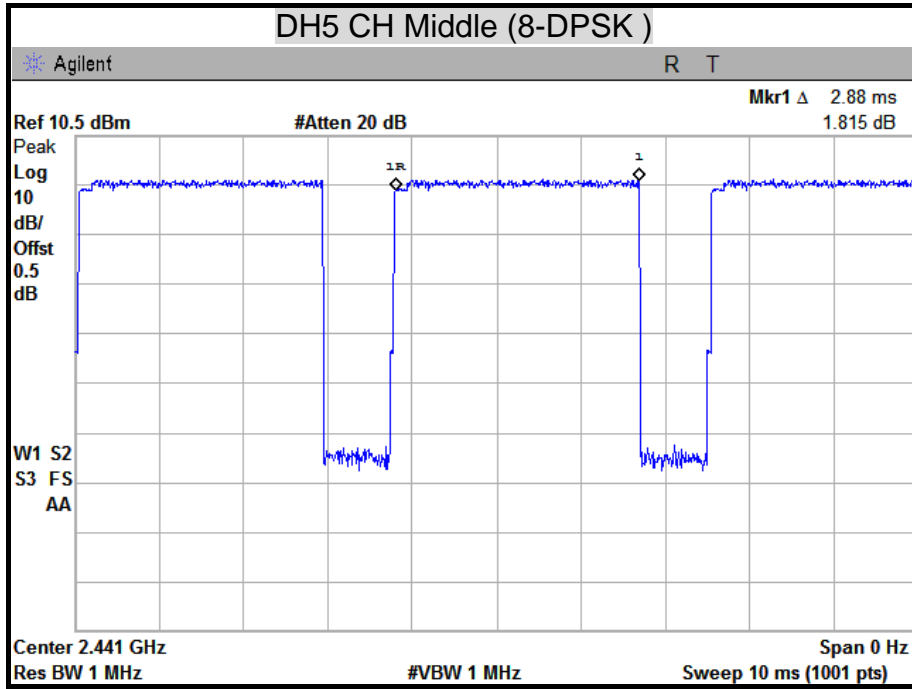

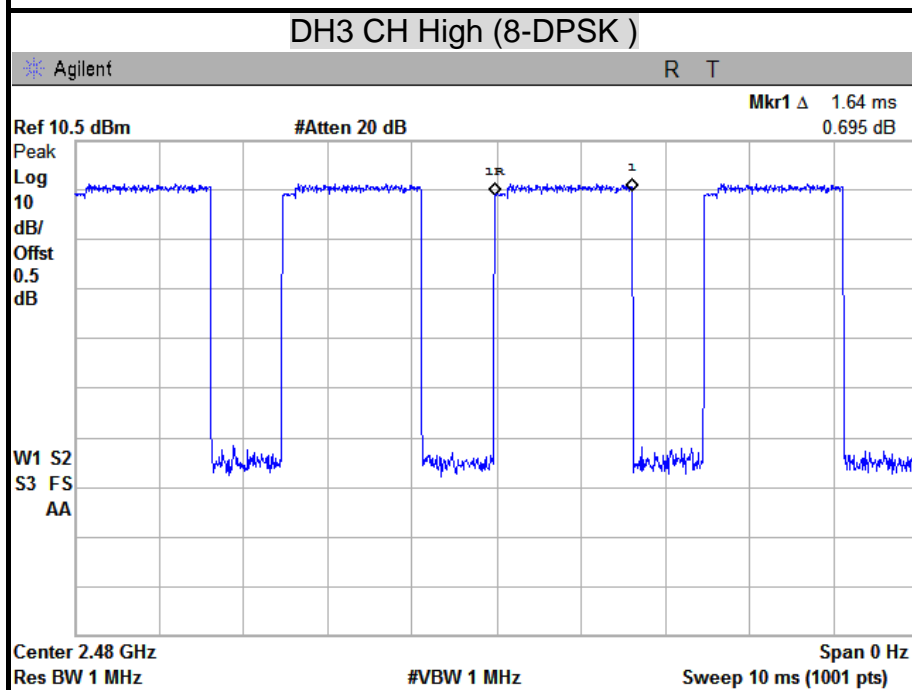
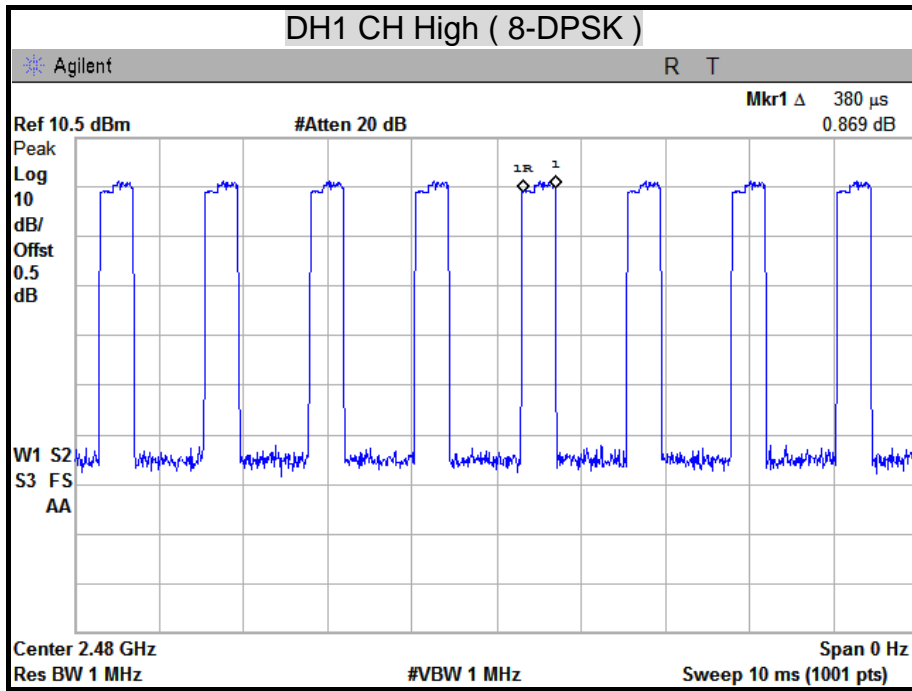

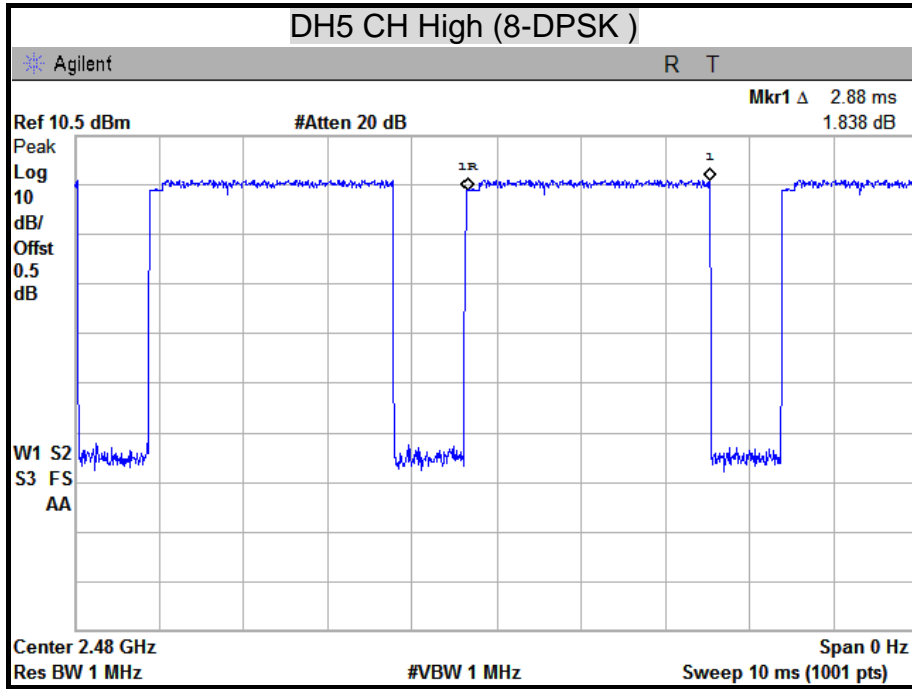



7.7 CONDUCTED SPURIOUS EMISSION

LIMITS

§ 15.247(d) In any 100 kHz bandwidth outside the frequency band in which the spread spectrum intentional radiator is operating, the radio frequency power that is produced by the intentional radiator shall be at least 20 dB below that in the 100 kHz bandwidth within the band that contains the highest level of the desired power, based on either an RF conducted or a radiated measurement. Attenuation below the general limits specified in § 15.209(a) is not required. In addition, radiated emissions which fall in the restricted bands, as defined in § 15.205(a), must also comply with the radiated emission limits specified in § 15.209(a) (see § 15.205(c)).

TEST EQUIPMENT

Name of Equipment	Manufacturer	Model	Serial Number	Calibration Due
Spectrum Analyzer	Agilent	E4407B	US41443108	08/09/2012

Remark: Each piece of equipment is scheduled for calibration once a year.

TEST SETUP

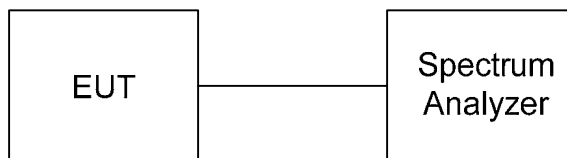

TEST PROCEDURE

The transmitter output is connected to a spectrum analyzer. The resolution bandwidth is set to 100 kHz. The video bandwidth is set to 100 kHz.

The spectrum from 30 MHz to 26.5 GHz is investigated with the transmitter set to the lowest, middle, and highest channels in the 2.4 GHz band.



TEST RESULTS

OUT-OF-BAND SPURIOUS EMISSIONS-CONDUCTED MEASUREMENT

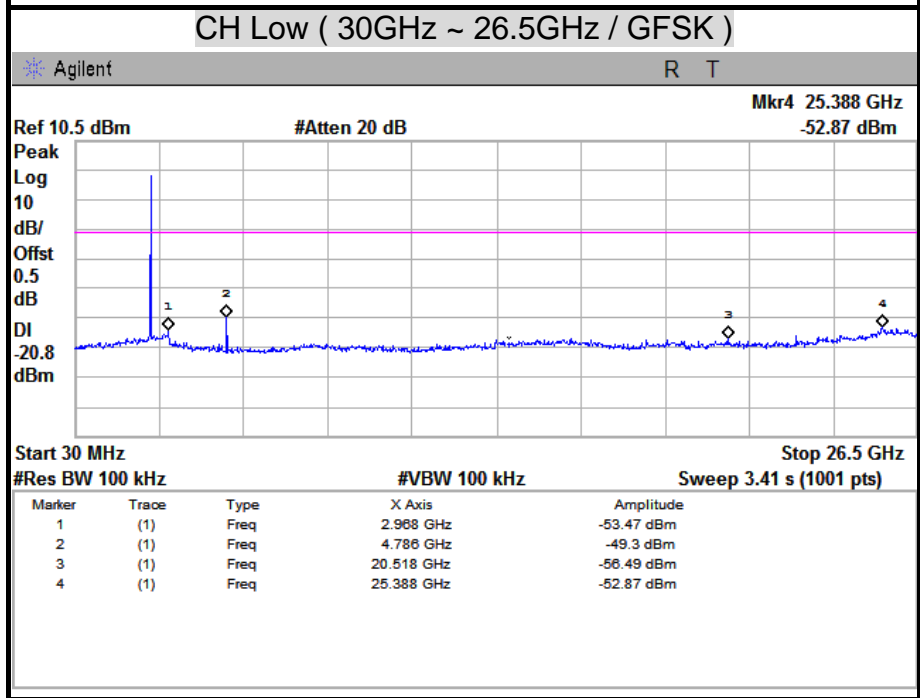
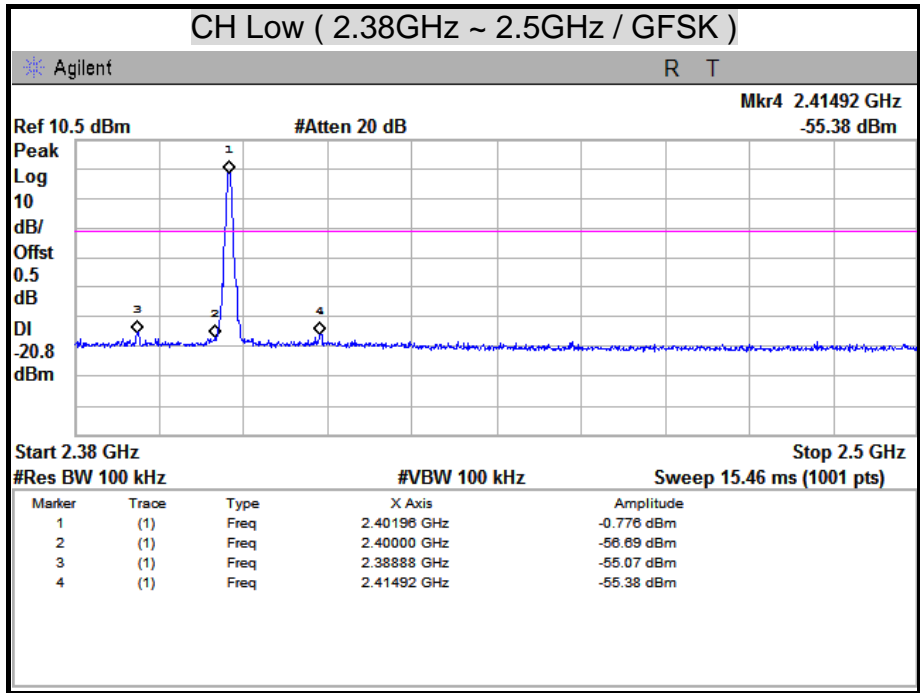

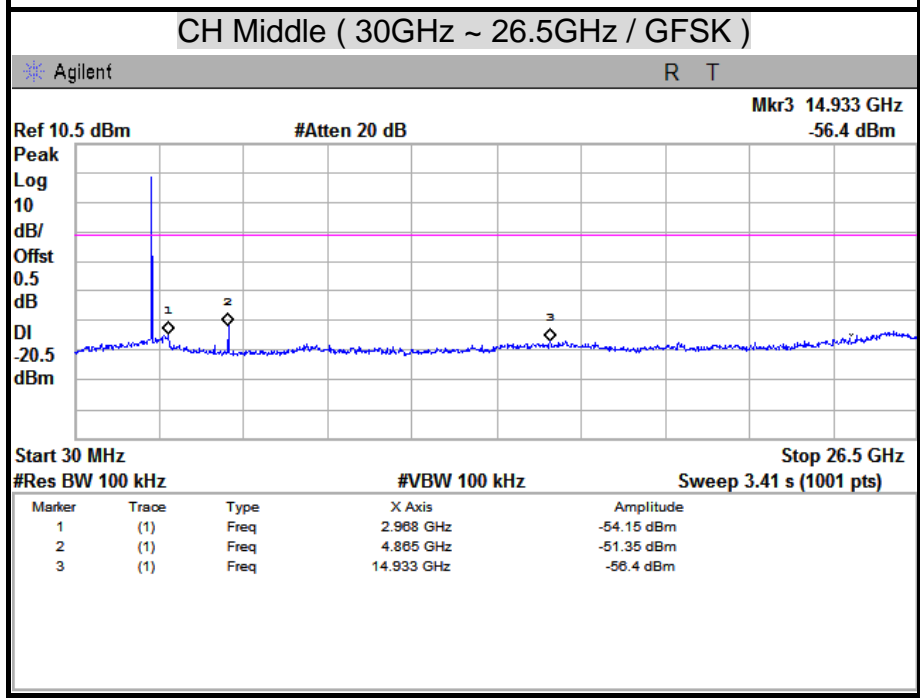
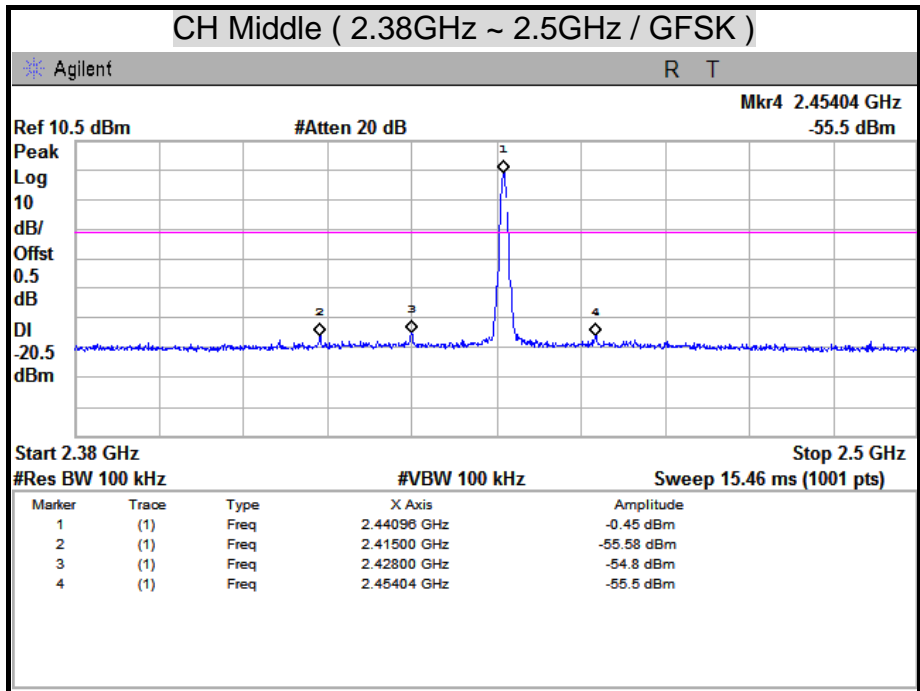

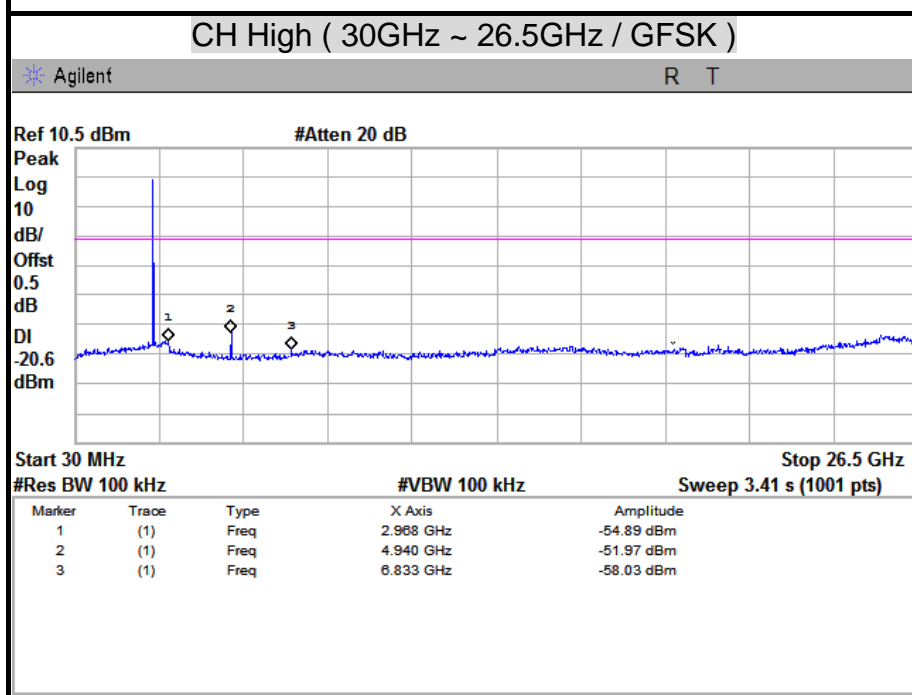
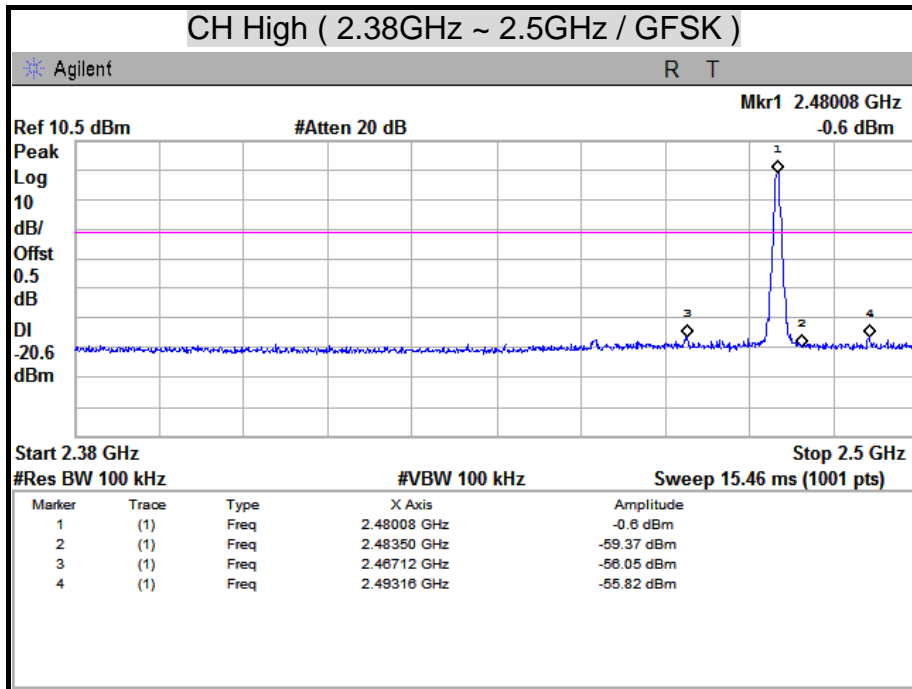

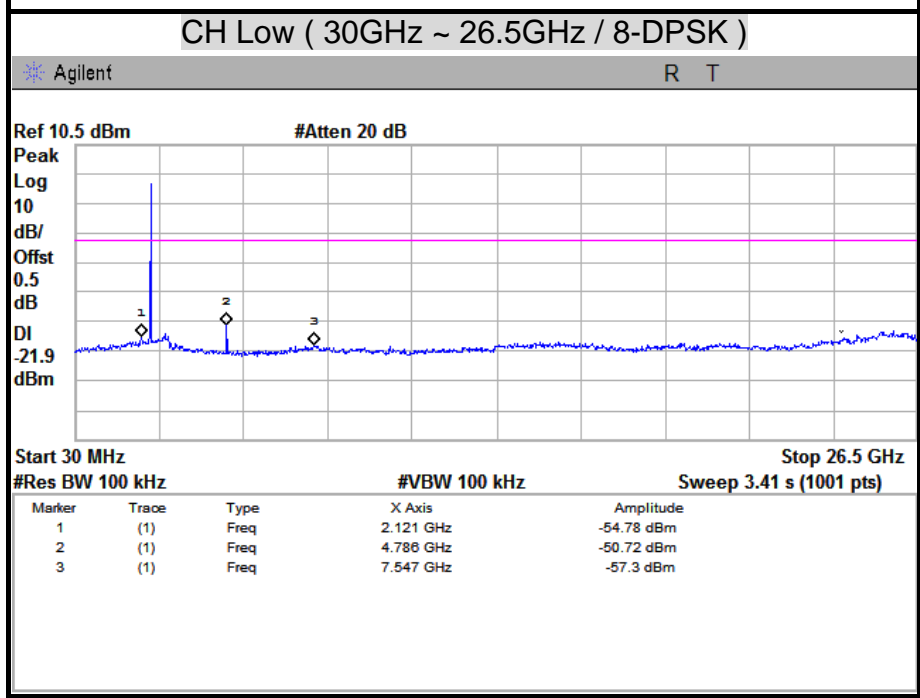
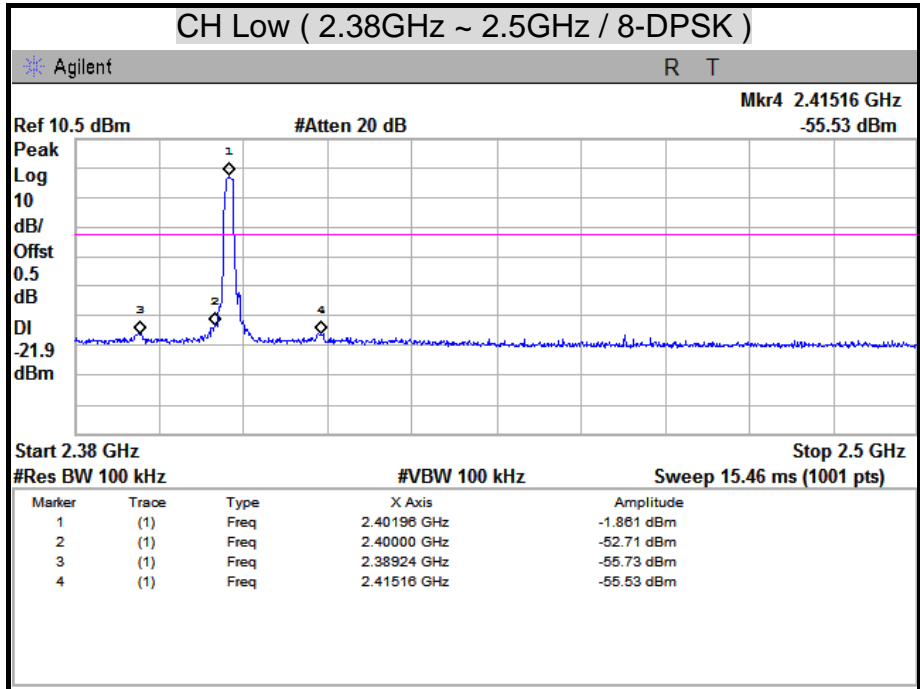

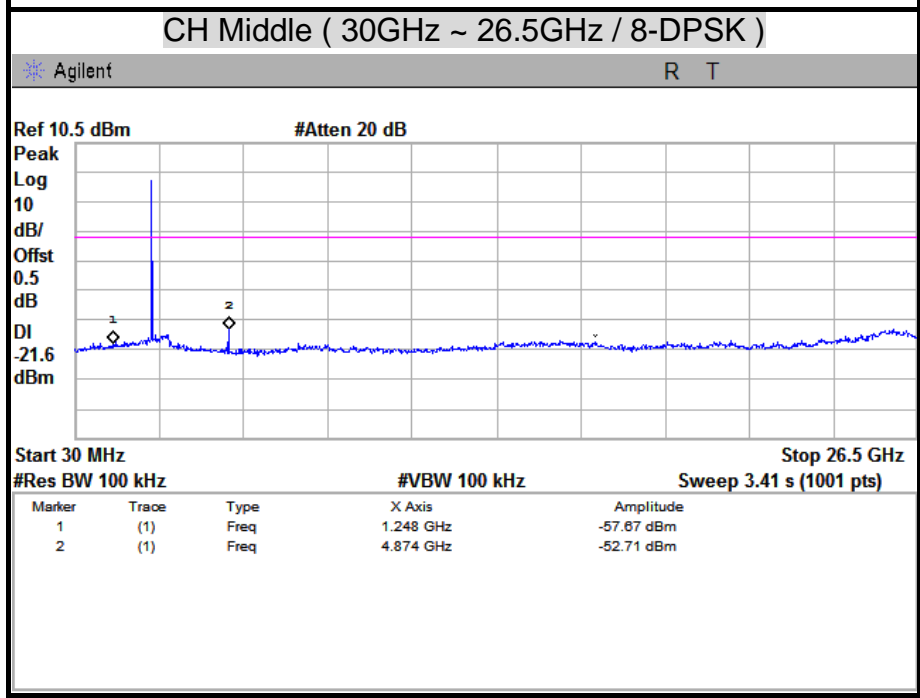
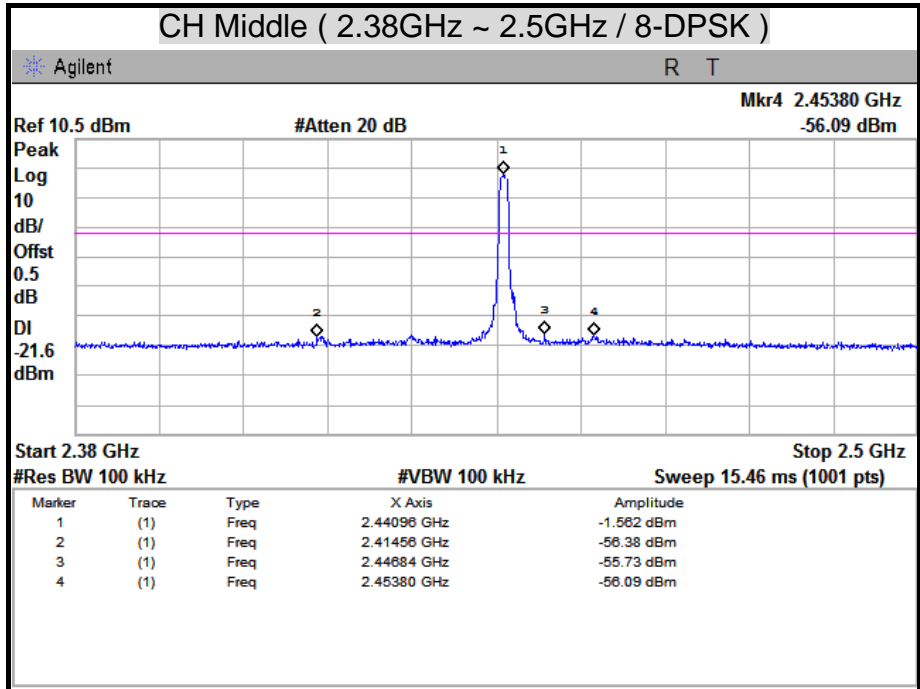

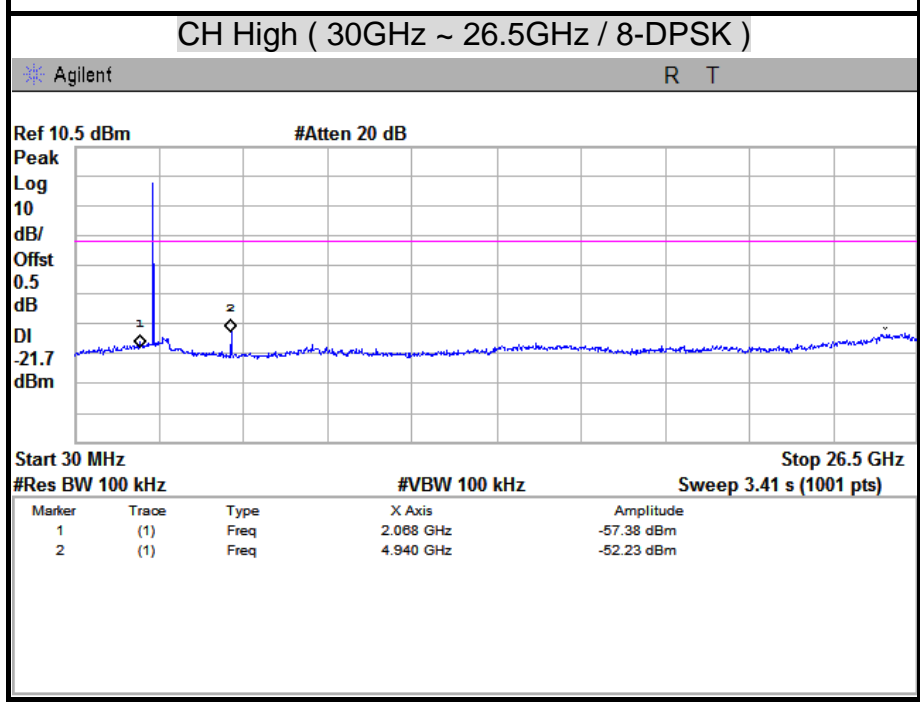
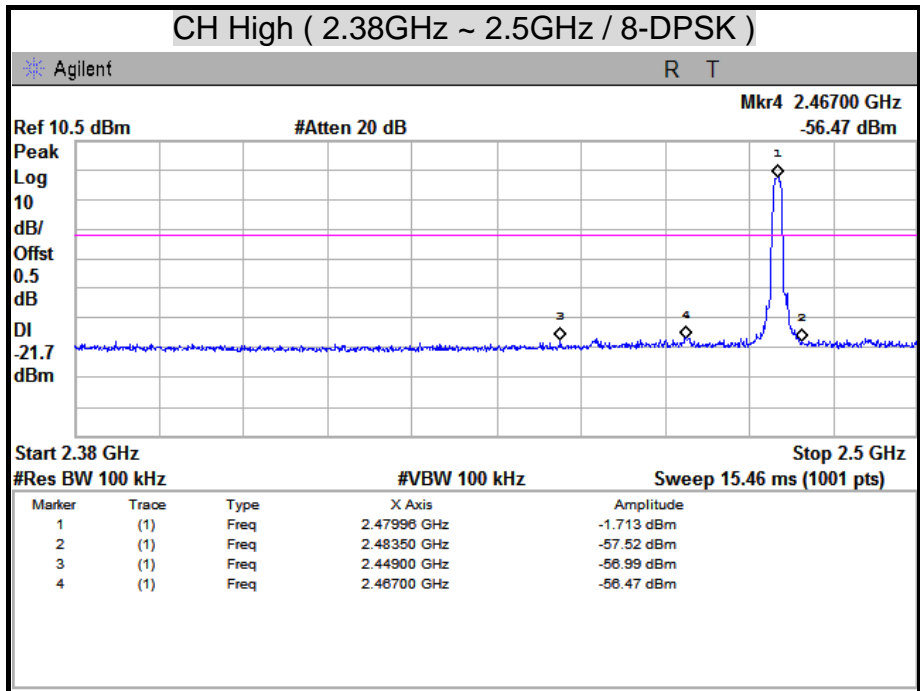



CONDUCTED MEASUREMENT BAND EDGES

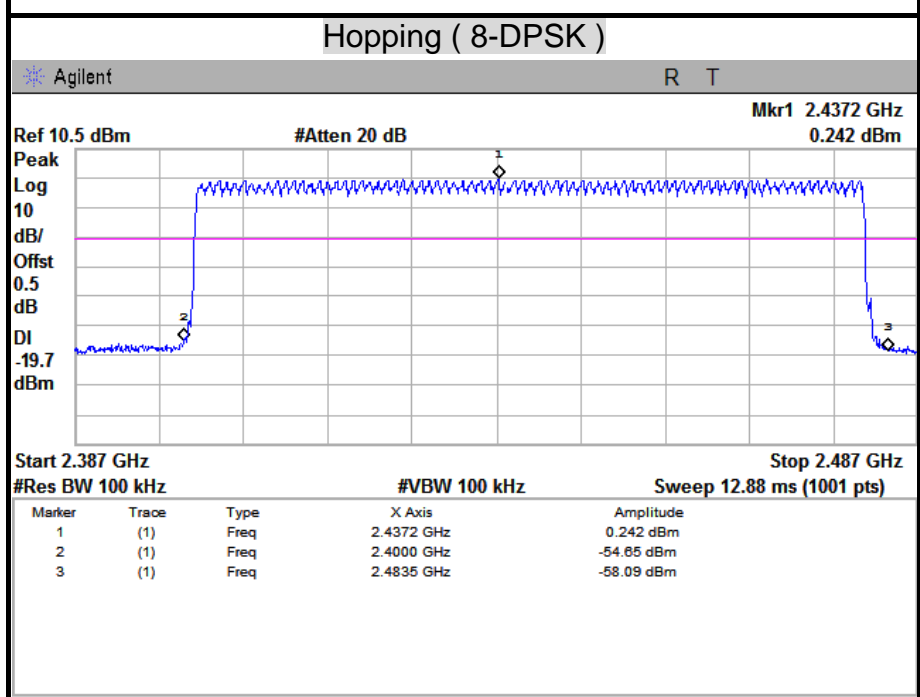
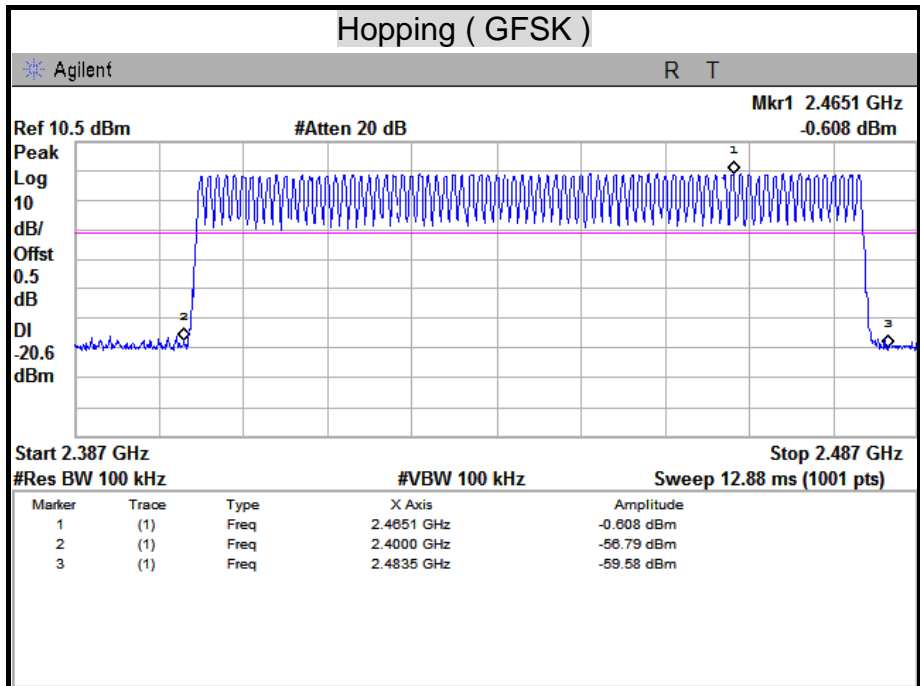



7.8 RADIATED EMISSION

LIMITS

(1) According to § 15.205 (a) Except as shown in paragraph (d) of this section, only spurious emissions are permitted in any of the frequency bands listed below:

MHz	MHz	MHz	GHz
0.090 - 0.110	16.42 - 16.423	399.9 - 410	4.5 - 5.15
¹ 0.495 - 0.505	16.69475 - 16.69525	608 - 614	5.35 - 5.46
2.1735 - 2.1905	16.80425 - 16.80475	960 - 1240	7.25 - 7.75
4.125 - 4.128	25.5 - 25.67	1300 - 1427	8.025 - 8.5
4.17725 - 4.17775	37.5 - 38.25	1435 - 1626.5	9.0 - 9.2
4.20725 - 4.20775	73 - 74.6	1645.5 - 1646.5	9.3 - 9.5
6.215 - 6.218	74.8 - 75.2	1660 - 1710	10.6 - 12.7
6.26775 - 6.26825	108 - 121.94	1718.8 - 1722.2	13.25 - 13.4
6.31175 - 6.31225	123 - 138	2200 - 2300	14.47 - 14.5
8.291 - 8.294	149.9 - 150.05	2310 - 2390	15.35 - 16.2
8.362 - 8.366	156.52475 - 156.52525	2483.5 - 2500	17.7 - 21.4
8.37625 - 8.38675	156.7 - 156.9	2655 - 2900	22.01 - 23.12
8.41425 - 8.41475	162.0125 - 167.17	3260 - 3267	23.6 - 24.0
12.29 - 12.293	167.72 - 173.2	3332 - 3339	31.2 - 31.8
12.51975 - 12.52025	240 - 285	3345.8 - 3338	36.43 - 36.5
12.57675 - 12.57725	322 - 335.4	3600 - 4400	(²)
13.36 - 13.41			

Remark:

- 1. ¹ Until February 1, 1999, this restricted band shall be 0.490-0.510 MHz.
- 2. ² Above 38.6

(2) According to § 15.205 (b) Except as provided in paragraphs (d) and (e), the field strength of emissions appearing within these frequency bands shall not exceed the limits shown in Section 15.209. At frequencies equal to or less than 1000 MHz, compliance with the limits in Section 15.209 shall be demonstrated using measurement instrumentation employing a CISPR quasi-peak detector. Above 1000 MHz, compliance with the emission limits in Section 15.209 shall be demonstrated based on the average value of the measured emissions. The provisions in Section 15.35 apply to these measurements.



(3) According to § 15.209 (a) Except as provided elsewhere in this Subpart, the emissions from an intentional radiator shall not exceed the field strength levels specified in the following table :

Frequency (MHz)	Field Strength (microvolts/meter)	Measurement Distance (meters)
0.009 – 0.490	2400/F(KHz)	300
0.490 – 1.705	24000/F(KHz)	30
1.705 – 30.0	30	30
30 - 88	100 **	3
88 - 216	150 **	3
216 - 960	200 **	3
Above 960	500	3

Remark: **Except as provided in paragraph (g), fundamental emissions from intentional radiators operating under this Section shall not be located in the frequency bands 54-72 MHz, 76-88 MHz, 174-216 MHz or 470-806 MHz. However, operation within these frequency bands is permitted under other sections of this Part, e.g., Sections 15.231 and 15.241.

(4) According to § 15.209 (b) In the emission table above, the tighter limit applies at the band edges.

TEST EQUIPMENT

966Chamber_B

Name of Equipment	Manufacture	Model	Serial Number	Calibration Due
Spectrum Analyzer	Agilent	E4446A	MY43360132	06/19/2012
EMI Receiver	ROHDE & SCHWARZ	ESCI	101131	01/13/2012
Broadband Hybrid Bi-Log Antenna	Sunol Sciences	JB1	A100209-4	10/05/2012
Double-Ridged Waveguide Horn	ETS-LINDGREN	3117	00078733	12/06/2012
Horn Antenna	COM-POWER	AH-840	03077	12/06/2012
Pre-Amplifier	Agilent	8447D	2944A10052	07/19/2012
Pre-Amplifier	Agilent	8449B	3008A01916	09/18/2012
LOOP Antenna	EMCO	6502	8905-2356	06/10/2012
Notch Filters Band Reject	Micro-Tronics	BRM05702-01	026	N.C.R

Remark: 1. Each piece of equipment is scheduled for calibration once a year.
2. N.C.R = No Calibration Request.



TEST SETUP

The diagram below shows the test setup that is utilized to make the measurements for emission from below 1GHz.

9kHz ~ 30MHz

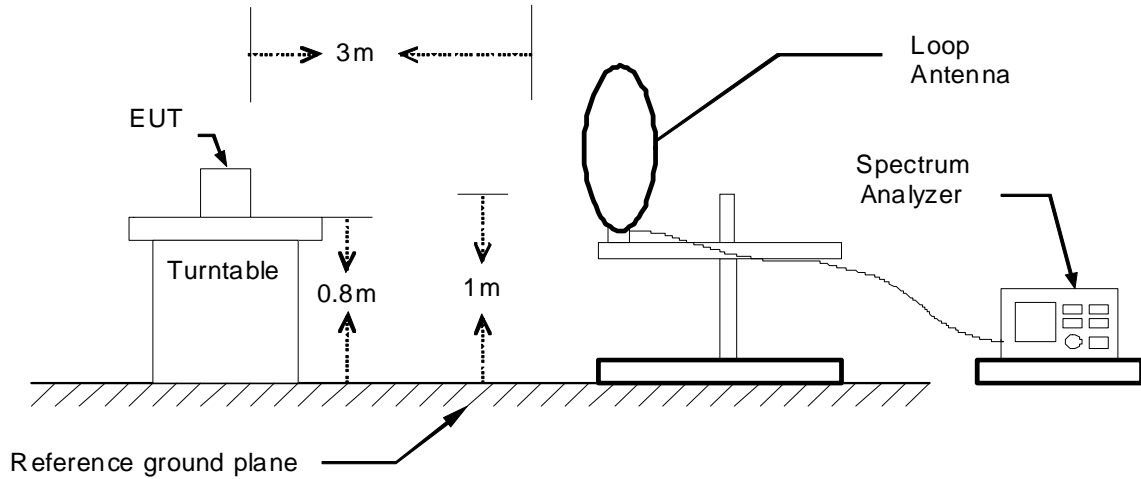

30MHz ~ 1GHz

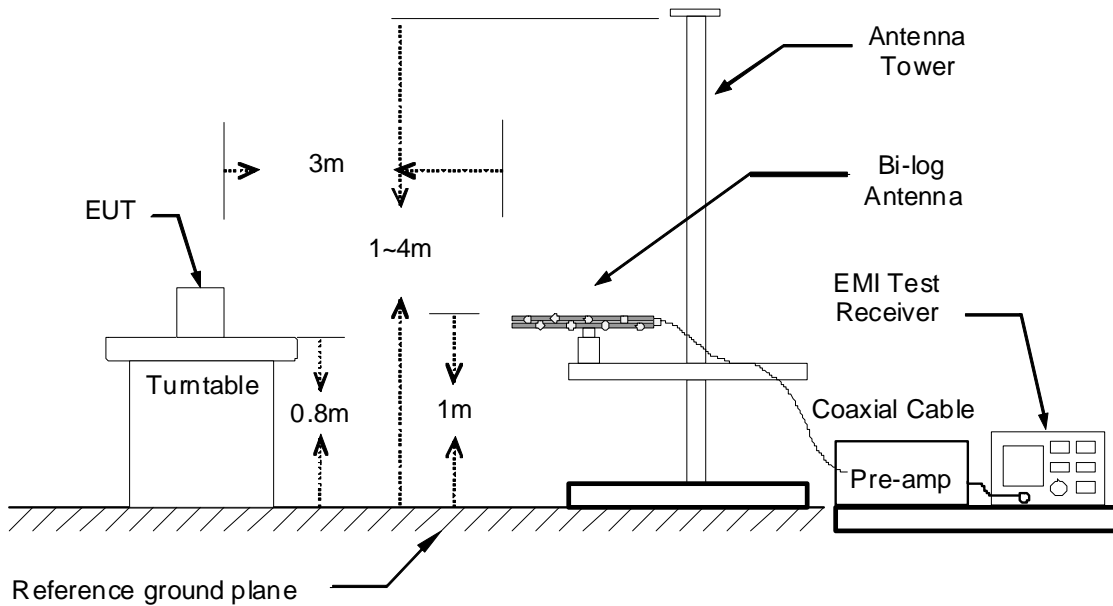



The diagram below shows the test setup that is utilized to make the measurements for emission above 1GHz.

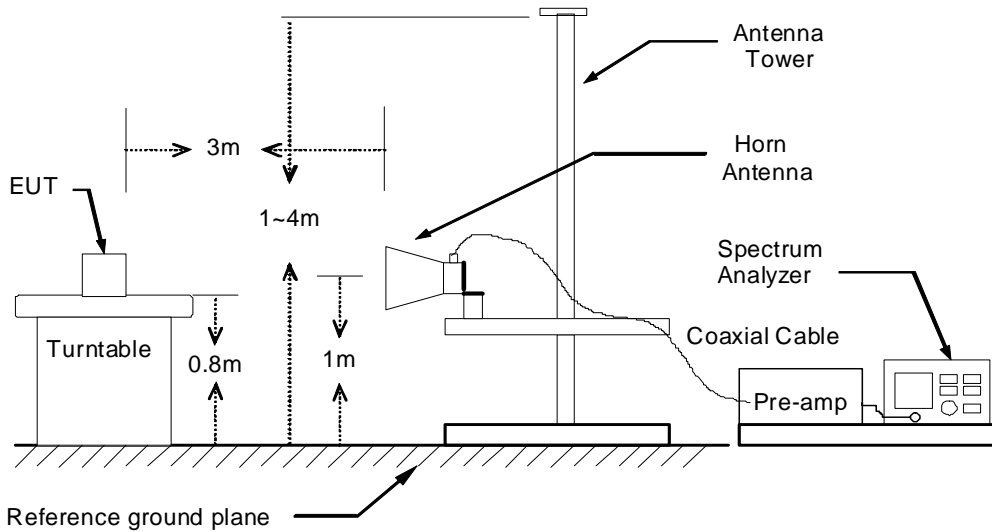

TEST PROCEDURE

1. The EUT was placed on the top of a rotating table 0.8 meters above the ground. The table was rotated 360 degrees to determine the position of the highest radiation.
2. While measuring the radiated emission below 1GHz, the EUT was set 3 meters away from the interference-receiving antenna, which was mounted on the top of a variable-height antenna tower. While measuring the radiated emission above 1GHz, the EUT was set 3 meters away from the interference-receiving antenna.
3. The antenna is a broadband antenna, and its height is varied from one meter to four meters above the ground to determine the maximum value of the field strength. Both horizontal and vertical polarization of the antenna are set to make the measurement.
4. For each suspected emission, the EUT was arranged to its worst case and then the antenna was tuned to heights from 1 meter to 4 meters and the table was turned from 0 degrees to 360 degrees to find the maximum reading.
5. The test-receiver system was set to Peak Detect Function and Specified Bandwidth with Maximum Hold Mode.
6. If the emission level of the EUT in peak mode was 10 dB lower than the limit specified, then testing could be stopped and the peak values of the EUT would be reported. Otherwise the emissions that did not have 10 dB margin would be re-tested one by one using peak, quasi-peak or average method as specified and then reported in a data sheet.

Remark :

1. The resolution bandwidth and video bandwidth of test receiver/spectrum analyzer is 120 KHz for Peak detection (PK) and Quasi-peak detection (QP) at frequency below 1GHz.
2. The resolution bandwidth and video bandwidth of test receiver/spectrum analyzer is 1 MHz for Peak detection and frequency above 1GHz.
3. The resolution bandwidth of test receiver/spectrum analyzer is 1 MHz and the video bandwidth is 10 Hz for Average detection (AV) at frequency above 1GHz.



TEST RESULTS

Below 1 GHz (9kHz ~ 30MHz)

No emission found between lowest internal used/generated frequency to 30MHz.

Below 1 GHz (30MHz ~ 1GHz)

Product Name	HK250	Test By	Bell Huang
Test Model	HK250	Test Date	2011/12/13
Test Mode	Normal Mode	TEMP & Humidity	24.1°C, 54%

966 Chamber_B at 3Meter / Horizontal						
Frequency (MHz)	Reading (dBµV)	Correction Factor (dB/m)	Result (dBµV/m)	Limit (dBµV/m)	Margin (dB)	Remark
105.66	43.93	-16.28	27.65	43.50	-15.85	Peak
158.04	44.96	-14.49	30.47	43.50	-13.03	Peak
264.74	42.30	-12.93	29.37	46.00	-16.63	Peak
284.14	42.29	-11.95	30.35	46.00	-15.65	Peak
306.45	45.88	-11.72	34.16	46.00	-11.84	Peak
388.90	38.51	-10.17	28.34	46.00	-17.66	Peak
480.08	40.48	-8.62	31.86	46.00	-14.14	Peak
960.23	35.75	-1.61	34.14	54.00	-19.86	Peak

966 Chamber_B at 3Meter / Vertical						
Frequency (MHz)	Reading (dBµV)	Correction Factor (dB/m)	Result (dBµV/m)	Limit (dBµV/m)	Margin (dB)	Remark
30.00	39.17	-6.10	33.07	40.00	-6.93	Peak
108.57	47.97	-15.74	32.23	43.50	-11.27	Peak
271.53	45.05	-12.50	32.54	46.00	-13.46	Peak
309.36	43.10	-11.66	31.44	46.00	-14.56	Peak
480.08	38.05	-8.62	29.43	46.00	-16.57	Peak
534.40	42.15	-8.02	34.13	46.00	-11.87	Peak
960.23	31.64	-1.61	30.03	54.00	-23.97	Peak

Remark:

1. Quasi-peak test would be performed if the peak result were greater than the quasi-peak limit.
2. Data of measurement within this frequency range shown " --- " in the table above means the reading of emissions are attenuated more than 20dB below the permissible limits or the field strength is too small to be measured.
3. Correction Factor (dB/m) = Antenna Factor (dB/m) + Cable Loss (dB) – PreAmp.Gain (dB)
4. Result (dBuV/m) = Reading (dBuV) + Correction Factor (dB/m)
5. Margin (dB) = Remark result (dBuV/m) - Quasi-peak limit (dBuV/m).



TX Above 1 GHz

Product Name	HK250	Test By	Bell Huang
Test Model	HK250	Test Date	2011/12/13
Test Mode	GFSK TX / CH Low	TEMP & Humidity	24.1°C, 54%

966 Chamber_B at 3Meter / Horizontal										
Frequency (MHz)	Reading-PK (dBuV)	Reading-AV (dBuV)	Correction Factor (dB/m)	Duty Cycle Correction Factor (dB)	Result-PK (dBuV/m)	Result-AV (dBuV/m)	Limit-PK (dBuV/m)	Limit-AV (dBuV/m)	Margin (dB)	Remark
1862.00	44.01	---	1.00		45.01	---	74.00	54.00	-28.99	Peak
2030.00	43.61	---	2.40		46.01	---	74.00	54.00	-27.99	Peak
2786.00	43.06	---	4.60		47.66	---	74.00	54.00	-26.34	Peak
2918.00	42.92	---	5.04		47.96	---	74.00	54.00	-26.04	Peak
4095.00	40.61	---	7.42		48.03	---	74.00	54.00	-25.97	Peak
* 4800.00	41.53	---	9.39	-30.81	50.92	20.11	74.00	54.00	-33.89	AVG

966 Chamber_B at 3Meter / Vertical										
Frequency (MHz)	Reading-PK (dBuV)	Reading-AV (dBuV)	Correction Factor (dB/m)	Duty Cycle Correction Factor (dB)	Result-PK (dBuV/m)	Result-AV (dBuV/m)	Limit-PK (dBuV/m)	Limit-AV (dBuV/m)	Margin (dB)	Remark
1064.00	49.57	---	-3.70		45.87	---	74.00	54.00	-28.13	Peak
1536.00	49.14	---	-2.13		47.01	---	74.00	54.00	-26.99	Peak
1598.00	47.74	---	-1.53		46.21	---	74.00	54.00	-27.79	Peak
1996.00	45.97	---	2.28		48.25	---	74.00	54.00	-25.75	Peak
2128.00	45.27	---	2.66		47.93	---	74.00	54.00	-26.07	Peak
2660.00	44.41	---	4.19		48.60	---	74.00	54.00	-25.40	Peak
* 4800.00	43.67	---	9.39	-30.81	53.06	22.25	74.00	54.00	-31.75	AVG
5010.00	43.14	---	9.54		52.68	---	74.00	54.00	-21.32	Peak

Remark:

1. Measuring frequencies from 1 GHz to the 10th harmonic of highest fundamental frequency.
2. Average test would be performed if the peak result were greater than the average limit.
3. Data of measurement within this frequency range shown " --- " in the table above means the reading of emissions are attenuated more than 20dB below the permissible limits or the field strength is too small to be measured.
4. Measurements above show only up to 6 maximum emissions noted, or would be lesser, with " N/A " remark, if no specific emissions from the EUT are recorded (ie: margin>20dB from the applicable limit) and considered that's already beyond the background noise floor.
5. Result = Reading + Correction Factor
Margin = Result - Limit
Remark Peak = Result(PK) - Limit(PK)
Remark AVG = Result(AV) - Limit(AV)
7. " * " For Fundamental & Harmonics: Result-AV = Result(PK) + Duty Cycle Correction Factor



Product Name	HK250	Test By	Bell Huang
Test Model	HK250	Test Date	2011/12/13
Test Mode	GFSK TX / CH Middle	TEMP & Humidity	24.1°C, 54%

966 Chamber_B at 3Meter / Horizontal

Frequency (MHz)	Reading-PK (dBuV)	Reading-AV (dBuV)	Correction Factor (dB/m)	Duty Cycle Correction Factor (dB)	Result-PK (dBuV/m)	Result-AV (dBuV/m)	Limit-PK (dBuV/m)	Limit-AV (dBuV/m)	Margin (dB)	Remark
1960.00	45.12	---	1.94		47.06	---	74.00	54.00	-26.94	Peak
2076.00	43.17	---	2.52		45.69	---	74.00	54.00	-28.31	Peak
2302.00	42.75	---	3.13		45.88	---	74.00	54.00	-28.12	Peak
2808.00	42.71	---	4.68		47.39	---	74.00	54.00	-26.61	Peak
4125.00	40.58	---	7.55		48.13	---	74.00	54.00	-25.87	Peak
* 4875.00	41.61	---	9.44	-30.81	51.05	20.24	74.00	54.00	-33.76	AVG

966 Chamber_B at 3Meter / Vertical

Frequency (MHz)	Reading-PK (dBuV)	Reading-AV (dBuV)	Correction Factor (dB/m)	Duty Cycle Correction Factor (dB)	Result-PK (dBuV/m)	Result-AV (dBuV/m)	Limit-PK (dBuV/m)	Limit-AV (dBuV/m)	Margin (dB)	Remark
1066.00	49.18	---	-3.69		45.49	---	74.00	54.00	-28.51	Peak
1466.00	48.31	---	-2.57		45.74	---	74.00	54.00	-28.26	Peak
1520.00	47.63	---	-2.28		45.35	---	74.00	54.00	-28.65	Peak
1986.00	46.60	---	2.19		48.79	---	74.00	54.00	-25.21	Peak
2128.00	44.19	---	2.66		46.85	---	74.00	54.00	-27.15	Peak
2664.00	43.63	---	4.20		47.83	---	74.00	54.00	-26.17	Peak
* 4875.00	46.21	---	9.44	-30.81	55.65	24.84	74.00	54.00	-29.16	AVG
5790.00	39.36	---	11.48		50.84	---	74.00	54.00	-23.16	Peak

Remark:

1. Measuring frequencies from 1 GHz to the 10th harmonic of highest fundamental frequency.
2. Average test would be performed if the peak result were greater than the average limit.
3. Data of measurement within this frequency range shown " --- " in the table above means the reading of emissions are attenuated more than 20dB below the permissible limits or the field strength is too small to be measured.
4. Measurements above show only up to 6 maximum emissions noted, or would be lesser, with " N/A " remark, if no specific emissions from the EUT are recorded (ie: margin>20dB from the applicable limit) and considered that's already beyond the background noise floor.
5. Result = Reading + Correction Factor
Margin = Result - Limit
Remark Peak = Result(PK) - Limit(PK)
Remark AVG = Result(AV) - Limit(AV)
7. " * " For Fundamental & Harmonics: Result-AV = Result(PK) + Duty Cycle Correction Factor



Product Name	HK250	Test By	Bell Huang
Test Model	HK250	Test Date	2011/12/13
Test Mode	GFSK TX / CH High	TEMP & Humidity	24.1°C, 54%

966 Chamber_B at 3Meter / Horizontal

Frequency (MHz)	Reading-PK (dBuV)	Reading-AV (dBuV)	Correction Factor (dB/m)	Duty Cycle Correction Factor (dB)	Result-PK (dBuV/m)	Result-AV (dBuV/m)	Limit-PK (dBuV/m)	Limit-AV (dBuV/m)	Margin (dB)	Remark
1538.00	45.49	---	-2.11		43.38	---	74.00	54.00	-30.62	Peak
2080.00	43.89	---	2.53		46.42	---	74.00	54.00	-27.58	Peak
2238.00	42.93	---	2.96		45.89	---	74.00	54.00	-28.11	Peak
2934.00	42.22	---	5.09		47.31	---	74.00	54.00	-26.69	Peak
4245.00	40.09	---	8.07		48.16	---	74.00	54.00	-25.84	Peak
* 4965.00	44.19	---	9.50	-30.81	53.69	22.88	74.00	54.00	-31.12	AVG

966 Chamber_B at 3Meter / Vertical

Frequency (MHz)	Reading-PK (dBuV)	Reading-AV (dBuV)	Correction Factor (dB/m)	Duty Cycle Correction Factor (dB)	Result-PK (dBuV/m)	Result-AV (dBuV/m)	Limit-PK (dBuV/m)	Limit-AV (dBuV/m)	Margin (dB)	Remark
1064.00	50.70	---	-3.70		47.00	---	74.00	54.00	-27.00	Peak
1980.00	44.97	---	2.13		47.10	---	74.00	54.00	-26.90	Peak
2132.00	44.75	---	2.67		47.42	---	74.00	54.00	-26.58	Peak
2588.00	43.52	---	3.95		47.47	---	74.00	54.00	-26.53	Peak
2662.00	43.77	---	4.19		47.96	---	74.00	54.00	-26.04	Peak
3825.00	41.79	---	6.60		48.39	---	74.00	54.00	-25.61	Peak
* 4965.00	46.92	---	9.50	-30.81	56.42	25.61	74.00	54.00	-28.39	AVG

Remark:

1. Measuring frequencies from 1 GHz to the 10th harmonic of highest fundamental frequency.
2. Average test would be performed if the peak result were greater than the average limit.
3. Data of measurement within this frequency range shown " --- " in the table above means the reading of emissions are attenuated more than 20dB below the permissible limits or the field strength is too small to be measured.
4. Measurements above show only up to 6 maximum emissions noted, or would be lesser, with " N/A " remark, if no specific emissions from the EUT are recorded (ie: margin>20dB from the applicable limit) and considered that's already beyond the background noise floor.
5. Result = Reading + Correction Factor
Margin = Result - Limit
Remark Peak = Result(PK) - Limit(PK)
Remark AVG = Result(AV) - Limit(AV)
7. " * " For Fundamental & Harmonics: Result-AV = Result(PK) + Duty Cycle Correction Factor



Product Name	HK250	Test By	Bell Huang
Test Model	HK250	Test Date	2011/12/13
Test Mode	8-DPSK TX / CH Low	TEMP & Humidity	24.1°C, 54%

966 Chamber_B at 3Meter / Horizontal										
Frequency (MHz)	Reading-PK (dBuV)	Reading-AV (dBuV)	Correction Factor (dB/m)	Duty Cycle Correction Factor (dB)	Result-PK (dBuV/m)	Result-AV (dBuV/m)	Limit-PK (dBuV/m)	Limit-AV (dBuV/m)	Margin (dB)	Remark
1064.00	46.73	---	-3.70		43.03	---	74.00	54.00	-30.97	Peak
1988.00	44.52	---	2.21		46.73	---	74.00	54.00	-27.27	Peak
2170.00	43.87	---	2.78		46.65	---	74.00	54.00	-27.35	Peak
2238.00	43.39	---	2.96		46.35	---	74.00	54.00	-27.65	Peak
4560.00	39.86	---	9.23		49.09	---	74.00	54.00	-24.91	Peak
* 4800.00	42.16	---	9.39	-30.81	51.55	20.74	74.00	54.00	-33.26	AVG

966 Chamber_B at 3Meter / Vertical										
Frequency (MHz)	Reading-PK (dBuV)	Reading-AV (dBuV)	Correction Factor (dB/m)	Duty Cycle Correction Factor (dB)	Result-PK (dBuV/m)	Result-AV (dBuV/m)	Limit-PK (dBuV/m)	Limit-AV (dBuV/m)	Margin (dB)	Remark
1066.00	49.59	---	-3.69		45.90	---	74.00	54.00	-28.10	Peak
1600.00	46.89	---	-1.51		45.38	---	74.00	54.00	-28.62	Peak
1872.00	45.28	---	1.09		46.37	---	74.00	54.00	-27.63	Peak
1988.00	45.24	---	2.21		47.45	---	74.00	54.00	-26.55	Peak
2132.00	44.78	---	2.67		47.45	---	74.00	54.00	-26.55	Peak
* 4800.00	44.39	---	9.39	-30.81	53.78	22.97	74.00	54.00	-31.03	AVG
4995.00	41.15	---	9.52		50.67	---	74.00	54.00	-23.33	Peak

Remark:

1. Measuring frequencies from 1 GHz to the 10th harmonic of highest fundamental frequency.
2. Average test would be performed if the peak result were greater than the average limit.
3. Data of measurement within this frequency range shown " --- " in the table above means the reading of emissions are attenuated more than 20dB below the permissible limits or the field strength is too small to be measured.
4. Measurements above show only up to 6 maximum emissions noted, or would be lesser, with " N/A " remark, if no specific emissions from the EUT are recorded (ie: margin>20dB from the applicable limit) and considered that's already beyond the background noise floor.
5. Result = Reading + Correction Factor
Margin = Result - Limit
Remark Peak = Result(PK) - Limit(PK)
Remark AVG = Result(AV) - Limit(AV)
7. " * " For Fundamental & Harmonics: Result-AV = Result(PK) + Duty Cycle Correction Factor



Product Name	HK250	Test By	Bell Huang
Test Model	HK250	Test Date	2011/12/13
Test Mode	8-DPSK TX / CH Middle	TEMP & Humidity	24.1°C, 54%

966 Chamber_B at 3Meter / Horizontal										
Frequency (MHz)	Reading-PK (dBuV)	Reading-AV (dBuV)	Correction Factor (dB/m)	Duty Cycle Correction Factor (dB)	Result-PK (dBuV/m)	Result-AV (dBuV/m)	Limit-PK (dBuV/m)	Limit-AV (dBuV/m)	Margin (dB)	Remark
1084.00	46.32	---	-3.64		42.68	---	74.00	54.00	-31.32	Peak
1516.00	44.82	---	-2.32		42.50	---	74.00	54.00	-31.50	Peak
1986.00	44.67	---	2.19		46.86	---	74.00	54.00	-27.14	Peak
2632.00	43.95	---	4.10		48.05	---	74.00	54.00	-25.95	Peak
* 4875.00	42.13	---	9.44	-30.81	51.57	20.76	74.00	54.00	-33.24	AVG

966 Chamber_B at 3Meter / Vertical										
Frequency (MHz)	Reading-PK (dBuV)	Reading-AV (dBuV)	Correction Factor (dB/m)	Duty Cycle Correction Factor (dB)	Result-PK (dBuV/m)	Result-AV (dBuV/m)	Limit-PK (dBuV/m)	Limit-AV (dBuV/m)	Margin (dB)	Remark
1068.00	49.04	---	-3.69		45.35	---	74.00	54.00	-28.65	Peak
1996.00	44.47	---	2.28		46.75	---	74.00	54.00	-27.25	Peak
2136.00	44.40	---	2.68		47.08	---	74.00	54.00	-26.92	Peak
2664.00	44.76	---	4.20		48.96	---	74.00	54.00	-25.04	Peak
2892.00	43.01	---	4.95		47.96	---	74.00	54.00	-26.04	Peak
* 4875.00	47.08	---	9.44	-30.81	56.52	25.71	74.00	54.00	-28.29	AVG
5040.00	40.86	---	9.62		50.48	---	74.00	54.00	-23.52	Peak

Remark:

1. Measuring frequencies from 1 GHz to the 10th harmonic of highest fundamental frequency.
2. Average test would be performed if the peak result were greater than the average limit.
3. Data of measurement within this frequency range shown " --- " in the table above means the reading of emissions are attenuated more than 20dB below the permissible limits or the field strength is too small to be measured.
4. Measurements above show only up to 6 maximum emissions noted, or would be lesser, with " N/A " remark, if no specific emissions from the EUT are recorded (ie: margin>20dB from the applicable limit) and considered that's already beyond the background noise floor.
5. Result = Reading + Correction Factor
Margin = Result - Limit
Remark Peak = Result(PK) - Limit(PK)
Remark AVG = Result(AV) - Limit(AV)
7. " * " For Fundamental & Harmonics: Result-AV = Result(PK) + Duty Cycle Correction Factor



Product Name	HK250	Test By	Bell Huang
Test Model	HK250	Test Date	2011/12/13
Test Mode	8-DPSK TX / CH High	TEMP & Humidity	24.1°C, 54%

966 Chamber_B at 3Meter / Horizontal										
Frequency (MHz)	Reading-PK (dBuV)	Reading-AV (dBuV)	Correction Factor (dB/m)	Duty Cycle Correction Factor (dB)	Result-PK (dBuV/m)	Result-AV (dBuV/m)	Limit-PK (dBuV/m)	Limit-AV (dBuV/m)	Margin (dB)	Remark
1766.00	44.49	---	0.08		44.57	---	74.00	54.00	-29.43	Peak
1980.00	44.41	---	2.13		46.54	---	74.00	54.00	-27.46	Peak
2662.00	43.05	---	4.19		47.24	---	74.00	54.00	-26.76	Peak
2840.00	42.61	---	4.78		47.39	---	74.00	54.00	-26.61	Peak
* 4965.00	45.31	---	9.50	-30.81	54.81	24.00	74.00	54.00	-30.00	AVG

966 Chamber_B at 3Meter / Vertical										
Frequency (MHz)	Reading-PK (dBuV)	Reading-AV (dBuV)	Correction Factor (dB/m)	Duty Cycle Correction Factor (dB)	Result-PK (dBuV/m)	Result-AV (dBuV/m)	Limit-PK (dBuV/m)	Limit-AV (dBuV/m)	Margin (dB)	Remark
1066.00	49.34	---	-3.69		45.65	---	74.00	54.00	-28.35	Peak
1470.00	46.37	---	-2.55		43.82	---	74.00	54.00	-30.18	Peak
1996.00	45.54	---	2.28		47.82	---	74.00	54.00	-26.18	Peak
2136.00	45.03	---	2.68		47.71	---	74.00	54.00	-26.29	Peak
2664.00	44.24	---	4.20		48.44	---	74.00	54.00	-25.56	Peak
* 4965.00	49.72	---	9.50	-30.81	59.22	28.41	74.00	54.00	-25.59	AVG

Remark:

1. Measuring frequencies from 1 GHz to the 10th harmonic of highest fundamental frequency.
2. Average test would be performed if the peak result were greater than the average limit.
3. Data of measurement within this frequency range shown " --- " in the table above means the reading of emissions are attenuated more than 20dB below the permissible limits or the field strength is too small to be measured.
4. Measurements above show only up to 6 maximum emissions noted, or would be lesser, with " N/A " remark, if no specific emissions from the EUT are recorded (ie: margin>20dB from the applicable limit) and considered that's already beyond the background noise floor.
5. Result = Reading + Correction Factor
Margin = Result - Limit
Remark Peak = Result(PK) - Limit(PK)
Remark AVG = Result(AV) - Limit(AV)
7. " * " For Fundamental & Harmonics: Result-AV = Result(PK) + Duty Cycle Correction Factor



Restricted Band Edges

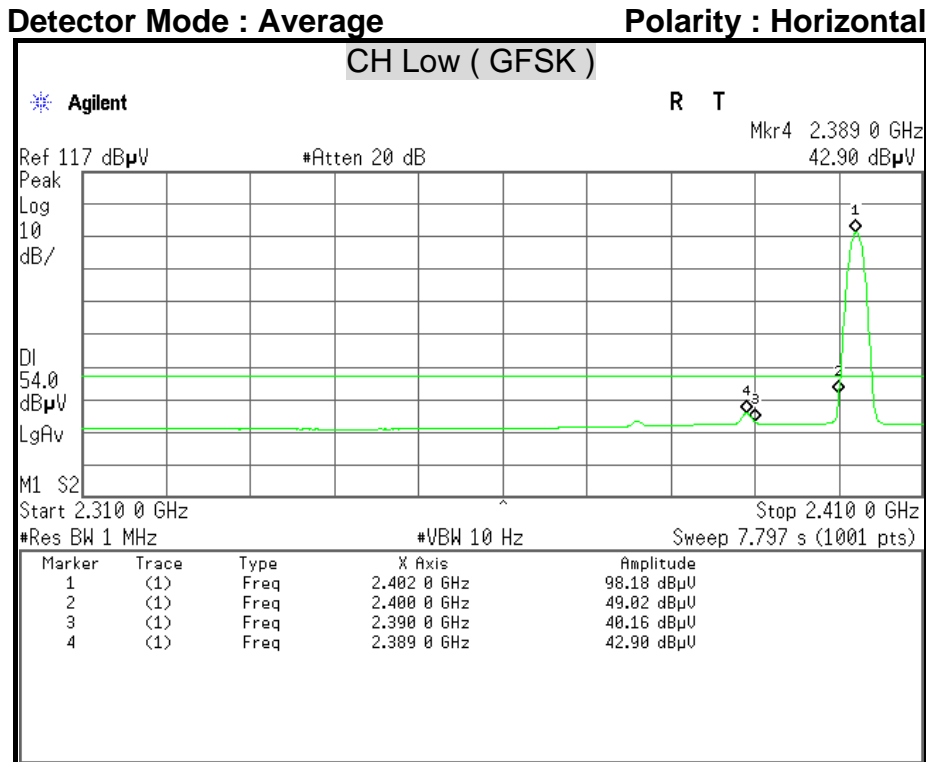
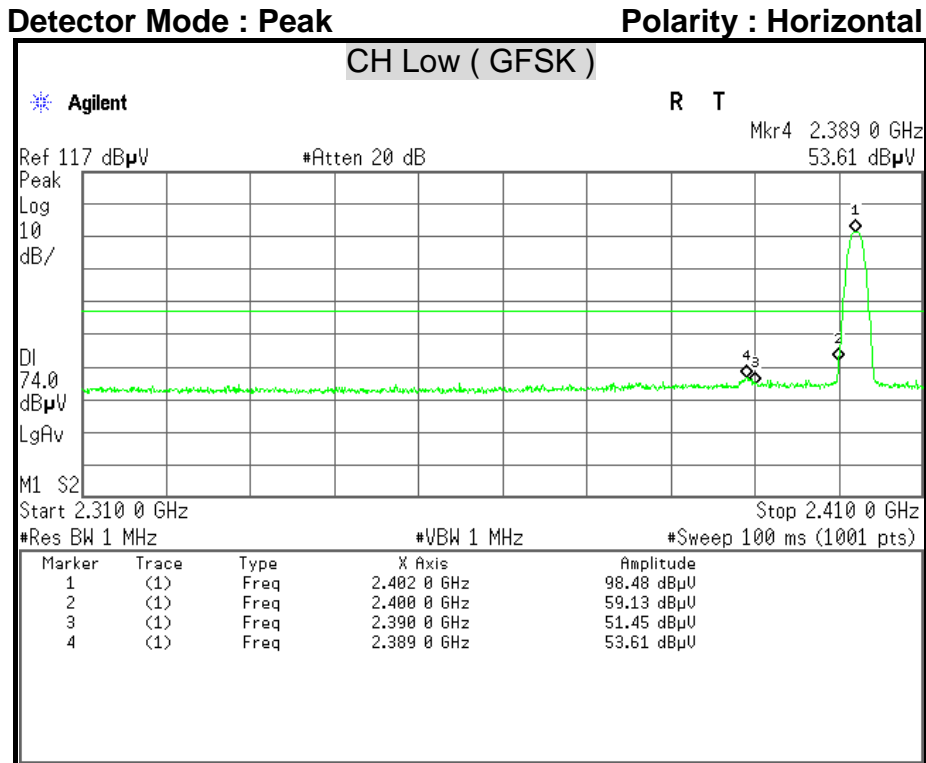



Detector Mode : Peak

Polarity : Vertical

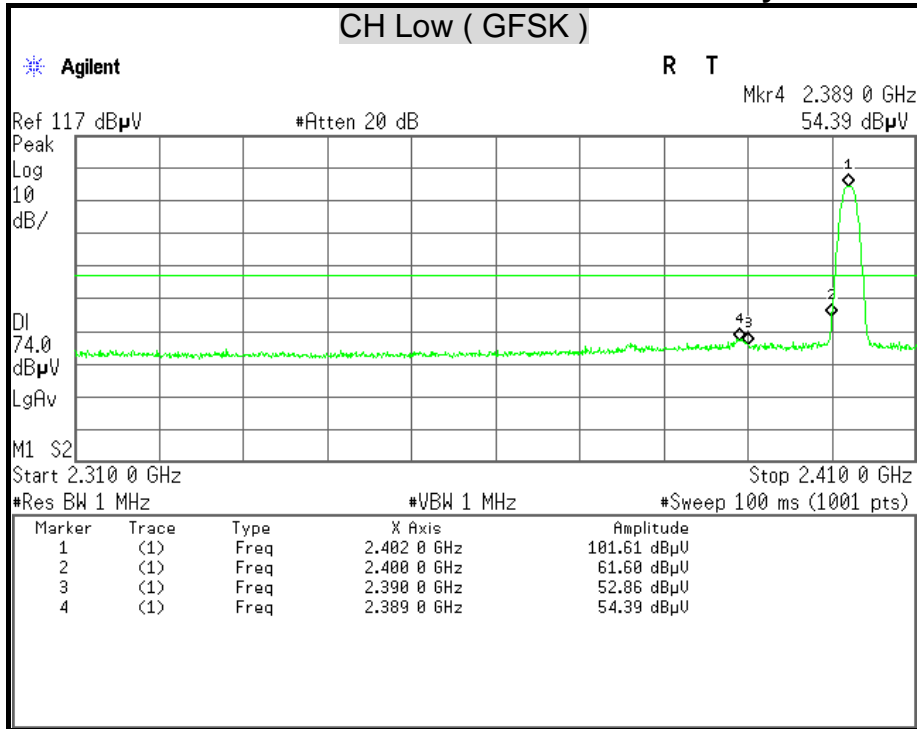

Detector Mode : Average

Polarity : Vertical

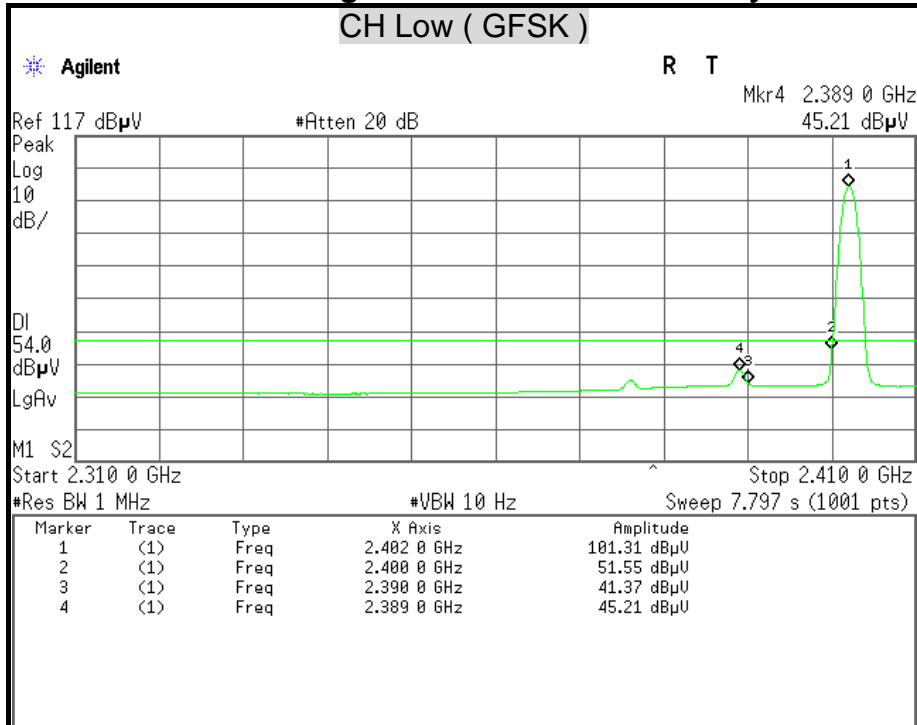



Detector Mode : Peak

Polarity : Horizontal

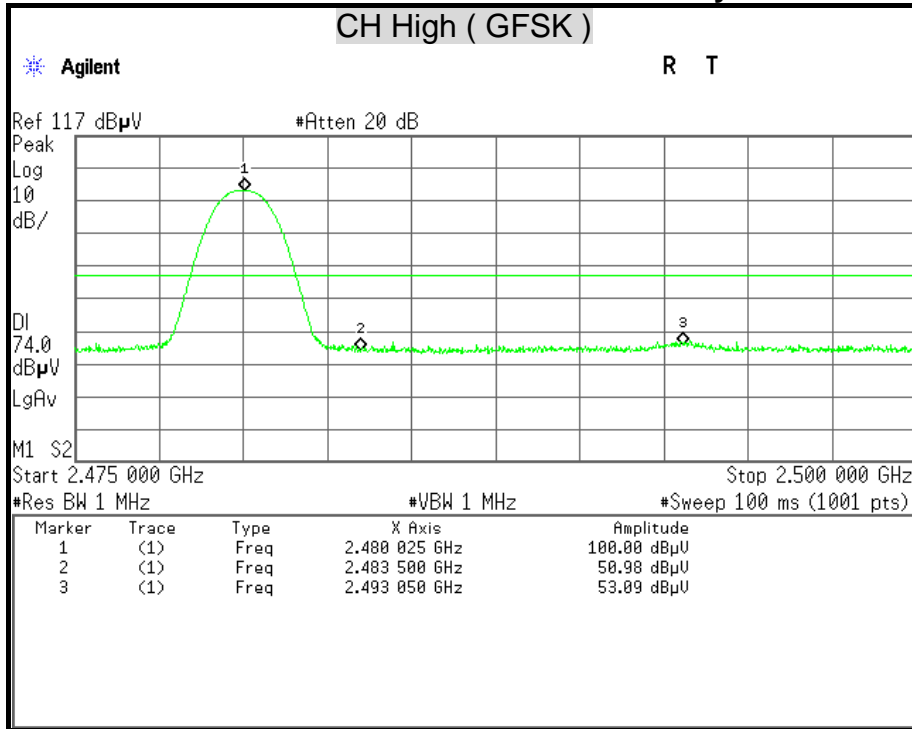

Detector Mode : Average

Polarity : Horizontal

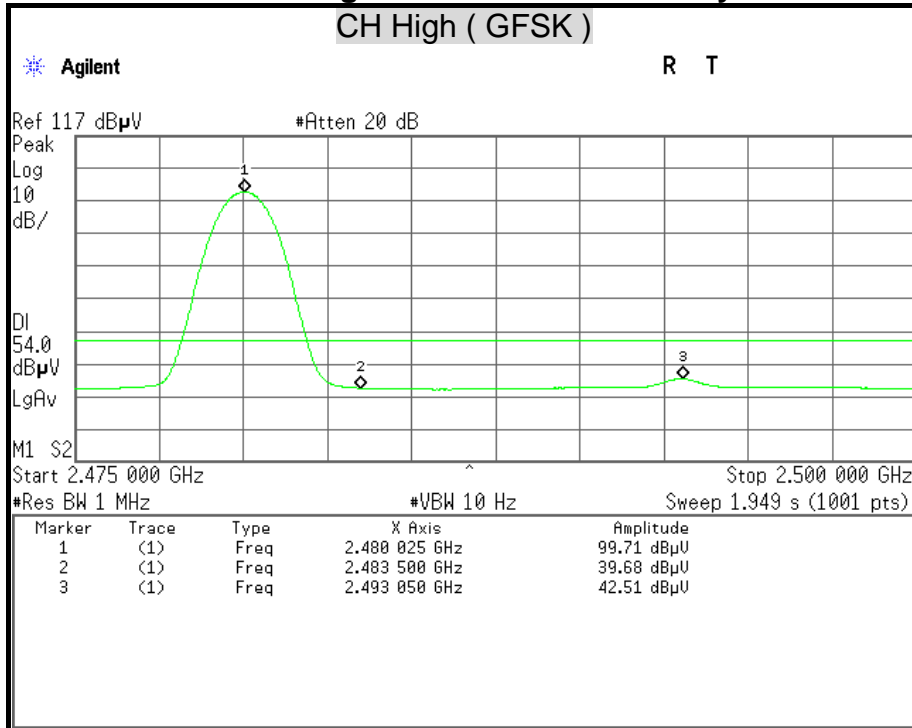



Detector Mode : Peak

Polarity : Vertical

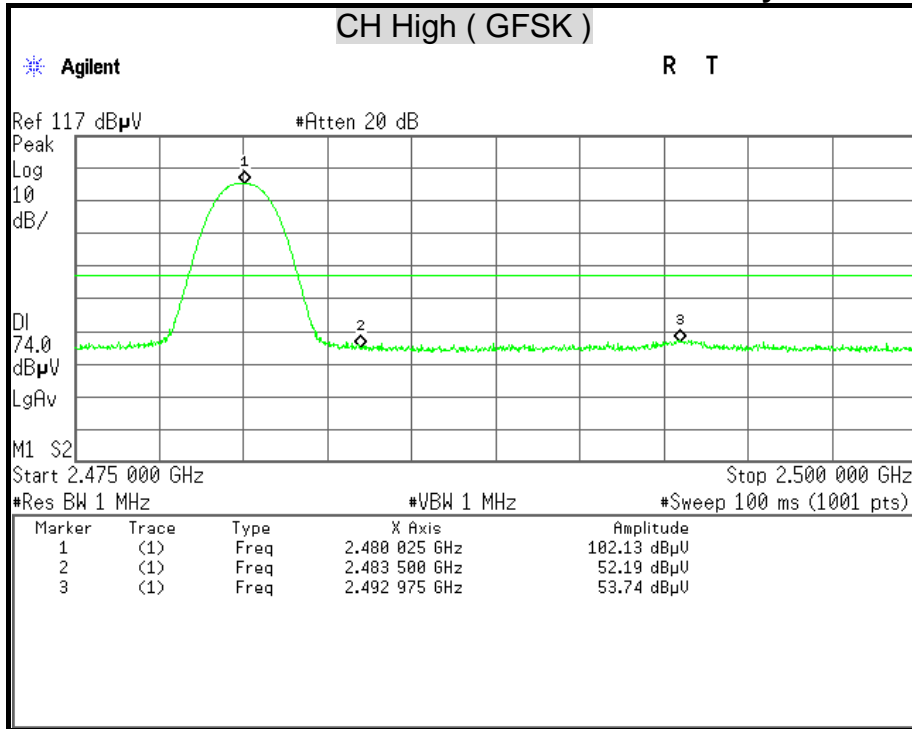

Detector Mode : Average

Polarity : Vertical

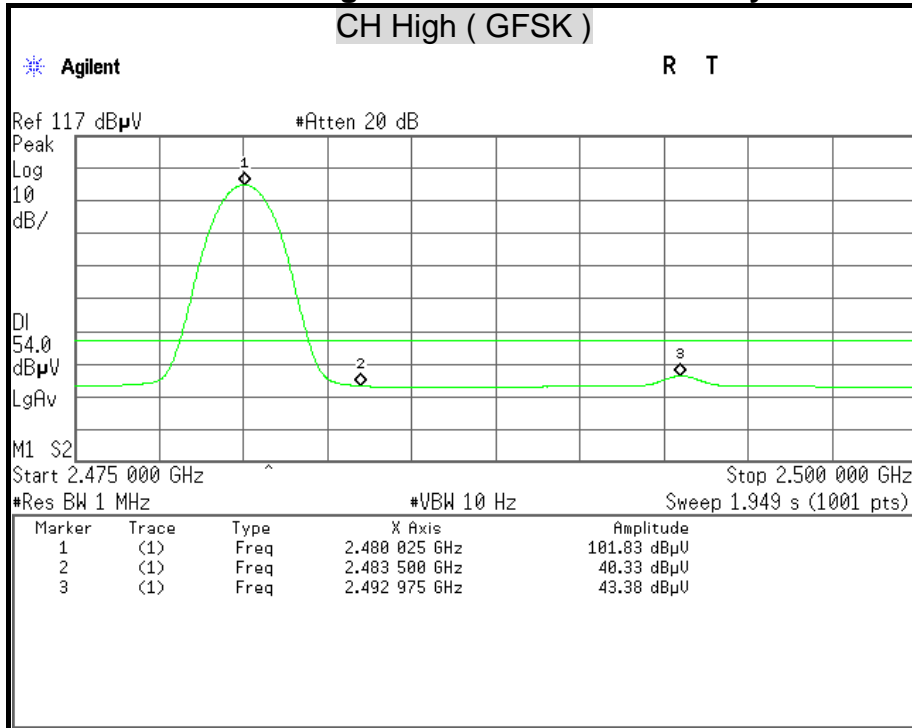



Detector Mode : Peak

Polarity : Horizontal

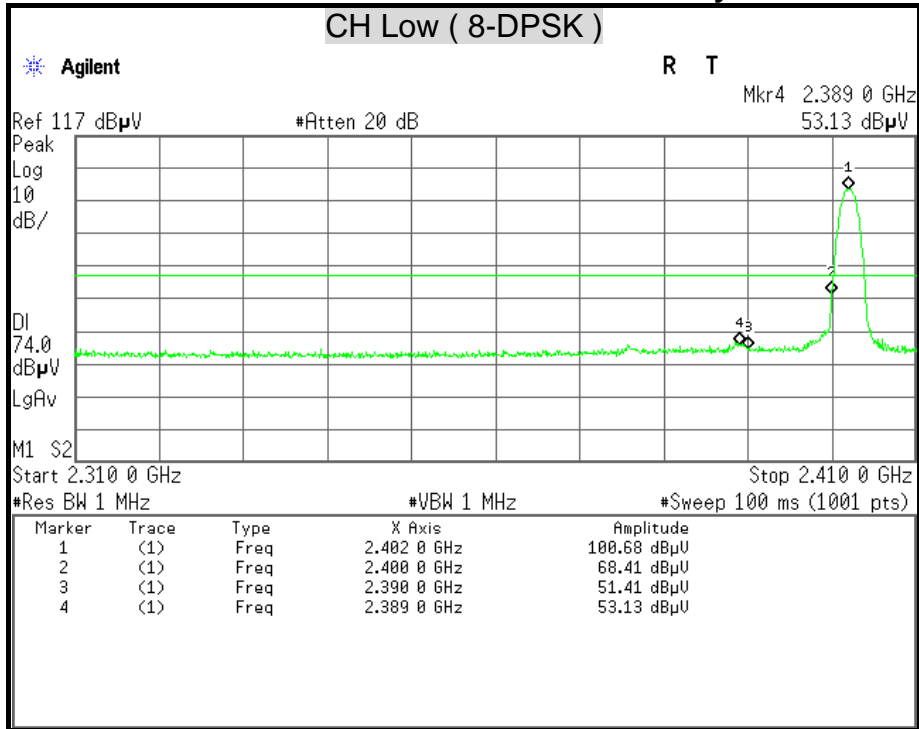

Detector Mode : Average

Polarity : Horizontal

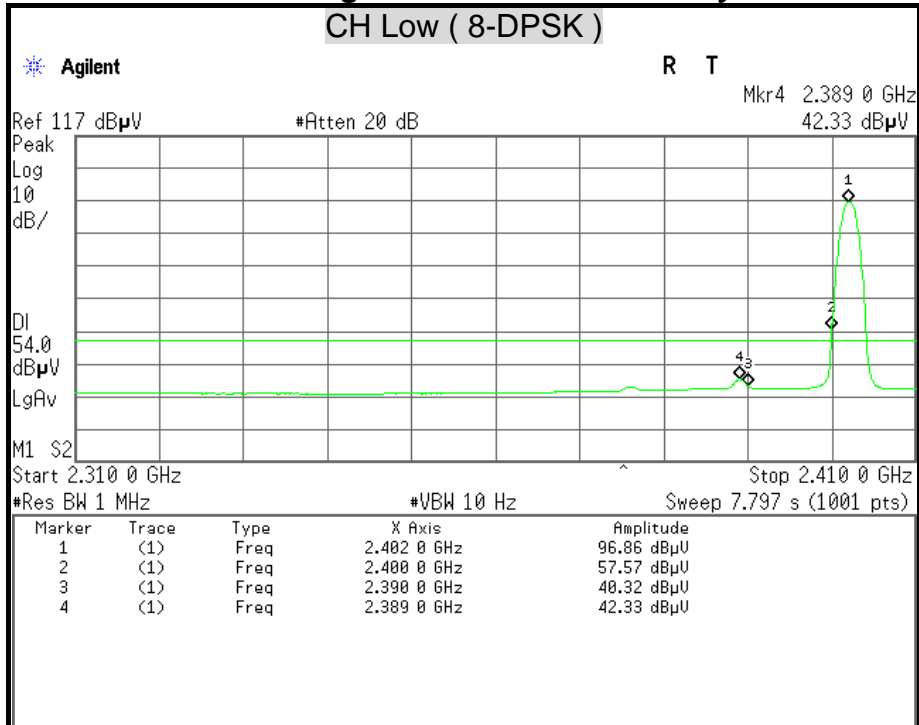



Detector Mode : Peak

Polarity : Vertical

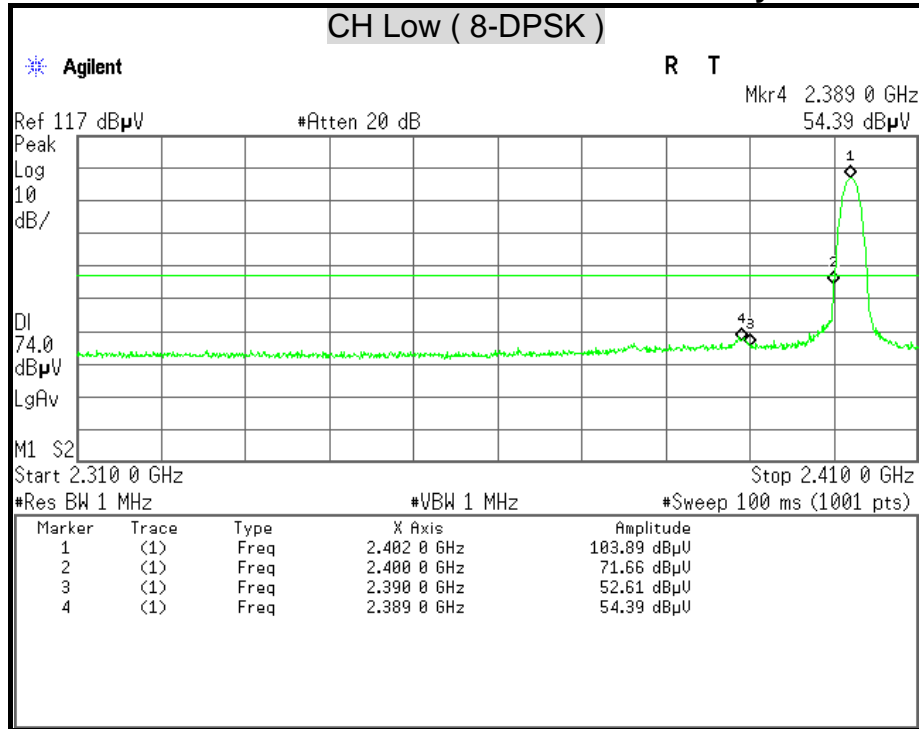

Detector Mode : Average

Polarity : Vertical

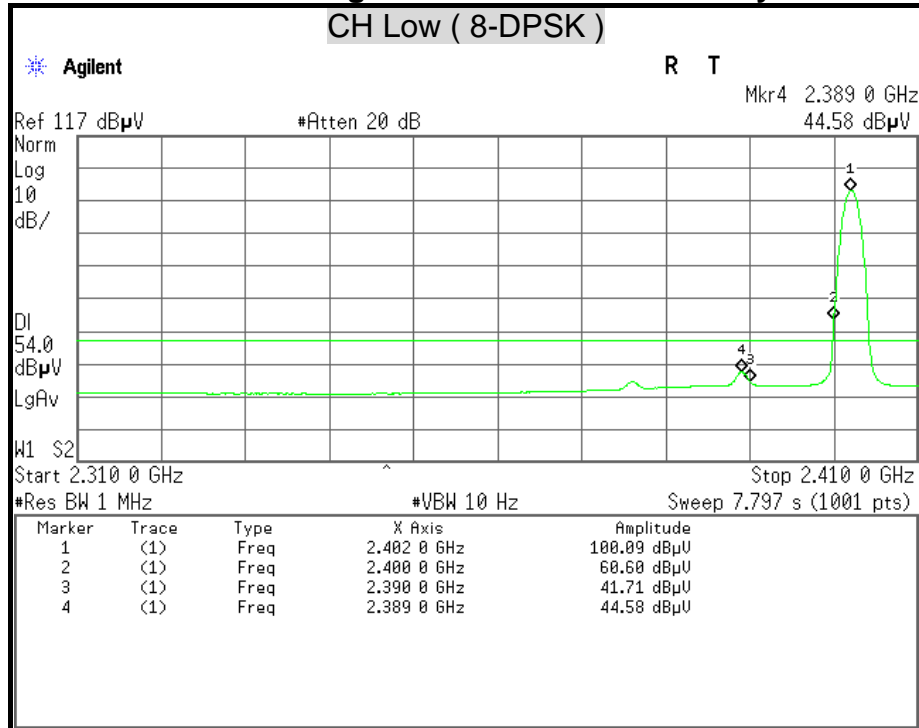



Detector Mode : Peak

Polarity : Horizontal

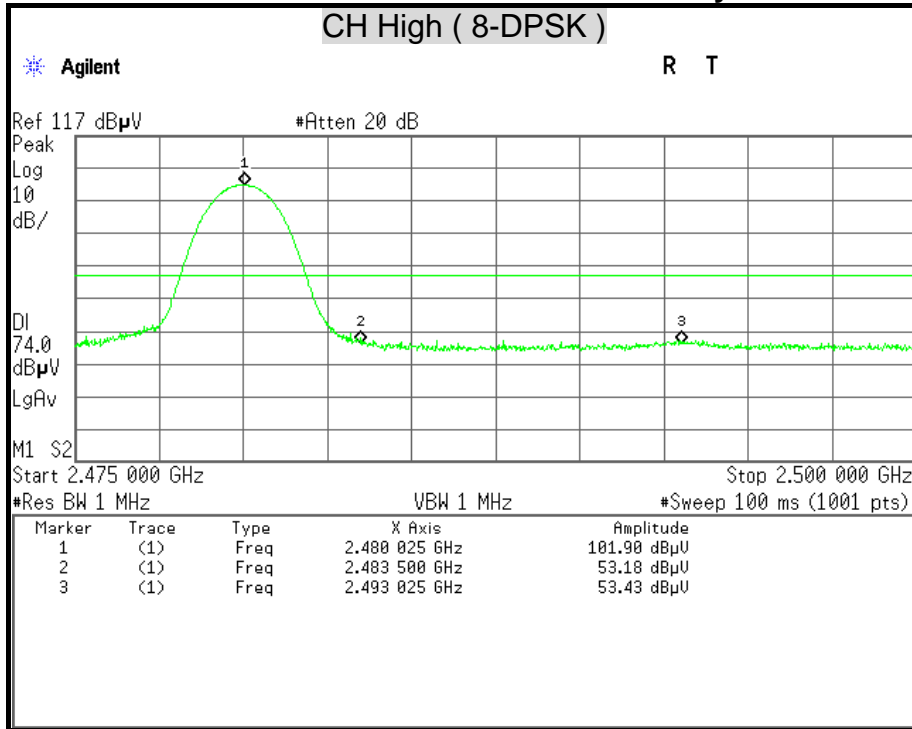

Detector Mode : Average

Polarity : Horizontal

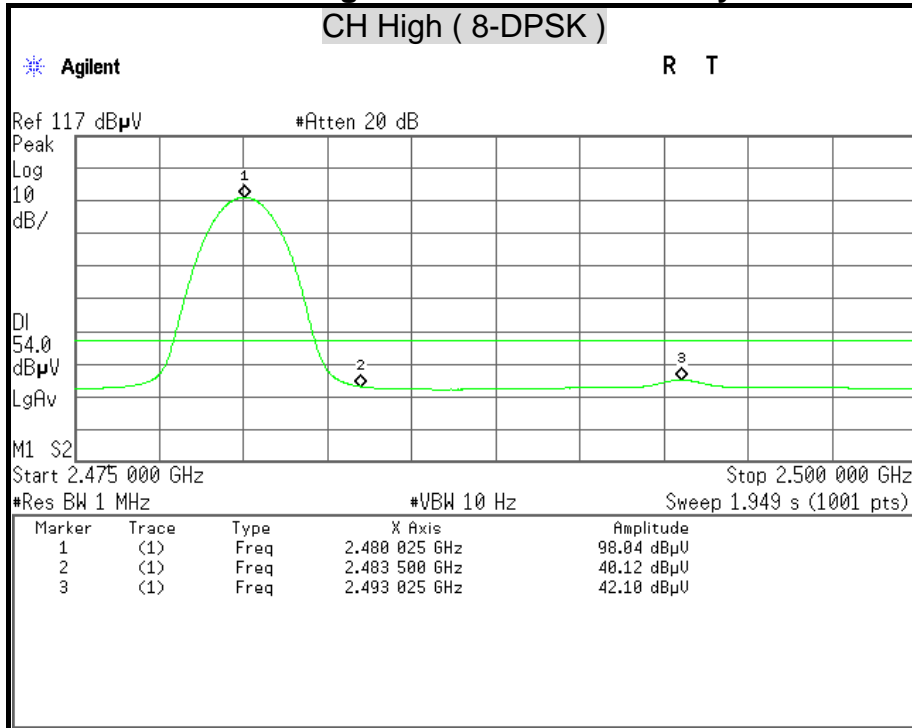



Detector Mode : Peak

Polarity : Vertical

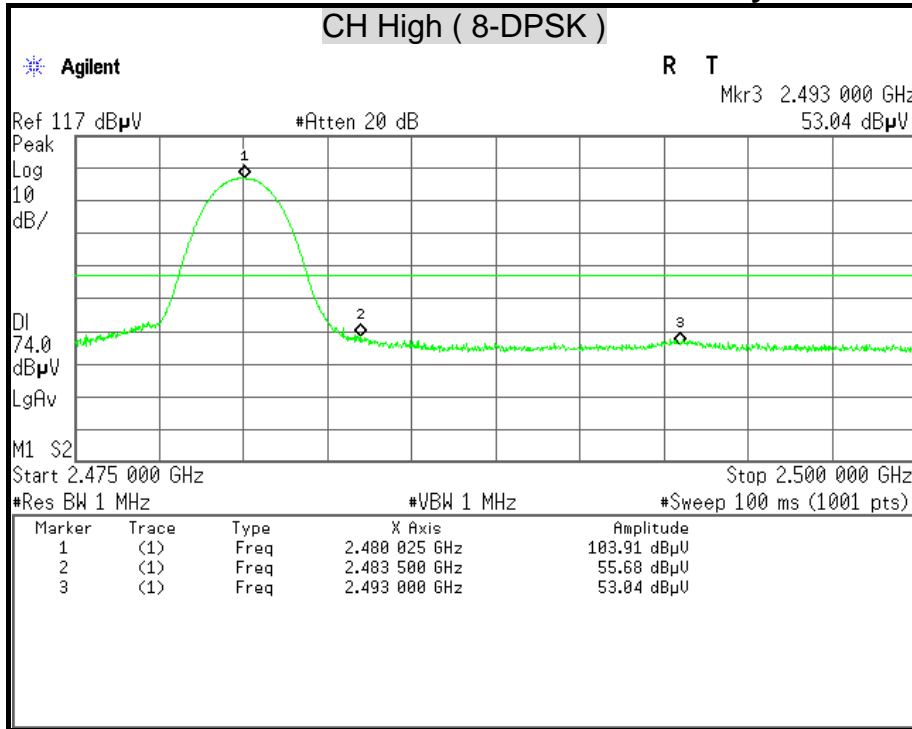

Detector Mode : Average

Polarity : Vertical

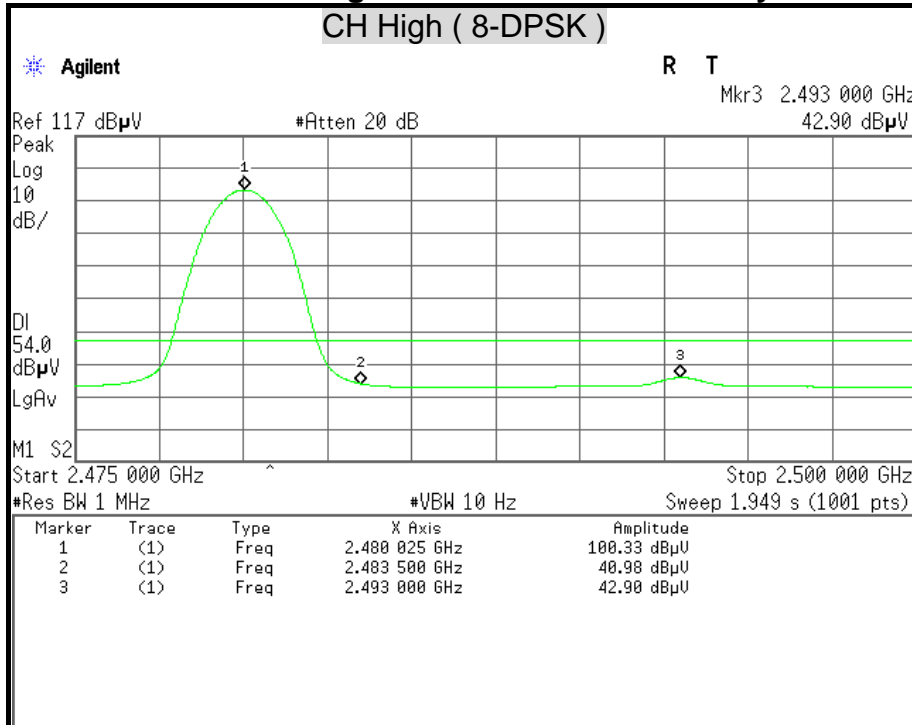



7.9 CONDUCTED EMISSION

LIMITS

§ 15.207 (a) Except as shown in paragraph (b) and (c) this section, for an intentional radiator that is designed to be connected to the public utility (AC) power line, the radio frequency voltage that is conducted back onto the AC power line on any frequency or frequencies within the band 150 kHz to 30 MHz shall not exceed the limits in the following table, as measured using a 50 μ H/50 ohms line impedance stabilization network (LISN). Compliance with the provisions of this paragraph shall be based on the measurement of the radio frequency voltage between each power line and ground at the power terminal. The lower limit applies at the boundary between the frequency ranges.

Frequency Range (MHz)	Conducted Limit (dB μ v)	
	Quasi-peak	Average
0.15 - 0.50	66 to 56	56 to 46
0.50 - 5.00	56	46
5.00 - 30.0	60	50

TEST EQUIPMENT

Name of Equipment	Manufacturer	Model	Serial Number	Calibration Due
L.I.S.N	SCHWARZBECK	NSLK 8127	8127-465	08/09/2012
L.I.S.N	SCHWARZBECK	NSLK 8127	8127-473	03/14/2012
EMI Receiver	ROHDE & SCHWARZ	ESCS 30	835418/008	10/20/2012
Pulse Limit	ROHDE & SCHWARZ	ESH3-Z2	100117	09/14/2012

Remark: Each piece of equipment is scheduled for calibration once a year.



TEST SETUP

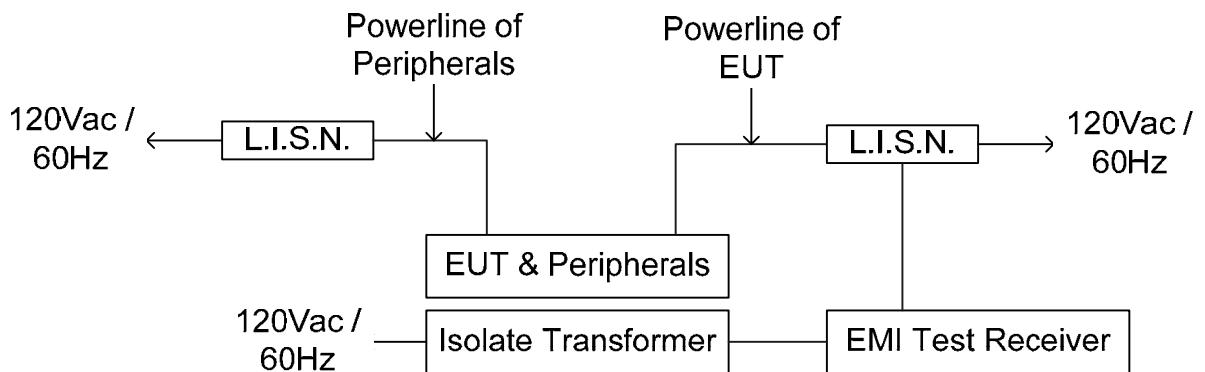
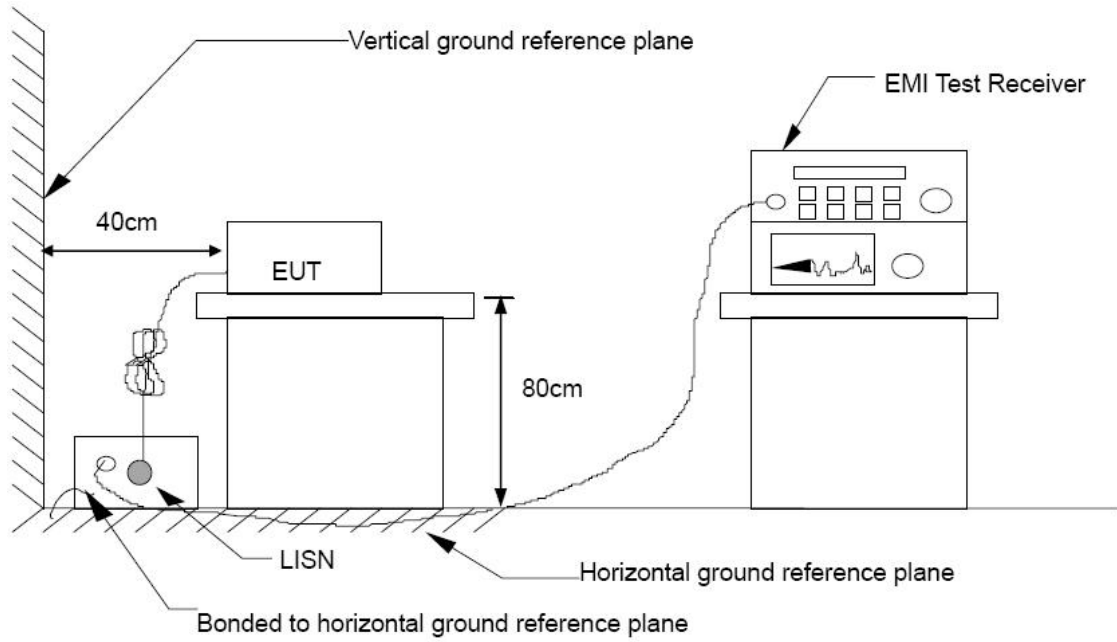



TEST PROCEDURE

The test procedure is performed in a 4m x 3m x 2.4m (LxWxH) shielded room.

The EUT along with its peripherals were placed on a 1.0m (W) x 1.5m (L) and 0.8m in height wooden table and the EUT was adjusted to maintain a 0.4 meter space from a vertical reference plane.

The EUT was connected to power mains through a line impedance stabilization network (LISN) which provides 50 ohm coupling impedance for measuring instrument and the chassis ground was bounded to the horizontal ground plane of shielded room. All peripherals were connected to the second LISN and the chassis ground also bounded to the horizontal ground plane of shielded room.

The EUT was located so that the distance between the boundary of the EUT and the closest surface of the LISN is 0.8 m. Where a mains flexible cord was provided by the manufacturer shall be 1 m long, or if in excess of 1 m, the excess cable was folded back and forth as far as possible so as to form a bundle not exceeding 0.4 m in length.

TEST RESULTS

Since the BT won't work at charge mode, this is test item is not applicable.