



FCC RF Test Report

APPLICANT : Motorola, Inc.
EQUIPMENT : T225
BRAND NAME : Motorola
MODEL NAME : SJYN0312A
FCC ID : IHDT6MM1
STANDARD : FCC Part 15 Subpart C §15.247
CLASSIFICATION : Digital Spread Spectrum (DSS)

The product was received on Dec. 03, 2010 and completely tested on Dec. 30, 2010. We, SPORTON INTERNATIONAL INC., would like to declare that the tested sample has been evaluated in accordance with the procedures given in ANSI C63.4-2003 and shown the compliance with the applicable technical standards.

The test results in this report apply exclusively to the tested model / sample. Without written approval of SPORTON INTERNATIONAL INC., the test report shall not be reproduced except in full.

Reviewed by:

Anderson Chiu

Anderson Chiu / Deputy Manager



SPORTON INTERNATIONAL INC.

No. 52, Hwa Ya 1st Rd., Hwa Ya Technology Park, Kwei-Shan Hsiang, Tao Yuan Hsien, Taiwan, R.O.C.

SPORTON INTERNATIONAL INC.

TEL : 886-3-327-3456

FAX : 886-3-328-4978

FCC ID : IHDT6MM1

Page Number : 1 of 65

Report Issued Date : Jan. 07, 2011

Report Version : Rev. 01



TABLE OF CONTENTS

REVISION HISTORY 3

SUMMARY OF TEST RESULT 4

1 GENERAL DESCRIPTION..... 5

 1.1 Applicant 5

 1.2 Manufacturer..... 5

 1.3 Feature of Equipment Under Test 5

 1.4 Testing Site 6

 1.5 Applied Standards 6

 1.6 Ancillary Equipment List 6

2 TEST CONFIGURATION OF EQUIPMENT UNDER TEST..... 7

 2.1 RF Output Power 7

 2.2 Test Mode..... 8

 2.3 Connection Diagram of Test System..... 9

 2.4 RF Utility 9

3 TEST RESULT 10

 3.1 Number of Channel Measurement 10

 3.2 20dB and 99% Bandwidth Measurement 13

 3.3 Hopping Channel Separation Measurement 26

 3.4 Dwell Time Measurement..... 29

 3.5 Peak Output Power Measurement 31

 3.6 Band Edges Measurement 34

 3.7 Spurious Emission Measurement..... 45

 3.8 AC Conducted Emission Measurement..... 49

 3.9 Radiated Emission Measurement..... 53

 3.10 Antenna Requirements 62

4 LIST OF MEASURING EQUIPMENT..... 63

5 UNCERTAINTY OF EVALUATION..... 64

APPENDIX A. PHOTOGRAPHS OF EUT

APPENDIX B. SETUP PHOTOGRAPHS



REVISION HISTORY

REPORT NO.	VERSION	DESCRIPTION	ISSUED DATE
FR0D0334	Rev. 01	Initial issue of report	Jan. 07, 2011

**SUMMARY OF TEST RESULT**

Report Section	FCC Rule	IC Rule	Description	Limit	Result	Remark
3.1	15.247(a)(1)	A8.4(2)	Number of Channels	≥ 15Chs	Pass	-
3.2	15.247(a)(1)	A8.1(a)	20dB Bandwidth	NA	Pass	-
3.2	-	Gen 4.4.1	99% Bandwidth	-	Pass	-
3.3	15.247(a)(1)	A8.1(b)	Channel Separation	≥ 2/3 of 20dB BW	Pass	-
3.4	15.247(a)(1)	A8.1(d)	Dwell Time of Each Channel	≤ 0.4sec in 31.6sec period	Pass	-
3.5	15.247(b)(1)	A8.1(b)	Peak Output Power	≤ 1W	Pass	-
3.6	15.247(d)	A8.5	Frequency Band Edges	≤ 20dBc	Pass	-
3.7	15.247(d)	A8.5	Spurious Emission	< 20 dBc	Pass	-
3.8	15.207	Gen 7.2.2	AC Conducted Emission	15.207(a)	Pass	Under limit 21.5 dB at 4.158 MHz
3.9	15.247(d)	A8.5	Transmitter Radiated Emission	15.209(a) & 15.247(d)	Pass	Under limit 3.5 dB at 2483.5 MHz
3.10	15.203 & 15.247(b)	A8.4	Antenna Requirement	N/A	Pass	-



1 General Description

1.1 Applicant

Motorola, Inc.

600 N. U.S. Highway 45, Libertyville, IL 60048-5343

1.2 Manufacturer

Merry Electronics (Shenzhen) CO., LTD.

No. 50, MeiBao Road, Dalang Street, BaoAn District, Shenzhen City, Guangdong Province, China

1.3 Feature of Equipment Under Test

Product Feature & Specification	
Equipment	T225
Brand Name	Motorola
Model Name	SJYN0312A
FCC ID	IHDT6MM1
Tx/Rx Frequency Range	2400 MHz ~ 2483.5 MHz
Number of Channels	79
Carrier Frequency of Each Channel	2402+n*1 MHz; n=0~78
Channel Spacing	1 MHz
Maximum Output Power to Antenna	Bluetooth (1Mbps) : 3.47 dBm (0.0022 W) Bluetooth EDR (2Mbps) : 5.31 dBm (0.0034 W) Bluetooth EDR (3Mbps) : 5.67 dBm (0.0037 W)
Antenna Type	PCB Antenna with gain -2 dBi
HW Version	5
SW Version	20101125
Type of Modulation	Bluetooth (1Mbps) : GFSK Bluetooth EDR (2Mbps) : π /4-DQPSK Bluetooth EDR (3Mbps) : 8-DPSK
EUT Stage	Production Unit

Remark:

1. This test report recorded only product characteristics and test results of Digital Spread Spectrum (DSS).
2. The above EUT's information was declared by manufacturer. Please refer to the specifications or user's manual for more detailed description.



1.4 Testing Site

Test Site	SPORTON INTERNATIONAL INC.		
Test Site Location	No. 52, Hwa Ya 1 st Rd., Hwa Ya Technology Park, Kwei-Shan Hsiang, Tao Yuan Hsien, Taiwan, R.O.C. TEL: +886-3-3273456 / FAX: +886-3-3284978		
Test Site No.	Sporton Site No.		FCC/IC Registration No.
	CO05-HY	03CH07-HY	722060/4086B-1

1.5 Applied Standards

According to the specifications of the manufacturer, the EUT must comply with the requirements of the following standards:

- ♦ FCC Part 15 Subpart C §15.247
- ♦ FCC Public Notice DA 00-705
- ♦ ANSI C63.4-2003
- ♦ IC RSS-210 Issue 8

Remark:

1. All test items were verified and recorded according to the standards and without any deviation during the test.
2. This EUT has also been tested and complied with the requirements of FCC Part 15, Subpart B (DoC), recorded in a separate test report.

1.6 Ancillary Equipment List

Item	Equipment	Trade Name	Model Name	FCC ID	Data Cable	Power Cord
1.	System Simulator	R&S	CMU 200	N/A	N/A	Unshielded, 1.8 m
2.	Bluetooth Base Station	R&S	CBT32	N/A	N/A	Unshielded, 1.8 m
3.	Car Battery	YUASA	46B24R(S)	N/A	N/A	N/A
4.	Mobile Phone	Motorola	81130CHEPA	1HDP56KC5	N/A	N/A

2 Test Configuration of Equipment Under Test

2.1 RF Output Power

Preliminary tests were performed in different data rate and recorded the RF output power in the following table:

Channel	Frequency	Bluetooth RF Output Power		
		Data Rate / Modulation		
		GFSK	π /4-DQPSK	8-DPSK
		1Mbps	2Mbps	3Mbps
Ch00	2402MHz	3.11 dBm	5.20 dBm	5.61 dBm
Ch39	2441MHz	3.46 dBm	5.31 dBm	5.67 dBm
Ch78	2480MHz	3.47 dBm	5.20 dBm	5.49 dBm

Remark:

1. The data rate was set in 3Mbps for all the test items due to the highest RF output power.
2. The EUT is programmed to transmit signals continuously for all testing.

2.2 Test Mode

The EUT has been associated with peripherals pursuant to ANSI C63.4-2003 and configuration operated in a manner tended to maximize its emission characteristics in a typical application. Frequency range investigated: conduction (150 kHz to 30 MHz), radiation (9 kHz to the 10th harmonic of the highest fundamental frequency or to 40 GHz, whichever is lower).

Pre-scanned tests were conducted to determine the final configuration from all possible combinations.

The following tables are showing the test modes as the worst cases and recorded in this report.

Test Cases			
Test Item	Data Rate / Modulation		
	Bluetooth 1Mbps GFSK	Bluetooth EDR 2Mbps π /4-DQPSK	Bluetooth EDR 3Mbps 8-DPSK
Conducted TCs	Mode 1: CH00_2402 MHz Mode 2: CH39_2441 MHz Mode 3: CH78_2480 MHz	Mode 4: CH00_2402 MHz Mode 5: CH39_2441 MHz Mode 6: CH78_2480 MHz	Mode 7: CH00_2402 MHz Mode 8: CH39_2441 MHz Mode 9: CH78_2480 MHz
Radiated TCs	N/A	N/A	Mode 1: CH00_2402 MHz Mode 2: CH39_2441 MHz Mode 3: CH78_2480 MHz
AC Conducted Emission	Mode 1 :Bluetooth Link + Car Charger (DC 12V)		
Remark: For radiated the data rate was set in 3Mbps due to the highest RF output power; only the data of these modes was reported.			

2.3 Connection Diagram of Test System

<Conduction>

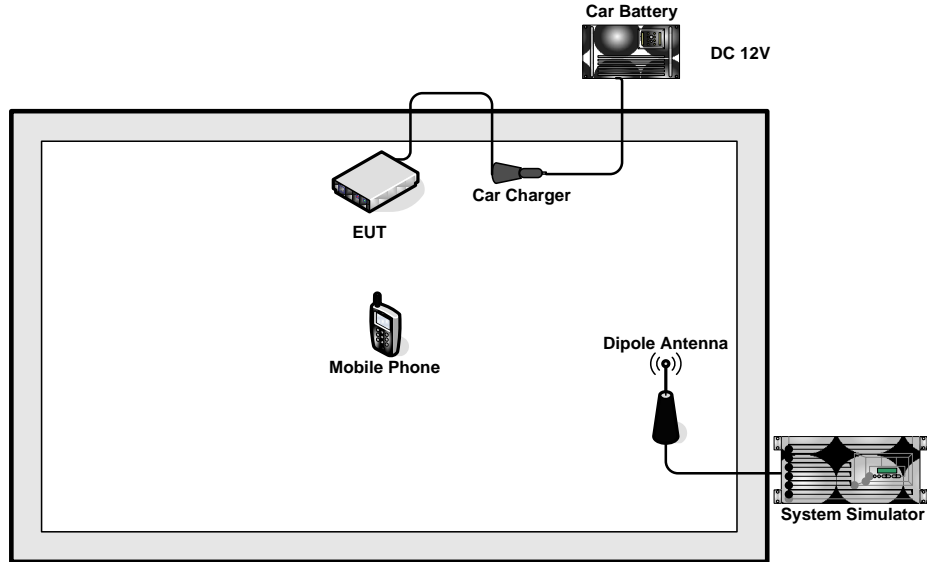

<Radiation>

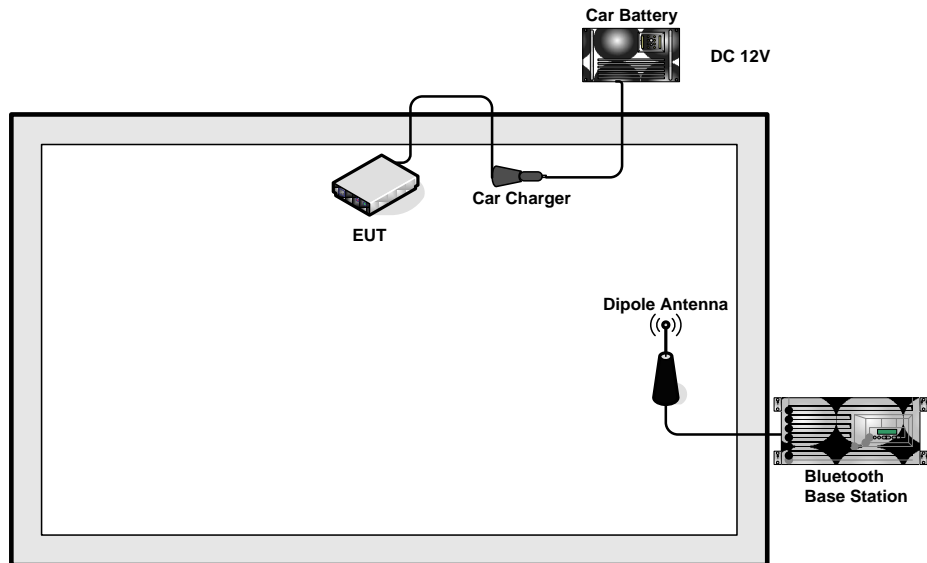

2.4 RF Utility

For Bluetooth function, the EUT was into the engineering modes to contact with Bluetooth base station for transmitting and receiving signals continuously.

3 Test Result

3.1 Number of Channel Measurement

3.1.1 Limits of Number of Hopping Frequency

Frequency hopping systems in the 2400-2483.5 MHz band shall use at least 15 channels.

3.1.2 Measuring Instruments

See list of measuring instruments of this test report.

3.1.3 Test Procedure

1. The testing follows FCC Public Notice DA 00-705 Measurement Guidelines.
2. The RF output of EUT was connected to the spectrum analyzer by a low loss cable.
3. The modulation types of EUT are irrelevant to number of hopping channels deviation.
4. The EUT must have its hopping function enabled. Use the following spectrum analyzer settings:
Span = the frequency band of operation; $RBW \geq 1\%$ of the span; $VBW \geq RBW$; Sweep = auto;
Detector function = peak; Trace = max hold.
5. The number of hopping frequency used is defined as the device has the numbers of total channel.

3.1.4 Test Setup

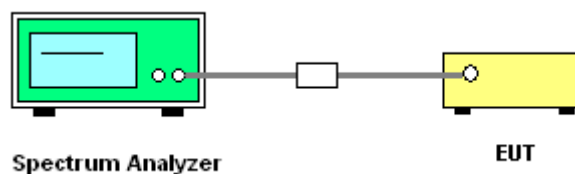



3.1.5 Test Result of Number of Hopping Frequency

Test Mode :	Mode 7~9	Temperature :	25~27°C
Test Engineer :	Hank Yu	Relative Humidity :	46~50%
Number of Hopping Channels (Channel)	Limits (Channel)	Pass/Fail	
79	> 15	Pass	



Number of Hopping Channel Plot on Channel 00 - 78

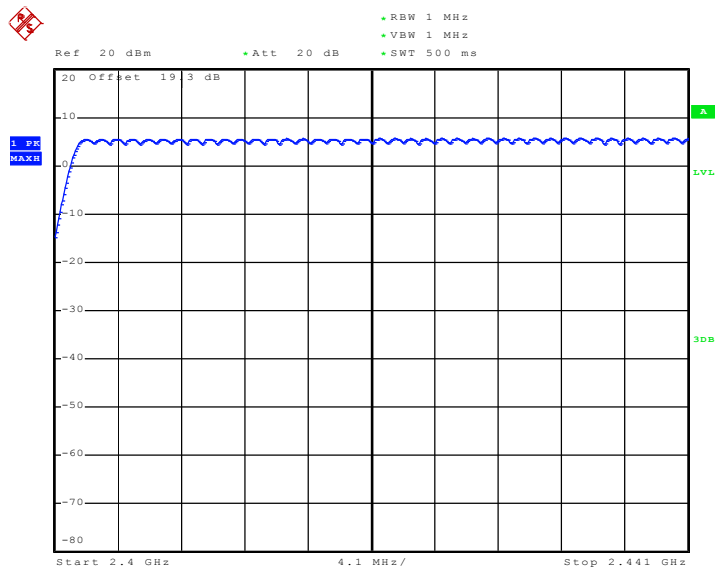

Date: 9.DEC.2010 19:10:10

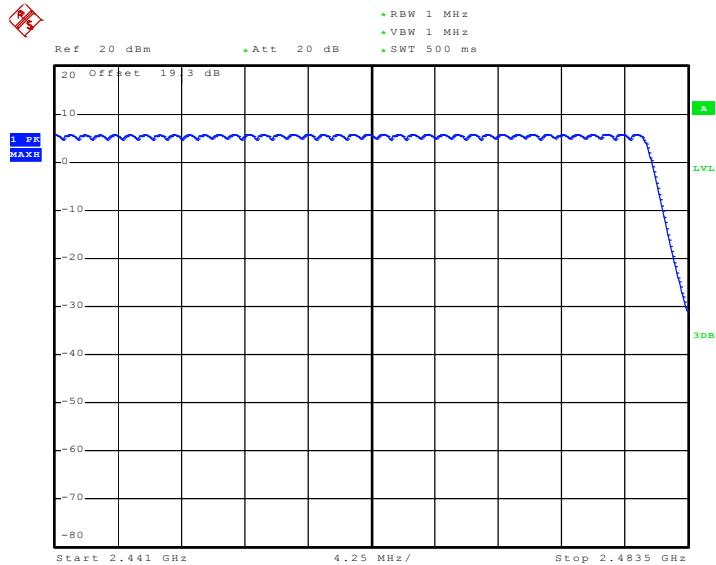

Date: 9.DEC.2010 19:31:51

3.2 20dB and 99% Bandwidth Measurement

3.2.1 Limit of 20dB Bandwidth

N/A

3.2.2 Measuring Instruments

See list of measuring instruments of this test report.

3.2.3 Test Procedures

1. The testing follows FCC Public Notice DA 00-705 Measurement Guidelines.
2. The RF output of EUT was connected to the spectrum analyzer by a low loss cable.
3. The EUT should be transmitting at its maximum data rate as the worst cases.
4. Use the following spectrum analyzer settings:
Span = approximately 2 to 3 times the 20 dB bandwidth, centered on a hopping channel;
RBW \geq 1% of the 20 dB bandwidth; VBW \geq RBW; Sweep = auto; Detector function = peak;
Trace = max hold.
5. The marker-delta reading at this point is the 20 dB bandwidth of the emission.

3.2.4 Test Setup

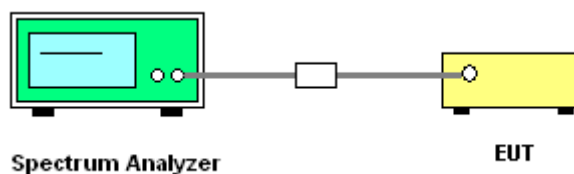



3.2.5 Test Result of 20dB Bandwidth

Test Mode :	Mode 1, 2, 3	Temperature :	25~27°C
Test Engineer :	Hank Yu	Relative Humidity :	46~50%

Channel	Frequency (MHz)	20dB Bandwidth (MHz)
00	2402	0.900
39	2441	0.900
78	2480	0.900

20 dB Bandwidth Plot on Channel 00

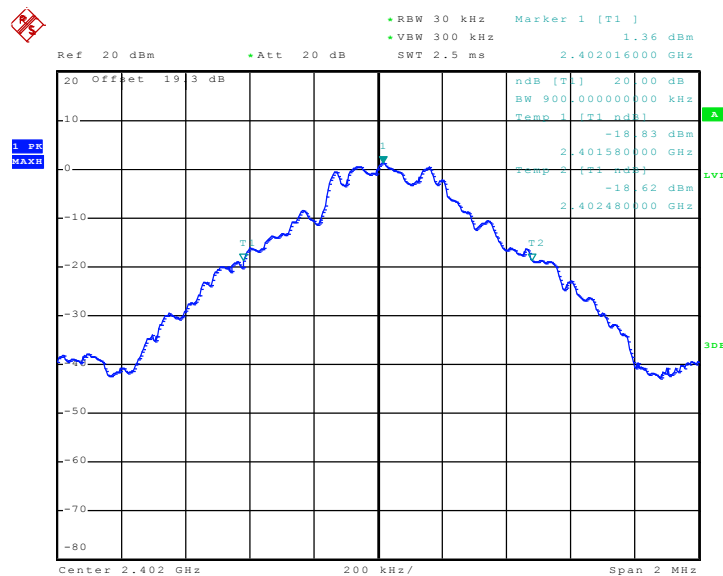

Date: 9.DEC.2010 18:43:25



20 dB Bandwidth Plot on Channel 39

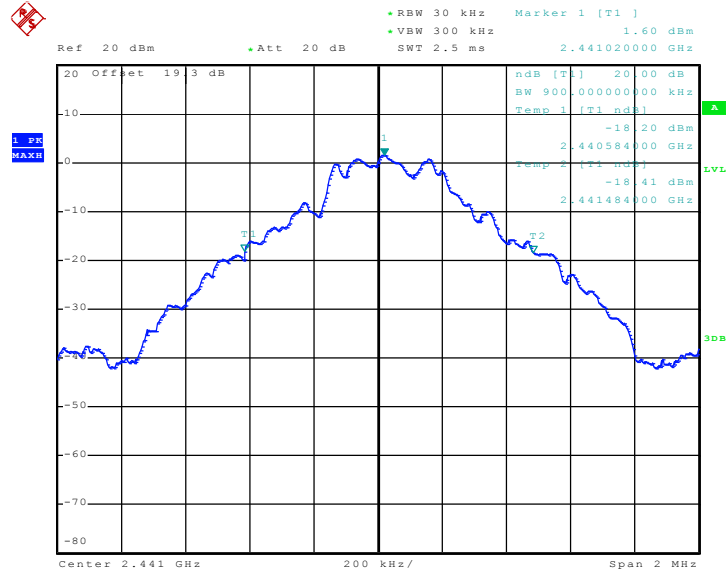

Date: 9.DEC.2010 18:49:03

20 dB Bandwidth Plot on Channel 78

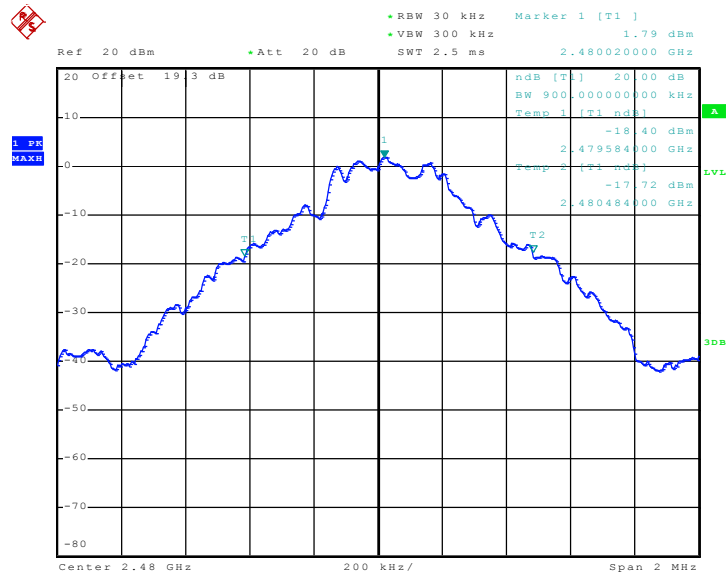

Date: 9.DEC.2010 18:30:18



Test Mode :	Mode 4, 5, 6	Temperature :	25~27°C
Test Engineer :	Hank Yu	Relative Humidity :	46~50%

Channel	Frequency (MHz)	20dB Bandwidth (MHz)
00	2402	1.332
39	2441	1.332
78	2480	1.332

20 dB Bandwidth Plot on Channel 00

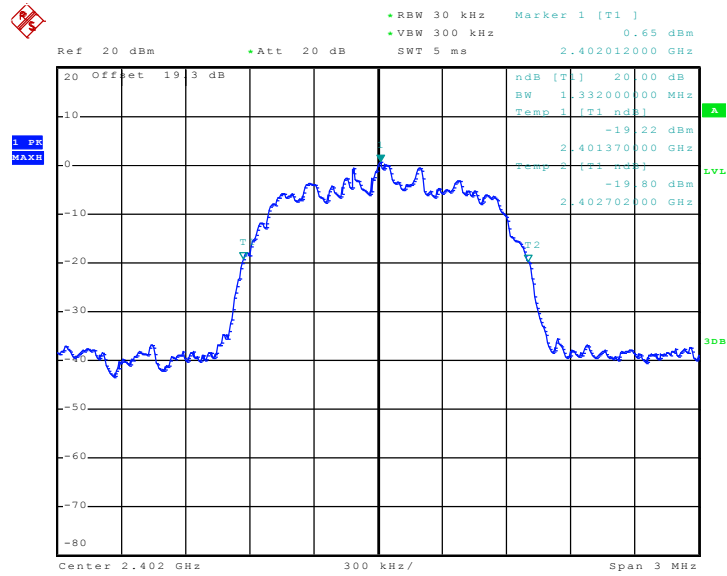

Date: 9.DEC.2010 19:19:51



20 dB Bandwidth Plot on Channel 39

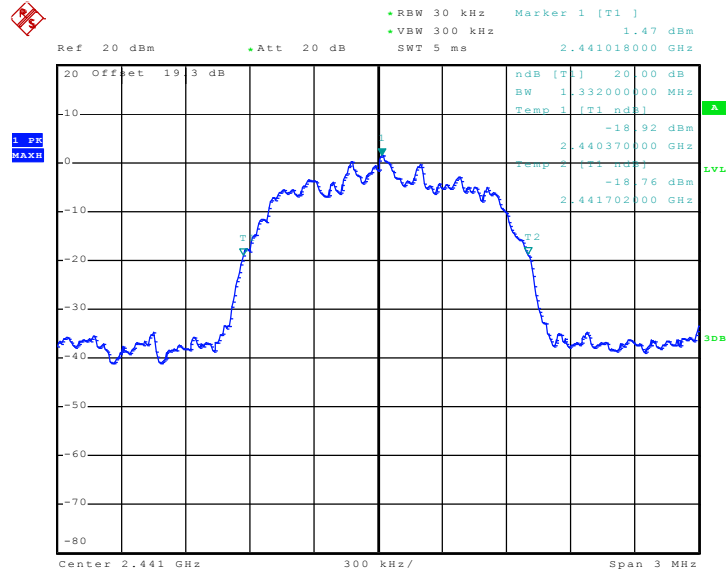

Date: 9.DEC.2010 18:58:35

20 dB Bandwidth Plot on Channel 78

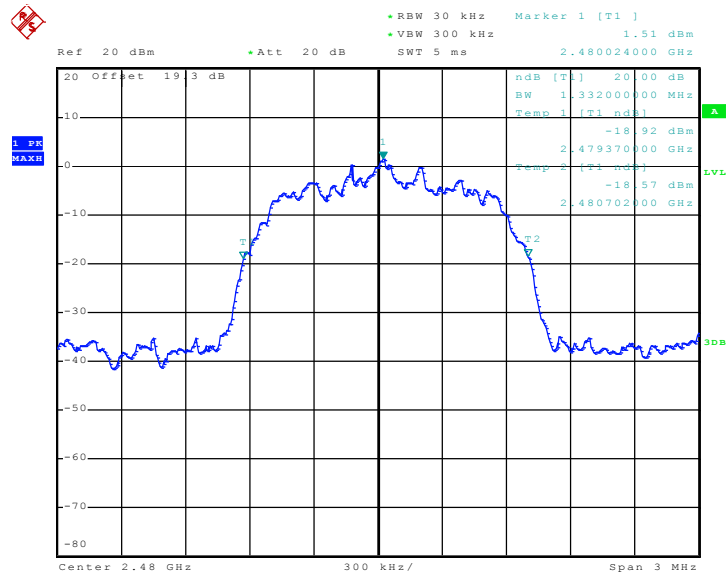

Date: 9.DEC.2010 18:26:28



Test Mode :	Mode 7, 8, 9	Temperature :	25~27°C
Test Engineer :	Hank Yu	Relative Humidity :	46~50%

Channel	Frequency (MHz)	20dB Bandwidth (MHz)
00	2402	1.320
39	2441	1.314
78	2480	1.320

20 dB Bandwidth Plot on Channel 00

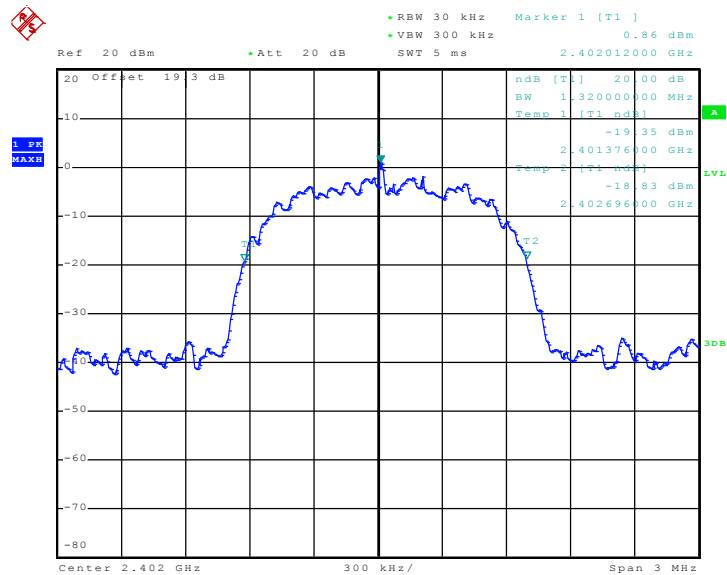

Date: 9.DEC.2010 19:23:24



20 dB Bandwidth Plot on Channel 39

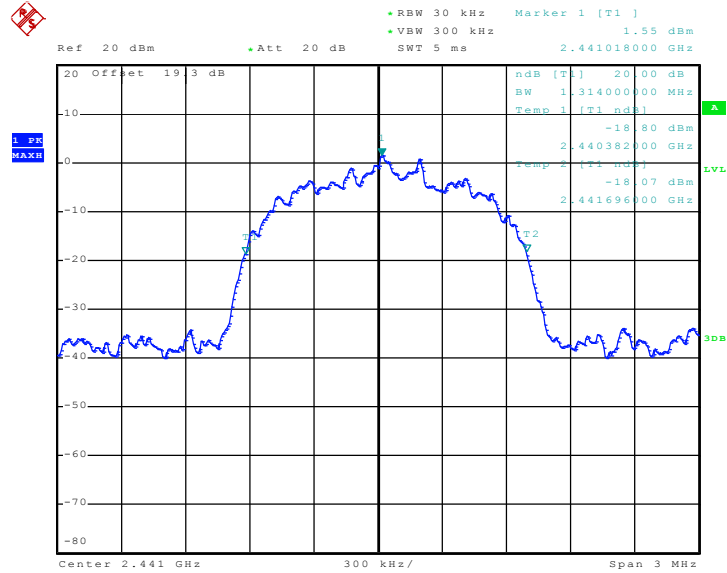

Date: 9.DEC.2010 19:04:12

20 dB Bandwidth Plot on Channel 78

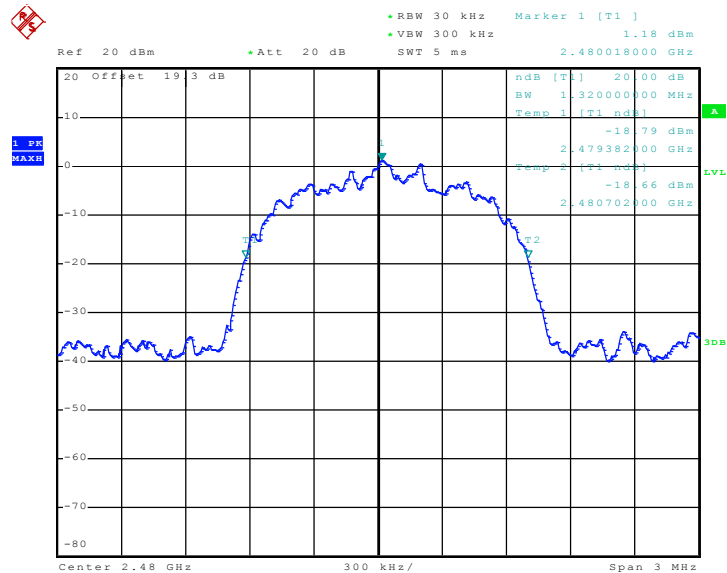

Date: 9.DEC.2010 18:22:38



3.2.6 Test Result of 99% Occupied Bandwidth

Test Mode :	Mode 1, 2, 3	Temperature :	25~27°C
Test Engineer :	Hank Yu	Relative Humidity :	46~50%

Channel	Frequency (MHz)	99% Occupied Bandwidth (MHz)
00	2402	0.872
39	2441	0.868
78	2480	0.864

99% Bandwidth Plot on Channel 00

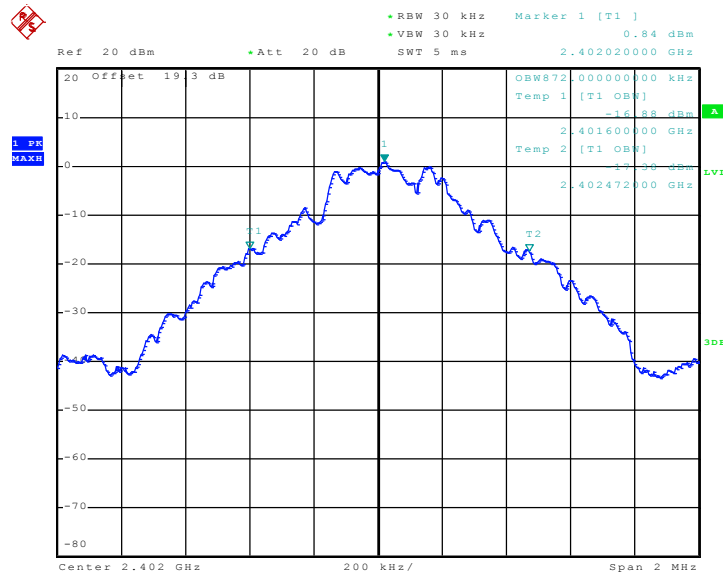

Date: 9.DEC.2010 18:47:24



99% Occupied Bandwidth Plot on Channel 39

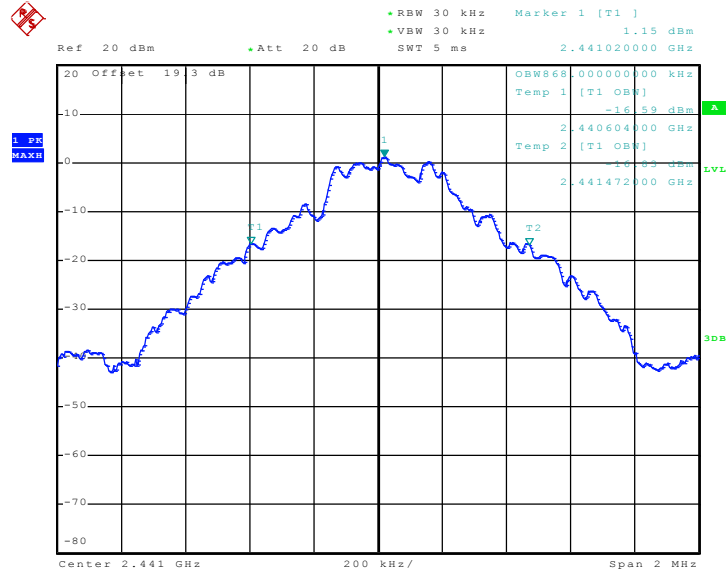

Date: 9.DEC.2010 18:48:28

99% Occupied Bandwidth Plot on Channel 78

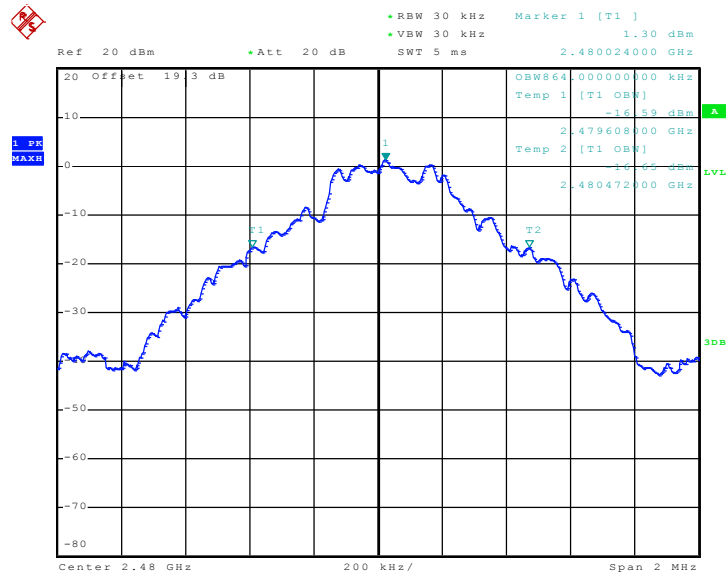

Date: 9.DEC.2010 18:29:45



Test Mode :	Mode 4, 5, 6	Temperature :	25~27°C
Test Engineer :	Hank Yu	Relative Humidity :	46~50%

Channel	Frequency (MHz)	99% Occupied Bandwidth (MHz)
00	2402	1.184
39	2441	1.184
78	2480	1.184

99% Bandwidth Plot on Channel 00

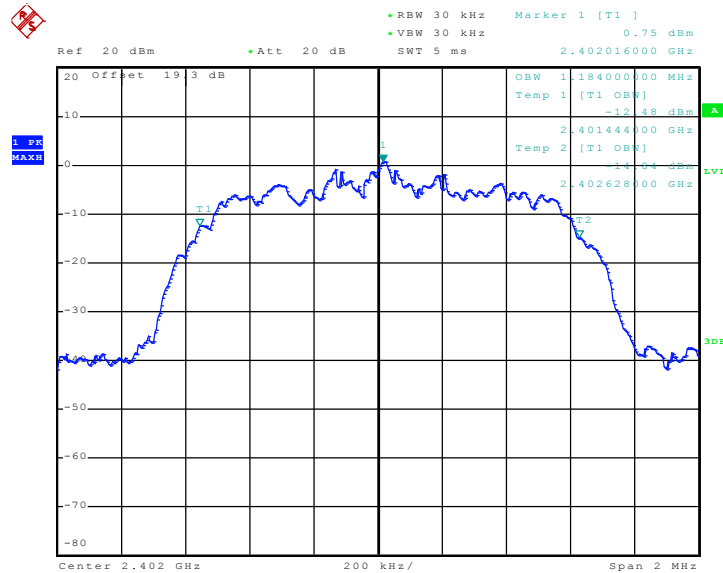

Date: 9.DEC.2010 19:17:46



99% Occupied Bandwidth Plot on Channel 39

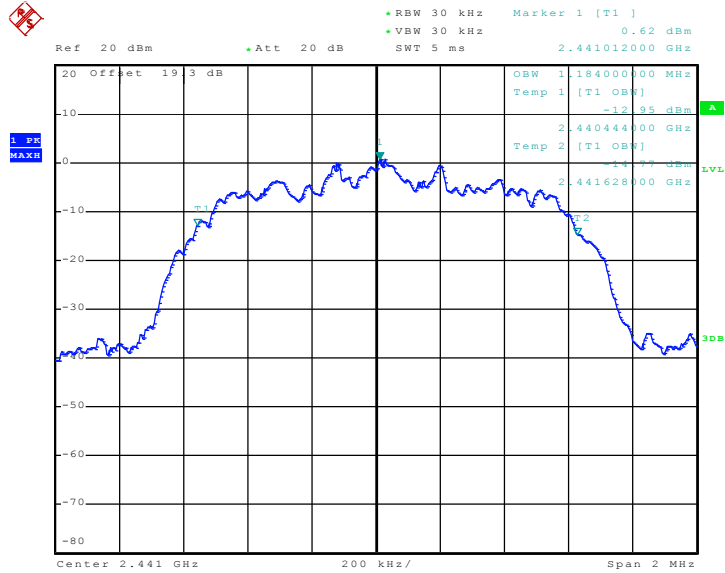

Date: 9.DEC.2010 18:59:28

99% Occupied Bandwidth Plot on Channel 78

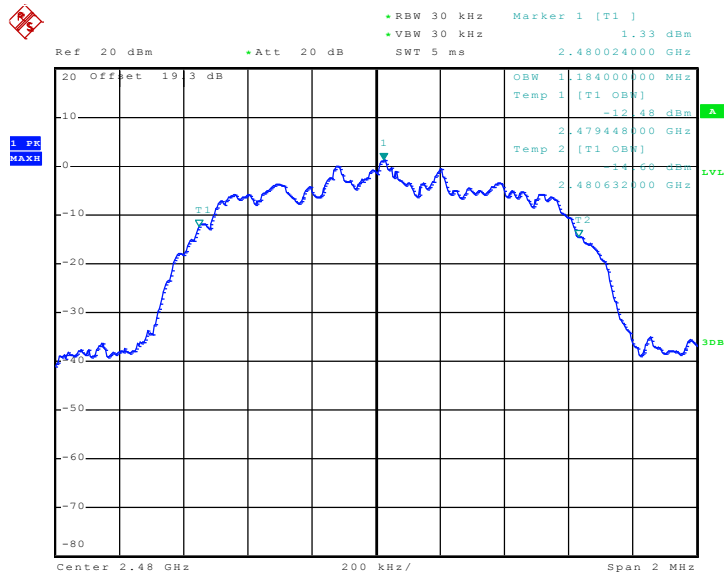

Date: 9.DEC.2010 18:26:11



Test Mode :	Mode 7, 8, 9	Temperature :	25~27°C
Test Engineer :	Hank Yu	Relative Humidity :	46~50%

Channel	Frequency (MHz)	99% Occupied Bandwidth (MHz)
00	2402	1.192
39	2441	1.192
78	2480	1.192

99% Bandwidth Plot on Channel 00

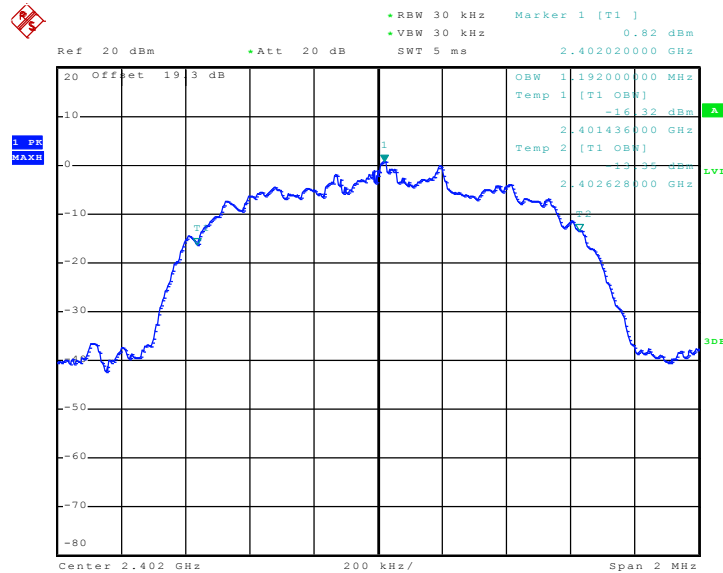

Date: 9.DEC.2010 18:33:13



99% Occupied Bandwidth Plot on Channel 39

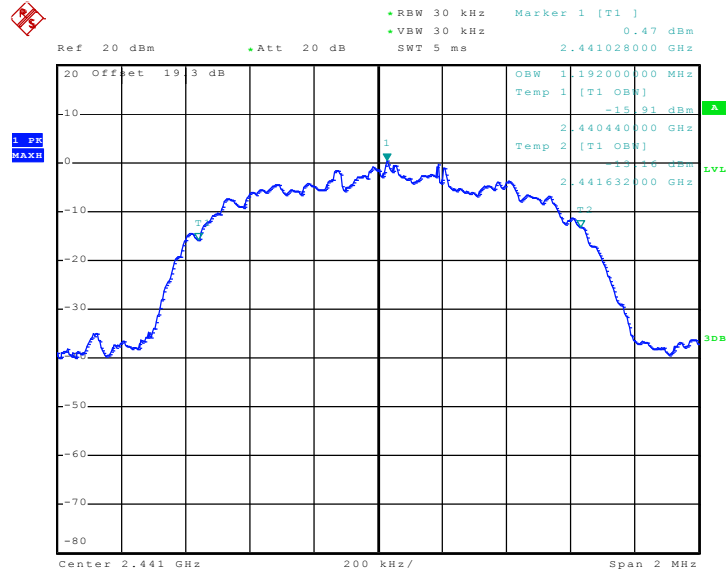

Date: 9.DEC.2010 19:02:37

99% Occupied Bandwidth Plot on Channel 78

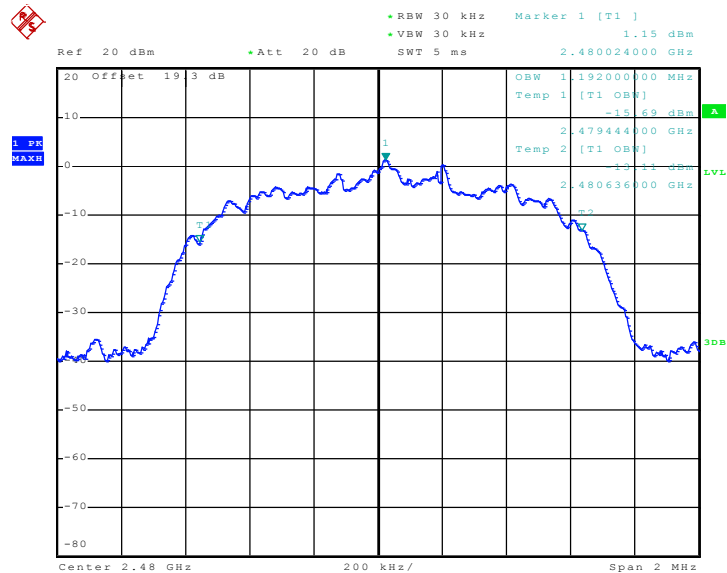

Date: 9.DEC.2010 18:22:53

3.3 Hopping Channel Separation Measurement

3.3.1 Limit of Hopping Channel Separation

Frequency hopping systems operating in the 2400-2483.5 MHz band may have hopping channel carrier frequencies that are separated by 25 kHz or two-thirds of the 20 dB bandwidth of the hopping channel, whichever is greater.

3.3.2 Measuring Instruments

See list of measuring instruments of this test report.

3.3.3 Test Procedures

1. Please refer FCC Public Notice DA 00-705 Measurement Guidelines.
2. The RF output of EUT was connected to the spectrum analyzer by a low loss cable.
3. The EUT should be transmitting at its maximum data rate as the worst cases.
4. Use the following spectrum analyzer settings:
Span = wide enough to capture the peaks of two adjacent channels; $RBW \geq 1\%$ of the span;
VBW \geq RBW; Sweep = auto; Detector function = peak; Trace = max hold.
5. Use the marker-delta function to determine the separation between the peaks of the adjacent channels.

3.3.4 Test Setup

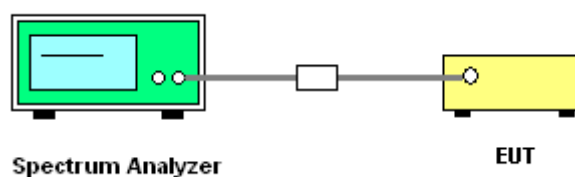



3.3.5 Test Result of Hopping Channel Separation

Test Mode :	Mode 7, 8, 9	Temperature :	25~27°C
Test Engineer :	Hank Yu	Relative Humidity :	46~50%

Channel	Frequency (MHz)	Frequency Separation (MHz)	(2/3 of 20dB BW) Limits (MHz)	Pass/Fail
00	2402	1.002	0.880	Pass
39	2441	1.002	0.876	Pass
78	2480	1.002	0.880	Pass

Channel Separation Plot on Channel 00 - 01

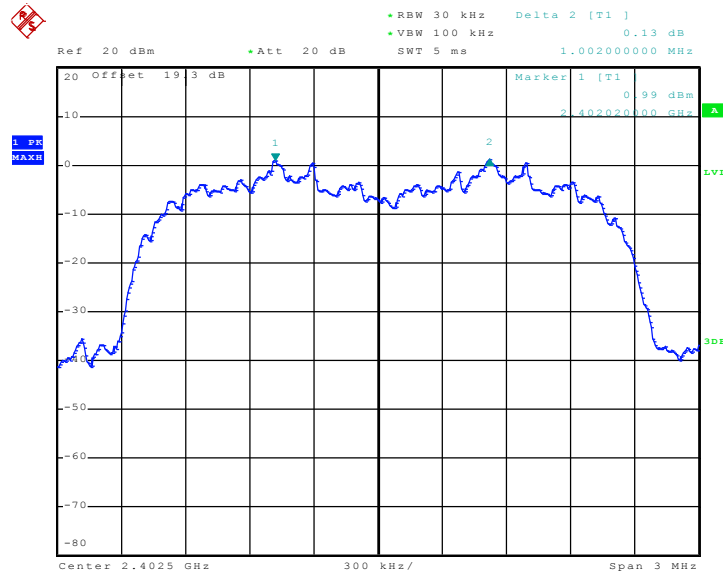

Date: 9.DEC.2010 18:34:33



Channel Separation Plot on Channel 39 - 40

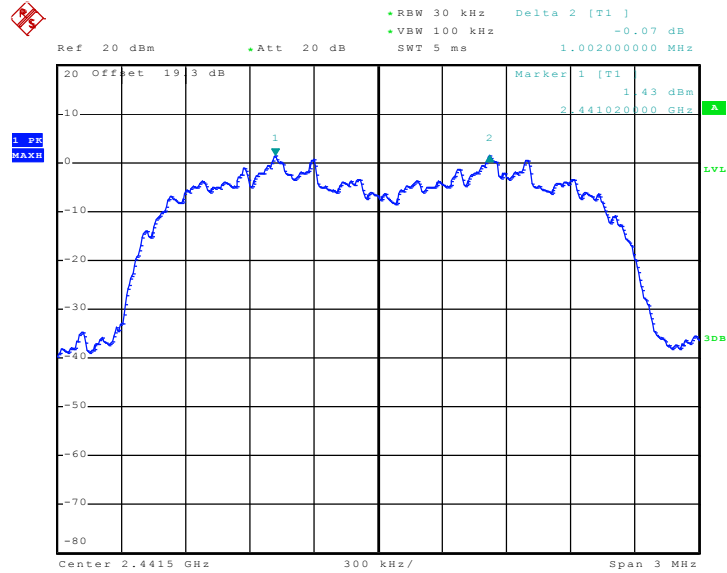

Date: 9.DEC.2010 19:03:59

Channel Separation Plot on Channel 77 - 78

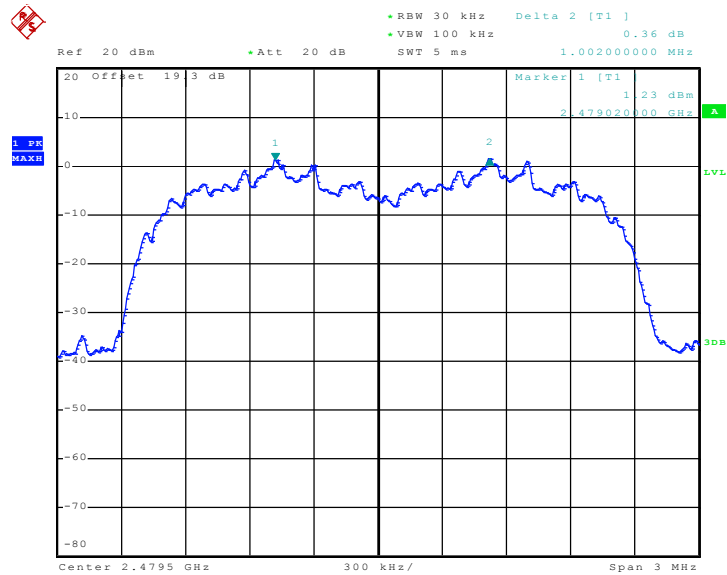

Date: 9.DEC.2010 18:25:01

3.4 Dwell Time Measurement

3.4.1 Limit of Dwell Time

The average time of occupancy on any channel shall not be greater than 0.4 seconds within a period of 0.4 seconds multiplied by the number of hopping channels employed.

3.4.2 Measuring Instruments

See list of measuring instruments of this test report.

3.4.3 Test Procedures

1. The testing follows FCC Public Notice DA 00-705 Measurement Guidelines.
2. The RF output of EUT was connected to the spectrum analyzer by a low loss cable.
3. The EUT should be transmitting at its maximum data rate as the worst cases.
4. The EUT must have its hopping function enabled. Use the following spectrum analyzer settings:
Span = zero span, centered on a hopping channel; RBW = 1 MHz; VBW ≥ RBW; Sweep = as necessary to capture the entire dwell time per hopping channel; Detector function = peak; Trace = max hold.
5. Use the marker-delta function to calculate the dwell time.

3.4.4 Test Setup

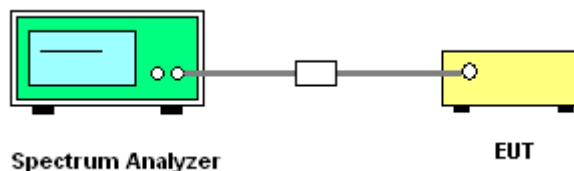

3.4.5 Test Result of Dwell Time

Test Mode :	Mode 8	Temperature :	25~27°C		
Test Engineer :	Hank Yu	Relative Humidity :	46~50%		
Package Mode	Average Hopping Channel	Package Transfer Time (usec)	Dwell Time (sec)	Limits (sec)	Pass/Fail
3DH5	3.10	3000.00	0.29	< 0.4s	Pass

Remark:

1. Dwell Time=79(channels) x 0.4(s) x average hopping channel x package transfer time
2. 79 channels come from the Hopping Channel number.
3. Average Hopping Channel = hops/sweep time
4. t: Package Transfer Time(us)



3DH5 Dwell Time (One Pulse) Plot on Channel 39

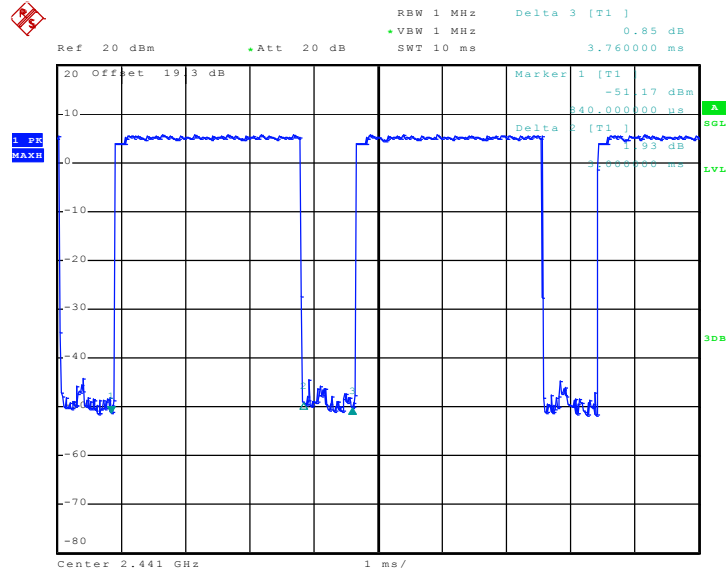

Date: 9.DEC.2010 19:05:18

3DH5 Dwell Time (Count Pulses) Plot on Channel 39

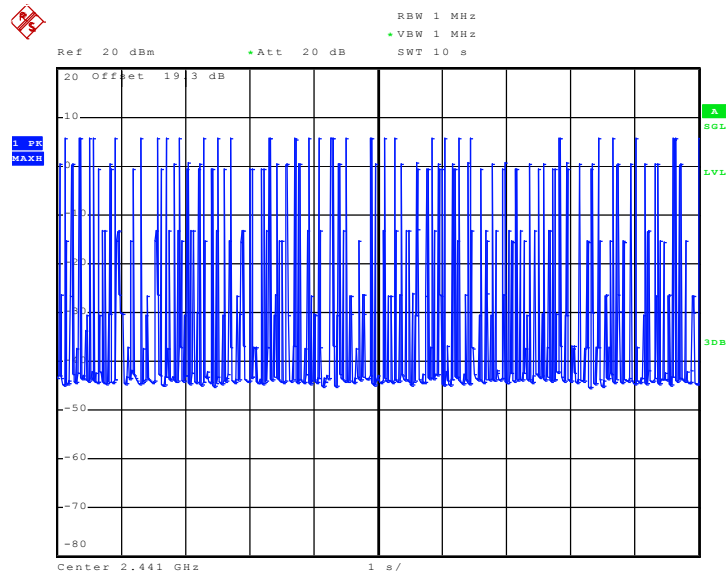

Date: 9.DEC.2010 19:04:50

3.5 Peak Output Power Measurement

3.5.1 Limit of Peak Output Power

Frequency hopping systems operating in the 2400-2483.5 MHz band employing at least 75 non-overlapping hopping channels: 1W (30 dBm).

3.5.2 Measuring Instruments

See list of measuring instruments of this test report.

3.5.3 Test Procedures

1. The testing follows FCC Public Notice DA 00-705 Measurement Guidelines.
2. The RF output of EUT was connected to the spectrum analyzer by a low loss cable.

3.5.4 Test Setup

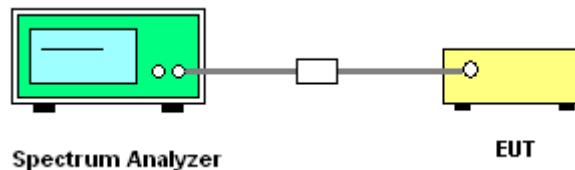

3.5.5 Test Result of Peak Output Power

Test Mode :	Mode 7, 8, 9	Temperature :	25~27°C
Test Engineer :	Hank Yu	Relative Humidity :	46~50%

Channel	Frequency (MHz)	RF Power (dBm)		
		8-DPSK	Max. Limits (dBm)	Pass/Fail
		3 Mbps		
00	2402	5.61	30	Pass
39	2441	5.67	30	Pass
78	2480	5.49	30	Pass



Peak Output Power Plot on Channel 00

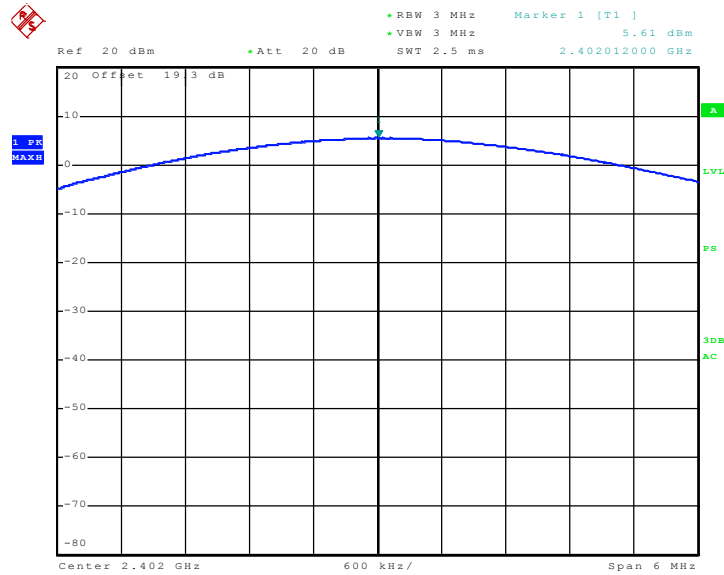

Date: 30.DEC.2010 10:14:28

Peak Output Power Plot on Channel 39

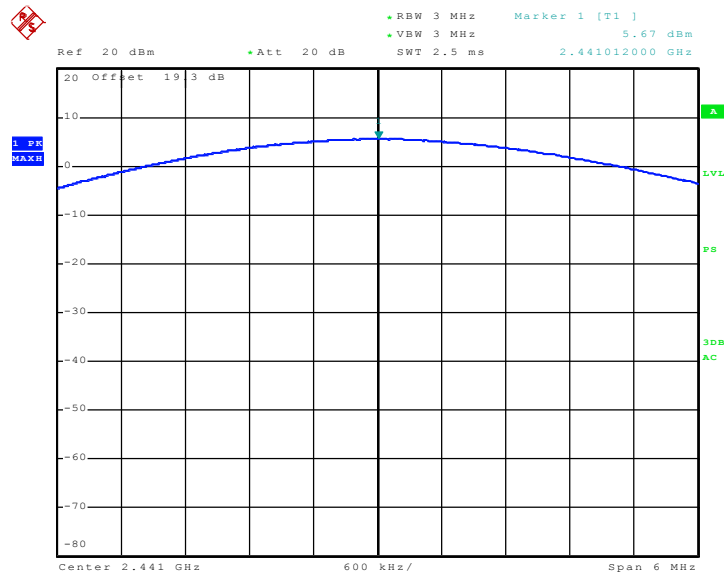

Date: 30.DEC.2010 10:11:36



Peak Output Power Plot on Channel 78

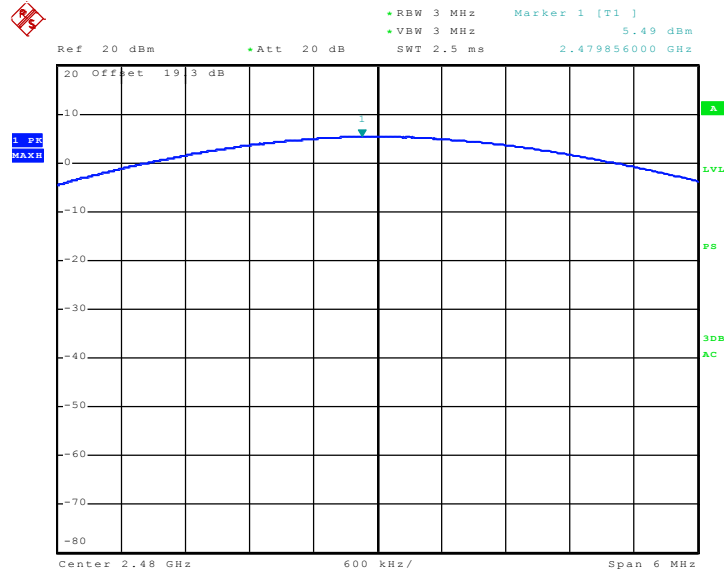

Date: 30.DEC.2010 10:15:37



3.6 Band Edges Measurement

3.6.1 Limit of Band Edges

In any 100 kHz bandwidth outside the intentional radiation frequency band, the radio frequency power shall be at least 20 dB below the highest level of the radiated power. In addition, radiated emissions which fall in the restricted bands must also comply with the radiated emission limits.

3.6.2 Measuring Instruments

See list of measuring instruments of this test report.

3.6.3 Test Procedures

1. The testing follows the guidelines in ANSI C63.4-2003 and FCC Public Notice DA 00-705 Measurement Guidelines.
2. RF antenna conducted test: Set RBW = 300kHz, Video bandwidth (VBW) \geq RBW. Band edge emissions must be at least 20 dB down from the highest emission level within the authorized band as measured with a 300k Hz RBW. Note: If the device complies with the use of power option 2 the attenuation under this paragraph shall be 30 dB instead of 20 dB.
3. Radiated emission test: Applies to band edge emissions that fall in the restricted bands listed in FCC Section 15.205. The maximum permitted average field strength is listed in FCC Section 15.209. A pre-amp is necessary for this measurement. For measurements above 1 GHz, set RBW = 1MHz, VBW = 1MHz, Sweep: Auto for Peak; set RBW = 1MHz, VBW = 10 Hz, Sweep: Auto for Average. If the emission is pulsed, modify the unit for continuous operation; use the settings shown above, then correct the reading by subtracting the peak-average correction factor, derived from the appropriate duty cycle calculation. See FCC Section 15.35(b) and (c).
4. In case the emission is fail due to the used RBW / VBW is too wide, marker-delta method of FCC Public Notice DA 00-705 will be followed.

3.6.4 Test Setup

<Radiated Band Edges>

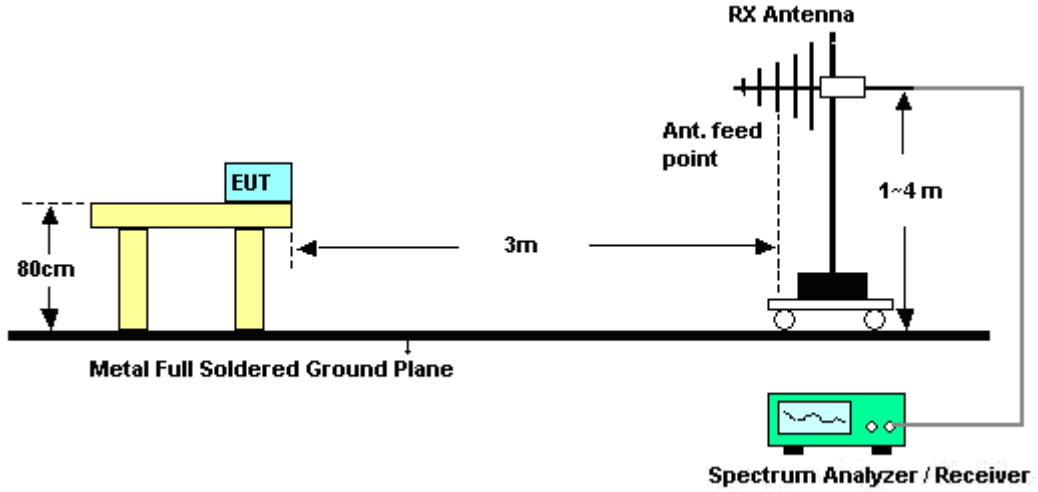

<Conducted Band Edges>

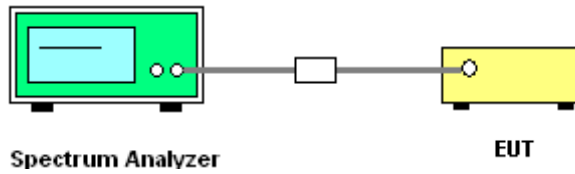



3.6.5 Test Result of Radiated Band Edges

Test Mode :	Mode 1	Temperature :	20~23°C
Test Channel :	00	Relative Humidity :	51~53%
		Test Engineer :	Wii Chang

ANTENNA POLARITY : HORIZONTAL										
Frequency (MHz)	Level (dBuV/m)	Over Limit (dB)	Limit Line (dBuV/m)	Read Level (dBuV)	Antenna Factor (dB)	Cable Loss (dB)	Preamp Factor (dB)	Ant Pos (cm)	Table Pos (deg)	Remark
2389.42	52.61	-21.39	74	48.25	32.18	6.03	33.85	102	232	Peak
2389.42	40.28	-13.72	54	35.92	32.18	6.03	33.85	102	232	Average

ANTENNA POLARITY : VERTICAL										
Frequency (MHz)	Level (dBuV/m)	Over Limit (dB)	Limit Line (dBuV/m)	Read Level (dBuV)	Antenna Factor (dB)	Cable Loss (dB)	Preamp Factor (dB)	Ant Pos (cm)	Table Pos (deg)	Remark
2389.42	47.68	-26.32	74	43.32	32.18	6.03	33.85	101	246	Peak
2389.42	34.98	-19.02	54	30.62	32.18	6.03	33.85	101	246	Average



Test Mode :	Mode 3	Temperature :	20~23°C
Test Channel :	78	Relative Humidity :	51~53%
		Test Engineer :	Wii Chang

ANTENNA POLARITY : HORIZONTAL										
Frequency (MHz)	Level (dBuV/m)	Over Limit (dB)	Limit Line (dBuV/m)	Read Level (dBuV)	Antenna Factor (dB)	Cable Loss (dB)	Preamp Factor (dB)	Ant Pos (cm)	Table Pos (deg)	Remark
2483.5	70.5	-3.5	74	65.94	32.28	6.18	33.9	100	231	Peak
2483.5	32.18	-21.82	54	27.62	32.28	6.18	33.9	100	231	Average

Summary results of marker-delta method:

Test mode	Maximum field strength of the fundamental emission (dBµV/m)	Delta Result (dB)	Average Result (dBµV/m)	Average Limit (dBµV/m)	Margin (dB)	Result
Single Carrier Mode	87.86	57.43	30.43	54	-23.57	Pass
Hopping Mode	87.86	55.68	32.18	54	-21.82	Pass

Note : Average result = Maximum field strength – Delta result

ANTENNA POLARITY : VERTICAL										
Frequency (MHz)	Level (dBuV/m)	Over Limit (dB)	Limit Line (dBuV/m)	Read Level (dBuV)	Antenna Factor (dB)	Cable Loss (dB)	Preamp Factor (dB)	Ant Pos (cm)	Table Pos (deg)	Remark
2483.5	64.1	-9.9	74	59.54	32.28	6.18	33.9	130	252	Peak
2483.5	29.08	-24.92	54	24.52	32.28	6.18	33.9	130	252	Average

Summary results of marker-delta method:

Test mode	Maximum field strength of the fundamental emission (dBµV/m)	Delta Result (dB)	Average Result (dBµV/m)	Average Limit (dBµV/m)	Margin (dB)	Result
Single Carrier Mode	82.58	54.73	27.85	54	-26.15	Pass
Hopping Mode	82.58	53.5	29.08	54	-24.92	Pass

Note : Average result = Maximum field strength – Delta result



Test Mode :	Mode 3	Temperature :	20~23°C
Test Channel :	78	Relative Humidity :	51~53%
Test Engineer :	Wii Chang	Polarization :	Horizontal

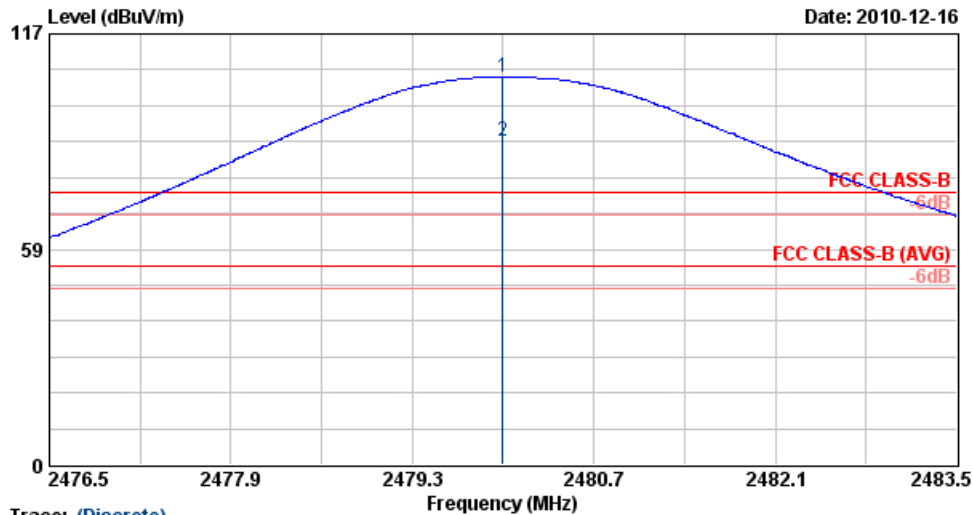

Trace: (Discrete)

Site : 03CH07-HY
 Condition : FCC CLASS-B HF_ANT_100824 HORIZONTAL
 Project : FR 0D0334
 Mode : Mode 3

	Freq	Level	Over Limit	Limit Line	Read Level	Antenna Factor	Cable Loss	Preamp Factor	Ant Pos	Table Pos	Remark
	MHz	dBUV/m	dB	dBUV/m	dBuV	dB/m	dB	dB	cm	deg	
1 @	2480.00	105.24	31.24	74.00	100.68	32.28	6.18	33.90	100	231	Peak
2 @	2480.00	87.86	33.86	54.00	83.30	32.28	6.18	33.90	100	231	Average

* Maximum field strength of the fundamental emission



Test Mode :	Mode 3	Temperature :	20~23°C
Test Channel :	78	Relative Humidity :	51~53%
Test Engineer :	Wii Chang	Polarization :	Horizontal

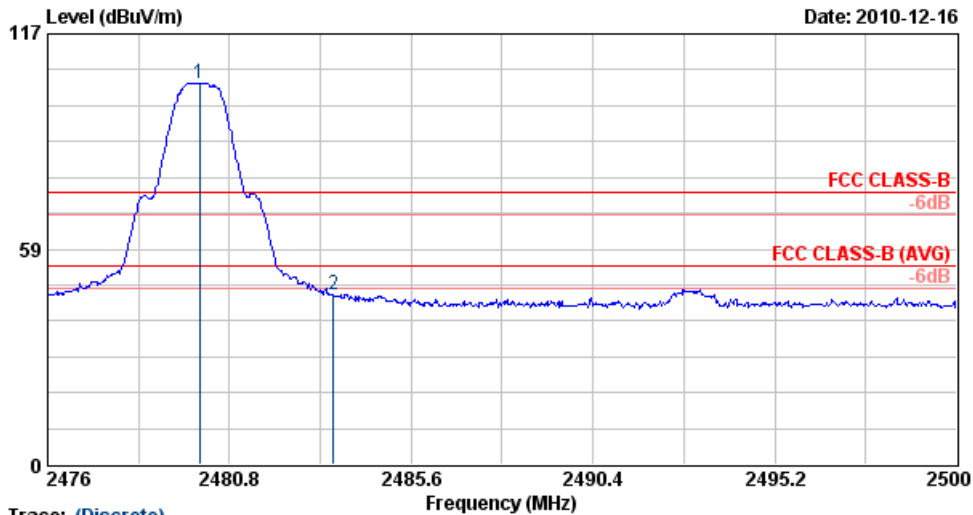

Trace: (Discrete)

Site : 03CH07-HY
 Condition : FCC CLASS-B HF_ANT_100824 HORIZONTAL
 Project : FR 0D0334
 Mode : Mode 3

	Freq	Level	Over Limit	Limit Line	Read Level	Antenna Factor	Cable Loss	Preamp Factor	Ant Pos	Table Pos	Remark
	MHz	dBuV/m	dB	dBuV/m	dBuV	dB/m	dB	dB	cm	deg	
1 @	2480.00	103.72	29.72	74.00	99.16	32.28	6.18	33.90	100	231	Peak
2	2483.54	46.29	-27.71	74.00	41.73	32.28	6.18	33.90	100	231	Peak

* Marker-Delta Method (RBW/VBW=100KHz): 57.43 dB , single carrier Mode



Test Mode :	Mode 3	Temperature :	20~23°C
Test Channel :	78	Relative Humidity :	51~53%
Test Engineer :	Wii Chang	Polarization :	Horizontal

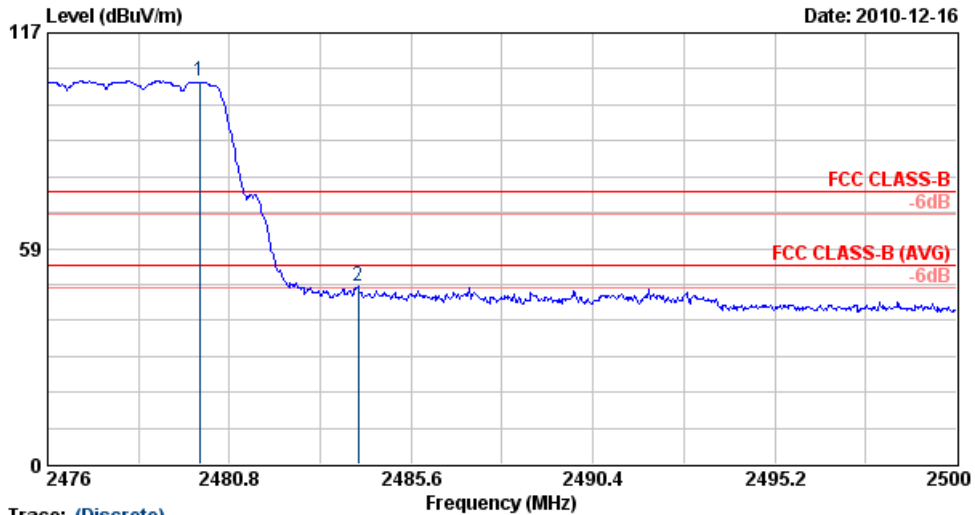

Trace: (Discrete)

Site : 03CH07-HY
 Condition : FCC CLASS-B HF_ANT_100824 HORIZONTAL
 Project : FR_0D0334
 Mode : Mode 3

	Freq	Level	Over Limit	Limit Line	Read Level	Antenna Factor	Cable Loss	Preamp Factor	Ant Pos	Table Pos	Remark
	MHz	dBuV/m	dB	dBuV/m	dBuV	dB/m	dB	dB	cm	deg	
1 @	2480.00	103.88	29.88	74.00	99.32	32.28	6.18	33.90	100	231	Peak
2	2484.21	48.20	-25.80	74.00	43.64	32.28	6.18	33.90	100	231	Peak

* Marker-Delta Method (RBW/VBW=100KHz): 55.68 dB , Hopping Mode



Test Mode :	Mode 3	Temperature :	20~23°C
Test Channel :	78	Relative Humidity :	51~53%
Test Engineer :	Wii Chang	Polarization :	Vertical

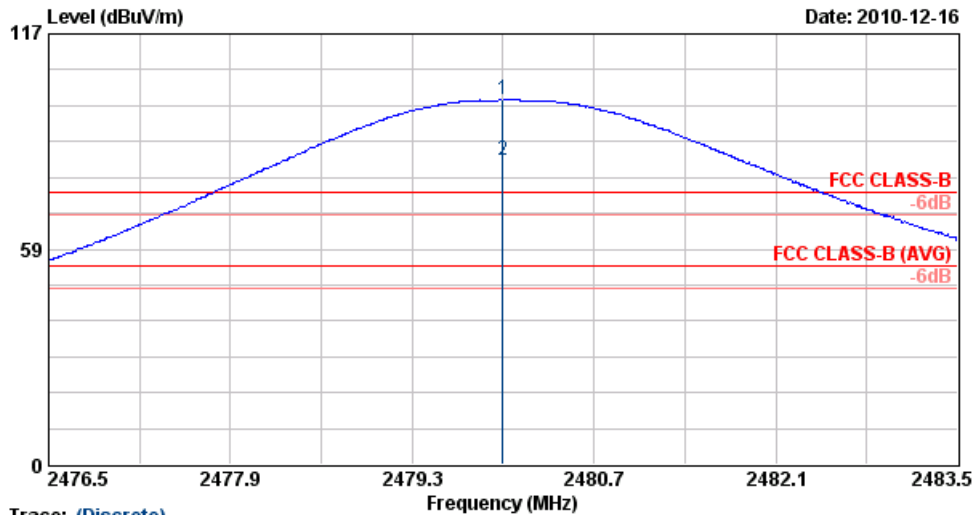

Trace: (Discrete)

Site : 03CH07-HY
 Condition : FCC CLASS-B HF_ANT_100824 VERTICAL
 Project : FR 0D0334
 Mode : Mode 3

	Freq	Level	Over Limit	Limit Line	Read Level	Antenna Factor	Cable Loss	Preamp Factor	Ant Pos	Table Pos	Remark
	MHz	dBuV/m	dB	dBuV/m	dBuV	dB/m	dB	dB	cm	deg	
1	X	2480.00	99.06	25.06	74.00	94.50	32.28	6.18	33.90	130	252 Peak
2	X	2480.00	82.58	28.58	54.00	78.02	32.28	6.18	33.90	130	252 Average

* Maximum field strength of the fundamental emission



Test Mode :	Mode 3	Temperature :	20~23°C
Test Channel :	78	Relative Humidity :	51~53%
Test Engineer :	Wii Chang	Polarization :	Vertical

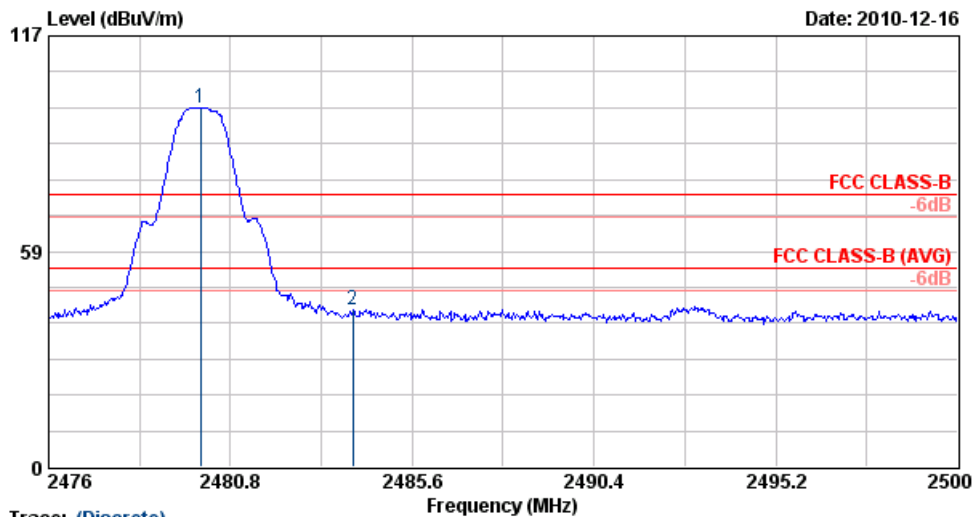

Trace: (Discrete)

Site : 03CH07-HY
 Condition : FCC CLASS-B HF_ANT_100824 VERTICAL
 Project : FR 0D0334
 Mode : Mode 3

	Freq	Level	Over Limit	Limit Line	Read Level	Antenna Factor	Cable Loss	Preamp Factor	Ant Pos	Table Pos	Remark
	MHz	dBuV/m	dB	dBuV/m	dBuV	dB/m	dB	dB	cm	deg	
1 X	2480.00	97.55	23.55	74.00	92.99	32.28	6.18	33.90	130	252	Peak
2	2484.04	42.82	-31.18	74.00	38.26	32.28	6.18	33.90	130	252	Peak

* Marker-Delta Method (RBW/VBW=100KHz): 54.73 dB , single carrier Mode



Test Mode :	Mode 3	Temperature :	20~23°C
Test Channel :	78	Relative Humidity :	51~53%
Test Engineer :	Wii Chang	Polarization :	Vertical

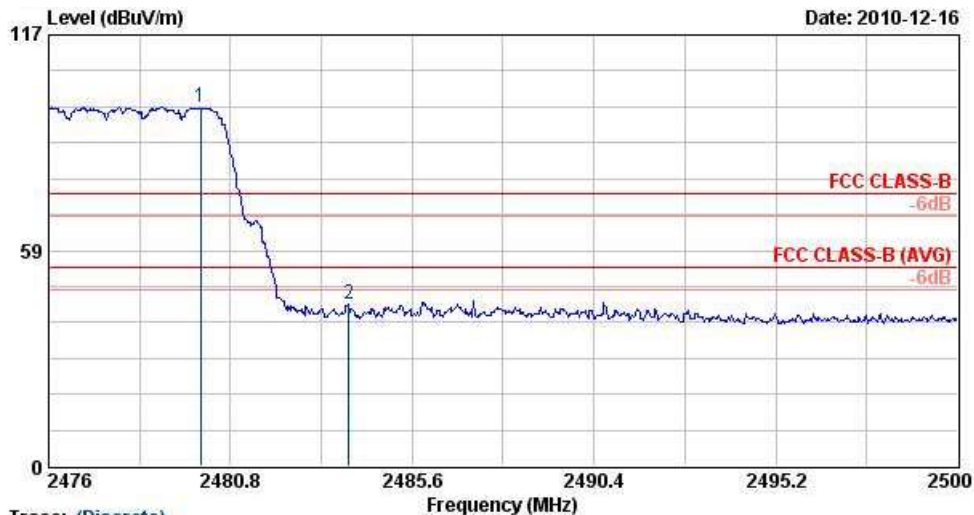

Trace: (Discrete)

Site : 03CH07-HY
 Condition : FCC CLASS-B HF_ANT_100824 VERTICAL
 Project : FR_0D0334
 Mode : Mode 3

	Freq	Level	Over	Limit	Read	Antenna	Cable	Preamp	Ant	Table	Remark
	MHz	dBUV/m	dB	dBUV/m	dBuV	dB/m	dB	dB	cm	deg	
1 @	2480.00	97.34	23.34	74.00	92.78	32.28	6.18	33.90	130	252	Peak
2	2483.92	43.84	-30.16	74.00	39.28	32.28	6.18	33.90	130	252	Peak

* Marker-Delta Method (RBW/VBW=100KHz): 53.50 dB , Hopping Mode



3.6.6 Test Result of Conducted Band Edges

Test Mode :	Mode 7 and 9	Temperature :	25~27°C
Test Channel :	00 and 78	Relative Humidity :	46~50%
		Test Engineer :	Hank Yu

Low Band Edge Plot on Channel 00

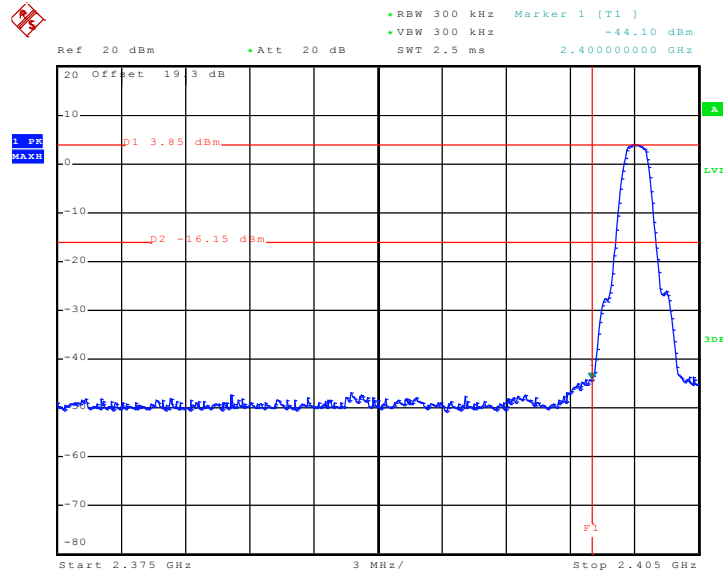

Date: 9.DEC.2010 18:33:36

High Band Edge Plot on Channel 78

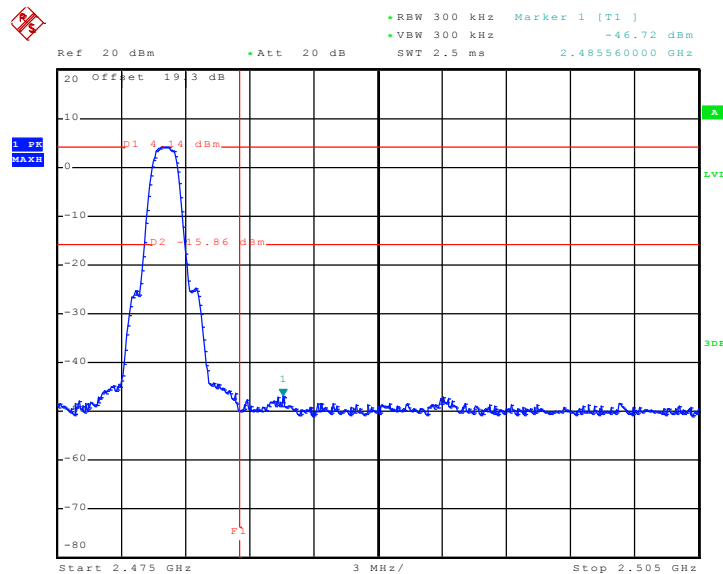

Date: 9.DEC.2010 18:23:12

3.7 Spurious Emission Measurement

3.7.1 Limit of Spurious Emission Measurement

All harmonics/spurs must be at least 20 dB down from the highest emission level within the authorized band.

3.7.2 Measuring Instruments

See list of measuring instruments of this test report.

3.7.3 Test Procedure

1. The transmitter output was connected to the spectrum analyzer via a low lose cable.
2. Set RBW = 100 kHz, Video bandwidth (VBW) \geq RBW, scan up through 10th harmonic. All harmonics / spurs must be at least 20 dB down from the highest emission level within the authorized band as measured with a 100 kHz RBW.

3.7.4 Test Setup

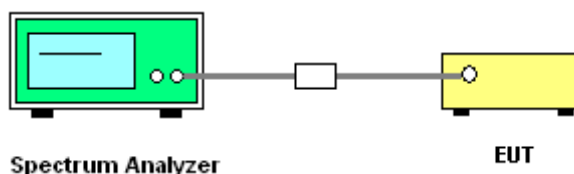



3.7.5 Test Result

Test Mode :	Mode 7	Temperature :	25~27°C
Test Channel :	00	Relative Humidity :	46~50%
		Test Engineer :	Hank Yu

Conducted Spurious Emission Plot between 30MHz ~ 3 GHz

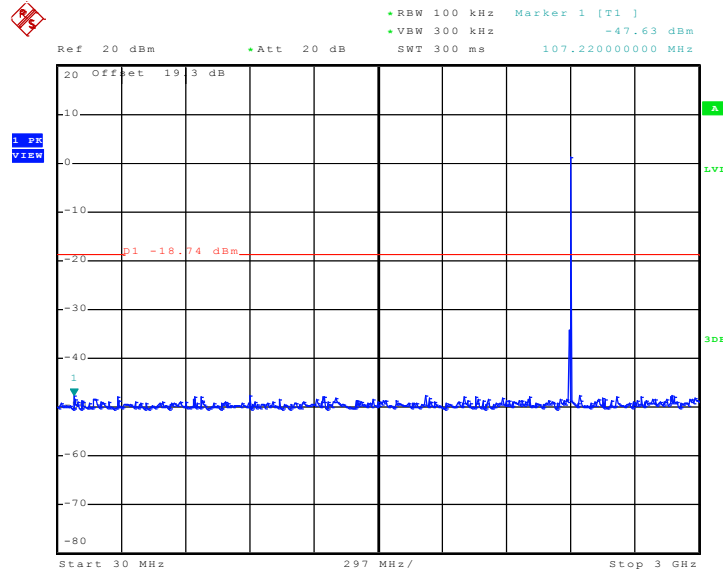

Date: 9.DEC.2010 18:32:27

Conducted Spurious Emission Plot between 3 GHz ~ 25 GHz

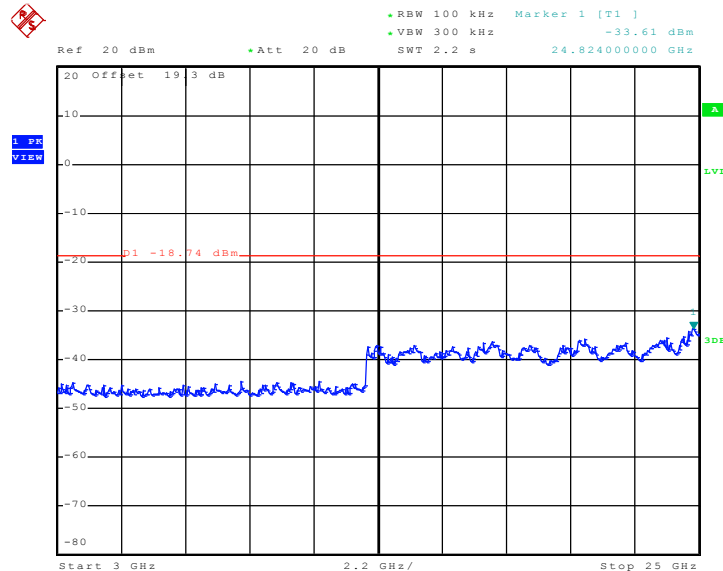

Date: 9.DEC.2010 18:32:49



Test Mode :	Mode 8	Temperature :	25~27°C
Test Channel :	39	Relative Humidity :	46~50%
		Test Engineer :	Hank Yu

Conducted Spurious Emission Plot between 30MHz ~ 3 GHz

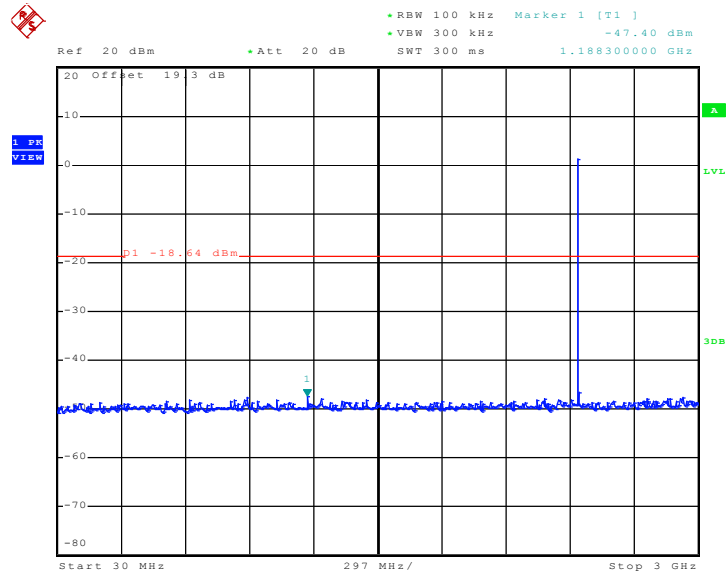

Date: 9.DEC.2010 19:02:01

Conducted Spurious Emission Plot between 3 GHz ~ 25 GHz

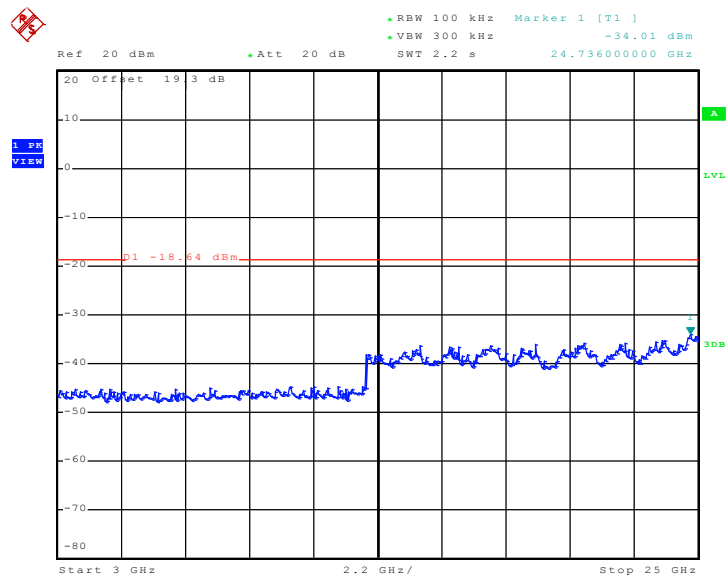

Date: 9.DEC.2010 19:02:23



Test Mode :	Mode 9	Temperature :	25~27°C
Test Channel :	78	Relative Humidity :	46~50%
		Test Engineer :	Hank Yu

Conducted Spurious Emission Plot between 30MHz ~ 3 GHz

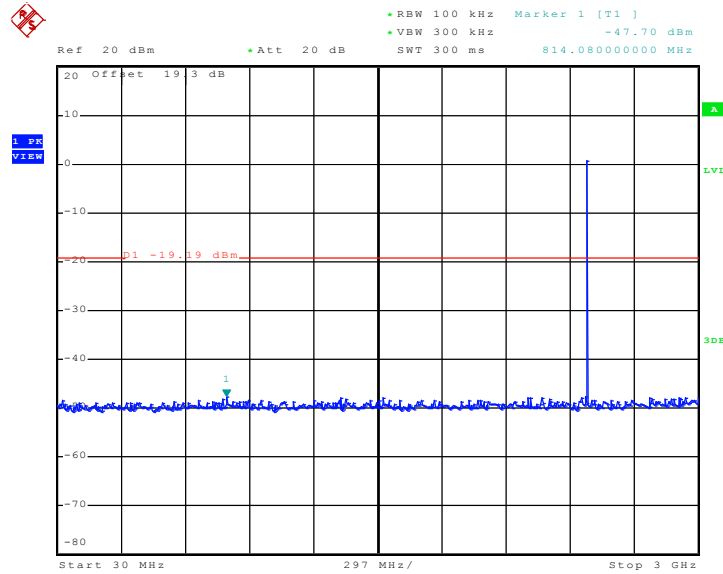

Date: 9.DEC.2010 18:31:04

Conducted Spurious Emission Plot between 3 GHz ~ 25 GHz

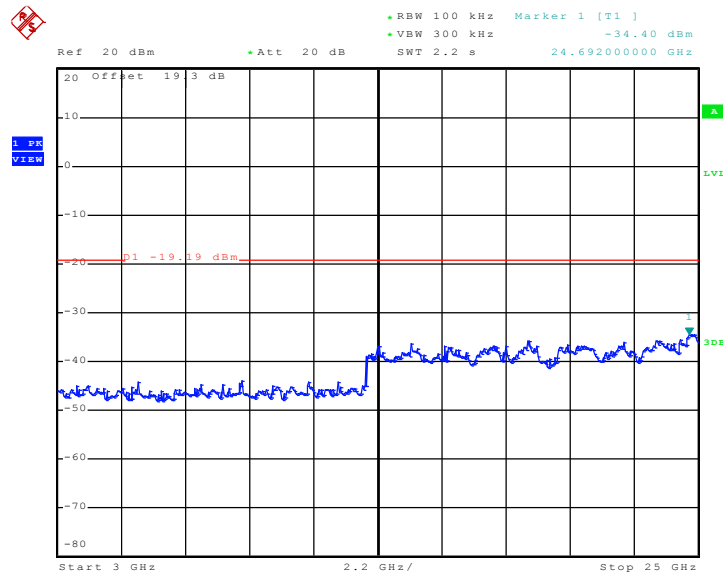

Date: 9.DEC.2010 18:31:26

3.8 AC Conducted Emission Measurement

3.8.1 Limit of AC Conducted Emission

For equipment that is designed to be connected to the public utility (AC) power line, the radio frequency voltage that is conducted back onto the AC power line on any frequency or frequencies within the band 150 kHz to 30 MHz shall not exceed the limits in the following table.

Frequency of emission (MHz)	Conducted limit (dBuV)	
	Quasi-peak	Average
0.15-0.5	66 to 56*	56 to 46*
0.5-5	56	46
5-30	60	50

*Decreases with the logarithm of the frequency.

3.8.2 Measuring Instruments

See list of measuring instruments of this test report.

3.8.3 Test Procedures

1. Please follow the guidelines in ANSI C63.4-2003.
2. The EUT was placed 0.4 meter from the conducting wall of the shielding room was kept at least 80 centimeters from any other grounded conducting surface.
3. Connect EUT to the power mains through a line impedance stabilization network (LISN).
4. All the support units are connecting to the other LISN.
5. The LISN provides 50 ohm coupling impedance for the measuring instrument.
6. The FCC states that a 50 ohm, 50 microhenry LISN should be used.
7. Both sides of AC line were checked for maximum conducted interference.
8. The frequency range from 150 kHz to 30 MHz was searched.
9. Set the test-receiver system to Peak Detect Function and specified bandwidth with Maximum Hold Mode.

3.8.4 Test Setup

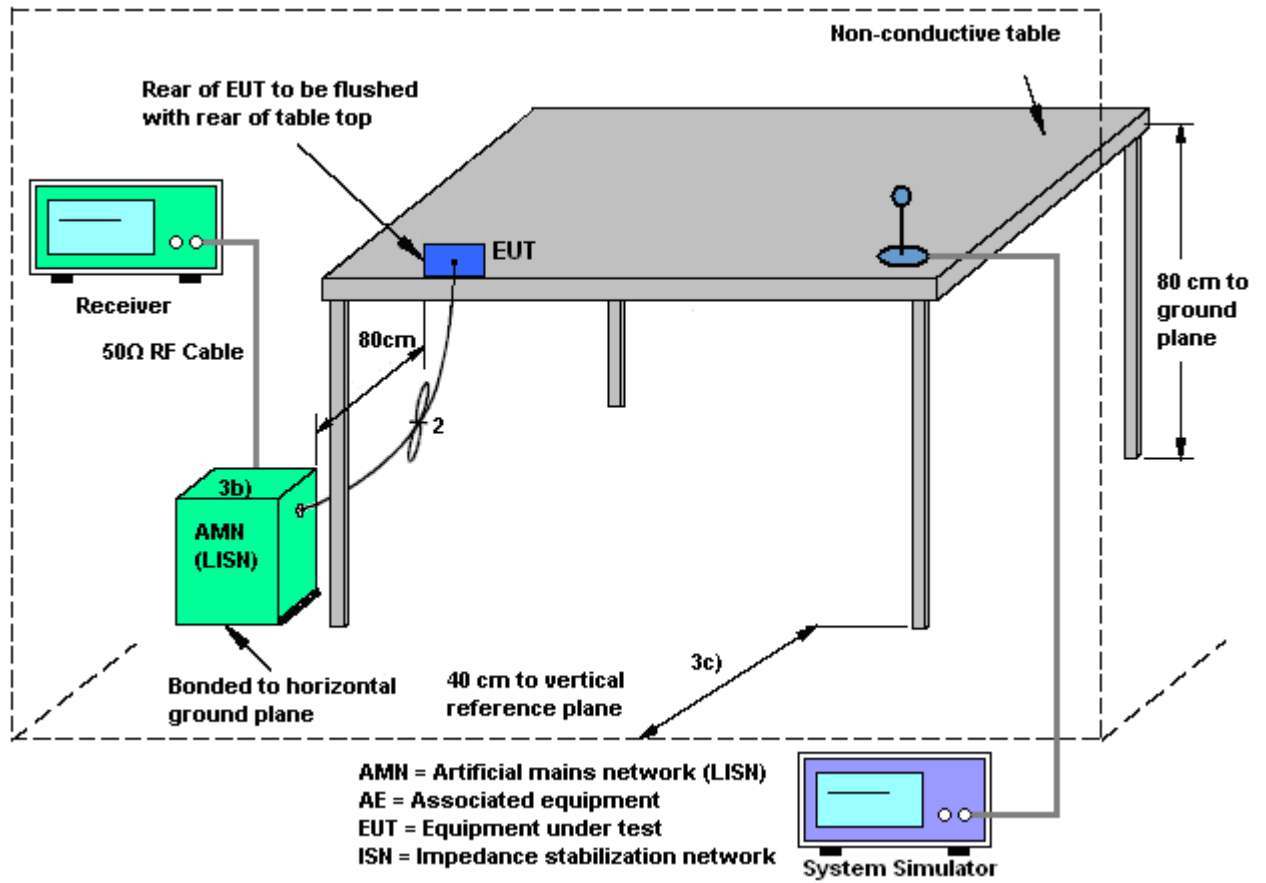



3.8.5 Test Result of AC Conducted Emission

Test Mode :	Mode 1	Temperature :	20~22°C
Test Engineer :	Cona Huang	Relative Humidity :	44~46%
Test Voltage :	+12Vdc	Phase :	Positive
Function Type :	Bluetooth Link + Car Charger (DC 12V)		
Remark :	All emissions not reported here are more than 10 dB below the prescribed limit.		

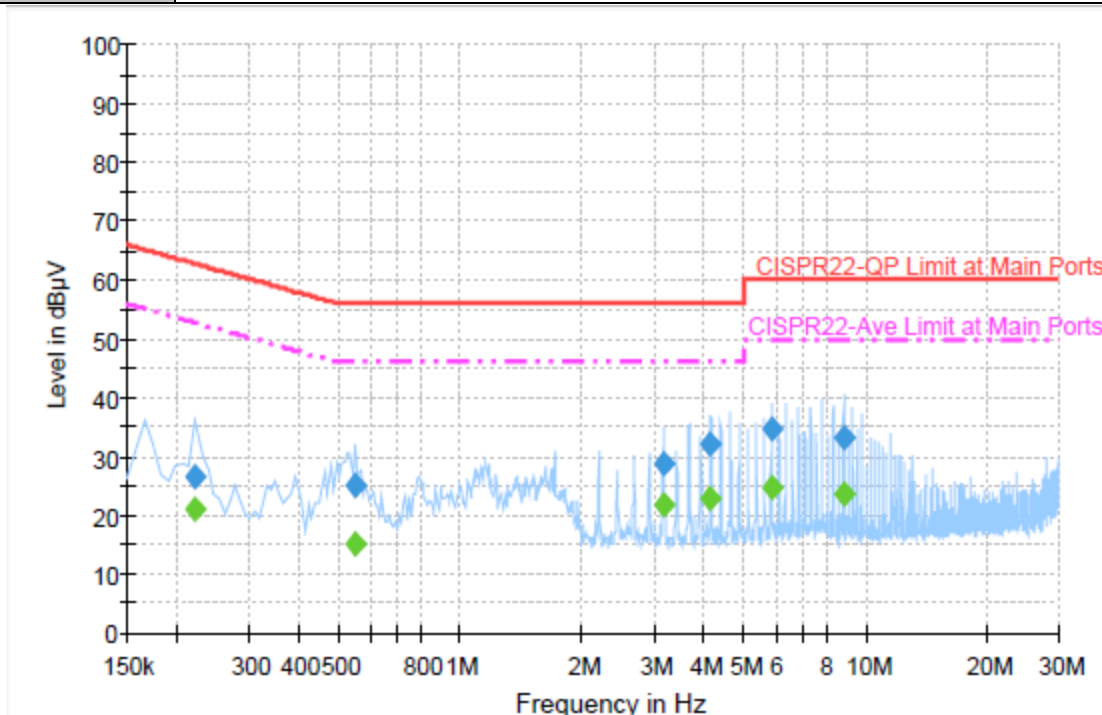

Final Result 1

Frequency (MHz)	QuasiPeak (dBµV)	Line	Corr. (dB)	Margin (dB)	Limit (dBµV)
0.222000	26.7	1	10.1	36.0	62.7
0.550000	25.0	1	9.9	31.0	56.0
3.174000	28.7	1	10.1	27.3	56.0
4.150000	32.2	1	10.1	23.8	56.0
5.870000	34.6	1	10.1	25.4	60.0
8.822000	33.4	1	10.2	26.6	60.0

Final Result 2

Frequency (MHz)	Average (dBµV)	Line	Corr. (dB)	Margin (dB)	Limit (dBµV)
0.222000	21.0	1	10.1	31.7	52.7
0.550000	15.0	1	9.9	31.0	46.0
3.174000	21.9	1	10.1	24.1	46.0
4.150000	22.7	1	10.1	23.3	46.0
5.870000	24.6	1	10.1	25.4	50.0
8.822000	23.5	1	10.2	26.5	50.0



Test Mode :	Mode 1	Temperature :	20~22°C
Test Engineer :	Cona Huang	Relative Humidity :	44~46%
Test Voltage :	-12Vdc	Phase :	Negative
Function Type :	Bluetooth Link + Car Charger (DC 12V)		
Remark :	All emissions not reported here are more than 10 dB below the prescribed limit.		

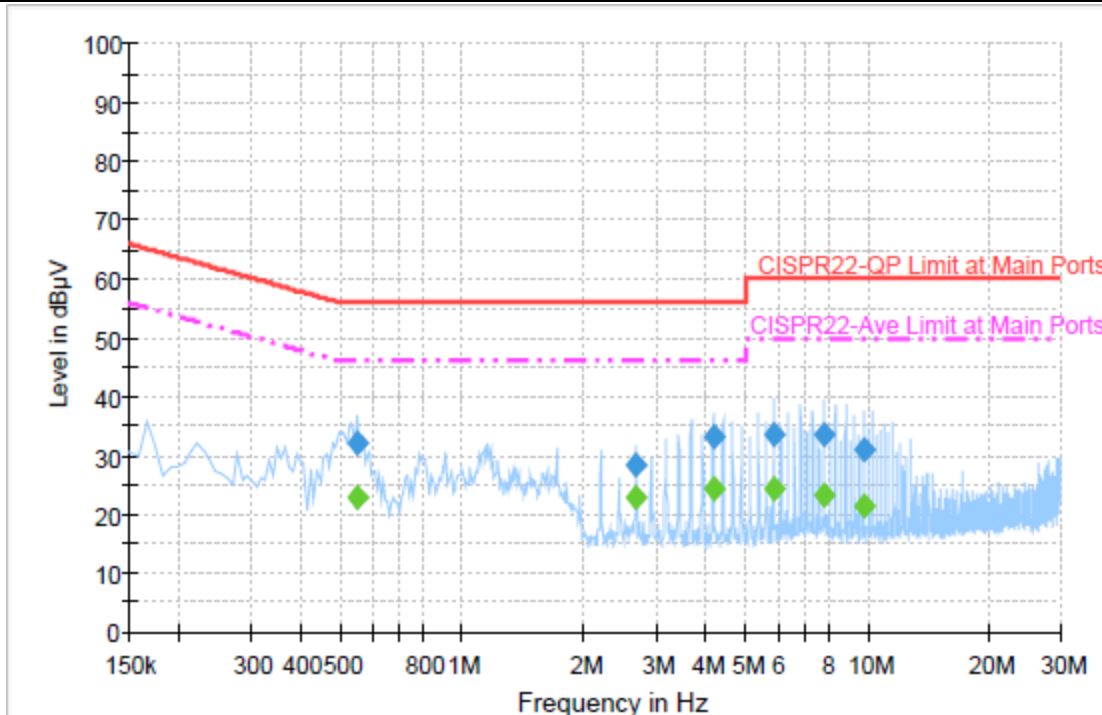

Final Result 1

Frequency (MHz)	QuasiPeak (dBµV)	Line	Corr. (dB)	Margin (dB)	Limit (dBµV)
0.550000	32.1	2	9.9	23.9	56.0
2.686000	28.5	2	10.0	27.5	56.0
4.158000	33.0	2	10.1	23.0	56.0
5.870000	33.6	2	10.1	26.4	60.0
7.830000	33.4	2	10.0	26.6	60.0
9.806000	31.1	2	10.1	28.9	60.0

Final Result 2

Frequency (MHz)	Average (dBµV)	Line	Corr. (dB)	Margin (dB)	Limit (dBµV)
0.550000	22.9	2	9.9	23.1	46.0
2.686000	22.7	2	10.0	23.3	46.0
4.158000	24.5	2	10.1	21.5	46.0
5.870000	24.3	2	10.1	25.7	50.0
7.830000	23.1	2	10.0	26.9	50.0
9.806000	21.4	2	10.1	28.6	50.0

3.9 Radiated Emission Measurement

3.9.1 Limit of Radiated Emission

In any 100 kHz bandwidth outside the intentional radiator frequency band, all harmonics/spurious must be at least 20 dB below the highest emission level within the authorized band. In addition, radiated emissions which fall in the restricted bands must also comply with the FCC section 15.209 limits as below.

Frequency (MHz)	Field Strength (microvolts/meter)	Measurement Distance (meters)
0.009 – 0.490	2400/F(kHz)	300
0.490 – 1.705	24000/F(kHz)	30
1.705 – 30.0	30	30
30 – 88	100	3
88 – 216	150	3
216 - 960	200	3
Above 960	500	3

3.9.2 Measuring Instruments

See list of measuring instruments of this test report.

3.9.3 Test Procedures

1. The testing follows the guidelines in FCC Public Notice DA 00-705 Measurement Guidelines.
2. Use the following spectrum analyzer settings:
 - (1) Span = wide enough to fully capture the emission being measured; RBW = 1 MHz for $f \geq 1$ GHz, 100 kHz for $f < 1$ GHz; VBW \geq RBW; Sweep = auto; Detector function = peak; Trace = max hold.
 - (2) Above 18 GHz shall be extrapolated to the specified distance using an extrapolation factor of 20 dB/decade from 3m to 1m.
Distance extrapolation factor = $20 \log(\text{specific distance [3m]} / \text{test distance [1m]})$ (dB)
3. Follow the guidelines in ANSI C63.4-2003 with respect to maximizing the emission by rotating the EUT, measuring the emission for three EUT orthogonal planes, and adjusting the measurement antenna height and polarization. A pre-amp and a high pass filter are used for this test in order to get the good signal level.

3.9.4 Test Setup

For radiated emissions below 30MHz

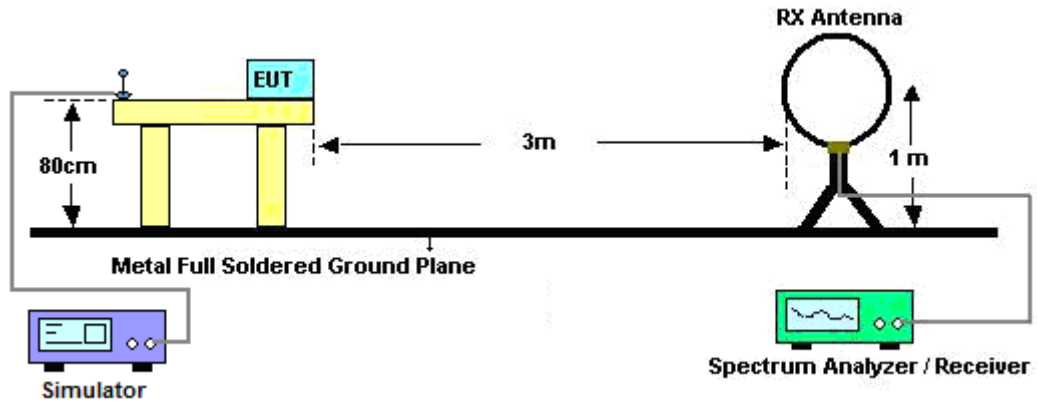

For radiated emissions above 30MHz

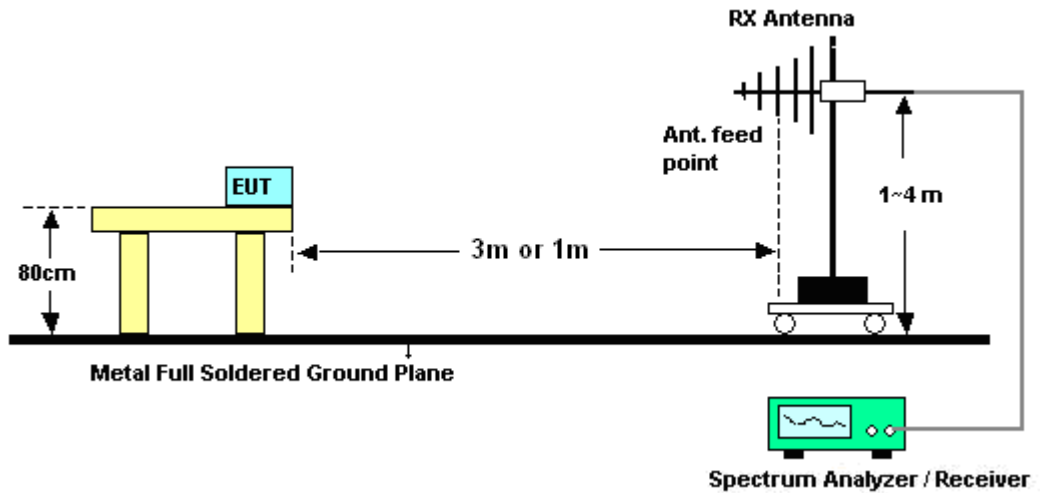



3.9.5 Test Results of Radiated Emissions (9 kHz ~ 30 MHz)

Test Engineer :	Wii Chang	Temperature :	20~23°C	
		Relative Humidity :	51~53%	
Frequency (MHz)	Level (dBuV)	Over Limit (dB)	Limit Line (dBuV)	Remark
-	-	-	-	See Note

Note:

The amplitude of spurious emissions that are attenuated by more than 20dB below the permissible value has no need to be reported.

Distance extrapolation factor = $40 \log(\text{specific distance} / \text{test distance})$ (dB);

Limit line = specific limits (dBuV) + distance extrapolation factor.



3.9.6 Test Result of Radiated Emission (30 MHz ~ 10th Harmonic)

Test Mode :	Mode 1	Temperature :	20~23°C
Test Channel :	00	Relative Humidity :	51~53%
Test Engineer :	Wii Chang	Polarization :	Horizontal
Remark :	2402 MHz is Fundamental Signals which can be ignored.		

Frequency (MHz)	Level (dBuV/m)	Over Limit (dB)	Limit Line (dBuV/m)	Read Level (dBuV)	Antenna Factor (dB)	Cable Loss (dB)	Preamp Factor (dB)	Ant Pos (cm)	Table Pos (deg)	Remark
35.94	23.06	-16.94	40	39.09	14.86	0.59	31.48	-	-	Peak
152.58	21.91	-21.59	43.5	41.29	10.96	1.21	31.55	-	-	Peak
236.82	20.94	-25.06	46	39.15	11.71	1.51	31.43	-	-	Peak
430.2	18.76	-27.24	46	30.57	17.07	2.25	31.13	-	-	Peak
797	24.46	-21.54	46	29.58	22.42	3.14	30.68	-	-	Peak
903.4	29.79	-16.21	46	33.46	23.67	3.35	30.69	100	111	Peak
2389.42	40.28	-13.72	54	35.92	32.18	6.03	33.85	102	232	Average
2389.42	52.61	-21.39	74	48.25	32.18	6.03	33.85	102	232	Peak
2402	105.29	-	-	100.93	32.18	6.03	33.85	102	232	Peak
2402	88.62	-	-	84.26	32.18	6.03	33.85	102	232	Average
2500	34.07	-19.93	54	29.49	32.3	6.18	33.9	102	232	Average
2500	44.97	-29.03	74	40.39	32.3	6.18	33.9	102	232	Peak
4804	53.17	-20.83	74	66.44	34.06	9.11	56.44	148	310	Peak
4804	41.45	-12.55	54	54.72	34.06	9.11	56.44	148	310	Average



Test Mode :	Mode 1	Temperature :	20~23°C
Test Channel :	00	Relative Humidity :	51~53%
Test Engineer :	Wii Chang	Polarization :	Vertical
Remark :	2402 MHz is Fundamental Signals which can be ignored.		

Frequency (MHz)	Level (dBuV/m)	Over Limit (dB)	Limit Line (dBuV/m)	Read Level (dBuV)	Antenna Factor (dB)	Cable Loss (dB)	Preamp Factor (dB)	Ant Pos (cm)	Table Pos (deg)	Remark
34.59	31.6	-8.4	40	47.16	15.33	0.58	31.47	210	111	Peak
154.74	23.62	-19.88	43.5	43.2	10.74	1.22	31.54	-	-	Peak
298.38	15.6	-30.4	46	31.73	13.44	1.76	31.33	-	-	Peak
466.6	19.33	-26.67	46	30.39	17.67	2.34	31.07	-	-	Peak
788.6	24.53	-21.47	46	29.8	22.29	3.12	30.68	-	-	Peak
985.3	27.74	-26.26	54	30.11	24.71	3.5	30.58	-	-	Peak
2389.42	34.98	-19.02	54	30.62	32.18	6.03	33.85	101	246	Average
2389.42	47.68	-26.32	74	43.32	32.18	6.03	33.85	101	246	Peak
2402	82.68	-	-	78.32	32.18	6.03	33.85	101	246	Average
2402	98.87	-	-	94.49	32.2	6.03	33.85	101	246	Peak
2500	45.22	-28.78	74	40.64	32.3	6.18	33.9	101	246	Peak
2500	33.27	-20.73	54	28.69	32.3	6.18	33.9	101	246	Average
4804	57.7	-16.3	74	70.97	34.06	9.11	56.44	100	198	Peak
4804	47.68	-6.32	54	60.95	34.06	9.11	56.44	100	198	Average



Test Mode :	Mode 2	Temperature :	20~23°C
Test Channel :	39	Relative Humidity :	51~53%
Test Engineer :	Wii Chang	Polarization :	Horizontal
Remark :	2441 MHz is Fundamental Signals which can be ignored.		

Frequency (MHz)	Level (dBuV/m)	Over Limit (dB)	Limit Line (dBuV/m)	Read Level (dBuV)	Antenna Factor (dB)	Cable Loss (dB)	Preamp Factor (dB)	Ant Pos (cm)	Table Pos (deg)	Remark
50.25	23.08	-16.92	40	45.64	8.28	0.7	31.54	-	-	Peak
136.65	27.16	-16.34	43.5	45.94	11.59	1.19	31.56	100	211	Peak
279.21	14.56	-31.44	46	31.14	13.13	1.64	31.35	-	-	Peak
430.2	18.45	-27.55	46	30.26	17.07	2.25	31.13	-	-	Peak
604.5	22.07	-23.93	46	30.48	19.81	2.7	30.92	-	-	Peak
903.4	28.04	-17.96	46	31.71	23.67	3.35	30.69	-	-	Peak
2342	46.4	-27.6	74	42.17	32.11	5.95	33.83	100	233	Peak
2342	38.69	-15.31	54	34.46	32.11	5.95	33.83	100	233	Average
2441	105.84	-	-	101.37	32.24	6.11	33.88	100	233	Peak
2441	88.6	-	-	84.13	32.24	6.11	33.88	100	233	Average
2500	45.06	-28.94	74	40.48	32.3	6.18	33.9	100	233	Peak
2500	33.06	-20.94	54	28.48	32.3	6.18	33.9	100	233	Average
4882	53.21	-20.79	74	66.48	34.08	9.14	56.49	184	306	Peak
4882	41.77	-32.23	74	55.04	34.08	9.14	56.49	184	306	Peak



Test Mode :	Mode 2	Temperature :	20~23°C
Test Channel :	39	Relative Humidity :	51~53%
Test Engineer :	Wii Chang	Polarization :	Vertical
Remark :	2441 MHz is Fundamental Signals which can be ignored.		

Frequency (MHz)	Level (dBuV/m)	Over Limit (dB)	Limit Line (dBuV/m)	Read Level (dBuV)	Antenna Factor (dB)	Cable Loss (dB)	Preamp Factor (dB)	Ant Pos (cm)	Table Pos (deg)	Remark
33.78	28.61	-11.39	40	43.94	15.57	0.57	31.47	100	222	Peak
91.02	22.63	-20.87	43.5	44.41	8.79	0.95	31.52	-	-	Peak
242.22	19.11	-26.89	46	36.88	12.12	1.53	31.42	-	-	Peak
470.1	19.32	-26.68	46	30.31	17.73	2.35	31.07	-	-	Peak
783.7	24.98	-21.02	46	30.35	22.21	3.11	30.69	-	-	Peak
1000	27.92	-26.08	54	30.1	24.89	3.51	30.58	-	-	Peak
2334	44.59	-29.41	74	40.38	32.09	5.95	33.83	100	247	Peak
2334	34	-20	54	29.79	32.09	5.95	33.83	100	247	Average
2441	99.7	-	-	95.23	32.24	6.11	33.88	100	247	Peak
2441	83.44	-	-	78.97	32.24	6.11	33.88	100	247	Average
2484	44.72	-29.28	74	40.16	32.28	6.18	33.9	100	247	Peak
2484	32.55	-21.45	54	27.99	32.28	6.18	33.9	100	247	Average
4882	56.73	-17.27	74	70	34.08	9.14	56.49	100	188	Peak
4882	48.01	-5.99	54	61.28	34.08	9.14	56.49	100	188	Average



Test Mode :	Mode 3	Temperature :	20~23°C
Test Channel :	78	Relative Humidity :	51~53%
Test Engineer :	Wii Chang	Polarization :	Horizontal
Remark :	2480 MHz is Fundamental Signals which can be ignored.		

Frequency (MHz)	Level (dBuV/m)	Over Limit (dB)	Limit Line (dBuV/m)	Read Level (dBuV)	Antenna Factor (dB)	Cable Loss (dB)	Preamp Factor (dB)	Ant Pos (cm)	Table Pos (deg)	Remark
51.06	22.58	-17.42	40	45.39	8.02	0.71	31.54	-	-	Peak
154.74	21.73	-21.77	43.5	41.31	10.74	1.22	31.54	-	-	Peak
265.17	14.48	-31.52	46	31.36	12.9	1.62	31.4	-	-	Peak
399.4	17.25	-28.75	46	29.73	16.56	2.14	31.18	-	-	Peak
766.2	23.7	-22.3	46	29.37	21.93	3.09	30.69	-	-	Peak
903.4	29.37	-16.63	46	33.04	23.67	3.35	30.69	100	151	Peak
2382	48.19	-25.81	74	43.85	32.16	6.03	33.85	100	231	Peak
2382	38.37	-15.63	54	34.03	32.16	6.03	33.85	100	231	Average
2480	105.21	-	-	100.65	32.28	6.18	33.9	100	231	Peak
2480	87.17	-	-	82.61	32.28	6.18	33.9	100	231	Average
2483.5	32.18	-21.82	54	27.62	32.28	6.18	33.9	100	231	Average
2483.5	70.5	-3.5	74	65.94	32.28	6.18	33.9	100	231	Peak
4960	54.98	-19.02	74	68.28	34.09	9.16	56.55	100	66	Peak
4960	42.53	-11.47	54	55.83	34.09	9.16	56.55	100	66	Average



Test Mode :	Mode 3	Temperature :	20~23°C
Test Channel :	78	Relative Humidity :	51~53%
Test Engineer :	Wii Chang	Polarization :	Vertical
Remark :	2480 MHz is Fundamental Signals which can be ignored.		

Frequency (MHz)	Level (dBuV/m)	Over Limit (dB)	Limit Line (dBuV/m)	Read Level (dBuV)	Antenna Factor (dB)	Cable Loss (dB)	Preamp Factor (dB)	Ant Pos (cm)	Table Pos (deg)	Remark
34.86	30.92	-9.08	40	46.48	15.33	0.58	31.47	100	111	Peak
84.54	23.32	-16.68	40	46.16	7.8	0.9	31.54	-	-	Peak
283.26	24.89	-21.11	46	41.38	13.2	1.65	31.34	-	-	Peak
405	17.35	-28.65	46	29.7	16.66	2.16	31.17	-	-	Peak
593.3	21.46	-24.54	46	30.05	19.67	2.67	30.93	-	-	Peak
951	27.16	-18.84	46	30	24.27	3.46	30.57	-	-	Peak
2340	32.75	-21.25	54	28.52	32.11	5.95	33.83	130	252	Average
2340	44.63	-29.37	74	40.4	32.11	5.95	33.83	130	252	Peak
2480	82.58	-	-	78.02	32.28	6.18	33.9	130	252	Average
2480	98.94	-	-	94.38	32.28	6.18	33.9	130	252	Peak
2483.5	29.08	-24.92	54	24.52	32.28	6.18	33.9	130	252	Average
2483.5	64.1	-9.9	74	59.54	32.28	6.18	33.9	130	252	Peak
4960	56.93	-17.07	74	70.23	34.09	9.16	56.55	100	197	Peak
4960	47.59	-6.41	54	60.89	34.09	9.16	56.55	100	197	Average



3.10 Antenna Requirements

3.10.1 Standard Applicable

If directional gain of transmitting antennas is greater than 6dBi, the power shall be reduced by the same level in dB comparing to gain minus 6dBi. The use of a permanently attached antenna or of an antenna that uses a unique coupling to the intentional radiator shall be considered sufficient to comply with the FCC rule.

3.10.2 Antenna Connected Construction

The antennas type used in this product is PCB Antenna without connector and it is considered to meet antenna requirement.

3.10.3 Antenna Gain

The antenna peak gain of EUT is less than 6 dBi. Therefore, it is not necessary to reduce maximum peak output power limit.



4 List of Measuring Equipment

Instrument	Manufacturer	Model No.	Serial No.	Characteristics	Calibration Date	Due Date	Remark
Spectrum Analyzer	R&S	FSP30	101329	9kHz~30GHz	Apr. 26, 2010	Apr. 25, 2011	Conducted (TH02-HY)
Power Meter	Anritsu	ML2495A	0932001	N/A	Sep. 13, 2010	Sep. 12, 2011	Conducted (TH02-HY)
Power Sensor	Anritsu	MA2411B	0846202	N/A	Sep. 14, 2010	Sep. 13, 2011	Conducted (TH02-HY)
EMI Test Receive	R&S	ESCS 30	100356	9KHz – 2.75GHz	Aug. 16, 2010	Aug. 15, 2011	Conduction (CO05-HY)
Two-LISN	R&S	ENV216	11-100081	9KHz – 30MHz	Dec. 03, 2010	Dec. 02, 2011	Conduction (CO05-HY)
Two-LISN	R&S	ENV216	11-100080	9KHz – 30MHz	Dec. 01, 2010	Nov. 30, 2011	Conduction (CO05-HY)
AC Power Source	APC	APC-1000W	N/A	N/A	N/A	N/A	Conduction (CO05-HY)
System Simulator	R&S	CMU200	117995	N/A	Mar. 19, 2009	Mar. 18, 2011	Conduction (CO05-HY)
Bilog Antenna	SCHAFFNER	CBL6111C	2726	30MHz ~ 1GHz	Oct. 31, 2010	Oct. 30, 2011	Radiation (03CH07-HY)
Spectrum Analyzer	R&S	FSP	101067	9KHz ~ 30GHz	Dec. 03, 2010	Dec. 02, 2011	Radiation (03CH07-HY)
Double Ridge Horn Antenna	ESCO	3117	00075962	1GHz ~ 18GHz	Aug. 19, 2010	Aug. 18, 2011	Radiation (03CH07-HY)
SHF-EHF Horn Antenna	SCHWARZBECK	BBHA 9170	BBHA9170251	15GHz- 40GHz	Oct. 18, 2010	Oct. 17, 2011	Radiation (03CH07-HY)
Pre Amplifier	Agilent	8449B	3008A02362	1GHz~ 26.5GHz	Dec. 06, 2010	Dec. 05, 2011	Radiation (03CH07-HY)
Pre Amplifier	COM-POWER	PA-103A	161241	10-1000MHz.32dB.GAIN	Mar. 27, 2010	Mar. 26, 2011	Radiation (03CH07-HY)
Loop Antenna	R&S	HFH2-Z2	860004/001	9 kHz~30 MHz	Jul. 29, 2010	Jul. 28, 2011	Radiation (03CH07-HY)
Bluetooth Base Station	R&S	CBT32	100519	N/A	May 12, 2009	May 11, 2011	Radiation (03CH07-HY)

5 Uncertainty of Evaluation

Uncertainty of Conducted Emission Measurement (150 kHz ~ 30 MHz)

Contribution	Uncertainty of X_i		$u(X_i)$
	dB	Probability Distribution	
Receiver Reading	0.10	Normal (k=2)	0.05
Cable Loss	0.10	Normal (k=2)	0.05
AMN Insertion Loss	2.50	Rectangular	0.63
Receiver Specification	1.50	Rectangular	0.43
Site Imperfection	1.39	Rectangular	0.80
Mismatch	+0.34 / -0.35	U-Shape	0.24
Combined Standard Uncertainty $U_c(y)$	1.13		
Measuring Uncertainty for a Level of Confidence of 95% ($U = 2U_c(y)$)	2.26		

Uncertainty of Radiated Emission Measurement (30 MHz ~ 1000 MHz)

Contribution	Uncertainty of X_i		$u(X_i)$
	dB	Probability Distribution	
Receiver Reading	0.41	Normal (k=2)	0.21
Antenna Factor Calibration	0.83	Normal (k=2)	0.42
Cable Loss Calibration	0.25	Normal (k=2)	0.13
Pre-Amplifier Gain Calibration	0.27	Normal (k=2)	0.14
RCV/SPA Specification	2.50	Rectangular	0.72
Antenna Factor Interpolation for Frequency	1.00	Rectangular	0.29
Site Imperfection	1.43	Rectangular	0.83
Mismatch	+0.39 / -0.41	U-Shape	0.28
Combined Standard Uncertainty $U_c(y)$	1.27		
Measuring Uncertainty for a Level of Confidence of 95% ($U = 2U_c(y)$)	2.54		



Uncertainty of Radiated Emission Measurement (1 GHz ~ 40 GHz)

Contribution	Uncertainty of X_i		$u(X_i)$	C_i	$C_i * u(X_i)$
	dB	Probability Distribution			
Receiver Reading	±0.10	Normal (k=2)	0.10	1	0.10
Antenna Factor Calibration	±1.70	Normal (k=2)	0.85	1	0.85
Cable Loss Calibration	±0.50	Normal (k=2)	0.25	1	0.25
Receiver Correction	±2.00	Rectangular	1.15	1	1.15
Antenna Factor Directional	±1.50	Rectangular	0.87	1	0.87
Site Imperfection	±2.80	Triangular	1.14	1	1.14
Mismatch Receiver VSWR $\Gamma_1 = 0.197$ Antenna VSWR $\Gamma_2 = 0.194$ Uncertainty = $20\text{Log}(1-\Gamma_1*\Gamma_2)$	+0.34 / -0.35	U-Shape	0.244	1	0.244
Combined Standard Uncertainty $U_c(y)$	2.36				
Measuring Uncertainty for a Level of Confidence of 95% ($U = 2U_c(y)$)	4.72				



Appendix A. Photographs of EUT

Please refer to Sporton report number EP0D0334 as below.