



**FCC 47 CFR PART 15 SUBPART C AND ANSI C63.4:2003
TEST REPORT**

For

Universal Bluetooth Headset

Model : HK201

Trade Name : Motorola

Issued for

Motorola Inc.

**600 N. U. S. Highway 45 Libertyville,
Illinois 60048-5343 United States**

Issued by

Compliance Certification Services Inc.

Tainan Laboratory

**No. 8, Jiu Cheng Ling, Jiaokeng Village, Sinhua
Township, Tainan Hsien 712, Taiwan R.O.C.**

TEL: +886-6-580-2201

FAX: +886-6-580-2202

<http://www.ccsrf.com>

E-Mail : service@ccsrf.com



Note: *This report shall not be reproduced except in full, without the written approval of Compliance Certification Services Inc. This document may be altered or revised by Compliance Certification Services Inc. personnel only, and shall be noted in the revision section of the document. The client should not use it to claim product endorsement by TAF or any government agencies. The test results in the report only apply to the tested sample.*



Revision History

Rev.	Issue Date	Revisions	Effect Page	Revised By
00	03/23/2010	Initial Issue	All Page 73	Winnie Chen



TABLE OF CONTENTS

TITLE	PAGE NO.
1. TEST REPORT CERTIFICATION	4
2. EUT DESCRIPTION	5
2.1 DESCRIPTION OF EUT & POWER	5
3. DESCRIPTION OF TEST MODES	6
4. TEST METHODOLOGY	7
5. FACILITIES AND ACCREDITATION	7
5.1 FACILITIES	7
5.2 EQUIPMENT	7
5.3 TABLE OF ACCREDITATIONS AND LISTINGS	8
6. CALIBRATION AND UNCERTAINTY	9
6.1 MEASURING INSTRUMENT CALIBRATION	9
6.2 MEASUREMENT UNCERTAINTY	9
7. SETUP OF EQUIPMENT UNDER TEST	10
8. FCC PART 15.247 REQUIREMENTS	11
8.1 20dB BANDWIDTH FOR HOPPING	11-16
8.2 MAXIMUM PEAK OUTPUT POWER	17-22
8.3 HOPPING CHANNEL SEPARATION	23-25
8.4 NUMBER OF HOPPING FREQUENCY USED	26-28
8.5 DWELL TIME ON EACH CHANNEL	29-34
8.6 CONDUCTED SPURIOUS EMISSION	35-39
8.7 RADIATED EMISSION	40-59
8.8 CONDUCTED EMISSION	60-66
APPENDIX I SETUP PHOTOS	67-73



1. TEST REPORT CERTIFICATION

Applicant : Motorola Inc.
Address : 600 N. U. S. Highway 45 Libertyville,
 Illinois 60048-5343 United States
Equipment Under Test : Universal Bluetooth Headset
Model : HK201
Trade Name : Motorola
Tested Date : March 08 ~ 23, 2010

APPLICABLE STANDARD	
Standard	Test Result
FCC Part 15 Subpart C AND ANSI C63.4:2003	PASS

WE HEREBY CERTIFY THAT: The above equipment has been tested by Compliance Certification Services Inc., and found compliance with the requirements set forth in the technical standards mentioned above. The results of testing in this report apply only to the product/system, which was tested. Other similar equipment will not necessarily produce the same results due to production tolerance and measurement uncertainties.

Approved by:

Jeter Wu
Section Manager

Reviewed by:

Eric Yang
Senior Engineer



2. EUT DESCRIPTION

2.1 DESCRIPTION OF EUT & POWER

Product Name	Universal Bluetooth Headset
Model Number	HK201
Frequency Range	2402MHz to 2480MHz f = 2402 + nMHz, n = 0,78
Transmit Power	-0.48 dBm (0.0009W)
Channel Spacing	1MHz
Channel Number	79 Channels
Transmit Data Rate	GFSK (1Mbps), $\pi/4$ -DQPSK (2Mbps), 8-DPSK (3Mbps)
Type of Modulation	Frequency Hopping Spread Spectrum
Frequency Selection	by software / firmware
Transmitter Classification	portable device
Antenna Type	PCB Antenna, Antenna Gain : 1.98dBi
Power Source	Normal Mode: 3.7VDC(Battery Powered) Charging Mode: 5.0VDC (From Notebook PC, Powered From Host Device & power adapter)
RF Exposure Evaluation	Since the EUT is classed portable device, and the maximum peak power is -0.48 dBm (<13.6dBm), the MPE evaluation is not required and no SAR consideration applied.
I/O Port	Micro USB port x 1

Power Adapter :

No.	Manufacturer	Model No.	Power Input	Power Output
1	MOTOROLA	FMP5334A	100-240V, 50/60Hz, 0.15A	5.0V, 550mA

Remark :

1. The sample selected for test was engineering sample that approximated to production product and was provided by manufacturer.
2. For more details, please refer to the User's manual of the EUT.
3. This submittal(s) (test report) is intended for FCC ID: IHDT6LK1 filing to comply with Section 15.207, 15.209 and 15.247 of the FCC Part 15, Subpart C Rules.



3. DESCRIPTION OF TEST MODES

The EUT (HK201) had been tested under operating condition.

There are three channels have been tested as following :

Channel	Frequency (MHz)
Low	2402
Middle	2441
High	2480

Radiated Emission Test (Below 1 GHz):

Pre-Scan has been conducted to determine the worst-case mode from all possible combinations between available modulations, data rates and antenna ports (if EUT with antenna diversity architecture).

Following channel(s) was (were) selected for the final test as listed below.

Charger Linking

Radiated Emission Test (Above 1 GHz):

Pre-Scan has been conducted to determine the worst-case mode from all possible combinations between available modulations, data rates and antenna ports (if EUT with antenna diversity architecture).

Following channel(s) was (were) selected for the final test as listed below.

Tested Channel	Modulation Technology	Modulation Type	Packet Type
Low, High	FHSS	GFSK	DH5
Low, High	FHSS	8-DPSK	3-DH5

Bandedge Measurement :

Pre-Scan has been conducted to determine the worst-case mode from all possible combinations between available modulations, data rates and antenna ports (if EUT with antenna diversity architecture).

Following channel(s) was (were) selected for the final test as listed below.

Tested Channel	Modulation Technology	Modulation Type	Packet Type
Low, High	FHSS	GFSK	DH5
Low, High	FHSS	8-DPSK	3-DH5



Antenna Port Conducted Measurement :

Pre-Scan has been conducted to determine the worst-case mode from all possible combinations between available modulations, data rates and antenna ports (if EUT with antenna diversity architecture).

Following channel(s) was (were) selected for the final test as listed below.

Tested Channel	Modulation Technology	Modulation Type	Packet Type
Low, Mid, High	FHSS	GFSK	DH5
Low, Mid, High	FHSS	8-DPSK	3-DH5

Remark : The field strength of spurious emission was measured in the following position: EUT stand-up position(Z axis), lie-down position(X, Y axis). The worst emission was found in stand-up position(Z axis) and the worst case was recorded.

4. TEST METHODOLOGY

The tests documented in this report were performed in accordance with ANSI C63.4 : 2003 and FCC CFR 47, 15.207, 15.209 and 15.247.

5. FACILITIES AND ACCREDITATION

5.1 FACILITIES

All measurement facilities used to collect the measurement data are located at No. 8, Jiu Cheng Ling, Jiaokeng Village, Sinhua Township, Tainan Hsien 712, Taiwan R.O.C. The sites are constructed in conformance with the requirements of ANSI C63.7, ANSI C63.4 : 2003 and CISPR Publication 22.

5.2 EQUIPMENT







Radiated emissions are measured with one or more of the following types of linearly polarized antennas: tuned dipole, biconical, log periodic, bi-log, and/or ridged waveguide, horn. Spectrum analyzers with preselectors and quasi-peak detectors are used to perform radiated measurements.

Conducted emissions are measured with Line Impedance Stabilization Networks and EMI Test Receivers.

Calibrated wideband preamplifiers, coaxial cables, and coaxial attenuators are also used for making measurements.

All receiving equipment conforms to CISPR Publication 16-1, "Radio Interference Measuring Apparatus and Measurement Methods."

5.3 TABLE OF ACCREDITATIONS AND LISTINGS

Country	Agency	Scope of Accreditation	Logo
USA	FCC	3/10 meter Open Area Test Sites to perform FCC Part 15/18 measurements	 FCC MRA: TW-1037
Japan	VCCI	3/10 meter Open Area Test Sites to perform conducted/radiated measurements	 C-2882 ; R-2635
Taiwan	TAF	CISPR 11, FCC METHOD-47 CFR Part 18, EN 55011, EN 60601-1-2, CISPR 22, CNS 13438, EN 55022, EN 55024, AS/NZS CISPR 22 CISPR 14, EN 55014-1, EN 55014-2, CNS 13783-1, CISPR 22, CNS 13439, EN 55013, FCC Method-47 CFR Part 15 Subpart B, IC ICES-003, VCCI V-3 & V-4 FCC Method-47 CFR Part 15 Subpart C and ANSI C63.4, LP 0002 EN / IEC 61000-4-2 / -3 / -4 / -5 / -6 / -8 / -11 EN 61000-3-2, EN 61000-3-3 EN 61000-6-3, EN 61000-6-1, AS/NZS 4251.1, EN 61000-6-4, EN 61000-6-2, AS/NZS 4251.2, EN 61204-3, EN 50130-4, EN 62040-2, EN 50371, EN 50385, AS/NZS 4268, ETSI EN 300 386 ETSI EN 300 328, ETSI EN 301 489-1/-3/-9/-17 ETSI EN 301 893, ETSI EN 300 220-2/-1 ETSI EN 300 440-2/-1 ETSI EN 301 357-2/-1 RSS-310, RSS-210 Issue 7, RSS-Gen Issue 2	 
Taiwan	BSMI	CNS 13438, CNS 13783-1, CNS13439	 SL2-IN-E-0039 SL2-R1/R2-0039 SL2-A1-E-0039
Canada	Industry Canada	RSS210, Issue 7	

* No part of this report may be used to claim or imply product endorsement by TAF or any agency of the US Government.



6. CALIBRATION AND UNCERTAINTY

6.1 MEASURING INSTRUMENT CALIBRATION

The measuring equipment utilized to perform the tests documented in this report has been calibrated in accordance with the manufacturer's recommendations, and is traceable to recognized national standards.

6.2 MEASUREMENT UNCERTAINTY

The following table is for the measurement uncertainty, which is calculated as per the document CISPR 16-4.

PARAMETER	UNCERTAINTY
Semi Anechoic Chamber (966 Chamber) / Radiated Emission, 30 to 200 MHz	+/- 3.6878
Semi Anechoic Chamber (966 Chamber) / Radiated Emission, 200 to 1000 MHz	+/- 3.0885
Semi Anechoic Chamber (966 Chamber) / Radiated Emission, 1 to 26.5GHz	+/- 3.2000
Conducted Emission	+/- 1.7468

This uncertainty represents an expanded uncertainty expressed at approximately the 95% confidence level using a coverage factor of k=2.



7. SETUP OF EQUIPMENT UNDER TEST

SUPPORT EQUIPMENT

No.	Product	Manufacturer	Model No.	Serial No.	FCC ID
1	Notebook PC	DELL	Latitude D610	CN-0C4708-48643-625-5565	E2K24BNHM
2	Notebook PC	Lenovo ideaPad	S10e_4068-RZ1	L3CEV2D	HFS-FL
3	Mouse	KINYO	KM-770	0804	---

SETUP DIAGRAM FOR TESTS

EUT & peripherals setup diagram is shown in appendix setup photos.

EUT OPERATING CONDITION

RF Mode

1. Setup all computers like the setup diagram.
2. Run Blue Tool
3. Select the following settings,
Transport :HCI Control
UART :Com 2 /115200/CTS flow control
4. Select
 - (a) 7.3:Host Controller & Baseband Commands(3 key)→Reset/Write Scan Enable
 - (b) 7.4:Informational Parameters (4 key)→Read_BD_ADDR
 - (c) 0: Vendor-specific Commands (0 key)→Tx_Test/Rx_Test
5. TX mode (GFSK / 8-DPSK)
Hopping_Mode : Single frequency
Frequency : 2402, 2441, 2480
Modulation_Type : PRBS9 Patten
Logical_Channel : ACL Basic
BB_Packet_Type : DH5/3-DH5
BB_Packet_Length : 339/1021
Tx_Power_Level : 0dBm
6. All of the functions are under run.
7. Start test.

Normal Mode

1. Setup all computers like the setup diagram.
2. (1) Build up a connection between EUT and Notebook (play music).
(2) Charge mode.
3. All of the functions are under run.
4. Start test.



8. FCC PART 15.247 REQUIREMENTS

8.1 20dB BANDWIDTH FOR HOPPING

LIMITS

Limit : N/A

TEST EQUIPMENT

Name of Equipment	Manufacturer	Model	Serial Number	Calibration Due
Spectrum Analyzer	AGILENT	E4446A	MY43360132	06/09/2010
Spectrum Analyzer	AGILENT	E4446A	MY46180323	05/26/2010

Remark: Each piece of equipment is scheduled for calibration once a year.

TEST SETUP



TEST PROCEDURE

The 20dB band width was measured with a spectrum analyzer connected to RF antenna connector(conducted measurement) while EUT was operating in transmit mode at the appropriate center frequency. The analyzer center frequency was set to the EUT carrier frequency, using the analyzer. Display Line and Marker Delta functions, the 20dB band width of the emission was determined.



TEST RESULTS

Modulation Type: GFSK, CFG PKT Packet Type: 15 Packet Size: 339 (DH5)

Channel	Channel Frequency (MHz)	20dB Bandwidth (MHz)	Pass / Fail
Low	2402	0.885	N/A
Middle	2441	0.890	N/A
High	2480	0.885	N/A

Modulation Type: 8-DPSK, CFG PKT Packet Type: 31 Packet Size: 1021 (3-DH5)

Channel	Channel Frequency (MHz)	20dB Bandwidth (MHz)	Pass / Fail
Low	2402	1.255	N/A
Middle	2441	1.260	N/A
High	2480	1.260	N/A



20dB BANDWIDTH

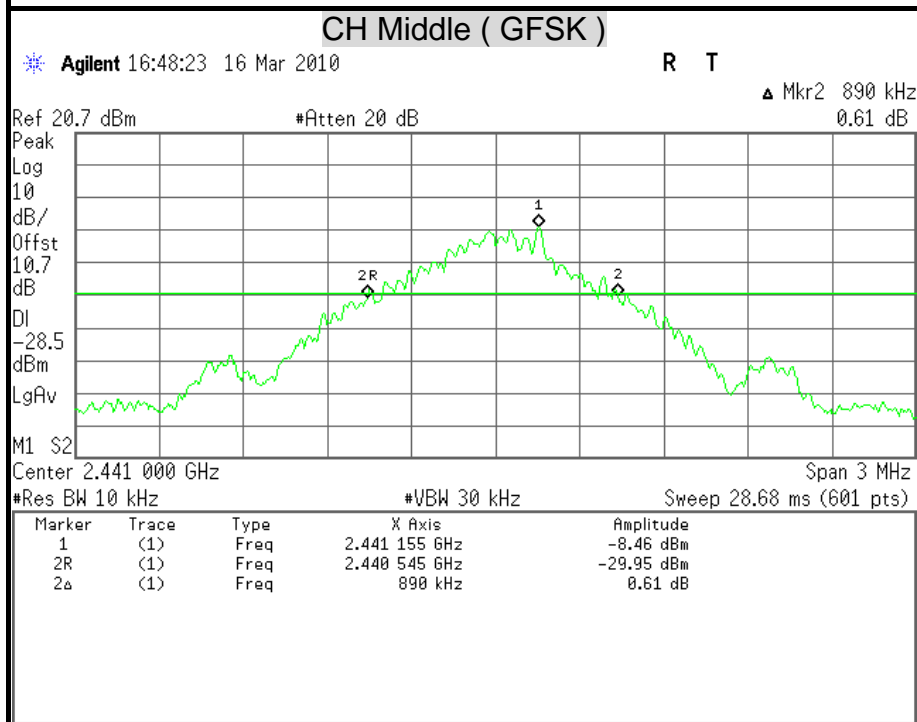
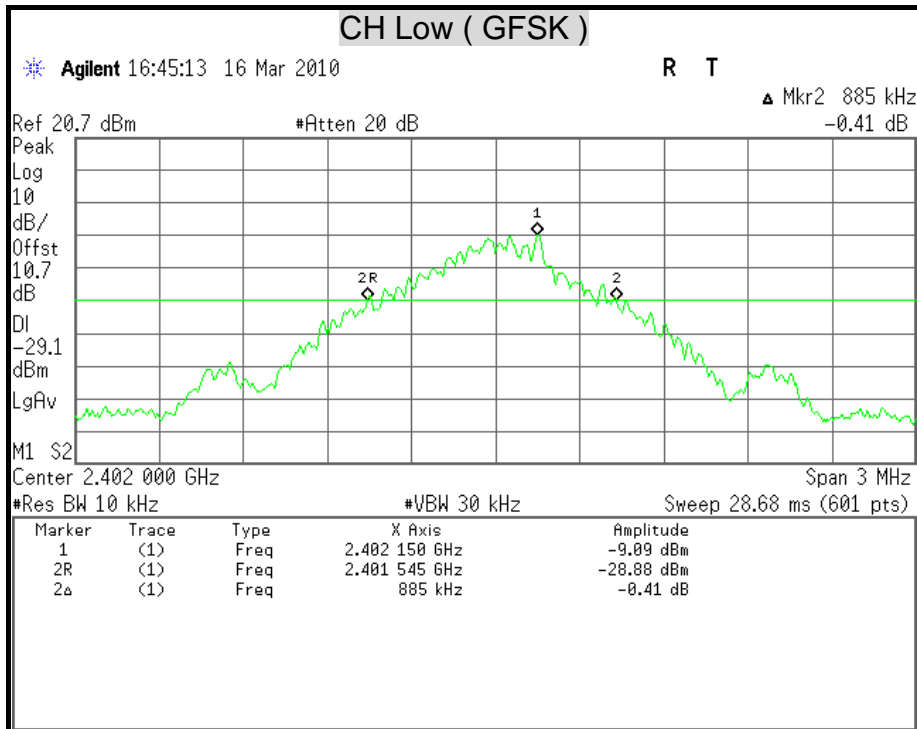

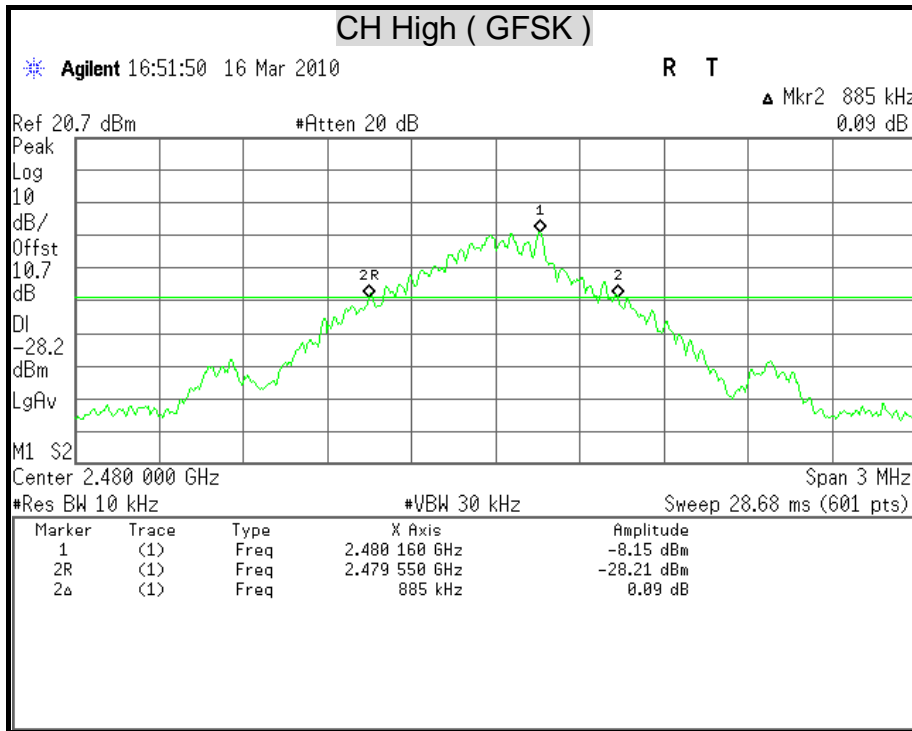

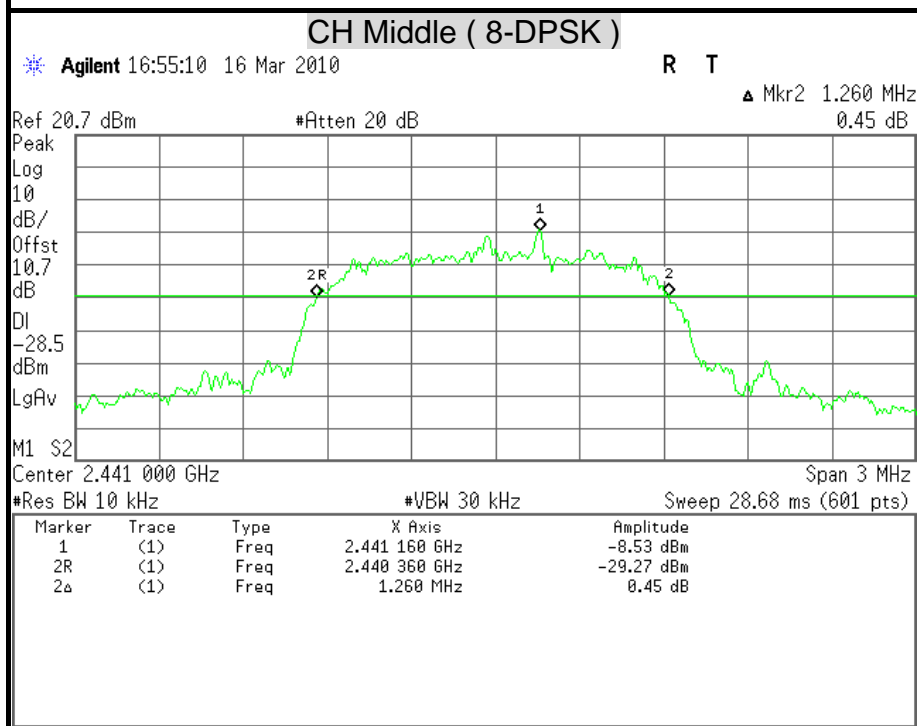
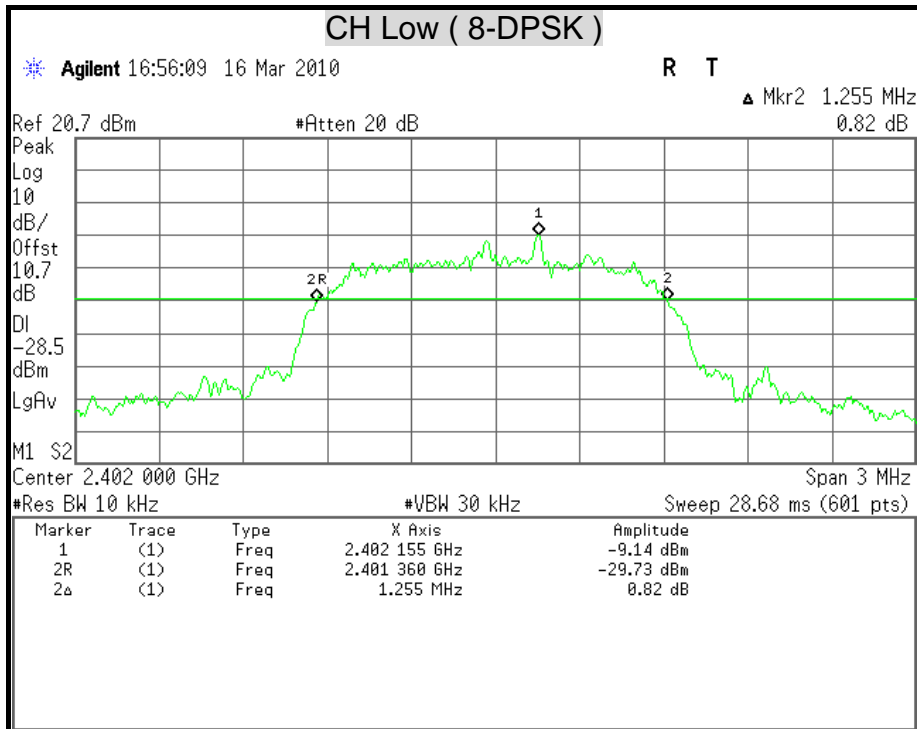

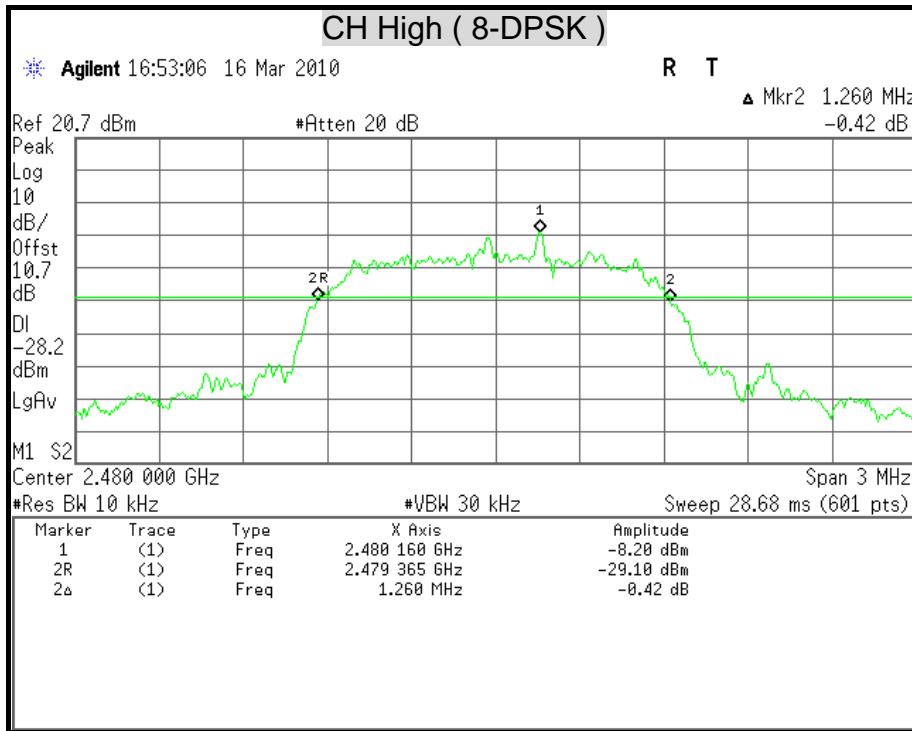



8.2 MAXIMUM PEAK OUTPUT POWER

LIMITS

§15.247(b)(1) For frequency hopping systems operating in the 2400-2483.5 MHz band employing at least 75 non-overlapping hopping channels, and all frequency hopping systems in the 5725-5850 MHz band: 1 watt. For all other frequency hopping systems in the 2400-2483.5 MHz band: 0.125 watts.

TEST EQUIPMENT

Name of Equipment	Manufacturer	Model	Serial Number	Calibration Due
Spectrum Analyzer	AGILENT	E4446A	MY43360132	06/09/2010
Spectrum Analyzer	AGILENT	E4446A	MY46180323	05/26/2010

Remark: Each piece of equipment is scheduled for calibration once a year.

TEST SETUP



TEST PROCEDURE

The RF power output was measured with a power meter connected to the RF Antenna connector (conducted measurement) while EUT was operating in transmit mode at the appropriate center frequency, A power meter was used to record the shape of the transmit signal.



TEST RESULTS

Modulation Type: GFSK ,CFG PKT Packet Type: 15 Packet Size: 339 (DH5)

Channel	Channel Frequency (MHz)	Peak Power		Peak Power Limit		Pass / Fail
		(dBm)	(W)	(dBm)	(W)	
Low	2402	-4.32	0.0004	20.97	0.125	PASS
Middle	2441	-2.38	0.0006	20.97	0.125	PASS
High	2480	-2.13	0.0006	20.97	0.125	PASS

Remark: The cable assembly insertion loss of 10.7dB (including 10 dB pad and 0.7 dB cable) was Entered as an offset in the spectrum analyzer to allow for direct reading of power.

Modulation Type: 8-DPSK ,CFG PKT Packet Type: 31 Packet Size: 1021 (3-DH5)

Channel	Channel Frequency (MHz)	Peak Power		Peak Power Limit		Pass / Fail
		(dBm)	(W)	(dBm)	(W)	
Low	2402	-0.48	0.0009	20.97	0.125	PASS
Middle	2441	-1.12	0.0008	20.97	0.125	PASS
High	2480	-0.87	0.0008	20.97	0.125	PASS

Remark: The cable assembly insertion loss of 10.7dB (including 10 dB pad and 0.7 dB cable) was Entered as an offset in the spectrum analyzer to allow for direct reading of power.



MAXIMUM PEAK OUTPUT POWER

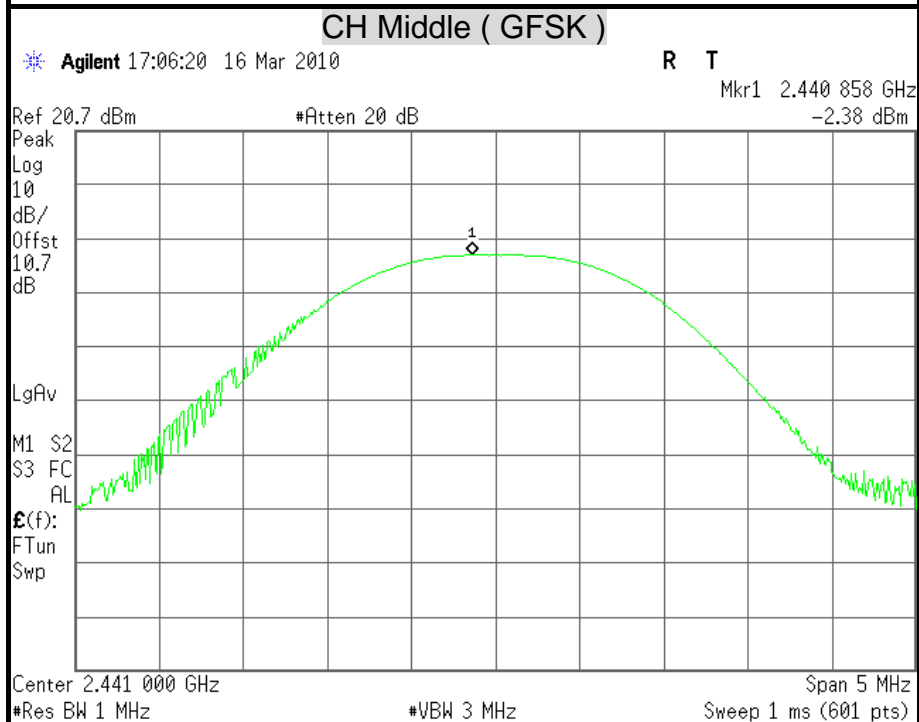
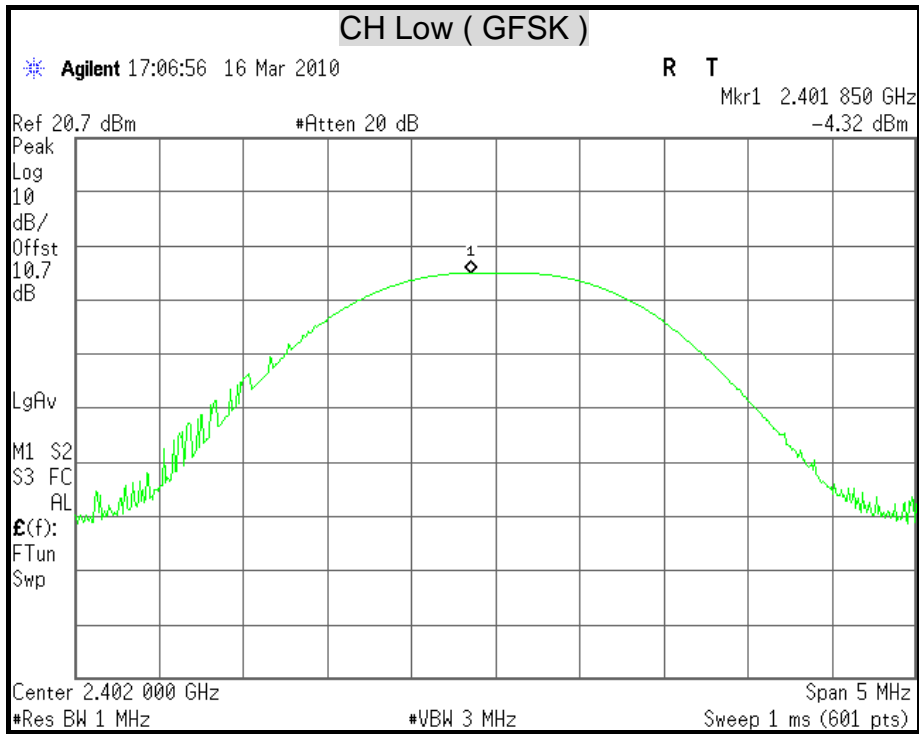

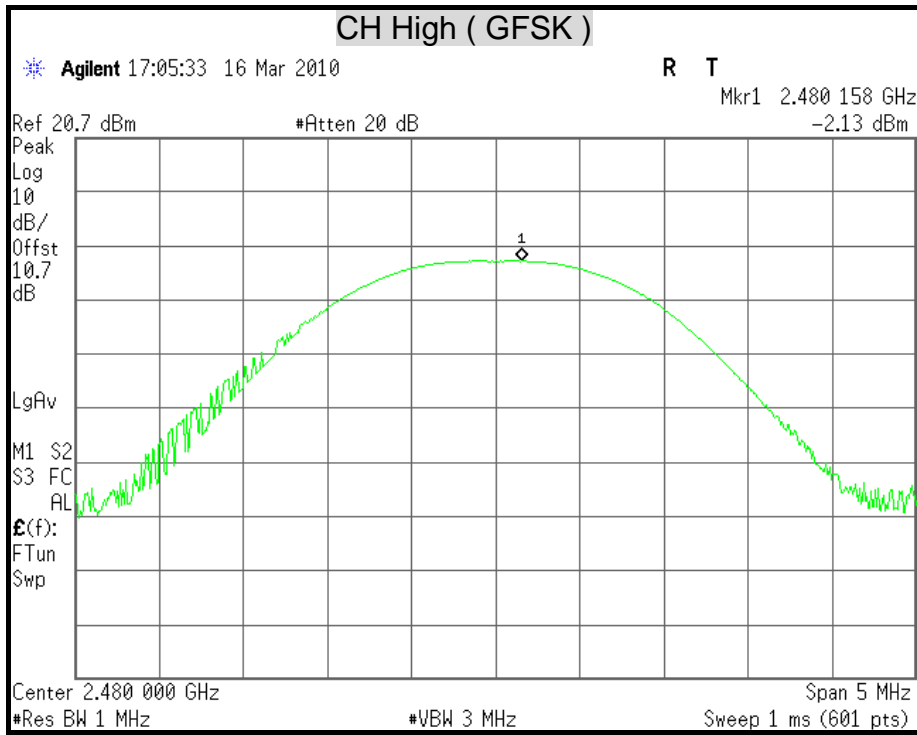

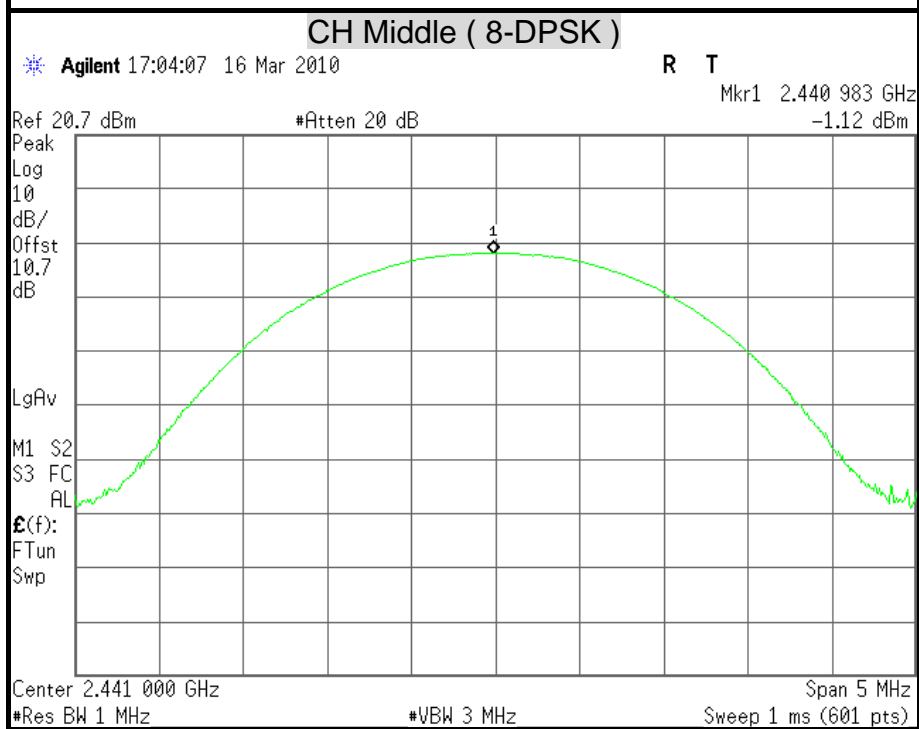
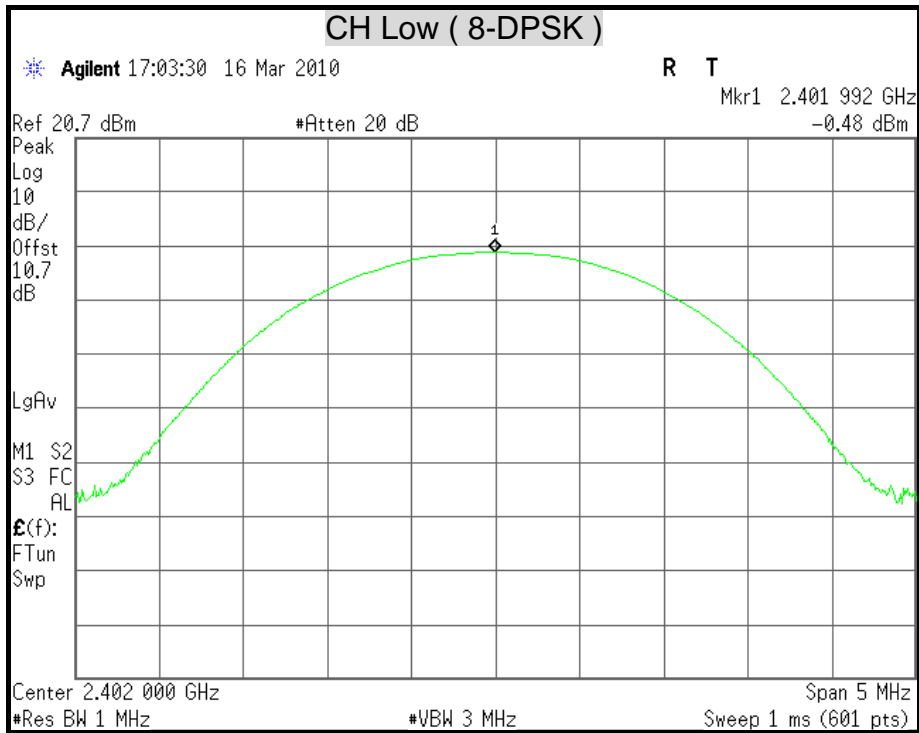

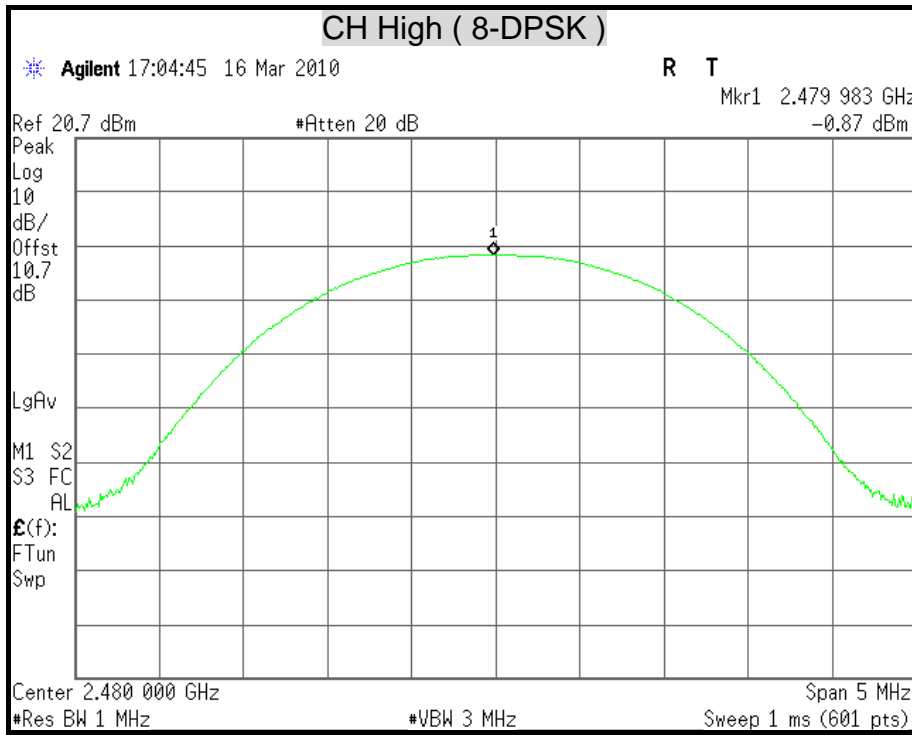

8.3 HOPPING CHANNEL SEPARATION

LIMITS

§15.247(a)(1) Frequency hopping systems shall have hopping channel carrier frequencies separated by a minimum of 25 kHz or the 20 dB bandwidth of the hopping channel, whichever is greater. Alternatively, frequency hopping systems operating in the 2400-2483.5 MHz band may have hopping channel carrier frequencies that are separated by 25 kHz or two-thirds of the 20 dB bandwidth of the hopping channel, whichever is greater, provided the systems operate with an output power no greater than 125 mW. The system shall hop to channel frequencies that are selected at the system hopping rate from a pseudorandomly ordered list of hopping frequencies. Each frequency must be used equally on the average by each transmitter. The system receivers shall have input bandwidths that match the hopping channel bandwidths of their corresponding transmitters and shall shift frequencies in synchronization with the transmitted signals.

TEST EQUIPMENT

Name of Equipment	Manufacturer	Model	Serial Number	Calibration Due
Spectrum Analyzer	AGILENT	E4446A	MY43360132	06/09/2010
Spectrum Analyzer	AGILENT	E4446A	MY46180323	05/26/2010

Remark: Each piece of equipment is scheduled for calibration once a year.

TEST SETUP



TEST PROCEDURE

1. Check the calibration of the measuring instrument using either an internal calibrator or a known signal from an external generator.
2. Position the EUT as shown in test setup without connection to measurement instrument. Turn on the EUT and connect it to measurement instrument. Then set it to any one convenient frequency within its operating range.
3. By using the MaxHold function record the separation of adjacent channels.
4. Measure the frequency difference of these two adjacent channels by spectrum analyzer MARK function. And then plot the result on spectrum analyzer screen.
5. Repeat above procedures until all frequencies measured were complete.



TEST RESULTS

Refer to section 8.1, 20dB bandwidth measurement, the measured channel separation should be greater than two-third of 20dB bandwidth or Minimum bandwidth.

Modulation Type: GFSK, CFG PKT Packet Type: 15 Packet Size: 339 (DH5)

Channel	Adjacent Hopping Channel Separation (kHz)	Two –third of 20dB bandwidth (kHz)	Minimum Bandwidth	Pass / Fail
2441MHz (Middle)	1000	593.33	25 kHz	PASS

Modulation Type: 8-DPSK, CFG PKT Packet Type: 31 Packet Size: 1021 (3-DH5)

Channel	Adjacent Hopping Channel Separation (kHz)	Two –third of 20dB bandwidth (kHz)	Minimum Bandwidth	Pass / Fail
2441MHz (Middle)	1000	839.99	25 kHz	PASS



HOPPING CHANNEL SEPARATION

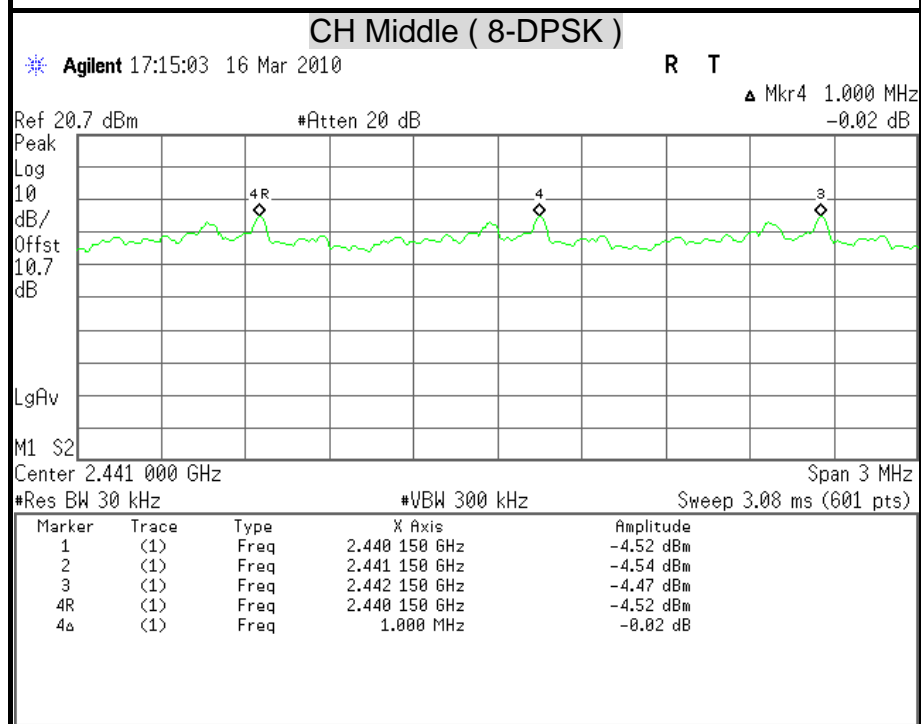
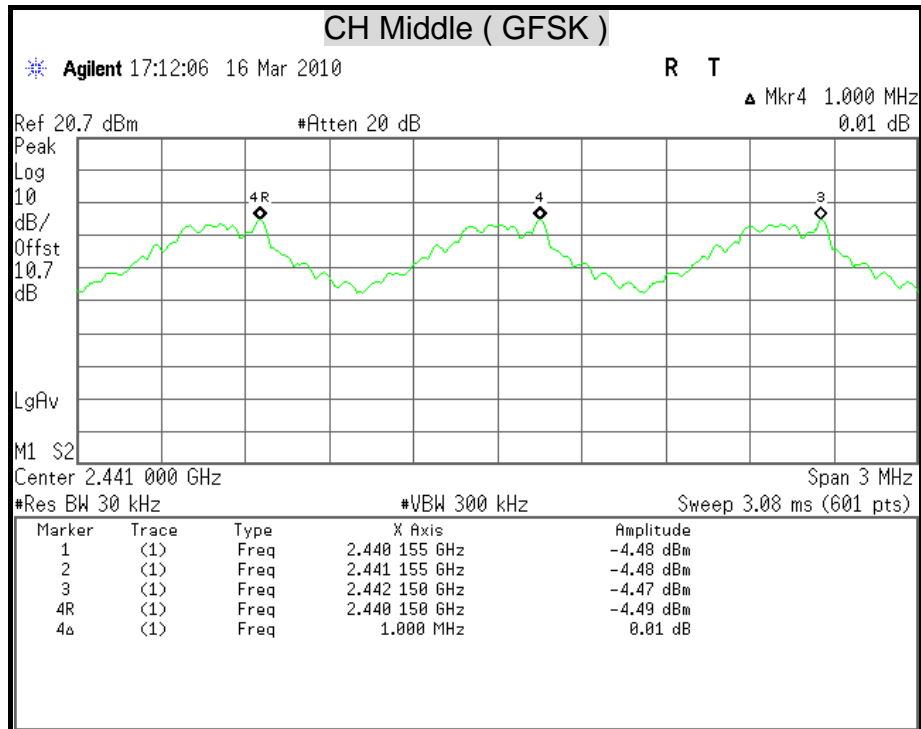



8.4 NUMBER OF HOPPING FREQUENCY USED

LIMITS

§15.247(a)(1)(iii) For frequency hopping systems in the 2400-2483.5 MHz band shall use at least 15 channels.

TEST EQUIPMENT

Name of Equipment	Manufacturer	Model	Serial Number	Calibration Due
Spectrum Analyzer	AGILENT	E4446A	MY43360132	06/09/2010
Spectrum Analyzer	AGILENT	E4446A	MY46180323	05/26/2010

Remark: Each piece of equipment is scheduled for calibration once a year.

TEST SETUP

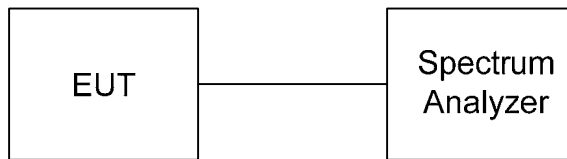

TEST PROCEDURE

1. Check the calibration of the measuring instrument (spectrum analyzer) using either an internal calibrator or a known signal from an external generator.
2. Position the EUT as shown in test setup without connection to measurement instrument. Turn on the EUT and connect its antenna terminal to measurement instrument via a low loss cable. Then set it to any one measured frequency within its operating range and make sure the instrument is operated in its linear range.
3. Set the spectrum analyzer on MaxHold Mode, and then keep the EUT in hopping mode. Record all the signals from each channel until each one has been recorded.
4. Set the spectrum analyzer on View mode and then plot the result on spectrum analyzer screen.
5. Repeat above procedures until all frequencies measured were complete.

TEST RESULTS

Refer to the attached plot.
There are 79 hopping frequencies in a hopping sequence.



NUMBER OF HOPPING FREQUENCY USED

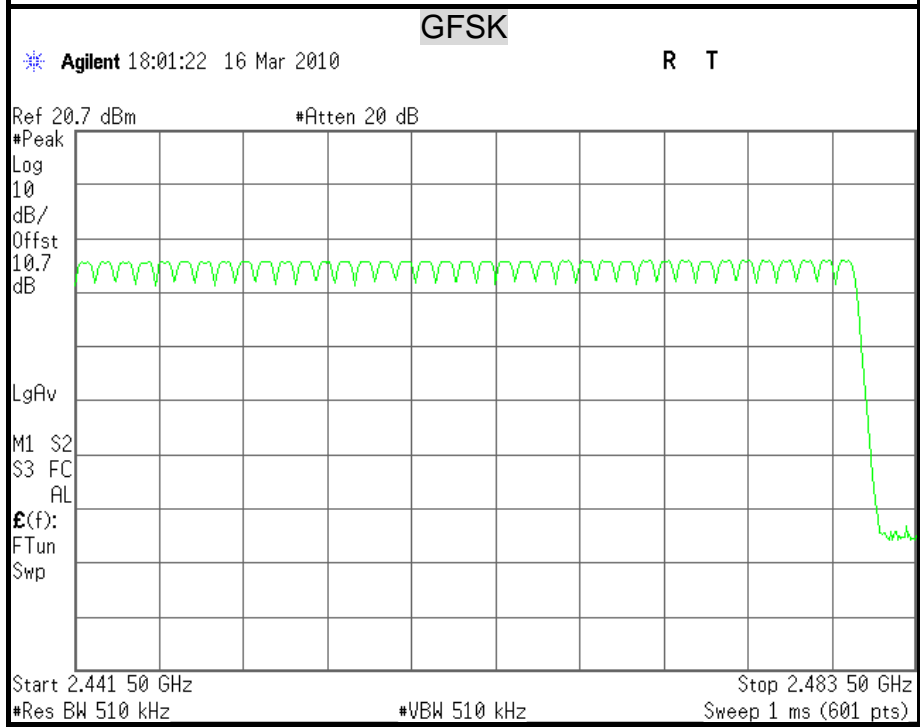
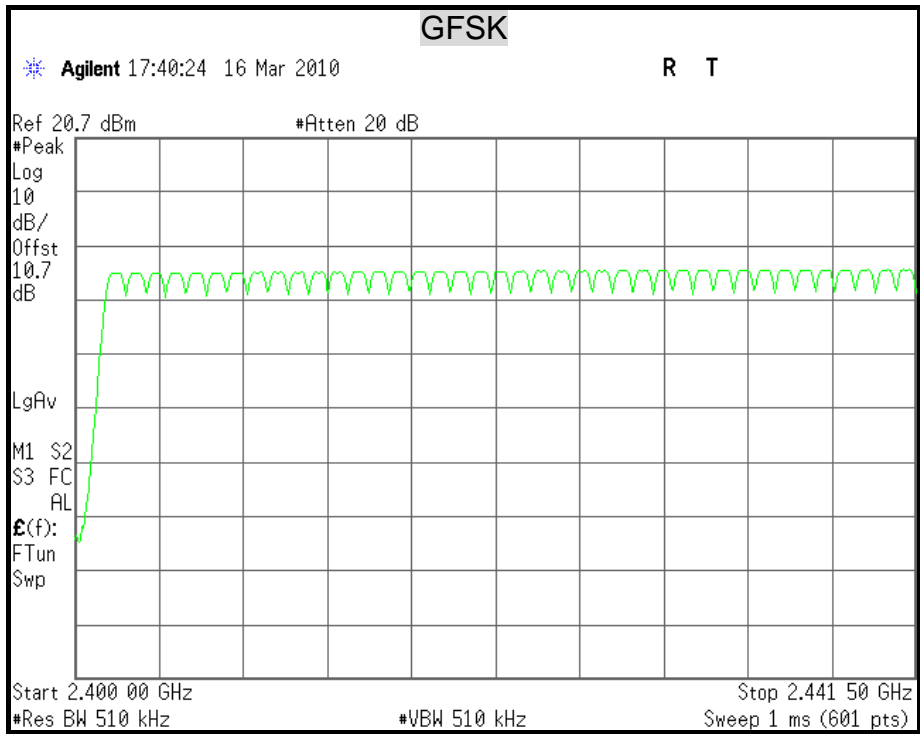

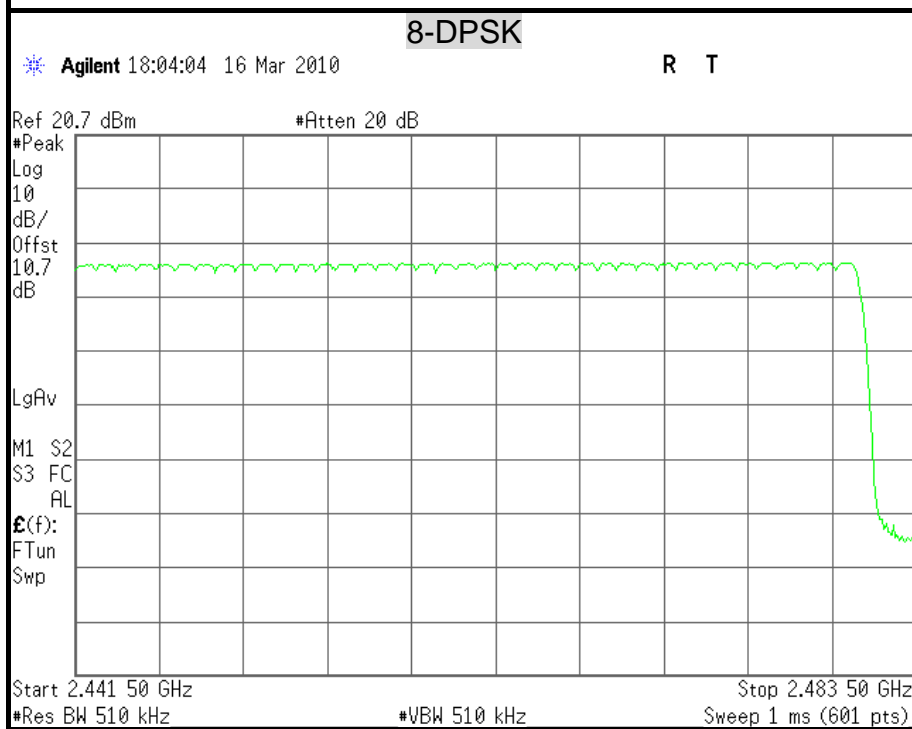
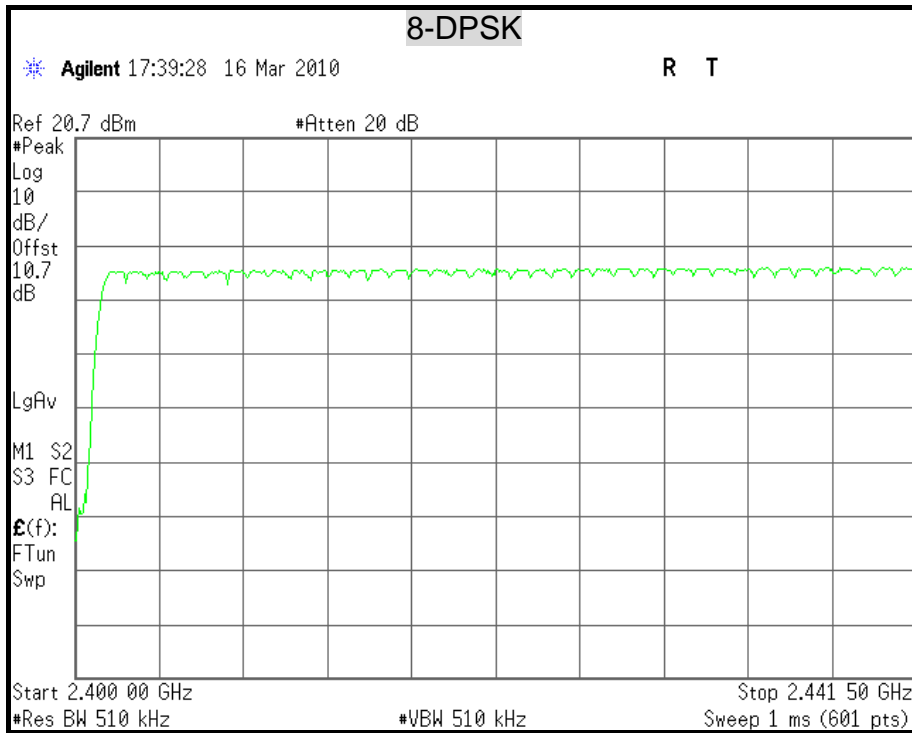



8.5 DWELL TIME ON EACH CHANNEL

LIMITS

§15.247(a)(1)(iii) For frequency hopping system operating in the 2400-2483.5MHz band, the average time of occupancy on any frequency shall not be greater than 0.4 second within a 31.6 second period.

TEST EQUIPMENT

Name of Equipment	Manufacturer	Model	Serial Number	Calibration Due
Spectrum Analyzer	AGILENT	E4446A	MY43360132	06/09/2010
Spectrum Analyzer	AGILENT	E4446A	MY46180323	05/26/2010

Remark: Each piece of equipment is scheduled for calibration once a year.

TEST SETUP

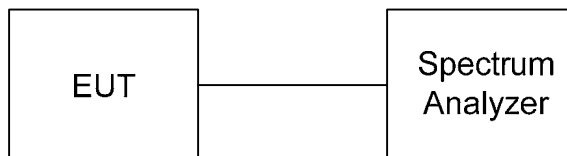

TEST PROCEDURE

1. Check the calibration of the measuring instrument using either an internal calibrator or a known signal from an external generator.
2. Position the EUT as shown in test setup without connection to measurement instrument. Turn on the EUT and connect its antenna terminal to measurement instrument via a low loss cable. Then set it to any one measured frequency within its operating range and make sure the instrument is operated in its linear range.
3. Adjust the center frequency of spectrum analyzer on any frequency be measured and set spectrum analyzer to zero span mode. And then, set RBW and VBW of spectrum analyzer to proper value.
4. Measure the time duration of one transmission on the measured frequency. And then plot the result with time difference of this time duration.
5. Repeat above procedures until all frequencies measured were complete.
6. The Bluetooth Headset has 3 type of payload, DH1, DH3, DH5. The hopping rate is 1600 per second.
The longer the payload is, the slower the hopping rate is.



TEST RESULTS

Time of occupancy on the TX channel in 31.6sec = time domain slot length x hop rate ÷ number of hop per channel x 31.6

Refer to the attached graph.

The hopping rates of Bluetooth devices change with different types of payload. The longer the payload is, the slower the hopping rate. The hopping rate scenario is defined in Bluetooth core specification.

Modulation Type: GFSK, CFG PKT Packet Type: 15 Packet Size: 339 (DH5)

Transmitting Frequency	Packet type	Dwell time (ms)	Time of occupancy on the TX channel in 31.6sec (ms)	Limit for Time of occupancy on the TX channel in 31.6sec (ms)	Results
2441MHz	DH1	0.383	122.56	400	PASS
2441MHz	DH3	1.650	264.00	400	PASS
2441MHz	DH5	2.883	307.52	400	PASS

DH1 Dwell time = 0.383 ms x (1600÷2) ÷ 79 x 31.6 = 122.56 (ms)

DH3 Dwell time = 1.650 ms x (1600÷4) ÷ 79 x 31.6 = 264.00 (ms)

DH5 Dwell time = 2.883 ms x (1600÷6) ÷ 79 x 31.6 = 307.52 (ms)

Modulation Type: 8-DPSK, CFG PKT Packet Type: 31 Packet Size: 1021 (3-DH5)

Transmitting Frequency	Packet type	Dwell time (ms)	Time of occupancy on the TX channel in 31.6sec (ms)	Limit for Time of occupancy on the TX channel in 31.6sec (ms)	Results
2441MHz	DH1	0.400	128.00	400	PASS
2441MHz	DH3	1.633	261.28	400	PASS
2441MHz	DH5	2.900	309.33	400	PASS

DH1 Dwell time = 0.400ms x (1600÷2) ÷ 79 x 31.6 = 128.00 (ms)

DH3 Dwell time = 1.633ms x (1600÷4) ÷ 79 x 31.6 = 261.28 (ms)

DH5 Dwell time = 2.900ms x (1600÷6) ÷ 79 x 31.6 = 309.33 (ms)



DWELL TIME ON EACH PAYLOAD

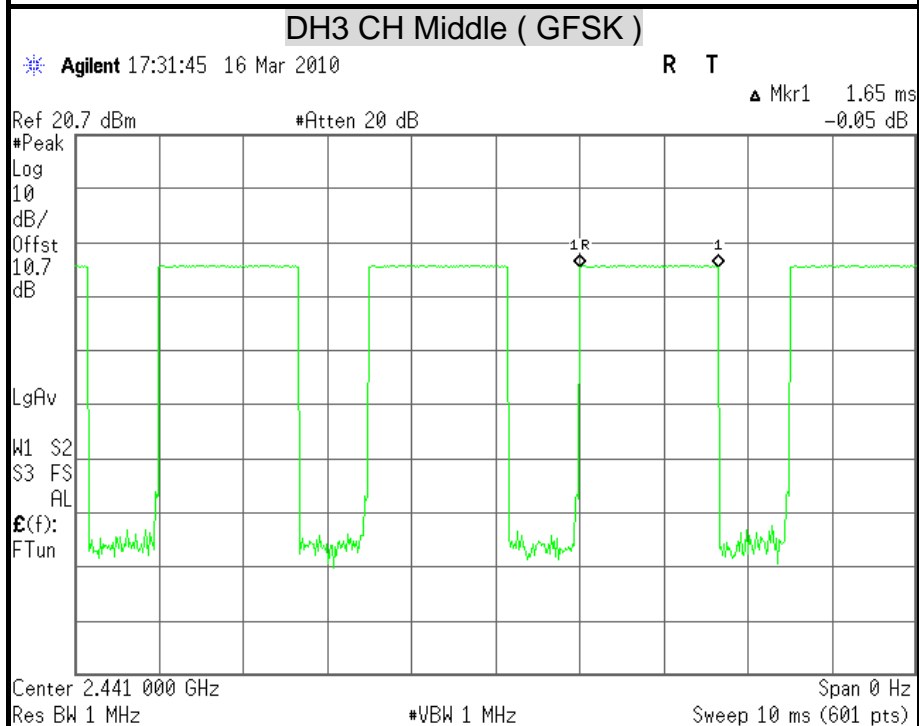
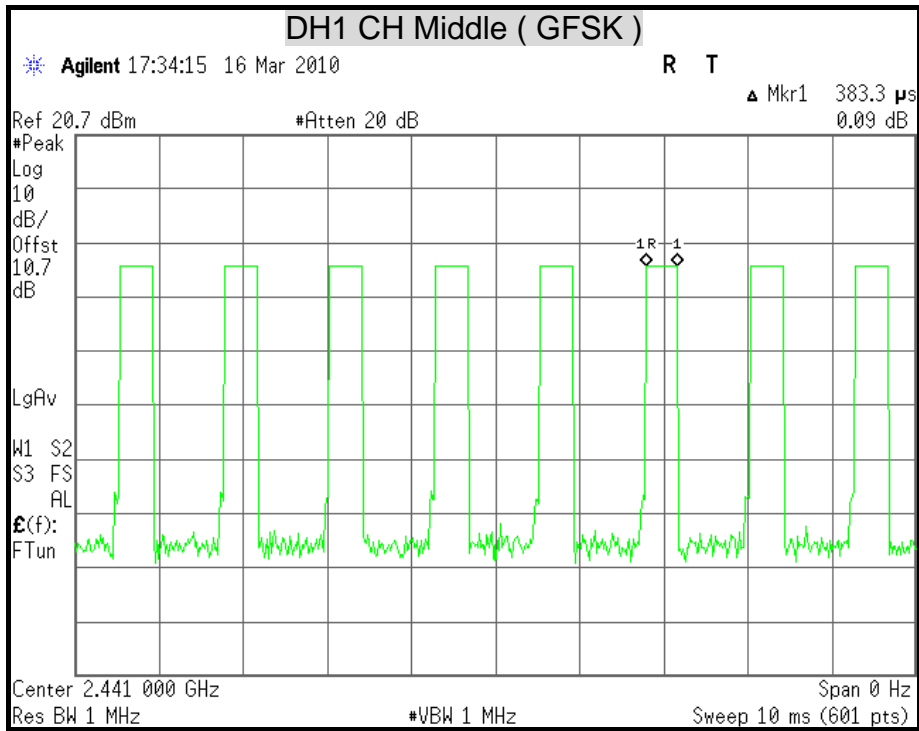

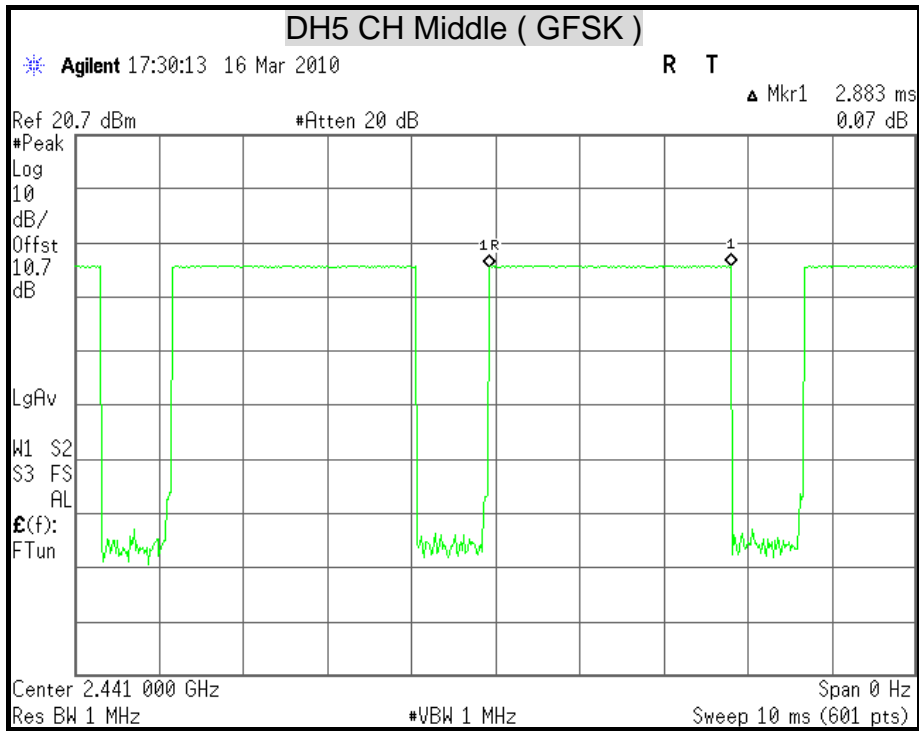

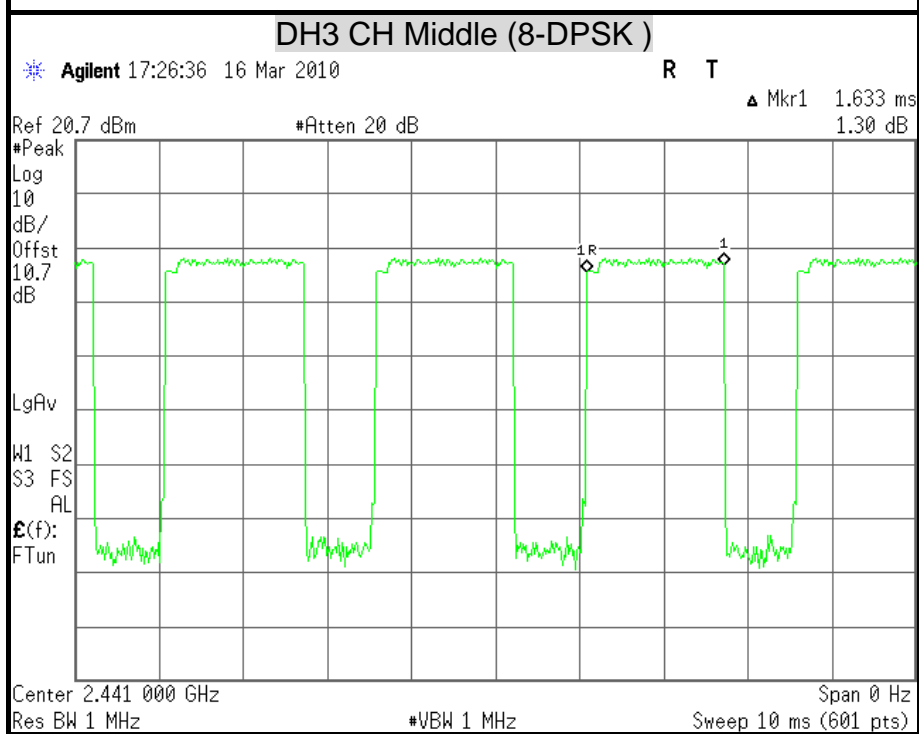
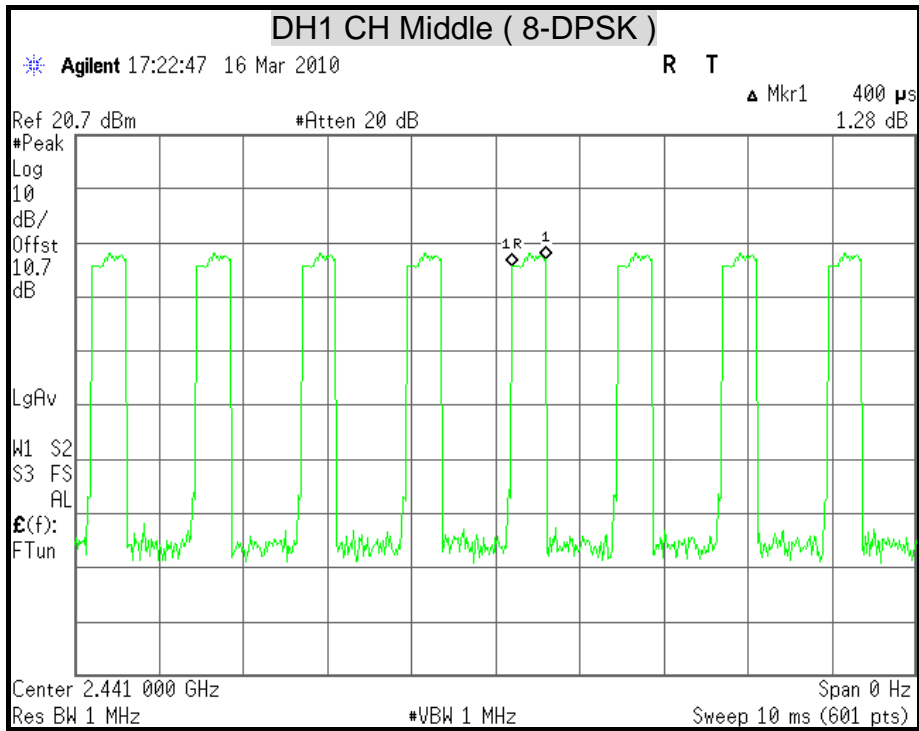

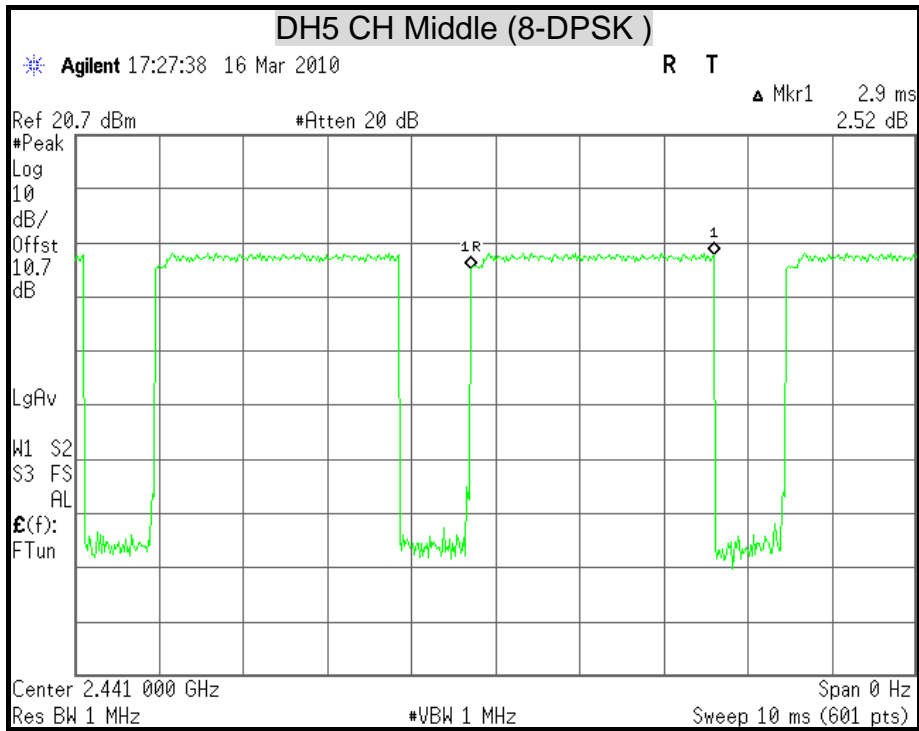



8.6 CONDUCTED SPURIOUS EMISSION

LIMITS

§ 15.247(d) In any 100 kHz bandwidth outside the frequency band in which the spread spectrum intentional radiator is operating, the radio frequency power that is produced by the intentional radiator shall be at least 20 dB below that in the 100 kHz bandwidth within the and that contains the highest level of the desired power, based on either an RF conducted or a radiated measurement. Attenuation below the general limits specified in § 15.209(a) is not required. In addition, radiated emissions which fall in the restricted bands, as defined in § 15.205(a), must also comply with the radiated emission limits specified in § 15.209(a) (see § 15.205(c)).

TEST EQUIPMENT

Name of Equipment	Manufacturer	Model	Serial Number	Calibration Due
Spectrum Analyzer	AGILENT	E4446A	MY43360132	06/09/2010
Spectrum Analyzer	AGILENT	E4446A	MY46180323	05/26/2010

Remark: Each piece of equipment is scheduled for calibration once a year.

TEST SETUP

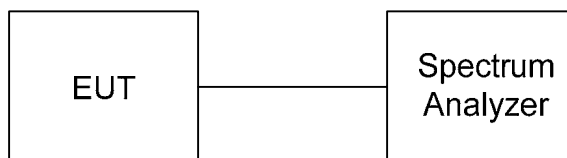

TEST PROCEDURE

The transmitter output is connected to a spectrum analyzer. The resolution bandwidth is set to 100 kHz. The video bandwidth is set to 100 kHz.

The spectrum from 30 MHz to 26.5 GHz is investigated with the transmitter set to the lowest, middle, and highest channels in the 2.4 GHz band.



TEST RESULTS

OUT-OF-BAND SPURIOUS EMISSIONS-CONDUCTED MEASUREMENT

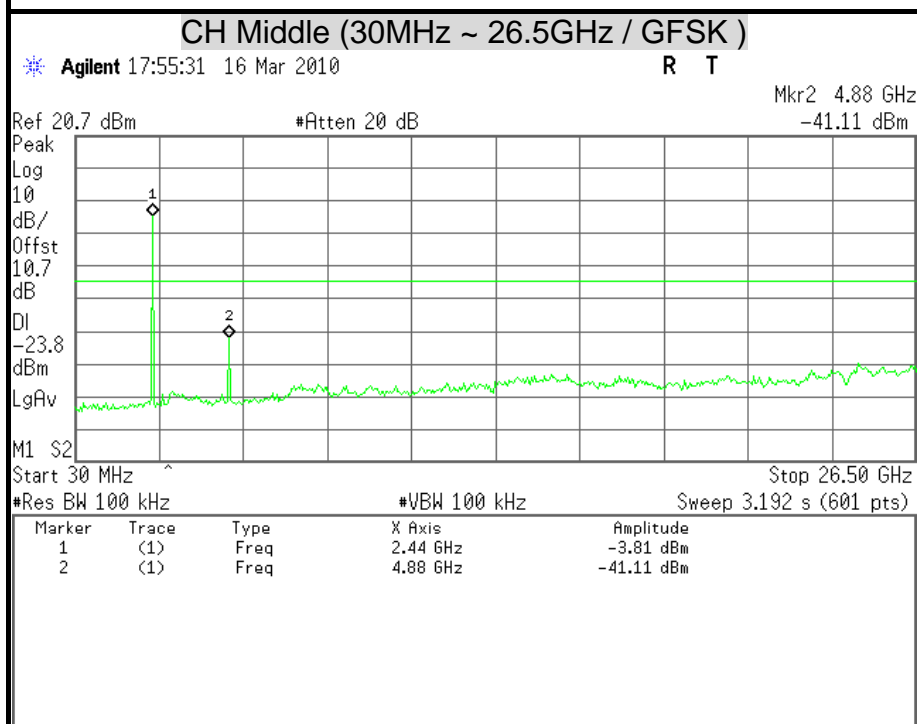
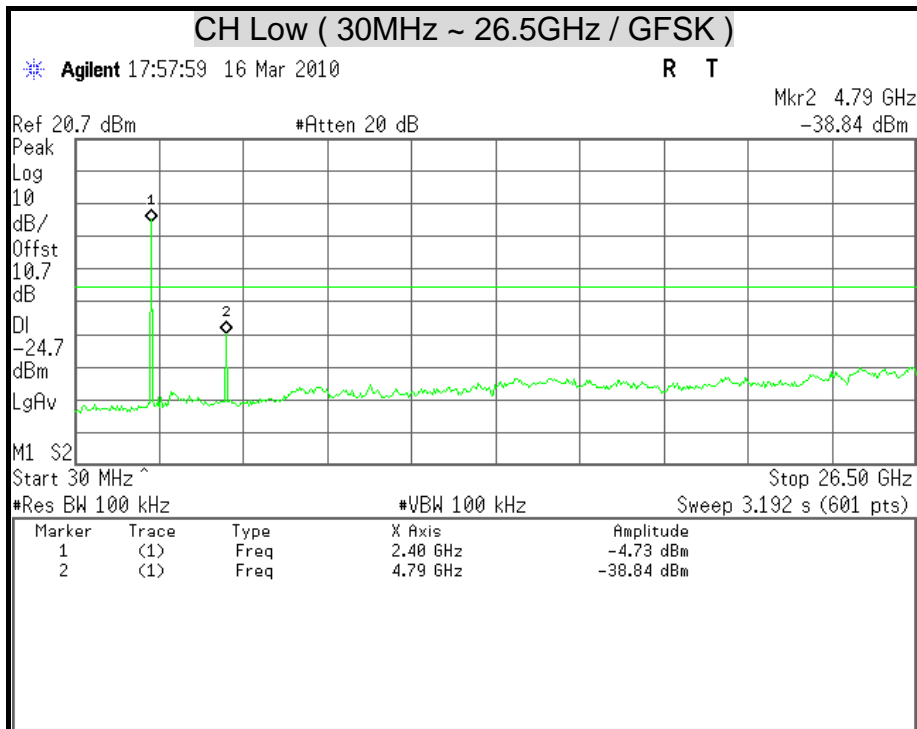

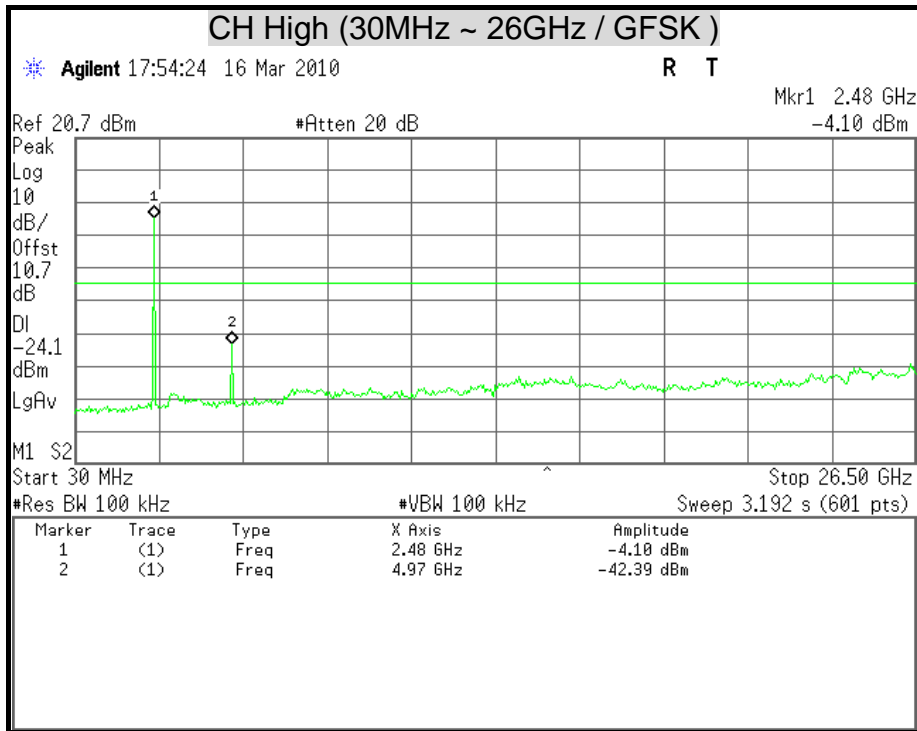

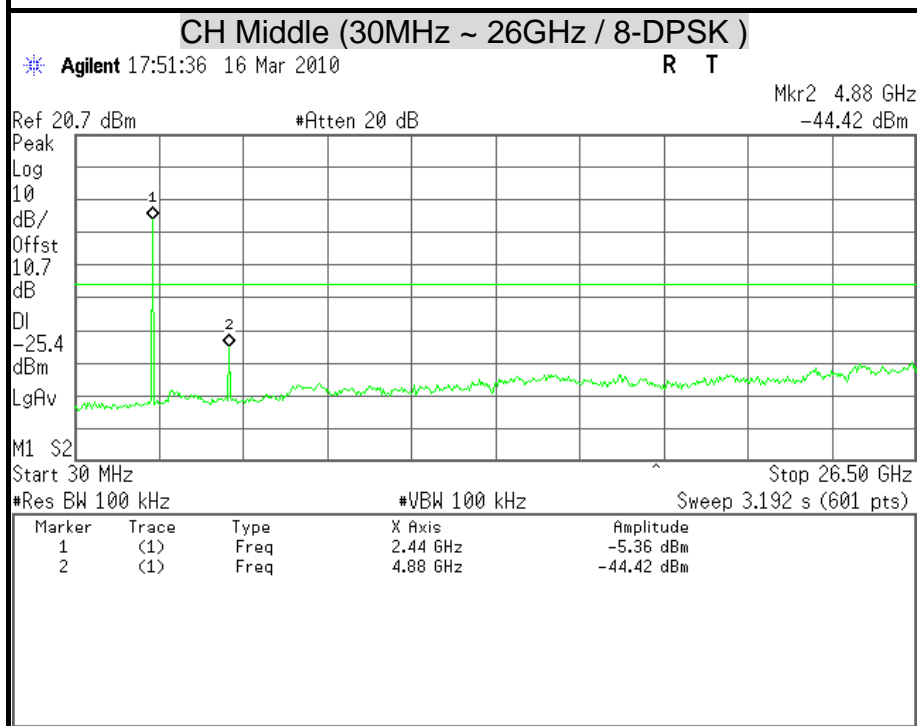
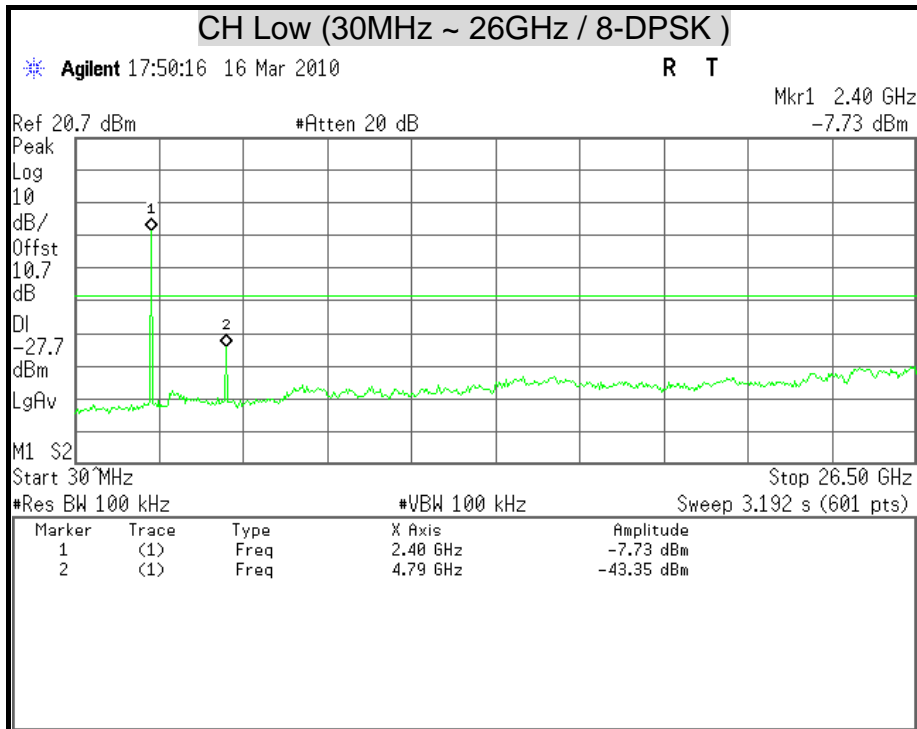

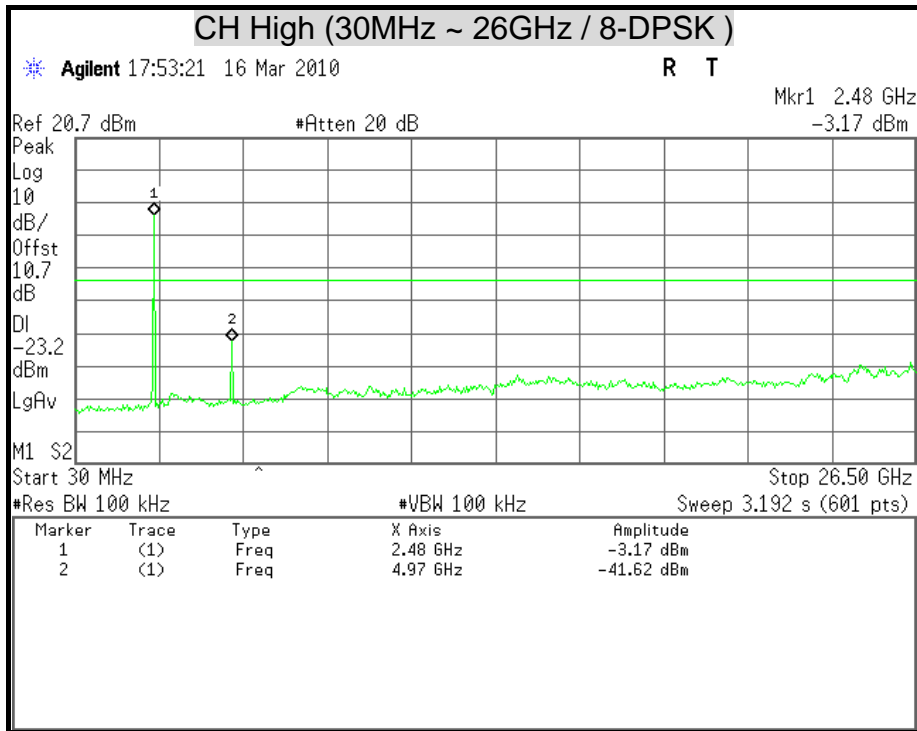



8.7 RADIATED EMISSION

LIMITS

(1) § 15.205 (a) Except as shown in paragraph (d) of this section, only spurious emissions are permitted in any of the frequency bands listed below:

MHz	MHz	MHz	GHz
0.090 - 0.110	16.42 - 16.423	399.9 - 410	4.5 - 5.15
¹ 0.495 - 0.505	16.69475 - 16.69525	608 - 614	5.35 - 5.46
2.1735 - 2.1905	16.80425 - 16.80475	960 - 1240	7.25 - 7.75
4.125 - 4.128	25.5 - 25.67	1300 - 1427	8.025 - 8.5
4.17725 - 4.17775	37.5 - 38.25	1435 - 1626.5	9.0 - 9.2
4.20725 - 4.20775	73 - 74.6	1645.5 - 1646.5	9.3 - 9.5
6.215 - 6.218	74.8 - 75.2	1660 -1710	10.6 -12.7
6.26775 - 6.26825	108 -121.94	1718.8 - 1722.2	13.25 -13.4
6.31175 - 6.31225	123 - 138	2200 - 2300	14.47 – 14.5
8.291 - 8.294	149.9 - 150.05	2310 - 2390	15.35 -16.2
8.362 - 8.366	156.52475 - 156.52525	2483.5 - 2500	17.7 - 21.4
8.37625 - 8.38675	156.7 - 156.9	2655 - 2900	22.01 - 23.12
8.41425 - 8.41475	162.0125 - 167.17	3260 - 3267	23.6 - 24.0
12.29 - 12.293	167.72 - 173.2	3332 - 3339	31.2 - 31.8
12.51975 - 12.52025	240 - 285	3345.8 - 3338	36.43 - 36.5
12.57675 - 12.57725	322 -335.4	3600 - 4400	(²)
13.36 - 13.41			

Remark:

1. ¹ Until February 1, 1999, this restricted band shall be 0.490-0.510 MHz.
2. ² Above 38.6

(2) § 15.205 (b) Except as provided in paragraphs (d) and (e), the field strength of emissions appearing within these frequency bands shall not exceed the limits shown in Section 15.209. At frequencies equal to or less than 1000 MHz, compliance with the limits in Section 15.209 shall be demonstrated using measurement instrumentation employing a CISPR quasi-peak detector. Above 1000 MHz, compliance with the emission limits in Section 15.209 shall be demonstrated based on the average value of the measured emissions. The provisions in Section 15.35 apply to these measurements.



(3) According to § 15.209 (a) Except as provided elsewhere in this Subpart, the emissions from an intentional radiator shall not exceed the field strength levels specified in the following table :

Frequency (MHz)	Field Strength (microvolts/meter)	Measurement Distance (meters)
0.009 – 0.490	2400/F(KHz)	300
0.490 – 1.705	24000/F(KHz)	30
1.705 – 30.0	30	30
30 - 88	100 **	3
88 - 216	150 **	3
216 - 960	200 **	3
Above 960	500	3

Remark: **Except as provided in paragraph (g), fundamental emissions from intentional radiators operating under this Section shall not be located in the frequency bands 54-72 MHz, 76-88 MHz, 174-216 MHz or 470-806 MHz. However, operation within these frequency bands is permitted under other sections of this Part, e.g., Sections 15.231 and 15.241.

(4) According to § 15.209 (b) In the emission table above, the tighter limit applies at the band edges.

TEST EQUIPMENT

966Chamber_A

Name of Equipment	Manufacture	Model	Serial Number	Calibration Due
Spectrum Analyzer	Agilent	E4446A	MY43360132	06/09/2010
EMI Test Receiver	ROHDE & SCHWARZ	ESCI	100221	05/17/2010
Bilog Antenna	SCHWARZBECK	VULB 9168	9168-249	11/12/2010
Double-Ridged Waveguide Horn	ETS LINDGREN	3117	00078732	06/30/2010
Pre-Amplifier	Agilent	8449B	3008A01471	08/02/2010
Pre-Amplifier	HP	8447F	2944A03748	09/24/2010
RF Coaxial Cable	HUBER-SUHNER	SUCOFLEX 104PEA	SN31347	07/21/2010
RF Coaxial Cable	HUBER-SUHNER	SUCOFLEX 104PEA	SN31350	07/21/2010
RF Coaxial Cable	HUBER-SUHNER	SUCOFLEX 104PEA	SN31355	07/21/2010
LOOP ANTENNA	EMCO	6502	2356	05/28/2010
Notch Filters Band Reject	Micro-Tronics	BRM05702-01	009	N.C.R

Remark: 1. Each piece of equipment is scheduled for calibration once a year.
2. N.C.R = No Calibration Request.

966Chamber_B

Name of Equipment	Manufacture	Model	Serial Number	Calibration Due
Spectrum Analyzer	AGILENT	E4447B	US41443108	08/09/2010
EMI Receiver	ROHDE & SCHWARZ	ESCS 30	826547/004	08/05/2010
Broadband Hybrid Bi-Log Antenna	Sunol Sciences	JB1	A100209-4	10/08/2010
Broad-Band Horn Antenna	SCHWARZBECK	BBHA 9120 D	9120D-778	09/23/2010
Double-Ridged Waveguide Horn	ETS-LINDGREN	3117	00078733	12/17/2010
Pre-Amplifier	Miteq	AM-1652-3000	1490937	10/14/2010
Pre-Amplifier	Miteq	AFS44-001026 50-42-10P-44	1494026	10/19/2010
RF Coaxial Cable	HUBER-SUHNER	SUCOFLEX 104PEA	SN31346	10/14/2010
RF Coaxial Cable	HUBER-SUHNER	SUCOFLEX 104PEA	SN33957	10/20/2010
RF Coaxial Cable	HUBER-SUHNER	SUCOFLEX 104PEA	SN33958	10/20/2010
Notch Filters Band Reject	Micro-Tronics	BRM05702-01	026	N.C.R

Remark: 1. Each piece of equipment is scheduled for calibration once a year.
 2. N.C.R = No Calibration Request.

TEST SETUP

The diagram below shows the test setup that is utilized to make the measurements for emission from below 1GHz.

9kHz ~ 30MHz

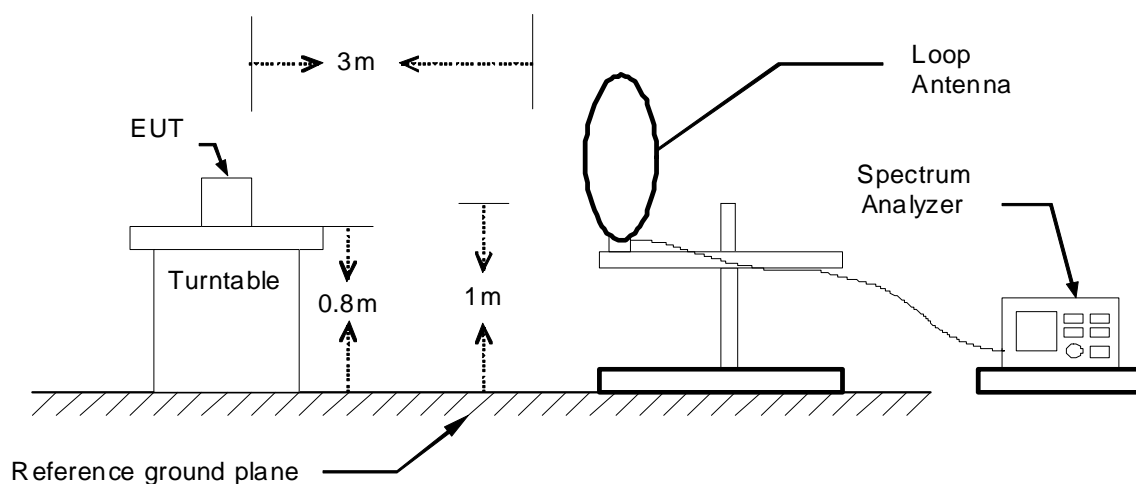

30MHz ~ 1GHz

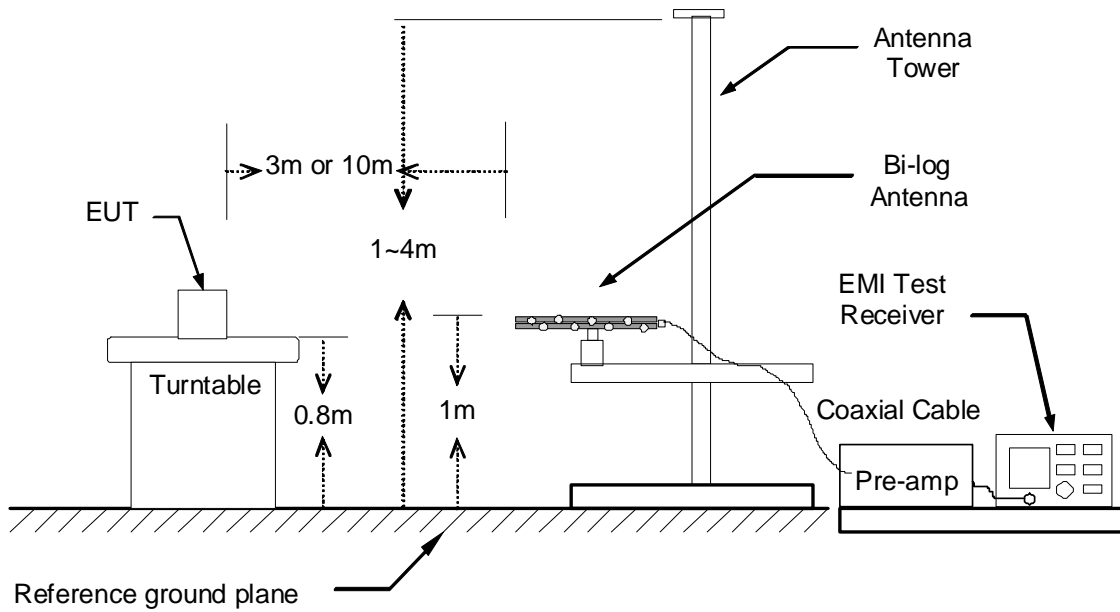

The diagram below shows the test setup that is utilized to make the measurements for emission above 1GHz.

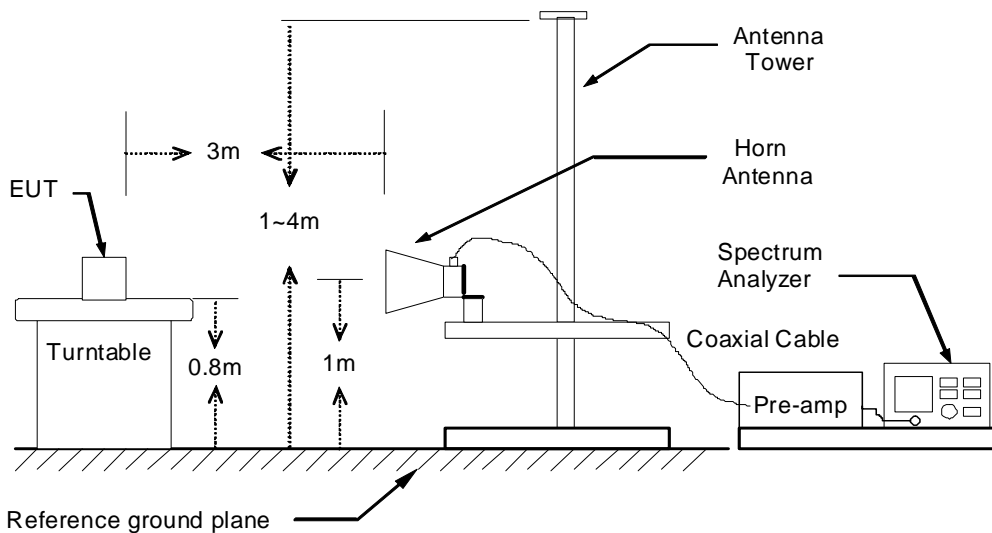



TEST PROCEDURE

1. The EUT was placed on the top of a rotating table 0.8 meters above the ground at a 10 meter open area test site. The table was rotated 360 degrees to determine the position of the highest radiation.
2. While measuring the radiated emission below 1GHz, the EUT was set 3 meters away from the interference-receiving antenna, which was mounted on the top of a variable-height antenna tower. While measuring the radiated emission above 1GHz, the EUT was set 3 meters away from the interference-receiving antenna
3. The antenna is a broadband antenna, and its height is varied from one meter to four meters above the ground to determine the maximum value of the field strength. Both horizontal and vertical polarization of the antenna are set to make the measurement.
4. For each suspected emission, the EUT was arranged to its worst case and then the antenna was tuned to heights from 1 meter to 4 meters and the table was turned from 0 degrees to 360 degrees to find the maximum reading.
5. The test-receiver system was set to Peak Detect Function and Specified Bandwidth with Maximum Hold Mode.
6. If the emission level of the EUT in peak mode was 10 dB lower than the limit specified, then testing could be stopped and the peak values of the EUT would be reported. Otherwise the emissions that did not have 10 dB margin would be re-tested one by one using peak, quasi-peak or average method as specified and then reported in a data sheet.

Remark :

1. *The resolution bandwidth and video bandwidth of test receiver/spectrum analyzer is 120 KHz for Peak detection (PK) and Quasi-peak detection (QP) at frequency below 1GHz.*
2. *The resolution bandwidth and video bandwidth of test receiver/spectrum analyzer is 1 MHz for Peak detection and frequency above 1GHz.*
3. *The resolution bandwidth of test receiver/spectrum analyzer is 1 MHz and the video bandwidth is 10 Hz for Average detection (AV) at frequency above 1GHz.*



TEST RESULTS

Below 1 GHz (9kHz ~ 30MHz)

No emission found between lowest internal used/generated frequency to 30MHz.

Below 1 GHz (30MHz ~ 1GHz)

Product Name	Universal Bluetooth Headset	Test By	Rick Lin
Model	HK201	Test Date	2010/03/10
Test Mode	Charge Mode (worst case)	TEMP & Humidity	12.6°C, 66%

966 Chamber_B at 3Meter / Horizontal						
Frequency (MHz)	Reading (dBµV)	Correction Factor (dB/m)	Result (dBµV/m)	Limit (dBµV/m)	Margin (dB)	Remark
105.66	60.64	-30.85	29.80	43.50	-13.70	Peak
231.76	69.92	-30.01	39.91	46.00	-6.09	Peak
253.10	65.28	-29.44	35.85	46.00	-10.15	Peak
315.18	62.34	-27.20	35.14	46.00	-10.86	Peak
431.58	63.36	-24.12	39.24	46.00	-6.76	Peak
590.66	53.24	-20.76	32.47	46.00	-13.53	Peak
656.62	50.57	-19.75	30.82	46.00	-15.18	Peak
799.21	51.45	-17.36	34.10	46.00	-11.90	Peak

966 Chamber_B at 3Meter / Vertical						
Frequency (MHz)	Reading (dBµV)	Correction Factor (dB/m)	Result (dBµV/m)	Limit (dBµV/m)	Margin (dB)	Remark
147.37	59.24	-29.36	29.88	43.50	-13.62	Peak
165.80	60.42	-30.17	30.24	43.50	-13.26	Peak
230.79	62.37	-30.05	32.31	46.00	-13.69	Peak
253.10	62.17	-29.44	32.73	46.00	-13.27	Peak
272.50	61.62	-27.90	33.72	46.00	-12.28	Peak
316.15	59.57	-27.16	32.40	46.00	-13.60	Peak
525.67	54.47	-22.40	32.07	46.00	-13.93	Peak
796.30	52.59	-17.38	35.21	46.00	-10.79	Peak

Remark:

1. Quasi-peak test would be performed if the peak result were greater than the quasi-peak limit.
2. Data of measurement within this frequency range shown " --- " in the table above means the reading of emissions are attenuated more than 20dB below the permissible limits or the field strength is too small to be measured.
3. Correction Factor (dB/m) = Antenna Factor (dB/m) + Cable Loss (dB) – PreAmp.Gain (dB)
4. Result (dBuV/m) = Reading (dBuV) + Correction Factor (dB/m)
5. Margin (dB) = Remark result (dBuV/m) - Quasi-peak limit (dBuV/m).



TX Above 1 GHz

Product Name	Universal Bluetooth Headset	Test By	Rick Lin
Model	HK201	Test Date	2010/03/16
Test Mode	GFSK TX / CH Low	TEMP & Humidity	20.1°C, 65%

966 Chamber_A at 3Meter / Horizontal									
Frequency (MHz)	Reading-PK (dBuV)	Reading-AV (dBuV)	Correction Factor (dB/m)	Result-PK (dBuV/m)	Result-AV (dBuV/m)	Limit-PK (dBuV/m)	Limit-AV (dBuV/m)	Margin (dB)	Remark
1328.00	53.25	---	-3.66	49.60	---	74.00	54.00	-24.40	Peak
1862.00	47.48	---	0.38	47.87	---	74.00	54.00	-26.13	Peak
2402.00	89.54	---	2.29	91.84	---	---	---	---	Carrier
4117.50	41.65	---	5.54	47.19	---	74.00	54.00	-26.81	Peak
4807.50	49.15	41.58	7.08	56.23	48.66	74.00	54.00	-5.34	AVG
5362.50	41.73	---	8.04	49.77	---	74.00	54.00	-24.23	Peak
6667.50	40.40	---	9.91	50.31	---	74.00	54.00	-23.69	Peak

966 Chamber_A at 3Meter / Vertical									
Frequency (MHz)	Reading-PK (dBuV)	Reading-AV (dBuV)	Correction Factor (dB/m)	Result-PK (dBuV/m)	Result-AV (dBuV/m)	Limit-PK (dBuV/m)	Limit-AV (dBuV/m)	Margin (dB)	Remark
1330.00	60.13	40.97	-3.65	56.48	37.32	74.00	54.00	-16.68	AVG
1596.00	46.73	---	-2.16	44.57	---	74.00	54.00	-29.43	Peak
1862.00	48.81	---	0.38	49.20	---	74.00	54.00	-24.80	Peak
2402.00	89.32	---	2.29	91.61	---	---	---	---	Carrier
4327.50	42.16	---	6.29	48.46	---	74.00	54.00	-25.54	Peak
4800.00	50.62	43.51	7.07	57.69	50.58	74.00	54.00	-23.42	AVG
5685.00	40.61	---	8.70	49.31	---	74.00	54.00	-24.69	Peak

Remark:

1. Measuring frequencies from 1 GHz to the 10th harmonic of highest fundamental frequency.
2. Average test would be performed if the peak result were greater than the average limit.
3. Data of measurement within this frequency range shown " --- " in the table above means the reading of emissions are attenuated more than 20dB below the permissible limits or the field strength is too small to be measured.
4. Measurements above show only up to 6 maximum emissions noted, or would be lesser, with " N/A " remark, if no specific emissions from the EUT are recorded (ie: margin>20dB from the applicable limit) and considered that's already beyond the background noise floor.
5. In any 100 kHz bandwidth outside the frequency band in which the spread spectrum or digitally modulated intentional radiator is operating, the radio frequency power that is produced by the intentional radiator shall be at least 20 dB below that in the 100 kHz bandwidth within the band that contains the highest level of the desired power, based on either an RF conducted or a radiated measurement, provided the transmitter demonstrates compliance with the peak conducted power limits. If the transmitter complies with the conducted power limits based on the use of RMS averaging over a time interval, as permitted under paragraph (b)(3) of this section, the attenuation required under this paragraph shall be 30 dB instead of 20 dB.
6. Result = Reading + Correction Factor
Margin = Result - Limit
Remark Peak = Result(PK) - Limit(PK)
Remark AVG = Result(AV) - Limit(AV)



Product Name	Universal Bluetooth Headset	Test By	Rick Lin
Model	HK201	Test Date	2010/03/16
Test Mode	GFSK TX / CH Middle	TEMP & Humidity	20.1°C, 65%

966 Chamber_A at 3Meter / Horizontal									
Frequency (MHz)	Reading-PK (dBuV)	Reading-AV (dBuV)	Correction Factor (dB/m)	Result-PK (dBuV/m)	Result-AV (dBuV/m)	Limit-PK (dBuV/m)	Limit-AV (dBuV/m)	Margin (dB)	Remark
1330.00	52.87	---	-3.65	49.22	---	74.00	54.00	-24.78	Peak
1862.00	47.77	---	0.38	48.15	---	74.00	54.00	-25.85	Peak
2440.00	89.37	---	2.35	91.71	---	---	---	---	Carrier
4882.50	51.44	43.58	7.12	58.56	50.70	74.00	54.00	-3.30	AVG
5827.50	41.19	---	8.95	50.14	---	74.00	54.00	-23.86	Peak
6435.00	41.07	---	9.64	50.71	---	74.00	54.00	-23.29	Peak

966 Chamber_A at 3Meter / Vertical									
Frequency (MHz)	Reading-PK (dBuV)	Reading-AV (dBuV)	Correction Factor (dB/m)	Result-PK (dBuV/m)	Result-AV (dBuV/m)	Limit-PK (dBuV/m)	Limit-AV (dBuV/m)	Margin (dB)	Remark
1330.00	53.26	---	-3.65	49.61	---	74.00	54.00	-24.39	Peak
1416.00	47.47	---	-3.36	44.11	---	74.00	54.00	-29.89	Peak
1866.00	50.47	---	0.42	50.89	---	74.00	54.00	-23.11	Peak
2440.00	90.36	---	2.35	92.71	---	---	---	---	Carrier
4882.50	50.88	43.17	7.12	58.00	50.29	74.00	54.00	-3.71	AVG
5572.50	41.63	---	8.50	50.13	---	74.00	54.00	-23.87	Peak
6960.00	41.17	---	10.28	51.45	---	74.00	54.00	-22.55	Peak

Remark:

1. Measuring frequencies from 1 GHz to the 10th harmonic of highest fundamental frequency.
2. Average test would be performed if the peak result were greater than the average limit.
3. Data of measurement within this frequency range shown " --- " in the table above means the reading of emissions are attenuated more than 20dB below the permissible limits or the field strength is too small to be measured.
4. Measurements above show only up to 6 maximum emissions noted, or would be lesser, with " N/A " remark, if no specific emissions from the EUT are recorded (ie: margin>20dB from the applicable limit) and considered that's already beyond the background noise floor.
5. In any 100 kHz bandwidth outside the frequency band in which the spread spectrum or digitally modulated intentional radiator is operating, the radio frequency power that is produced by the intentional radiator shall be at least 20 dB below that in the 100 kHz bandwidth within the band that contains the highest level of the desired power, based on either an RF conducted or a radiated measurement, provided the transmitter demonstrates compliance with the peak conducted power limits. If the transmitter complies with the conducted power limits based on the use of RMS averaging over a time interval, as permitted under paragraph (b)(3) of this section, the attenuation required under this paragraph shall be 30 dB instead of 20 dB.
6. Result = Reading + Correction Factor
Margin = Result - Limit
Remark Peak = Result(PK) - Limit(PK)
Remark AVG = Result(AV) - Limit(AV)



Product Name	Universal Bluetooth Headset	Test By	Rick Lin
Model	HK201	Test Date	2010/03/16
Test Mode	GFSK TX / CH High	TEMP & Humidity	20.1°C, 65%

966 Chamber_A at 3Meter / Horizontal									
Frequency (MHz)	Reading-PK (dBuV)	Reading-AV (dBuV)	Correction Factor (dB/m)	Result-PK (dBuV/m)	Result-AV (dBuV/m)	Limit-PK (dBuV/m)	Limit-AV (dBuV/m)	Margin (dB)	Remark
1330.00	53.19	---	-3.65	49.54	---	74.00	54.00	-24.46	Peak
1864.00	47.01	---	0.40	47.41	---	74.00	54.00	-26.59	Peak
2480.00	87.34	---	2.40	89.75	---	---	---	---	Carrier
4005.00	41.65	---	5.14	46.79	---	74.00	54.00	-27.21	Peak
4590.00	41.27	---	6.96	48.23	---	74.00	54.00	-25.77	Peak
4957.50	43.83	---	7.16	50.98	---	74.00	54.00	-23.02	Peak
6135.00	40.42	---	9.37	49.79	---	74.00	54.00	-24.21	Peak

966 Chamber_A at 3Meter / Vertical									
Frequency (MHz)	Reading-PK (dBuV)	Reading-AV (dBuV)	Correction Factor (dB/m)	Result-PK (dBuV/m)	Result-AV (dBuV/m)	Limit-PK (dBuV/m)	Limit-AV (dBuV/m)	Margin (dB)	Remark
1332.00	59.68	42.00	-3.64	56.04	38.36	74.00	54.00	-15.64	AVG
1866.00	49.63	---	0.42	50.05	---	74.00	54.00	-23.95	Peak
2480.00	92.35	---	2.40	94.76	---	---	---	---	Carrier
3157.50	43.29	---	3.65	46.94	---	74.00	54.00	-27.06	Peak
4957.50	49.01	41.27	7.16	56.17	48.43	74.00	54.00	-5.57	AVG
5610.00	40.61	---	8.57	49.17	---	74.00	54.00	-24.83	Peak
6772.50	40.73	---	10.04	50.77	---	74.00	54.00	-23.23	Peak

Remark:

1. Measuring frequencies from 1 GHz to the 10th harmonic of highest fundamental frequency.
2. Average test would be performed if the peak result were greater than the average limit.
3. Data of measurement within this frequency range shown " --- " in the table above means the reading of emissions are attenuated more than 20dB below the permissible limits or the field strength is too small to be measured.
4. Measurements above show only up to 6 maximum emissions noted, or would be lesser, with " N/A " remark, if no specific emissions from the EUT are recorded (ie: margin>20dB from the applicable limit) and considered that's already beyond the background noise floor.
5. In any 100 kHz bandwidth outside the frequency band in which the spread spectrum or digitally modulated intentional radiator is operating, the radio frequency power that is produced by the intentional radiator shall be at least 20 dB below that in the 100 kHz bandwidth within the band that contains the highest level of the desired power, based on either an RF conducted or a radiated measurement, provided the transmitter demonstrates compliance with the peak conducted power limits. If the transmitter complies with the conducted power limits based on the use of RMS averaging over a time interval, as permitted under paragraph (b)(3) of this section, the attenuation required under this paragraph shall be 30 dB instead of 20 dB.
6. Result = Reading + Correction Factor
Margin = Result - Limit
Remark Peak = Result(PK) - Limit(PK)
Remark AVG = Result(AV) - Limit(AV)



Product Name	Universal Bluetooth Headset	Test By	Rick Lin
Model	HK201	Test Date	2010/03/16
Test Mode	8-DPSK TX / CH Low	TEMP & Humidity	20.1°C, 65%

966 Chamber_A at 3Meter / Horizontal									
Frequency (MHz)	Reading-PK (dBuV)	Reading-AV (dBuV)	Correction Factor (dB/m)	Result-PK (dBuV/m)	Result-AV (dBuV/m)	Limit-PK (dBuV/m)	Limit-AV (dBuV/m)	Margin (dB)	Remark
1332.00	53.24	---	-3.64	49.60	---	74.00	54.00	-24.40	Peak
1862.00	47.78	---	0.38	48.16	---	74.00	54.00	-25.84	Peak
2402.00	91.27	---	2.29	93.56	---	---	---	---	Carrier
3390.00	42.13	---	4.08	46.21	---	74.00	54.00	-27.79	Peak
4807.50	49.81	39.27	7.08	56.89	46.35	74.00	54.00	-7.65	AVG
6420.00	40.73	---	9.63	50.35	---	74.00	54.00	-23.65	Peak

966 Chamber_A at 3Meter / Vertical									
Frequency (MHz)	Reading-PK (dBuV)	Reading-AV (dBuV)	Correction Factor (dB/m)	Result-PK (dBuV/m)	Result-AV (dBuV/m)	Limit-PK (dBuV/m)	Limit-AV (dBuV/m)	Margin (dB)	Remark
1328.00	61.32	43.60	-3.66	57.66	39.94	74.00	54.00	-14.06	AVG
1598.00	47.72	---	-2.14	45.58	---	74.00	54.00	-28.42	Peak
1860.00	48.65	---	0.36	49.01	---	74.00	54.00	-24.99	Peak
2402.00	90.26	---	2.29	92.55	---	---	---	---	Carrier
3262.50	42.13	---	3.85	45.97	---	74.00	54.00	-28.03	Peak
4807.50	53.25	42.52	7.08	60.33	49.60	74.00	54.00	-4.40	AVG
5790.00	41.59	---	8.88	50.48	---	74.00	54.00	-23.52	Peak

Remark:

1. Measuring frequencies from 1 GHz to the 10th harmonic of highest fundamental frequency.
2. Average test would be performed if the peak result were greater than the average limit.
3. Data of measurement within this frequency range shown " --- " in the table above means the reading of emissions are attenuated more than 20dB below the permissible limits or the field strength is too small to be measured.
4. Measurements above show only up to 6 maximum emissions noted, or would be lesser, with " N/A " remark, if no specific emissions from the EUT are recorded (ie: margin>20dB from the applicable limit) and considered that's already beyond the background noise floor.
5. In any 100 kHz bandwidth outside the frequency band in which the spread spectrum or digitally modulated intentional radiator is operating, the radio frequency power that is produced by the intentional radiator shall be at least 20 dB below that in the 100 kHz bandwidth within the band that contains the highest level of the desired power, based on either an RF conducted or a radiated measurement, provided the transmitter demonstrates compliance with the peak conducted power limits. If the transmitter complies with the conducted power limits based on the use of RMS averaging over a time interval, as permitted under paragraph (b)(3) of this section, the attenuation required under this paragraph shall be 30 dB instead of 20 dB.
6. Result = Reading + Correction Factor
Margin = Result - Limit
Remark Peak = Result(PK) - Limit(PK)
Remark AVG = Result(AV) - Limit(AV)



Product Name	Universal Bluetooth Headset	Test By	Rick Lin
Model	HK201	Test Date	2010/03/16
Test Mode	8-DPSK TX / CH Middle	TEMP & Humidity	20.1°C, 65%

966 Chamber_A at 3Meter / Horizontal									
Frequency (MHz)	Reading-PK (dBuV)	Reading-AV (dBuV)	Correction Factor (dB/m)	Result-PK (dBuV/m)	Result-AV (dBuV/m)	Limit-PK (dBuV/m)	Limit-AV (dBuV/m)	Margin (dB)	Remark
1330.00	52.27	---	-3.65	48.62	---	74.00	54.00	-25.38	Peak
1864.00	46.92	---	0.40	47.32	---	74.00	54.00	-26.68	Peak
2440.00	90.25	---	2.35	92.60	---	---	---	---	Carrier
4335.00	41.60	---	6.32	47.93	---	74.00	54.00	-26.07	Peak
4882.50	53.56	43.25	7.12	60.68	50.37	74.00	54.00	-3.63	AVG
6015.00	40.55	---	9.27	49.82	---	74.00	54.00	-24.18	Peak

966 Chamber_A at 3Meter / Vertical									
Frequency (MHz)	Reading-PK (dBuV)	Reading-AV (dBuV)	Correction Factor (dB/m)	Result-PK (dBuV/m)	Result-AV (dBuV/m)	Limit-PK (dBuV/m)	Limit-AV (dBuV/m)	Margin (dB)	Remark
1332.00	53.16	---	-3.64	49.51	---	74.00	54.00	-24.49	Peak
1862.00	50.93	---	0.38	51.31	---	74.00	54.00	-22.69	Peak
2440.00	91.19	---	2.35	93.53	---	---	---	---	Carrier
3675.00	42.85	---	4.58	47.43	---	74.00	54.00	-26.57	Peak
4882.50	52.68	42.45	7.12	59.80	49.57	74.00	54.00	-4.43	AVG
6007.50	40.76	---	9.26	50.02	---	74.00	54.00	-23.98	Peak

Remark:

1. Measuring frequencies from 1 GHz to the 10th harmonic of highest fundamental frequency.
2. Average test would be performed if the peak result were greater than the average limit.
3. Data of measurement within this frequency range shown " --- " in the table above means the reading of emissions are attenuated more than 20dB below the permissible limits or the field strength is too small to be measured.
4. Measurements above show only up to 6 maximum emissions noted, or would be lesser, with " N/A " remark, if no specific emissions from the EUT are recorded (ie: margin>20dB from the applicable limit) and considered that's already beyond the background noise floor.
5. In any 100 kHz bandwidth outside the frequency band in which the spread spectrum or digitally modulated intentional radiator is operating, the radio frequency power that is produced by the intentional radiator shall be at least 20 dB below that in the 100 kHz bandwidth within the band that contains the highest level of the desired power, based on either an RF conducted or a radiated measurement, provided the transmitter demonstrates compliance with the peak conducted power limits. If the transmitter complies with the conducted power limits based on the use of RMS averaging over a time interval, as permitted under paragraph (b)(3) of this section, the attenuation required under this paragraph shall be 30 dB instead of 20 dB.
6. Result = Reading + Correction Factor
Margin = Result - Limit
Remark Peak = Result(PK) - Limit(PK)
Remark AVG = Result(AV) - Limit(AV)



Product Name	Universal Bluetooth Headset	Test By	Rick Lin
Model	HK201	Test Date	2010/03/16
Test Mode	8-DPSK TX / CH High	TEMP & Humidity	20.1°C, 65%

966 Chamber_A at 3Meter / Horizontal									
Frequency (MHz)	Reading-PK (dBuV)	Reading-AV (dBuV)	Correction Factor (dB/m)	Result-PK (dBuV/m)	Result-AV (dBuV/m)	Limit-PK (dBuV/m)	Limit-AV (dBuV/m)	Margin (dB)	Remark
1330.00	53.43	---	-3.65	49.78	---	74.00	54.00	-24.22	Peak
1866.00	48.48	---	0.42	48.90	---	74.00	54.00	-25.10	Peak
2480.00	88.36	---	2.40	90.76	---	---	---	---	Carrier
3547.50	42.41	---	4.36	46.77	---	74.00	54.00	-27.23	Peak
4957.50	43.11	---	7.16	50.27	---	74.00	54.00	-23.73	Peak
5280.00	41.15	---	7.85	48.99	---	74.00	54.00	-25.01	Peak
6277.50	40.20	---	9.50	49.70	---	74.00	54.00	-24.30	Peak

966 Chamber_A at 3Meter / Vertical									
Frequency (MHz)	Reading-PK (dBuV)	Reading-AV (dBuV)	Correction Factor (dB/m)	Result-PK (dBuV/m)	Result-AV (dBuV/m)	Limit-PK (dBuV/m)	Limit-AV (dBuV/m)	Margin (dB)	Remark
1330.00	60.50	42.85	-3.65	56.85	39.20	74.00	54.00	-14.80	AVG
1860.00	49.58	---	0.36	49.94	---	74.00	54.00	-24.06	Peak
2480.00	93.89	---	2.40	96.30	---	---	---	---	Carrier
3135.00	43.33	---	3.61	46.94	---	74.00	54.00	-27.06	Peak
4372.50	40.88	---	6.46	47.34	---	74.00	54.00	-26.66	Peak
4957.50	50.51	40.14	7.16	57.67	47.30	74.00	54.00	-6.70	AVG
6307.50	40.48	---	9.53	50.01	---	74.00	54.00	-23.99	Peak

Remark:

1. Measuring frequencies from 1 GHz to the 10th harmonic of highest fundamental frequency.
2. Average test would be performed if the peak result were greater than the average limit.
3. Data of measurement within this frequency range shown " --- " in the table above means the reading of emissions are attenuated more than 20dB below the permissible limits or the field strength is too small to be measured.
4. Measurements above show only up to 6 maximum emissions noted, or would be lesser, with " N/A " remark, if no specific emissions from the EUT are recorded (ie: margin>20dB from the applicable limit) and considered that's already beyond the background noise floor.
5. In any 100 kHz bandwidth outside the frequency band in which the spread spectrum or digitally modulated intentional radiator is operating, the radio frequency power that is produced by the intentional radiator shall be at least 20 dB below that in the 100 kHz bandwidth within the band that contains the highest level of the desired power, based on either an RF conducted or a radiated measurement, provided the transmitter demonstrates compliance with the peak conducted power limits. If the transmitter complies with the conducted power limits based on the use of RMS averaging over a time interval, as permitted under paragraph (b)(3) of this section, the attenuation required under this paragraph shall be 30 dB instead of 20 dB.
6. Result = Reading + Correction Factor
Margin = Result - Limit
Remark Peak = Result(PK) - Limit(PK)
Remark AVG = Result(AV) - Limit(AV)



Restricted Band Edges

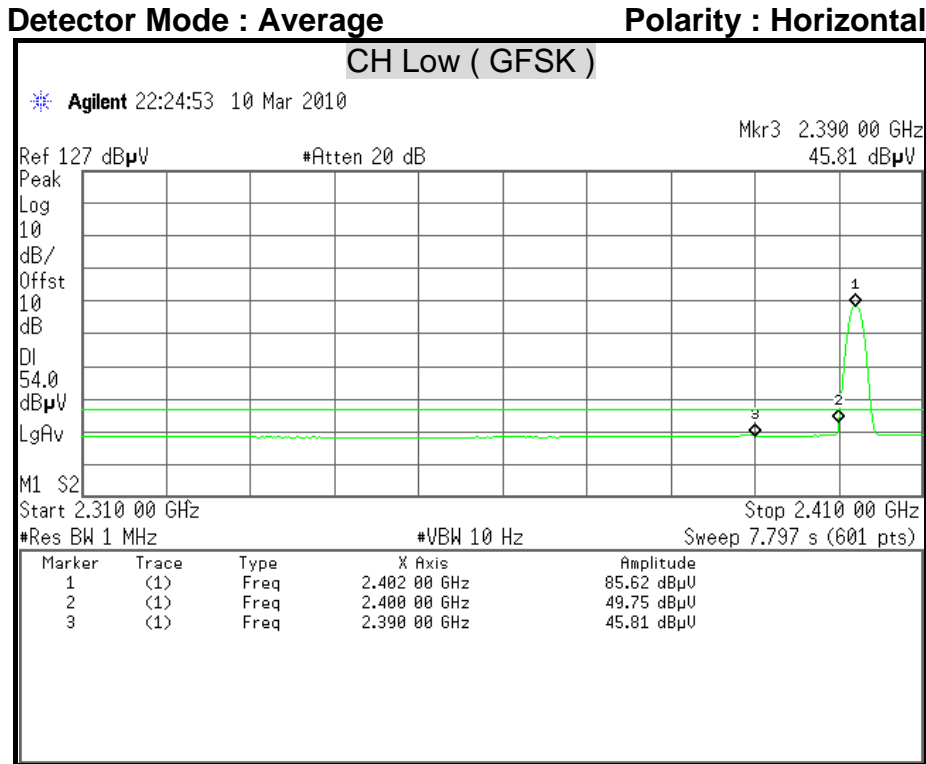
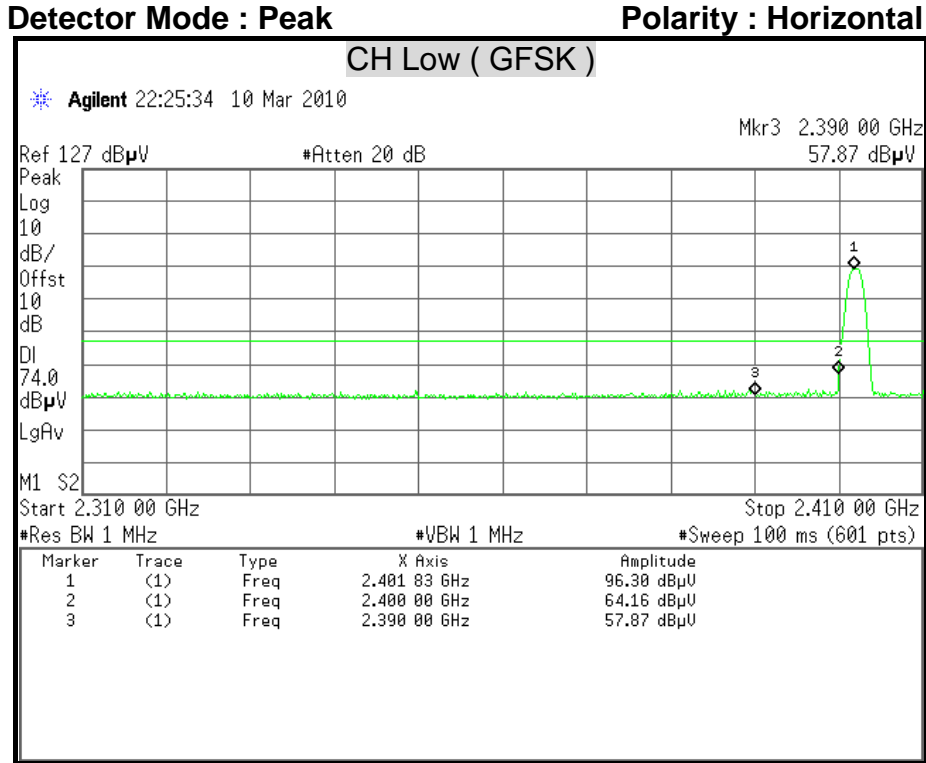



Detector Mode : Peak

Polarity : Vertical

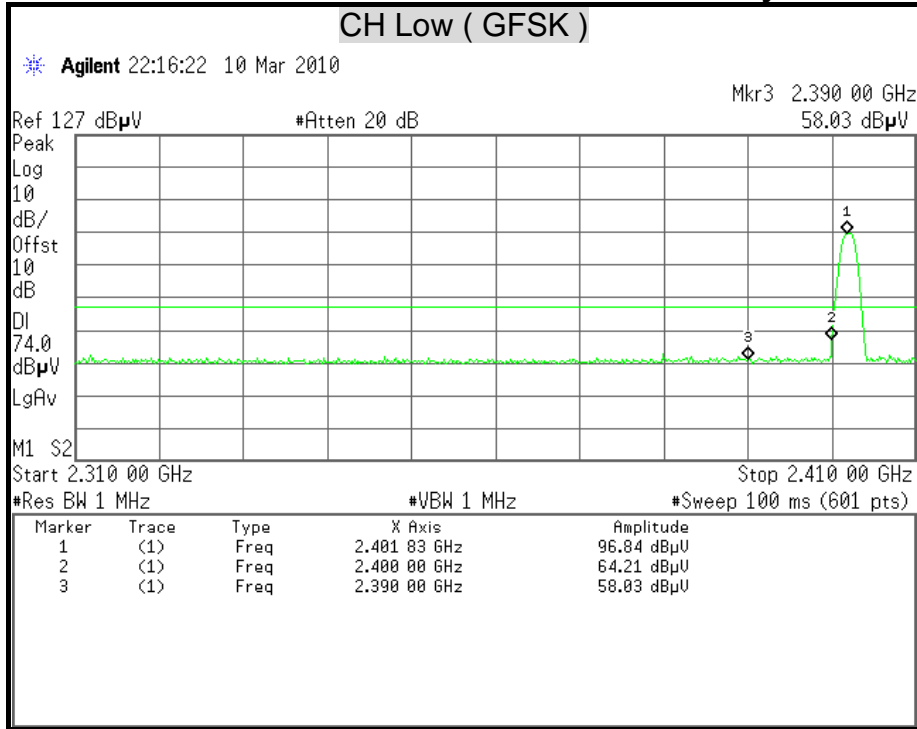

Detector Mode : Average

Polarity : Vertical

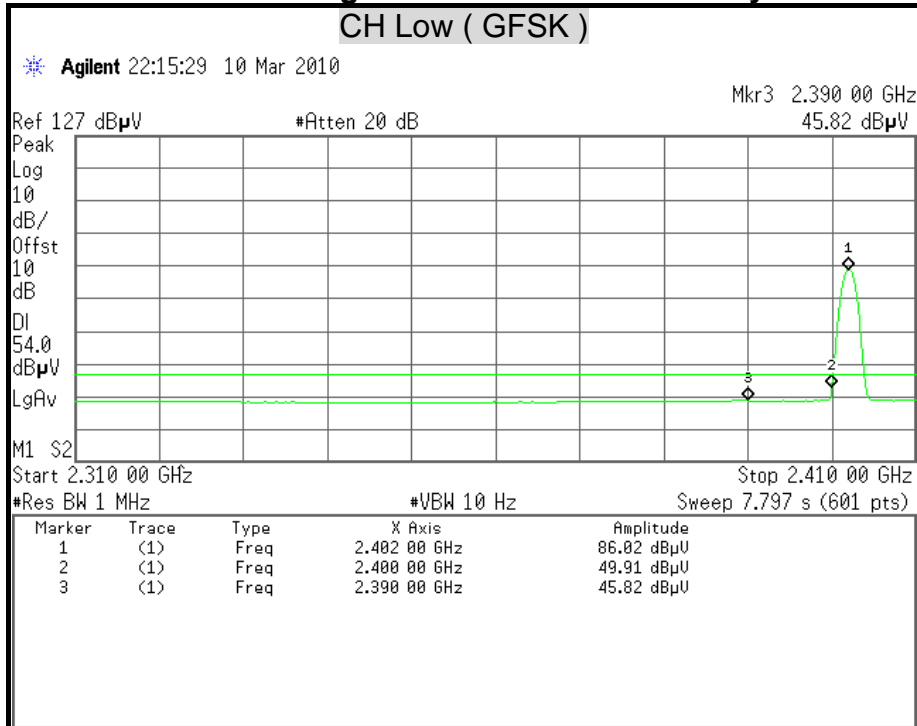



Detector Mode : Peak

Polarity : Horizontal

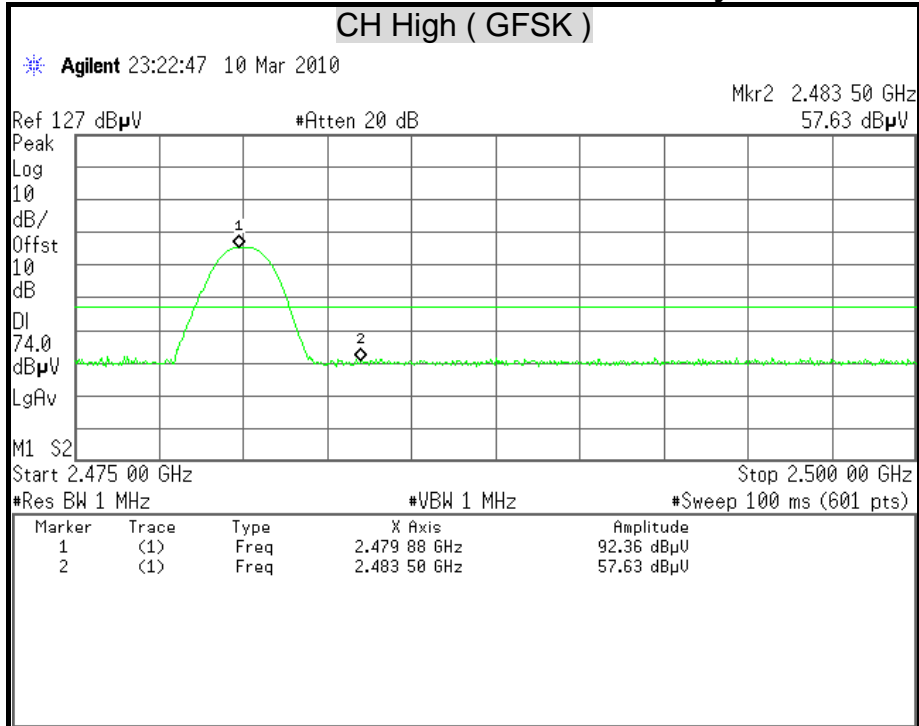

Detector Mode : Average

Polarity : Horizontal

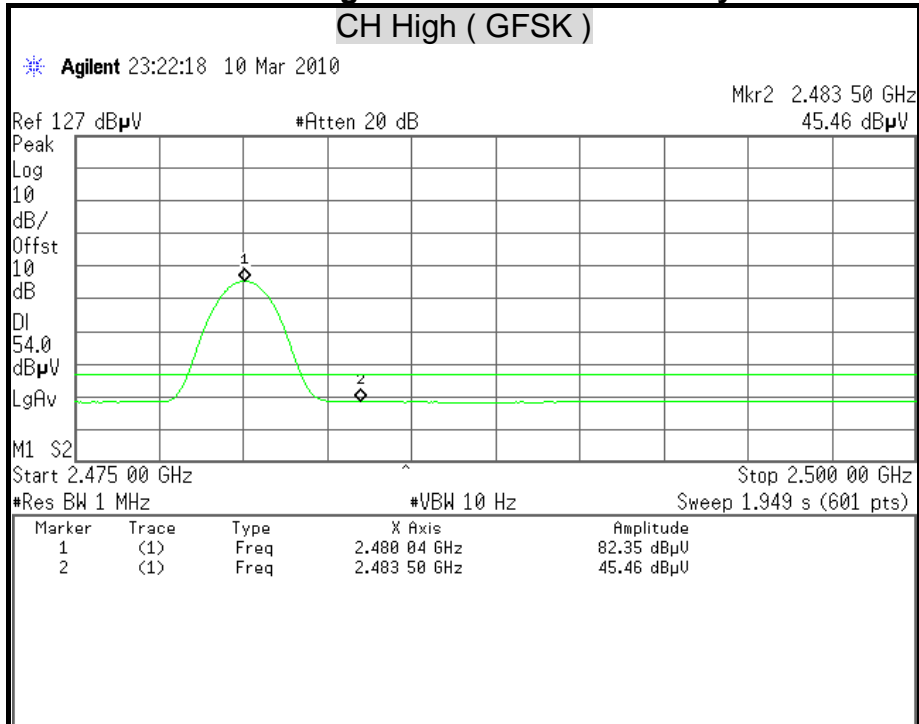



Detector Mode : Peak

Polarity : Vertical

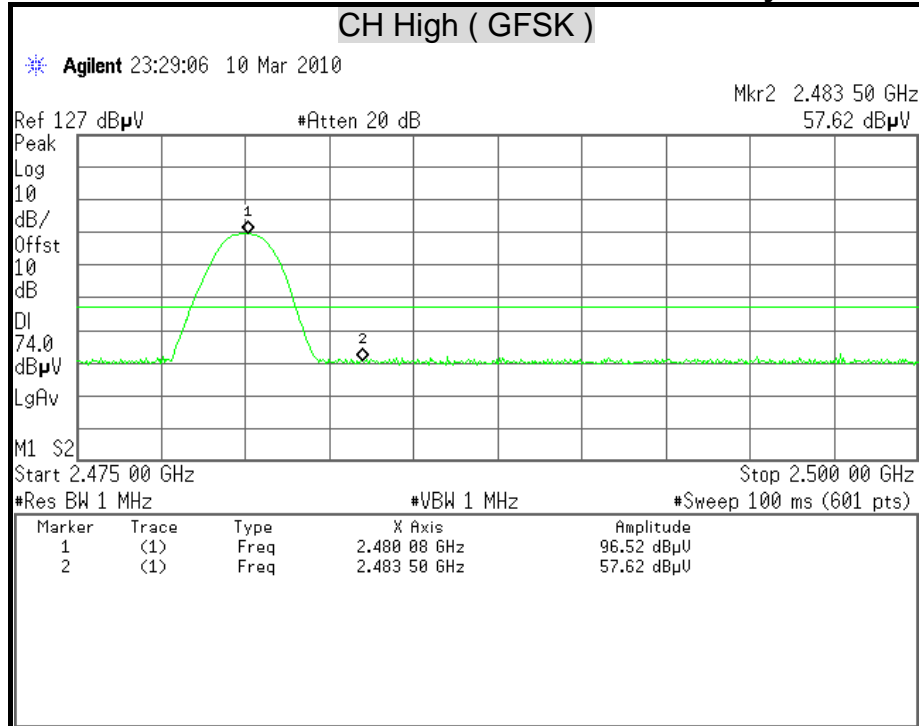

Detector Mode : Average

Polarity : Vertical

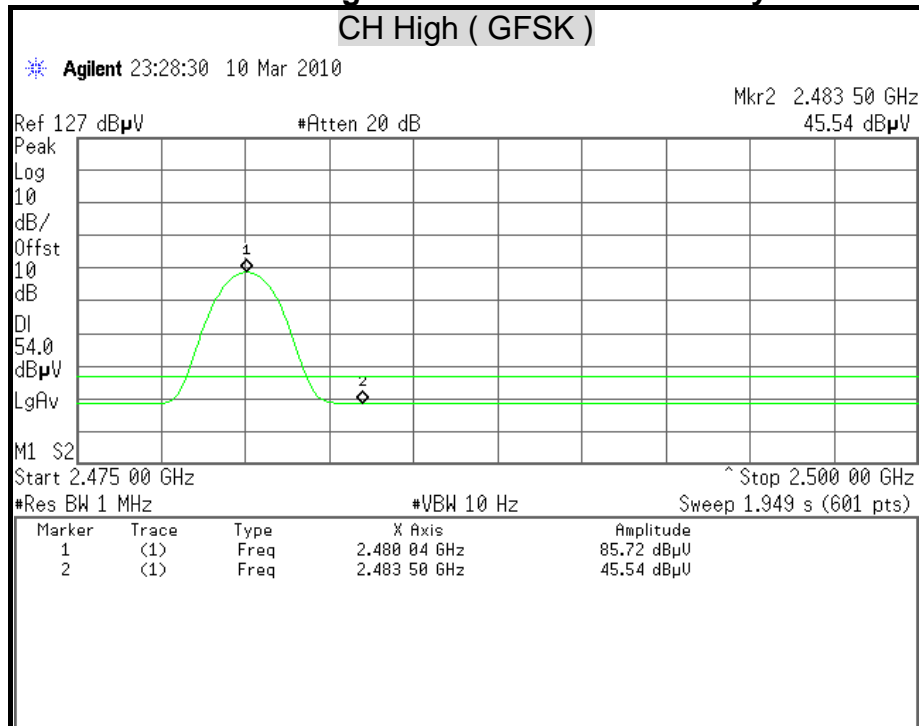



Detector Mode : Peak

Polarity : Horizontal

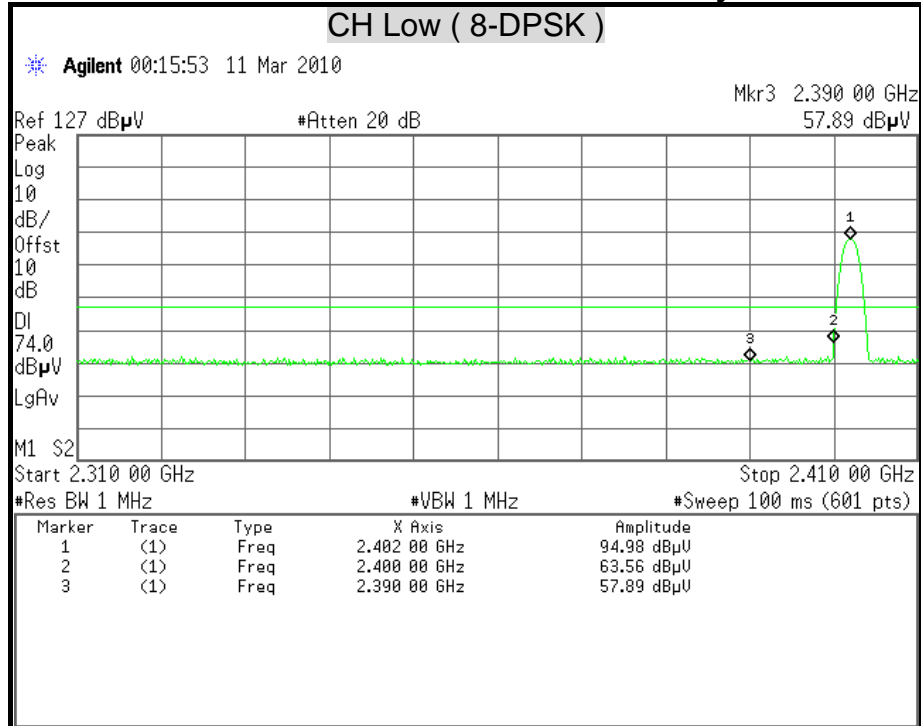

Detector Mode : Average

Polarity : Horizontal

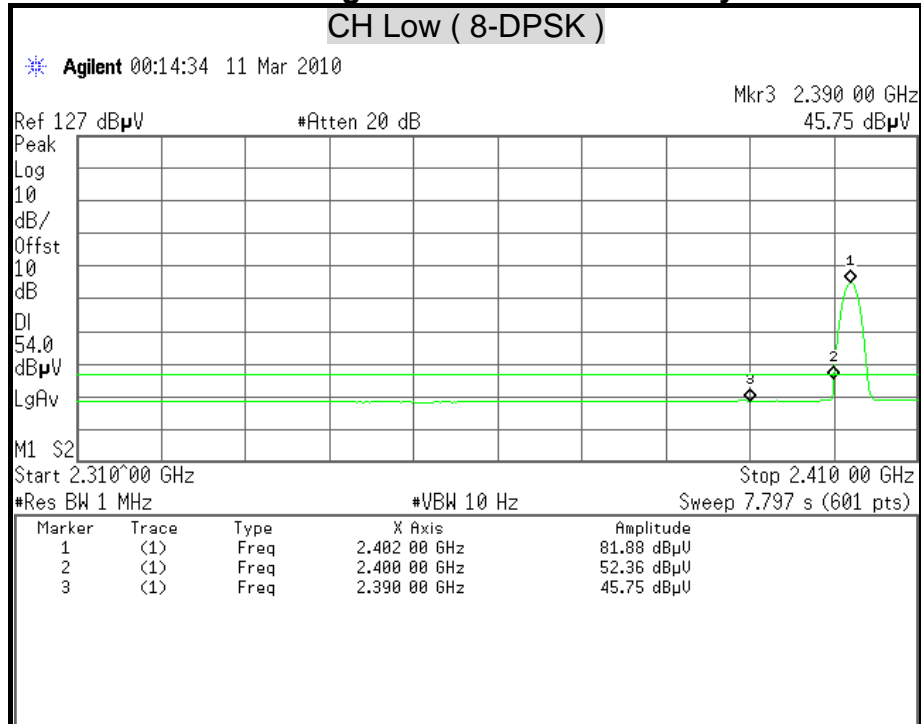

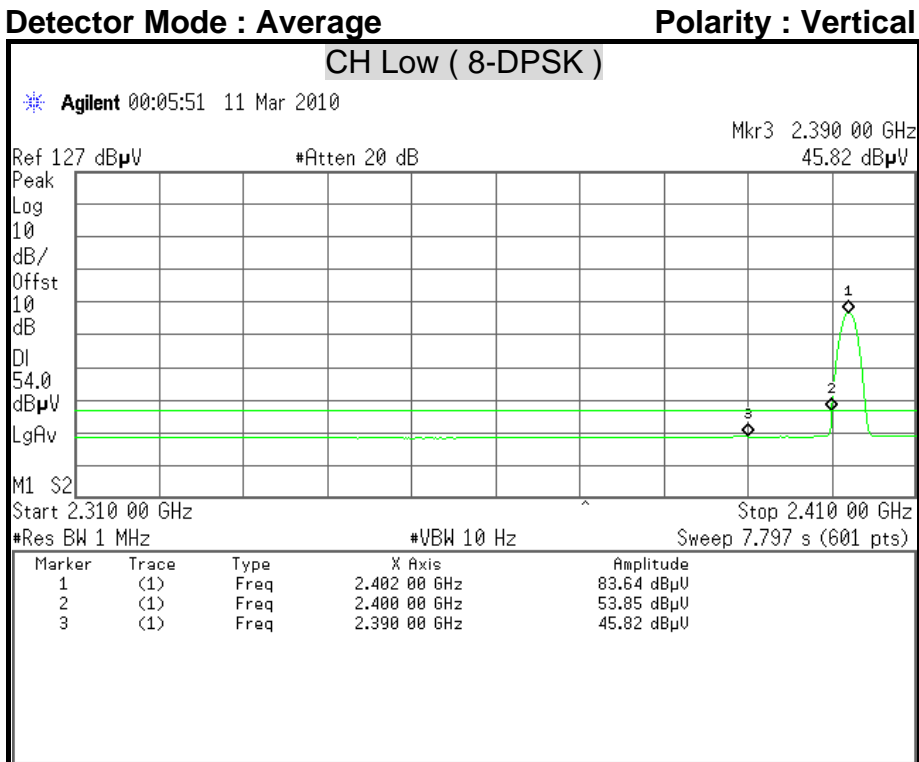
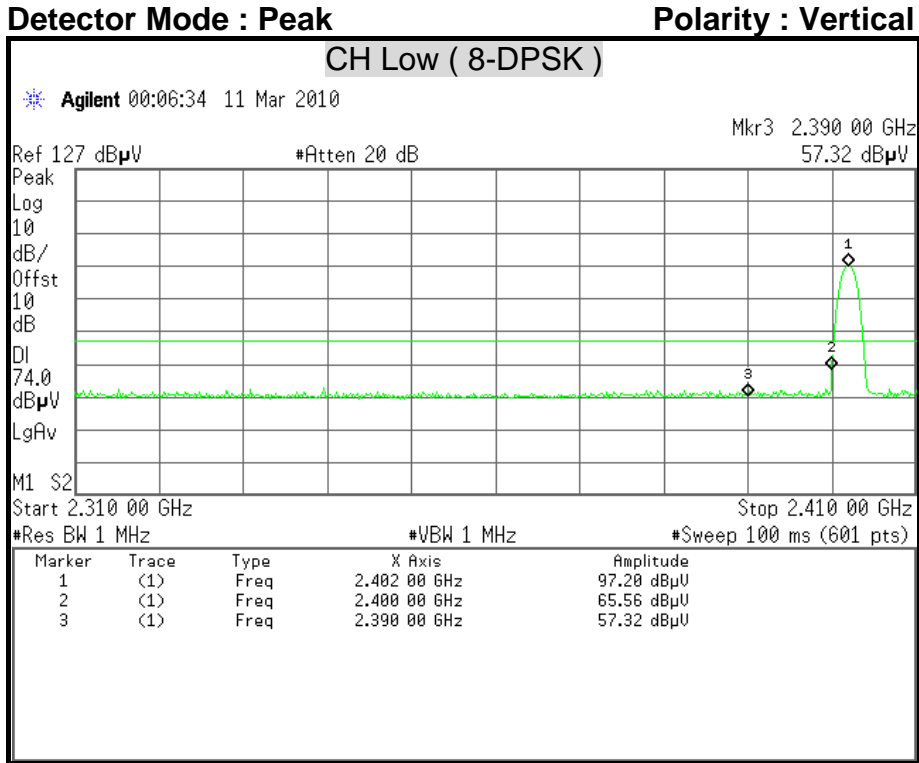



Detector Mode : Peak

Polarity : Horizontal

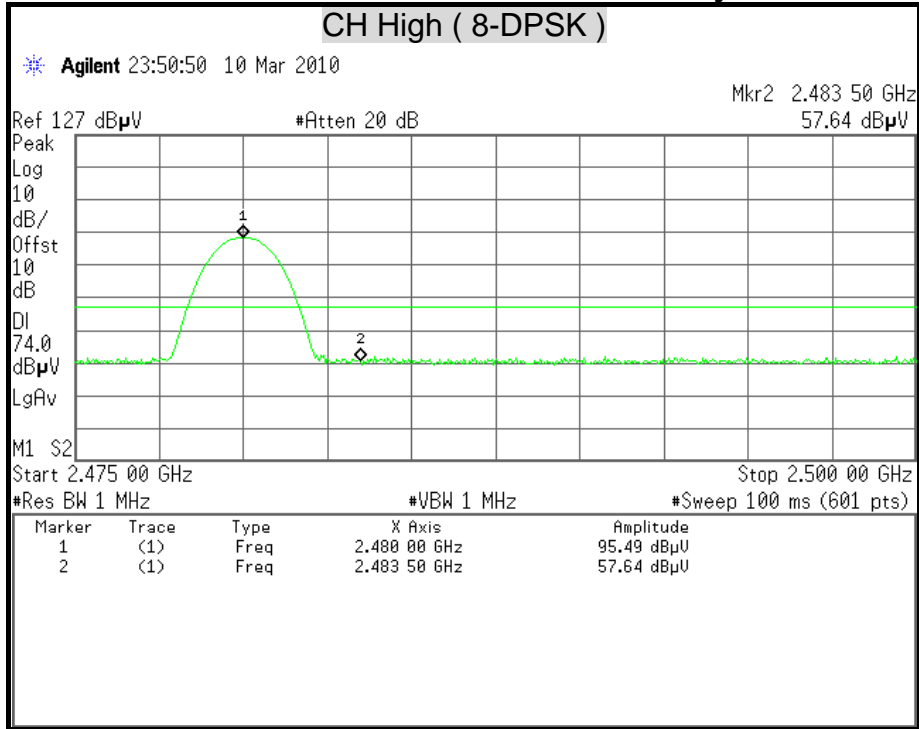

Detector Mode : Average

Polarity : Horizontal

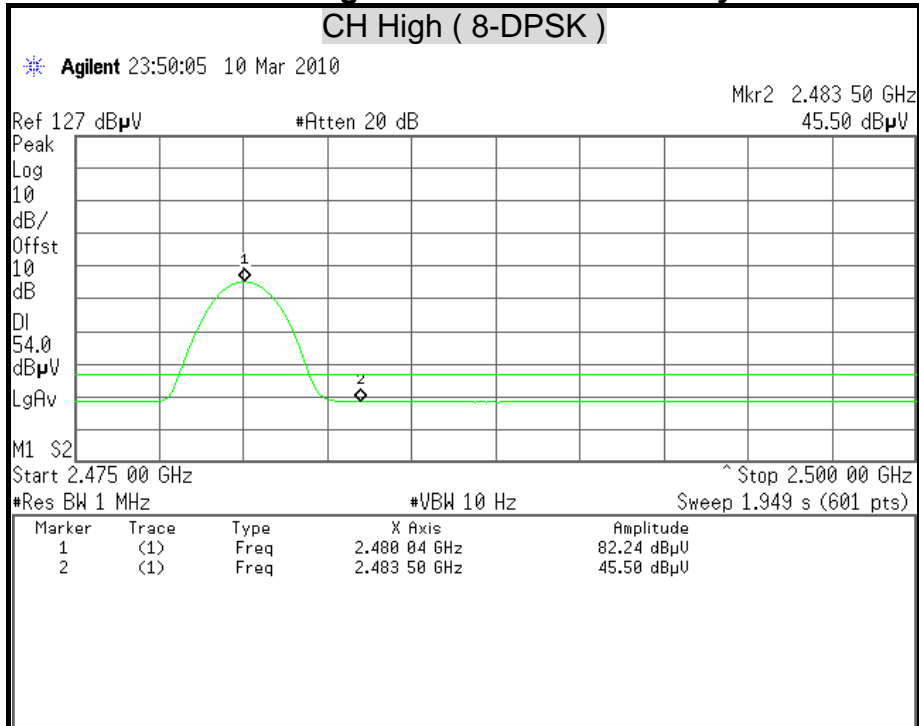

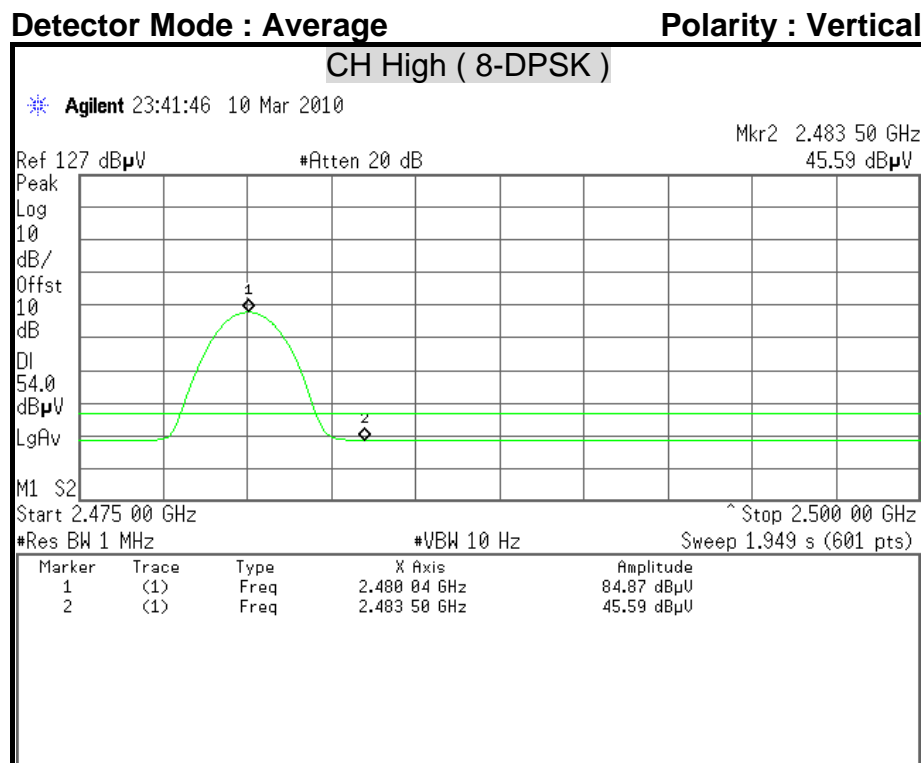
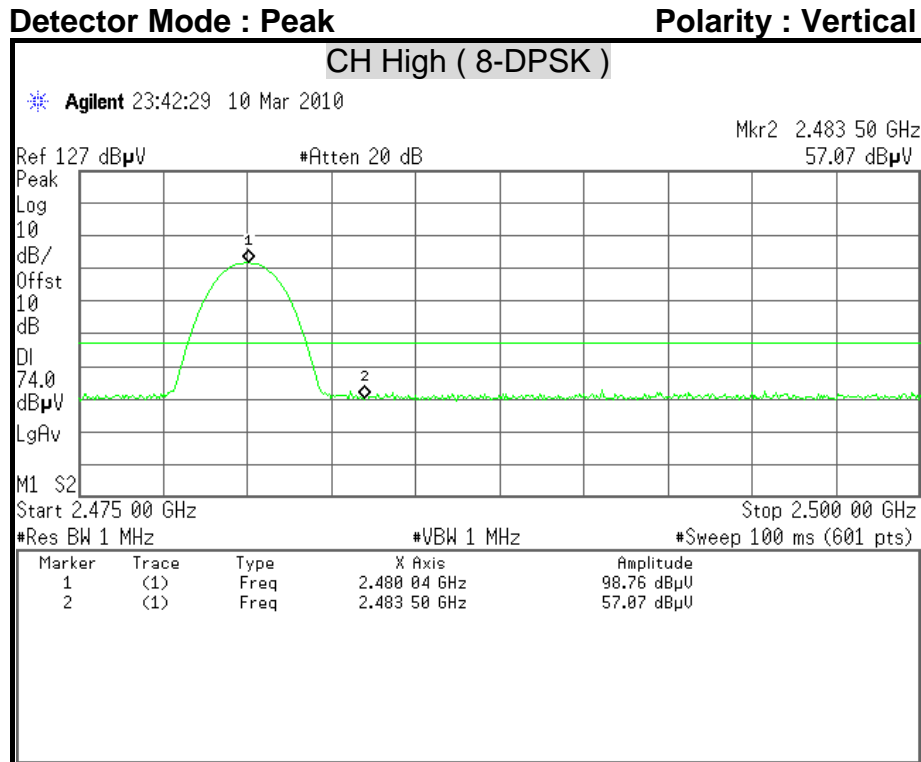



8.8 CONDUCTED EMISSION

LIMITS

§ 15.207 (a) Except as shown in paragraph (b) and (c) this section, for an intentional radiator that is designed to be connected to the public utility (AC) power line, the radio frequency voltage that is conducted back onto the AC power line on any frequency or frequencies within the band 150 kHz to 30 MHz shall not exceed the limits in the following table, as measured using a 50 μ H/50 ohms line impedance stabilization network (LISN). Compliance with the provisions of this paragraph shall be based on the measurement of the radio frequency voltage between each power line and ground at the power terminal. The lower limit applies at the boundary between the frequency ranges.

Frequency Range (MHz)	Conducted Limit (dB μ v)	
	Quasi-peak	Average
0.15 - 0.50	66 to 56	56 to 46
0.50 - 5.00	56	46
5.00 - 30.0	60	50

TEST EQUIPMENT

Name of Equipment	Manufacturer	Model	Serial Number	Calibration Due
L.I.S.N	SCHWARZBECK	NSLK 8127	8127-465	08/13/2010
TEST RECEIVER	ROHDE & SCHWARZ	ESHS30	838550/003	01/28/2011
PULSE LIMIT	ROHDE & SCHWARZ	ESH3-Z2	100117	09/17/2010
N Type Coaxial Cable	BELDEN	8268 M17/164	003	07/09/2010

Remark: Each piece of equipment is scheduled for calibration once a year.

TEST SETUP

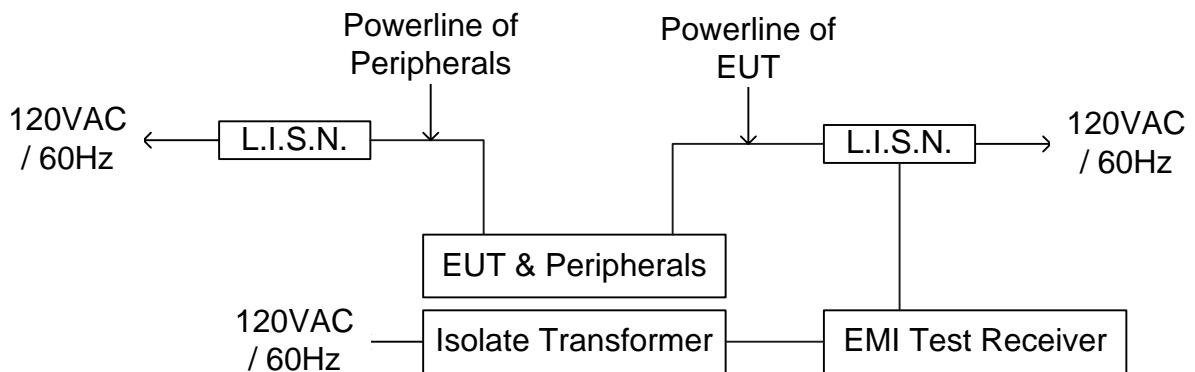
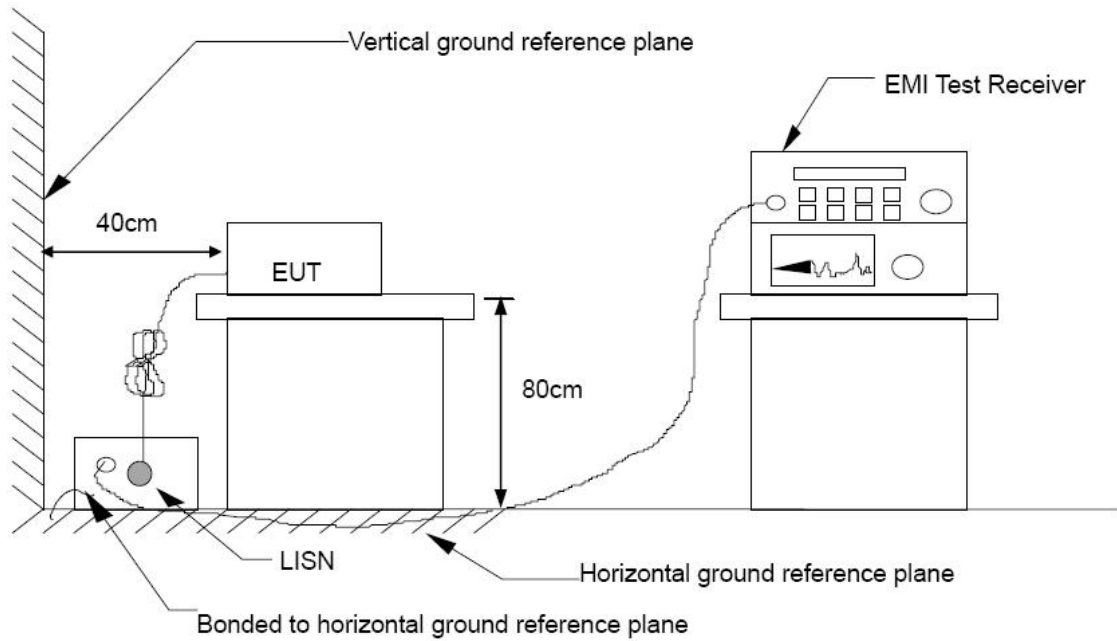



TEST PROCEDURE

The test procedure is performed in a 4m × 3m × 2.4m (L×W×H) shielded room.

The EUT along with its peripherals were placed on a 1.0m (W) × 1.5m (L) and 0.8m in height wooden table and the EUT was adjusted to maintain a 0.4 meter space from a vertical reference plane.

The EUT was connected to power mains through a line impedance stabilization network (LISN) which provides 50 ohm coupling impedance for measuring instrument and the chassis ground was bounded to the horizontal ground plane of shielded room. All peripherals were connected to the second LISN and the chassis ground also bounded to the horizontal ground plane of shielded room.

The EUT was located so that the distance between the boundary of the EUT and the closest surface of the LISN is 0.8 m. Where a mains flexible cord was provided by the manufacturer shall be 1 m long, or if in excess of 1 m, the excess cable was folded back and forth as far as possible so as to form a bundle not exceeding 0.4 m in length.



TEST RESULTS

Product Name	Universal Bluetooth Headset	Test By	Rick Lin
Model	HK201	Test Date	2010/03/15
Test Mode	Power Adapter	TEMP & Humidity	24.5°C, 67%

LINE

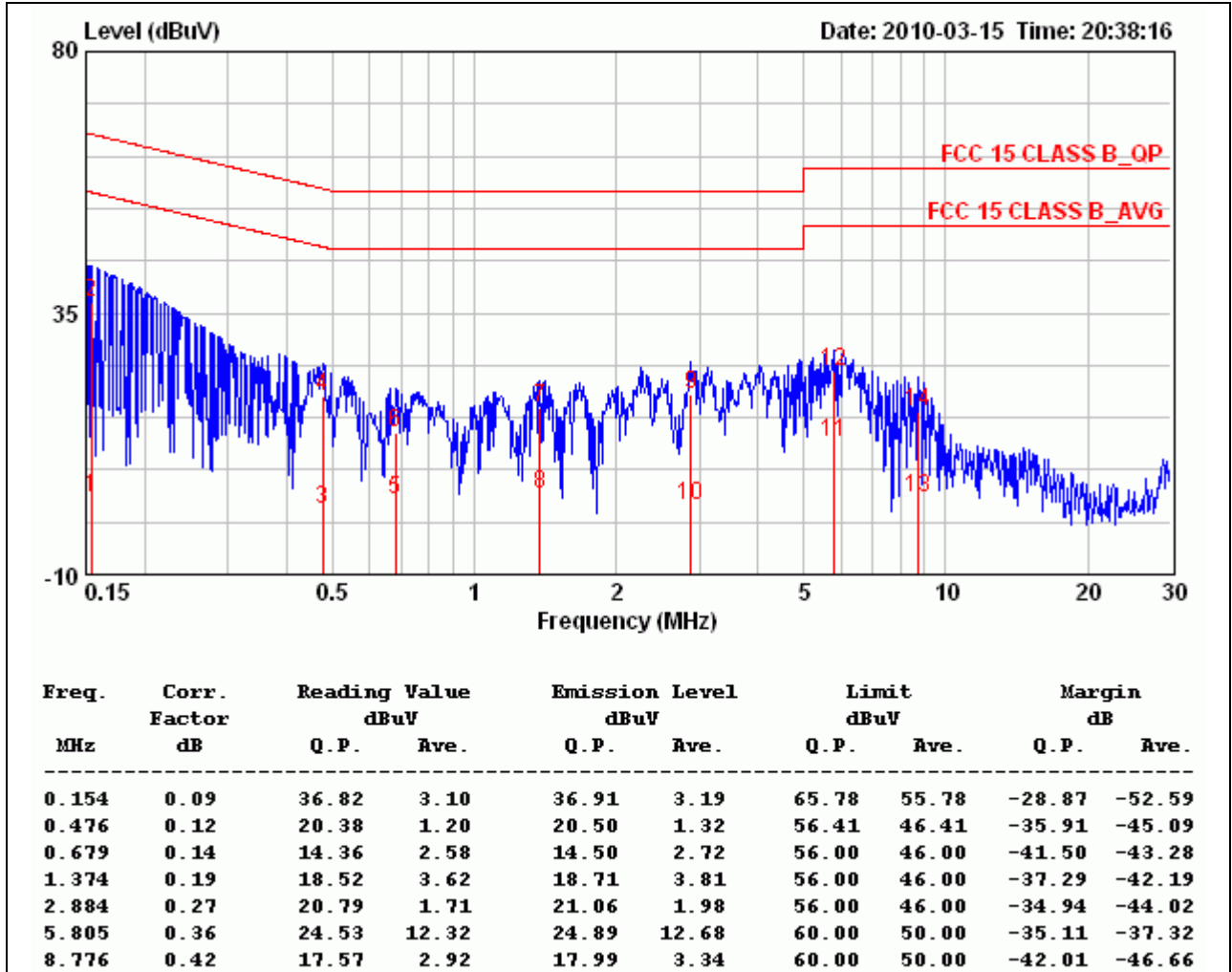

Remark:

1. Correction Factor = Insertion loss + cable loss
2. Margin value = Emission level – Limit value



Product Name	Universal Bluetooth Headset	Test By	Rick Lin
Model	HK201	Test Date	2010/03/15
Test Mode	Power Adapter	TEMP & Humidity	24.5°C, 67%

NEUTRAL

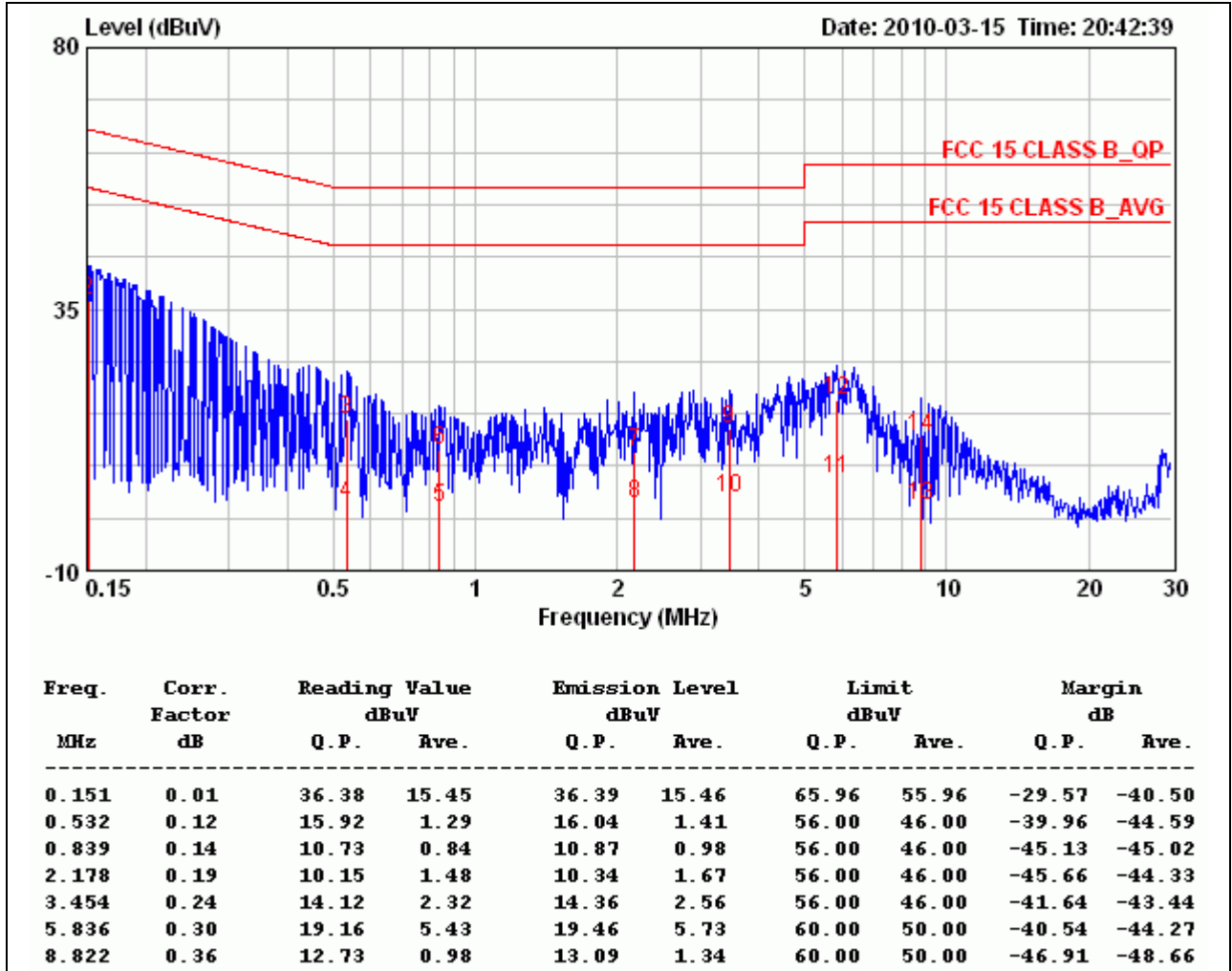

Remark:

1. Correction Factor = Insertion loss + cable loss
2. Margin value = Emission level – Limit value



Product Name	Universal Bluetooth Headset	Test By	Rick Lin
Model	HK201	Test Date	2010/03/15
Test Mode	Charge Mode	TEMP & Humidity	24.5°C, 67%

LINE

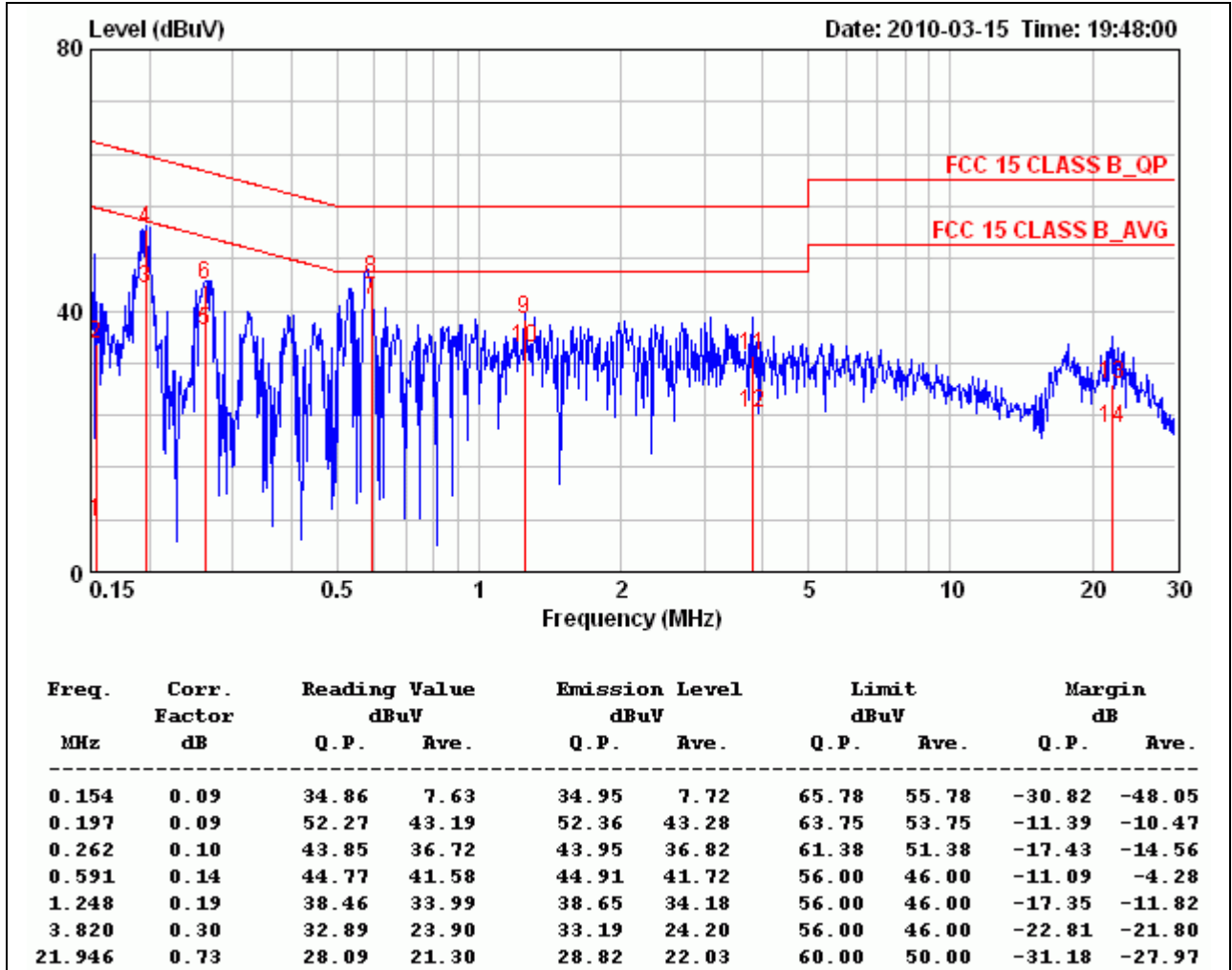

Remark:

1. Correction Factor = Insertion loss + cable loss
2. Margin value = Emission level – Limit value



Product Name	Universal Bluetooth Headset	Test By	Rick Lin
Model	HK201	Test Date	2010/03/15
Test Mode	Charge Mode	TEMP & Humidity	24.5°C, 67%

NEUTRAL

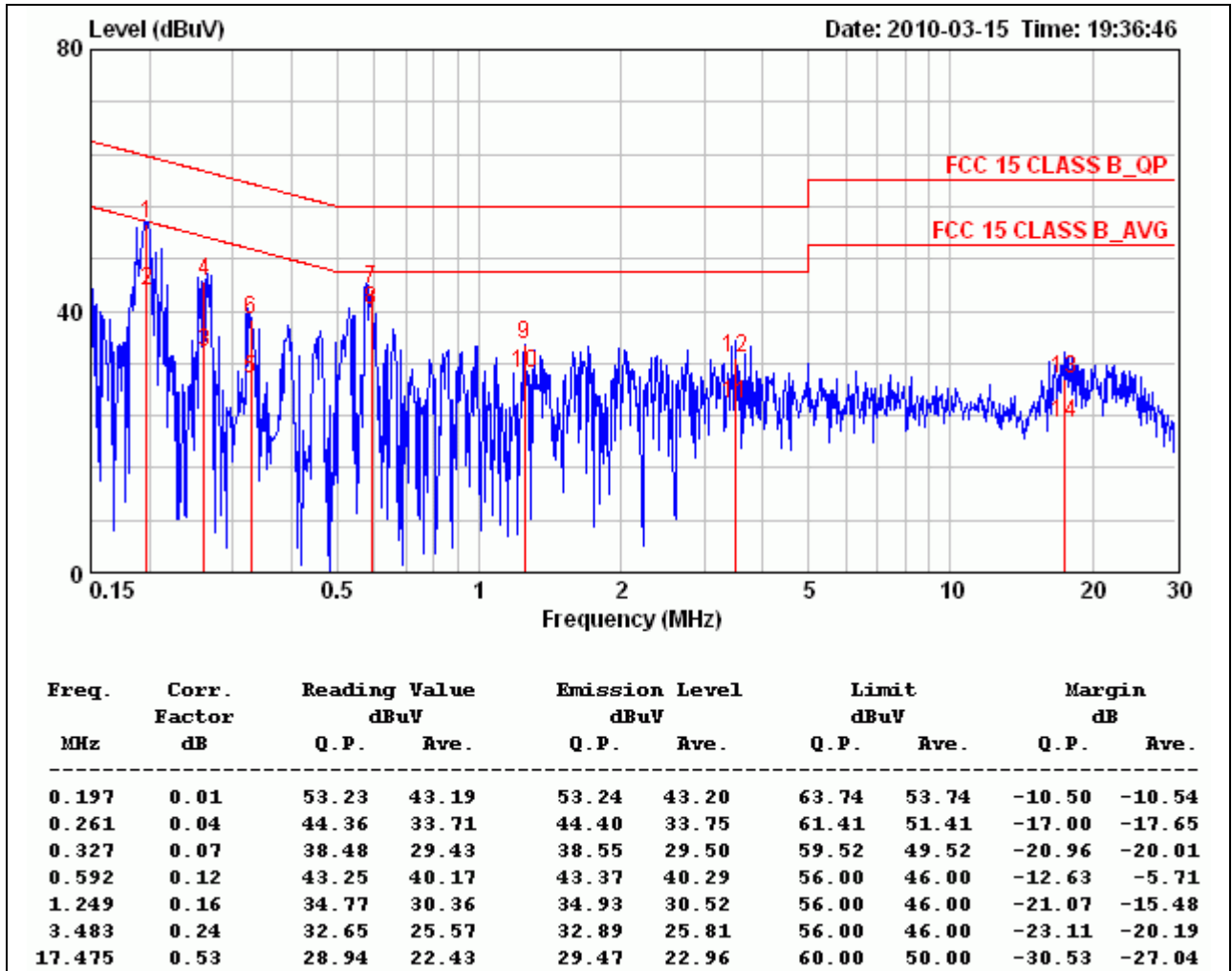

Remark:

1. Correction Factor = Insertion loss + cable loss
2. Margin value = Emission level – Limit value