



FCC RF Test Report

APPLICANT : Motorola Mobility LLC
EQUIPMENT : Mobile Cellular Phone
BRAND NAME : Motorola
MODEL NAME : XT2083-1
FCC ID : IHDT56ZD5
STANDARD : FCC Part 15 Subpart E §15.407
CLASSIFICATION : (NII) Unlicensed National Information Infrastructure

The product was received on Apr. 21, 2020 and testing was completed on Jun. 16, 2020. We, Sporton International (Kunshan) Inc., would like to declare that the tested sample has been evaluated in accordance with the test procedures and has been in compliance with the applicable technical standards.

The test results in this report apply exclusively to the tested model / sample. Without written approval of Sporton International (Kunshan) Inc., the test report shall not be reproduced except in full.

Jason Jia

Reviewed by: Jason Jia / Supervisor

James Huang

Approved by: James Huang / Manager



Sporton International (Kunshan) Inc.

**No. 1098, Pengxi North Road, Kunshan Economic Development Zone Jiangsu Province 215300
People's Republic of China**



TABLE OF CONTENTS

REVISION HISTORY..... 3

SUMMARY OF TEST RESULT 4

1 GENERAL DESCRIPTION 5

 1.1 Applicant 5

 1.2 Manufacturer 5

 1.3 Product Feature of Equipment Under Test 5

 1.4 Product Specification of Equipment Under Test 6

 1.5 Modification of EUT 7

 1.6 Testing Location 7

 1.7 Test Software 7

 1.8 Applicable Standards 8

 1.9 Specification of Accessory 8

2 TEST CONFIGURATION OF EQUIPMENT UNDER TEST 10

 2.1 Carrier Frequency and Channel 10

 2.2 Test Mode 11

 2.3 Connection Diagram of Test System 13

 2.4 Support Unit used in test configuration and system 14

 2.5 EUT Operation Test Setup 14

 2.6 Measurement Results Explanation Example 14

3 TEST RESULT 15

 3.1 26dB & 99% Occupied Bandwidth Measurement 15

 3.2 Maximum Conducted Output Power Measurement 17

 3.3 Power Spectral Density Measurement 19

 3.4 Unwanted Emissions Measurement 22

 3.5 AC Conducted Emission Measurement 27

 3.6 Automatically Discontinue Transmission 29

 3.7 Antenna Requirements 30

4 LIST OF MEASURING EQUIPMENT 31

5 UNCERTAINTY OF EVALUATION 32

APPENDIX A. CONDUCTED TEST RESULTS

APPENDIX B. AC CONDUCTED EMISSION TEST RESULT

APPENDIX C. RADIATED SPURIOUS EMISSION

APPENDIX D. DUTY CYCLE PLOTS

APPENDIX E. SETUP PHOTOGRAPHS



SUMMARY OF TEST RESULT

Report Section	FCC Rule	Description	Limit	Result	Remark
3.1	2.1049 & 15.403(i)	26dB & 99% Bandwidth	-	Pass	-
3.2	15.407(a)	Maximum Conducted Output Power	≤ 24 dBm	Pass	-
3.3	15.407(a)	Power Spectral Density	≤ 11 dBm	Pass	-
3.4	15.407(b)	Unwanted Emissions	15.407(b) & 15.209(a)	Pass	Under limit 3.33 dB at 5387.280 MHz
3.5	15.207	AC Conducted Emission	15.207(a)	Pass	Under limit 11.50 dB at 0.198 MHz
3.6	15.407(c)	Automatically Discontinue Transmission	Discontinue Transmission	Pass	-
3.7	15.203 & 15.407(a)	Antenna Requirement	N/A	Pass	-

Declaration of Conformity:
The test results with all measurement uncertainty excluded are presented in accordance with the regulation limits or requirements declared by manufacturers.
Comments and Explanations:
The declared of product specification for EUT presented in the report are provided by the manufacturer, and the manufacturer takes all the responsibilities for the accuracy of product specification.



1 General Description

1.1 Applicant

Motorola Mobility LLC
222 W,Merchandise Mart Plaza,Chicago,IL60654 USA

1.2 Manufacturer

Motorola Mobility LLC
222 W,Merchandise Mart Plaza,Chicago,IL60654 USA

1.3 Product Feature of Equipment Under Test

Product Feature	
Equipment	Mobile Cellular Phone
Brand Name	Motorola
Model Name	XT2083-1
FCC ID	IHDT56ZD5
EUT supports Radios application	GSM/WCDMA/LTE WLAN 2.4GHz 802.11b/g/n HT20 WLAN 5GHz 802.11a/n HT20/HT40 WLAN 5GHz 802.11ac VHT20/VHT40/VHT80 Bluetooth BR / EDR / LE FM Receiver / GNSS
IMEI Code	Conducted : N/A Conduction : 355530110015754/355530110015762 Radiation : 355531110011389
HW Version	DVT2
SW Version	QPX30.34
EUT Stage	Production Unit

Remark: The above EUT's information was declared by manufacturer. Please refer to the specifications or user's manual for more detailed description.



1.4 Product Specification of Equipment Under Test

Standards-related Product Specification	
Tx/Rx Frequency Range	5180 MHz ~ 5240 MHz 5260 MHz ~ 5320 MHz 5500 MHz ~ 5720 MHz
Maximum Output Power to Antenna	<p><5180 MHz ~ 5240 MHz> 802.11a : 17.90 dBm / 0.0617 W 802.11n HT20 : 16.90 dBm / 0.0490 W 802.11n HT40 : 16.08 dBm / 0.0406 W 802.11ac VHT20 : 16.91 dBm / 0.0491 W 802.11ac VHT40 : 16.96 dBm / 0.0497 W 802.11ac VHT80 : 16.18 dBm / 0.0415 W</p> <p><5260 MHz ~ 5320 MHz> 802.11a : 17.86 dBm / 0.0611 W 802.11n HT20 : 16.89 dBm / 0.0489 W 802.11n HT40 : 15.86 dBm / 0.0385 W 802.11ac VHT20 : 16.94 dBm / 0.0494 W 802.11ac VHT40 : 16.88 dBm / 0.0488 W 802.11ac VHT80 : 15.58 dBm / 0.0361 W</p> <p><5500 MHz ~ 5720 MHz > 802.11a : 17.87 dBm / 0.0612 W 802.11n HT20 : 16.86 dBm / 0.0485 W 802.11n HT40 : 16.16 dBm / 0.0413 W 802.11ac VHT20 : 16.96 dBm / 0.0497 W 802.11ac VHT40 : 17.20 dBm / 0.0525 W 802.11ac VHT80 : 16.20 dBm / 0.0417 W</p>
99% Occupied Bandwidth	<p><5180 MHz ~ 5240 MHz> 802.11a : 17.93 MHz 802.11ac VHT20 : 21.58 MHz 802.11ac VHT40 : 36.76 MHz 802.11ac VHT80 : 75.88 MHz</p> <p><5260 MHz ~ 5320 MHz> 802.11a : 18.08 MHz 802.11ac VHT20 : 19.03 MHz 802.11ac VHT40 : 36.56 MHz 802.11ac VHT80 : 75.76 MHz</p> <p><5500 MHz ~ 5720 MHz > 802.11a : 18.28 MHz 802.11ac VHT20 : 19.78 MHz 802.11ac VHT40 : 37.66 MHz 802.11ac VHT80 : 76.00 MHz</p>
Antenna Type / Gain	<p><5150 MHz ~ 5250 MHz> PIFA Antenna with gain -0.40 dBi</p> <p><5250 MHz ~ 5350 MHz> PIFA Antenna with gain -0.50 dBi</p> <p><5470 MHz ~ 5725 MHz> PIFA Antenna with gain -0.60 dBi</p>
Type of Modulation	802.11a/n : OFDM (BPSK / QPSK / 16QAM / 64QAM) 802.11ac : OFDM (BPSK / QPSK / 16QAM / 64QAM / 256QAM)

Note: For 802.11n HT20 / ac VHT20 and 802.11n HT40 / ac VHT40 mode, the whole testing have



assessed only 802.11ac VHT20/ VHT40 by referring to their maximum conducted power..

1.5 Modification of EUT

No modifications are made to the EUT during all test items.

1.6 Testing Location

Sporton International (Kunshan) Inc. is accredited to ISO/IEC 17025:2017 by American Association for Laboratory Accreditation with Certificate Number 5145.02.

Test Firm	Sporton International (Kunshan) Inc.		
Test Site Location	No. 1098, Pengxi North Road, Kunshan Economic Development Zone Jiangsu Province 215300 People's Republic of China TEL : +86-512-57900158 FAX : +86-512-57900958		
Test Site No.	Sporton Site No.	FCC Designation No.	FCC Test Firm Registration No.
	CO01-KS TH01-KS	CN1257	314309

Sporton International (Shenzhen) Inc. is accredited to ISO/IEC 17025:2017 by American Association for Laboratory Accreditation with Certificate Number 5145.01.

Test Firm	Sporton International (Shenzhen) Inc.		
Test Site Location	No. 3 Bldg the third floor of south, Shahe River west, Fengzeyuan Warehouse, Nanshan Shenzhen, 518055 People's Republic of China TEL: +86-755-33202398		
Test Site No.	Sporton Site No.	FCC Designation No.	FCC Test Firm Registration No.
	03CH02-SZ	CN1256	421272

1.7 Test Software

Item	Site	Manufacture	Name	Version
1.	CO01-KS	AUDIX	E3	6.2009-8-24
2.	03CH02-SZ	AUDIX	E3	6.2009-8-24a



1.8 Applicable Standards

According to the specifications of the manufacturer, the EUT must comply with the requirements of the following standards:

- ♦ 47 CFR Part 15 Subpart E
- ♦ FCC KDB 789033 D02 General UNII Test Procedures New Rules v02r01.
- ♦ ANSI C63.10-2013

Remark:

1. All test items were verified and recorded according to the standards and without any deviation during the test.
2. This EUT has also been tested and complied with the requirements of FCC Part 15, Subpart B, recorded in a separate test report.

1.9 Specification of Accessory

Specification of Accessory				
AC Adapter 1(US)	Brand Name	Motorola (Acbel)	Model Name	MC-201
AC Adapter 1(EU)	Brand Name	Motorola (Acbel)	Model Name	MC-202
AC Adapter 1(UK)	Brand Name	Motorola (Acbel)	Model Name	MC-203
AC Adapter 1(AU)	Brand Name	Motorola (Acbel)	Model Name	MC-205
AC Adapter 1(AR)	Brand Name	Motorola (Acbel)	Model Name	MC-206
AC Adapter 1(BR)	Brand Name	Motorola (Acbel)	Model Name	MC-207
AC Adapter 1(Chile)	Brand Name	Motorola (Acbel)	Model Name	MC-209
AC Adapter 2(US)	Brand Name	Motorola (Chenyang)	Model Name	MC-201
AC Adapter 2(EU)	Brand Name	Motorola (Chenyang)	Model Name	MC-202
AC Adapter 2(UK)	Brand Name	Motorola (Chenyang)	Model Name	MC-203
AC Adapter 2(IN)	Brand Name	Motorola (Chenyang)	Model Name	MC-204
AC Adapter 2(AU)	Brand Name	Motorola (Chenyang)	Model Name	MC-205
AC Adapter 2(AR)	Brand Name	Motorola (Chenyang)	Model Name	MC-206
AC Adapter 2(BR)	Brand Name	Motorola (Chenyang)	Model Name	MC-207
AC Adapter 3(BR)	Brand Name	Motorola (Flex/Salom)	Model Name	SC-57
AC Adapter 4(BR)	Brand Name	Motorola (Cliptech/Tenpao)	Model Name	SC-57
Battery	Brand Name	Motorola(ATL)	Model Name	JK50



Earphone 1	Brand Name	Motorola (New Leader)	Model Name	EM09
Earphone 2	Brand Name	Motorola(Lyand)	Model Name	MH191
Earphone 3	Brand Name	Motorola (Juwei)	Model Name	JWEP1123-T03
Earphone 4	Brand Name	Motorola (Lchse)	Model Name	MH191
USB Cable 1	Brand Name	Motorola (Yihuaxing)	Model Name	T365-008
USB Cable 2	Brand Name	Motorola (Saibao)	Model Name	STN-A110
USB Cable 3	Brand Name	Motorola (I SHENG)	Model Name	SC18C28955



2 Test Configuration of Equipment Under Test

- a. The EUT has been associated with peripherals and configuration operated in a manner tended to maximize its emission characteristics in a typical application. Frequency range investigated: conduction emission (150 kHz to 30 MHz), radiation emission (9 kHz to the 10th harmonic of the highest fundamental frequency or to 40 GHz, whichever is lower). For radiated measurement, pre-scanned in three orthogonal panels, X, Y, Z. The worst cases (X plane) were recorded in this report.
- b. AC power line Conducted Emission was tested under maximum output power.

2.1 Carrier Frequency and Channel

Frequency Band	Channel	Freq. (MHz)	Channel	Freq. (MHz)
5150-5250 MHz Band 1 (U-NII-1)	36	5180	44	5220
	38*	5190	46*	5230
	40	5200	48	5240
	42 [#]	5210		

Frequency Band	Channel	Freq. (MHz)	Channel	Freq. (MHz)
5250-5350 MHz Band 2 (U-NII-2A)	52	5260	60	5300
	54*	5270	62*	5310
	56	5280	64	5320
	58 [#]	5290		

Frequency Band	Channel	Freq. (MHz)	Channel	Freq. (MHz)
5470-5725 MHz Band 3 (U-NII-2C)	100	5500	112	5560
	102*	5510	116	5580
	104	5520	132	5660
	106 [#]	5530	134*	5670
	108	5540	136	5680
	110*	5550	140	5700



Frequency Band	Channel	Freq. (MHz)	Channel	Freq. (MHz)
TDWR Channel	118*	5590	124	5620
	120	5600	126*	5630
	122 [#]	5610	128	5640

Frequency Band	Channel	Freq. (MHz)	Channel	Freq. (MHz)
Straddle Channel	138 [#]	5690	144	5720
	142*	5710		

Note:

1. The above Frequency and Channel in "*" were 802.11n HT40 and 802.11ac VHT40.
2. The above Frequency and Channel in "[#]" were 802.11ac VHT80.

2.2 Test Mode

Final test modes are considering the modulation and worse data rates as below table.

Modulation	Data Rate
802.11a	6 Mbps
802.11ac VHT20	MCS0
802.11ac VHT40	MCS0
802.11ac VHT80	MCS0

Test Cases	
AC Conducted Emission	Mode 1 : GSM 850 Idle + Bluetooth Link + WLAN Link(5G) + Earphone + USB Cable 4(Charging from Adapter 4) + Battery 1
Remark: For Radiated Test Cases, The tests were performance with Adapter1, Battery, Earphone1 and USB Cable1.	



Ch. #		Band I : 5150-5250 MHz	Band II : 5250-5350 MHz	Band III : 5470-5725MHz
		802.11a	802.11a	802.11a
L	Low	36	52	100
M	Middle	44	60	116
H	High	48	64	140
Straddle		-	-	144

Ch. #		Band I : 5150-5250 MHz	Band II : 5250-5350 MHz	Band III : 5470-5725MHz
		802.11ac VHT20	802.11ac VHT20	802.11ac VHT20
L	Low	36	52	100
M	Middle	44	60	116
H	High	48	64	140
Straddle		-	-	144

Ch. #		Band I : 5150-5250 MHz	Band II : 5250-5350 MHz	Band III : 5470-5725MHz
		802.11ac VHT40	802.11ac VHT40	802.11ac VHT40
L	Low	38	54	102
M	Middle	-	-	110
H	High	46	62	134
Straddle		-	-	142

Ch. #		Band I : 5150-5250 MHz	Band II : 5250-5350 MHz	Band III : 5470-5725MHz
		802.11ac VHT80	802.11ac VHT80	802.11ac VHT80
L	Low	-	-	106
M	Middle	42	58	-
H	High	-	-	-
Straddle		-	-	138

2.3 Connection Diagram of Test System

For Radiation

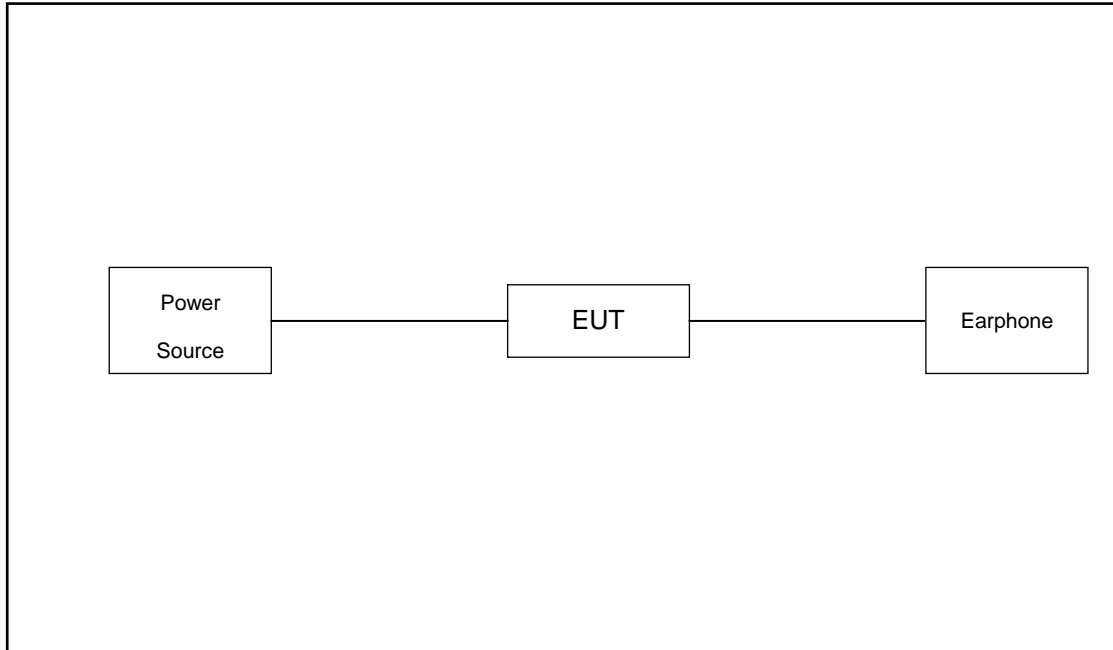

For Conducted Emission

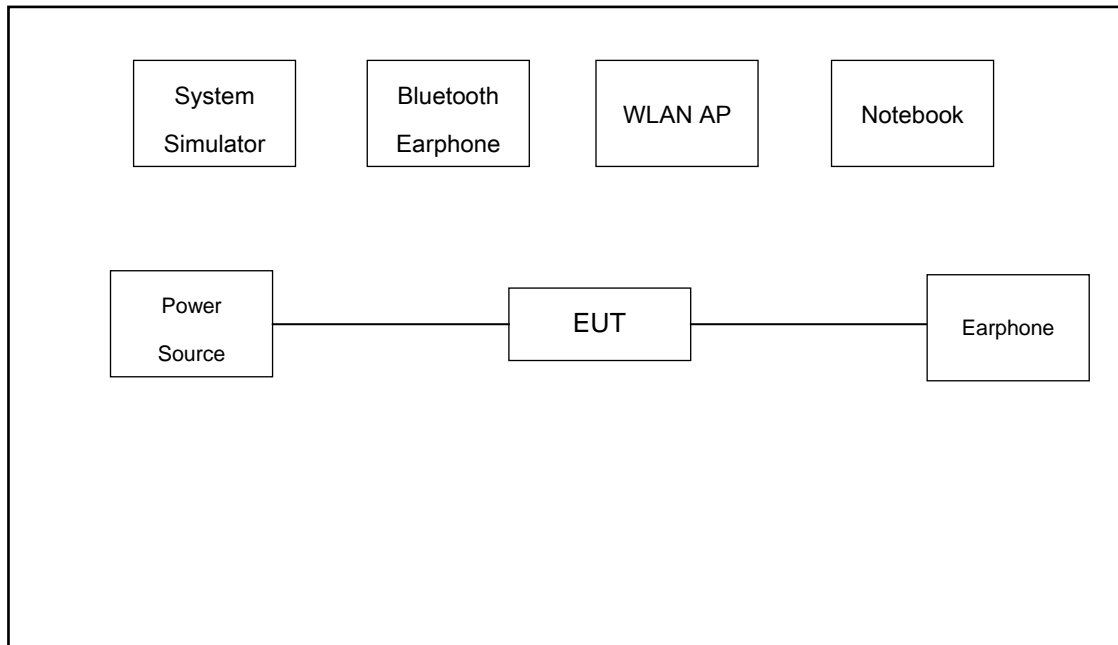

2.4 Support Unit used in test configuration and system

Item	Equipment	Trade Name	Model Name	FCC ID	Data Cable	Power Cord
1.	System Simulator	Anritsu	MT8820C	N/A	N/A	Unshielded, 1.8m
2.	WLAN AP	D-link	DIR-655	KA21R655B1	N/A	Unshielded, 1.8m
3.	Notebook	Lenovo	G480	QDS-BRCM1050I	N/A	AC I/P: Unshielded, 1.2 m DC O/P: Shielded, 1.8 m
4.	Bluetooth Earphone	Lenovo	LBH308	N/A	N/A	N/A
5.	SD Card	Kingston	8GB	N/A	N/A	N/A

2.5 EUT Operation Test Setup

For WLAN RF test items, an engineering test program was provided and enabled to make EUT continuously transmit/receive.

For AC power line conducted emissions, the EUT was set to connect with the WLAN AP under large package sizes transmission.

2.6 Measurement Results Explanation Example

For all conducted test items:

The offset level is set in the spectrum analyzer to compensate the RF cable loss and attenuator factor between EUT conducted output port and spectrum analyzer. With the offset compensation, the spectrum analyzer reading level is exactly the EUT RF output level.

Example :

The spectrum analyzer offset is derived from RF cable loss and attenuator factor.

Offset = RF cable loss.

Following shows an offset computation example with cable loss 6.3 dB.

$$\begin{aligned} \text{Offset(dB)} &= \text{RF cable loss(dB)}. \\ &= 6.3 \text{ (dB)} \end{aligned}$$

3 Test Result

3.1 26dB & 99% Occupied Bandwidth Measurement

3.1.1 Description of 26dB & 99% Occupied Bandwidth

This section is for reporting purpose only.

There is no restriction limits for bandwidth.

For Straddle Channel, According to KDB 789033 D02 General UNII Test Procedures New Rules v02r01, If the power and PSD of the devices are uniform and comply with the lower limits specified for the U-NII-2 bands, a single measurement over the entire emission bandwidth can be performed to show compliance.

3.1.2 Measuring Instruments

The measuring equipment is listed in the section 4 of this test report.

3.1.3 Test Procedures

1. The testing follows FCC KDB 789033 D02 General UNII Test Procedures New Rules v02r01. Section C) Emission bandwidth
2. Set RBW = approximately 1% of the emission bandwidth.
3. Set the VBW > RBW.
4. Detector = Peak.
5. Trace mode = max hold
6. Measure the maximum width of the emission that is 26 dB down from the peak of the emission. Compare this with the RBW setting of the analyzer. Readjust RBW and repeat measurement as needed until the RBW/EBW ratio is approximately 1%.
7. For 99% Bandwidth Measurement, the spectrum analyzer's resolution bandwidth (RBW) is set 1MHz and set the Video bandwidth (VBW) $\geq 3 * RBW$.
8. Measure and record the results in the test report.

3.1.4 Test Setup

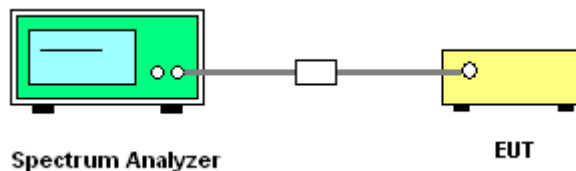



3.1.5 Test Result of 26dB & 99% Occupied Bandwidth

Please refer to Appendix A.

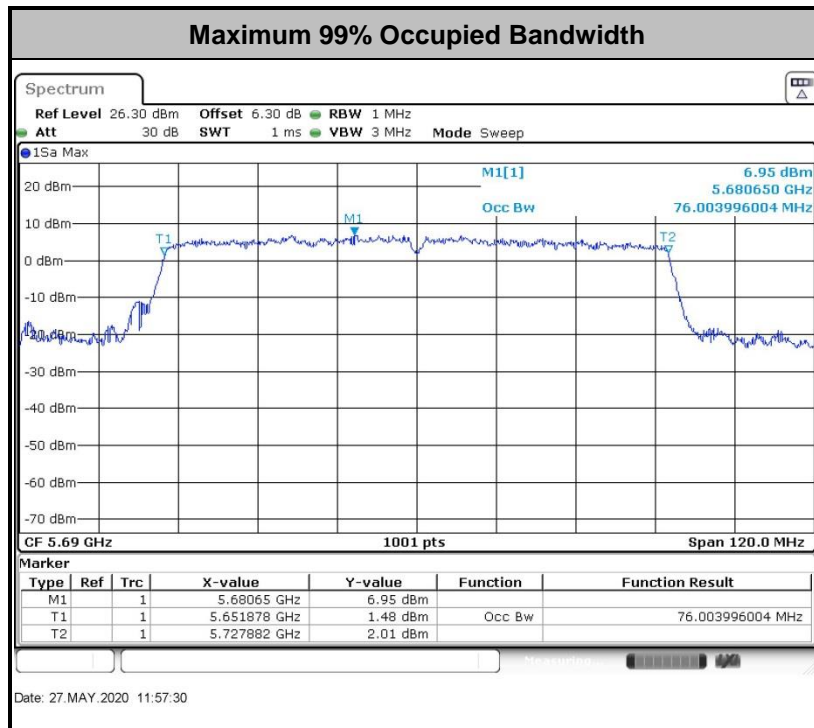
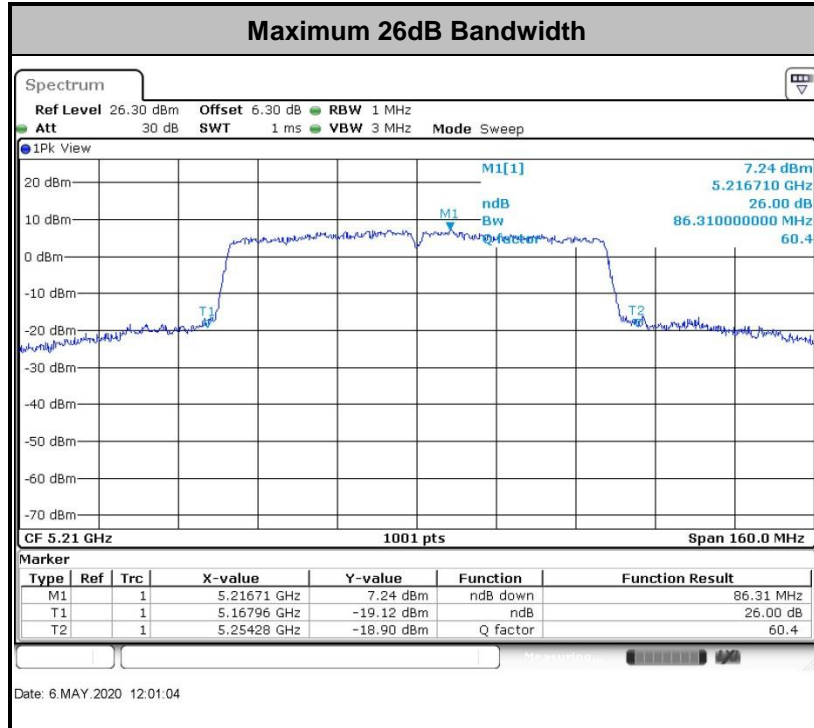

Note: The occupied channel bandwidth is maintained within the band of operation for all of the modulations.



3.2 Maximum Conducted Output Power Measurement

3.2.1 Limit of Maximum Conducted Output Power

<FCC 14-30 CFR 15.407>

For mobile and portable client devices in the 5.15–5.25 GHz band, the maximum conducted output power over the frequency band of operation shall not exceed 250 mW.

For the 5.25–5.725 GHz bands, the maximum conducted output power over the frequency bands of operation shall not exceed the lesser of 250 mW or $11 + 10 \log B$, dBm, where B is the 26 dB emission bandwidth in megahertz.

For the 5.47–5.6 GHz and 5.65–5.725 GHz band, the maximum conducted output power shall not exceed 250 mW or $11 + 10 \log_{10} B$, dBm, whichever power is less. The maximum e.i.r.p. shall not exceed 1.0 W or $17 + 10 \log_{10} B$, dBm, whichever is less. B is the 99% emission bandwidth in megahertz.

For Straddle Channel, According to KDB 789033 D02 General UNII Test Procedures New Rules v02r01, If the power and PSD of the devices are uniform and comply with the lower limits specified for the U-NII-2 bands, a single measurement over the entire emission bandwidth can be performed to show compliance.

If transmitting antennas of directional gain greater than 6 dBi are used, the peak output power shall be reduced by the amount in dB that the directional gain of the antenna exceeds 6 dBi.

Note that U-NII-2 band, devices with a maximum e.i.r.p. greater than 500 mW shall implement TPC in order to have the capability to operate at least 6 dB below the maximum permitted e.i.r.p. of 1 W.

3.2.2 Measuring Instruments

The measuring equipment is listed in the section 4 of this test report.

3.2.3 Test Procedures

The testing follows Method PM of FCC KDB 789033 D02 General UNII Test Procedures New Rules v02r01.

Method PM (Measurement using an RF average power meter):

1. Measurement is performed using a wideband RF power meter.
2. The EUT is configured to transmit continuously with a consistent duty cycle at its maximum power control level.
3. Measure the average power of the transmitter, and the average power is corrected with duty factor, $10 \log(1/x)$, where x is the duty cycle.

For Straddle Channel, According to KDB 789033 D02 General UNII Test Procedures New Rules v02r01, If the power and PSD of the devices are uniform and comply with the lower limits specified for the U-NII-2 bands, a single measurement over the entire emission bandwidth can be performed to show compliance.

3.2.4 Test Setup

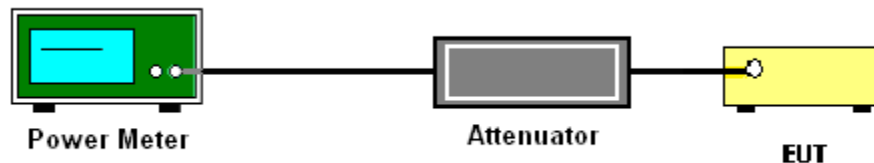

3.2.5 Test Result of Maximum Conducted Output Power

Please refer to Appendix A.



3.3 Power Spectral Density Measurement

3.3.1 Limit of Power Spectral Density

<FCC 14-30 CFR 15.407>

For mobile and portable client devices in the 5.15–5.25 GHz band, the maximum power spectral density shall not exceed 11dBm in any 1 megahertz band.

For the 5.25–5.725 GHz bands, the maximum power spectral density shall not exceed 11 dBm in any 1 megahertz band.

For Straddle Channel, According to KDB 789033 D02 General UNII Test Procedures New Rules v02r01, If the power and PSD of the devices are uniform and comply with the lower limits specified for the U-NII-2 bands, a single measurement over the entire emission bandwidth can be performed to show compliance.

If transmitting antennas of directional gain greater than 6 dBi are used, the peak output power shall be reduced by the amount in dB that the directional gain of the antenna exceeds 6 dBi.

3.3.2 Measuring Instruments

The measuring equipment is listed in the section 4 of this test report.

3.3.3 Test Procedures

The testing follows FCC KDB 789033 D02 General UNII Test Procedures New Rules v02r01.
Section F) Maximum power spectral density.

Method SA-2

(trace averaging across on and off times of the EUT transmissions, followed by duty cycle correction).

- Measure the duty cycle.
 - Set span to encompass the entire emission bandwidth (EBW) of the signal.
 - Set RBW = 1 MHz.
 - Set VBW \geq 3 MHz.
 - Number of points in sweep \geq 2 Span / RBW.
 - Sweep time = auto.
 - Detector = RMS
 - Trace average at least 100 traces in power averaging mode.
 - Add $10 \log(1/x)$, where x is the duty cycle, to the measured power in order to compute the average power during the actual transmission times. For example, add $10 \log(1/0.25) = 6$ dB if the duty cycle is 25 percent.
1. The RF output of EUT was connected to the spectrum analyzer by a low loss cable.
 2. Each plot has already offset with cable loss, and attenuator loss. Measure the PPSD and record it.

3.3.4 Test Setup

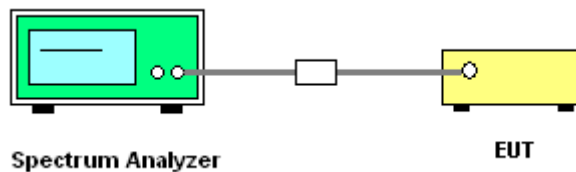



3.3.5 Test Result of Power Spectral Density

Please refer to Appendix A.

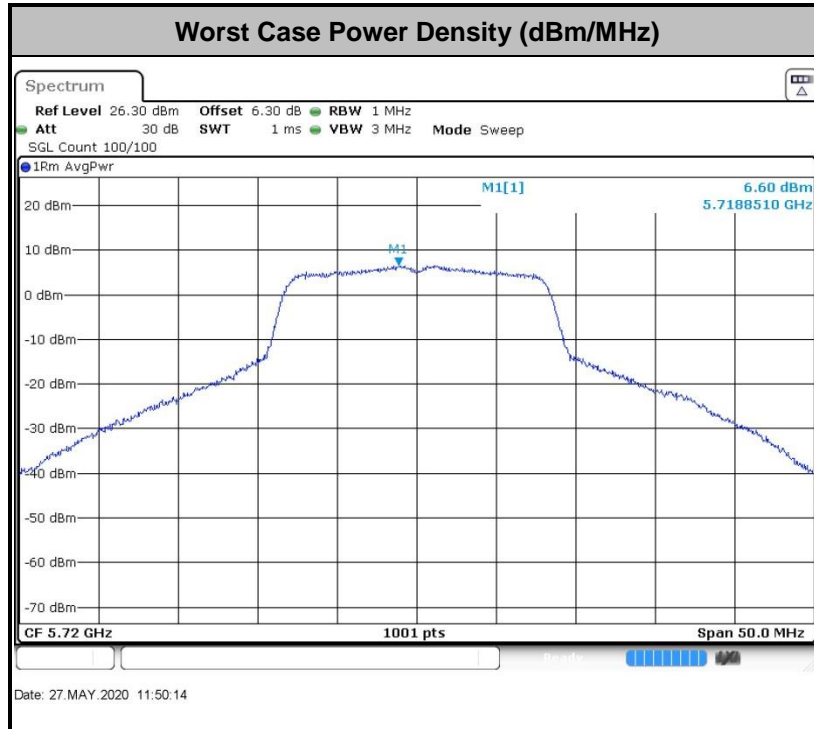



3.4 Unwanted Emissions Measurement

This section is to measure unwanted emissions through radiated measurement for band edge spurious emissions and out of band emissions measurement.

3.4.1 Limit of Unwanted Emissions

- (1) For transmitters operating in the 5150-5250 MHz band: all emissions outside of the 5150-5350 MHz band shall not exceed an EIRP of -27dBm/MHz.

For transmitters operating in the 5250-5350 MHz band: all emissions outside of the 5150-5350 MHz band shall not exceed an EIRP of -27 dBm/MHz. Devices operating in the 5250-5350 MHz band that generate emissions in the 5150-5250 MHz band must meet all applicable technical requirements for operation in the 5150-5250 MHz band (including indoor use) or alternatively meet an out-of-band emission EIRP limit of -27 dBm/MHz in the 5150-5250 MHz band.

For transmitters operating in the 5470-5600 MHz and 5650-5725MHz band: all emissions outside of the 5470-5600 MHz and 5650-5725MHz band shall not exceed an EIRP of -27 dBm/MHz.

- (2) Unwanted spurious emissions fallen in restricted bands shall comply with the general field strength limits as below table,

Frequency (MHz)	Field Strength (microvolts/meter)	Measurement Distance (meters)
0.009 – 0.490	2400/F(kHz)	300
0.490 – 1.705	24000/F(kHz)	30
1.705 – 30.0	30	30
30 – 88	100	3
88 – 216	150	3
216 - 960	200	3
Above 960	500	3



EIRP (dBm)	Field Strength at 3m (dBµV/m)
- 27	68.3

Note: The following formula is used to convert the EIRP to field strength.

$$EIRP = E_{Meas} + 20\log(d_{Meas}) - 104.8$$

where

EIRP is the equivalent isotropically radiated power, in dBm

E_{Meas} is the field strength of the emission at the measurement distance, in dBµV/m

d_{Meas} is the measurement distance, in m

3.4.2 Measuring Instruments

The measuring equipment is listed in the section 4 of this test report.

3.4.3 Test Procedures

- The testing follows FCC KDB 789033 D02 General UNII Test Procedures New Rules v02r01. Section G) Unwanted emissions measurement.

(1) Procedure for Unwanted Emissions Measurements Below 1000MHz

- RBW = 120 kHz
- VBW = 300 kHz
- Detector = Peak
- Trace mode = max hold

(2) Procedure for Peak Unwanted Emissions Measurements Above 1000 MHz

- RBW = 1 MHz
- VBW ≥ 3 MHz
- Detector = Peak
- Sweep time = auto
- Trace mode = max hold

(3) Procedures for Average Unwanted Emissions Measurements Above 1000MHz

- RBW = 1 MHz
- VBW = 10 Hz, when duty cycle is no less than 98 percent.
- VBW ≥ 1/T, when duty cycle is less than 98 percent where T is the minimum transmission duration over which the transmitter is on and is transmitting at its maximum power control level for the tested mode of operation.

- The EUT was placed on a turntable with 0.8 meter for frequency below 1GHz and 1.5 meter for frequency above 1GHz respectively above ground.
- The EUT was set 3 meters from the interference receiving antenna which was mounted on the top of a variable height antenna tower.
- The antenna is a broadband antenna and its height is adjusted between one meter and four meters above ground to find the maximum value of the field strength for both horizontal



polarization and vertical polarization of the antenna.

5. For each suspected emission, the EUT was arranged to its worst case and then adjust the antenna tower (from 1 m to 4 m) and turntable (from 0 degree to 360 degrees) to find the maximum reading.
6. For testing below 1GHz, if the emission level of the EUT in peak mode was 3 dB lower than the limit specified, then peak values of EUT will be reported, otherwise, the emissions will be repeated one by one using the CISPR quasi-peak method and reported.
7. For testing above 1GHz, the emission level of the EUT in peak mode was 20dB lower than average limit (that means the emission level in average mode also complies with the limit in average mode), then peak values of EUT will be reported, otherwise, the emissions will be measured in average mode again and reported.

3.4.4 Test Setup

For radiated emissions below 30MHz

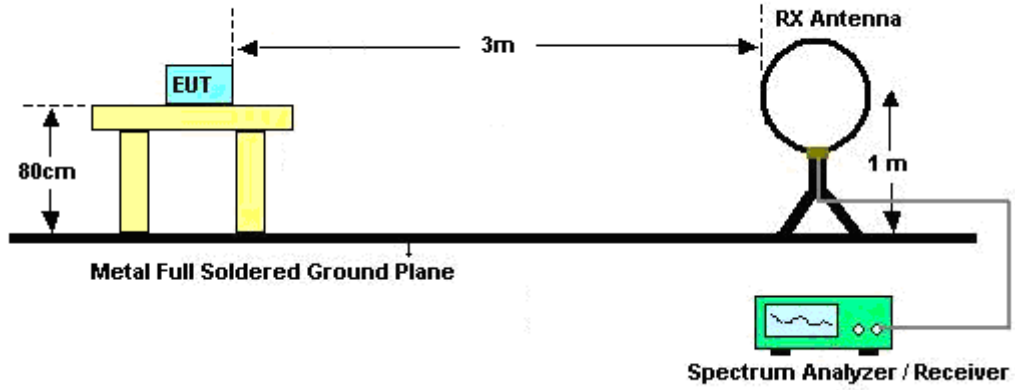

For radiated emissions from 30MHz to 1GHz

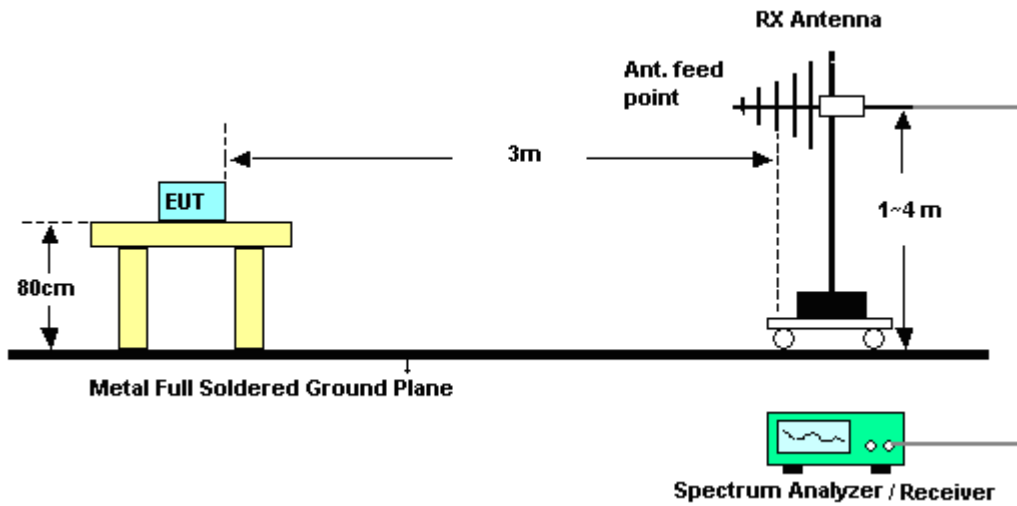

For radiated emissions above 1GHz

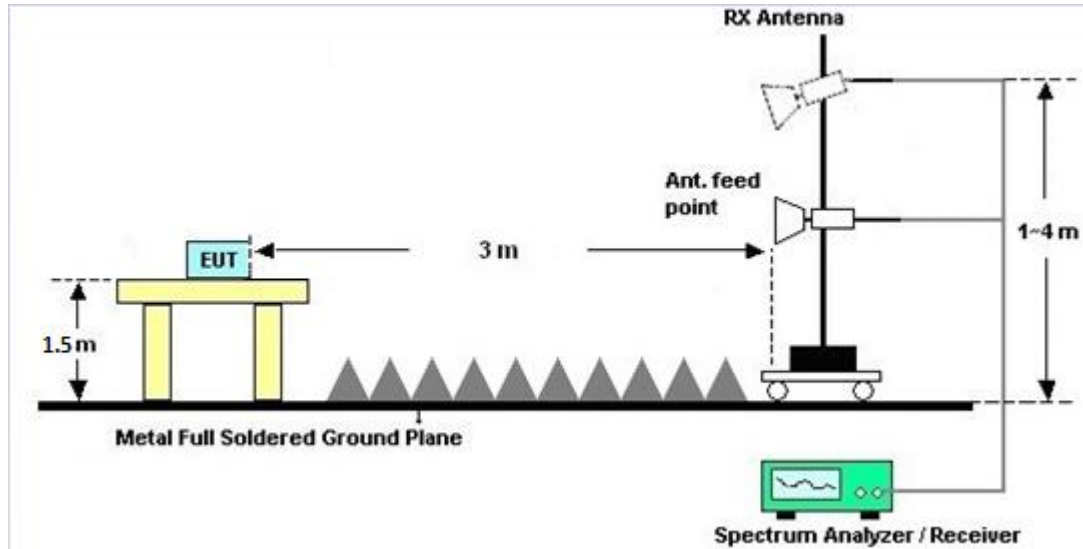

3.4.5 Test Results of Radiated Spurious Emissions (9 kHz ~ 30 MHz)

The low frequency, which started from 9 kHz to 30MHz, was pre-scanned and the result which was 20dB lower than the limit line was not reported.

There is a comparison data of both open-field test site and semi-Anechoic chamber, and the result came out very similar.

3.4.6 Test Result of Radiated Spurious at Band Edges

Please refer to Appendix C.

3.4.7 Duty Cycle

Please refer to Appendix D.

3.4.8 Test Result of Radiated Spurious Emissions (30MHz ~ 10th Harmonic)

Please refer to Appendix C.



3.5 AC Conducted Emission Measurement

3.5.1 Limit of AC Conducted Emission

For equipment that is designed to be connected to the public utility (AC) power line, the radio frequency voltage that is conducted back onto the AC power line on any frequency or frequencies within the band 150 kHz to 30 MHz shall not exceed the limits in the following table.

Frequency of emission (MHz)	Conducted limit (dBµV)	
	Quasi-peak	Average
0.15-0.5	66 to 56*	56 to 46*
0.5-5	56	46
5-30	60	50

*Decreases with the logarithm of the frequency.

3.5.2 Measuring Instruments

The measuring equipment is listed in the section 4 of this test report.

3.5.3 Test Procedures

1. The EUT was placed 0.4 meter from the conducting wall of the shielding room was kept at least 80 centimeters from any other grounded conducting surface.
2. Connect EUT to the power mains through a line impedance stabilization network (LISN).
3. All the support units are connecting to the other LISN.
4. The LISN provides 50 ohm coupling impedance for the measuring instrument.
5. The FCC states that a 50 ohm, 50 microhenry LISN should be used.
6. Both sides of AC line were checked for maximum conducted interference.
7. The frequency range from 150 kHz to 30 MHz was searched.
8. Set the test-receiver system to Peak Detect Function and specified bandwidth with Maximum Hold Mode.

3.5.4 Test Setup

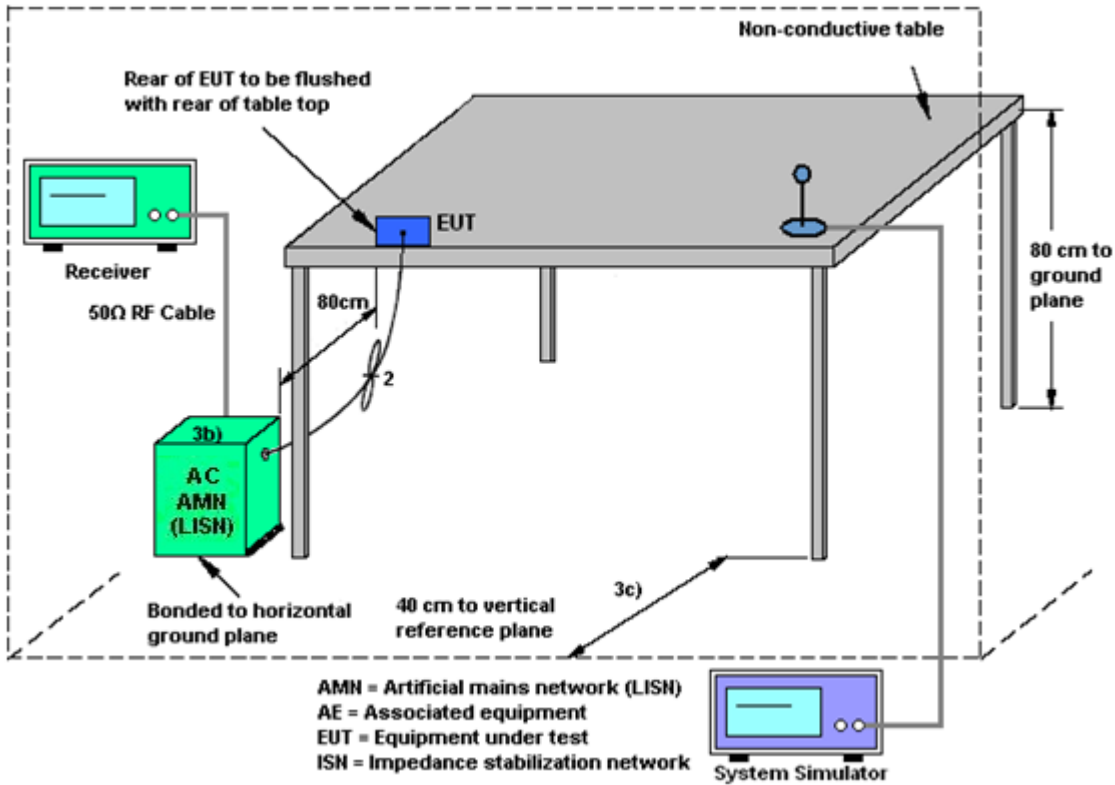

3.5.5 Test Result of AC Conducted Emission

Please refer to Appendix B.



3.6 Automatically Discontinue Transmission

3.6.1 Limit of Automatically Discontinue Transmission

The device shall automatically discontinue transmission in case of either absence of information to transmit or operational failure. These provisions are not intended to preclude the transmission of control or signaling information or the use of repetitive codes used by certain digital technologies to complete frame or burst intervals. Applicants shall include in their application for equipment authorization to describe how this requirement is met.

3.6.2 Measuring Instruments

The measuring equipment is listed in the section 4 of this test report.

3.6.3 Test Result of Automatically Discontinue Transmission

While the EUT is not transmitting any information, the EUT can automatically discontinue transmission and become standby mode for power saving. The EUT can detect the controlling signal of ACK message transmitting from remote device and verify whether it shall resend or discontinue transmission.



3.7 Antenna Requirements

3.7.1 Standard Applicable

If transmitting antenna directional gain is greater than 6 dBi, both the peak transmit power and the peak power spectral density shall be reduced by the amount in dB that the directional gain of the antenna exceeds 6 dBi.

3.7.2 Antenna Anti-Replacement Construction

An embedded-in antenna design is used.

3.7.3 Antenna Gain

The antenna peak gain of EUT is less than 6 dBi. Therefore, it is not necessary to reduce maximum peak output power limit.



4 List of Measuring Equipment

Instrument	Manufacturer	Model No.	Serial No.	Characteristics	Calibration Date	Test Date	Due Date	Remark
Spectrum Analyzer	R&S	FSV40	101040	10Hz~40GHz	Nov. 02, 2019	May 06, 2020~ May 27, 2020	Nov. 01, 2020	Conducted (TH01-KS)
Pulse Power Sensor	Anritsu	MA2411B	0917070	300MHz~40GHz	Jan. 15, 2020	May 06, 2020~ May 27, 2020	Jan. 14, 2021	Conducted (TH01-KS)
Power Meter	Anritsu	ML2495A	1005002	50MHz Bandwidth	Jan. 08, 2020	May 06, 2020~ May 27, 2020	Jan. 07, 2021	Conducted (TH01-KS)
EXA Spectrum Analyzer	KEYSIGHT	N9010A	MY55150213	10Hz~44GHz	Apr. 17, 2020	Jun. 16, 2020	Apr. 16, 2021	Radiation (03CH02-SZ)
Loop Antenna	R&S	HFH2-Z2	100354	9kHz~30MHz	May 28, 2020	Jun. 16, 2020	May 27, 2022	Radiation (03CH02-SZ)
Bilog Antenna	TeseQ	CBL6112D	35407	30MHz~2GHz	Jul. 19, 2019	Jun. 16, 2020	Jul. 18, 2020	Radiation (03CH02-SZ)
Double Ridge Horn Antenna	ETS-Lindgren	3117	00119436	1GHz~18GHz	Aug. 27, 2019	Jun. 16, 2020	Aug. 26, 2020	Radiation (03CH02-SZ)
HF Amplifier	MITEQ	TTA1840-35-HG	1871923	18GHz~40GHz	Jul. 22, 2019	Jun. 16, 2020	Jul. 21, 2020	Radiation (03CH02-SZ)
SHF-EHF Horn	com-power	AH-840	101071	18GHz~40GHz	Apr. 17, 2020	Jun. 16, 2020	Apr. 16, 2021	Radiation (03CH02-SZ)
LF Amplifier	Burgeon	BPA-530	102211	0.01~3000Mhz	Oct. 18, 2019	Jun. 16, 2020	Oct. 17, 2020	Radiation (03CH02-SZ)
HF Amplifier	MITEQ	AMF-7D-00101800-30-10P-R	1943528	1GHz~18GHz	Oct. 18, 2019	Jun. 16, 2020	Oct. 17, 2020	Radiation (03CH02-SZ)
HF Amplifier	KEYSIGHT	83017A	MY53270105	0.5GHz~26.5GHz	Oct. 18, 2019	Jun. 16, 2020	Oct. 17, 2020	Radiation (03CH02-SZ)
AC Power Source	Chroma	61601	616010002470	N/A	NCR	Jun. 16, 2020	NCR	Radiation (03CH02-SZ)
Turn Table	Chaintek	T-200	N/A	0~360 degree	NCR	Jun. 16, 2020	NCR	Radiation (03CH02-SZ)
Antenna Mast	Chaintek	MBS-400	N/A	1 m~4 m	NCR	Jun. 16, 2020	NCR	Radiation (03CH02-SZ)
EMI Receiver	R&S	ESCI7	100768	9kHz~7GHz;	Apr. 14, 2020	May 09, 2020	Apr. 13, 2021	Conduction (CO01-KS)
AC LISN (for auxiliary equipment)	MessTec	AN3016	060103	9kHz~30MHz	Oct. 18, 2019	May 09, 2020	Oct. 17, 2020	Conduction (CO01-KS)
AC LISN	MessTec	AN3016	060105	9kHz~30MHz	Oct. 28, 2019	May 09, 2020	Oct. 27, 2020	Conduction (CO01-KS)
AC Power Source	Chroma	61602	ABP00000811	AC 0V~300V, 45Hz~1000Hz	Oct. 18, 2019	May 09, 2020	Oct. 17, 2020	Conduction (CO01-KS)

NCR: No Calibration Required



5 Uncertainty of Evaluation

The measurement uncertainties shown below were calculated in accordance with the requirements of ANSI 63.10-2013. All the measurement uncertainty value were shown with a coverage K=2 to indicate 95% level of confidence. The measurement data show herein meets or exceeds the CISPR measurement uncertainty values specified in CISPR 16-4-2 and can be compared directly to specified limit to determine compliance.

Uncertainty of Conducted Emission Measurement (150kHz ~ 30MHz)

Measuring Uncertainty for a Level of Confidence of 95% (U = 2Uc(y))	2.9dB
---	-------

Uncertainty of Radiated Emission Measurement (30 MHz ~ 1000 MHz)

Measuring Uncertainty for a Level of Confidence of 95% (U = 2Uc(y))	5.0dB
---	-------

Uncertainty of Radiated Emission Measurement (1000 MHz ~ 18000 MHz)

Measuring Uncertainty for a Level of Confidence of 95% (U = 2Uc(y))	5.0dB
---	-------

Uncertainty of Radiated Emission Measurement (18000 MHz ~ 40000 MHz)

Measuring Uncertainty for a Level of Confidence of 95% (U = 2Uc(y))	4.4dB
---	-------



Appendix A. Conducted Test Results

Report Number : FR042102D

Test Engineer:	Asa Cheng	Temperature:	21~25	°C
Test Date:	2020/5/6~2020/5/27	Relative Humidity:	51~54	%

TEST RESULTS DATA
26dB and 99% OBW

Band I										
Mod.	Data Rate	N _{Tx}	CH.	Freq. (MHz)	99% Bandwidth (MHz)	26 dB Bandwidth (MHz)	IC 99% Bandwidth Power Limit (dBm)	IC 99% Bandwidth EIRP Limit (dBm)		
11a	6Mbps	1	36	5180	17.83	27.37	-	22.51		
11a	6Mbps	1	44	5220	17.93	27.22	-	22.54		
11a	6Mbps	1	48	5240	17.68	25.82	-	22.48		
VHT20	MCS0	1	36	5180	18.83	26.42	-	22.75		
VHT20	MCS0	1	44	5220	21.58	36.81	-	23.01		
VHT20	MCS0	1	48	5240	18.78	26.82	-	22.74		
VHT40	MCS0	1	38	5190	36.76	42.35	-	23.01		
VHT40	MCS0	1	46	5230	36.66	42.26	-	23.01		
VHT80	MCS0	1	42	5210	75.88	86.31	-	23.01		

TEST RESULTS DATA
Average Power Table

FCC Band I										
Mod.	Data Rate	N _{Tx}	CH.	Freq. (MHz)	Duty Factor (dB)	Average Conducted Power (dBm)	FCC Conducted Power Limit (dBm)	DG (dBi)		Pass/Fail
11a	6Mbps	1	36	5180	0.08	17.90	24.00	-0.40		Pass
11a	6Mbps	1	44	5220	0.08	17.83	24.00	-0.40		Pass
11a	6Mbps	1	48	5240	0.08	17.36	24.00	-0.40		Pass
HT20	MCS0	1	36	5180	0.08	16.90	24.00	-0.40		Pass
HT20	MCS0	1	44	5220	0.08	16.73	24.00	-0.40		Pass
HT20	MCS0	1	48	5240	0.08	16.20	24.00	-0.40		Pass
HT40	MCS0	1	38	5190	0.16	16.08	24.00	-0.40		Pass
HT40	MCS0	1	46	5230	0.16	15.66	24.00	-0.40		Pass
VHT20	MCS0	1	36	5180	0.08	16.91	24.00	-0.40		Pass
VHT20	MCS0	1	44	5220	0.08	16.84	24.00	-0.40		Pass
VHT20	MCS0	1	48	5240	0.08	16.59	24.00	-0.40		Pass
VHT40	MCS0	1	38	5190	0.16	16.96	24.00	-0.40		Pass
VHT40	MCS0	1	46	5230	0.16	16.64	24.00	-0.40		Pass
VHT80	MCS0	1	42	5210	0.30	16.18	24.00	-0.40		Pass

TEST RESULTS DATA
Power Spectral Density

FCC Band I										
Mod.	Data Rate	N _{TX}	CH.	Freq. (MHz)	Duty Factor (dB)	Average Power Density (dBm/MHz)	Average PSD Limit (dBm/MHz)	DG (dBi)	-	Pass/Fail
11a	6Mbps	1	36	5180	0.08	6.65	11.00	-0.40		Pass
11a	6Mbps	1	44	5220	0.08	6.50	11.00	-0.40		Pass
11a	6Mbps	1	48	5240	0.08	6.30	11.00	-0.40		Pass
VHT20	MCS0	1	36	5180	0.08	5.72	11.00	-0.40		Pass
VHT20	MCS0	1	44	5220	0.08	5.40	11.00	-0.40		Pass
VHT20	MCS0	1	48	5240	0.08	5.50	11.00	-0.40		Pass
VHT40	MCS0	1	38	5190	0.16	2.41	11.00	-0.40		Pass
VHT40	MCS0	1	46	5230	0.16	2.13	11.00	-0.40		Pass
VHT80	MCS0	1	42	5210	0.30	-0.94	11.00	-0.40		Pass

TEST RESULTS DATA
26dB and 99% OBW

Band II										
Mod.	Data Rate	N _{Tx}	CH.	Freq. (MHz)	99% Bandwidth (MHz)	26 dB Bandwidth (MHz)	IC 99% Bandwidth Power Limit (dBm)	IC 99% Bandwidth EIRP Limit (dBm)	FCC 26dB Bandwidth Power Limit (dBm)	Note
11a	6M bps	1	52	5260	17.68	25.97	23.48	29.48	23.98	
11a	6M bps	1	60	5300	18.08	28.57	23.57	29.57	23.98	
11a	6M bps	1	64	5320	17.93	29.32	23.54	29.54	23.98	
VHT20	MCS 0	1	52	5260	18.83	28.02	23.75	29.75	23.98	
VHT20	MCS 0	1	60	5300	18.58	24.73	23.69	29.69	23.98	
VHT20	MCS 0	1	64	5320	19.03	28.52	23.79	29.79	23.98	
VHT40	MCS 0	1	54	5270	36.56	41.54	23.98	30.00	23.98	
VHT40	MCS 0	1	62	5310	36.56	41.72	23.98	30.00	23.98	
VHT80	MCS 0	1	58	5290	75.76	83.60	23.98	30.00	23.98	

TEST RESULTS DATA
Average Power Table

FCC Band II										
Mod.	Data Rate	N _{Tx}	CH.	Freq. (MHz)	Duty Factor (dB)	Average Conducted Power (dBm)	FCC Conducted Power Limit (dBm)	DG (dBi)	EIRP Power Limit (dBm)	Pass/Fail
11a	6M bps	1	52	5260	0.08	17.86	23.98	-0.50	26.99	Pass
11a	6M bps	1	60	5300	0.08	17.80	23.98	-0.50	26.99	Pass
11a	6M bps	1	64	5320	0.08	17.35	23.98	-0.50	26.99	Pass
HT20	MCS 0	1	52	5260	0.08	16.89	23.98	-0.50	26.99	Pass
HT20	MCS 0	1	60	5300	0.08	16.89	23.98	-0.50	26.99	Pass
HT20	MCS 0	1	64	5320	0.08	16.40	23.98	-0.50	26.99	Pass
HT40	MCS 0	1	54	5270	0.16	15.86	23.98	-0.50	26.99	Pass
HT40	MCS 0	1	62	5310	0.16	15.58	23.98	-0.50	26.99	Pass
VHT20	MCS 0	1	52	5260	0.08	16.94	23.98	-0.50	26.99	Pass
VHT20	MCS 0	1	60	5300	0.08	16.90	23.98	-0.50	26.99	Pass
VHT20	MCS 0	1	64	5320	0.08	16.88	23.98	-0.50	26.99	Pass
VHT40	MCS 0	1	54	5270	0.16	16.88	23.98	-0.50	26.99	Pass
VHT40	MCS 0	1	62	5310	0.16	16.48	23.98	-0.50	26.99	Pass
VHT80	MCS 0	1	58	5290	0.30	15.58	23.98	-0.50	26.99	Pass

TEST RESULTS DATA
Power Spectral Density

Band II										
Mod.	Data Rate	N _{TX}	CH.	Freq. (MHz)	Duty Factor (dB)	Average Power Density (dBm/MHz)	Average PSD Limit (dBm/MHz)	DG (dBi)		Pass/Fail
11a	6M bps	1	52	5260	0.08	6.42	11.00	-0.50		Pass
11a	6M bps	1	60	5300	0.08	6.33	11.00	-0.50		Pass
11a	6M bps	1	64	5320	0.08	5.69	11.00	-0.50		Pass
VHT20	MCS 0	1	52	5260	0.08	5.71	11.00	-0.50		Pass
VHT20	MCS 0	1	60	5300	0.08	5.74	11.00	-0.50		Pass
VHT20	MCS 0	1	64	5320	0.08	5.59	11.00	-0.50		Pass
VHT40	MCS 0	1	54	5270	0.16	2.41	11.00	-0.50		Pass
VHT40	MCS 0	1	62	5310	0.16	1.76	11.00	-0.50		Pass
VHT80	MCS 0	1	58	5290	0.30	-1.26	11.00	-0.50		Pass

TEST RESULTS DATA
26dB and 99% OBW

Band III										
Mod.	Data Rate	NTx	CH.	Freq. (MHz)	99% Bandwidth (MHz)	26 dB Bandwidth (MHz)	IC 99% Bandwidth Power Limit (dBm)	IC 99% Bandwidth EIRP Limit (dBm)	FCC 26dB Bandwidth Power Limit (dBm)	Note
11a	6M bps	1	100	5500	17.68	25.97	23.48	29.48	23.98	
11a	6M bps	1	116	5580	17.38	24.13	23.40	29.40	23.98	
11a	6Mbps	1	140	5700	17.58	25.43	23.45	29.45	23.98	
11a	6M bps	1	144	5720	18.28	27.97	23.62	29.62	23.98	
VHT20	MCS 0	1	100	5500	18.63	24.78	23.70	29.70	23.98	
VHT20	MCS 0	1	116	5580	18.73	25.67	23.73	29.73	23.98	
VHT20	MCS0	1	140	5700	18.68	25.92	23.71	29.71	23.98	
VHT20	MCS 0	1	144	5720	19.78	31.22	23.96	29.96	23.98	
VHT40	MCS 0	1	102	5510	36.56	42.08	23.98	30.00	23.98	
VHT40	MCS 0	1	110	5550	36.56	42.08	23.98	30.00	23.98	
VHT40	MCS0	1	134	5670	36.56	41.63	23.98	30.00	23.98	
VHT40	MCS 0	1	142	5710	37.66	56.28	23.98	30.00	23.98	
VHT80	MCS 0	1	106	5530	75.88	84.72	23.98	30.00	23.98	
VHT80	MCS0	1	122	5610	75.88	83.76	23.98	30.00	23.98	
VHT80	MCS 0	1	138	5690	76.00	85.67	23.98	30.00	23.98	

TEST RESULTS DATA
Average Power Table

FCC Band III										
Mod.	Data Rate	N _{Tx}	CH.	Freq. (MHz)	Duty Factor (dB)	Average Conducted Power (dBm)	FCC Conducted Power Limit (dBm)	DG (dBi)	EIRP Power Limit (dBm)	Pass/Fail
11a	6M bps	1	100	5500	0.08	16.43	23.98	-0.60	26.99	Pass
11a	6M bps	1	116	5580	0.08	16.66	23.98	-0.60	26.99	Pass
11a	6M bps	1	140	5700	0.08	17.80	23.98	-0.60	26.99	Pass
11a	6Mbps	1	144	5720	0.08	17.87	23.98	-0.60	26.99	Pass
HT20	MCS 0	1	100	5500	0.08	15.28	23.98	-0.60	26.99	Pass
HT20	MCS 0	1	116	5580	0.08	15.88	23.98	-0.60	26.99	Pass
HT20	MCS 0	1	140	5700	0.08	16.70	23.98	-0.60	26.99	Pass
HT20	MCS0	1	144	5720	0.08	16.86	23.98	-0.60	26.99	Pass
HT40	MCS 0	1	102	5510	0.16	14.66	23.98	-0.60	26.99	Pass
HT40	MCS 0	1	110	5550	0.16	14.98	23.98	-0.60	26.99	Pass
HT40	MCS 0	1	134	5670	0.16	15.84	23.98	-0.60	26.99	Pass
HT40	MCS0	1	142	5710	0.16	16.16	23.98	-0.60	26.99	Pass
VHT20	MCS 0	1	100	5500	0.08	16.38	23.98	-0.60	26.99	Pass
VHT20	MCS 0	1	116	5580	0.08	16.72	23.98	-0.60	26.99	Pass
VHT20	MCS 0	1	140	5700	0.08	16.71	23.98	-0.60	26.99	Pass
VHT20	MCS0	1	144	5720	0.08	16.96	23.98	-0.60	26.99	Pass
VHT40	MCS 0	1	102	5510	0.16	15.84	23.98	-0.60	26.99	Pass
VHT40	MCS 0	1	110	5550	0.16	16.26	23.98	-0.60	26.99	Pass
VHT40	MCS 0	1	134	5670	0.16	17.20	23.98	-0.60	26.99	Pass
VHT40	MCS0	1	142	5710	0.16	17.16	23.98	-0.60	26.99	Pass
VHT80	MCS 0	1	106	5530	0.30	14.62	23.98	-0.60	26.99	Pass
VHT80	MCS 0	1	122	5610	0.30	15.52	23.98	-0.60	26.99	Pass
VHT80	MCS0	1	138	5690	0.30	16.20	23.98	-0.60	26.99	Pass

TEST RESULTS DATA
Power Spectral Density

Band III										
Mod.	Data Rate	NTx	CH.	Freq. (MHz)	Duty Factor (dB)	Average Power Density (dBm/MHz)	Average PSD Limit (dBm/MHz)	DG (dBi)		Pass/Fail
11a	6M bps	1	100	5500	0.08	5.47	11.00	-0.60		Pass
11a	6M bps	1	116	5580	0.08	5.87	11.00	-0.60		Pass
11a	6Mbps	1	140	5700	0.08	6.56	11.00	-0.60		Pass
11a	6M bps	1	144	5720	0.08	6.68	11.00	-0.60		Pass
VHT20	MCS 0	1	100	5500	0.08	5.42	11.00	-0.60		Pass
VHT20	MCS 0	1	116	5580	0.08	5.39	11.00	-0.60		Pass
VHT20	MCS0	1	140	5700	0.08	5.36	11.00	-0.60		Pass
VHT20	MCS 0	1	144	5720	0.08	5.71	11.00	-0.60		Pass
VHT40	MCS 0	1	102	5510	0.16	1.46	11.00	-0.60		Pass
VHT40	MCS 0	1	110	5550	0.16	2.03	11.00	-0.60		Pass
VHT40	MCS0	1	134	5670	0.16	2.66	11.00	-0.60		Pass
VHT40	MCS 0	1	142	5710	0.16	3.01	11.00	-0.60		Pass
VHT80	MCS 0	1	106	5530	0.30	-1.94	11.00	-0.60		Pass
VHT80	MCS0	1	122	5610	0.30	-1.83	11.00	-0.60		Pass
VHT80	MCS 0	1	138	5690	0.30	-1.60	11.00	-0.60		Pass



Appendix B. AC Conducted Emission Test Results

Test Engineer :	Amos Zhang	Temperature :	25.3~26.2°C
		Relative Humidity :	38~40%
Test Voltage :	120Vac / 60Hz	Phase :	Line
Remark :	All emissions not reported here are more than 10 dB below the prescribed limit.		

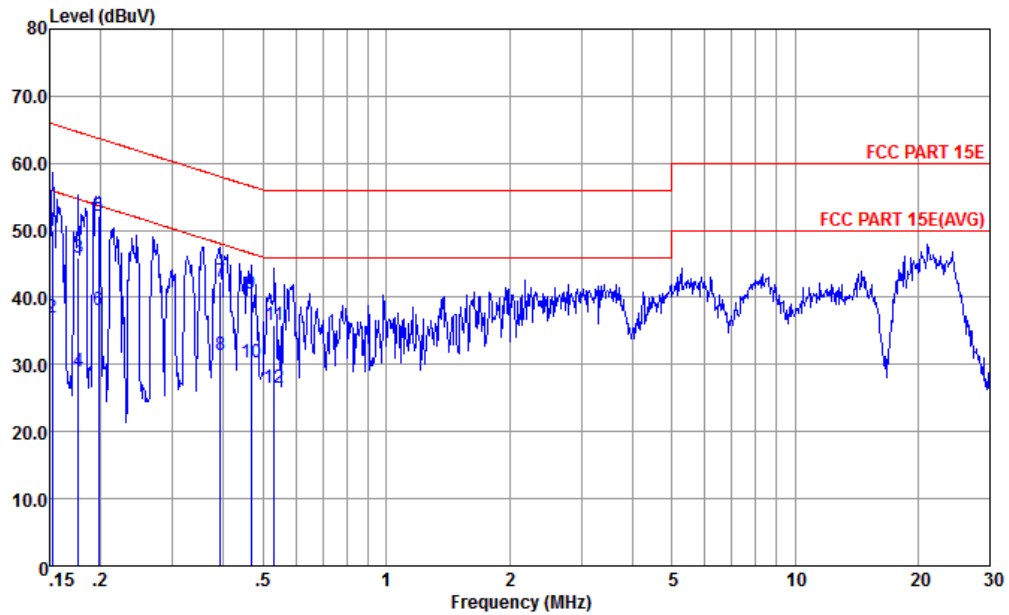

Site : CO01-KS
 Condition : FCC PART 15E LISN-L-191028-060105 LINE

	Freq	Level	Over Limit	Limit Line	Read Level	LISN Factor	Cable Loss	Remark
	MHz	dBuV	dB	dBuV	dBuV	dB	dB	
1	0.152	50.00	-15.87	65.87	39.50	0.03	10.47	QP
2	0.152	37.10	-18.77	55.87	26.60	0.03	10.47	Average
3	0.177	45.95	-18.69	64.64	35.50	0.04	10.41	QP
4	0.177	29.05	-25.59	54.64	18.60	0.04	10.41	Average
5 *	0.198	52.21	-11.50	63.71	41.80	0.04	10.37	QP
6	0.198	38.01	-15.70	53.71	27.60	0.04	10.37	Average
7	0.393	42.42	-15.57	57.99	32.10	0.05	10.27	QP
8	0.393	31.52	-16.47	47.99	21.20	0.05	10.27	Average
9	0.466	40.60	-15.98	56.58	30.30	0.06	10.24	QP
10	0.466	30.40	-16.18	46.58	20.10	0.06	10.24	Average
11	0.532	35.90	-20.10	56.00	25.60	0.06	10.24	QP
12	0.532	26.60	-19.40	46.00	16.30	0.06	10.24	Average



Test Engineer :	Amos Zhang	Temperature :	25.3~26.2°C
		Relative Humidity :	38~40%
Test Voltage :	120Vac / 60Hz	Phase :	Neutral
Remark :	All emissions not reported here are more than 10 dB below the prescribed limit.		

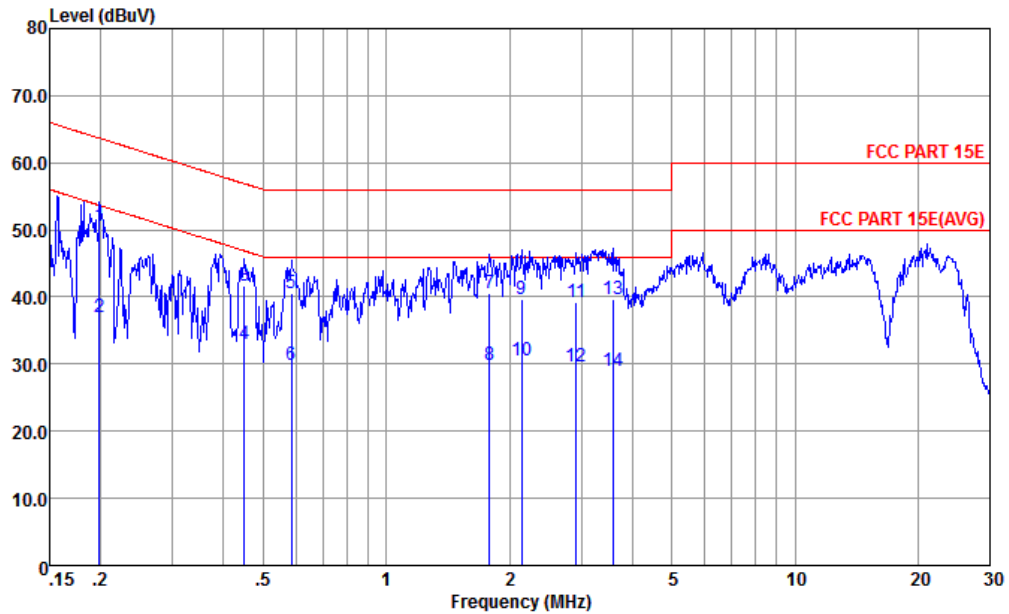

Site : CO01-KS
 Condition : FCC PART 15E LISN-N-191028-060105 NEUTRAL

	Freq	Level	Over	Limit	Read	LISN	Cable	
	MHz	dBuV	Limit	Line	Level	Factor	Loss	Remark
			dB	dBuV	dBuV	dB	dB	
1 *	0.199	50.55	-13.12	63.67	40.10	0.08	10.37	QP
2	0.199	37.05	-16.62	53.67	26.60	0.08	10.37	Average
3	0.449	41.65	-15.24	56.89	31.30	0.10	10.25	QP
4	0.449	32.95	-13.94	46.89	22.60	0.10	10.25	Average
5	0.585	40.54	-15.46	56.00	30.20	0.10	10.24	QP
6	0.585	29.94	-16.06	46.00	19.60	0.10	10.24	Average
7	1.790	40.56	-15.44	56.00	30.20	0.13	10.23	QP
8	1.790	29.96	-16.04	46.00	19.60	0.13	10.23	Average
9	2.144	39.66	-16.34	56.00	29.30	0.13	10.23	QP
10	2.144	30.56	-15.44	46.00	20.20	0.13	10.23	Average
11	2.915	39.28	-16.72	56.00	28.90	0.14	10.24	QP
12	2.915	29.68	-16.32	46.00	19.30	0.14	10.24	Average
13	3.584	39.60	-16.40	56.00	29.20	0.15	10.25	QP
14	3.584	29.00	-17.00	46.00	18.60	0.15	10.25	Average

Note:

- Level(dBμV) = Read Level(dBμV) + LISN Factor(dB) + Cable Loss(dB)
- Over Limit(dB) = Level(dBμV) – Limit Line(dBμV)



Appendix C. Radiated Spurious Emission

Band 1 - 5150~5250MHz WIFI 802.11a (Band Edge @ 3m)

WIFI Ant.	Note	Frequency	Level	Over Limit	Limit Line	Read Level	Antenna Factor	Cable Loss	Preamp Factor	Ant Pos	Table Pos	Peak Avg.	Pol.
1		(MHz)	(dBμV/m)	(dB)	(dBμV/m)	(dBμV)	(dB/m)	(dB)	(dB)	(cm)	(deg)	(P/A)	(H/V)
802.11a CH 36 5180MHz		5124.28	50.03	-23.97	74	37.47	31.87	10.06	29.37	102	24	P	H
		5150	40.93	-13.07	54	28.34	31.9	10.06	29.37	102	24	A	H
	*	5180	102.25	-	-	89.82	31.7	10.09	29.36	102	24	P	H
		5180	94.11	-	-	81.68	31.7	10.09	29.36	102	24	A	H
		5101.4	49.72	-24.28	74	37.28	31.8	10.02	29.38	100	343	P	V
		5150	39.29	-14.71	54	26.7	31.9	10.06	29.37	100	343	A	V
	*	5180	93.89	-	-	81.46	31.7	10.09	29.36	100	343	P	V
		5180	88.06	-	-	75.63	31.7	10.09	29.36	100	343	A	V
802.11a CH 44 5220MHz		5077.74	49.37	-24.63	74	36.96	31.77	10.02	29.38	100	26	P	H
		5088.4	39.17	-14.83	54	26.76	31.77	10.02	29.38	100	26	A	H
	*	5220	102.6	-	-	90.33	31.5	10.13	29.36	100	26	P	H
		5220	94.69	-	-	82.42	31.5	10.13	29.36	100	26	A	H
		5414.92	49.83	-24.17	74	37.11	31.7	10.34	29.32	100	26	P	H
		5456.92	39.43	-14.57	54	26.66	31.7	10.38	29.31	100	26	A	H
		5083.46	49.53	-24.47	74	37.12	31.77	10.02	29.38	101	352	P	V
		5088.4	39.17	-14.83	54	26.76	31.77	10.02	29.38	101	352	A	V
	*	5220	92.54	-	-	80.27	31.5	10.13	29.36	101	352	P	V
		5220	87.08	-	-	74.81	31.5	10.13	29.36	101	352	A	V
		5456.64	50.03	-23.97	74	37.26	31.7	10.38	29.31	101	352	P	V
		5450	39.42	-14.58	54	26.65	31.7	10.38	29.31	101	352	A	V



802.11a CH 48 5240MHz		5017.16	49.11	-24.89	74	36.98	31.57	9.95	29.39	111	26	P	H
		5084.5	39.15	-14.85	54	26.74	31.77	10.02	29.38	111	26	A	H
	*	5240	101.64	-	-	89.42	31.4	10.17	29.35	111	26	P	H
		5240	93.74	-	-	81.52	31.4	10.17	29.35	111	26	A	H
		5456.64	49.72	-24.28	74	36.95	31.7	10.38	29.31	111	26	P	H
		5457.48	39.44	-14.56	54	26.67	31.7	10.38	29.31	111	26	A	H
		5042.64	49.2	-24.8	74	36.9	31.7	9.99	29.39	106	348	P	V
		5081.64	39.14	-14.86	54	26.73	31.77	10.02	29.38	106	348	A	V
	*	5240	92.55	-	-	80.33	31.4	10.17	29.35	106	348	P	V
		5240	86.6	-	-	74.38	31.4	10.17	29.35	106	348	A	V
		5447.28	49.44	-24.56	74	36.67	31.7	10.38	29.31	106	348	P	V
		5459.04	39.43	-14.57	54	26.66	31.7	10.38	29.31	106	348	A	V
Remark	1. No other spurious found. 2. All results are PASS against Peak and Average limit line.												



Band 1 5150~5250MHz

WIFI 802.11a (Harmonic @ 3m)

WIFI Ant. 1	Note	Frequency (MHz)	Level (dBμV/m)	Over Limit (dB)	Limit Line (dBμV/m)	Read Level (dBμV)	Antenna Factor (dB/m)	Cable Loss (dB)	Preamp Factor (dB)	Ant Pos (cm)	Table Pos (deg)	Peak Avg. (P/A)	Pol. (H/V)
802.11a CH 36 5180MHz		10360	48.24	-20.06	68.3	47.73	39.67	14.23	53.39	196	175	P	H
		15540	50.23	-23.77	74	44.78	38.5	18.86	51.91	142	186	P	H
		10360	48.45	-19.85	68.3	47.94	39.67	14.23	53.39	152	260	P	V
		15540	50.06	-23.94	74	44.61	38.5	18.86	51.91	189	238	P	V
802.11a CH 44 5220MHz		10440	47.68	-20.62	68.3	47.04	39.8	14.29	53.45	150	230	P	H
		15660	50.34	-23.66	74	45.23	38.2	18.87	51.96	160	225	P	H
		10440	46.93	-21.37	68.3	46.29	39.8	14.29	53.45	175	296	P	V
		15660	50.31	-23.69	74	45.2	38.2	18.87	51.96	185	236	P	V
802.11a CH 48 5240MHz		10480	46.7	-21.6	68.3	46.07	39.8	14.32	53.49	150	289	P	H
		15720	49.29	-24.71	74	44.43	37.98	18.87	51.99	150	291	P	H
		10480	47.36	-20.94	68.3	46.73	39.8	14.32	53.49	153	242	P	V
		15720	49.66	-24.34	74	44.8	37.98	18.87	51.99	196	210	P	V
Remark	1. No other spurious found. 2. All results are PASS against Peak and Average limit line.												



Band 1 5150~5250MHz
WIFI 802.11ac VHT20 (Band Edge @ 3m)

WIFI Ant. 1	Note	Frequency (MHz)	Level (dBμV/m)	Over Limit (dB)	Limit Line (dBμV/m)	Read Level (dBμV)	Antenna Factor (dB/m)	Cable Loss (dB)	Preamp Factor (dB)	Ant Pos (cm)	Table Pos (deg)	Peak Avg. (P/A)	Pol. (H/V)
802.11ac VHT20 CH 36 5180MHz		5132.86	50.04	-23.96	74	37.48	31.87	10.06	29.37	114	79	P	H
		5150	41.36	-12.64	54	28.77	31.9	10.06	29.37	114	79	A	H
	*	5180	98.91	-	-	86.48	31.7	10.09	29.36	114	79	P	H
		5180	93.05	-	-	80.62	31.7	10.09	29.36	114	79	A	H
		5113.88	48.98	-25.02	74	36.51	31.83	10.02	29.38	100	343	P	V
		5122.2	39.21	-14.79	54	26.69	31.83	10.06	29.37	100	343	A	V
	*	5180	92.39	-	-	79.96	31.7	10.09	29.36	100	343	P	V
	5180	85.31	-	-	72.88	31.7	10.09	29.36	100	343	A	V	
802.11ac VHT20 CH 44 5220MHz		5042.38	49.64	-24.36	74	37.34	31.7	9.99	29.39	100	26	P	H
		5083.72	39.18	-14.82	54	26.77	31.77	10.02	29.38	100	26	A	H
	*	5220	98.32	-	-	86.05	31.5	10.13	29.36	100	26	P	H
		5220	92.82	-	-	80.55	31.5	10.13	29.36	100	26	A	H
		5363.28	49.36	-24.64	74	36.96	31.43	10.3	29.33	100	26	P	H
		5457.6	39.51	-14.49	54	26.74	31.7	10.38	29.31	100	26	A	H
		5059.28	49.75	-24.25	74	37.42	31.73	9.99	29.39	123	288	P	V
		5084.24	39.18	-14.82	54	26.77	31.77	10.02	29.38	123	288	A	V
	*	5220	92.79	-	-	80.52	31.5	10.13	29.36	123	288	P	V
		5220	87.22	-	-	74.95	31.5	10.13	29.36	123	288	A	V
	5393.04	49.25	-24.75	74	36.66	31.57	10.34	29.32	123	288	P	V	
	5458.8	39.51	-14.49	54	26.74	31.7	10.38	29.31	123	288	A	V	



802.11ac VHT20 CH 48 5240MHz		5069.68	49.3	-24.7	74	36.96	31.73	9.99	29.38	100	26	P	H
		5088.66	39.19	-14.81	54	26.75	31.8	10.02	29.38	100	26	A	H
	*	5240	100.09	-	-	87.87	31.4	10.17	29.35	100	26	P	H
		5240	94.46	-	-	82.24	31.4	10.17	29.35	100	26	A	H
		5448	49.38	-24.62	74	36.61	31.7	10.38	29.31	100	26	P	H
		5460	39.5	-14.5	54	26.73	31.7	10.38	29.31	100	26	A	H
		5117.78	50.19	-23.81	74	37.68	31.83	10.06	29.38	100	290	P	V
		5086.84	39.19	-14.81	54	26.78	31.77	10.02	29.38	100	290	A	V
	*	5240	92.9	-	-	80.68	31.4	10.17	29.35	100	290	P	V
		5240	86.62	-	-	74.4	31.4	10.17	29.35	100	290	A	V
		5369.28	50.06	-23.94	74	37.66	31.43	10.3	29.33	100	290	P	V
		5456.64	39.51	-14.49	54	26.74	31.7	10.38	29.31	100	290	A	V
Remark	1. No other spurious found. 2. All results are PASS against Peak and Average limit line.												



Band 1 5150~5250MHz
WIFI 802.11ac VHT20 (Harmonic @ 3m)

Table with 14 columns: WIFI Ant. 1, Note, Frequency (MHz), Level (dBµV/m), Over Limit (dB), Limit Line (dBµV/m), Read Level (dBµV), Antenna Factor (dB/m), Cable Loss (dB), Preamp Factor (dB), Ant Pos (cm), Table Pos (deg), Peak Avg. (P/A), Pol. (H/V). Rows include test results for 802.11ac VHT20 CH 36 (5180MHz) and CH 44 (5220MHz), and 802.11ac VHT20 CH 48 (5240MHz).

Remark

- 1. No other spurious found.
2. All results are PASS against Peak and Average limit line.



Band 1 5150~5250MHz
WIFI 802.11ac VHT40 (Band Edge @ 3m)

WIFI Ant. 1	Note	Frequency (MHz)	Level (dBμV/m)	Over Limit (dB)	Limit Line (dBμV/m)	Read Level (dBμV)	Antenna Factor (dB/m)	Cable Loss (dB)	Preamp Factor (dB)	Ant Pos (cm)	Table Pos (deg)	Peak Avg. (P/A)	Pol. (H/V)
802.11ac VHT40 CH 38 5190MHz		5149.76	57.31	-16.69	74	44.72	31.9	10.06	29.37	100	5	P	H
		5150	47.55	-6.45	54	34.96	31.9	10.06	29.37	100	5	A	H
	*	5190	95.77	-	-	83.34	31.7	10.09	29.36	100	5	P	H
		5190	89.42	-	-	76.99	31.7	10.09	29.36	100	5	A	H
		5442.96	49.35	-24.65	74	36.58	31.7	10.38	29.31	100	20	P	H
		5423.04	39.45	-14.55	54	26.73	31.7	10.34	29.32	100	20	P	H
		5149.5	55.48	-18.52	74	42.89	31.9	10.06	29.37	312	258	P	V
		5150	46.68	-7.32	54	34.09	31.9	10.06	29.37	312	258	A	V
	*	5190	94.79	-	-	82.36	31.7	10.09	29.36	312	258	P	V
		5190	88.64	-	-	76.21	31.7	10.09	29.36	312	258	A	V
		5374.32	48.32	-25.68	74	35.91	31.43	10.3	29.32	114	317	P	V
		5442.96	39.5	-14.5	54	26.73	31.7	10.38	29.31	114	317	P	V
802.11ac VHT40 CH 46 5230MHz		5143.52	49.29	-24.71	74	36.7	31.9	10.06	29.37	100	20	P	H
		5133.9	39.37	-14.63	54	26.81	31.87	10.06	29.37	100	20	A	H
	*	5230	95.04	-	-	82.86	31.4	10.13	29.35	100	20	P	H
		5230	89.46	-	-	77.28	31.4	10.13	29.35	100	20	A	H
		5418.48	49.67	-24.33	74	36.95	31.7	10.34	29.32	100	20	P	H
		5458.08	39.61	-14.39	54	26.84	31.7	10.38	29.31	100	20	A	H
		5056.16	50.35	-23.65	74	38.02	31.73	9.99	29.39	114	317	P	V
		5080.34	39.25	-14.75	54	26.84	31.77	10.02	29.38	114	317	A	V
	*	5230	90.69	-	-	78.51	31.4	10.13	29.35	114	317	P	V
		5230	84.25	-	-	72.07	31.4	10.13	29.35	114	317	A	V
	5455.2	50.22	-23.78	74	37.45	31.7	10.38	29.31	114	317	P	V	
	5458.32	39.57	-14.43	54	26.8	31.7	10.38	29.31	114	317	A	V	
Remark	1. No other spurious found. 2. All results are PASS against Peak and Average limit line.												



Band 1 5150~5250MHz
WIFI 802.11ac VHT40 (Harmonic @ 3m)

Table with 14 columns: WIFI Ant. 1, Note, Frequency (MHz), Level (dBµV/m), Over Limit (dB), Limit Line (dBµV/m), Read Level (dBµV), Antenna Factor (dB/m), Cable Loss (dB), Preamp Factor (dB), Ant Pos (cm), Table Pos (deg), Peak Avg. (P/A), Pol. (H/V). Rows include 802.11ac VHT40 CH 38 5190MHz and 802.11ac VHT40 CH 46 5230MHz.

Remark
1. No other spurious found.
2. All results are PASS against Peak and Average limit line.



Band 1 5150~5250MHz
WIFI 802.11ac VHT80 (Band Edge @ 3m)

Table with 14 columns: WIFI Ant. 1, Note, Frequency (MHz), Level (dBµV/m), Over Limit (dB), Limit Line (dBµV/m), Read Level (dBµV), Antenna Factor (dB/m), Cable Loss (dB), Preamp Factor (dB), Ant Pos (cm), Table Pos (deg), Peak Avg. (P/A), Pol. (H/V). Rows include test results for frequencies like 5150.02, 5145.08, 5210, 5441.52, 5459.52, 5149.24, 5137.8, 5210, 5210, 5456.4, 5458.32.

Remark

- 1. No other spurious found.
2. All results are PASS against Peak and Average limit line.



Band 1 5150~5250MHz

WIFI 802.11ac VHT80 (Harmonic @ 3m)

WIFI Ant. 1	Note	Frequency (MHz)	Level (dBμV/m)	Over Limit (dB)	Limit Line (dBμV/m)	Read Level (dBμV)	Antenna Factor (dB/m)	Cable Loss (dB)	Preamp Factor (dB)	Ant Pos (cm)	Table Pos (deg)	Peak Avg. (P/A)	Pol. (H/V)
802.11ac		10420	47.91	-20.39	68.3	47.25	39.8	14.29	53.43	230	300	P	H
VHT80		15630	50.68	-23.32	74	45.54	38.23	18.87	51.96	123	260	P	H
CH 42		10420	47.76	-20.54	68.3	47.1	39.8	14.29	53.43	230	300	P	V
5210MHz		15630	50.35	-23.65	74	45.21	38.23	18.87	51.96	123	260	P	V
Remark	1. No other spurious found. 2. All results are PASS against Peak and Average limit line.												



Band 2 - 5250~5350MHz
WIFI 802.11a (Band Edge @ 3m)

WIFI	Note	Frequency	Level	Over	Limit	Read	Antenna	Cable	Preamp	Ant	Table	Peak	Pol.
Ant.				Limit	Line	Level	Factor	Loss	Factor	Pos	Pos	Avg.	
1		(MHz)	(dBμV/m)	(dB)	(dBμV/m)	(dBμV)	(dB/m)	(dB)	(dB)	(cm)	(deg)	(P/A)	(H/V)
802.11a CH 52 5260MHz		5126.35	48.83	-25.17	74	36.27	31.87	10.06	29.37	105	26	P	H
		5087.85	39.12	-14.88	54	26.71	31.77	10.02	29.38	105	26	A	H
	*	5260	102.3	-	-	90.18	31.3	10.17	29.35	105	26	P	H
		5260	94.31	-	-	82.19	31.3	10.17	29.35	105	26	A	H
		5439.12	49.21	-24.79	74	36.44	31.7	10.38	29.31	105	26	P	H
		5459.28	39.4	-14.6	54	26.63	31.7	10.38	29.31	105	26	A	H
		5051.45	49.26	-24.74	74	36.96	31.7	9.99	29.39	100	349	P	V
		5088.9	39.17	-14.83	54	26.73	31.8	10.02	29.38	100	349	A	V
	*	5260	93.95	-	-	81.83	31.3	10.17	29.35	100	349	P	V
		5260	88.34	-	-	76.22	31.3	10.17	29.35	100	349	A	V
		5427.12	49.44	-24.56	74	36.67	31.7	10.38	29.31	100	349	P	V
		5455.92	39.43	-14.57	54	26.66	31.7	10.38	29.31	100	349	A	V
802.11a CH 60 5300MHz		5054.25	51.36	-22.64	74	39.06	31.7	9.99	29.39	118	27	P	H
		5086.45	39.12	-14.88	54	26.71	31.77	10.02	29.38	118	27	A	H
	*	5300	101.82	-	-	89.65	31.3	10.21	29.34	118	27	P	H
		5300	94	-	-	81.83	31.3	10.21	29.34	118	27	A	H
		5391.84	50.04	-23.96	74	37.45	31.57	10.34	29.32	118	27	P	H
		5357.52	41.4	-12.6	54	29.13	31.3	10.3	29.33	118	27	A	H
		5031.85	49.15	-24.85	74	36.96	31.63	9.95	29.39	100	354	P	V
		5084.7	39.17	-14.83	54	26.76	31.77	10.02	29.38	100	354	A	V
	*	5300	93.45	-	-	81.28	31.3	10.21	29.34	100	354	P	V
		5300	87.71	-	-	75.54	31.3	10.21	29.34	100	354	A	V
		5454.48	50.16	-23.84	74	37.39	31.7	10.38	29.31	100	354	P	V
		5459.52	39.43	-14.57	54	26.66	31.7	10.38	29.31	100	354	A	V



802.11a CH 64 5320MHz	*	5320	101.81	-	-	89.59	31.3	10.26	29.34	110	22	P	H
		5320	93.17	-	-	80.95	31.3	10.26	29.34	110	22	A	H
		5350.56	59.61	-14.39	74	47.34	31.3	10.3	29.33	110	22	P	H
		5350.08	49.1	-4.9	54	36.83	31.3	10.3	29.33	110	22	A	H
	*	5320	93.17	-	-	80.95	31.3	10.26	29.34	100	352	P	V
		5320	87.66	-	-	75.44	31.3	10.26	29.34	100	352	A	V
		5350.56	52.48	-21.52	74	40.21	31.3	10.3	29.33	100	352	P	V
		5350.08	43.43	-10.57	54	31.16	31.3	10.3	29.33	100	352	A	V
Remark	<ol style="list-style-type: none"> No other spurious found. All results are PASS against Peak and Average limit line. 												



Band 2 5250~5350MHz

WIFI 802.11a (Harmonic @ 3m)

WIFI Ant. 1	Note	Frequency (MHz)	Level (dBμV/m)	Over Limit (dB)	Limit Line (dBμV/m)	Read Level (dBμV)	Antenna Factor (dB/m)	Cable Loss (dB)	Preamp Factor (dB)	Ant Pos (cm)	Table Pos (deg)	Peak Avg. (P/A)	Pol. (H/V)
802.11a CH 52 5260MHz		10520	47.52	-20.78	68.3	46.85	39.8	14.35	53.48	172	234	P	H
		15780	48.39	-25.61	74	43.89	37.63	18.88	52.01	124	281	P	H
		10520	47.5	-20.8	68.3	46.83	39.8	14.35	53.48	150	220	P	V
		15780	48.35	-25.65	74	43.85	37.63	18.88	52.01	159	345	P	V
802.11a CH 60 5300MHz		10600	47.87	-26.13	74	47.04	39.8	14.41	53.38	117	129	P	H
		15900	47.66	-26.34	74	43.42	37.4	18.9	52.06	167	143	P	H
		10600	46.86	-27.14	74	46.03	39.8	14.41	53.38	185	215	P	V
		15900	48.19	-25.81	74	43.95	37.4	18.9	52.06	196	190	P	V
802.11a CH 64 5320MHz		10640	48.67	-25.33	74	47.76	39.8	14.44	53.33	152	135	P	H
		15960	47.59	-26.41	74	43.37	37.4	18.91	52.09	173	245	P	H
		10640	47.94	-26.06	74	47.03	39.8	14.44	53.33	144	197	P	V
		15960	48.05	-25.95	74	43.83	37.4	18.91	52.09	125	221	P	V
Remark	1. No other spurious found. 2. All results are PASS against Peak and Average limit line.												



Band 2 5250~5350MHz
WIFI 802.11ac VHT20 (Band Edge @ 3m)

WIFI Ant. 1	Note	Frequency (MHz)	Level (dBμV/m)	Over Limit (dB)	Limit Line (dBμV/m)	Read Level (dBμV)	Antenna Factor (dB/m)	Cable Loss (dB)	Preamp Factor (dB)	Ant Pos (cm)	Table Pos (deg)	Peak Avg. (P/A)	Pol. (H/V)
802.11ac VHT20 CH 52 5260MHz		5056.35	48.96	-25.04	74	36.63	31.73	9.99	29.39	100	26	P	H
		5094.15	39.15	-14.85	54	26.71	31.8	10.02	29.38	100	26	A	H
	*	5260	100.54	-	-	88.42	31.3	10.17	29.35	100	26	P	H
		5260	94.62	-	-	82.5	31.3	10.17	29.35	100	26	A	H
		5457.12	49.4	-24.6	74	36.63	31.7	10.38	29.31	100	26	P	H
		5456.64	39.52	-14.48	54	26.75	31.7	10.38	29.31	100	26	A	H
		5071.75	49.44	-24.56	74	37.06	31.77	9.99	29.38	100	290	P	V
		5083.65	39.22	-14.78	54	26.81	31.77	10.02	29.38	100	290	A	V
	*	5260	93.46	-	-	81.34	31.3	10.17	29.35	100	290	P	V
		5260	86.8	-	-	74.68	31.3	10.17	29.35	100	290	A	V
		5435.76	50.33	-23.67	74	37.56	31.7	10.38	29.31	100	290	P	V
		5459.76	39.51	-14.49	54	26.74	31.7	10.38	29.31	100	290	A	V
802.11ac VHT20 CH 60 5300MHz		5116.2	50.35	-23.65	74	37.84	31.83	10.06	29.38	106	28	P	H
		5083.65	39.19	-14.81	54	26.78	31.77	10.02	29.38	106	28	A	H
	*	5300	101.19	-	-	89.02	31.3	10.21	29.34	106	28	P	H
		5300	95.38	-	-	83.21	31.3	10.21	29.34	106	28	A	H
		5377.92	49.84	-24.16	74	37.29	31.57	10.3	29.32	106	28	P	H
		5357.52	42.12	-11.88	54	29.85	31.3	10.3	29.33	106	28	A	H
		5117.95	49.33	-24.67	74	36.82	31.83	10.06	29.38	100	290	P	V
		5088.9	39.19	-14.81	54	26.75	31.8	10.02	29.38	100	290	A	V
	*	5300	94.83	-	-	82.66	31.3	10.21	29.34	100	290	P	V
		5300	88.82	-	-	76.65	31.3	10.21	29.34	100	290	A	V
	5425.92	50.08	-23.92	74	37.35	31.7	10.34	29.31	100	290	P	V	
	5459.28	39.49	-14.51	54	26.72	31.7	10.38	29.31	100	290	A	V	



802.11ac VHT20 CH 64 5320MHz	*	5320	101.15	-	-	88.93	31.3	10.26	29.34	103	28	P	H
		5320	95.02	-	-	82.8	31.3	10.26	29.34	103	28	A	H
		5350.08	59.02	-14.98	74	46.75	31.3	10.3	29.33	103	28	P	H
		5350.08	48.63	-5.37	54	36.36	31.3	10.3	29.33	103	28	A	H
	*	5320	95.31	-	-	83.09	31.3	10.26	29.34	100	289	P	V
		5320	89.45	-	-	77.23	31.3	10.26	29.34	100	289	A	V
		5351.2	53.49	-20.51	74	41.22	31.3	10.3	29.33	100	289	P	V
		5350.08	44.07	-9.93	54	31.8	31.3	10.3	29.33	100	289	A	V
Remark	<ol style="list-style-type: none"> No other spurious found. All results are PASS against Peak and Average limit line. 												



Band 2 5250~5350MHz
WIFI 802.11ac VHT20 (Harmonic @ 3m)

Table with 14 columns: WIFI Ant. 1, Note, Frequency (MHz), Level (dBµV/m), Over Limit (dB), Limit Line (dBµV/m), Read Level (dBµV), Antenna Factor (dB/m), Cable Loss (dB), Preamp Factor (dB), Ant Pos (cm), Table Pos (deg), Peak Avg. (P/A), Pol. (H/V). Rows include test results for 802.11ac VHT20 CH 52 (5260MHz) and CH 60 (5300MHz), and 802.11ac VHT20 CH 64 (5320MHz).

Remark

- 1. No other spurious found.
2. All results are PASS against Peak and Average limit line.



Band 2 5250~5350MHz
WIFI 802.11ac VHT40 (Band Edge @ 3m)

WIFI Ant. 1	Note	Frequency (MHz)	Level (dBμV/m)	Over Limit (dB)	Limit Line (dBμV/m)	Read Level (dBμV)	Antenna Factor (dB/m)	Cable Loss (dB)	Preamp Factor (dB)	Ant Pos (cm)	Table Pos (deg)	Peak Avg. (P/A)	Pol. (H/V)
802.11ac VHT40 CH 54 5270MHz		5126.1	49.2	-24.8	74	36.64	31.87	10.06	29.37	120	344	P	H
		5085.28	39.24	-14.76	54	26.83	31.77	10.02	29.38	120	344	A	H
	*	5270	95.29	-	-	83.17	31.3	10.17	29.35	120	344	P	H
		5270	89.5	-	-	77.38	31.3	10.17	29.35	120	344	A	H
		5446.32	49.69	-24.31	74	36.92	31.7	10.38	29.31	120	344	P	H
		5460	39.55	-14.45	54	26.78	31.7	10.38	29.31	120	344	A	H
		5048.36	50.22	-23.78	74	37.92	31.7	9.99	29.39	121	340	P	V
		5085.28	39.23	-14.77	54	26.82	31.77	10.02	29.38	121	340	A	V
	*	5270	89.68	-	-	77.56	31.3	10.17	29.35	121	340	P	V
		5270	83.92	-	-	71.8	31.3	10.17	29.35	121	340	A	V
		5457.12	50.37	-23.63	74	37.6	31.7	10.38	29.31	121	340	P	V
		5457.6	39.53	-14.47	54	26.76	31.7	10.38	29.31	121	340	A	V
802.11ac VHT40 CH 62 5310MHz		5041.65	49.52	-24.48	74	37.22	31.7	9.99	29.39	310	13	P	H
		5075.25	41.08	-12.92	54	28.7	31.77	9.99	29.38	310	13	A	H
	*	5310	95.59	-	-	83.37	31.3	10.26	29.34	310	13	P	H
		5310	89.78	-	-	77.56	31.3	10.26	29.34	310	13	A	H
		5354.16	57.25	-16.75	74	44.98	31.3	10.3	29.33	310	13	P	H
		5350.8	50.66	-3.34	54	38.39	31.3	10.3	29.33	310	13	A	H
		5083.65	49.07	-24.93	74	36.66	31.77	10.02	29.38	380	206	P	V
		5068.95	41.12	-12.88	54	28.78	31.73	9.99	29.38	380	206	A	V
	*	5310	93.88	-	-	81.66	31.3	10.26	29.34	380	206	P	V
		5310	87.95	-	-	75.73	31.3	10.26	29.34	380	206	A	V
	5351.52	55.21	-18.79	74	42.94	31.3	10.3	29.33	380	206	P	V	
	5350.08	47.87	-6.13	54	35.6	31.3	10.3	29.33	380	206	A	V	
Remark	1. No other spurious found. 2. All results are PASS against Peak and Average limit line.												



Band 2 5250~5350MHz
WIFI 802.11ac VHT40 (Harmonic @ 3m)

Table with 14 columns: WIFI Ant. 1, Note, Frequency (MHz), Level (dBµV/m), Over Limit (dB), Limit Line (dBµV/m), Read Level (dBµV), Antenna Factor (dB/m), Cable Loss (dB), Preamp Factor (dB), Ant Pos (cm), Table Pos (deg), Peak Avg. (P/A), Pol. (H/V). Rows include test results for 802.11ac VHT40 CH 54 at 5270MHz and 802.11ac VHT40 CH 62 at 5310MHz. A Remark section at the bottom states: 1. No other spurious found. 2. All results are PASS against Peak and Average limit line.



Band 2 5250~5350MHz
WIFI 802.11ac VHT80 (Band Edge @ 3m)

Table with 14 columns: WIFI Ant. 1, Note, Frequency (MHz), Level (dBµV/m), Over Limit (dB), Limit Line (dBµV/m), Read Level (dBµV), Antenna Factor (dB/m), Cable Loss (dB), Preamp Factor (dB), Ant Pos (cm), Table Pos (deg), Peak Avg. (P/A), Pol. (H/V). Rows include test results for frequencies like 5060.55, 5079.1, 5290, 5355.36, 5387.28, 5114.8, 5047.95, 5290, 5290, 5355.84, 5387.52.

Remark

- 1. No other spurious found.
2. All results are PASS against Peak and Average limit line.



Band 2 5250~5350MHz

WIFI 802.11ac VHT80 (Harmonic @ 3m)

WIFI Ant. 1	Note	Frequency (MHz)	Level (dBμV/m)	Over Limit (dB)	Limit Line (dBμV/m)	Read Level (dBμV)	Antenna Factor (dB/m)	Cable Loss (dB)	Preamp Factor (dB)	Ant Pos (cm)	Table Pos (deg)	Peak Avg. (P/A)	Pol. (H/V)
802.11ac		10580	47.16	-21.14	68.3	46.35	39.8	14.41	53.4	122	340	P	H
VHT80		15870	48.34	-25.66	74	44.1	37.4	18.89	52.05	168	345	P	H
CH 58		10580	47.55	-20.75	68.3	46.74	39.8	14.41	53.4	122	340	P	V
5290MHz		15870	48.5	-25.5	74	44.26	37.4	18.89	52.05	168	345	P	V
Remark	1. No other spurious found. 2. All results are PASS against Peak and Average limit line.												



Band 3 - 5470~5725MHz
WIFI 802.11a (Band Edge @ 3m)

WIFI	Note	Frequency	Level	Over	Limit	Read	Antenna	Cable	Preamp	Ant	Table	Peak	Pol.
Ant.				Limit	Line	Level	Factor	Loss	Factor	Pos	Pos	Avg.	
1		(MHz)	(dBμV/m)	(dB)	(dBμV/m)	(dBμV)	(dB/m)	(dB)	(dB)	(cm)	(deg)	(P/A)	(H/V)
802.11a CH 100 5500MHz		5456.4	50.4	-23.6	74	37.63	31.7	10.38	29.31	126	356	P	H
		5468.72	51.07	-17.23	68.3	38.18	31.77	10.43	29.31	126	356	P	H
		5442.32	41.02	-12.98	54	28.25	31.7	10.38	29.31	126	356	A	H
	*	5500	100.46	-	-	87.43	31.9	10.43	29.3	126	356	P	H
		5500	93.34	-	-	80.31	31.9	10.43	29.3	126	356	A	H
		5453.68	49.81	-24.19	74	37.04	31.7	10.38	29.31	108	352	P	V
		5465.84	49.53	-18.77	68.3	36.64	31.77	10.43	29.31	108	352	P	V
		5442.32	39.93	-14.07	54	27.16	31.7	10.38	29.31	108	352	A	V
	*	5500	92.78	-	-	79.75	31.9	10.43	29.3	108	352	P	V
		5500	87.67	-	-	74.64	31.9	10.43	29.3	108	352	A	V
802.11a CH 116 5580MHz		5382.4	50.07	-23.93	74	37.52	31.57	10.3	29.32	139	349	P	H
		5463.04	48.75	-19.55	68.3	35.91	31.77	10.38	29.31	139	349	P	H
		5458.96	39.59	-14.41	54	26.82	31.7	10.38	29.31	139	349	A	H
	*	5580	100.09	-	-	87.18	31.73	10.52	29.34	139	349	P	H
		5580	93.85	-	-	80.94	31.73	10.52	29.34	139	349	A	H
		5743.895	50.05	-18.25	68.3	36.73	32.1	10.62	29.4	139	349	P	H
		5446.48	49.08	-24.92	74	36.31	31.7	10.38	29.31	100	352	P	V
		5462.32	49.85	-18.45	68.3	37.08	31.7	10.38	29.31	100	352	P	V
		5458.96	39.67	-14.33	54	26.9	31.7	10.38	29.31	100	352	A	V
	*	5580	92.8	-	-	79.89	31.73	10.52	29.34	100	352	P	V
		5580	86.43	-	-	73.52	31.73	10.52	29.34	100	352	A	V
	5731.295	49.09	-19.21	68.3	35.81	32.07	10.61	29.4	100	352	P	V	



802.11a CH 140 5700MHz	*	5700	102.76	-	-	89.53	32	10.61	29.38	302	353	P	H
		5700	95.85	-	-	82.62	32	10.61	29.38	302	353	A	H
		5725.32	56	-12.3	68.3	42.71	32.07	10.61	29.39	302	353	P	H
	*	5700	94.13	-	-	80.9	32	10.61	29.38	108	348	P	V
		5700	87.53	-	-	74.3	32	10.61	29.38	108	348	A	V
		5743.08	50.56	-17.74	68.3	37.24	32.1	10.62	29.4	108	348	P	V
Remark	1. No other spurious found. 2. All results are PASS against Peak and Average limit line.												



Band 3 - 5470~5725MHz
WIFI 802.11a (Harmonic @ 3m)

Table with 14 columns: WIFI Ant. 1, Note, Frequency (MHz), Level (dBµV/m), Over Limit (dB), Limit Line (dBµV/m), Read Level (dBµV), Antenna Factor (dB/m), Cable Loss (dB), Preamp Factor (dB), Ant Pos (cm), Table Pos (deg), Peak Avg. (P/A), Pol. (H/V). Rows include channels 100, 116, and 140 with their respective frequency and measurement data.

Remark

- 1. No other spurious found.
2. All results are PASS against Peak and Average limit line.



Band 3 - 5470~5725MHz
WIFI 802.11ac VHT20 (Band Edge @ 3m)

Table with 14 columns: WIFI Ant. 1, Note, Frequency (MHz), Level (dBµV/m), Over Limit (dB), Limit Line (dBµV/m), Read Level (dBµV), Antenna Factor (dB/m), Cable Loss (dB), Preamp Factor (dB), Ant Pos (cm), Table Pos (deg), Peak Avg. (P/A), Pol. (H/V). Rows include data for 802.11ac VHT20 CH 100 (5500MHz) and 802.11ac VHT20 CH 116 (5580MHz).



802.11ac	*	5700	99.58	-	-	86.35	32	10.61	29.38	100	283	P	H
		5700	93.33	-	-	80.1	32	10.61	29.38	100	283	A	H
VHT20		5725.16	56.4	-11.9	68.3	43.11	32.07	10.61	29.39	100	283	P	H
CH 140	*	5700	94.09	-	-	80.86	32	10.61	29.38	101	54	P	V
5700MHz		5700	87.22	-	-	73.99	32	10.61	29.38	101	54	A	V
		5753.32	51.42	-16.88	68.3	38.07	32.13	10.62	29.4	101	54	P	V
Remark	1. No other spurious found. 2. All results are PASS against Peak and Average limit line.												



Band 3 - 5470~5725MHz
WIFI 802.11ac VHT20 (Harmonic @ 3m)

WIFI Ant. 1	Note	Frequency (MHz)	Level (dBμV/m)	Over Limit (dB)	Limit Line (dBμV/m)	Read Level (dBμV)	Antenna Factor (dB/m)	Cable Loss (dB)	Preamp Factor (dB)	Ant Pos (cm)	Table Pos (deg)	Peak Avg. (P/A)	Pol. (H/V)
802.11ac		11000	48.64	-25.36	74	46.72	40.1	14.72	52.9	196	296	P	H
VHT20		16500	52.48	-15.82	68.3	45.34	38.5	20.34	51.7	191	271	P	H
CH 100		11000	50.18	-23.82	74	48.26	40.1	14.72	52.9	163	230	P	V
5500MHz		16500	52.22	-16.08	68.3	45.08	38.5	20.34	51.7	178	296	P	V
802.11ac		11160	48.12	-25.88	74	46.38	39.67	14.87	52.8	170	200	P	H
VHT20		16740	53.66	-14.64	68.3	44.58	39.9	21.17	51.99	156	350	P	H
CH 116		11160	47.95	-26.05	74	46.21	39.67	14.87	52.8	170	296	P	V
5580MHz		16740	53.64	-14.66	68.3	44.56	39.9	21.17	51.99	145	350	P	V
802.11ac		11400	49.18	-24.82	74	46.88	39.9	15.06	52.66	157	285	P	H
VHT20		17100	53.35	-14.95	68.3	43.31	40.2	22.24	52.4	165	246	P	H
CH 140		11400	48.21	-25.79	74	45.91	39.9	15.06	52.66	157	221	P	V
5700MHz		17100	53.1	-15.2	68.3	43.06	40.2	22.24	52.4	196	246	P	V
Remark	1. No other spurious found. 2. All results are PASS against Peak and Average limit line.												



Band 3 - 5470~5725MHz
WIFI 802.11ac VHT40 (Band Edge @ 3m)

WIFI Ant. 1	Note	Frequency (MHz)	Level (dBμV/m)	Over Limit (dB)	Limit Line (dBμV/m)	Read Level (dBμV)	Antenna Factor (dB/m)	Cable Loss (dB)	Preamp Factor (dB)	Ant Pos (cm)	Table Pos (deg)	Peak Avg. (P/A)	Pol. (H/V)
802.11ac VHT40 CH 102 5510MHz		5459.92	52.78	-21.22	74	40.01	31.7	10.38	29.31	300	344	P	H
		5468.8	54.6	-13.7	68.3	41.71	31.77	10.43	29.31	300	344	P	H
		5459.92	43.95	-10.05	54	31.18	31.7	10.38	29.31	300	344	A	H
	*	5510	97.22	-	-	84.16	31.9	10.47	29.31	300	344	P	H
		5510	90.68	-	-	77.62	31.9	10.47	29.31	300	344	A	H
		5745.785	49.14	-19.16	68.3	35.82	32.1	10.62	29.4	300	344	P	H
		5458.96	51.78	-22.22	74	39.01	31.7	10.38	29.31	255	255	P	V
		5469.52	56.08	-12.22	68.3	43.19	31.77	10.43	29.31	255	255	P	V
		5459.92	44.35	-9.65	54	31.58	31.7	10.38	29.31	255	255	A	V
	*	5510	97.73	-	-	84.67	31.9	10.47	29.31	255	255	P	V
		5510	91.66	-	-	78.6	31.9	10.47	29.31	255	255	A	V
		5764.68	49.19	-19.11	68.3	35.85	32.13	10.62	29.41	255	255	P	V
802.11ac VHT40 CH 110 5550MHz		5437.12	50.96	-23.04	74	38.19	31.7	10.38	29.31	189	351	P	H
		5460.88	49.75	-18.55	68.3	36.98	31.7	10.38	29.31	189	351	P	H
		5456.8	41.89	-12.11	54	29.12	31.7	10.38	29.31	189	351	A	H
	*	5550	97.25	-	-	84.35	31.7	10.52	29.32	189	351	P	H
		5550	91.36	-	-	78.46	31.7	10.52	29.32	189	351	A	H
		5747.36	49.06	-19.24	68.3	35.74	32.1	10.62	29.4	189	351	P	H
		5404.96	49.73	-24.27	74	37.01	31.7	10.34	29.32	285	266	P	V
		5460.16	50.92	-17.38	68.3	38.15	31.7	10.38	29.31	285	266	P	V
		5454.16	42.03	-11.97	54	29.26	31.7	10.38	29.31	285	266	A	V
	*	5550	96.9	-	-	84	31.7	10.52	29.32	285	266	P	V
	5550	90.13	-	-	77.23	31.7	10.52	29.32	285	266	A	V	
	5743.265	49.57	-18.73	68.3	36.25	32.1	10.62	29.4	285	266	P	V	



802.11ac VHT40 CH 134 5670MHz		5458.85	49.68	-24.32	74	36.91	31.7	10.38	29.31	241	292	P	H
		5463.05	48.15	-20.15	68.3	35.31	31.77	10.38	29.31	241	292	P	H
		5460	41.51	-12.49	54	28.74	31.7	10.38	29.31	241	292	A	H
	*	5670	99.41	-	-	86.34	31.85	10.59	29.37	241	292	P	H
		5670	93.35	-	-	80.28	31.85	10.59	29.37	241	292	A	H
		5725.275	53.18	-15.12	68.3	39.89	32.07	10.61	29.39	241	292	P	H
		5415.45	49.61	-24.39	74	36.89	31.7	10.34	29.32	261	257	P	V
		5466.55	49.21	-19.09	68.3	36.32	31.77	10.43	29.31	261	257	P	V
		5454.3	41.36	-12.64	54	28.59	31.7	10.38	29.31	261	257	P	V
	*	5670	94.41	-	-	81.34	31.85	10.59	29.37	261	257	P	V
		5670	88.57	-	-	75.5	31.85	10.59	29.37	261	257	A	V
		5730.875	50.6	-17.7	68.3	37.32	32.07	10.61	29.4	261	257	P	V
Remark	1. No other spurious found. 2. All results are PASS against Peak and Average limit line.												



Band 3 - 5470~5725MHz
WIFI 802.11ac VHT40 (Harmonic @ 3m)

WIFI Ant. 1	Note	Frequency (MHz)	Level (dBμV/m)	Over Limit (dB)	Limit Line (dBμV/m)	Read Level (dBμV)	Antenna Factor (dB/m)	Cable Loss (dB)	Preamp Factor (dB)	Ant Pos (cm)	Table Pos (deg)	Peak Avg. (P/A)	Pol. (H/V)
802.11ac		11020	49.71	-24.29	74	47.8	40.05	14.75	52.89	150	222	P	H
VHT40		16530	53.05	-15.25	68.3	45.66	38.67	20.46	51.74	160	300	P	H
CH 102		11020	49.13	-24.87	74	47.22	40.05	14.75	52.89	170	230	P	V
5510MHz		16530	52.43	-15.87	68.3	45.04	38.67	20.46	51.74	160	300	P	V
802.11ac		11100	49.12	-24.88	74	47.35	39.8	14.81	52.84	154	230	P	H
VHT40		16650	53.5	-14.8	68.3	45.13	39.45	20.81	51.89	120	330	P	H
CH 110		11100	48.82	-25.18	74	47.05	39.8	14.81	52.84	150	200	P	V
5550MHz		16650	52.61	-15.69	68.3	44.24	39.45	20.81	51.89	180	350	P	V
802.11ac		11340	48.14	-25.86	74	46.01	39.83	15	52.7	200	360	P	H
VHT40		17010	55.78	-12.52	68.3	45.57	40.53	22	52.32	200	360	P	H
CH 134		11340	48.1	-25.9	74	45.97	39.83	15	52.7	135	310	P	V
5670MHz		17010	54.58	-13.72	68.3	44.37	40.53	22	52.32	150	180	P	V
Remark	1. No other spurious found. 2. All results are PASS against Peak and Average limit line.												



Band 3 5470~5725MHz
WIFI 802.11ac VHT80 (Band Edge @ 3m)

WIFI Ant. 1	Note	Frequency (MHz)	Level (dBμV/m)	Over Limit (dB)	Limit Line (dBμV/m)	Read Level (dBμV)	Antenna Factor (dB/m)	Cable Loss (dB)	Preamp Factor (dB)	Ant Pos (cm)	Table Pos (deg)	Peak Avg. (P/A)	Pol. (H/V)
802.11ac VHT80 CH 106 5530MHz		5451.52	59	-15	74	46.23	31.7	10.38	29.31	100	15	P	H
		5470	61.16	-7.14	68.3	48.27	31.77	10.43	29.31	100	15	P	H
		5452.48	49.99	-4.01	54	37.22	31.7	10.38	29.31	100	15	A	H
	*	5530	92.13	-	-	79.15	31.83	10.47	29.32	100	15	P	H
		5530	86.32	-	-	73.34	31.83	10.47	29.32	100	15	A	H
		5730.98	50.5	-17.8	68.3	37.22	32.07	10.61	29.4	100	15	P	H
		5452.24	53.36	-20.64	74	40.59	31.7	10.38	29.31	100	350	P	V
		5470	53.41	-14.89	68.3	40.52	31.77	10.43	29.31	100	350	P	V
		5454.88	43.51	-10.49	54	30.74	31.7	10.38	29.31	100	350	A	V
	*	5530	88.15	-	-	75.17	31.83	10.47	29.32	100	350	P	V
		5530	82.41	-	-	69.43	31.83	10.47	29.32	100	350	A	V
		5747.36	49.03	-19.27	68.3	35.71	32.1	10.62	29.4	100	350	P	V
802.11ac VHT80 CH 122 5610MHz		5459.68	50.5	-23.5	74	37.73	31.7	10.38	29.31	100	15	P	H
		5467.36	50.55	-17.75	68.3	37.66	31.77	10.43	29.31	100	15	P	H
		5458.72	41.24	-12.76	54	28.47	31.7	10.38	29.31	100	15	A	H
	*	5610	92.22	-	-	79.21	31.8	10.56	29.35	100	15	P	H
		5610	86.21	-	-	73.2	31.8	10.56	29.35	100	15	A	H
		5734.725	50.61	-17.69	68.3	37.3	32.1	10.61	29.4	100	15	P	H
		5428	50.65	-23.35	74	37.88	31.7	10.38	29.31	100	350	P	V
		5467.36	50.64	-17.66	68.3	37.75	31.77	10.43	29.31	100	350	P	V
		5447.44	41.19	-12.81	54	28.42	31.7	10.38	29.31	100	350	A	V
	*	5610	93.44	-	-	80.43	31.8	10.56	29.35	100	350	P	V
	5610	87.12	-	-	74.11	31.8	10.56	29.35	100	350	A	V	
	5742.075	51.51	-16.79	68.3	38.19	32.1	10.62	29.4	100	350	P	V	
Remark	1. No other spurious found. 2. All results are PASS against Peak and Average limit line.												



Band 3 5470~5725MHz
WIFI 802.11ac VHT80 (Harmonic @ 3m)

Table with 14 columns: WIFI Ant. 1, Note, Frequency (MHz), Level (dBµV/m), Over Limit (dB), Limit Line (dBµV/m), Read Level (dBµV), Antenna Factor (dB/m), Cable Loss (dB), Preamp Factor (dB), Ant Pos (cm), Table Pos (deg), Peak Avg. (P/A), Pol. (H/V). Rows include test results for 802.11ac, VHT80, CH 106, 5530MHz, CH 122, and 5610MHz.

Remark
1. No other spurious found.
2. All results are PASS against Peak and Average limit line.



Band 3 - Straddle Channel
WIFI 802.11a (Harmonic @ 3m)

WIFI Ant. 1	Note	Frequency (MHz)	Level (dBμV/m)	Over Limit (dB)	Limit Line (dBμV/m)	Read Level (dBμV)	Antenna Factor (dB/m)	Cable Loss (dB)	Preamp Factor (dB)	Ant Pos (cm)	Table Pos (deg)	Peak Avg. (P/A)	Pol. (H/V)
802.11a CH 144 5720MHz		11440	49.31	-24.69	74	46.89	39.97	15.09	52.64	150	280	P	H
		17160	49.63	-18.67	68.3	39.54	40.2	22.36	52.47	163	250	P	H
		11440	49.43	-24.57	74	47.01	39.97	15.09	52.64	150	280	P	V
		17160	50.77	-17.53	68.3	40.68	40.2	22.36	52.47	163	250	P	V
Remark	1. No other spurious found. 2. All results are PASS against Peak and Average limit line.												



Band 3 - Straddle Channel
WIFI 802.11ac VHT20 (Harmonic @ 3m)

Table with 14 columns: WIFI Ant. 1, Note, Frequency (MHz), Level (dBµV/m), Over Limit (dB), Limit Line (dBµV/m), Read Level (dBµV), Antenna Factor (dB/m), Cable Loss (dB), Preamp Factor (dB), Ant Pos (cm), Table Pos (deg), Peak Avg. (P/A), Pol. (H/V). Rows include 802.11ac VHT20 CH 144 5720MHz and a Remark section.



Band 3 - Straddle Channel
WIFI 802.11ac VHT40 (Harmonic @ 3m)

Table with 14 columns: WIFI Ant. 1, Note, Frequency (MHz), Level (dBµV/m), Over Limit (dB), Limit Line (dBµV/m), Read Level (dBµV), Antenna Factor (dB/m), Cable Loss (dB), Preamp Factor (dB), Ant Pos (cm), Table Pos (deg), Peak Avg. (P/A), Pol. (H/V). Rows include 802.11ac VHT40 CH 142 5710MHz and a Remark section.



Band 3 - Straddle Channel
WIFI 802.11ac VHT80 (Harmonic @ 3m)

WIFI Ant. 1	Note	Frequency (MHz)	Level (dBμV/m)	Over Limit (dB)	Limit Line (dBμV/m)	Read Level (dBμV)	Antenna Factor (dB/m)	Cable Loss (dB)	Preamp Factor (dB)	Ant Pos (cm)	Table Pos (deg)	Peak Avg. (P/A)	Pol. (H/V)
802.11ac		11380	48.2	-25.8	74	45.96	39.88	15.03	52.67	152	300	P	H
VHT80		17070	50.17	-18.13	68.3	40.09	40.33	22.12	52.37	140	310	P	H
CH 138		11380	48.72	-25.28	74	46.48	39.88	15.03	52.67	152	300	P	V
5690MHz		17070	50.6	-17.7	68.3	40.52	40.33	22.12	52.37	140	310	P	V
Remark	1. No other spurious found. 2. All results are PASS against Peak and Average limit line.												



Emission below 1GHz

WIFI 802. 11ac VHT80 (LF @ 3m)

WIFI	Note	Frequency	Level	Over	Limit	Read	Antenna	Cable	Preamp	Ant	Table	Peak	Pol.
Ant.				Limit	Line	Level	Factor	Loss	Factor	Pos	Pos	Avg.	
1		(MHz)	(dBμV/m)	(dB)	(dBμV/m)	(dBμV)	(dB/m)	(dB)	(dB)	(cm)	(deg)	(P/A)	(H/V)
802.11ac VHT80 LF		30.97	25.54	-14.46	40	31.94	24.33	0.57	31.3	100	320	P	H
		80.44	20.82	-19.18	40	38.09	13.4	0.93	31.6	-	-	P	H
		133.79	23.81	-19.69	43.5	36.6	17.47	1.2	31.46	-	-	P	H
		240.49	24.45	-21.55	46	36.82	17.64	1.62	31.63	-	-	P	H
		544.1	27.02	-18.98	46	31.06	24.73	2.52	31.29	-	-	P	H
		901.06	29.94	-16.06	46	29.1	29.02	3.32	31.5	-	-	P	H
		30	29.77	-10.23	40	35.71	24.8	0.56	31.3	100	22	P	V
		81.41	21.78	-18.22	40	38.9	13.54	0.94	31.6	-	-	P	V
		129.91	26.91	-16.59	43.5	39.76	17.45	1.18	31.48	-	-	P	V
		256.01	25.74	-20.26	46	35.87	19.85	1.68	31.66	-	-	P	V
		522.76	27.11	-18.89	46	31.58	24.32	2.46	31.25	-	-	P	V
	946.65	29.39	-16.61	46	27.56	29.75	3.39	31.31	-	-	P	V	
Remark	1. No other spurious found. 2. All results are PASS against limit line.												



Note symbol

*	Fundamental Frequency which can be ignored. However, the level of any unwanted emissions shall not exceed the level of the fundamental frequency.
!	Test result is over limit line.
P/A	Peak or Average
H/V	Horizontal or Vertical



A calculation example for radiated spurious emission is shown as below:

WIFI	Note	Frequency	Level	Over	Limit	Read	Antenna	Cable	Preamp	Ant	Table	Peak	Pol.
Ant.				Limit	Line	Level	Factor	Loss	Factor	Pos	Pos	Avg.	
1		(MHz)	(dBμV/m)	(dB)	(dBμV/m)	(dBμV)	(dB/m)	(dB)	(dB)	(cm)	(deg)	(P/A)	(H/V)
802.11b		2390	55.45	-18.55	74	54.51	32.22	4.58	35.86	103	308	P	H
CH 01													
2412MHz		2390	43.54	-10.46	54	42.6	32.22	4.58	35.86	103	308	A	H

- Level(dBμV/m) =
Antenna Factor(dB/m) + Cable Loss(dB) + Read Level(dBμV) - Preamp Factor(dB)
- Over Limit(dB) = Level(dBμV/m) – Limit Line(dBμV/m)

For Peak Limit @ 2390MHz:

- Level(dBμV/m)
= Antenna Factor(dB/m) + Cable Loss(dB) + Read Level(dBμV) - Preamp Factor(dB)
= 32.22(dB/m) + 4.58(dB) + 54.51(dBμV) – 35.86 (dB)
= 55.45 (dBμV/m)
- Over Limit(dB)
= Level(dBμV/m) – Limit Line(dBμV/m)
= 55.45(dBμV/m) – 74(dBμV/m)
= -18.55(dB)

For Average Limit @ 2390MHz:

- Level(dBμV/m)
= Antenna Factor(dB/m) + Cable Loss(dB) + Read Level(dBμV) - Preamp Factor(dB)
= 32.22(dB/m) + 4.58(dB) + 42.6(dBμV) – 35.86 (dB)
= 43.54 (dBμV/m)
- Over Limit(dB)
= Level(dBμV/m) – Limit Line(dBμV/m)
= 43.54(dBμV/m) – 54(dBμV/m)
= -10.46(dB)

Both peak and average measured complies with the limit line, so test result is “PASS”.



Appendix D. Duty Cycle Plots

Band	Duty Cycle(%)	T(ms)	1/T(kHz)	VBW Setting
802.11a	98.28	-	-	10Hz
802.11ac VHT20	98.16	-	-	10Hz
802.11ac VHT40	96.35	0.957	1.045	3kHz
802.11ac VHT80	93.30	0.464	2.156	3kHz

802.11a

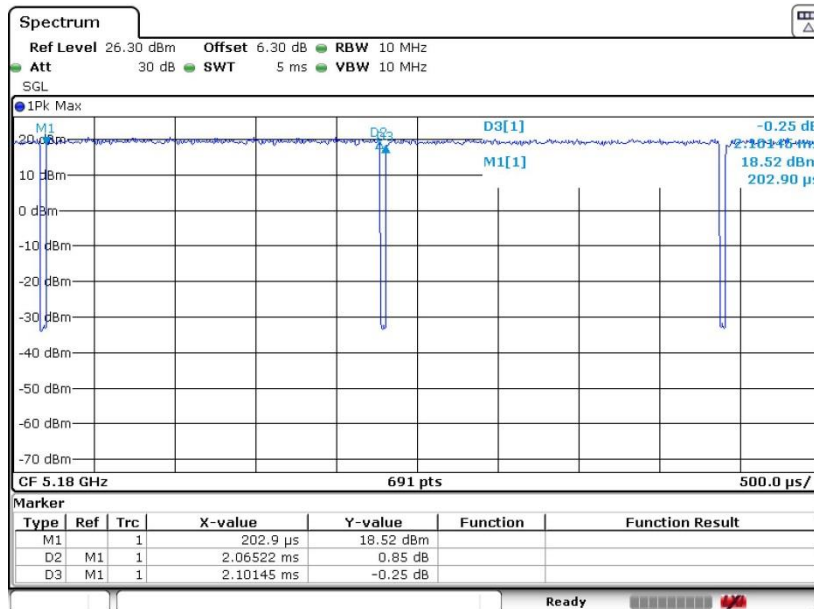

Date: 22.APR.2020 12:44:11



802.11ac VHT20

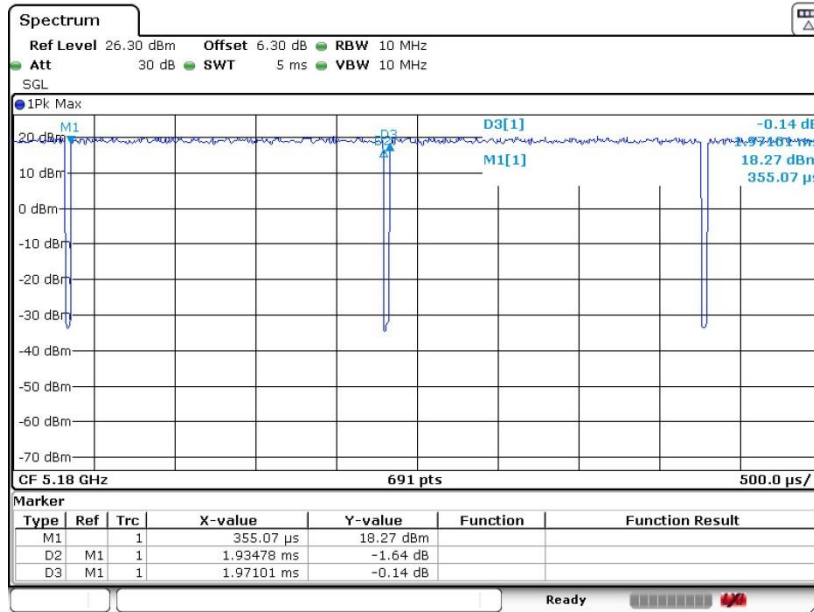

Date: 22.APR.2020 12:51:48

802.11ac VHT40

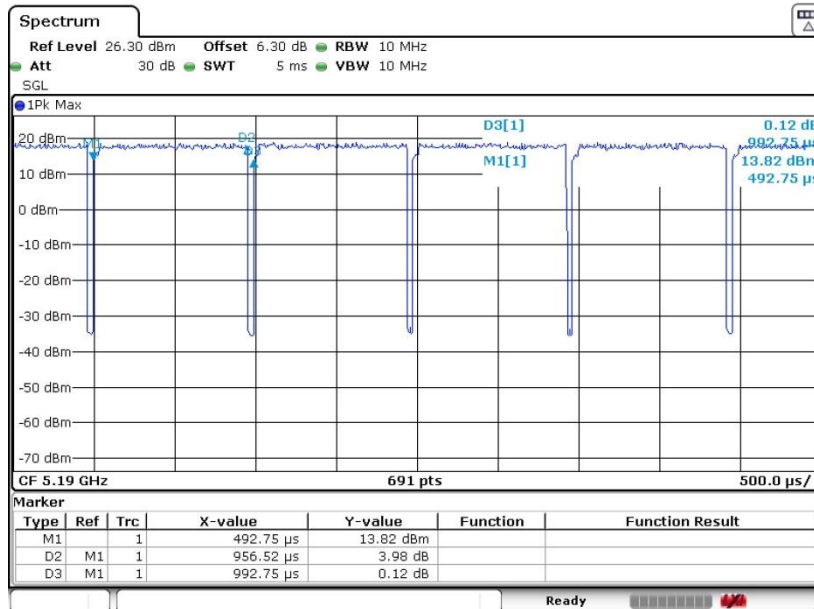

Date: 22.APR.2020 12:53:55



802.11ac VHT80

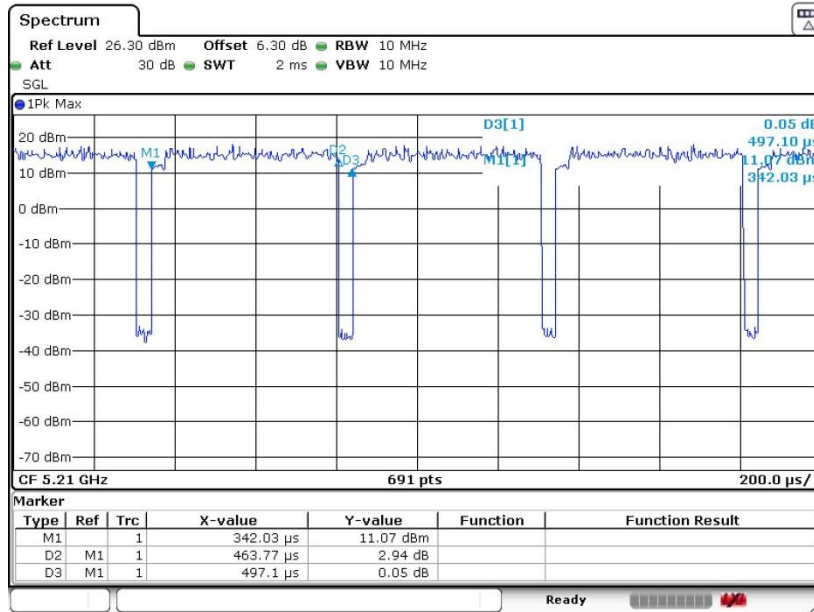

Date: 22.APR.2020 12:56:10