

System Check_Head_2600MHz

DUT: D2600V2 - SN:1061

Communication System: UID 0, CW (0); Frequency: 2600 MHz;Duty Cycle: 1:1
 Medium: HSL_2600 Medium parameters used: $f = 2600$ MHz; $\sigma = 2.027$ S/m; $\epsilon_r = 37.857$; $\rho = 1000$ kg/m³
 Ambient Temperature : 23.3 °C; Liquid Temperature : 22.9 °C

DASY5 Configuration:

- Probe: ES3DV3 - SN3293; ConvF(4.39, 4.39, 4.39); Calibrated: 2019.11.25
- Sensor-Surface: 3mm (Mechanical Surface Detection)
- Electronics: DAE4 Sn1338; Calibrated: 2019.11.20
- Phantom: SAM2; Type: SAM; Serial: TP-1503
- Measurement SW: DASY52, Version 52.10 (1); SEMCAD X Version 14.6.11 (7439)

Pin=250mW/Area Scan (71x71x1): Interpolated grid: dx=1.200 mm, dy=1.200 mm
 Maximum value of SAR (interpolated) = 24.1 W/kg

Pin=250mW/Zoom Scan (7x7x7)/Cube 0: Measurement grid: dx=5mm, dy=5mm, dz=5mm
 Reference Value = 72.80 V/m; Power Drift = 0.05 dB
 Peak SAR (extrapolated) = 32.4 W/kg
SAR(1 g) = 14.8 W/kg; SAR(10 g) = 6.52 W/kg
 Maximum value of SAR (measured) = 23.4 W/kg

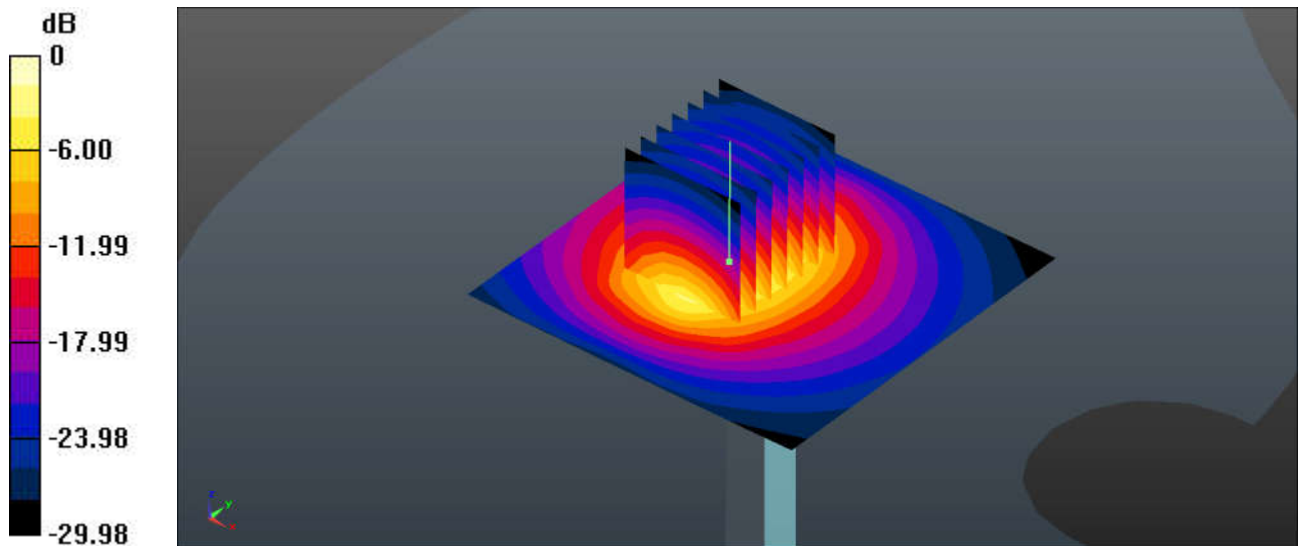

0 dB = 24.1 W/kg = 13.82 dBW/kg

System Check_Head_2600MHz

DUT: D2600V2 - SN:1061

Communication System: UID 0, CW (0); Frequency: 2600 MHz; Duty Cycle: 1:1
Medium: HSL_2600 Medium parameters used: $f = 2600$ MHz; $\sigma = 2.036$ S/m; $\epsilon_r = 38.304$; $\rho = 1000$ kg/m³
Ambient Temperature : 23.3 °C; Liquid Temperature : 22.9 °C

DASY5 Configuration:

- Probe: ES3DV3 - SN3293; ConvF(4.39, 4.39, 4.39); Calibrated: 2019.11.25
- Sensor-Surface: 3mm (Mechanical Surface Detection)
- Electronics: DAE4 Sn1338; Calibrated: 2019.11.20
- Phantom: SAM2; Type: SAM; Serial: TP-1503
- Measurement SW: DASY52, Version 52.10 (1); SEMCAD X Version 14.6.11 (7439)

Pin=250mW/Area Scan (71x71x1): Interpolated grid: dx=1.200 mm, dy=1.200 mm
Maximum value of SAR (interpolated) = 24.3 W/kg

Pin=250mW/Zoom Scan (7x7x7)/Cube 0: Measurement grid: dx=5mm, dy=5mm, dz=5mm
Reference Value = 72.80 V/m; Power Drift = 0.15 dB
Peak SAR (extrapolated) = 32.5 W/kg
SAR(1 g) = 14.8 W/kg; SAR(10 g) = 6.55 W/kg
Maximum value of SAR (measured) = 23.5 W/kg

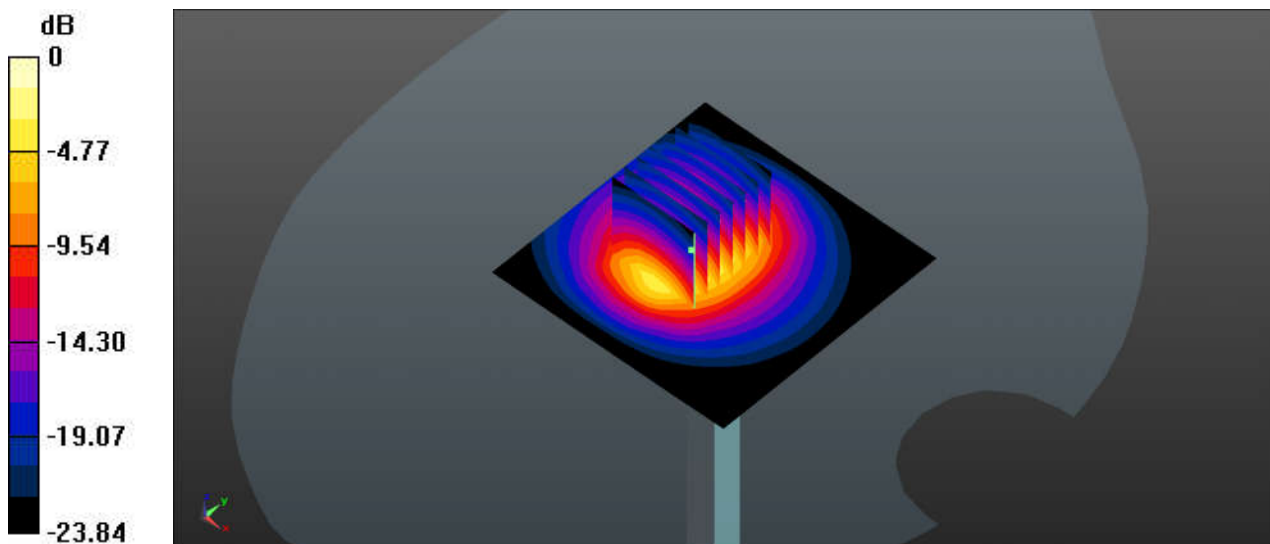

0 dB = 23.5 W/kg = 13.71 dBW/kg

System Check_Head_2600MHz

DUT: D2600V2 - SN:1061

Communication System: UID 0, CW (0); Frequency: 2600 MHz;Duty Cycle: 1:1
Medium: HSL_2600 Medium parameters used: $f = 2600$ MHz; $\sigma = 2.053$ S/m; $\epsilon_r = 38.089$; $\rho = 1000$ kg/m³
Ambient Temperature : 23.3 °C; Liquid Temperature : 22.9 °C

DASY5 Configuration:

- Probe: ES3DV3 - SN3293; ConvF(4.39, 4.39, 4.39); Calibrated: 2019.11.25
- Sensor-Surface: 3mm (Mechanical Surface Detection)
- Electronics: DAE4 Sn1338; Calibrated: 2019.11.20
- Phantom: SAM2; Type: SAM; Serial: TP-1503
- Measurement SW: DASY52, Version 52.10 (1); SEMCAD X Version 14.6.11 (7439)

Pin=250mW/Area Scan (71x71x1): Interpolated grid: dx=1.200 mm, dy=1.200 mm

Maximum value of SAR (interpolated) = 24.5 W/kg

Pin=250mW/Zoom Scan (7x7x7)/Cube 0: Measurement grid: dx=5mm, dy=5mm, dz=5mm

Reference Value = 72.80 V/m; Power Drift = 0.15 dB

Peak SAR (extrapolated) = 32.8 W/kg

SAR(1 g) = 15 W/kg; SAR(10 g) = 6.6 W/kg

Maximum value of SAR (measured) = 23.7 W/kg

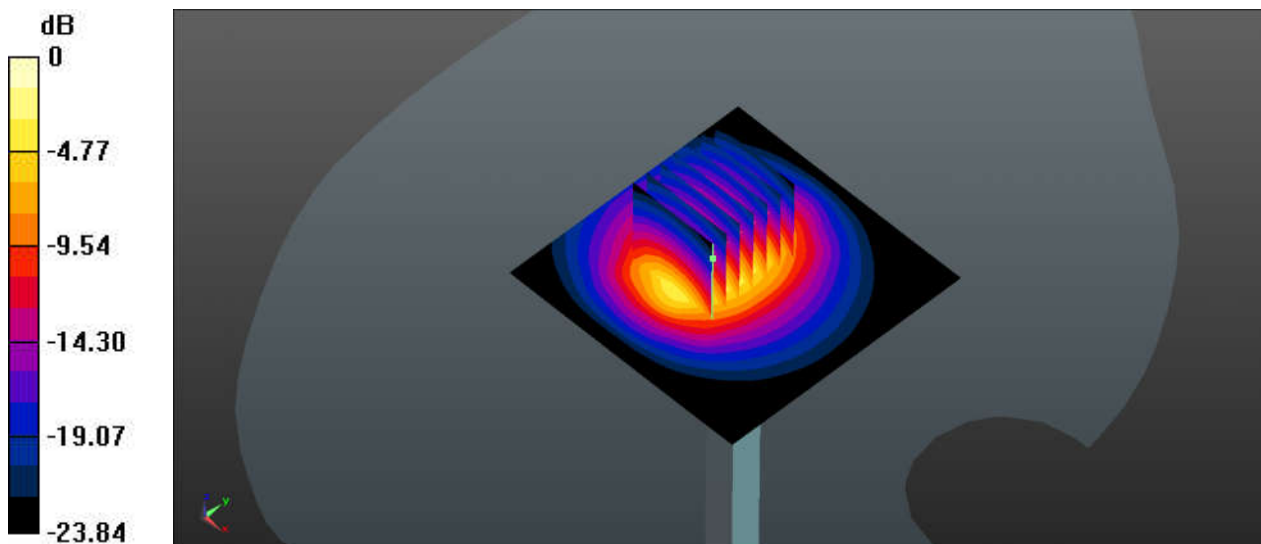

0 dB = 23.7 W/kg = 13.75 dBW/kg

System Check_Head_2600MHz

DUT: D2600V2 - SN:1061

Communication System: UID 0, CW (0); Frequency: 2600 MHz;Duty Cycle: 1:1
Medium: HSL_2600 Medium parameters used: $f = 2600$ MHz; $\sigma = 2.052$ S/m; $\epsilon_r = 38.095$; $\rho = 1000$ kg/m³
Ambient Temperature : 23.3 °C; Liquid Temperature : 22.9 °C

DASY5 Configuration:

- Probe: ES3DV3 - SN3293; ConvF(4.39, 4.39, 4.39); Calibrated: 2019.11.25
- Sensor-Surface: 3mm (Mechanical Surface Detection)
- Electronics: DAE4 Sn1338; Calibrated: 2019.11.20
- Phantom: SAM2; Type: SAM; Serial: TP-1503
- Measurement SW: DASY52, Version 52.10 (1); SEMCAD X Version 14.6.11 (7439)

Pin=250mW/Area Scan (71x71x1): Interpolated grid: dx=1.200 mm, dy=1.200 mm

Maximum value of SAR (interpolated) = 24.4 W/kg

Pin=250mW/Zoom Scan (7x7x7)/Cube 0: Measurement grid: dx=5mm, dy=5mm, dz=5mm

Reference Value = 72.80 V/m; Power Drift = 0.15 dB

Peak SAR (extrapolated) = 32.8 W/kg

SAR(1 g) = 15 W/kg; SAR(10 g) = 6.6 W/kg

Maximum value of SAR (measured) = 23.7 W/kg

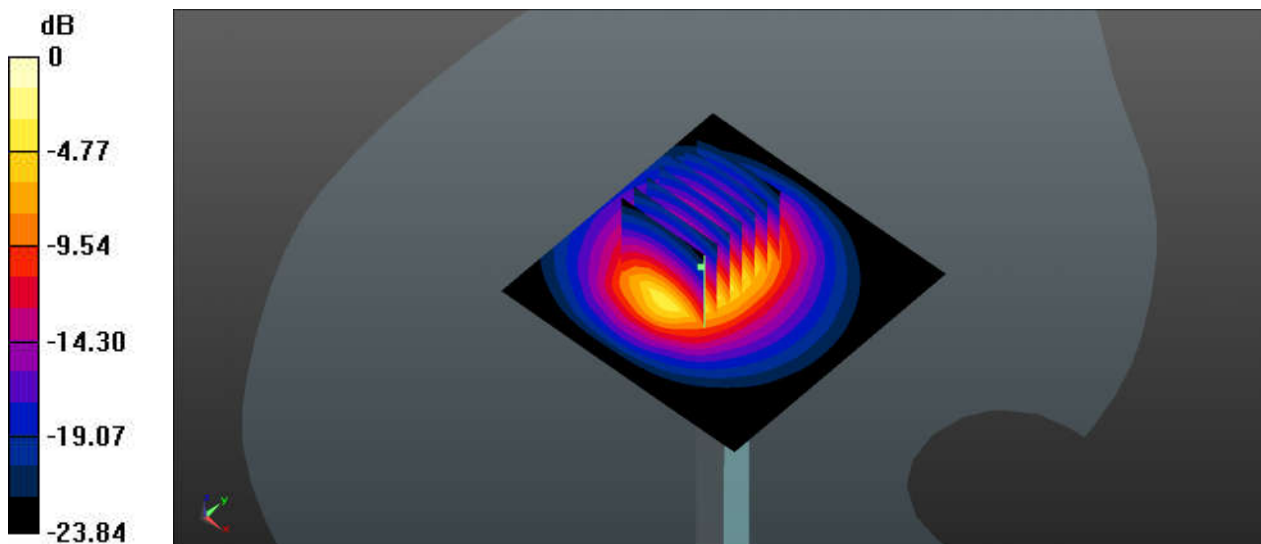

0 dB = 23.7 W/kg = 13.75 dBW/kg

System Check_Head_5250MHz

DUT: D5GHzV2-1113

Communication System: UID 0, CW (0); Frequency: 5250 MHz; Duty Cycle: 1:1

Medium: HSL_5000 Medium parameters used: $f = 5250$ MHz; $\sigma = 4.601$ S/m; $\epsilon_r = 36.381$; $\rho = 1000$ kg/m³

Ambient Temperature : 23.2 °C ; Liquid Temperature : 22.7 °C

DASY5 Configuration:

- Probe: EX3DV4 - SN3857; ConvF(5.19, 5.19, 5.19); Calibrated: 2019.5.27
- Sensor-Surface: 1.4mm (Mechanical Surface Detection)
- Electronics: DAE4 Sn1338; Calibrated: 2019.11.20
- Phantom: SAM1; Type: SAM; Serial: TP-1839
- Measurement SW: DASY52, Version 52.10 (1); SEMCAD X Version 14.6.11 (7439)

CW/Area Scan (71x71x1): Interpolated grid: dx=1.000 mm, dy=1.000 mm

Maximum value of SAR (interpolated) = 18.7 W/kg

CW/Zoom Scan (8x8x7)/Cube 0: Measurement grid: dx=4mm, dy=4mm, dz=1.4mm

Reference Value = 44.50 V/m; Power Drift = 0.18 dB

Peak SAR (extrapolated) = 29.7 W/kg

SAR(1 g) = 8.01 W/kg; SAR(10 g) = 2.32 W/kg

Maximum value of SAR (measured) = 18.0 W/kg

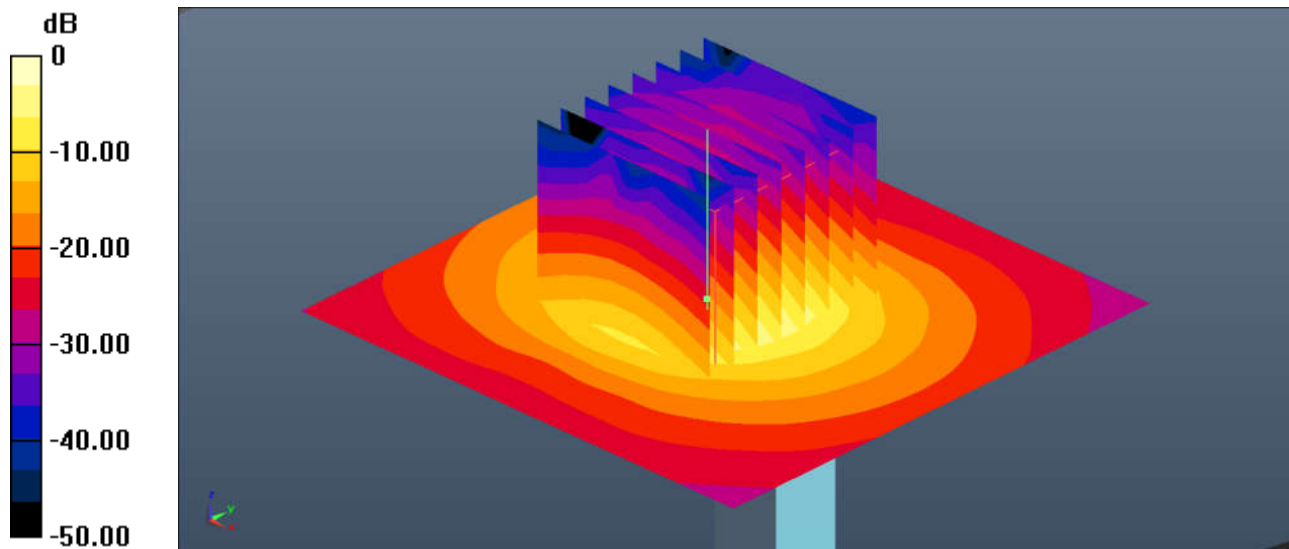

0 dB = 18.0 W/kg = 12.55 dBW/kg

System Check_Head_5600MHz

DUT: D5GHzV2-1113

Communication System: UID 0, CW (0); Frequency: 5600 MHz; Duty Cycle: 1:1
Medium: HSL_5000 Medium parameters used: $f = 5600$ MHz; $\sigma = 4.99$ S/m; $\epsilon_r = 35.802$; $\rho = 1000$ kg/m³
Ambient Temperature : 23.2 °C ; Liquid Temperature : 22.6 °C

DASY5 Configuration:

- Probe: EX3DV4 - SN3857; ConvF(4.92, 4.92, 4.92); Calibrated: 2019.5.27
- Sensor-Surface: 1.4mm (Mechanical Surface Detection)
- Electronics: DAE4 Sn1338; Calibrated: 2019.11.20
- Phantom: SAM1; Type: SAM; Serial: TP-1839
- Measurement SW: DASY52, Version 52.10 (1); SEMCAD X Version 14.6.11 (7439)

CW/Area Scan (71x71x1): Interpolated grid: dx=1.000 mm, dy=1.000 mm
Maximum value of SAR (interpolated) = 20.9 W/kg

CW/Zoom Scan (8x8x7)/Cube 0: Measurement grid: dx=4mm, dy=4mm, dz=1.4mm
Reference Value = 42.98 V/m; Power Drift = 0.12 dB
Peak SAR (extrapolated) = 33.4 W/kg
SAR(1 g) = 8.3 W/kg; SAR(10 g) = 2.37 W/kg
Maximum value of SAR (measured) = 19.2 W/kg

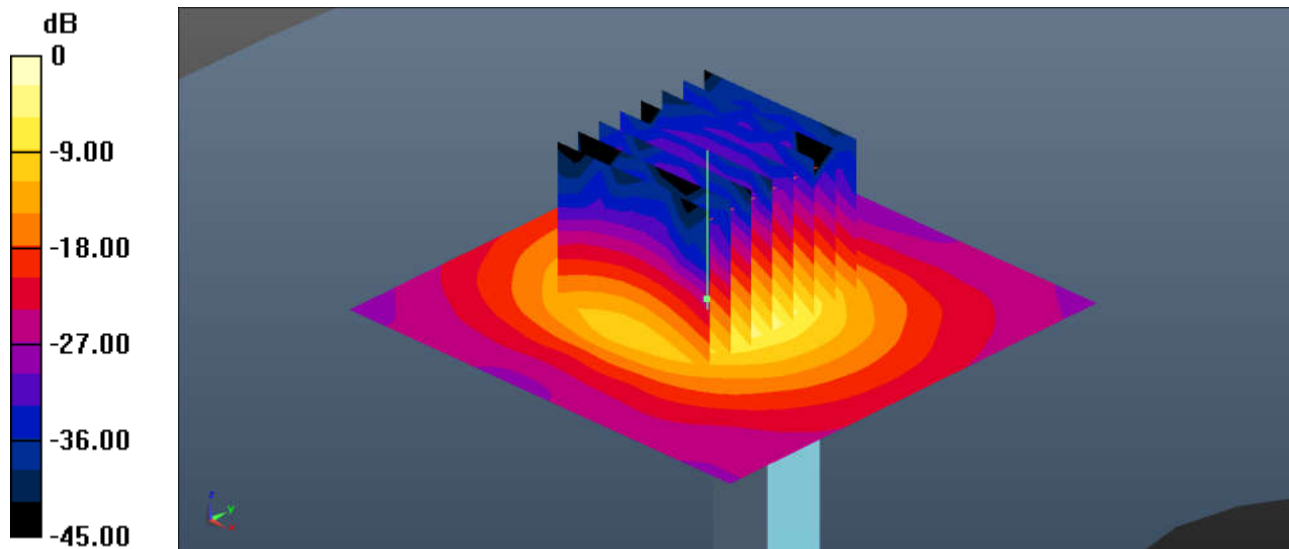

0 dB = 19.2 W/kg = 12.83 dBW/kg

System Check_Head_5750MHz

DUT: D5GHzV2-1113

Communication System: UID 0, CW (0); Frequency: 5750 MHz; Duty Cycle: 1:1
Medium: HSL_5000 Medium parameters used: $f = 5750$ MHz; $\sigma = 5.166$ S/m; $\epsilon_r = 35.55$; $\rho = 1000$ kg/m³
Ambient Temperature : 23.2 °C ; Liquid Temperature : 22.7 °C

DASY5 Configuration:

- Probe: EX3DV4 - SN3857; ConvF(5.17, 5.17, 5.17); Calibrated: 2019.5.27
- Sensor-Surface: 1.4mm (Mechanical Surface Detection)
- Electronics: DAE4 Sn1338; Calibrated: 2019.11.20
- Phantom: SAM1; Type: SAM; Serial: TP-1839
- Measurement SW: DASY52, Version 52.10 (1); SEMCAD X Version 14.6.11 (7439)

CW/Area Scan (71x71x1): Interpolated grid: dx=1.000 mm, dy=1.000 mm
Maximum value of SAR (interpolated) = 18.5 W/kg

CW/Zoom Scan (8x8x7)/Cube 0: Measurement grid: dx=4mm, dy=4mm, dz=1.4mm
Reference Value = 39.26 V/m; Power Drift = 0.03 dB
Peak SAR (extrapolated) = 31.9 W/kg
SAR(1 g) = 7.61 W/kg; SAR(10 g) = 2.17 W/kg
Maximum value of SAR (measured) = 17.7 W/kg

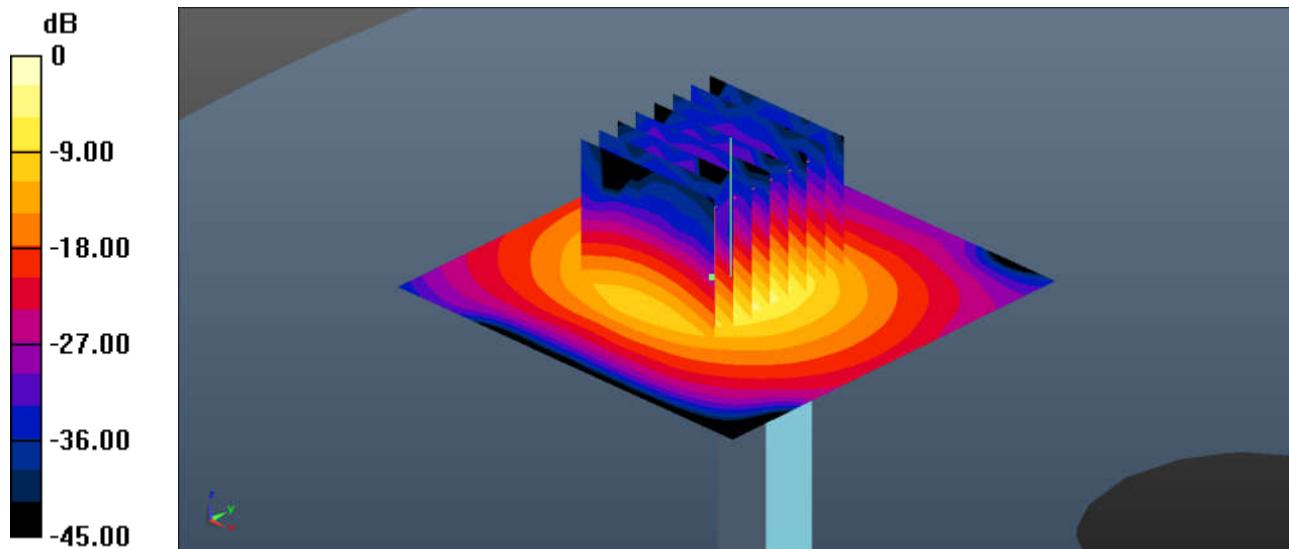

0 dB = 17.7 W/kg = 12.48 dBW/kg



Appendix B. Plots of High SAR Measurement

The plots are shown as follows.

01_GSM850_GPRS 2 Tx slots_Right Cheek_0mm_Ch128

Communication System: UID 0, GSM850-2UP (0); Frequency: 824.2 MHz; Duty Cycle: 1:4.15
 Medium: HSL_835 Medium parameters used: $f = 824.2$ MHz; $\sigma = 0.891$ S/m; $\epsilon_r = 41.376$; $\rho = 1000$ kg/m³
 Ambient Temperature : 23.2 °C; Liquid Temperature : 22.8 °C

DASY5 Configuration:

- Probe: ES3DV3 - SN3293; ConvF(6.39, 6.39, 6.39); Calibrated: 2019.11.25
- Sensor-Surface: 3mm (Mechanical Surface Detection)
- Electronics: DAE4 Sn1338; Calibrated: 2019.11.20
- Phantom: SAM2; Type: SAM; Serial: TP-1503
- Measurement SW: DASY52, Version 52.10 (1); SEMCAD X Version 14.6.11 (7439)

Ch128/Area Scan (81x71x1): Interpolated grid: dx=1.500 mm, dy=1.500 mm

Maximum value of SAR (interpolated) = 0.374 W/kg

Ch128/Zoom Scan (6x5x7)/Cube 0: Measurement grid: dx=8mm, dy=8mm, dz=5mm

Reference Value = 5.044 V/m; Power Drift = 0.06 dB

Peak SAR (extrapolated) = 0.422 W/kg

SAR(1 g) = 0.329 W/kg; SAR(10 g) = 0.252 W/kg

Maximum value of SAR (measured) = 0.362 W/kg

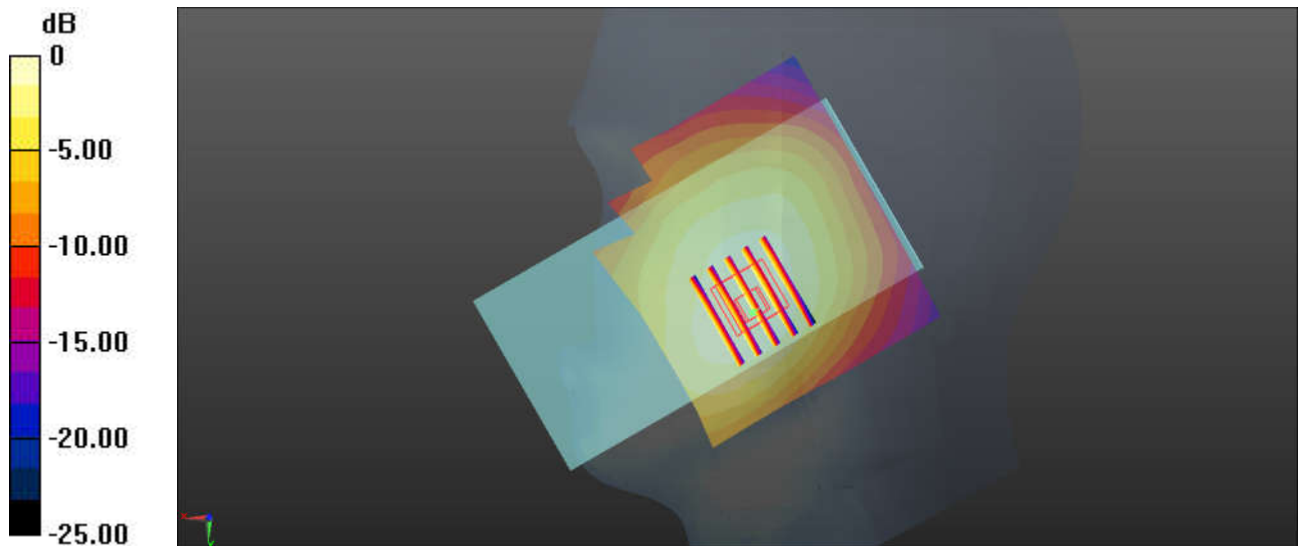

0 dB = 0.374 W/kg = -4.27 dBW/kg

02_GSM1900_GPRS 2 Tx slots_Right Cheek_0mm_Ch512

Communication System: UID 0, PCS-2UP (0); Frequency: 1850.2 MHz; Duty Cycle: 1:4.15
 Medium: HSL_1900 Medium parameters used: $f = 1850.2$ MHz; $\sigma = 1.347$ S/m; $\epsilon_r = 39.244$; $\rho = 1000$ kg/m³
 Ambient Temperature : 23.3 °C; Liquid Temperature : 22.8 °C

DASY5 Configuration:

- Probe: ES3DV3 - SN3293; ConvF(5.32, 5.32, 5.32); Calibrated: 2019.11.25
- Sensor-Surface: 3mm (Mechanical Surface Detection)
- Electronics: DAE4 Sn1338; Calibrated: 2019.11.20
- Phantom: SAM2; Type: SAM; Serial: TP-1503
- Measurement SW: DASY52, Version 52.10 (1); SEMCAD X Version 14.6.11 (7439)

Ch512/Area Scan (81x71x1): Interpolated grid: dx=1.500 mm, dy=1.500 mm

Maximum value of SAR (interpolated) = 0.0332 W/kg

Ch512/Zoom Scan (5x5x7)/Cube 0: Measurement grid: dx=8mm, dy=8mm, dz=5mm

Reference Value = 2.346 V/m; Power Drift = 0.02 dB

Peak SAR (extrapolated) = 0.0420 W/kg

SAR(1 g) = 0.029 W/kg; SAR(10 g) = 0.018 W/kg

Maximum value of SAR (measured) = 0.0337 W/kg

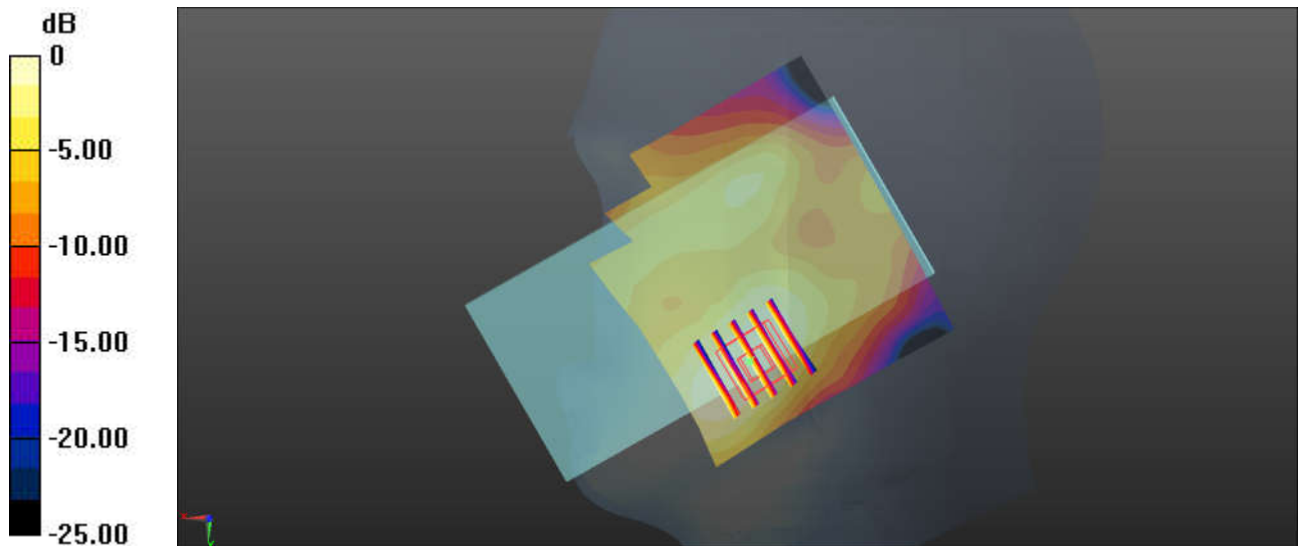

0 dB = 0.0332 W/kg = -14.79 dBW/kg

03_WCDMA II_RMC 12.2Kbps_Right Cheek_0mm_Ch9262

Communication System: UID 0, WCDMA (0); Frequency: 1852.4 MHz; Duty Cycle: 1:1
 Medium: HSL_1900 Medium parameters used: $f = 1852.4 \text{ MHz}$; $\sigma = 1.35 \text{ S/m}$; $\epsilon_r = 39.228$; $\rho = 1000 \text{ kg/m}^3$
 Ambient Temperature : 23.3 °C; Liquid Temperature : 22.8 °C

DASY5 Configuration:

- Probe: ES3DV3 - SN3293; ConvF(5.32, 5.32, 5.32); Calibrated: 2019.11.25
- Sensor-Surface: 3mm (Mechanical Surface Detection)
- Electronics: DAE4 Sn1338; Calibrated: 2019.11.20
- Phantom: SAM2; Type: SAM; Serial: TP-1503
- Measurement SW: DASY52, Version 52.10 (1); SEMCAD X Version 14.6.11 (7439)

Ch9262/Area Scan (81x71x1): Interpolated grid: $dx=1.500 \text{ mm}$, $dy=1.500 \text{ mm}$

Maximum value of SAR (interpolated) = 0.0922 W/kg

Ch9262/Zoom Scan (5x5x7)/Cube 0: Measurement grid: $dx=8\text{mm}$, $dy=8\text{mm}$, $dz=5\text{mm}$

Reference Value = 4.199 V/m; Power Drift = 0.09 dB

Peak SAR (extrapolated) = 0.119 W/kg

SAR(1 g) = 0.079 W/kg; SAR(10 g) = 0.050 W/kg

Maximum value of SAR (measured) = 0.0903 W/kg

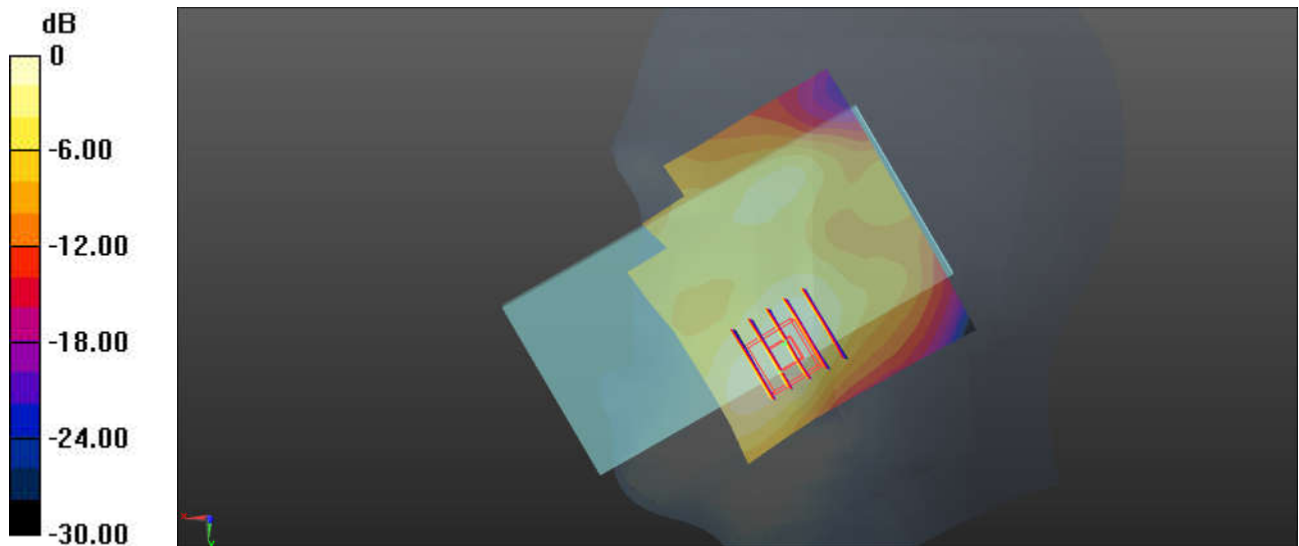

0 dB = 0.0922 W/kg = -10.35 dBW/kg

04_WCDMA IV_RMC 12.2Kbps_Left Cheek_0mm_Ch1413

Communication System: UID 0, WCDMA (0); Frequency: 1732.6 MHz; Duty Cycle: 1:1
 Medium: HSL_1750 Medium parameters used: $f = 1733 \text{ MHz}$; $\sigma = 1.338 \text{ S/m}$; $\epsilon_r = 39.138$; $\rho = 1000 \text{ kg/m}^3$
 Ambient Temperature : $23.3 \text{ }^\circ\text{C}$; Liquid Temperature : $22.6 \text{ }^\circ\text{C}$

DASY5 Configuration:

- Probe: ES3DV3 - SN3293; ConvF(5.53, 5.53, 5.53); Calibrated: 2019.11.25
- Sensor-Surface: 3mm (Mechanical Surface Detection)
- Electronics: DAE4 Sn1338; Calibrated: 2019.11.20
- Phantom: SAM2; Type: SAM; Serial: TP-1503
- Measurement SW: DASY52, Version 52.10 (1); SEMCAD X Version 14.6.11 (7439)

Ch1413/Area Scan (81x71x1): Interpolated grid: $dx=1.500 \text{ mm}$, $dy=1.500 \text{ mm}$

Maximum value of SAR (interpolated) = 0.0659 W/kg

Ch1413/Zoom Scan (5x5x7)/Cube 0: Measurement grid: $dx=8\text{mm}$, $dy=8\text{mm}$, $dz=5\text{mm}$

Reference Value = 3.280 V/m ; Power Drift = 0.03 dB

Peak SAR (extrapolated) = 0.100 W/kg

SAR(1 g) = 0.066 W/kg ; SAR(10 g) = 0.043 W/kg

Maximum value of SAR (measured) = 0.0772 W/kg

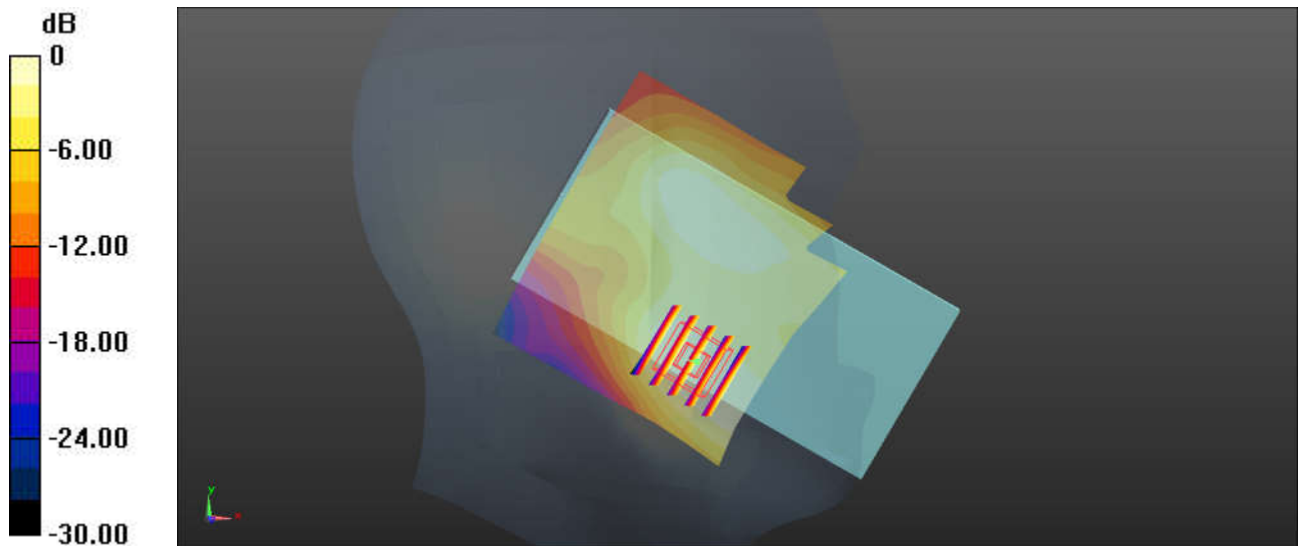

$0 \text{ dB} = 0.0659 \text{ W/kg} = -11.81 \text{ dBW/kg}$

05_WCDMA V_RMC 12.2Kbps_Right Cheek_0mm_Ch4182

Communication System: UID 0, WCDMA (0); Frequency: 836.4 MHz; Duty Cycle: 1:1
Medium: HSL_835 Medium parameters used: $f = 836.4$ MHz; $\sigma = 0.903$ S/m; $\epsilon_r = 41.219$; $\rho = 1000$ kg/m³
Ambient Temperature : 23.2 °C; Liquid Temperature : 22.8 °C

DASY5 Configuration:

- Probe: ES3DV3 - SN3293; ConvF(6.39, 6.39, 6.39); Calibrated: 2019.11.25
- Sensor-Surface: 3mm (Mechanical Surface Detection)
- Electronics: DAE4 Sn1338; Calibrated: 2019.11.20
- Phantom: SAM2; Type: SAM; Serial: TP-1503
- Measurement SW: DASY52, Version 52.10 (1); SEMCAD X Version 14.6.11 (7439)

Ch4182/Area Scan (81x81x1): Interpolated grid: dx=1.500 mm, dy=1.500 mm

Maximum value of SAR (interpolated) = 0.473 W/kg

Ch4182/Zoom Scan (5x5x7)/Cube 0: Measurement grid: dx=8mm, dy=8mm, dz=5mm

Reference Value = 5.719 V/m; Power Drift = 0.03 dB

Peak SAR (extrapolated) = 0.536 W/kg

SAR(1 g) = 0.420 W/kg; SAR(10 g) = 0.321 W/kg

Maximum value of SAR (measured) = 0.461 W/kg

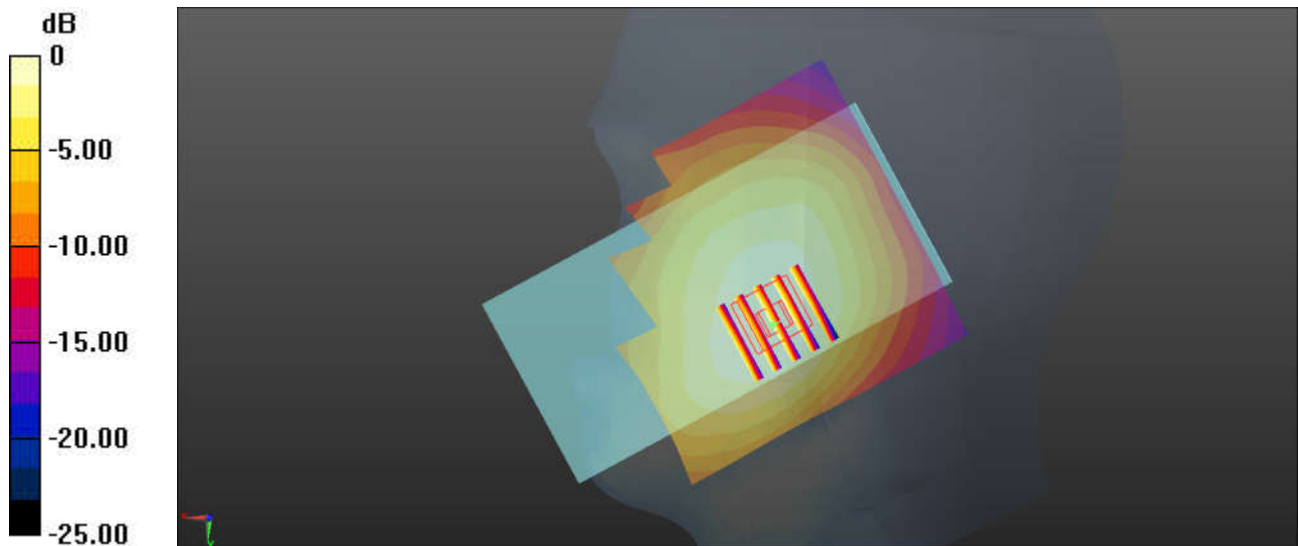

06_CDMA2000 BC10_RC3 SO55_Right Cheek_0mm_Ch684

Communication System: UID 0, CDMA (0); Frequency: 823.1 MHz; Duty Cycle: 1:1

Medium: HSL_835 Medium parameters used: $f = 823.1$ MHz; $\sigma = 0.897$ S/m; $\epsilon_r = 42.932$; $\rho = 1000$ kg/m³

Ambient Temperature : 23.2 °C; Liquid Temperature : 22.8 °C

DASY5 Configuration:

- Probe: ES3DV3 - SN3293; ConvF(6.39, 6.39, 6.39); Calibrated: 2019.11.25
- Sensor-Surface: 3mm (Mechanical Surface Detection)
- Electronics: DAE4 Sn1338; Calibrated: 2019.11.20
- Phantom: SAM2; Type: SAM; Serial: TP-1503
- Measurement SW: DASY52, Version 52.10 (1); SEMCAD X Version 14.6.11 (7439)

Ch684/Area Scan (71x71x1): Interpolated grid: dx=1.500 mm, dy=1.500 mm

Maximum value of SAR (interpolated) = 0.361 W/kg

Ch684/Zoom Scan (5x5x7)/Cube 0: Measurement grid: dx=8mm, dy=8mm, dz=5mm

Reference Value = 5.583 V/m; Power Drift = 0.02 dB

Peak SAR (extrapolated) = 0.426 W/kg

SAR(1 g) = 0.328 W/kg; SAR(10 g) = 0.248 W/kg

Maximum value of SAR (measured) = 0.361 W/kg

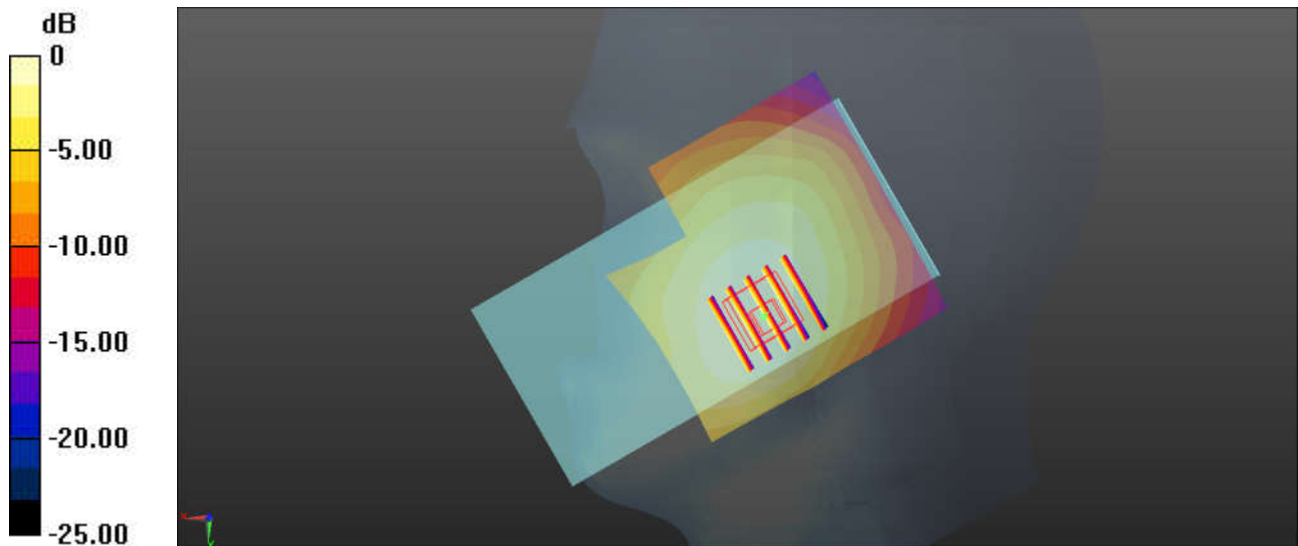

0 dB = 0.361 W/kg = -4.42 dBW/kg

07_CDMA2000 BC0_RC3 SO55_Right Cheek_0mm_Ch1013

Communication System: UID 0, CDMA (0); Frequency: 824.7 MHz; Duty Cycle: 1:1
 Medium: HSL_835 Medium parameters used: $f = 825 \text{ MHz}$; $\sigma = 0.889 \text{ S/m}$; $\epsilon_r = 42.914$; $\rho = 1000 \text{ kg/m}^3$
 Ambient Temperature : $23.2 \text{ }^\circ\text{C}$; Liquid Temperature : $22.8 \text{ }^\circ\text{C}$

DASY5 Configuration:

- Probe: ES3DV3 - SN3293; ConvF(6.39, 6.39, 6.39); Calibrated: 2019.11.25
- Sensor-Surface: 3mm (Mechanical Surface Detection)
- Electronics: DAE4 Sn1338; Calibrated: 2019.11.20
- Phantom: SAM2; Type: SAM; Serial: TP-1503
- Measurement SW: DASY52, Version 52.10 (1); SEMCAD X Version 14.6.11 (7439)

Ch1013/Area Scan (71x71x1): Interpolated grid: $dx=1.500 \text{ mm}$, $dy=1.500 \text{ mm}$

Maximum value of SAR (interpolated) = 0.482 W/kg

Ch1013/Zoom Scan (5x5x7)/Cube 0: Measurement grid: $dx=8\text{mm}$, $dy=8\text{mm}$, $dz=5\text{mm}$

Reference Value = 6.108 V/m ; Power Drift = -0.06 dB

Peak SAR (extrapolated) = 0.533 W/kg

SAR(1 g) = 0.415 W/kg ; SAR(10 g) = 0.316 W/kg

Maximum value of SAR (measured) = 0.459 W/kg

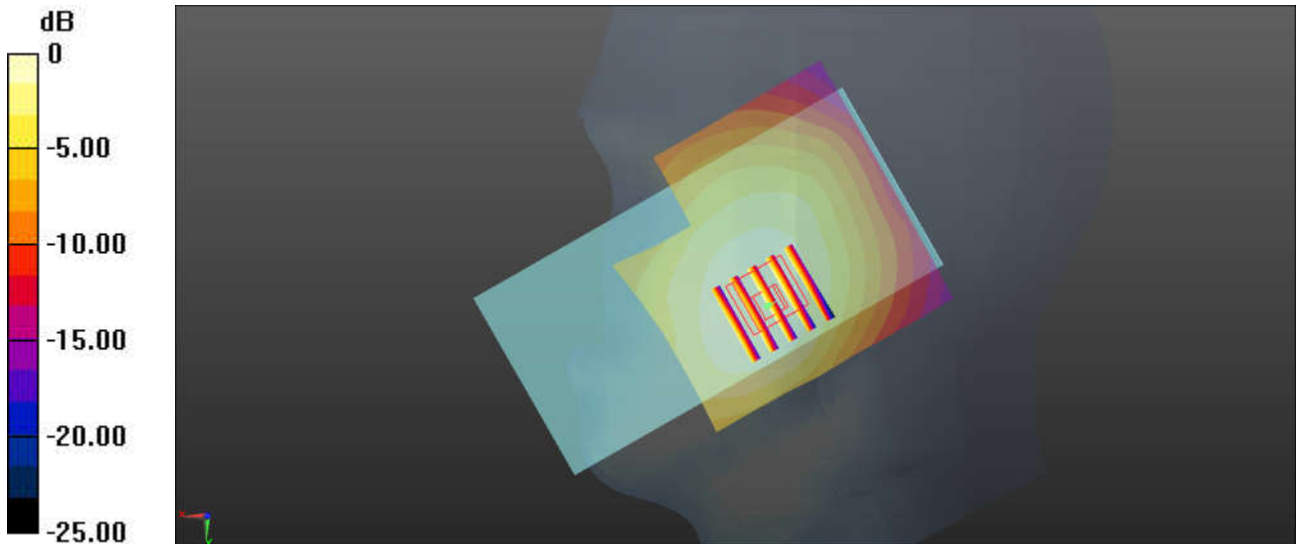

$0 \text{ dB} = 0.482 \text{ W/kg} = -3.17 \text{ dBW/kg}$

08_CDMA2000 BC1_RC3 SO55_Right Cheek_0mm_Ch25

Communication System: UID 0, CDMA (0); Frequency: 1851.25 MHz; Duty Cycle: 1:1
 Medium: HSL_1900 Medium parameters used: $f = 1851.25$ MHz; $\sigma = 1.352$ S/m; $\epsilon_r = 40.237$; $\rho = 1000$ kg/m³
 Ambient Temperature : 23.3 °C; Liquid Temperature : 22.8 °C

DASY5 Configuration:

- Probe: ES3DV3 - SN3293; ConvF(5.32, 5.32, 5.32); Calibrated: 2019.11.25
- Sensor-Surface: 3mm (Mechanical Surface Detection)
- Electronics: DAE4 Sn1338; Calibrated: 2019.11.20
- Phantom: SAM2; Type: SAM; Serial: TP-1503
- Measurement SW: DASY52, Version 52.10 (1); SEMCAD X Version 14.6.11 (7439)

Ch25/Area Scan (71x71x1): Interpolated grid: dx=1.500 mm, dy=1.500 mm

Maximum value of SAR (interpolated) = 0.123 W/kg

Ch25/Zoom Scan (5x5x7)/Cube 0: Measurement grid: dx=8mm, dy=8mm, dz=5mm

Reference Value = 4.356 V/m; Power Drift = -0.17 dB

Peak SAR (extrapolated) = 0.156 W/kg

SAR(1 g) = 0.099 W/kg; SAR(10 g) = 0.061 W/kg

Maximum value of SAR (measured) = 0.117 W/kg

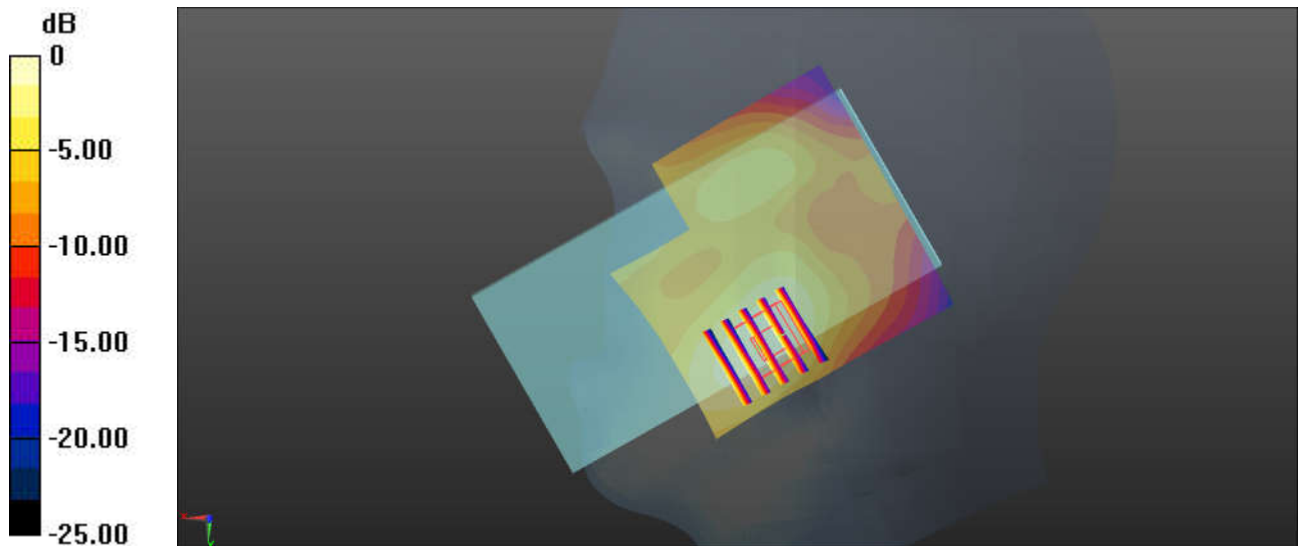

0 dB = 0.123 W/kg = -9.10 dBW/kg

09_LTE Band 7_20M_QPSK_1RB_99Offset_Right Cheek_0mm_Ch21350

Communication System: UID 0, LTE-FDD (0); Frequency: 2560 MHz; Duty Cycle: 1:1
Medium: HSL_2600 Medium parameters used: $f = 2560$ MHz; $\sigma = 1.983$ S/m; $\epsilon_r = 38.021$; $\rho = 1000$ kg/m³
Ambient Temperature : 23.3 °C; Liquid Temperature : 22.9 °C

DASY5 Configuration:

- Probe: ES3DV3 - SN3293; ConvF(4.39, 4.39, 4.39); Calibrated: 2019.11.25
- Sensor-Surface: 3mm (Mechanical Surface Detection)
- Electronics: DAE4 Sn1338; Calibrated: 2019.11.20
- Phantom: SAM2; Type: SAM; Serial: TP-1503
- Measurement SW: DASY52, Version 52.10 (1); SEMCAD X Version 14.6.11 (7439)

Ch21350/Area Scan (91x91x1): Interpolated grid: dx=1.200 mm, dy=1.200 mm

Maximum value of SAR (interpolated) = 0.616 W/kg

Ch21350/Zoom Scan (7x7x7)/Cube 0: Measurement grid: dx=5mm, dy=5mm, dz=5mm

Reference Value = 4.449 V/m; Power Drift = 0.01 dB

Peak SAR (extrapolated) = 0.877 W/kg

SAR(1 g) = 0.469 W/kg; SAR(10 g) = 0.254 W/kg

Maximum value of SAR (measured) = 0.582 W/kg

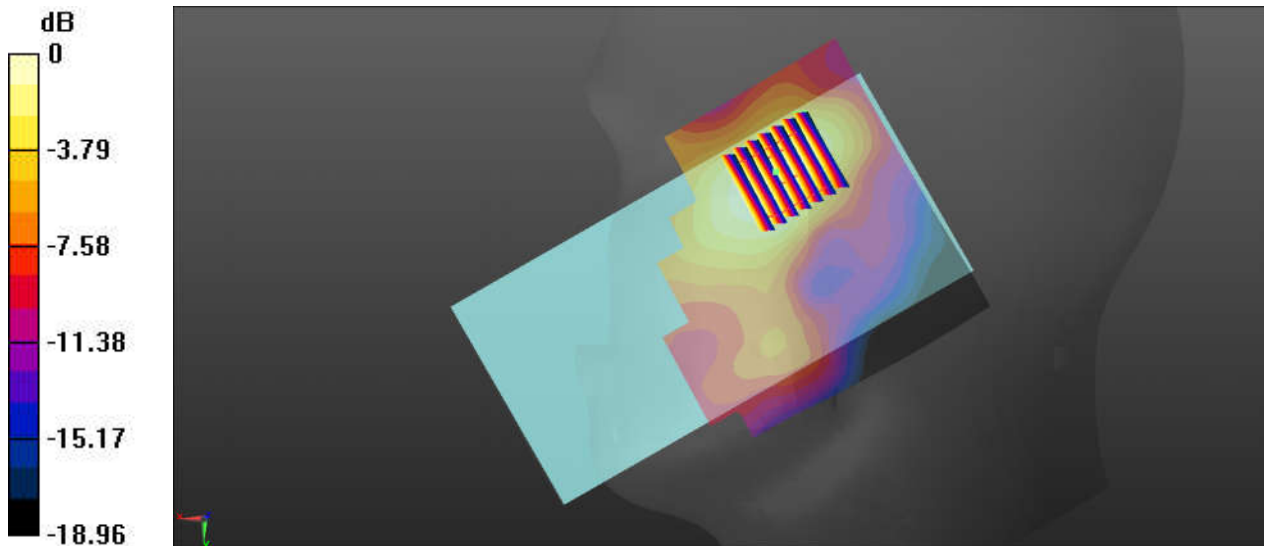

0 dB = 0.582 W/kg = -2.35 dBW/kg

10_LTE Band 12_10M_QPSK_1RB_49Offset_Left Cheek_0mm_Ch23095

Communication System: UID 0, LTE-FDD (0); Frequency: 707.5 MHz; Duty Cycle: 1:1
 Medium: HSL_750 Medium parameters used: $f = 707.5$ MHz; $\sigma = 0.852$ S/m; $\epsilon_r = 42.279$; $\rho = 1000$ kg/m³
 Ambient Temperature : 23.2 °C; Liquid Temperature : 22.9 °C

DASY5 Configuration:

- Probe: ES3DV3 - SN3293; ConvF(6.56, 6.56, 6.56); Calibrated: 2019.11.25
- Sensor-Surface: 3mm (Mechanical Surface Detection)
- Electronics: DAE4 Sn1338; Calibrated: 2019.11.20
- Phantom: SAM2; Type: SAM; Serial: TP-1503
- Measurement SW: DASY52, Version 52.10 (1); SEMCAD X Version 14.6.11 (7439)

Ch23095/Area Scan (81x81x1): Interpolated grid: dx=1.500 mm, dy=1.500 mm

Maximum value of SAR (interpolated) = 0.394 W/kg

Ch23095/Zoom Scan (5x5x7)/Cube 0: Measurement grid: dx=8mm, dy=8mm, dz=5mm

Reference Value = 6.279 V/m; Power Drift = 0.09 dB

Peak SAR (extrapolated) = 0.423 W/kg

SAR(1 g) = 0.346 W/kg; SAR(10 g) = 0.278 W/kg

Maximum value of SAR (measured) = 0.372 W/kg

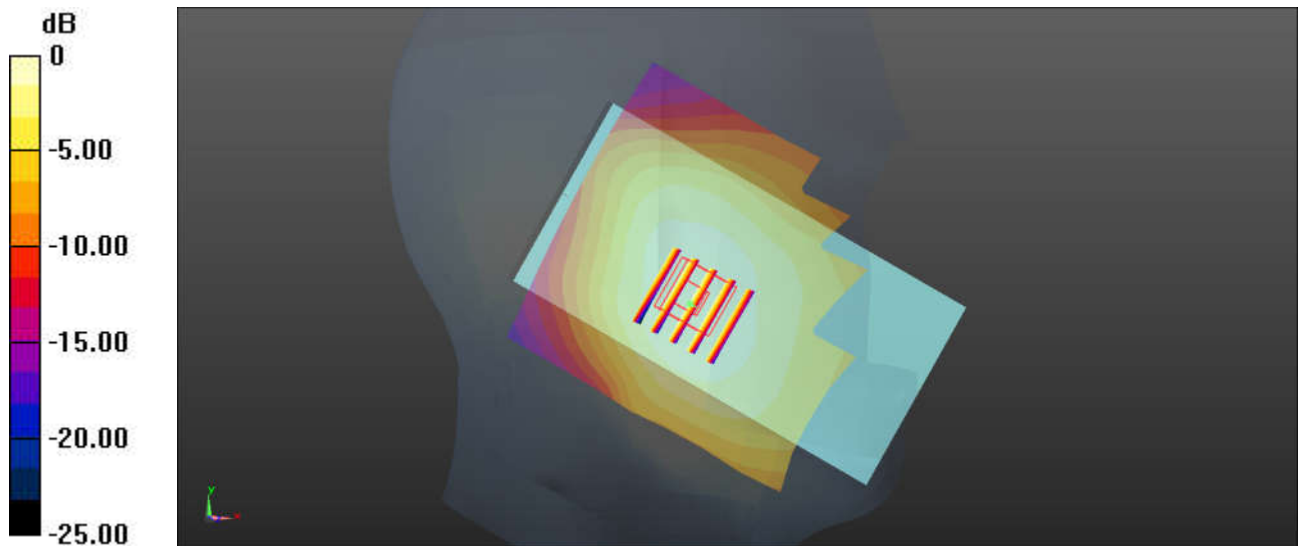

0 dB = 0.394 W/kg = -4.05 dBW/kg

11_LTE Band 13_10M_QPSK_1RB_0Offset_Right Cheek_0mm_Ch23230

Communication System: UID 0, LTE-FDD (0); Frequency: 782 MHz;Duty Cycle: 1:1
Medium: HSL_750 Medium parameters used: $f = 782 \text{ MHz}$; $\sigma = 0.923 \text{ S/m}$; $\epsilon_r = 41.305$; $\rho = 1000 \text{ kg/m}^3$
Ambient Temperature : $23.2 \text{ }^\circ\text{C}$; Liquid Temperature : $22.9 \text{ }^\circ\text{C}$

DASY5 Configuration:

- Probe: ES3DV3 - SN3293; ConvF(6.56, 6.56, 6.56); Calibrated: 2019.11.25
- Sensor-Surface: 3mm (Mechanical Surface Detection)
- Electronics: DAE4 Sn1338; Calibrated: 2019.11.20
- Phantom: SAM2; Type: SAM; Serial: TP-1503
- Measurement SW: DASY52, Version 52.10 (1); SEMCAD X Version 14.6.11 (7439)

Ch23230/Area Scan (81x81x1): Interpolated grid: $dx=1.500 \text{ mm}$, $dy=1.500 \text{ mm}$

Maximum value of SAR (interpolated) = 0.411 W/kg

Ch23230/Zoom Scan (6x5x7)/Cube 0: Measurement grid: $dx=8\text{mm}$, $dy=8\text{mm}$, $dz=5\text{mm}$

Reference Value = 5.143 V/m ; Power Drift = 0.05 dB

Peak SAR (extrapolated) = 0.459 W/kg

SAR(1 g) = 0.369 W/kg ; SAR(10 g) = 0.288 W/kg

Maximum value of SAR (measured) = 0.401 W/kg

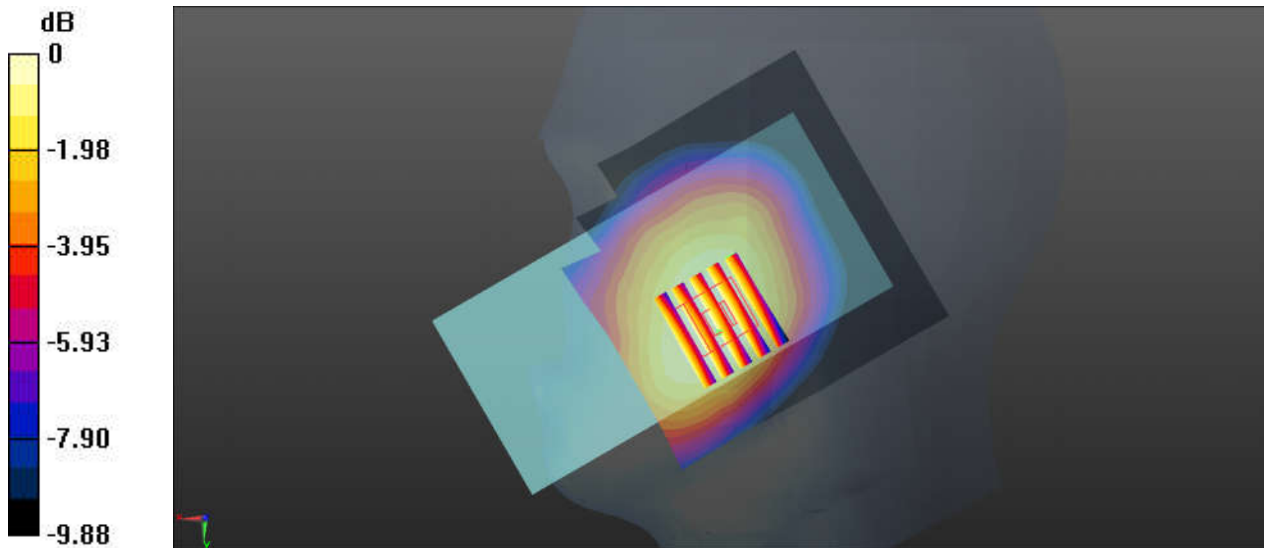

0 dB = 0.401 W/kg = -3.97 dBW/kg

12_LTE Band 25_20M_QPSK_1RB_49Offset_Right Cheek_0mm_Ch26140

Communication System: UID 0, LTE-FDD (0); Frequency: 1860 MHz; Duty Cycle: 1:1
 Medium: HSL_1900 Medium parameters used: $f = 1860$ MHz; $\sigma = 1.361$ S/m; $\epsilon_r = 40.209$; $\rho = 1000$ kg/m³
 Ambient Temperature : 23.3 °C; Liquid Temperature : 22.8 °C

DASY5 Configuration:

- Probe: ES3DV3 - SN3293; ConvF(5.32, 5.32, 5.32); Calibrated: 2019.11.25
- Sensor-Surface: 3mm (Mechanical Surface Detection)
- Electronics: DAE4 Sn1338; Calibrated: 2019.11.20
- Phantom: SAM2; Type: SAM; Serial: TP-1503
- Measurement SW: DASY52, Version 52.10 (1); SEMCAD X Version 14.6.11 (7439)

Ch26140/Area Scan (81x71x1): Interpolated grid: dx=1.500 mm, dy=1.500 mm

Maximum value of SAR (interpolated) = 0.0919 W/kg

Ch26140/Zoom Scan (5x5x7)/Cube 0: Measurement grid: dx=8mm, dy=8mm, dz=5mm

Reference Value = 3.085 V/m; Power Drift = -0.04 dB

Peak SAR (extrapolated) = 0.124 W/kg

SAR(1 g) = 0.081 W/kg; SAR(10 g) = 0.050 W/kg

Maximum value of SAR (measured) = 0.0942 W/kg

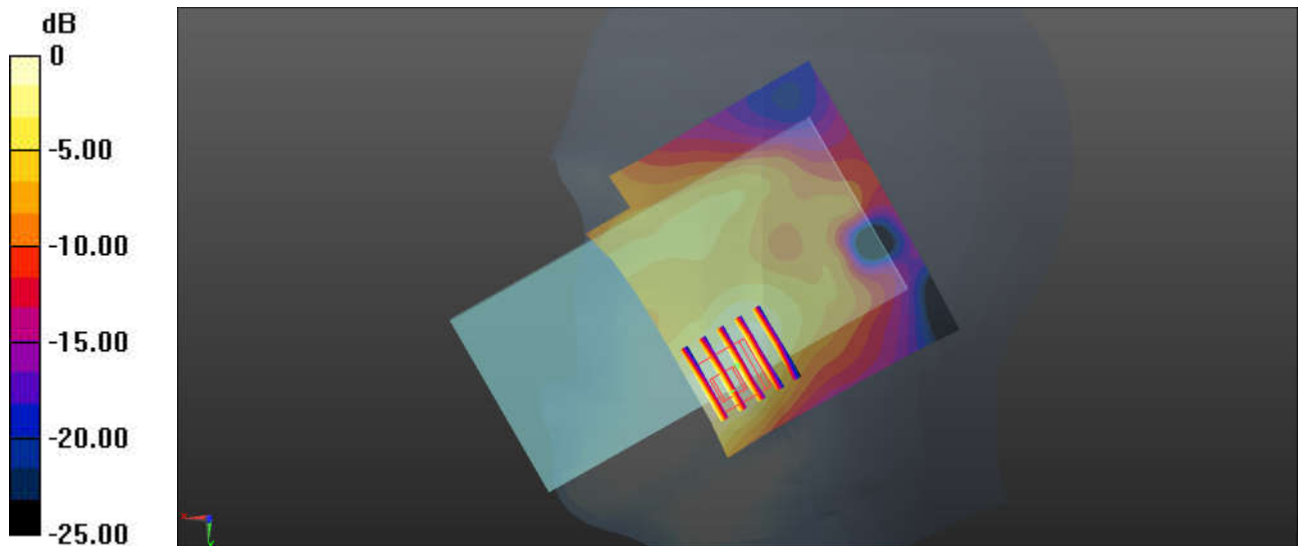

0 dB = 0.0919 W/kg = -10.37 dBW/kg

13_LTE Band 26_15M_QPSK_1RB_74Offset_Right Cheek_0mm_Ch26965

Communication System: UID 0, LTE-FDD (0); Frequency: 841.5 MHz; Duty Cycle: 1:1
 Medium: HSL_835 Medium parameters used: $f = 841.5$ MHz; $\sigma = 0.915$ S/m; $\epsilon_r = 42.725$; $\rho = 1000$ kg/m³
 Ambient Temperature : 23.2 °C; Liquid Temperature : 22.8 °C

DASY5 Configuration:

- Probe: ES3DV3 - SN3293; ConvF(6.56, 6.56, 6.56); Calibrated: 2019.11.25
- Sensor-Surface: 3mm (Mechanical Surface Detection)
- Electronics: DAE4 Sn1338; Calibrated: 2019.11.20
- Phantom: SAM2; Type: SAM; Serial: TP-1503
- Measurement SW: DASY52, Version 52.10 (1); SEMCAD X Version 14.6.11 (7439)

Ch26965/Area Scan (81x81x1): Interpolated grid: dx=1.500 mm, dy=1.500 mm
 Maximum value of SAR (interpolated) = 0.442 W/kg

Ch26965/Zoom Scan (5x5x7)/Cube 0: Measurement grid: dx=8mm, dy=8mm, dz=5mm
 Reference Value = 5.768 V/m; Power Drift = 0.03 dB
 Peak SAR (extrapolated) = 0.534 W/kg
SAR(1 g) = 0.420 W/kg; SAR(10 g) = 0.308 W/kg
 Maximum value of SAR (measured) = 0.454 W/kg

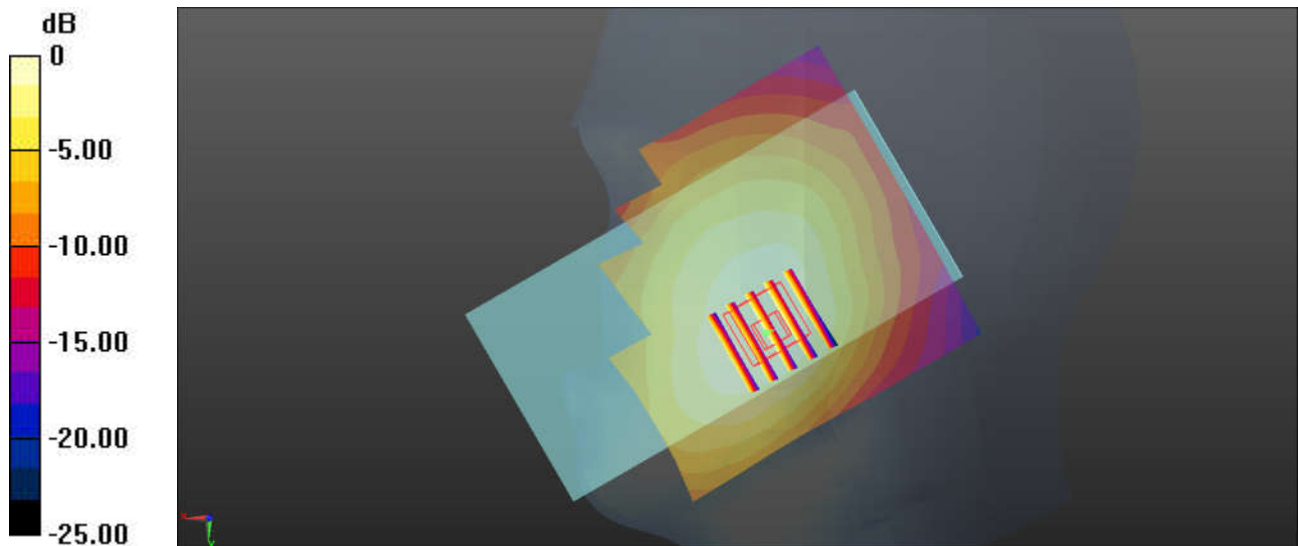

0 dB = 0.442 W/kg = -3.55 dBW/kg

14_LTE Band 66_20M_QPSK_1RB_99Offset_Right Cheek_0mm_Ch132572

Communication System: UID 0, LTE-FDD (0); Frequency: 1770 MHz; Duty Cycle: 1:1
 Medium: HSL_1750 Medium parameters used: $f = 1770$ MHz; $\sigma = 1.372$ S/m; $\epsilon_r = 40.419$; $\rho = 1000$ kg/m³
 Ambient Temperature : 23.3 °C; Liquid Temperature : 22.6 °C

DASY5 Configuration:

- Probe: ES3DV3 - SN3293; ConvF(5.53, 5.53, 5.53); Calibrated: 2019.11.25
- Sensor-Surface: 3mm (Mechanical Surface Detection)
- Electronics: DAE4 Sn1338; Calibrated: 2019.11.20
- Phantom: SAM2; Type: SAM; Serial: TP-1503
- Measurement SW: DASY52, Version 52.10 (1); SEMCAD X Version 14.6.11 (7439)

Ch132572/Area Scan (81x71x1): Interpolated grid: dx=1.500 mm, dy=1.500 mm
 Maximum value of SAR (interpolated) = 0.119 W/kg

Ch132572/Zoom Scan (6x6x7)/Cube 0: Measurement grid: dx=8mm, dy=8mm, dz=5mm
 Reference Value = 5.581 V/m; Power Drift = -0.01 dB
 Peak SAR (extrapolated) = 0.161 W/kg
SAR(1 g) = 0.105 W/kg; SAR(10 g) = 0.066 W/kg
 Maximum value of SAR (measured) = 0.123 W/kg

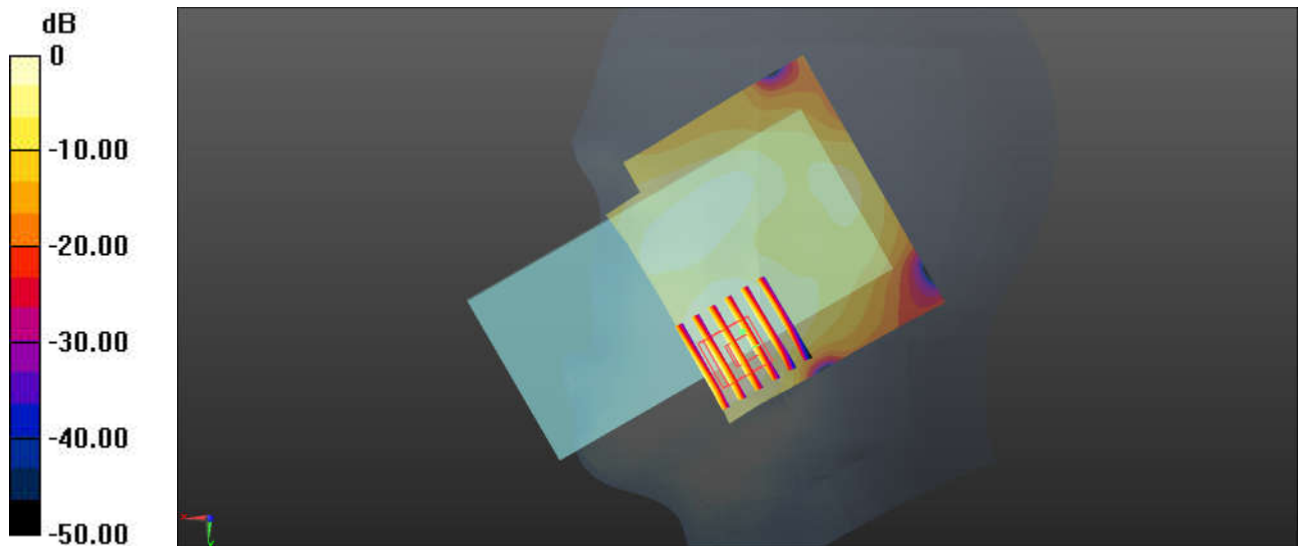

0 dB = 0.119 W/kg = -9.24 dBW/kg

15_LTE Band 71_20M_QPSK_1RB_49Offset_Right Cheek_0mm_Ch133322

Communication System: UID 0, LTE-FDD (0); Frequency: 683 MHz; Duty Cycle: 1:1
 Medium: HSL_750 Medium parameters used: $f = 683 \text{ MHz}$; $\sigma = 0.849 \text{ S/m}$; $\epsilon_r = 44.101$; $\rho = 1000 \text{ kg/m}^3$
 Ambient Temperature : 23.2 °C; Liquid Temperature : 22.9 °C

DASY5 Configuration:

- Probe: ES3DV3 - SN3293; ConvF(6.56, 6.56, 6.56); Calibrated: 2019.11.25
- Sensor-Surface: 3mm (Mechanical Surface Detection)
- Electronics: DAE4 Sn1338; Calibrated: 2019.11.20
- Phantom: SAM2; Type: SAM; Serial: TP-1503
- Measurement SW: DASY52, Version 52.10 (1); SEMCAD X Version 14.6.11 (7439)

Ch133322/Area Scan (81x81x1): Interpolated grid: $dx=1.500 \text{ mm}$, $dy=1.500 \text{ mm}$
 Maximum value of SAR (interpolated) = 0.262 W/kg

Ch133322/Zoom Scan (5x5x7)/Cube 0: Measurement grid: $dx=8\text{mm}$, $dy=8\text{mm}$, $dz=5\text{mm}$
 Reference Value = 4.346 V/m; Power Drift = 0.07 dB
 Peak SAR (extrapolated) = 0.294 W/kg
SAR(1 g) = 0.240 W/kg; SAR(10 g) = 0.195 W/kg
 Maximum value of SAR (measured) = 0.257 W/kg

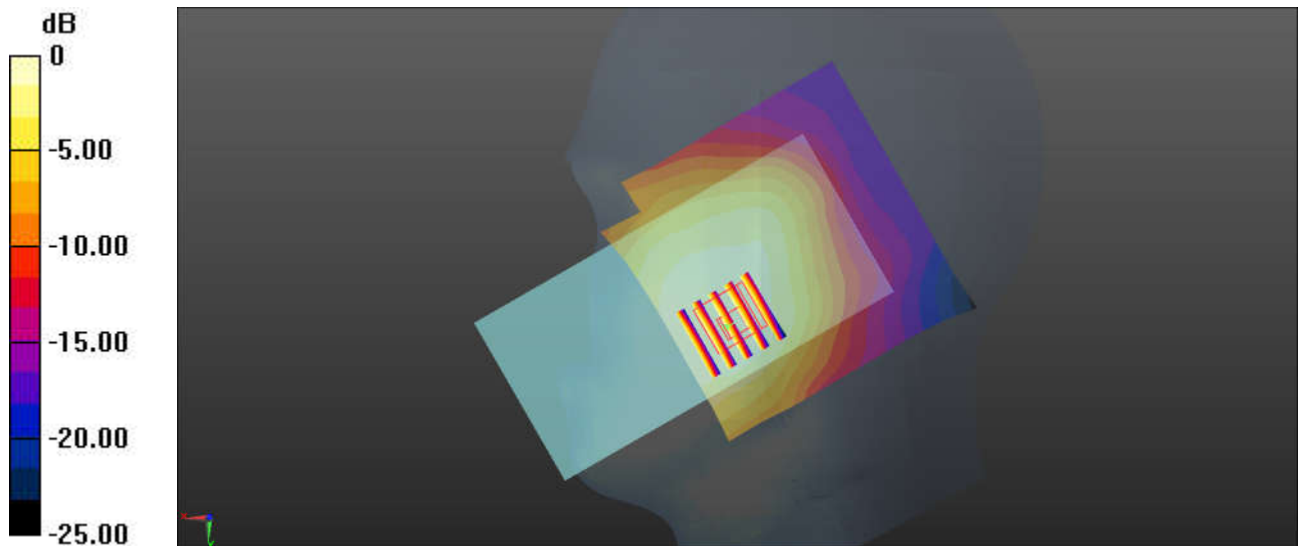

0 dB = 0.262 W/kg = -5.82 dBW/kg

16_LTE Band 41_20M_QPSK_1RB_49Offset_Left Cheek_0mm_Ch41055

Communication System: UID 0, LTE-TDD (0); Frequency: 2636.5 MHz; Duty Cycle: 1:1.59
Medium: HSL_2600 Medium parameters used: $f = 2637$ MHz; $\sigma = 2.07$ S/m; $\epsilon_r = 37.698$; $\rho = 1000$ kg/m³
Ambient Temperature : 23.3 °C; Liquid Temperature : 22.9 °C

DASY5 Configuration:

- Probe: ES3DV3 - SN3293; ConvF(4.39, 4.39, 4.39); Calibrated: 2019.11.25
- Sensor-Surface: 3mm (Mechanical Surface Detection)
- Electronics: DAE4 Sn1338; Calibrated: 2019.11.20
- Phantom: SAM2; Type: SAM; Serial: TP-1503
- Measurement SW: DASY52, Version 52.10 (1); SEMCAD X Version 14.6.11 (7439)

Ch41055/Area Scan (81x101x1): Interpolated grid: dx=1.200 mm, dy=1.200 mm

Maximum value of SAR (interpolated) = 0.464 W/kg

Ch41055/Zoom Scan (7x7x7)/Cube 0: Measurement grid: dx=5mm, dy=5mm, dz=5mm

Reference Value = 4.620 V/m; Power Drift = 0.06 dB

Peak SAR (extrapolated) = 0.783 W/kg

SAR(1 g) = 0.461 W/kg; SAR(10 g) = 0.230 W/kg

Maximum value of SAR (measured) = 0.518 W/kg

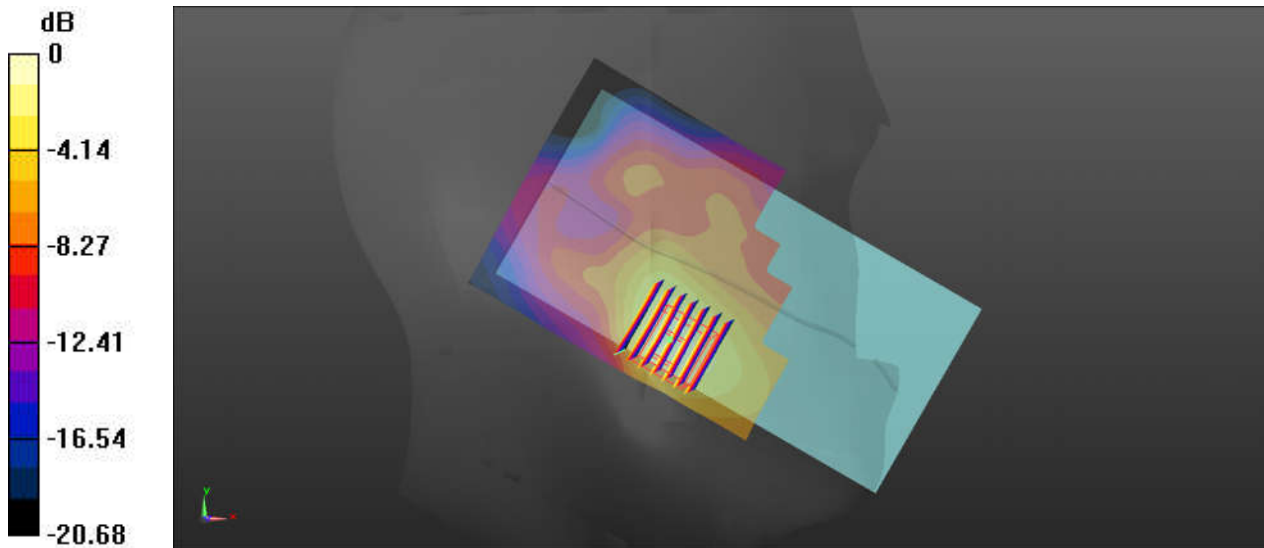

0 dB = 0.518 W/kg = -2.86 dBW/kg

17_LTE Band 41 HPUE_20M_QPSK_1RB_49Offset_Left Cheek_0mm_Ch41055

Communication System: UID 0, LTE-TDD (0); Frequency: 2636.5 MHz; Duty Cycle: 1:1.59
Medium: HSL_2600 Medium parameters used: $f = 2637$ MHz; $\sigma = 2.07$ S/m; $\epsilon_r = 37.698$; $\rho = 1000$ kg/m³
Ambient Temperature : 23.3 °C; Liquid Temperature : 22.9 °C

DASY5 Configuration:

- Probe: ES3DV3 - SN3293; ConvF(4.39, 4.39, 4.39); Calibrated: 2019.11.25
- Sensor-Surface: 3mm (Mechanical Surface Detection)
- Electronics: DAE4 Sn1338; Calibrated: 2019.11.20
- Phantom: SAM2; Type: SAM; Serial: TP-1503
- Measurement SW: DASY52, Version 52.10 (1); SEMCAD X Version 14.6.11 (7439)

Ch41055/Area Scan (91x81x1):

Interpolated grid: $dx=1.200$ mm, $dy=1.200$ mm
Maximum value of SAR (interpolated) = 0.867 W/kg

Ch41055/Zoom Scan (7x7x7)/Cube 0:

Measurement grid: $dx=5$ mm, $dy=5$ mm, $dz=5$ mm
Reference Value = 5.314 V/m; Power Drift = -0.08 dB

Peak SAR (extrapolated) = 0.781 W/kg

SAR(1 g) = 0.502 W/kg; SAR(10 g) = 0.216 W/kg

Maximum value of SAR (measured) = 0.534 W/kg

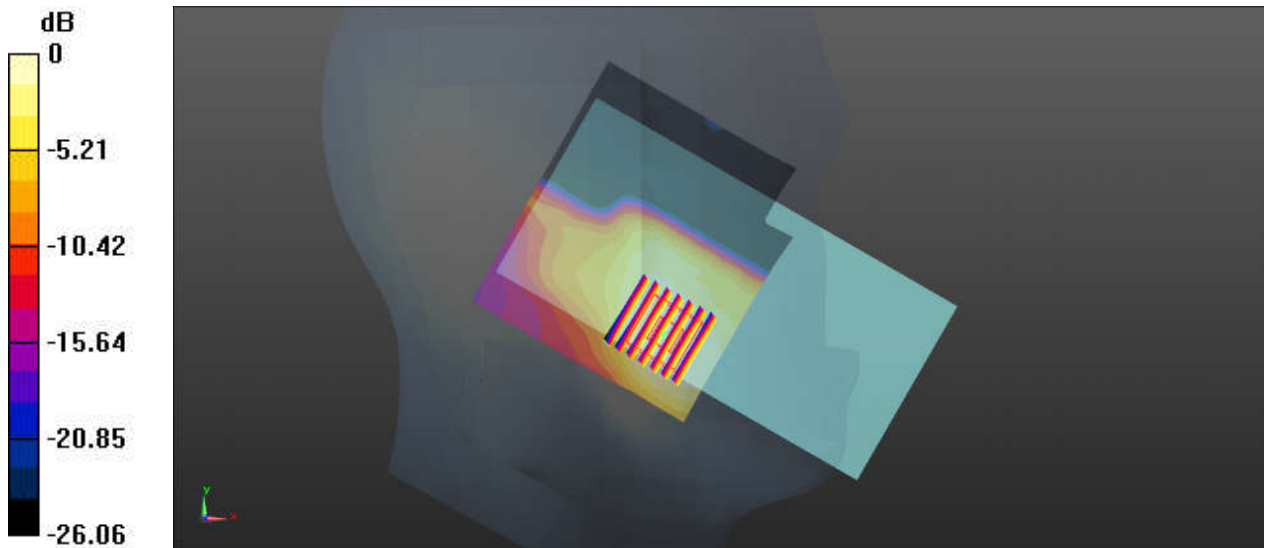

0 dB = 0.534 W/kg = -2.72 dBW/kg

18_WLAN 2.4GHz_802.11b 1Mbps_Left Cheek_0mm_Ch6

Communication System: UID 0, 802.11b (0); Frequency: 2437 MHz; Duty Cycle: 1:1.025
Medium: HSL_2450 Medium parameters used: $f = 2437$ MHz; $\sigma = 1.843$ S/m; $\epsilon_r = 38.589$; $\rho = 1000$ kg/m³

Ambient Temperature : 23.4 °C ; Liquid Temperature : 22.7 °C

DASY5 Configuration:

- Probe: ES3DV3 - SN3293; ConvF(4.6, 4.6, 4.6); Calibrated: 2019.11.25
- Sensor-Surface: 3mm (Mechanical Surface Detection)
- Electronics: DAE4 Sn1338; Calibrated: 2019.11.20
- Phantom: SAM2; Type: SAM; Serial: TP-1503
- Measurement SW: DASY52, Version 52.10 (1); SEMCAD X Version 14.6.11 (7439)

Ch6/Area Scan (91x81x1): Interpolated grid: dx=1.200 mm, dy=1.200 mm

Maximum value of SAR (interpolated) = 1.28 W/kg

Ch6/Zoom Scan (7x8x7)/Cube 0: Measurement grid: dx=5mm, dy=5mm, dz=5mm

Reference Value = 10.35 V/m; Power Drift = 0.05 dB

Peak SAR (extrapolated) = 1.52 W/kg

SAR(1 g) = 0.750 W/kg; SAR(10 g) = 0.376 W/kg

Maximum value of SAR (measured) = 0.930 W/kg

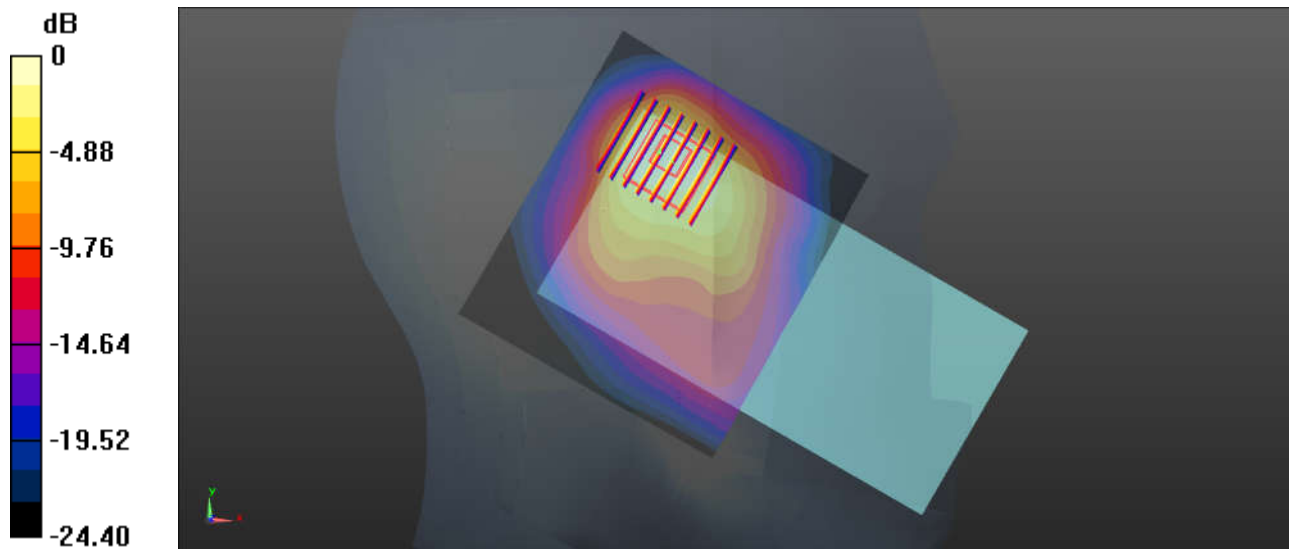

0 dB = 0.930 W/kg = -0.32 dBW/kg

19_Bluetooth_1Mbps_Left Cheek_0mm_Ch39

Communication System: UID 0, Bluetooth (0); Frequency: 2441 MHz; Duty Cycle: 1:1.299
 Medium: HSL_2450 Medium parameters used: $f = 2441$ MHz; $\sigma = 1.848$ S/m; $\epsilon_r = 38.573$; $\rho = 1000$ kg/m³
 Ambient Temperature : 23.4 °C; Liquid Temperature : 22.7 °C

DASY5 Configuration:

- Probe: ES3DV3 - SN3293; ConvF(4.6, 4.6, 4.6); Calibrated: 2019.11.25
- Sensor-Surface: 3mm (Mechanical Surface Detection)
- Electronics: DAE4 Sn1338; Calibrated: 2019.11.20
- Phantom: SAM2; Type: SAM; Serial: TP-1503
- Measurement SW: DASY52, Version 52.10 (1); SEMCAD X Version 14.6.11 (7439)

Ch39/Area Scan (101x91x1): Interpolated grid: dx=1.200 mm, dy=1.200 mm

Maximum value of SAR (interpolated) = 0.263 W/kg

Ch39/Zoom Scan (7x7x7)/Cube 0: Measurement grid: dx=5mm, dy=5mm, dz=5mm

Reference Value = 5.774 V/m; Power Drift = 0.06 dB

Peak SAR (extrapolated) = 0.367 W/kg

SAR(1 g) = 0.164 W/kg; SAR(10 g) = 0.082 W/kg

Maximum value of SAR (measured) = 0.205 W/kg

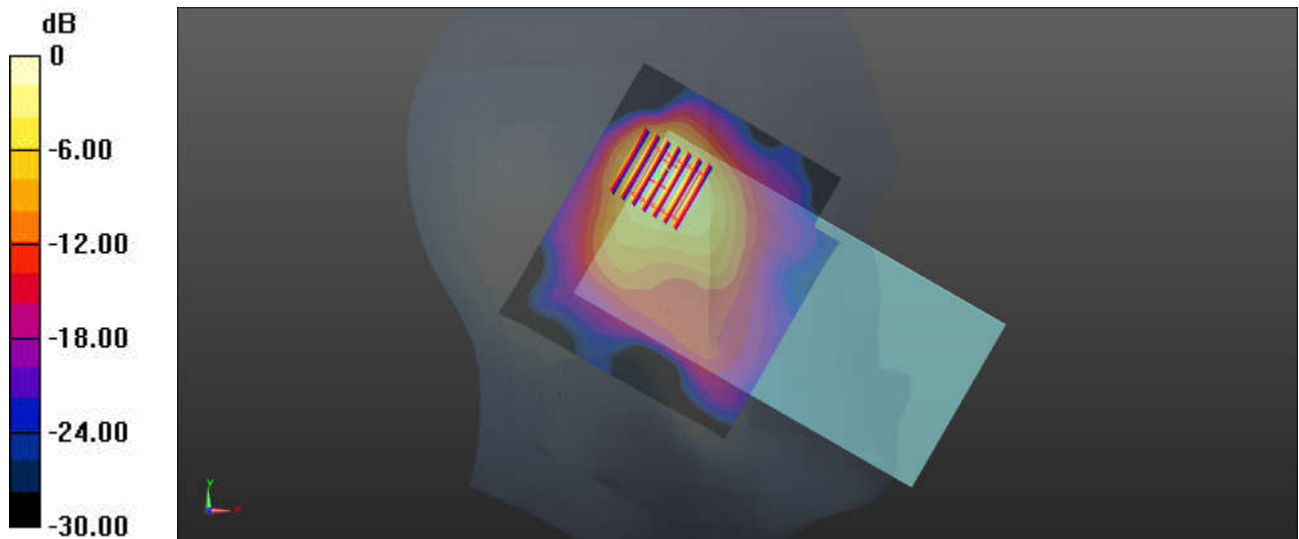

0 dB = 0.263 W/kg = -5.80 dBW/kg

20_WLAN 5GHz_802.11a 6Mbps_Right Tilted_0mm_Ch52

Communication System: UID 0, 802.11a (0); Frequency: 5260 MHz; Duty Cycle: 1:1.149
Medium: HSL_5000 Medium parameters used: $f = 5260$ MHz; $\sigma = 4.617$ S/m; $\epsilon_r = 36.368$; $\rho = 1000$ kg/m³
Ambient Temperature : 23.2 °C; Liquid Temperature : 22.7 °C

DASY5 Configuration:

- Probe: EX3DV4 - SN3857; ConvF(5.19, 5.19, 5.19); Calibrated: 2019.5.27
- Sensor-Surface: 1.4mm (Mechanical Surface Detection)
- Electronics: DAE4 Sn1338; Calibrated: 2019.11.20
- Phantom: SAM1; Type: SAM; Serial: TP-1839
- Measurement SW: DASY52, Version 52.10 (1); SEMCAD X Version 14.6.11 (7439)

Ch52/Area Scan (101x111x1): Interpolated grid: dx=1.000 mm, dy=1.000 mm

Maximum value of SAR (interpolated) = 0.254 W/kg

Ch52/Zoom Scan (8x8x7)/Cube 0: Measurement grid: dx=4mm, dy=4mm, dz=1.4mm

Reference Value = 2.736 V/m; Power Drift = 0.09 dB

Peak SAR (extrapolated) = 0.366 W/kg

SAR(1 g) = 0.112 W/kg; SAR(10 g) = 0.044 W/kg

Maximum value of SAR (measured) = 0.238 W/kg

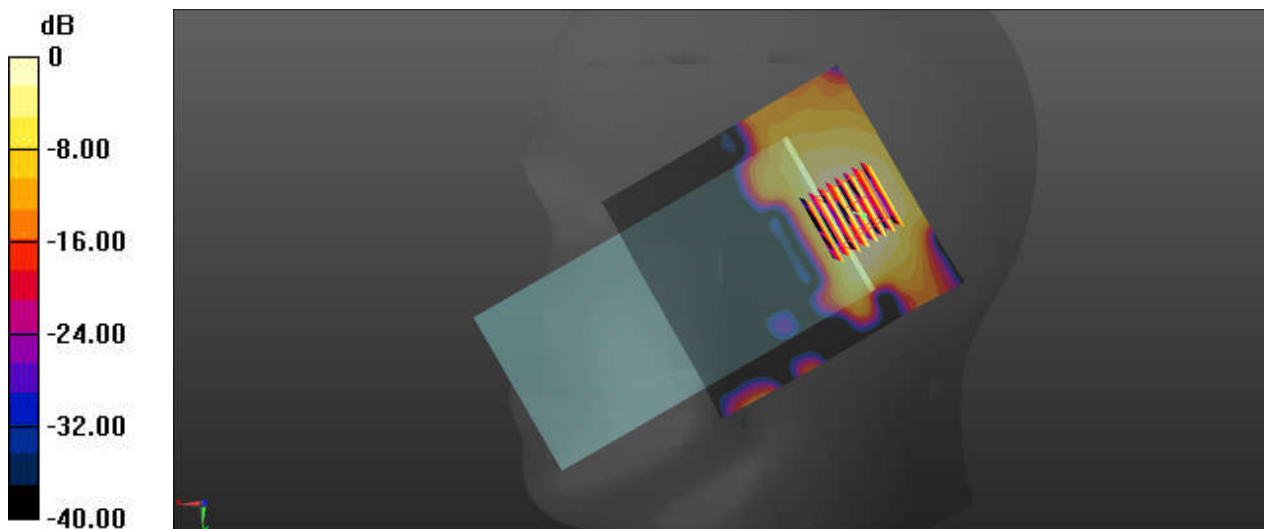

0 dB = 0.254 W/kg = -5.95 dBW/kg

21_WLAN 5GHz_802.11a 6Mbps_Right Tilted_0mm_Ch140

Communication System: UID 0, 802.11a (0); Frequency: 5700 MHz; Duty Cycle: 1:1.149
Medium: HSL_5000 Medium parameters used: $f = 5700$ MHz; $\sigma = 5.106$ S/m; $\epsilon_r = 35.64$; $\rho = 1000$ kg/m³
Ambient Temperature : 23.2 °C; Liquid Temperature : 22.6 °C

DASY5 Configuration:

- Probe: EX3DV4-SN3857; ConvF(4.92, 4.92, 4.92); Calibrated: 2019.5.27
- Sensor-Surface: 1.4mm (Mechanical Surface Detection)
- Electronics: DAE4 Sn1338; Calibrated: 2019.11.20
- Phantom: SAM1; Type: SAM; Serial: TP-1839
- Measurement SW: DASY52, Version 52.10 (1); SEMCAD X Version 14.6.11 (7439)

Ch140/Area Scan (101x111x1): Interpolated grid: dx=1.000 mm, dy=1.000 mm

Maximum value of SAR (interpolated) = 0.226 W/kg

Ch140/Zoom Scan (9x8x7)/Cube 0: Measurement grid: dx=4mm, dy=4mm, dz=1.4mm

Reference Value = 2.705 V/m; Power Drift = 0.09 dB

Peak SAR (extrapolated) = 0.315 W/kg

SAR(1 g) = 0.087 W/kg; SAR(10 g) = 0.033 W/kg

Maximum value of SAR (measured) = 0.199 W/kg

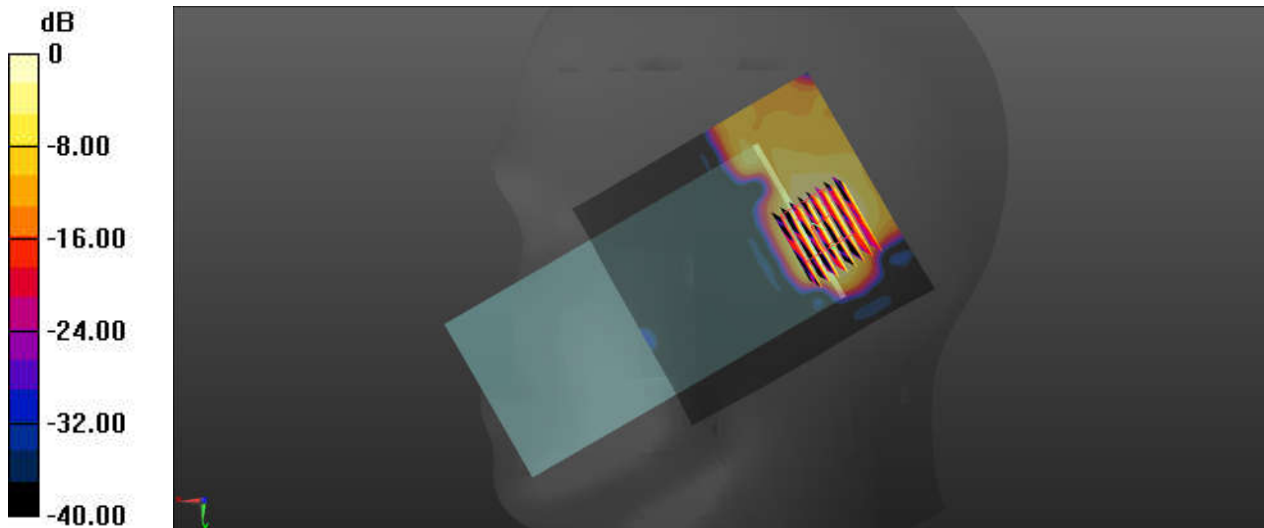

0 dB = 0.226 W/kg = -6.46 dBW/kg

22_WLAN 5GHz_802.11a 6Mbps_Right Tilted_0mm_Ch165

Communication System: UID 0, 802.11a (0); Frequency: 5825 MHz; Duty Cycle: 1:1.149
Medium: HSL_5000 Medium parameters used: $f = 5825$ MHz; $\sigma = 5.25$ S/m; $\epsilon_r = 35.439$; $\rho = 1000$ kg/m³
Ambient Temperature : 23.2 °C; Liquid Temperature : 22.7 °C

DASY5 Configuration:

- Probe: EX3DV4-SN3857; ConvF(5.17, 5.17, 5.17); Calibrated: 2019.5.27
- Sensor-Surface: 1.4mm (Mechanical Surface Detection)
- Electronics: DAE4 Sn1338; Calibrated: 2019.11.20
- Phantom: SAM1; Type: SAM; Serial: TP-1839
- Measurement SW: DASY52, Version 52.10 (1); SEMCAD X Version 14.6.11 (7439)

Ch165/Area Scan (101x111x1): Interpolated grid: dx=1.000 mm, dy=1.000 mm

Maximum value of SAR (interpolated) = 0.322 W/kg

Ch165/Zoom Scan (9x9x7)/Cube 0: Measurement grid: dx=4mm, dy=4mm, dz=1.4mm

Reference Value = 2.968 V/m; Power Drift = 0.03 dB

Peak SAR (extrapolated) = 0.461 W/kg

SAR(1 g) = 0.123 W/kg; SAR(10 g) = 0.048 W/kg

Maximum value of SAR (measured) = 0.290 W/kg

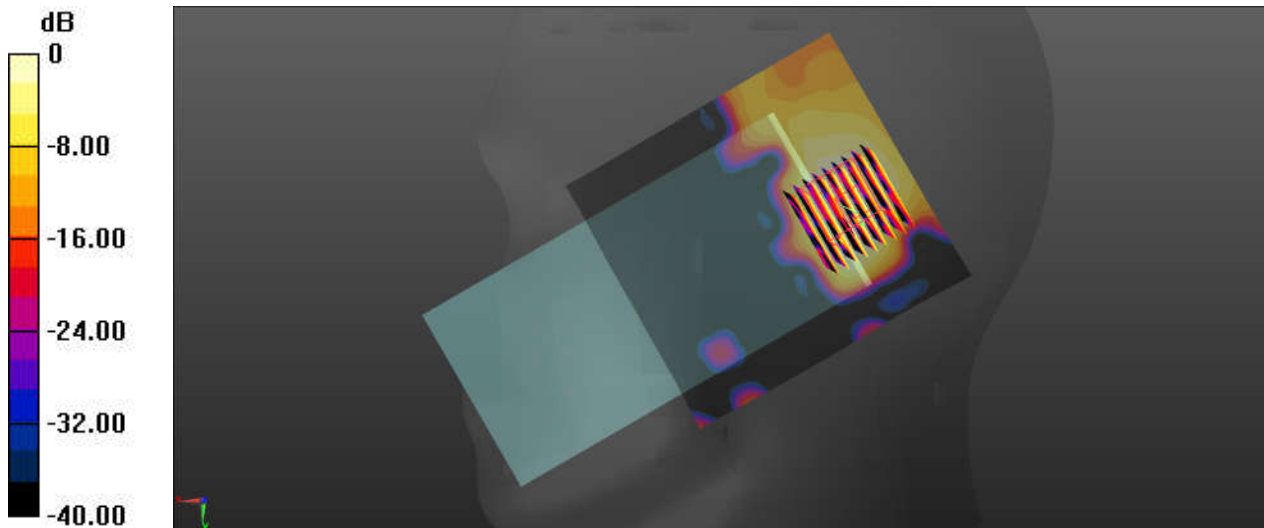

0 dB = 0.322 W/kg = -4.92 dBW/kg

23_GSM850_GPRS 2 Tx slots_Front_5mm_Ch189

Communication System: UID 0, GSM850-2UP (0); Frequency: 836.4 MHz; Duty Cycle: 1:4.15
 Medium: HSL_835 Medium parameters used: $f = 836.4$ MHz; $\sigma = 0.903$ S/m; $\epsilon_r = 41.219$; $\rho = 1000$ kg/m³
 Ambient Temperature : 23.2 °C; Liquid Temperature : 22.8 °C

DASY5 Configuration:

- Probe: ES3DV3 - SN3293; ConvF(6.39, 6.39, 6.39); Calibrated: 2019.11.25
- Sensor-Surface: 3mm (Mechanical Surface Detection)
- Electronics: DAE4 Sn1338; Calibrated: 2019.11.20
- Phantom: SAM2; Type: SAM; Serial: TP-1503
- Measurement SW: DASY52, Version 52.10 (1); SEMCAD X Version 14.6.11 (7439)

Ch189/Area Scan (81x71x1): Interpolated grid: dx=1.500 mm, dy=1.500 mm

Maximum value of SAR (interpolated) = 1.20 W/kg

Ch189/Zoom Scan (6x6x7)/Cube 0: Measurement grid: dx=8mm, dy=8mm, dz=5mm

Reference Value = 17.90 V/m; Power Drift = 0.04 dB

Peak SAR (extrapolated) = 2.15 W/kg

SAR(1 g) = 1.06 W/kg; SAR(10 g) = 0.569 W/kg

Maximum value of SAR (measured) = 1.24 W/kg

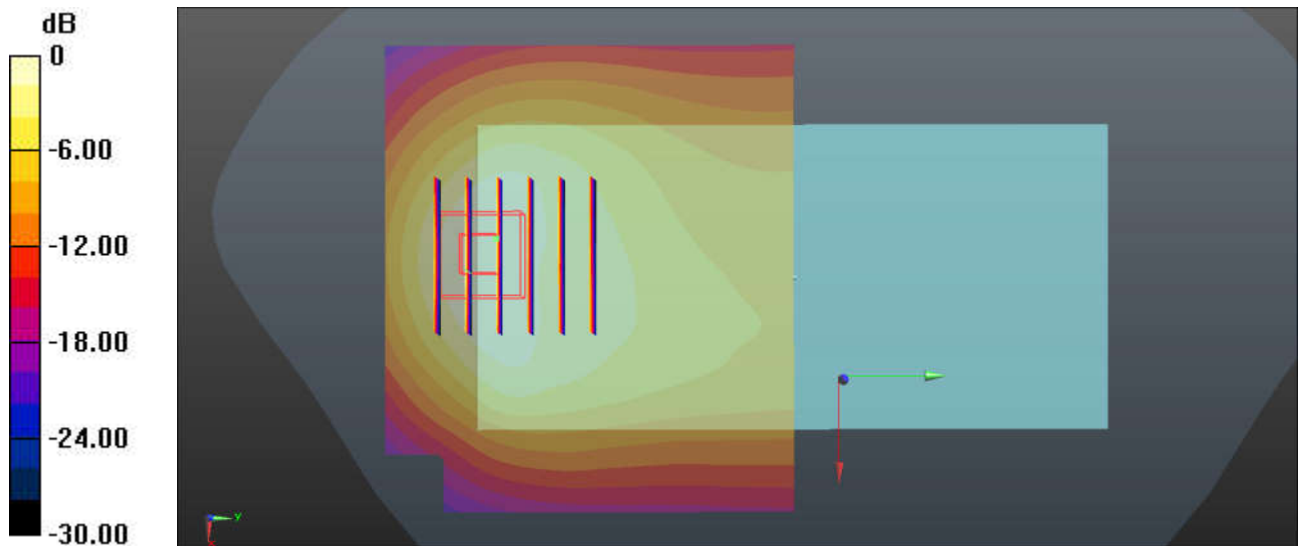

0 dB = 1.20 W/kg = 0.79 dBW/kg

24_GSM1900_GPRS 2 Tx slots_Back_5mm_Ch661

Communication System: UID 0, PCS-2UP (0); Frequency: 1880 MHz; Duty Cycle: 1:4.15
 Medium: HSL_1900 Medium parameters used: $f = 1880$ MHz; $\sigma = 1.376$ S/m; $\epsilon_r = 39.136$; $\rho = 1000$ kg/m³
 Ambient Temperature : 23.3 °C; Liquid Temperature : 22.8 °C

DASY5 Configuration:

- Probe: ES3DV3 - SN3293; ConvF(5.32, 5.32, 5.32); Calibrated: 2019.11.25
- Sensor-Surface: 3mm (Mechanical Surface Detection)
- Electronics: DAE4 Sn1338; Calibrated: 2019.11.20
- Phantom: SAM2; Type: SAM; Serial: TP-1503
- Measurement SW: DASY52, Version 52.10 (1); SEMCAD X Version 14.6.11 (7439)

Ch661/Area Scan (81x71x1): Interpolated grid: dx=1.500 mm, dy=1.500 mm

Maximum value of SAR (interpolated) = 1.39 W/kg

Ch661/Zoom Scan (6x6x7)/Cube 0: Measurement grid: dx=8mm, dy=8mm, dz=5mm

Reference Value = 2.300 V/m; Power Drift = 0.03 dB

Peak SAR (extrapolated) = 1.99 W/kg

SAR(1 g) = 1.02 W/kg; SAR(10 g) = 0.490 W/kg

Maximum value of SAR (measured) = 1.26 W/kg

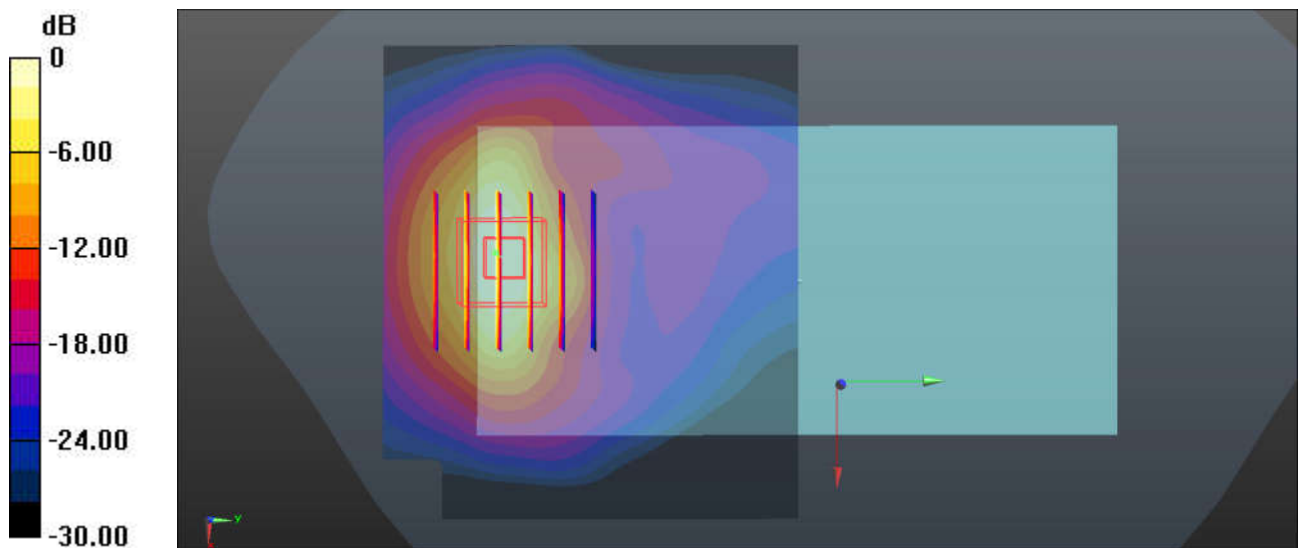

0 dB = 1.39 W/kg = 1.43 dBW/kg

25_WCDMA II_RMC 12.2Kbps_Back_5mm_Ch9400

Communication System: UID 0, WCDMA (0); Frequency: 1880 MHz; Duty Cycle: 1:1
 Medium: HSL_1900 Medium parameters used: $f = 1880$ MHz; $\sigma = 1.376$ S/m; $\epsilon_r = 39.136$; $\rho = 1000$ kg/m³
 Ambient Temperature : 23.3 °C; Liquid Temperature : 22.8 °C

DASY5 Configuration:

- Probe: ES3DV3 - SN3293; ConvF(5.32, 5.32, 5.32); Calibrated: 2019.11.25
- Sensor-Surface: 3mm (Mechanical Surface Detection)
- Electronics: DAE4 Sn1338; Calibrated: 2019.11.20
- Phantom: SAM2; Type: SAM; Serial: TP-1503
- Measurement SW: DASY52, Version 52.10 (1); SEMCAD X Version 14.6.11 (7439)

Ch9400/Area Scan (81x71x1): Interpolated grid: dx=1.500 mm, dy=1.500 mm

Maximum value of SAR (interpolated) = 1.46 W/kg

Ch9400/Zoom Scan (5x5x7)/Cube 0: Measurement grid: dx=8mm, dy=8mm, dz=5mm

Reference Value = 1.311 V/m; Power Drift = 0.04 dB

Peak SAR (extrapolated) = 1.93 W/kg

SAR(1 g) = 1.06 W/kg; SAR(10 g) = 0.532 W/kg

Maximum value of SAR (measured) = 1.32 W/kg

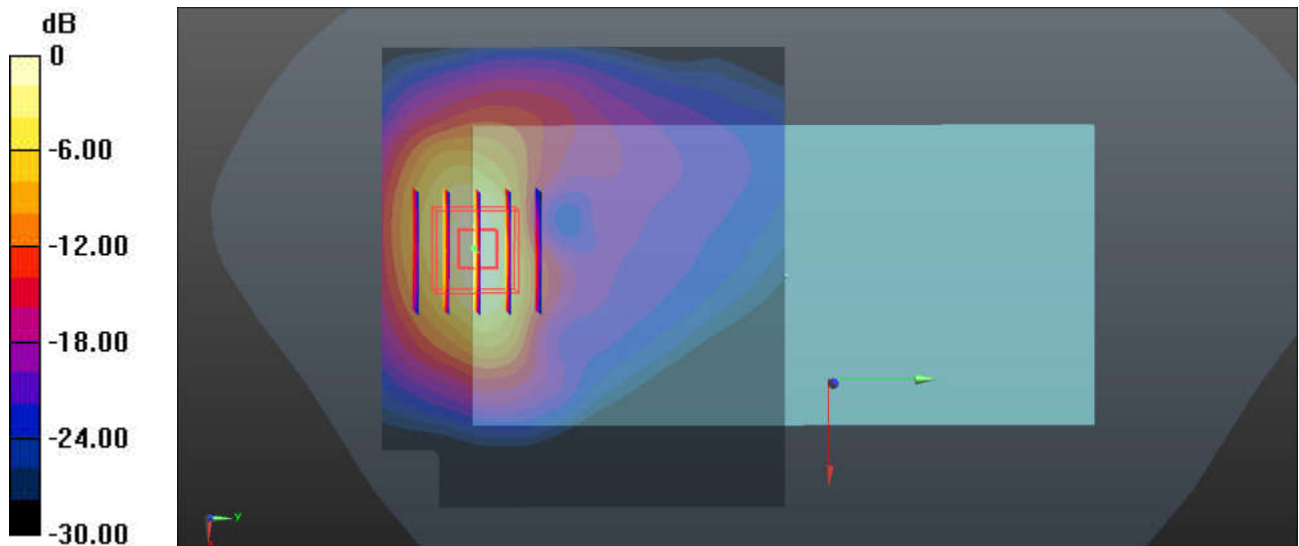

0 dB = 1.46 W/kg = 1.64 dBW/kg

26_WCDMA IV_RMC 12.2Kbps_Bottom Side_5mm_Ch1513

Communication System: UID 0, WCDMA (0); Frequency: 1752.6 MHz; Duty Cycle: 1:1
 Medium: HSL_1750 Medium parameters used: $f = 1753 \text{ MHz}$; $\sigma = 1.36 \text{ S/m}$; $\epsilon_r = 39.047$; $\rho = 1000 \text{ kg/m}^3$
 Ambient Temperature : $23.3 \text{ }^\circ\text{C}$; Liquid Temperature : $22.6 \text{ }^\circ\text{C}$

DASY5 Configuration:

- Probe: ES3DV3 - SN3293; ConvF(5.53, 5.53, 5.53); Calibrated: 2019.11.25
- Sensor-Surface: 3mm (Mechanical Surface Detection)
- Electronics: DAE4 Sn1338; Calibrated: 2019.11.20
- Phantom: SAM2; Type: SAM; Serial: TP-1503
- Measurement SW: DASY52, Version 52.10 (1); SEMCAD X Version 14.6.11 (7439)

Ch1513/Area Scan (41x81x1): Interpolated grid: $dx=1.500 \text{ mm}$, $dy=1.500 \text{ mm}$

Maximum value of SAR (interpolated) = 1.42 W/kg

Ch1513/Zoom Scan (5x5x7)/Cube 0: Measurement grid: $dx=8\text{mm}$, $dy=8\text{mm}$, $dz=5\text{mm}$

Reference Value = 30.56 V/m ; Power Drift = 0.08 dB

Peak SAR (extrapolated) = 1.98 W/kg

SAR(1 g) = 0.988 W/kg ; SAR(10 g) = 0.469 W/kg

Maximum value of SAR (measured) = 1.28 W/kg

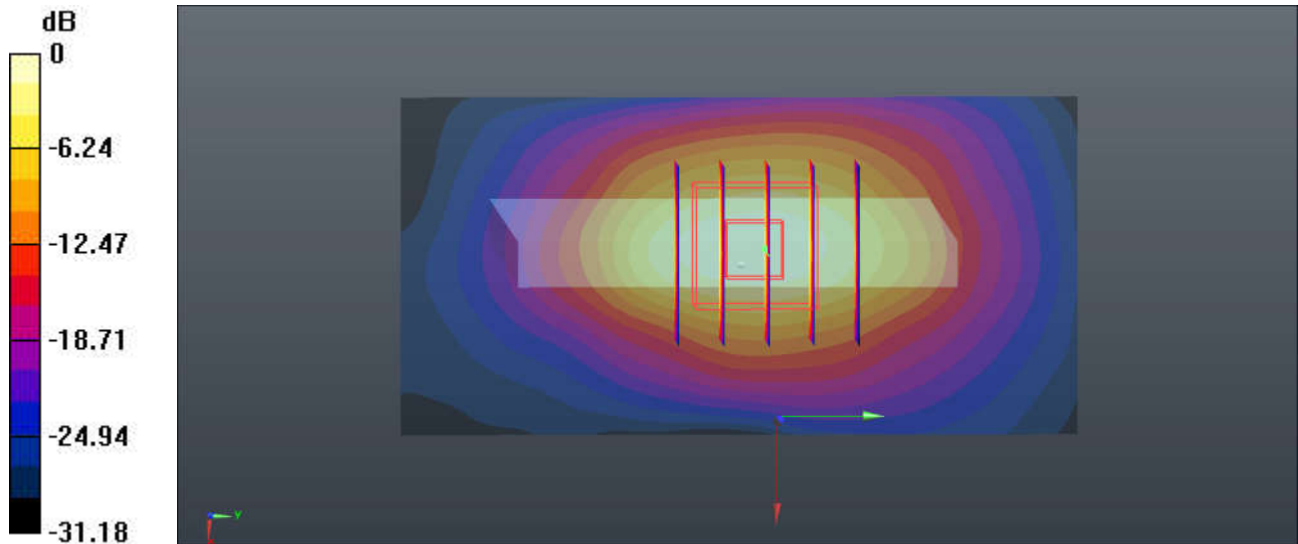

$0 \text{ dB} = 1.42 \text{ W/kg} = 1.52 \text{ dBW/kg}$

27_WCDMA V_RMC 12.2Kbps_Bottom Side_5mm_Ch4132

Communication System: UID 0, WCDMA (0); Frequency: 826.4 MHz; Duty Cycle: 1:1
Medium: HSL_835 Medium parameters used: $f = 826.4$ MHz; $\sigma = 0.893$ S/m; $\epsilon_r = 41.342$; $\rho = 1000$ kg/m³
Ambient Temperature : 23.2 °C; Liquid Temperature : 22.8 °C

DASY5 Configuration:

- Probe: ES3DV3 - SN3293; ConvF(6.39, 6.39, 6.39); Calibrated: 2019.11.25
- Sensor-Surface: 3mm (Mechanical Surface Detection)
- Electronics: DAE4 Sn1338; Calibrated: 2019.11.20
- Phantom: SAM2; Type: SAM; Serial: TP-1503
- Measurement SW: DASY52, Version 52.10 (1); SEMCAD X Version 14.6.11 (7439)

Ch4132/Area Scan (41x71x1): Interpolated grid: dx=1.500 mm, dy=1.500 mm

Maximum value of SAR (interpolated) = 0.982 W/kg

Ch4132/Zoom Scan (5x5x7)/Cube 0: Measurement grid: dx=8mm, dy=8mm, dz=5mm

Reference Value = 28.47 V/m; Power Drift = 0.08 dB

Peak SAR (extrapolated) = 2.77 W/kg

SAR(1 g) = 0.969 W/kg; SAR(10 g) = 0.412 W/kg

Maximum value of SAR (measured) = 1.30 W/kg

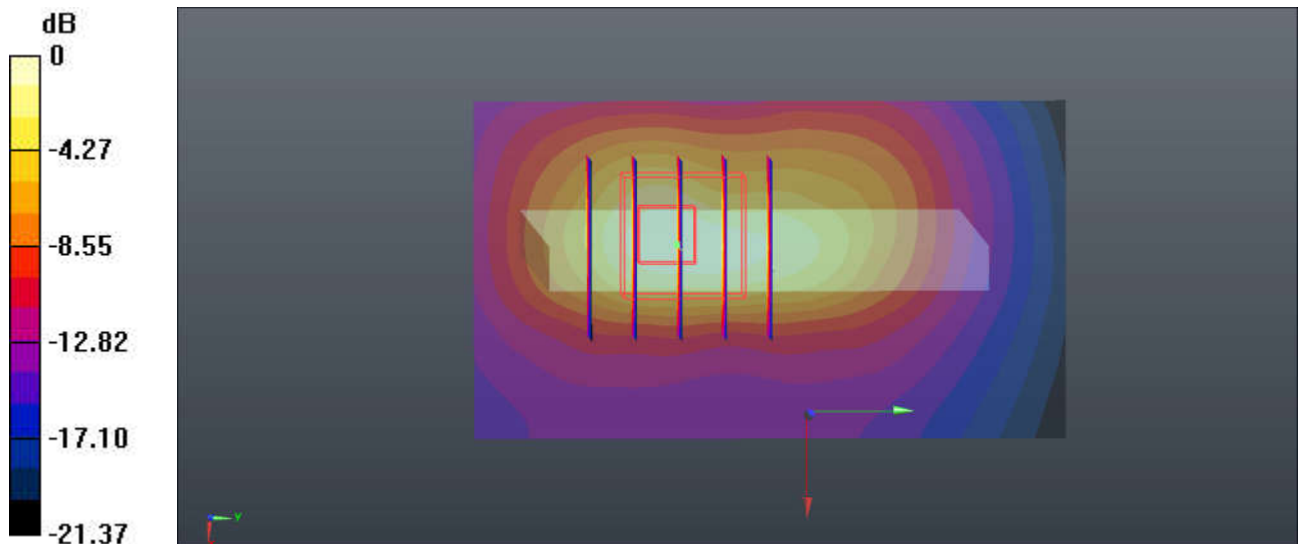

28_CDMA2000 BC10_RTAP 153.6Kbps_Front_5mm_Ch476

Communication System: UID 0, CDMA (0); Frequency: 817.9 MHz; Duty Cycle: 1:1
 Medium: HSL_835 Medium parameters used: $f = 818 \text{ MHz}$; $\sigma = 0.892 \text{ S/m}$; $\epsilon_r = 42.993$; $\rho = 1000 \text{ kg/m}^3$
 Ambient Temperature : $23.2 \text{ }^\circ\text{C}$; Liquid Temperature : $22.8 \text{ }^\circ\text{C}$

DASY5 Configuration:

- Probe: ES3DV3 - SN3293; ConvF(6.39, 6.39, 6.39); Calibrated: 2019.11.25
- Sensor-Surface: 3mm (Mechanical Surface Detection)
- Electronics: DAE4 Sn1338; Calibrated: 2019.11.20
- Phantom: SAM2; Type: SAM; Serial: TP-1503
- Measurement SW: DASY52, Version 52.10 (1); SEMCAD X Version 14.6.11 (7439)

Ch476/Area Scan (71x71x1): Interpolated grid: $dx=1.500 \text{ mm}$, $dy=1.500 \text{ mm}$

Maximum value of SAR (interpolated) = 0.930 W/kg

Ch476/Zoom Scan (6x6x7)/Cube 0: Measurement grid: $dx=8\text{mm}$, $dy=8\text{mm}$, $dz=5\text{mm}$

Reference Value = 15.46 V/m ; Power Drift = 0.09 dB

Peak SAR (extrapolated) = 1.82 W/kg

SAR(1 g) = 0.872 W/kg ; SAR(10 g) = 0.463 W/kg

Maximum value of SAR (measured) = 1.06 W/kg

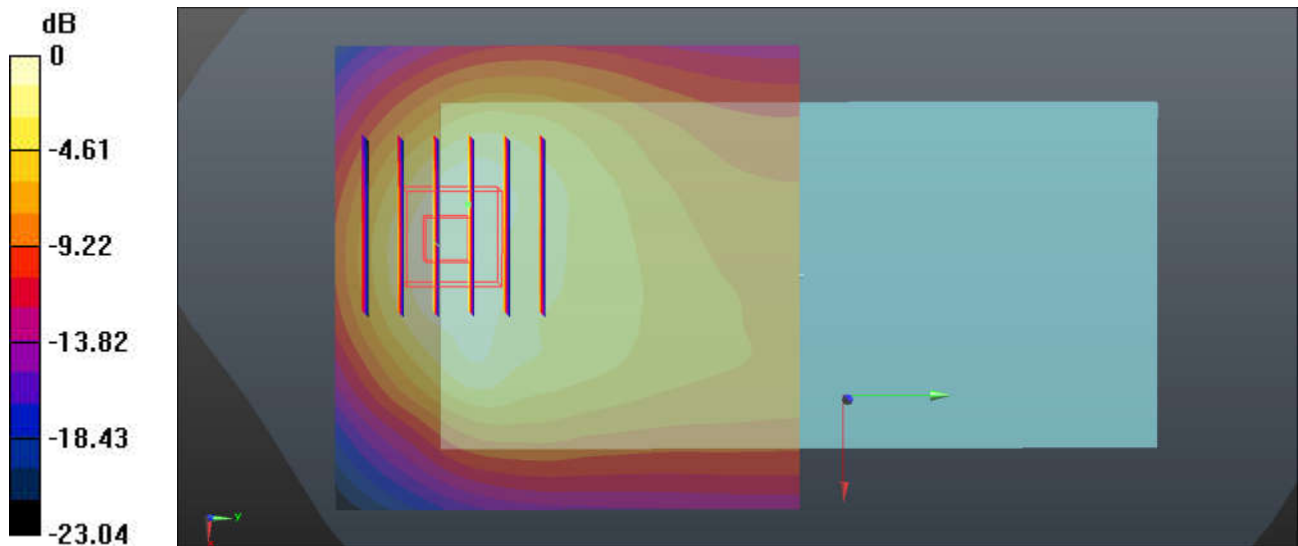

$0 \text{ dB} = 0.930 \text{ W/kg} = -0.32 \text{ dBW/kg}$

29_CDMA2000 BC0_RTAP 153.6Kbps_Front_5mm_Ch384

Communication System: UID 0, CDMA (0); Frequency: 836.52 MHz; Duty Cycle: 1:1
 Medium: HSL_835 Medium parameters used: $f = 837$ MHz; $\sigma = 0.91$ S/m; $\epsilon_r = 42.775$; $\rho = 1000$ kg/m³
 Ambient Temperature : 23.2 °C; Liquid Temperature : 22.8 °C

DASY5 Configuration:

- Probe: ES3DV3 - SN3293; ConvF(6.39, 6.39, 6.39); Calibrated: 2019.11.25
- Sensor-Surface: 3mm (Mechanical Surface Detection)
- Electronics: DAE4 Sn1338; Calibrated: 2019.11.20
- Phantom: SAM2; Type: SAM; Serial: TP-1503
- Measurement SW: DASY52, Version 52.10 (1); SEMCAD X Version 14.6.11 (7439)

Ch384/Area Scan (71x71x1): Interpolated grid: dx=1.500 mm, dy=1.500 mm

Maximum value of SAR (interpolated) = 1.28 W/kg

Ch384/Zoom Scan (6x6x7)/Cube 0: Measurement grid: dx=8mm, dy=8mm, dz=5mm

Reference Value = 18.02 V/m; Power Drift = -0.06 dB

Peak SAR (extrapolated) = 2.30 W/kg

SAR(1 g) = 1.11 W/kg; SAR(10 g) = 0.586 W/kg

Maximum value of SAR (measured) = 1.36 W/kg

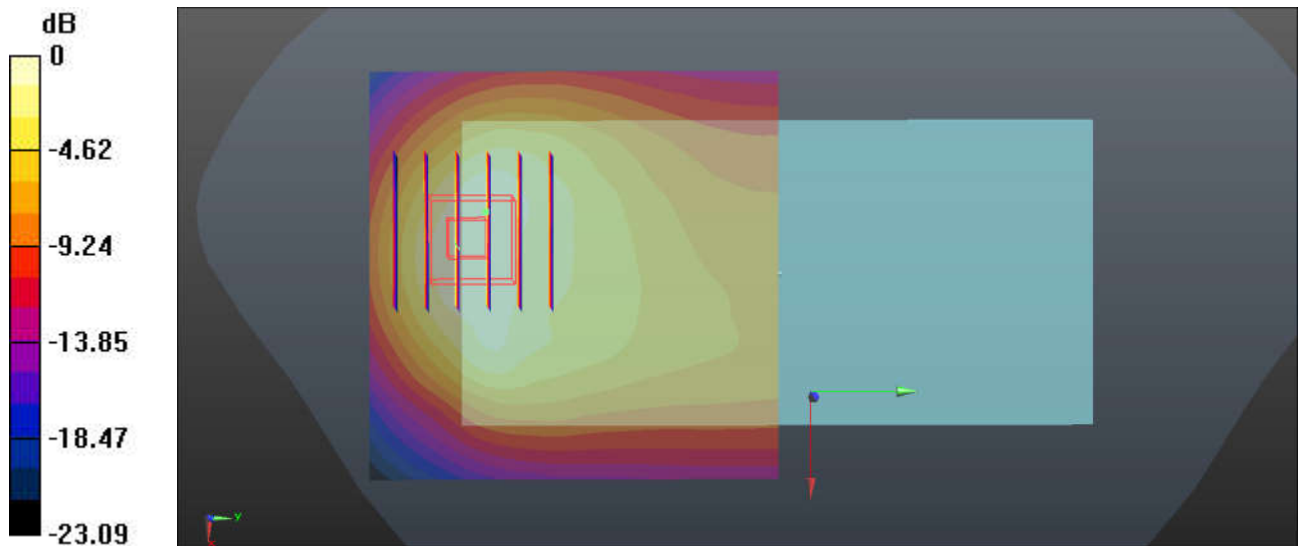

0 dB = 1.28 W/kg = 1.07 dBW/kg

30_CDMA2000 BC1_20M_RTAP 153.6Kbps_Bottom Side_5mm_Ch25

Communication System: UID 0, CDMA (0); Frequency: 1851.25 MHz; Duty Cycle: 1:1
 Medium: HSL_1900 Medium parameters used: $f = 1851.25$ MHz; $\sigma = 1.342$ S/m; $\epsilon_r = 39.788$; $\rho = 1000$ kg/m³
 Ambient Temperature : 23.3 °C; Liquid Temperature : 22.8 °C

DASY5 Configuration:

- Probe: ES3DV3 - SN3293; ConvF(5.32, 5.32, 5.32); Calibrated: 2019.11.25
- Sensor-Surface: 3mm (Mechanical Surface Detection)
- Electronics: DAE4 Sn1338; Calibrated: 2019.11.20
- Phantom: SAM2; Type: SAM; Serial: TP-1503
- Measurement SW: DASY52, Version 52.10 (1); SEMCAD X Version 14.6.11 (7439)

Ch25/Area Scan (41x81x1): Interpolated grid: dx=1.500 mm, dy=1.500 mm

Maximum value of SAR (interpolated) = 1.84 W/kg

Ch25/Zoom Scan (5x5x7)/Cube 0: Measurement grid: dx=8mm, dy=8mm, dz=5mm

Reference Value = 33.85 V/m; Power Drift = 0.06 dB

Peak SAR (extrapolated) = 2.65 W/kg

SAR(1 g) = 1.31 W/kg; SAR(10 g) = 0.608 W/kg

Maximum value of SAR (measured) = 1.73 W/kg

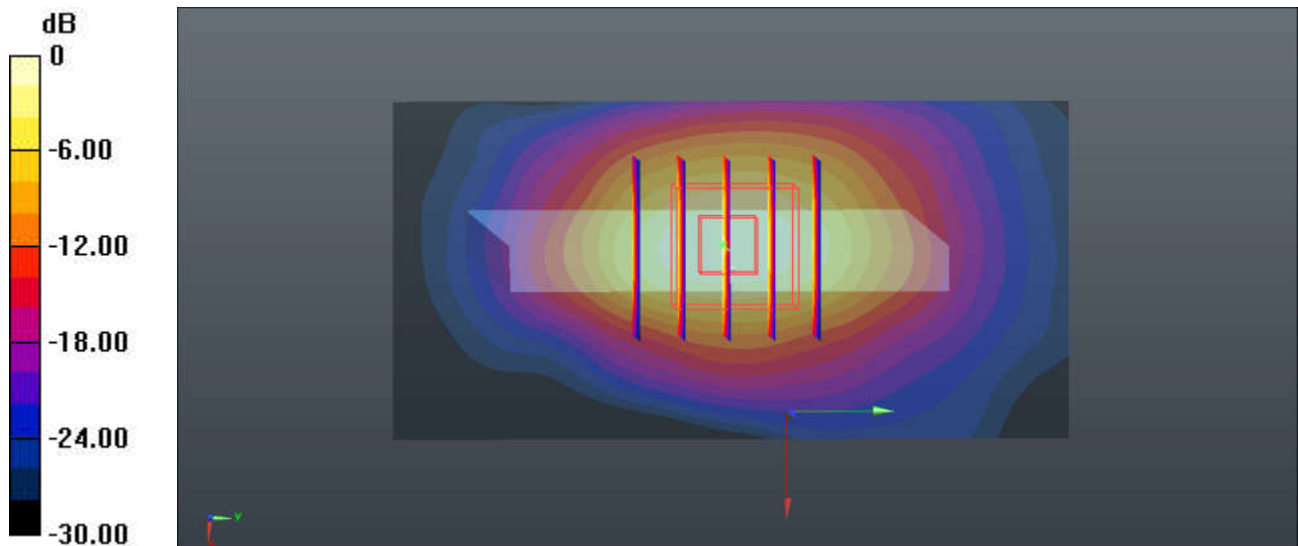

0 dB = 1.84 W/kg = 2.65 dBW/kg

31_LTE Band 7_20M_QPSK_50RB_0Offset_Back_5mm_Ch20850

Communication System: UID 0, LTE-FDD (0); Frequency: 2510 MHz; Duty Cycle: 1:1
Medium: HSL_2600 Medium parameters used: $f = 2510$ MHz; $\sigma = 1.93$ S/m; $\epsilon_r = 38.651$; $\rho = 1000$ kg/m³
Ambient Temperature : 23.3 °C; Liquid Temperature : 22.9 °C

DASY5 Configuration:

- Probe: ES3DV3 - SN3293; ConvF(4.39, 4.39, 4.39); Calibrated: 2019.11.25
- Sensor-Surface: 3mm (Mechanical Surface Detection)
- Electronics: DAE4 Sn1338; Calibrated: 2019.11.20
- Phantom: SAM2; Type: SAM; Serial: TP-1503
- Measurement SW: DASY52, Version 52.10 (1); SEMCAD X Version 14.6.11 (7439)

Ch20850/Area Scan (91x91x1): Interpolated grid: dx=1.200 mm, dy=1.200 mm

Maximum value of SAR (interpolated) = 1.78 W/kg

Ch20850/Zoom Scan (7x7x7)/Cube 0: Measurement grid: dx=5mm, dy=5mm, dz=5mm

Reference Value = 8.832 V/m; Power Drift = 0.03 dB

Peak SAR (extrapolated) = 2.97 W/kg

SAR(1 g) = 1.33 W/kg; SAR(10 g) = 0.629 W/kg

Maximum value of SAR (measured) = 1.70 W/kg

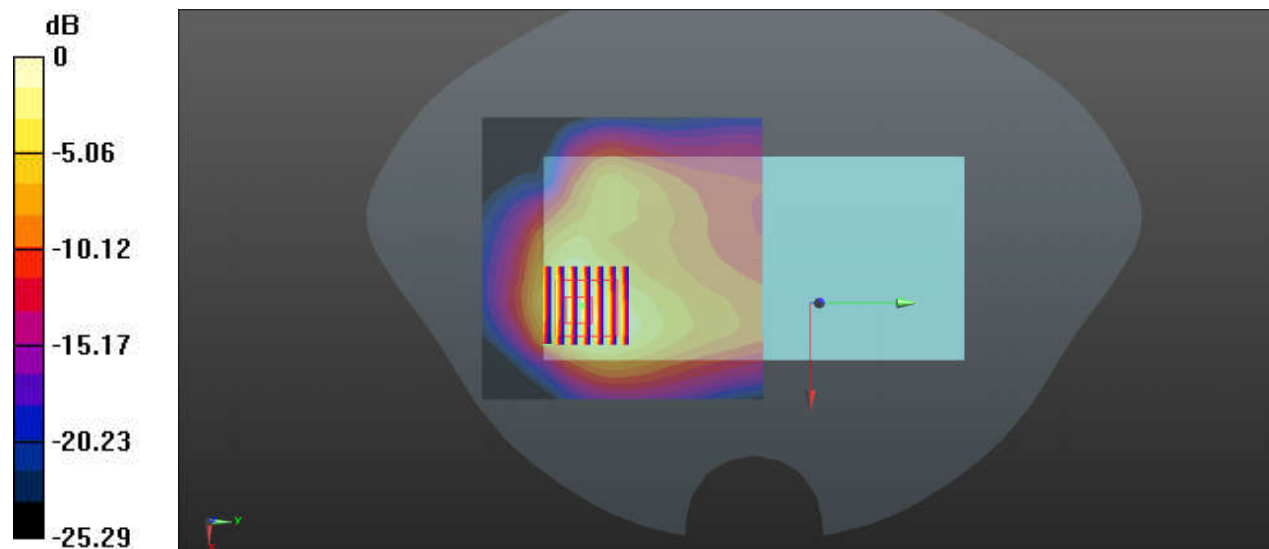

0 dB = 1.70 W/kg = 2.30 dBW/kg

32_LTE Band 12_10M_QPSK_1RB_49Offset_Front_5mm_Ch23095

Communication System: UID 0, LTE-FDD (0); Frequency: 707.5 MHz; Duty Cycle: 1:1
 Medium: HSL_750 Medium parameters used: $f = 707.5$ MHz; $\sigma = 0.852$ S/m; $\epsilon_r = 42.279$; $\rho = 1000$ kg/m³
 Ambient Temperature : 23.2 °C; Liquid Temperature : 22.9 °C

DASY5 Configuration:

- Probe: ES3DV3 - SN3293; ConvF(6.56, 6.56, 6.56); Calibrated: 2019.11.25
- Sensor-Surface: 3mm (Mechanical Surface Detection)
- Electronics: DAE4 Sn1338; Calibrated: 2019.11.20
- Phantom: SAM2; Type: SAM; Serial: TP-1503
- Measurement SW: DASY52, Version 52.10 (1); SEMCAD X Version 14.6.11 (7439)

Ch23095/Area Scan (81x71x1): Interpolated grid: dx=1.500 mm, dy=1.500 mm
 Maximum value of SAR (interpolated) = 0.949 W/kg

Ch23095/Zoom Scan (6x5x7)/Cube 0: Measurement grid: dx=8mm, dy=8mm, dz=5mm
 Reference Value = 20.09 V/m; Power Drift = 0.09 dB
 Peak SAR (extrapolated) = 1.49 W/kg
SAR(1 g) = 0.730 W/kg; SAR(10 g) = 0.409 W/kg
 Maximum value of SAR (measured) = 0.890 W/kg

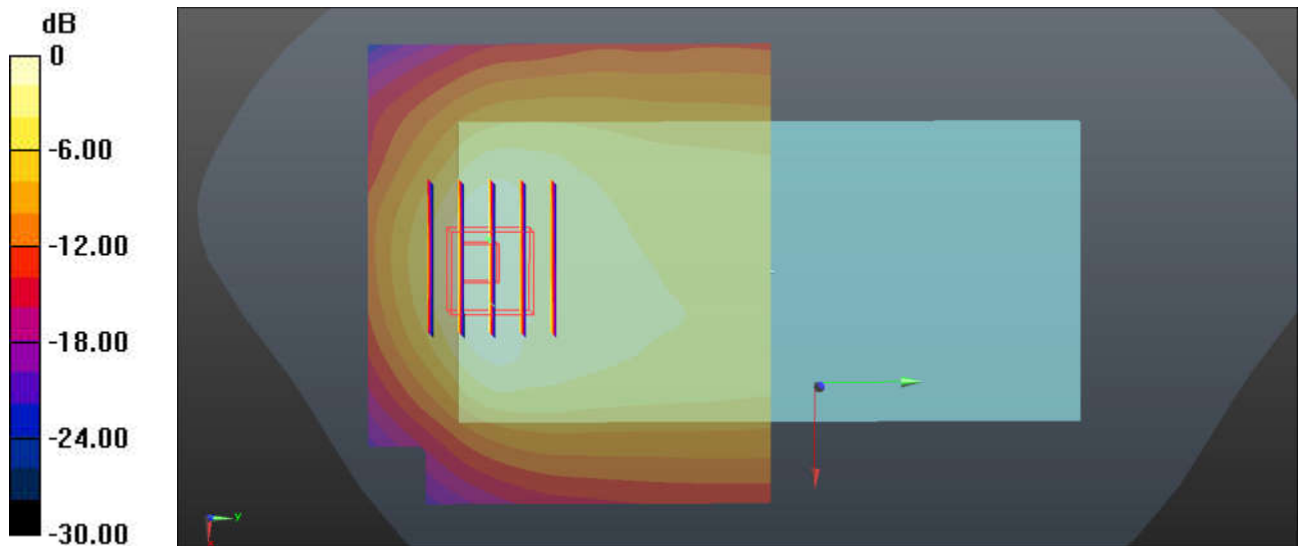

0 dB = 0.949 W/kg = -0.23 dBW/kg

33_LTE Band 13_10M_QPSK_1RB_0Offset_Bottom Side_5mm_Ch23230

Communication System: UID 0, LTE-FDD (0); Frequency: 782 MHz; Duty Cycle: 1:1
 Medium: HSL_750 Medium parameters used: $f = 782 \text{ MHz}$; $\sigma = 0.923 \text{ S/m}$; $\epsilon_r = 41.305$; $\rho = 1000 \text{ kg/m}^3$
 Ambient Temperature : $23.2 \text{ }^\circ\text{C}$; Liquid Temperature : $22.9 \text{ }^\circ\text{C}$

DASY5 Configuration:

- Probe: ES3DV3 - SN3293; ConvF(5.32, 5.32, 5.32); Calibrated: 2019.11.25
- Sensor-Surface: 3mm (Mechanical Surface Detection)
- Electronics: DAE4 Sn1338; Calibrated: 2019.11.20
- Phantom: SAM2; Type: SAM; Serial: TP-1503
- Measurement SW: DASY52, Version 52.10 (1); SEMCAD X Version 14.6.11 (7439)

Ch23230/Area Scan (41x71x1): Interpolated grid: $dx=1.500 \text{ mm}$, $dy=1.500 \text{ mm}$
 Maximum value of SAR (interpolated) = 1.43 W/kg

Ch23230/Zoom Scan (6x6x7)/Cube 0: Measurement grid: $dx=8\text{mm}$, $dy=8\text{mm}$, $dz=5\text{mm}$
 Reference Value = 35.13 V/m ; Power Drift = 0.09 dB
 Peak SAR (extrapolated) = 3.48 W/kg
SAR(1 g) = 1.25 W/kg ; SAR(10 g) = 0.537 W/kg
 Maximum value of SAR (measured) = 1.63 W/kg

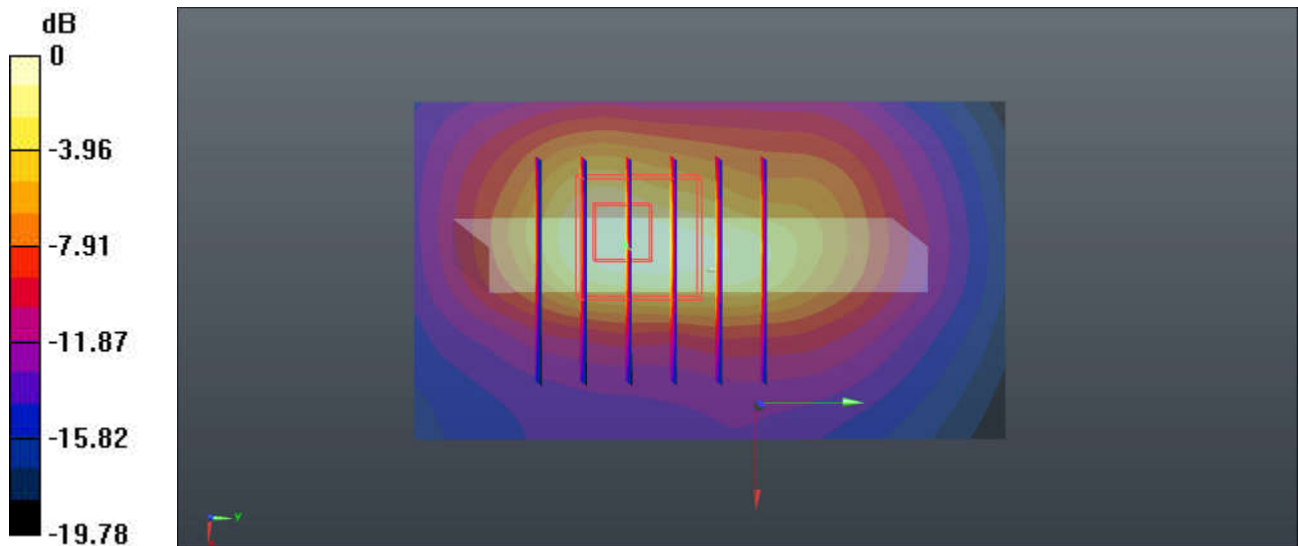

0 dB = $1.43 \text{ W/kg} = 1.55 \text{ dBW/kg}$

34_LTE Band 26_15M_QPSK_1RB_74Offset_Front_5mm_Ch26865

Communication System: UID 0, LTE-FDD (0); Frequency: 831.5 MHz; Duty Cycle: 1:1
Medium: HSL_835 Medium parameters used: $f = 831.5$ MHz; $\sigma = 0.905$ S/m; $\epsilon_r = 42.84$; $\rho = 1000$ kg/m³
Ambient Temperature : 23.2 °C; Liquid Temperature : 22.8 °C

DASY5 Configuration:

- Probe: ES3DV3 - SN3293; ConvF(6.39, 6.39, 6.39); Calibrated: 2019.11.25
- Sensor-Surface: 3mm (Mechanical Surface Detection)
- Electronics: DAE4 Sn1338; Calibrated: 2019.11.20
- Phantom: SAM2; Type: SAM; Serial: TP-1503
- Measurement SW: DASY52, Version 52.10 (1); SEMCAD X Version 14.6.11 (7439)

Ch26865/Area Scan (81x71x1): Interpolated grid: dx=1.500 mm, dy=1.500 mm
Maximum value of SAR (interpolated) = 1.15 W/kg

Ch26865/Zoom Scan (6x6x7)/Cube 0: Measurement grid: dx=8mm, dy=8mm, dz=5mm
Reference Value = 17.06 V/m; Power Drift = 0.01 dB
Peak SAR (extrapolated) = 2.06 W/kg
SAR(1 g) = 1.15 W/kg; SAR(10 g) = 0.571 W/kg
Maximum value of SAR (measured) = 1.37 W/kg

Ch26865/Zoom Scan (6x6x7)/Cube 1: Measurement grid: dx=8mm, dy=8mm, dz=5mm
Reference Value = 17.06 V/m; Power Drift = 0.01 dB
Peak SAR (extrapolated) = 1.79 W/kg
SAR(1 g) = 0.878 W/kg; SAR(10 g) = 0.462 W/kg
Maximum value of SAR (measured) = 1.18 W/kg

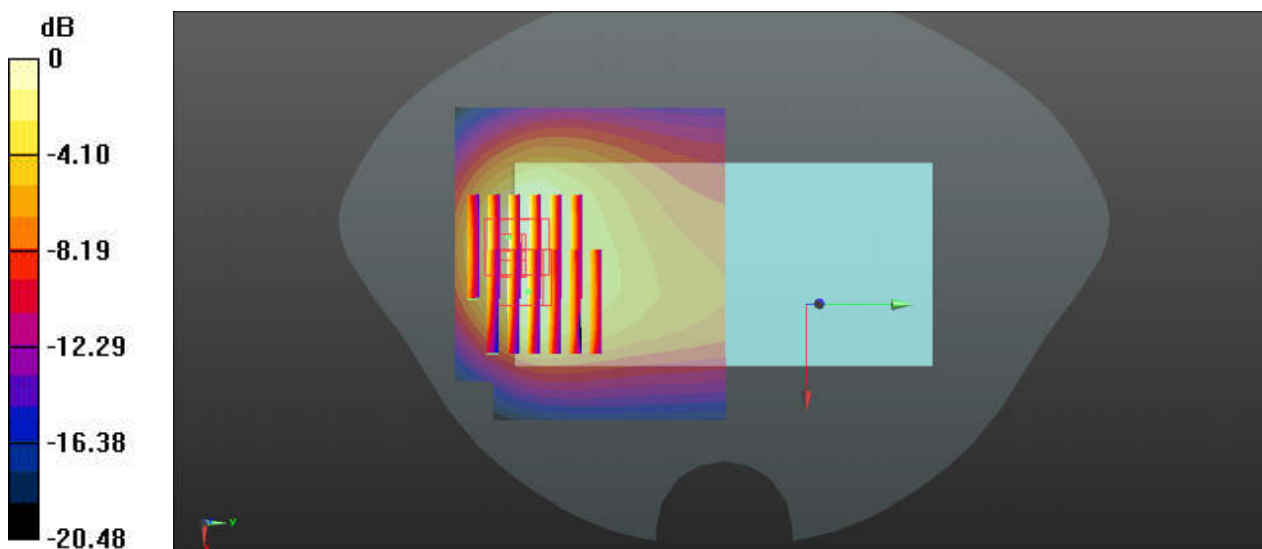

0 dB = 1.18 W/kg = 0.72 dBW/kg

35_LTE Band 25_20M_QPSK_50RB_0Offset_Back_5mm_Ch26590

Communication System: UID 0, LTE-FDD (0); Frequency: 1905 MHz; Duty Cycle: 1:1
 Medium: HSL_1900 Medium parameters used: $f = 1905$ MHz; $\sigma = 1.404$ S/m; $\epsilon_r = 39.629$; $\rho = 1000$ kg/m³
 Ambient Temperature : 23.3 °C; Liquid Temperature : 22.8 °C

DASY5 Configuration:

- Probe: ES3DV3 - SN3293; ConvF(5.32, 5.32, 5.32); Calibrated: 2019.11.25
- Sensor-Surface: 3mm (Mechanical Surface Detection)
- Electronics: DAE4 Sn1338; Calibrated: 2019.11.20
- Phantom: SAM2; Type: SAM; Serial: TP-1503
- Measurement SW: DASY52, Version 52.10 (1); SEMCAD X Version 14.6.11 (7439)

Ch26590/Area Scan (81x71x1): Interpolated grid: dx=1.500 mm, dy=1.500 mm

Maximum value of SAR (interpolated) = 1.60 W/kg

Ch26590/Zoom Scan (5x5x7)/Cube 0: Measurement grid: dx=8mm, dy=8mm, dz=5mm

Reference Value = 1.625 V/m; Power Drift = -0.03 dB

Peak SAR (extrapolated) = 3.19 W/kg

SAR(1 g) = 1.2 W/kg; SAR(10 g) = 0.554 W/kg

Maximum value of SAR (measured) = 1.42 W/kg

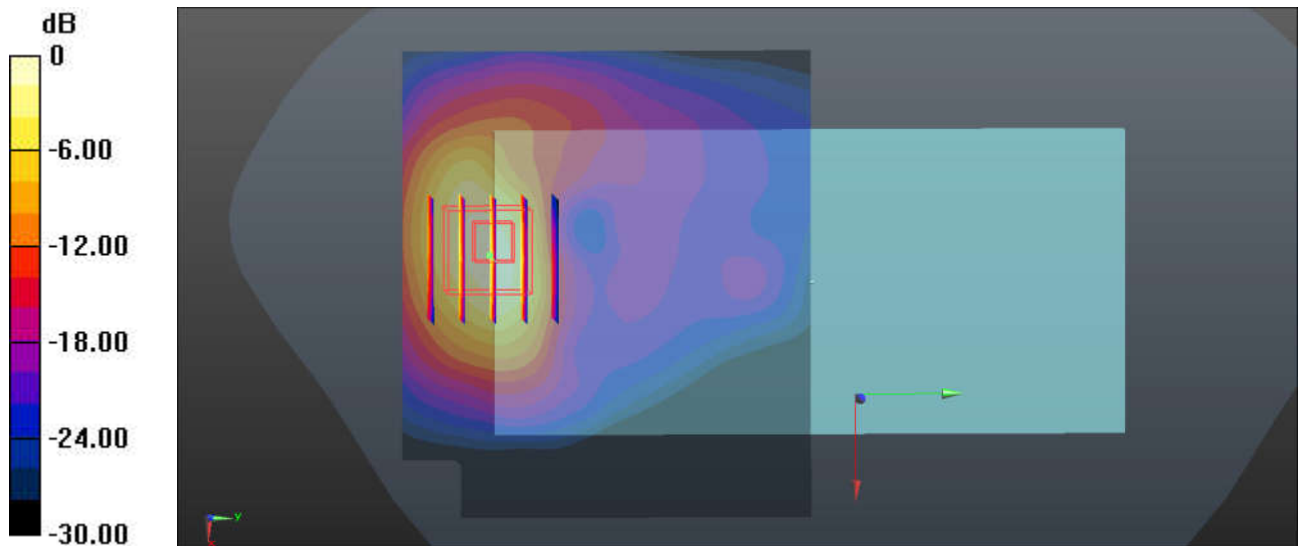

0 dB = 1.60 W/kg = 2.04 dBW/kg

36_LTE Band 66_20M_QPSK_1RB_99Offset_Back_5mm_Ch132072

Communication System: UID 0, LTE-FDD (0); Frequency: 1720 MHz; Duty Cycle: 1:1
 Medium: HSL_1750 Medium parameters used: $f = 1720$ MHz; $\sigma = 1.341$ S/m; $\epsilon_r = 40.786$; $\rho = 1000$ kg/m³
 Ambient Temperature : 23.3 °C; Liquid Temperature : 22.6 °C

DASY5 Configuration:

- Probe: ES3DV3 - SN3293; ConvF(5.53, 5.53, 5.53); Calibrated: 2019.11.25
- Sensor-Surface: 3mm (Mechanical Surface Detection)
- Electronics: DAE4 Sn1338; Calibrated: 2019.11.20
- Phantom: SAM2; Type: SAM; Serial: TP-1503
- Measurement SW: DASY52, Version 52.10 (1); SEMCAD X Version 14.6.11 (7439)

Ch132072/Area Scan (81x71x1): Interpolated grid: dx=1.500 mm, dy=1.500 mm
 Maximum value of SAR (interpolated) = 1.32 W/kg

Ch132072/Zoom Scan (5x5x7)/Cube 0: Measurement grid: dx=8mm, dy=8mm, dz=5mm
 Reference Value = 3.291 V/m; Power Drift = 0.10 dB
 Peak SAR (extrapolated) = 2.04 W/kg
SAR(1 g) = 1.18 W/kg; SAR(10 g) = 0.610 W/kg
 Maximum value of SAR (measured) = 1.42 W/kg

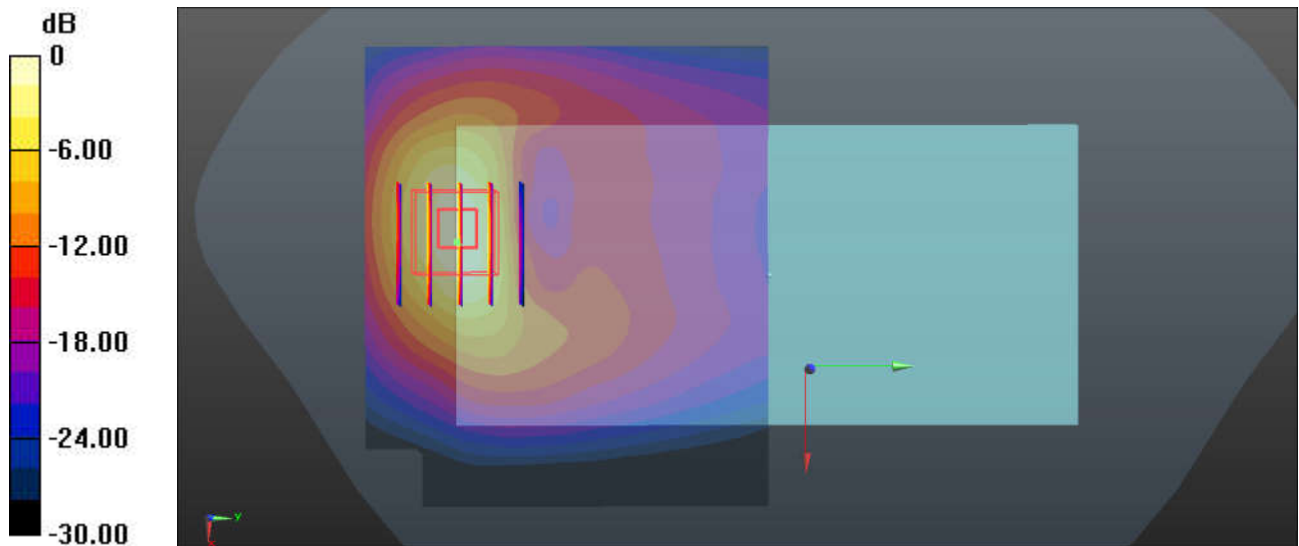

0 dB = 1.32 W/kg = 1.21 dBW/kg

37_LTE Band 71_20M_QPSK_1RB_49Offset_Bottom Side_5mm_Ch133322

Communication System: UID 0, LTE-FDD (0); Frequency: 683 MHz;Duty Cycle: 1:1
Medium: HSL_750 Medium parameters used: f = 683 MHz; $\sigma = 0.849$ S/m; $\epsilon_r = 44.101$; $\rho = 1000$ kg/m³
Ambient Temperature : 23.2 °C; Liquid Temperature : 22.9 °C

DASY5 Configuration:

- Probe: ES3DV3 - SN3293; ConvF(6.56, 6.56, 6.56); Calibrated: 2019.11.25
- Sensor-Surface: 3mm (Mechanical Surface Detection)
- Electronics: DAE4 Sn1338; Calibrated: 2019.11.20
- Phantom: SAM2; Type: SAM; Serial: TP-1503
- Measurement SW: DASY52, Version 52.10 (1); SEMCAD X Version 14.6.11 (7439)

Ch133322/Area Scan (41x71x1): Interpolated grid: dx=1.500 mm, dy=1.500 mm
Maximum value of SAR (interpolated) = 0.946 W/kg

Ch133322/Zoom Scan (5x5x7)/Cube 0: Measurement grid: dx=8mm, dy=8mm, dz=5mm
Reference Value = 27.70 V/m; Power Drift = 0.01 dB
Peak SAR (extrapolated) = 2.56 W/kg
SAR(1 g) = 0.785 W/kg; SAR(10 g) = 0.328 W/kg
Maximum value of SAR (measured) = 1.06 W/kg

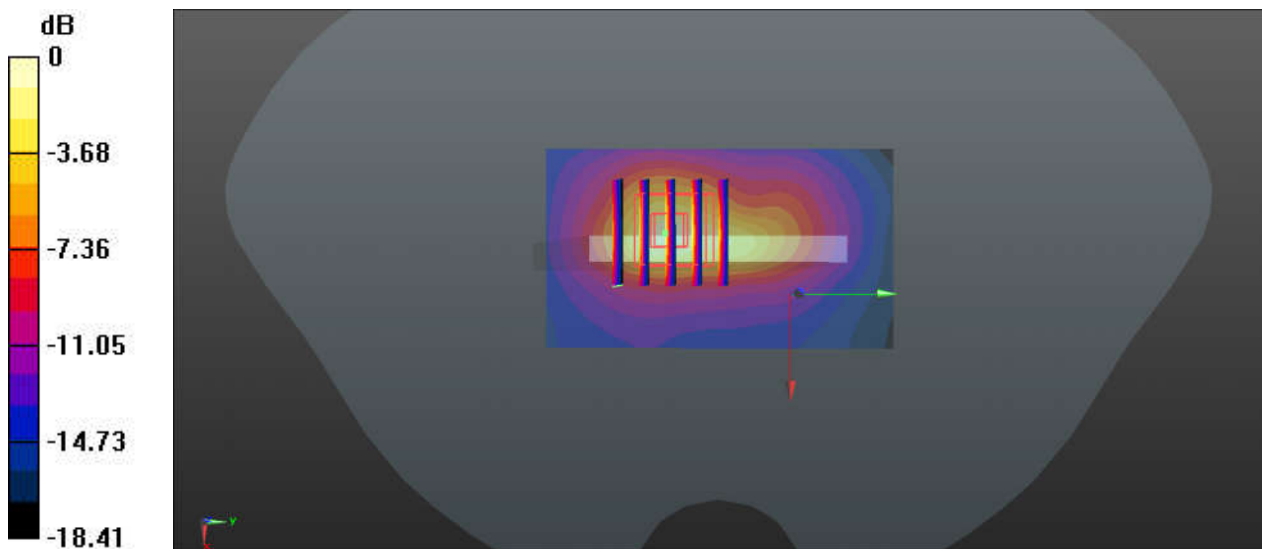

0 dB = 1.06 W/kg = 0.25 dBW/kg

38_LTE Band 41_20M_QPSK_1RB_49Offset_Back_5mm_Ch40185

Communication System: UID 0, LTE-TDD (0); Frequency: 2549.5 MHz; Duty Cycle: 1:1.59
Medium: HSL_2600 Medium parameters used: $f = 2549.5$ MHz; $\sigma = 1.992$ S/m; $\epsilon_r = 38.272$; $\rho = 1000$ kg/m³
Ambient Temperature : 23.3 °C; Liquid Temperature : 22.9 °C

DASY5 Configuration:

- Probe: ES3DV3 - SN3293; ConvF(4.39, 4.39, 4.39); Calibrated: 2019.11.25
- Sensor-Surface: 3mm (Mechanical Surface Detection)
- Electronics: DAE4 Sn1338; Calibrated: 2019.11.20
- Phantom: SAM2; Type: SAM; Serial: TP-1503
- Measurement SW: DASY52, Version 52.10 (1); SEMCAD X Version 14.6.11 (7439)

Ch40185/Area Scan (91x81x1): Interpolated grid: dx=1.200 mm, dy=1.200 mm

Maximum value of SAR (interpolated) = 1.38 W/kg

Ch40185/Zoom Scan (7x7x7)/Cube 0: Measurement grid: dx=5mm, dy=5mm, dz=5mm

Reference Value = 8.007 V/m; Power Drift = 0.03 dB

Peak SAR (extrapolated) = 2.93 W/kg

SAR(1 g) = 1.23 W/kg; SAR(10 g) = 0.572 W/kg

Maximum value of SAR (measured) = 1.57 W/kg

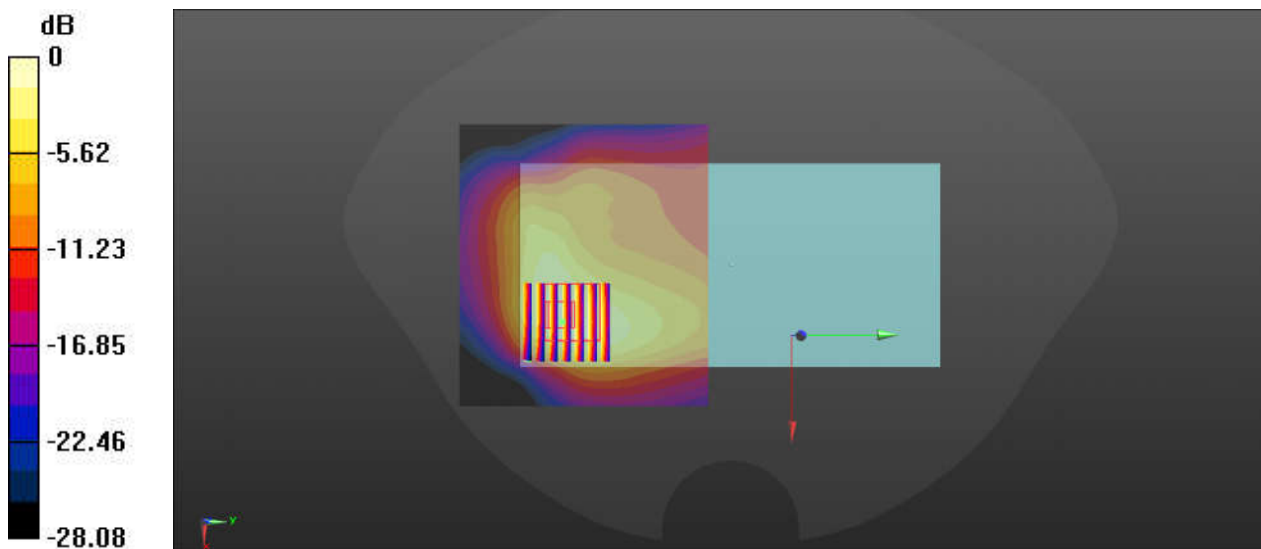

0 dB = 1.57 W/kg = 1.96 dBW/kg

39_LTE Band 41-HPUE_20M_QPSK_1RB_49Offset_Back_5mm_Ch40185

Communication System: UID 0, LTE-TDD (0); Frequency: 2549.5 MHz; Duty Cycle: 1:1.59
Medium: HSL_2600 Medium parameters used: $f = 2549.5$ MHz; $\sigma = 1.992$ S/m; $\epsilon_r = 38.272$; $\rho = 1000$ kg/m³
Ambient Temperature : 23.3 °C; Liquid Temperature : 22.9 °C

DASY5 Configuration:

- Probe: ES3DV3 - SN3293; ConvF(4.39, 4.39, 4.39); Calibrated: 2019.11.25
- Sensor-Surface: 3mm (Mechanical Surface Detection)
- Electronics: DAE4 Sn1338; Calibrated: 2019.11.20
- Phantom: SAM2; Type: SAM; Serial: TP-1503
- Measurement SW: DASY52, Version 52.10 (1); SEMCAD X Version 14.6.11 (7439)

Ch40185/Area Scan (91x81x1): Interpolated grid: dx=1.200 mm, dy=1.200 mm

Maximum value of SAR (interpolated) = 1.19 W/kg

Ch40185/Zoom Scan (7x7x7)/Cube 0: Measurement grid: dx=5mm, dy=5mm, dz=5mm

Reference Value = 6.352 V/m; Power Drift = 0.01 dB

Peak SAR (extrapolated) = 1.92 W/kg

SAR(1 g) = 0.818 W/kg; SAR(10 g) = 0.385 W/kg

Maximum value of SAR (measured) = 1.08 W/kg

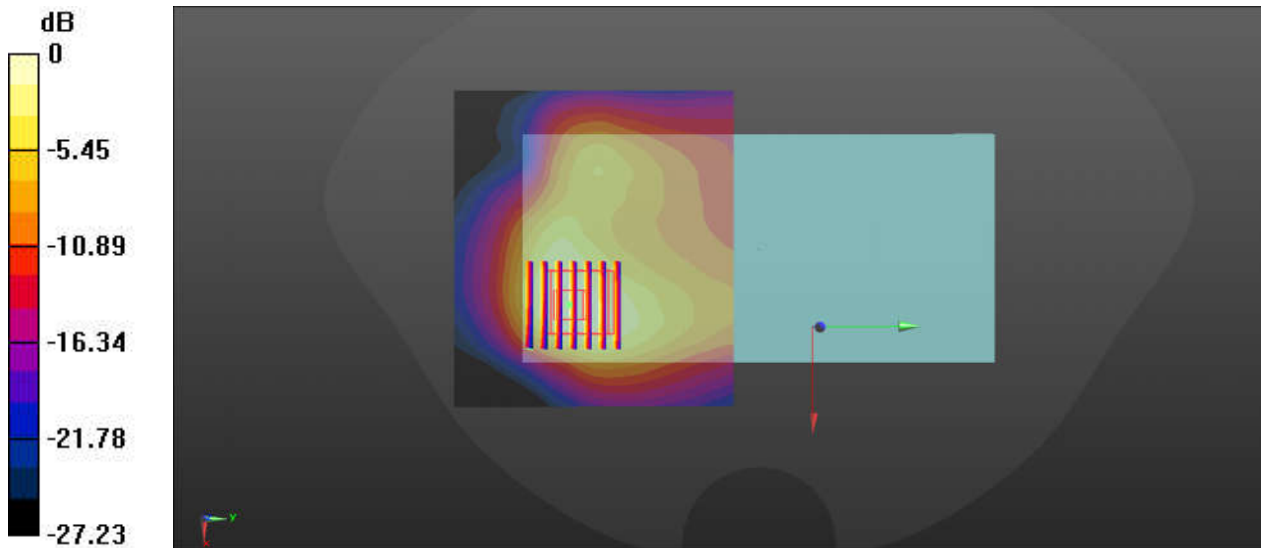

0 dB = 1.08 W/kg = 0.33 dBW/kg

40_WLAN 2.4GHz_802.11b 1Mbps_Back_5mm_Ch6

Communication System: UID 0, 802.11b (0); Frequency: 2437 MHz; Duty Cycle: 1:1.025
Medium: HSL_2450 Medium parameters used: $f = 2437$ MHz; $\sigma = 1.843$ S/m; $\epsilon_r = 38.589$; $\rho = 1000$ kg/m³
Ambient Temperature : 23.4 °C ; Liquid Temperature : 22.7 °C

DASY5 Configuration:

- Probe: ES3DV3 - SN3293; ConvF(4.6, 4.6, 4.6); Calibrated: 2019.11.25
- Sensor-Surface: 3mm (Mechanical Surface Detection)
- Electronics: DAE4 Sn1338; Calibrated: 2019.11.20
- Phantom: SAM2; Type: SAM; Serial: TP-1503
- Measurement SW: DASY52, Version 52.10 (1); SEMCAD X Version 14.6.11 (7439)

Ch6/Area Scan (91x81x1): Interpolated grid: dx=1.200 mm, dy=1.200 mm
Maximum value of SAR (interpolated) = 1.27 W/kg

Ch6/Zoom Scan (7x7x7)/Cube 0: Measurement grid: dx=5mm, dy=5mm, dz=5mm
Reference Value = 6.091 V/m; Power Drift = 0.04 dB
Peak SAR (extrapolated) = 1.54 W/kg
SAR(1 g) = 0.792 W/kg; SAR(10 g) = 0.410 W/kg
Maximum value of SAR (measured) = 1.02 W/kg

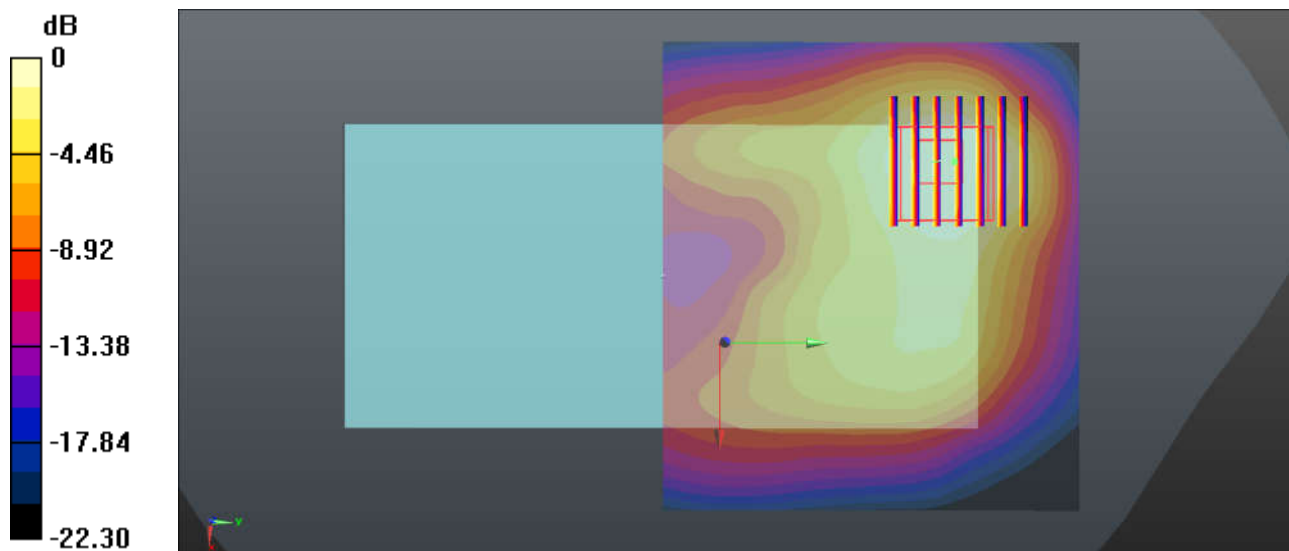

0 dB = 1.02 W/kg = 0.09 dBW/kg

41_Bluetooth_1Mbps_Back_5mm_Ch39

Communication System: UID 0, Bluetooth (0); Frequency: 2441 MHz; Duty Cycle: 1:1.299
Medium: HSL_2450 Medium parameters used: $f = 2441$ MHz; $\sigma = 1.848$ S/m; $\epsilon_r = 38.573$; $\rho = 1000$ kg/m³
Ambient Temperature : 23.4 °C; Liquid Temperature : 22.7 °C

DASY5 Configuration:

- Probe: ES3DV3 - SN3293; ConvF(4.6, 4.6, 4.6); Calibrated: 2019.11.25
- Sensor-Surface: 3mm (Mechanical Surface Detection)
- Electronics: DAE4 Sn1338; Calibrated: 2019.11.20
- Phantom: SAM2; Type: SAM; Serial: TP-1503
- Measurement SW: DASY52, Version 52.10 (1); SEMCAD X Version 14.6.11 (7439)

Ch39/Area Scan (101x81x1): Interpolated grid: dx=1.200 mm, dy=1.200 mm

Maximum value of SAR (interpolated) = 0.0913 W/kg

Ch39/Zoom Scan (7x7x7)/Cube 0: Measurement grid: dx=5mm, dy=5mm, dz=5mm

Reference Value = 2.018 V/m; Power Drift = -0.17 dB

Peak SAR (extrapolated) = 0.139 W/kg

SAR(1 g) = 0.070 W/kg; SAR(10 g) = 0.037 W/kg

Ratio of SAR at M2 to SAR at M1 = 51.8%

Maximum value of SAR (measured) = 0.0894 W/kg

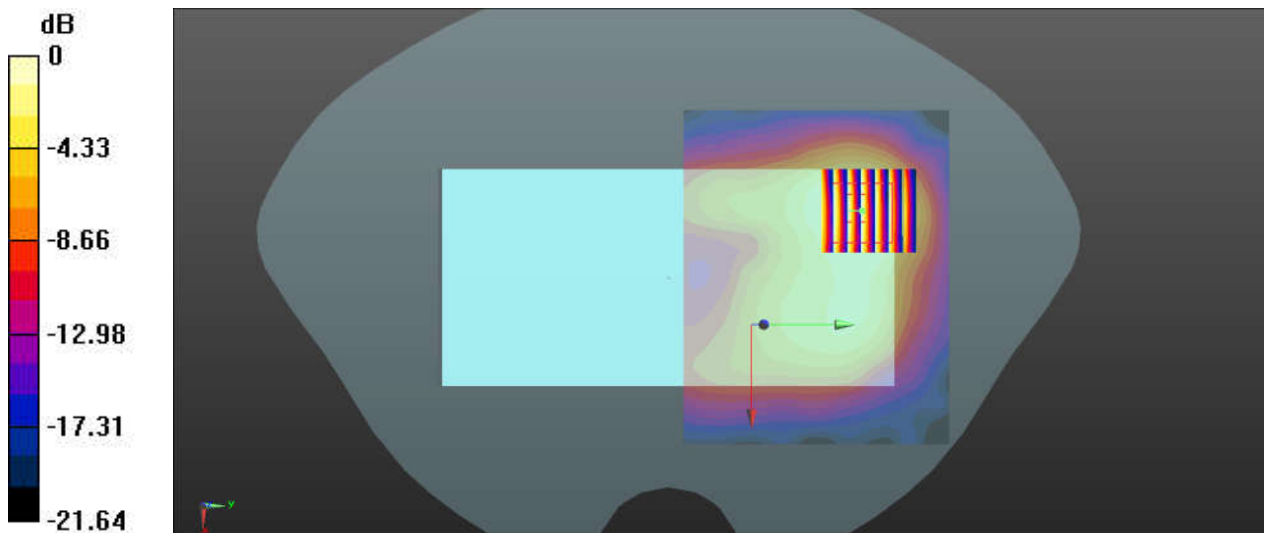

0 dB = 0.0894 W/kg = -10.49 dBW/kg

42_WLAN 5GHz_802.11a 6Mbps_Back_5mm_Ch44

Communication System: UID 0, 802.11a (0); Frequency: 5220 MHz; Duty Cycle: 1:1.149
Medium: HSL_5000 Medium parameters used: $f = 5220$ MHz; $\sigma = 4.566$ S/m; $\epsilon_r = 36.447$; $\rho = 1000$ kg/m³
Ambient Temperature : 23.2 °C; Liquid Temperature : 22.7 °C

DASY5 Configuration:

- Probe: EX3DV4-SN3857; ConvF(5.19, 5.19, 5.19); Calibrated: 2019.5.27
- Sensor-Surface: 1.4mm (Mechanical Surface Detection)
- Electronics: DAE4 Sn1338; Calibrated: 2019.11.20
- Phantom: SAM1; Type: SAM; Serial: TP-1839
- Measurement SW: DASY52, Version 52.10 (1); SEMCAD X Version 14.6.11 (7439)

Ch44/Area Scan (101x101x1): Interpolated grid: dx=1.000 mm, dy=1.000 mm

Maximum value of SAR (interpolated) = 2.21 W/kg

Ch44/Zoom Scan (8x8x7)/Cube 0: Measurement grid: dx=4mm, dy=4mm, dz=1.4mm

Reference Value = 0 V/m; Power Drift = -0.09 dB

Peak SAR (extrapolated) = 3.13 W/kg

SAR(1 g) = 0.864 W/kg; SAR(10 g) = 0.213 W/kg

Maximum value of SAR (measured) = 1.88 W/kg

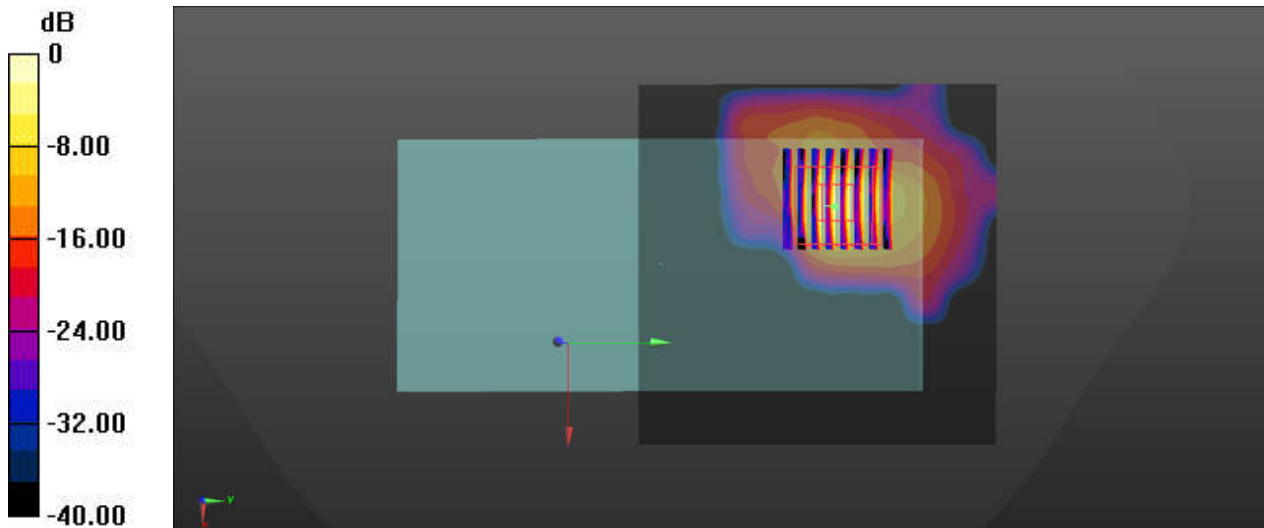

0 dB = 2.21 W/kg = 3.44 dBW/kg

43_WLAN 5GHz_802.11a 6Mbps_Back_5mm_Ch149

Communication System: UID 0, 802.11a (0); Frequency: 5745 MHz; Duty Cycle: 1:1.149
Medium: HSL_5000 Medium parameters used: $f = 5745$ MHz; $\sigma = 5.16$ S/m; $\epsilon_r = 35.56$; $\rho = 1000$ kg/m³
Ambient Temperature : 23.2 °C; Liquid Temperature : 22.7 °C

DASY5 Configuration:

- Probe: EX3DV4-SN3857; ConvF(5.17, 5.17, 5.17); Calibrated: 2019.5.27
- Sensor-Surface: 1.4mm (Mechanical Surface Detection)
- Electronics: DAE4 Sn1338; Calibrated: 2019.11.20
- Phantom: SAM1; Type: SAM; Serial: TP-1839
- Measurement SW: DASY52, Version 52.10 (1); SEMCAD X Version 14.6.11 (7439)

Ch149/Area Scan (101x101x1): Interpolated grid: dx=1.000 mm, dy=1.000 mm

Maximum value of SAR (interpolated) = 1.43 W/kg

Ch149/Zoom Scan (8x8x7)/Cube 0: Measurement grid: dx=4mm, dy=4mm, dz=1.4mm

Reference Value = 1.983 V/m; Power Drift = 0.07 dB

Peak SAR (extrapolated) = 2.84 W/kg

SAR(1 g) = 0.656 W/kg; SAR(10 g) = 0.191 W/kg

Maximum value of SAR (measured) = 1.64 W/kg

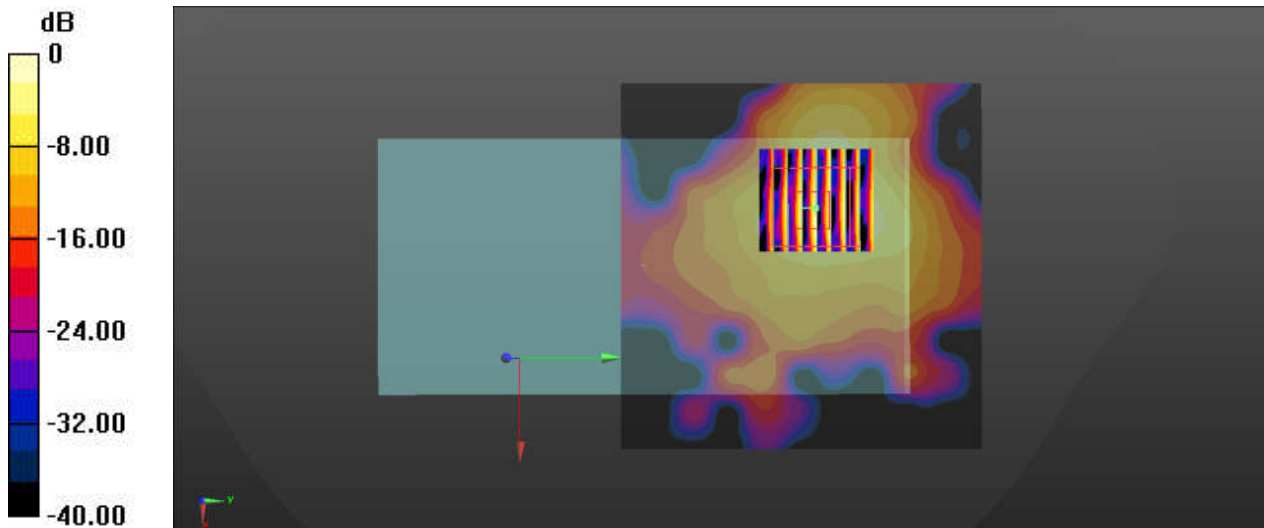

0 dB = 1.43 W/kg = 1.55 dBW/kg

44_GSM850_GPRS 2 Tx slots_Front_5mm_Ch189

Communication System: UID 0, GSM850-2UP (0); Frequency: 836.4 MHz; Duty Cycle: 1:4.15
 Medium: HSL_835 Medium parameters used: $f = 836.4 \text{ MHz}$; $\sigma = 0.903 \text{ S/m}$; $\epsilon_r = 41.219$; $\rho = 1000 \text{ kg/m}^3$
 Ambient Temperature : 23.2 °C; Liquid Temperature : 22.8 °C

DASY5 Configuration:

- Probe: ES3DV3 - SN3293; ConvF(6.39, 6.39, 6.39); Calibrated: 2019.11.25
- Sensor-Surface: 3mm (Mechanical Surface Detection)
- Electronics: DAE4 Sn1338; Calibrated: 2019.11.20
- Phantom: SAM2; Type: SAM; Serial: TP-1503
- Measurement SW: DASY52, Version 52.10 (1); SEMCAD X Version 14.6.11 (7439)

Ch189/Area Scan (81x71x1): Interpolated grid: $dx=1.500 \text{ mm}$, $dy=1.500 \text{ mm}$

Maximum value of SAR (interpolated) = 1.20 W/kg

Ch189/Zoom Scan (6x6x7)/Cube 0: Measurement grid: $dx=8\text{mm}$, $dy=8\text{mm}$, $dz=5\text{mm}$

Reference Value = 17.90 V/m; Power Drift = 0.04 dB

Peak SAR (extrapolated) = 2.15 W/kg

SAR(1 g) = 1.06 W/kg; SAR(10 g) = 0.569 W/kg

Maximum value of SAR (measured) = 1.24 W/kg

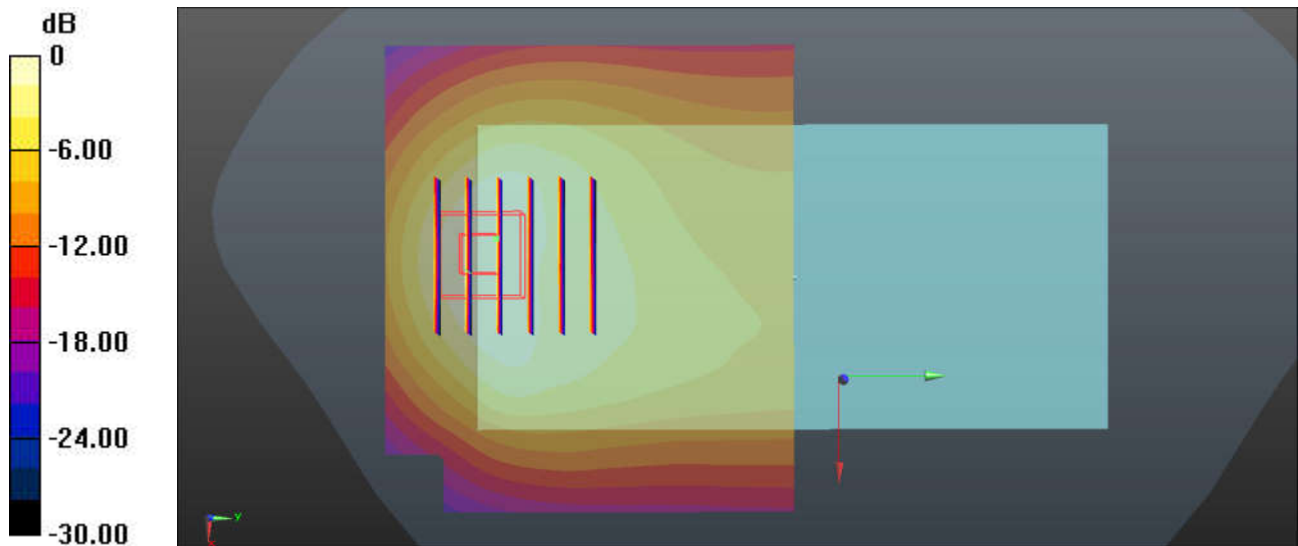

0 dB = 1.20 W/kg = 0.79 dBW/kg

45_GSM1900_GPRS 2 Tx slots_Back_5mm_Ch661

Communication System: UID 0, PCS-2UP (0); Frequency: 1880 MHz; Duty Cycle: 1:4.15
 Medium: HSL_1900 Medium parameters used: $f = 1880$ MHz; $\sigma = 1.376$ S/m; $\epsilon_r = 39.136$; $\rho = 1000$ kg/m³
 Ambient Temperature : 23.3 °C; Liquid Temperature : 22.8 °C

DASY5 Configuration:

- Probe: ES3DV3 - SN3293; ConvF(5.32, 5.32, 5.32); Calibrated: 2019.11.25
- Sensor-Surface: 3mm (Mechanical Surface Detection)
- Electronics: DAE4 Sn1338; Calibrated: 2019.11.20
- Phantom: SAM2; Type: SAM; Serial: TP-1503
- Measurement SW: DASY52, Version 52.10 (1); SEMCAD X Version 14.6.11 (7439)

Ch661/Area Scan (81x71x1): Interpolated grid: dx=1.500 mm, dy=1.500 mm

Maximum value of SAR (interpolated) = 1.39 W/kg

Ch661/Zoom Scan (6x6x7)/Cube 0: Measurement grid: dx=8mm, dy=8mm, dz=5mm

Reference Value = 2.300 V/m; Power Drift = 0.03 dB

Peak SAR (extrapolated) = 1.99 W/kg

SAR(1 g) = 1.02 W/kg; SAR(10 g) = 0.490 W/kg

Maximum value of SAR (measured) = 1.26 W/kg

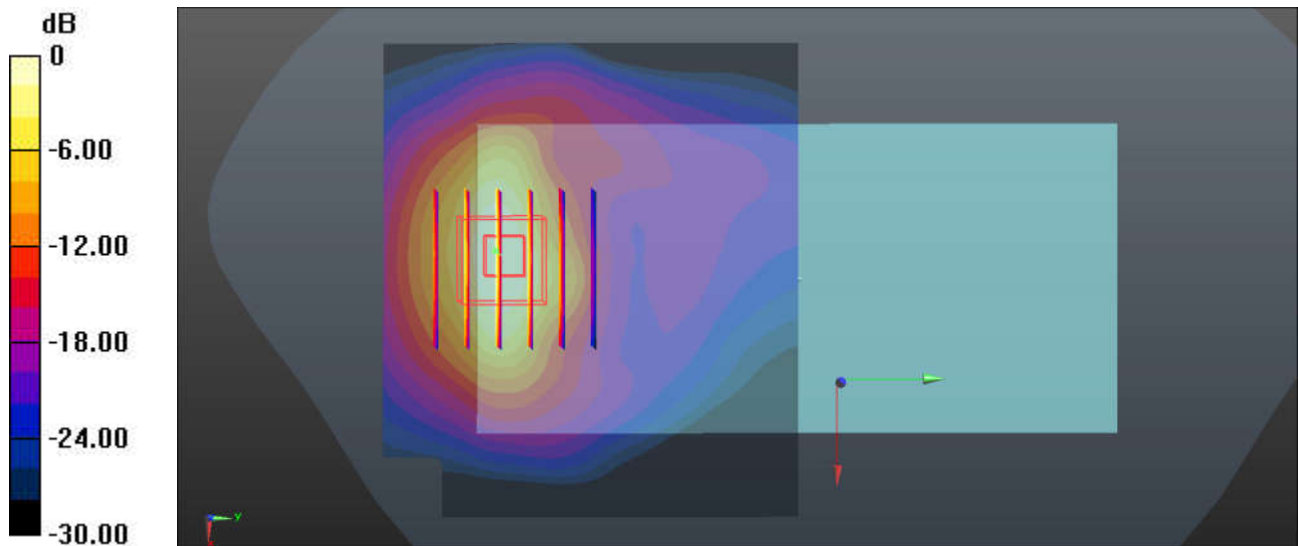

0 dB = 1.39 W/kg = 1.43 dBW/kg

46_WCDMA II_RMC 12.2Kbps_Back_5mm_Ch9400

Communication System: UID 0, WCDMA (0); Frequency: 1880 MHz; Duty Cycle: 1:1
 Medium: HSL_1900 Medium parameters used: $f = 1880$ MHz; $\sigma = 1.376$ S/m; $\epsilon_r = 39.136$; $\rho = 1000$ kg/m³
 Ambient Temperature : 23.3 °C; Liquid Temperature : 22.8 °C

DASY5 Configuration:

- Probe: ES3DV3 - SN3293; ConvF(5.32, 5.32, 5.32); Calibrated: 2019.11.25
- Sensor-Surface: 3mm (Mechanical Surface Detection)
- Electronics: DAE4 Sn1338; Calibrated: 2019.11.20
- Phantom: SAM2; Type: SAM; Serial: TP-1503
- Measurement SW: DASY52, Version 52.10 (1); SEMCAD X Version 14.6.11 (7439)

Ch9400/Area Scan (81x71x1): Interpolated grid: dx=1.500 mm, dy=1.500 mm

Maximum value of SAR (interpolated) = 1.46 W/kg

Ch9400/Zoom Scan (5x5x7)/Cube 0: Measurement grid: dx=8mm, dy=8mm, dz=5mm

Reference Value = 1.311 V/m; Power Drift = 0.04 dB

Peak SAR (extrapolated) = 1.93 W/kg

SAR(1 g) = 1.06 W/kg; SAR(10 g) = 0.532 W/kg

Maximum value of SAR (measured) = 1.32 W/kg

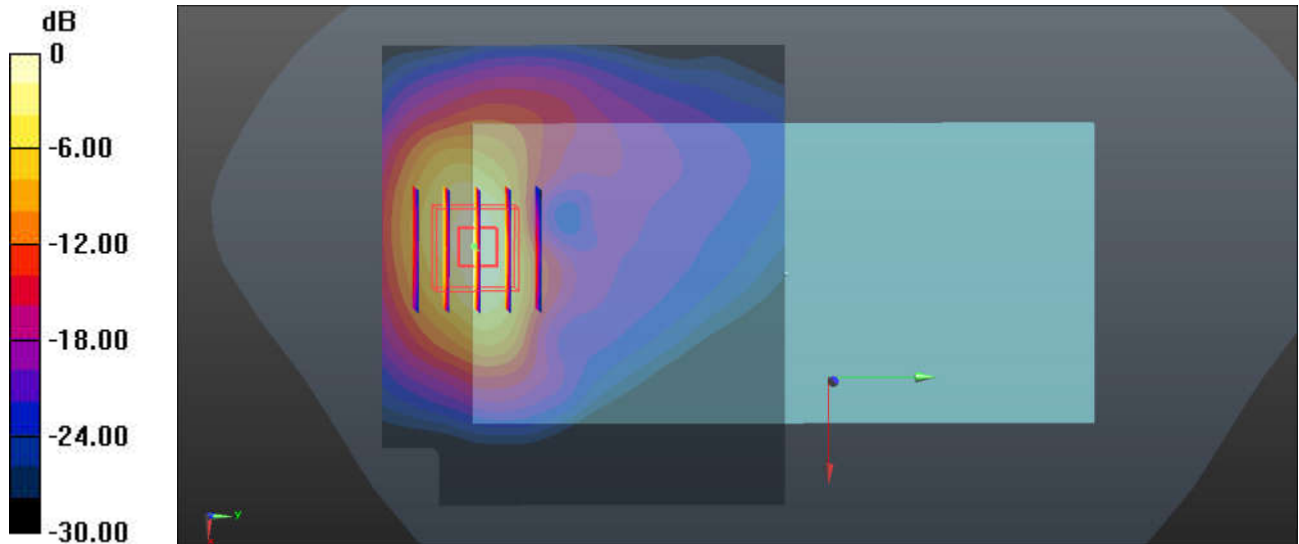

0 dB = 1.46 W/kg = 1.64 dBW/kg

47_WCDMA IV_RMC 12.2Kbps_Back_5mm_Ch1312

Communication System: UID 0, WCDMA (0); Frequency: 1712.4 MHz; Duty Cycle: 1:1
 Medium: HSL_1750 Medium parameters used: $f = 1712.4 \text{ MHz}$; $\sigma = 1.317 \text{ S/m}$; $\epsilon_r = 39.244$; $\rho = 1000 \text{ kg/m}^3$
 Ambient Temperature : 23.3 °C; Liquid Temperature : 22.6 °C

DASY5 Configuration:

- Probe: ES3DV3 - SN3293; ConvF(5.53, 5.53, 5.53); Calibrated: 2019.11.25
- Sensor-Surface: 3mm (Mechanical Surface Detection)
- Electronics: DAE4 Sn1338; Calibrated: 2019.11.20
- Phantom: SAM2; Type: SAM; Serial: TP-1503
- Measurement SW: DASY52, Version 52.10 (1); SEMCAD X Version 14.6.11 (7439)

Ch1312/Area Scan (81x71x1): Interpolated grid: $dx=1.500 \text{ mm}$, $dy=1.500 \text{ mm}$

Maximum value of SAR (interpolated) = 1.34 W/kg

Ch1312/Zoom Scan (5x5x7)/Cube 0: Measurement grid: $dx=8\text{mm}$, $dy=8\text{mm}$, $dz=5\text{mm}$

Reference Value = 3.165 V/m; Power Drift = 0.04 dB

Peak SAR (extrapolated) = 1.79 W/kg

SAR(1 g) = 1.04 W/kg; SAR(10 g) = 0.537 W/kg

Maximum value of SAR (measured) = 1.28 W/kg

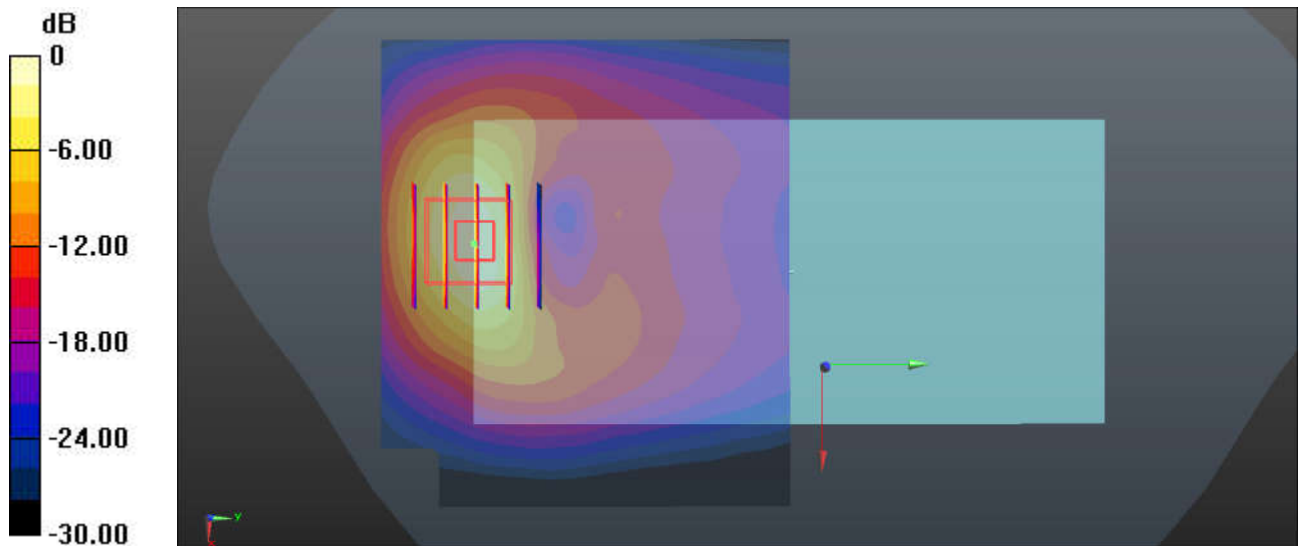

0 dB = 1.34 W/kg = 1.27 dBW/kg

48_WCDMA V_RMC 12.2Kbps_Front_5mm_Headset_Ch4132

Communication System: UID 0, WCDMA (0); Frequency: 826.4 MHz; Duty Cycle: 1:1
 Medium: HSL_835 Medium parameters used: $f = 826.4 \text{ MHz}$; $\sigma = 0.893 \text{ S/m}$; $\epsilon_r = 41.342$; $\rho = 1000 \text{ kg/m}^3$
 Ambient Temperature : $23.2 \text{ }^\circ\text{C}$; Liquid Temperature : $22.8 \text{ }^\circ\text{C}$

DASY5 Configuration:

- Probe: ES3DV3 - SN3293; ConvF(6.39, 6.39, 6.39); Calibrated: 2019.11.25
- Sensor-Surface: 3mm (Mechanical Surface Detection)
- Electronics: DAE4 Sn1338; Calibrated: 2019.11.20
- Phantom: SAM2; Type: SAM; Serial: TP-1503
- Measurement SW: DASY52, Version 52.10 (1); SEMCAD X Version 14.6.11 (7439)

Ch4132/Area Scan (81x71x1): Interpolated grid: $dx=1.500 \text{ mm}$, $dy=1.500 \text{ mm}$

Maximum value of SAR (interpolated) = 1.23 W/kg

Ch4132/Zoom Scan (5x5x7)/Cube 0: Measurement grid: $dx=8\text{mm}$, $dy=8\text{mm}$, $dz=5\text{mm}$

Reference Value = 16.70 V/m ; Power Drift = 0.03 dB

Peak SAR (extrapolated) = 1.97 W/kg

SAR(1 g) = 0.968 W/kg ; SAR(10 g) = 0.515 W/kg

Maximum value of SAR (measured) = 1.27 W/kg

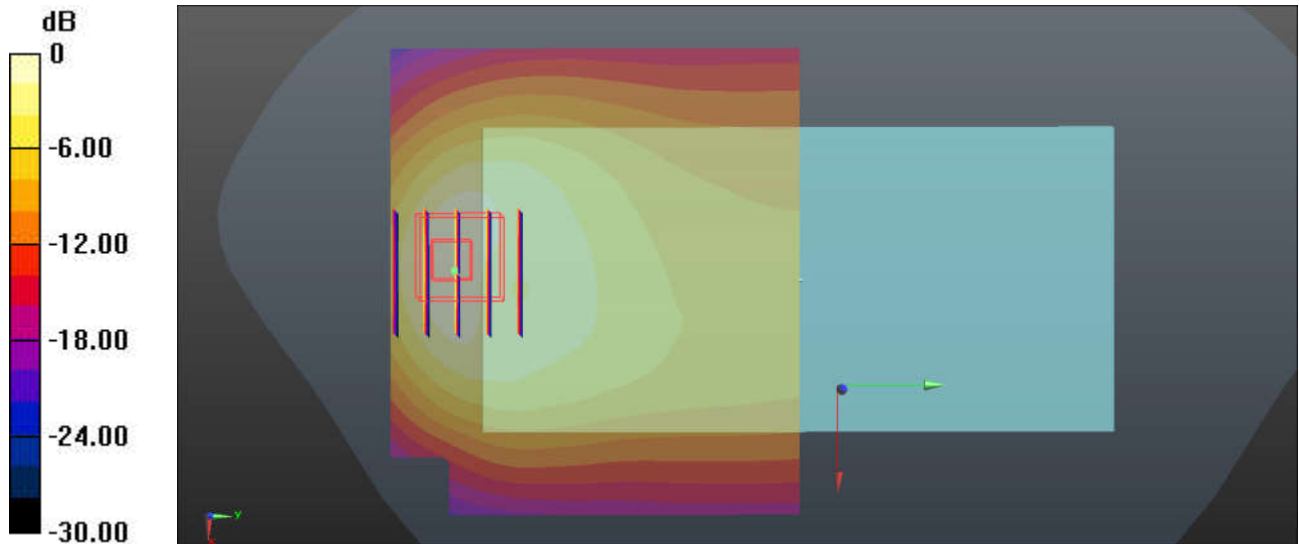

$0 \text{ dB} = 1.23 \text{ W/kg} = 0.90 \text{ dBW/kg}$

49_CDMA2000 BC10_RC3 SO32 (F+SCH) _Front_5mm_Ch476

Communication System: UID 0, CDMA (0); Frequency: 817.9 MHz; Duty Cycle: 1:1
 Medium: HSL_835 Medium parameters used: $f = 818 \text{ MHz}$; $\sigma = 0.892 \text{ S/m}$; $\epsilon_r = 42.993$; $\rho = 1000 \text{ kg/m}^3$
 Ambient Temperature : $23.2 \text{ }^\circ\text{C}$; Liquid Temperature : $22.8 \text{ }^\circ\text{C}$

DASY5 Configuration:

- Probe: ES3DV3 - SN3293; ConvF(6.39, 6.39, 6.39); Calibrated: 2019.11.25
- Sensor-Surface: 3mm (Mechanical Surface Detection)
- Electronics: DAE4 Sn1338; Calibrated: 2019.11.20
- Phantom: SAM2; Type: SAM; Serial: TP-1503
- Measurement SW: DASY52, Version 52.10 (1); SEMCAD X Version 14.6.11 (7439)

Ch476/Area Scan (71x71x1): Interpolated grid: $dx=1.500 \text{ mm}$, $dy=1.500 \text{ mm}$

Maximum value of SAR (interpolated) = 1.08 W/kg

Ch476/Zoom Scan (5x5x7)/Cube 0: Measurement grid: $dx=8\text{mm}$, $dy=8\text{mm}$, $dz=5\text{mm}$

Reference Value = 17.28 V/m ; Power Drift = 0.05 dB

Peak SAR (extrapolated) = 1.95 W/kg

SAR(1 g) = 0.961 W/kg ; SAR(10 g) = 0.520 W/kg

Maximum value of SAR (measured) = 1.24 W/kg

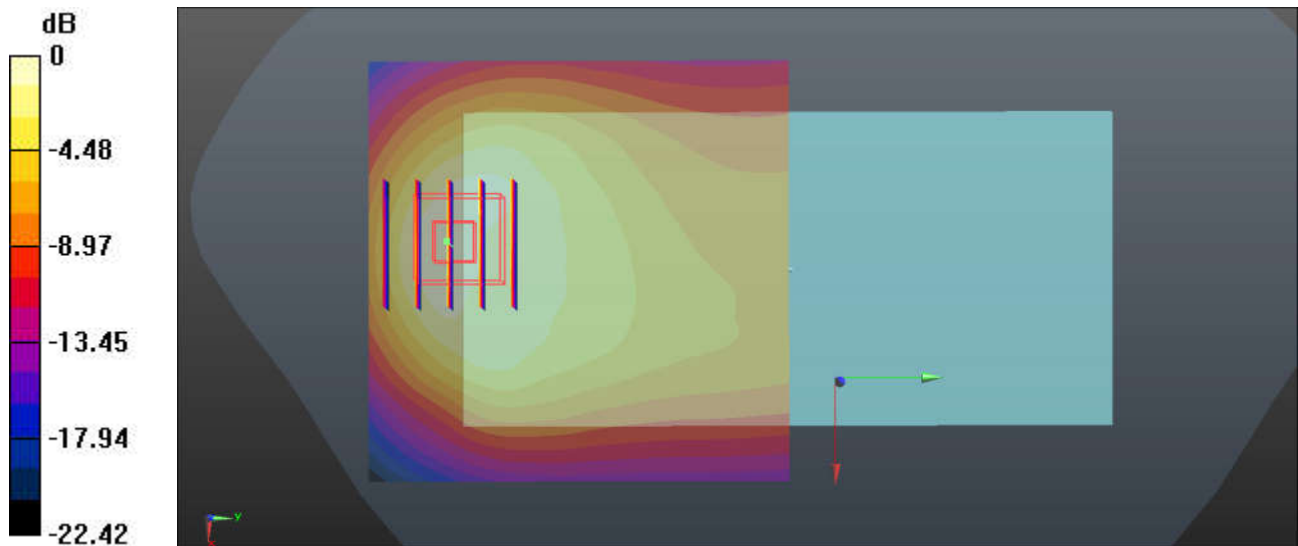

$0 \text{ dB} = 1.08 \text{ W/kg} = 0.33 \text{ dBW/kg}$

50_CDMA2000 BC0_RC3 SO32 (F+SCH) _Front_5mm_Ch1013

Communication System: UID 0, CDMA (0); Frequency: 824.7 MHz; Duty Cycle: 1:1
 Medium: HSL_835 Medium parameters used: $f = 825$ MHz; $\sigma = 0.889$ S/m; $\epsilon_r = 42.914$; $\rho = 1000$ kg/m³
 Ambient Temperature : 23.2 °C; Liquid Temperature : 22.8 °C

DASY5 Configuration:

- Probe: ES3DV3 - SN3293; ConvF(6.39, 6.39, 6.39); Calibrated: 2019.11.25
- Sensor-Surface: 3mm (Mechanical Surface Detection)
- Electronics: DAE4 Sn1338; Calibrated: 2019.11.20
- Phantom: SAM2; Type: SAM; Serial: TP-1503
- Measurement SW: DASY52, Version 52.10 (1); SEMCAD X Version 14.6.11 (7439)

Ch1013/Area Scan (71x71x1): Interpolated grid: dx=1.500 mm, dy=1.500 mm

Maximum value of SAR (interpolated) = 1.27 W/kg

Ch1013/Zoom Scan (5x5x7)/Cube 0: Measurement grid: dx=8mm, dy=8mm, dz=5mm

Reference Value = 19.37 V/m; Power Drift = -0.09 dB

Peak SAR (extrapolated) = 2.30 W/kg

SAR(1 g) = 1.14 W/kg; SAR(10 g) = 0.611 W/kg

Maximum value of SAR (measured) = 1.40 W/kg

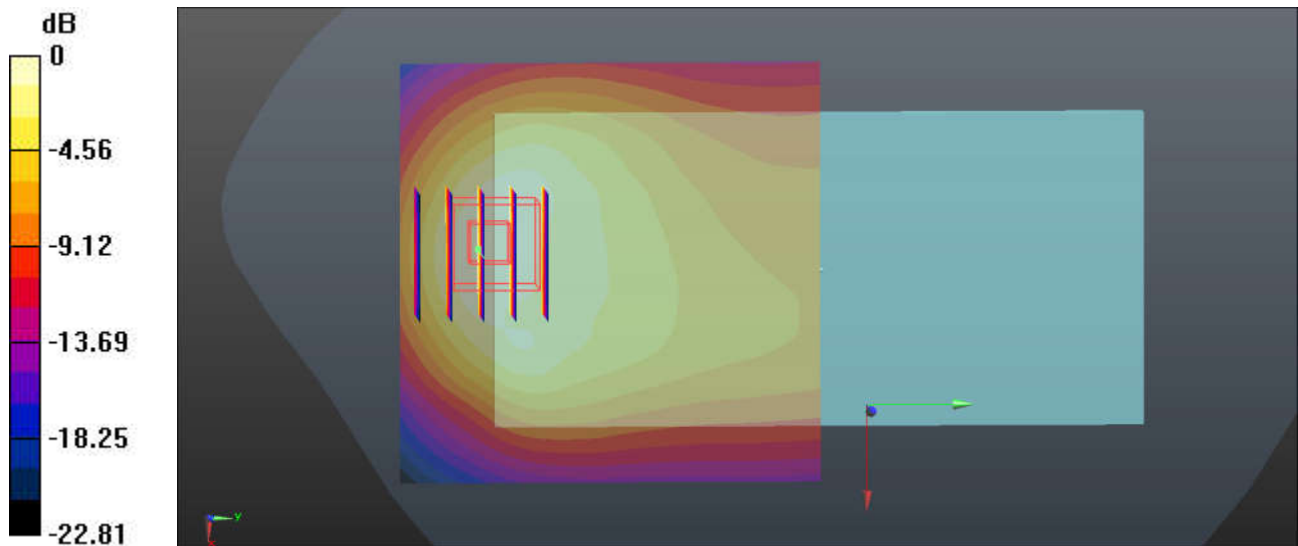

0 dB = 1.27 W/kg = 1.04 dBW/kg

51_CDMA2000 BC1_20M_RTAP 153.6Kbps_Back_5mm_Ch600

Communication System: UID 0, CDMA (0); Frequency: 1880 MHz; Duty Cycle: 1:1
Medium: HSL_1900 Medium parameters used: $f = 1880$ MHz; $\sigma = 1.381$ S/m; $\epsilon_r = 40.134$; $\rho = 1000$ kg/m³
Ambient Temperature : 23.3 °C; Liquid Temperature : 22.8 °C

DASY5 Configuration:

- Probe: ES3DV3 - SN3293; ConvF(5.32, 5.32, 5.32); Calibrated: 2019.11.25
- Sensor-Surface: 3mm (Mechanical Surface Detection)
- Electronics: DAE4 Sn1338; Calibrated: 2019.11.20
- Phantom: SAM2; Type: SAM; Serial: TP-1503
- Measurement SW: DASY52, Version 52.10 (1); SEMCAD X Version 14.6.11 (7439)

Ch600/Area Scan (81x71x1): Interpolated grid: dx=1.500 mm, dy=1.500 mm

Maximum value of SAR (interpolated) = 1.76 W/kg

Ch600/Zoom Scan (5x5x7)/Cube 0: Measurement grid: dx=8mm, dy=8mm, dz=5mm

Reference Value = 2.621 V/m; Power Drift = -0.05 dB

Peak SAR (extrapolated) = 2.27 W/kg

SAR(1 g) = 1.22 W/kg; SAR(10 g) = 0.606 W/kg

Maximum value of SAR (measured) = 1.52 W/kg

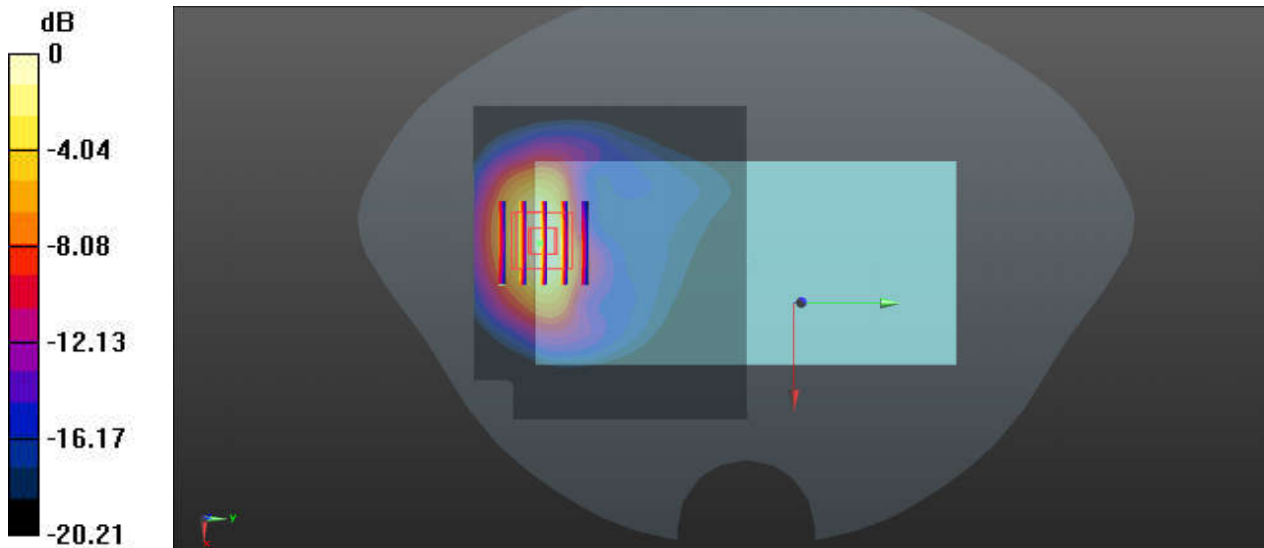

0 dB = 1.52 W/kg = 1.82 dBW/kg

52_LTE Band 7_20M_QPSK_50RB_0Offset_Back_5mm_Ch20850

Communication System: UID 0, LTE-FDD (0); Frequency: 2510 MHz; Duty Cycle: 1:1
Medium: HSL_2600 Medium parameters used: $f = 2510$ MHz; $\sigma = 1.93$ S/m; $\epsilon_r = 38.651$; $\rho = 1000$ kg/m³
Ambient Temperature : 23.3 °C; Liquid Temperature : 22.9 °C

DASY5 Configuration:

- Probe: ES3DV3 - SN3293; ConvF(4.39, 4.39, 4.39); Calibrated: 2019.11.25
- Sensor-Surface: 3mm (Mechanical Surface Detection)
- Electronics: DAE4 Sn1338; Calibrated: 2019.11.20
- Phantom: SAM2; Type: SAM; Serial: TP-1503
- Measurement SW: DASY52, Version 52.10 (1); SEMCAD X Version 14.6.11 (7439)

Ch20850/Area Scan (91x91x1): Interpolated grid: dx=1.200 mm, dy=1.200 mm

Maximum value of SAR (interpolated) = 1.78 W/kg

Ch20850/Zoom Scan (7x7x7)/Cube 0: Measurement grid: dx=5mm, dy=5mm, dz=5mm

Reference Value = 8.832 V/m; Power Drift = 0.03 dB

Peak SAR (extrapolated) = 2.97 W/kg

SAR(1 g) = 1.33 W/kg; SAR(10 g) = 0.629 W/kg

Maximum value of SAR (measured) = 1.70 W/kg

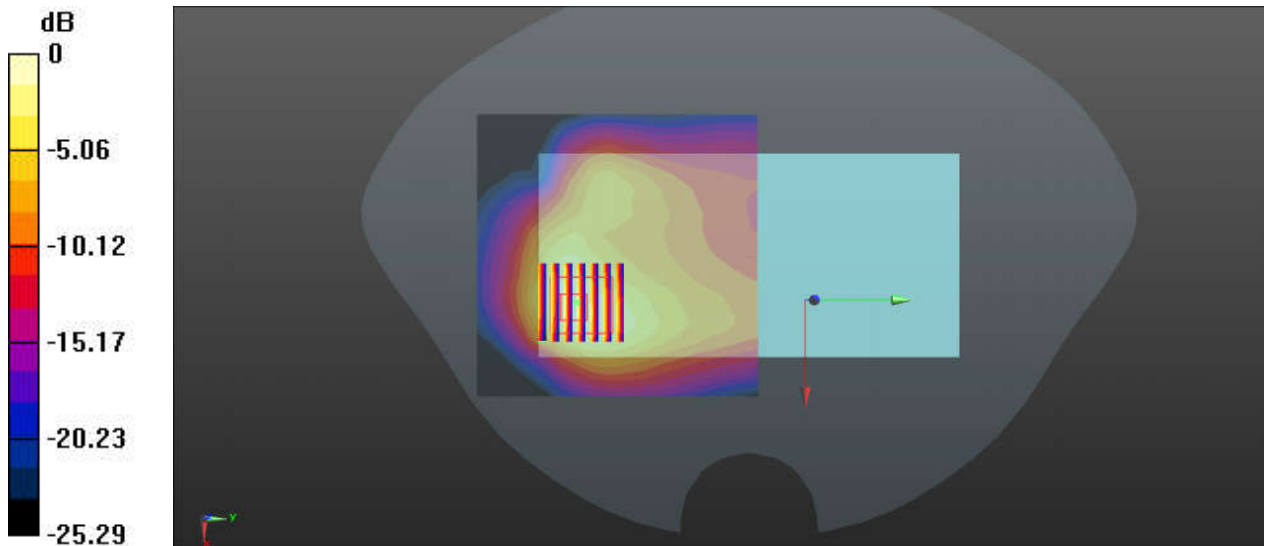

0 dB = 1.70 W/kg = 2.30 dBW/kg

53_LTE Band 12_10M_QPSK_1RB_49Offset_Front_5mm_Ch23095

Communication System: UID 0, LTE-FDD (0); Frequency: 707.5 MHz; Duty Cycle: 1:1
 Medium: HSL_750 Medium parameters used: $f = 707.5$ MHz; $\sigma = 0.852$ S/m; $\epsilon_r = 42.279$; $\rho = 1000$ kg/m³
 Ambient Temperature : 23.2 °C; Liquid Temperature : 22.9 °C

DASY5 Configuration:

- Probe: ES3DV3 - SN3293; ConvF(6.56, 6.56, 6.56); Calibrated: 2019.11.25
- Sensor-Surface: 3mm (Mechanical Surface Detection)
- Electronics: DAE4 Sn1338; Calibrated: 2019.11.20
- Phantom: SAM2; Type: SAM; Serial: TP-1503
- Measurement SW: DASY52, Version 52.10 (1); SEMCAD X Version 14.6.11 (7439)

Ch23095/Area Scan (81x71x1): Interpolated grid: dx=1.500 mm, dy=1.500 mm

Maximum value of SAR (interpolated) = 0.949 W/kg

Ch23095/Zoom Scan (6x5x7)/Cube 0: Measurement grid: dx=8mm, dy=8mm, dz=5mm

Reference Value = 20.09 V/m; Power Drift = 0.09 dB

Peak SAR (extrapolated) = 1.49 W/kg

SAR(1 g) = 0.730 W/kg; SAR(10 g) = 0.409 W/kg

Maximum value of SAR (measured) = 0.890 W/kg

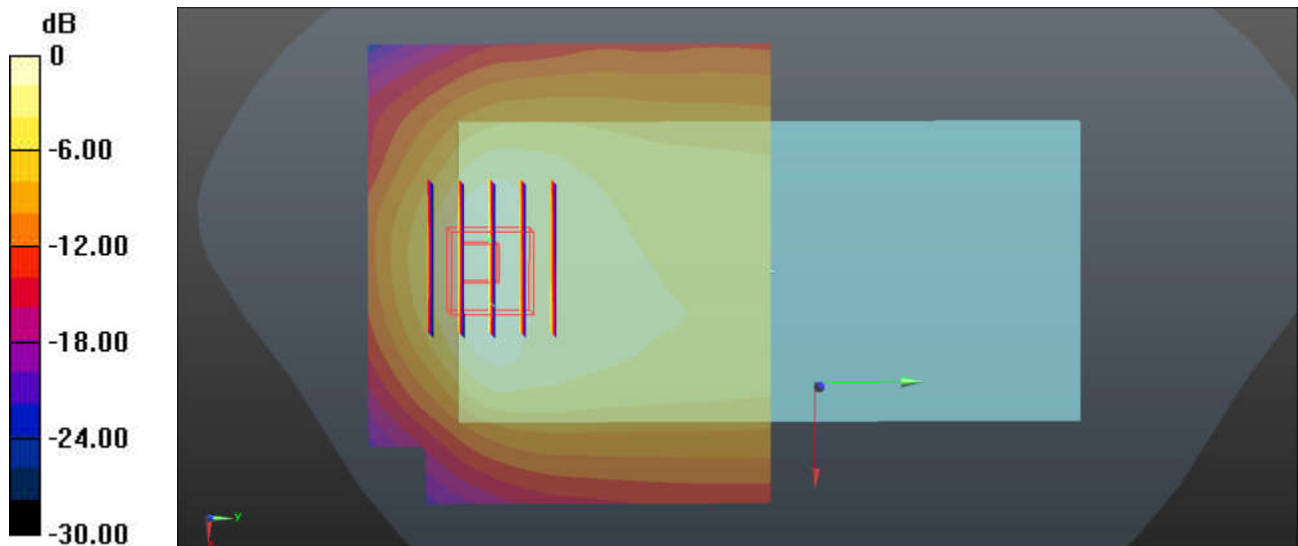

0 dB = 0.949 W/kg = -0.23 dBW/kg

54_LTE Band 13_10M_QPSK_1RB_0Offset_Front_5mm_Ch23230

Communication System: UID 0, LTE-FDD (0); Frequency: 782 MHz; Duty Cycle: 1:1
 Medium: HSL_750 Medium parameters used: $f = 782 \text{ MHz}$; $\sigma = 0.923 \text{ S/m}$; $\epsilon_r = 41.305$; $\rho = 1000 \text{ kg/m}^3$
 Ambient Temperature : $23.2 \text{ }^\circ\text{C}$; Liquid Temperature : $22.9 \text{ }^\circ\text{C}$

DASY5 Configuration:

- Probe: ES3DV3 - SN3293; ConvF(6.56, 6.56, 6.56); Calibrated: 2019.11.25
- Sensor-Surface: 3mm (Mechanical Surface Detection)
- Electronics: DAE4 Sn1338; Calibrated: 2019.11.20
- Phantom: SAM2; Type: SAM; Serial: TP-1503
- Measurement SW: DASY52, Version 52.10 (1); SEMCAD X Version 14.6.11 (7439)

Ch23230/Area Scan (81x71x1): Interpolated grid: $dx=1.500 \text{ mm}$, $dy=1.500 \text{ mm}$
 Maximum value of SAR (interpolated) = 1.52 W/kg

Ch23230/Zoom Scan (6x6x7)/Cube 0: Measurement grid: $dx=8\text{mm}$, $dy=8\text{mm}$, $dz=5\text{mm}$
 Reference Value = 23.23 V/m ; Power Drift = -0.07 dB
 Peak SAR (extrapolated) = 2.42 W/kg
SAR(1 g) = 1.18 W/kg ; SAR(10 g) = 0.629 W/kg
 Maximum value of SAR (measured) = 1.53 W/kg

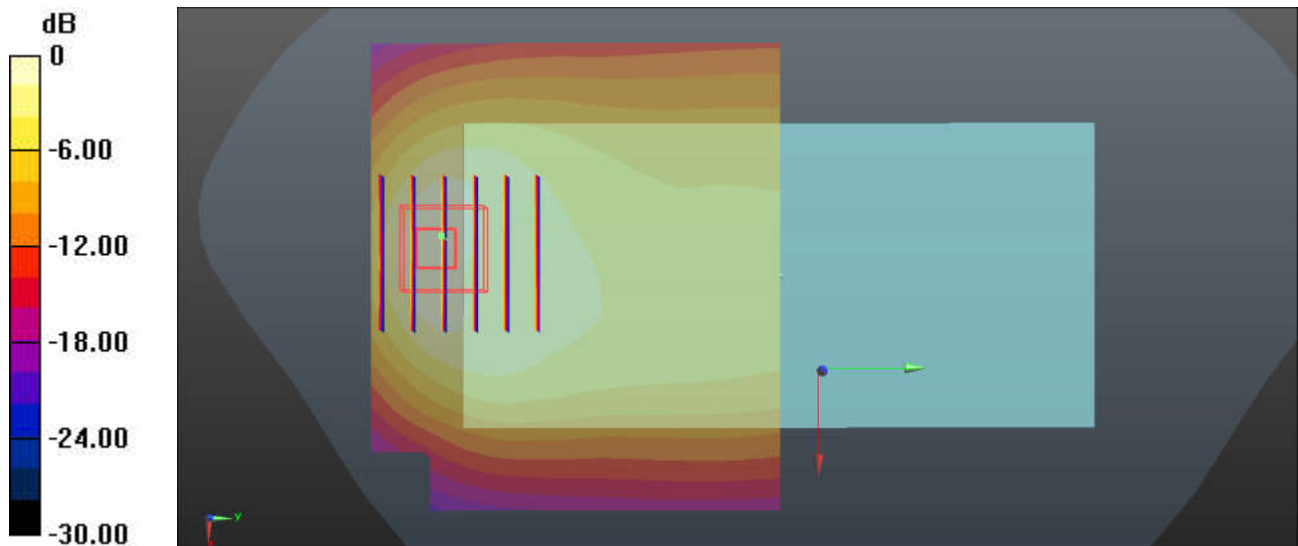

$0 \text{ dB} = 1.52 \text{ W/kg} = 1.82 \text{ dBW/kg}$