



# FCC RF Test Report

**APPLICANT** : Motorola Mobility LLC  
**EQUIPMENT** : Mobile Phone  
**BRAND NAME** : Motorola  
**MODEL NAME** : XT2029-1  
**FCC ID** : IHDT56YM1  
**STANDARD** : 47 CFR Part 2, 22(H), 24(E), 27(L), 27(M)  
**CLASSIFICATION** : PCS Licensed Transmitter Held to Ear (PCE)

The product was received on Jul. 29, 2019 and completely tested on Aug. 13, 2019. We, Sporton International (Kunshan) Inc., would like to declare that the tested sample has been evaluated in accordance with the procedures given in ANSI C63.26-2015 and shown compliance with the applicable technical standards.

The test results in this report apply exclusively to the tested model / sample. Without written approval of Sporton International (Kunshan) Inc., the test report shall not be reproduced except in full.

Reviewed by: Jason Jia / Supervisor

Approved by: James Huang / Manager



**Sporton International (Kunshan) Inc.**

**No. 1098, Pengxi North Road, Kunshan Economic Development Zone Jiangsu Province 215300  
People's Republic of China**



TABLE OF CONTENTS

REVISION HISTORY...3
SUMMARY OF TEST RESULT...4
1 GENERAL DESCRIPTION...5
1.1 Applicant...5
1.2 Manufacturer...5
1.3 Product Feature of Equipment Under Test...5
1.4 Product Specification of Equipment Under Test...6
1.5 Specification of Accessory...7
1.6 Modification of EUT...7
1.7 Maximum ERP/EIRP Power, Frequency Tolerance, and Emission Designator...8
1.8 Testing Location...9
1.9 Applicable Standards...9
2 TEST CONFIGURATION OF EQUIPMENT UNDER TEST...10
2.1 Test Mode...10
2.2 Connection Diagram of Test System...12
2.3 Support Unit used in test configuration and system...13
2.4 Measurement Results Explanation Example...13
2.5 Frequency List of Low/Middle/High Channels...14
3 CONDUCTED TEST ITEMS...16
3.1 Measuring Instruments...16
3.2 Test Setup...16
3.3 Test Result of Conducted Test...16
3.4 Conducted Output Power and ERP/EIRP...17
3.5 Peak-to-Average Ratio...18
3.6 Occupied Bandwidth...19
3.7 Conducted Band Edge...20
3.8 Conducted Spurious Emission...22
3.9 Frequency Stability...23
4 RADIATED TEST ITEMS...24
4.1 Measuring Instruments...24
4.2 Test Setup...24
4.3 Test Result of Radiated Test...24
4.4 Radiated Spurious Emission...25
5 LIST OF MEASURING EQUIPMENT...26
6 UNCERTAINTY OF EVALUATION...27
APPENDIX A. TEST RESULTS OF CONDUCTED TEST
APPENDIX B. TEST RESULTS OF RADIATED TEST
APPENDIX C. TEST SETUP PHOTOGRAPHS





## SUMMARY OF TEST RESULT

Report Section	FCC Rule	Description	Limit	Result	Remark
3.4	§2.1046	Conducted Output Power	Reporting Only	PASS	-
	§22.913(a)(5)	Effective Radiated Power (Band 5)	ERP < 7 Watt		
	§24.232(c) §27.50(h)(2)	Equivalent Isotropic Radiated Power (Band 2) (Band 7)	EIRP < 2Watt		
	§27.50(d)(4)	Equivalent Isotropic Radiated Power (Band 4)	EIRP < 1Watt		
3.5	§24.232(d)	Peak-to-Average Ratio	<13 dB	PASS	-
3.6	§2.1049	Occupied Bandwidth	Reporting Only	PASS	-
3.7	§2.1051 §22.917(a) §24.238(a) §27.53(h)	Conducted Band Edge Measurement (Band 2) (Band 4) (Band 5)	< 43+10log <sub>10</sub> (P[Watts])	PASS	-
	§27.53(m)(4)	Conducted Band Edge Measurement (Band 7)	§27.53(m)(4)		
3.8	§2.1051 §22.917(a) §24.238(a) §27.53(h)	Conducted Spurious Emission (Band 2) (Band 4) (Band 5)	< 43+10log <sub>10</sub> (P[Watts])	PASS	-
	§2.1051 §27.53(m)(4)	Conducted Spurious Emission (Band 7)	< 55+10log <sub>10</sub> (P[Watts])		
3.9	§2.1055 §22.355	Frequency Stability Temperature & Voltage	< 2.5 ppm for Part 22	PASS	-
	§2.1055 §24.235 §27.54		Within Authorized Band		
4.4	§2.1053 §22.917(a) §24.238(a) §27.53(h)	Radiated Spurious Emission (Band 2) (Band 4) (Band 5)	< 43+10log <sub>10</sub> (P[Watts])	PASS	Under limit 12.37 dB at 7580.000 MHz
	§2.1053 §27.53(m)(4)	Radiated Spurious Emission (Band 7)	< 55+10log <sub>10</sub> (P[Watts])		



# 1 General Description

## 1.1 Applicant

Motorola Mobility LLC  
222 W, Merchandise Mart Plaza, Chicago, IL60654 USA

## 1.2 Manufacturer

Motorola Mobility LLC  
222 W, Merchandise Mart Plaza, Chicago, IL60654 USA

## 1.3 Product Feature of Equipment Under Test

Product Feature	
Equipment	Mobile Phone
Brand Name	Motorola
Model Name	XT2029-1
FCC ID	IHDT56YM1
EUT supports Radios application	GSM/WCDMA/LTE WLAN 2.4GHz 802.11b/g/n HT20 Bluetooth BR/EDR/LE FM Receiver and GNSS
IMEI Code	Conducted:N/A Radiation: 357245100002534
HW Version	M3901-P
SW Version	POA29.101
EUT Stage	Identical Prototype



### 1.4 Product Specification of Equipment Under Test

Standards-related Product Specification	
<b>Tx Frequency</b>	LTE Band 2 : 1850.7 MHz ~ 1909.3 MHz LTE Band 4 : 1710.7 MHz ~ 1754.3 MHz LTE Band 5 : 824.7 MHz ~ 848.3 MHz LTE Band 7 : 2502.5 MHz ~ 2567.5 MHz
<b>Rx Frequency</b>	LTE Band 2 : 1930.7 MHz ~ 1989.3 MHz LTE Band 4 : 2110.7 MHz ~ 2154.3 MHz LTE Band 5 : 869.7 MHz ~ 893.3 MHz LTE Band 7 : 2622.5MHz ~ 2687.5 MHz
<b>Bandwidth</b>	LTE Band 2 : 1.4MHz / 3MHz / 5MHz / 10MHz / 15MHz / 20MHz LTE Band 4 : 1.4MHz / 3MHz / 5MHz / 10MHz / 15MHz / 20MHz LTE Band 5 : 1.4MHz / 3MHz / 5MHz / 10MHz LTE Band 7 : 5MHz / 10MHz / 15MHz / 20MHz
<b>Maximum Output Power to Antenna</b>	LTE Band 2 : 23.16 dBm LTE Band 4 : 23.35 dBm LTE Band 5 : 23.68 dBm LTE Band 7 : 23.17 dBm
<b>Antenna Gain</b>	LTE Band 2 : 0.19 dBi LTE Band 4 : 0.19 dBi LTE Band 5 : -1.53 dBi LTE Band 7 : -0.45 dBi
<b>Type of Modulation</b>	QPSK / 16QAM



## 1.5 Specification of Accessory

Specification of Accessory				
AC Adapter 1(US)	Brand Name	Motorola (Acbel)	Model Name	SC-61
	Power Rating	I/P: 100-240 Vac, 0.13A, 50/60Hz; O/P: 5Vdc,1A		
AC Adapter 1(AR)	Brand Name	Motorola (Acbel)	Model Name	SC-64
	Power Rating	I/P: 100-240 Vac, 0.13A, 50/60Hz; O/P: 5Vdc,1A		
AC Adapter 1(Chile)	Brand Name	Motorola (Acbel)	Model Name	SC-62
	Power Rating	I/P: 100-240 Vac, 0.13A, 50/60Hz; O/P: 5Vdc,1A		
AC Adapter 2(US)	Brand Name	Motorola (Chenyang)	Model Name	SC-61
	Power Rating	I/P: 100-240 Vac, 0.13A, 50/60Hz; O/P: 5Vdc,1A		
AC Adapter 2(AR)	Brand Name	Motorola (Chenyang)	Model Name	SC-64
	Power Rating	I/P: 100-240 Vac, 0.13A, 50/60Hz; O/P: 5Vdc,1A		
Battery 1	Brand Name	Motorola(ATL)	Model Name	KS40
	Power Rating	4.4Vdc,3000mAh	Type	Li-ion
Battery 2	Brand Name	Motorola(Sunwoda)	Model Name	KS40
	Power Rating	4.4Vdc,3000mAh	Type	Li-ion
Earphone	Brand Name	Juwei Electronctcs Co ., LTD	Model Name	JWEP1131-ZN01
	Signal Line Type	1.10 meter, non-shielded cable, without ferrite core		
USB Cable	Brand Name	Li Qi Electronics	Model Name	LQ048018
	Signal Line Type	1.0 meter, shielded cable, without ferrite core		

## 1.6 Modification of EUT

No modifications are made to the EUT during all test items.



### 1.7 Maximum ERP/EIRP Power, Frequency Tolerance, and Emission Designator

LTE Band 2		QPSK			16QAM		
BW (MHz)	Frequency Range (MHz)	Emission Designator (99%OBW)	Frequency Tolerance (ppm)	Maximum EIRP(W)	Emission Designator (99%OBW)	Frequency Tolerance (ppm)	Maximum EIRP(W)
1.4	1850.7 ~ 1909.3	1M10G7D	-	0.2138	1M09W7D	-	0.1820
3	1851.5 ~ 1908.5	2M71G7D	-	0.2118	2M72W7D	-	0.1820
5	1852.5 ~ 1907.5	4M53G7D	-	0.2148	4M50W7D	-	0.1862
10	1855.0 ~ 1905.0	9M05G7D	0.0025	0.2128	9M09W7D	-	0.1832
15	1857.5 ~ 1902.5	13M5G7D	-	0.2158	13M6W7D	-	0.1854
20	1860.0 ~ 1900.0	18M6G7D	-	0.2163	18M5W7D	-	0.1791
LTE Band 4		QPSK			16QAM		
BW (MHz)	Frequency Range (MHz)	Emission Designator (99%OBW)	Frequency Tolerance (ppm)	Maximum EIRP(W)	Emission Designator (99%OBW)	Frequency Tolerance (ppm)	Maximum EIRP(W)
1.4	1710.7 ~ 1754.3	1M10G7D	-	0.2249	1M10W7D	-	0.1858
3	1711.5 ~ 1753.5	2M72G7D	-	0.2193	2M71W7D	-	0.1828
5	1712.5 ~ 1752.5	4M52G7D	-	0.2234	4M54W7D	-	0.1888
10	1715.0 ~ 1750.0	9M07G7D	0.0029	0.2234	9M07W7D	-	0.1862
15	1717.5 ~ 1747.5	13M5G7D	-	0.2203	13M5W7D	-	0.1892
20	1720.0 ~ 1745.0	18M6G7D	-	0.2259	18M5W7D	-	0.1871
LTE Band 5		QPSK			16QAM		
BW (MHz)	Frequency Range (MHz)	Emission Designator (99%OBW)	Frequency Tolerance (ppm)	Maximum ERP(W)	Emission Designator (99%OBW)	Frequency Tolerance (ppm)	Maximum ERP(W)
1.4	824.7 ~ 848.3	1M09G7D	-	0.0977	1M10W7D	-	0.0815
3	825.5 ~ 847.5	2M72G7D	-	0.0948	2M70W7D	-	0.0800
5	826.5 ~ 846.5	4M51G7D	-	0.0998	4M53W7D	-	0.0830
10	829.0 ~ 844.0	9M11G7D	0.0060	0.1000	9M07W7D	-	0.0817
LTE Band 7		QPSK			16QAM		
BW (MHz)	Frequency Range (MHz)	Emission Designator (99%OBW)	Frequency Tolerance (ppm)	Maximum EIRP(W)	Emission Designator (99%OBW)	Frequency Tolerance (ppm)	Maximum EIRP(W)
5	2502.5 ~ 2567.5	4M51G7D	-	0.1841	4M52W7D	-	0.1581
10	2505.0 ~ 2565.0	9M07G7D	0.0032	0.1824	9M07W7D	-	0.1524
15	2507.5 ~ 2562.5	13M5G7D	-	0.1841	13M5W7D	-	0.1538
20	2510.0 ~ 2560.0	18M3G7D	-	0.1871	18M5W7D	-	0.1560



### 1.8 Testing Location

Sporton International (Kunshan) Inc. is accredited to ISO/IEC 17025:2017 by American Association for Laboratory Accreditation with Certificate Number 5145.02.

<b>Test Firm</b>	Sporton International (Kunshan) Inc.		
<b>Test Site Location</b>	No. 1098, Pengxi North Road, Kunshan Economic Development Zone Jiangsu Province 215300 People's Republic of China TEL : +86-512-57900158 FAX : +86-512-57900958		
<b>Test Site No.</b>	<b>Sporton Site No.</b>	<b>FCC Designation No.</b>	<b>FCC Test Firm Registration No.</b>
	TH01-KS 03CH04-KS	CN1257	314309

### 1.9 Applicable Standards

According to the specifications of the manufacturer, the EUT must comply with the requirements of the following standards:

- ♦ 47 CFR Part 2, 22(H), 24(E), 27(L), 27(M)
- ♦ ANSI C63.26-2015
- ♦ FCC KDB 971168 D01 Power Meas License Digital Systems v03r01
- ♦ FCC KDB 412172 D01 Determining ERP and EIRP v01r01

**Remark:**

1. All test items were verified and recorded according to the standards and without any deviation during the test.
2. This EUT has also been tested and complied with the requirements of FCC Part 15, Subpart B, recorded in a separate test report.



## 2 Test Configuration of Equipment Under Test

### 2.1 Test Mode

Antenna port conducted and radiated test items listed below are performed according to KDB 971168 D01 Power Meas License Digital Systems v03r01 with maximum output power.

Radiated measurements are performed by rotating the EUT in three different orthogonal test planes to find the maximum emission.

Test Items	Band	Bandwidth (MHz)						Modulation			RB #			Test Channel		
		1.4	3	5	10	15	20	QPSK	16QAM	64QAM	1	Half	Full	L	M	H
Max. Output Power	2	v	v	v	v	v	v	v	v		v	v	v	v	v	v
	4	v	v	v	v	v	v	v	v		v	v	v	v	v	v
	5	v	v	v	v	-	-	v	v		v	v	v	v	v	v
	7	-	-	v	v	v	v	v	v		v	v	v	v	v	v
Peak-to-Average Ratio	2						v	v	v		v		v	v	v	v
	4						v	v	v		v		v	v	v	v
	5				v	-	-	v	v		v		v	v	v	v
	7	-	-				v	v	v		v		v	v	v	v
26dB and 99% Bandwidth	2	v	v	v	v	v	v	v	v				v	v	v	v
	4	v	v	v	v	v	v	v	v				v	v	v	v
	5	v	v	v	v	-	-	v	v				v	v	v	v
	7	-	-	v	v	v	v	v	v				v	v	v	v
Conducted Band Edge	2	v	v	v	v	v	v	v	v		v		v	v		v
	4	v	v	v	v	v	v	v	v		v		v	v		v
	5	v	v	v	v	-	-	v	v		v		v	v		v
	7	-	-	v	v	v	v	v	v		v		v	v		v



Test Items	Band	Bandwidth (MHz)						Modulation			RB #			Test Channel		
		1.4	3	5	10	15	20	QPSK	16QAM	64QAM	1	Half	Full	L	M	H
Conducted Spurious Emission	2	v	v	v	v	v	v	v	v		v			v	v	v
	4	v	v	v	v	v	v	v	v		v			v	v	v
	5	v	v	v	v	-	-	v	v		v			v	v	v
	7	-	-	v	v	v	v	v	v		v			v	v	v
Frequency Stability	2				v			v					v		v	
	4				v			v					v		v	
	5				v	-	-	v					v		v	
	7	-	-		v			v					v		v	
E.R.P / E.I.R.P	2	v	v	v	v	v	v	v	v		v			v	v	v
	4	v	v	v	v	v	v	v	v		v			v	v	v
	5	v	v	v	v	-	-	v	v		v			v	v	v
	7	-	-	v	v	v	v	v	v		v			v	v	v
Radiated Spurious Emission	2	Worst Case											v	v	v	
	4	Worst Case											v	v	v	
	5	Worst Case											v	v	v	
	7	Worst Case											v	v	v	
Note	1. The mark "v" means that this configuration is chosen for testing 2. The mark "-" means that this bandwidth is not supported. 3. The device is investigated from 30MHz to 10 times of fundamental signal for radiated spurious emission test under different RB size/offset and modulations in exploratory test. Subsequently, only the worst case emissions are reported.															

## 2.2 Connection Diagram of Test System

LTE Band 2/4/7

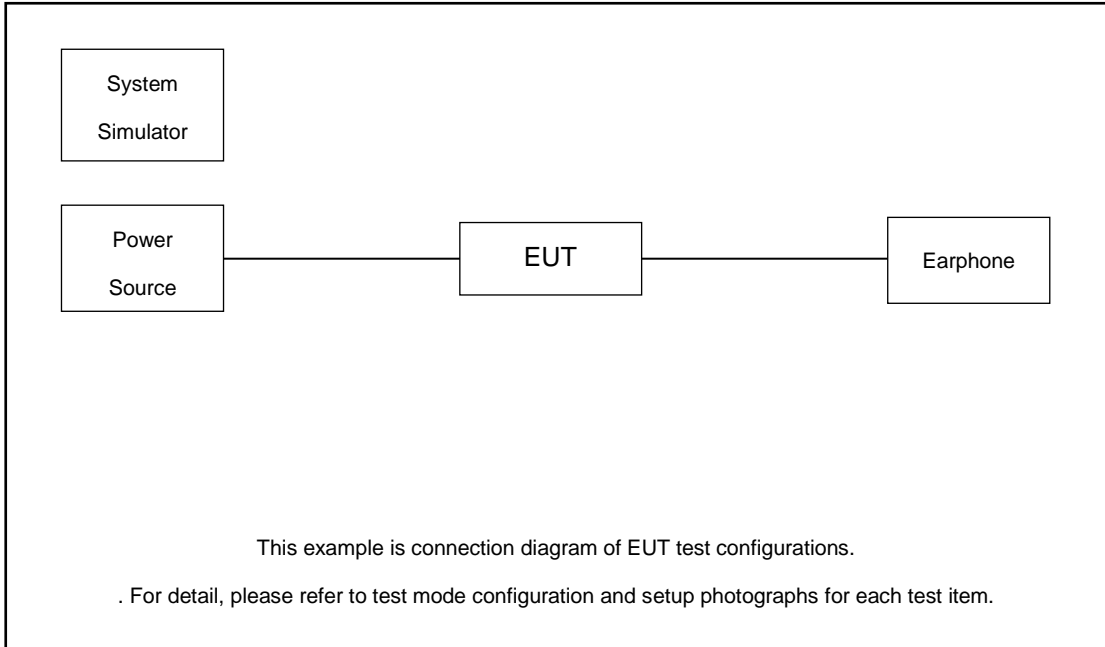

LTE Band 5

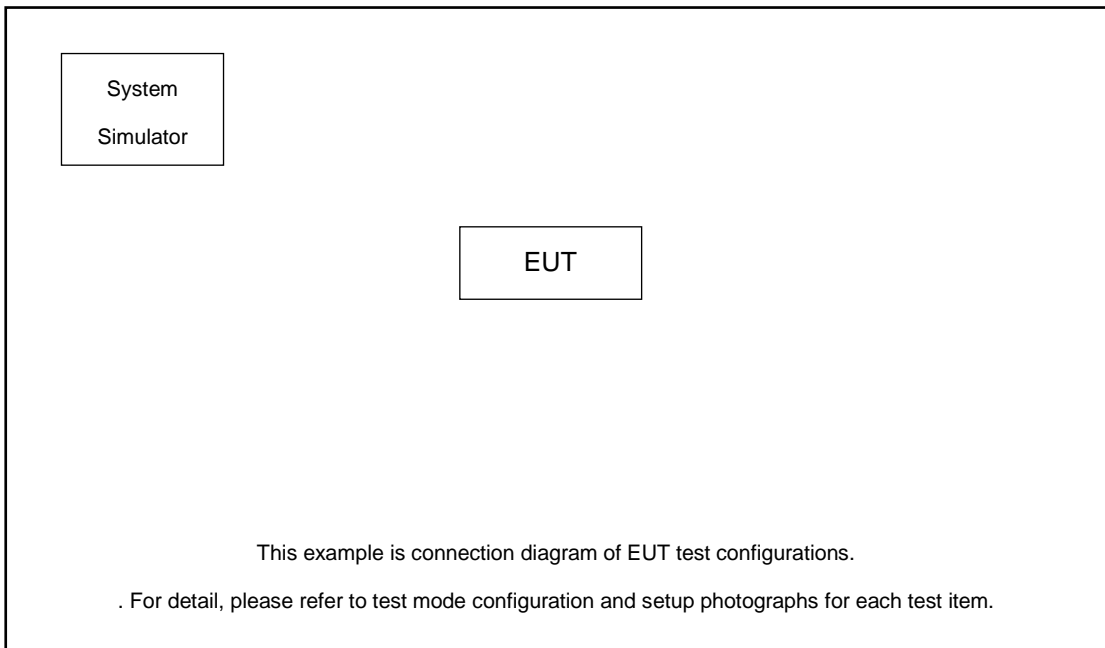



### 2.3 Support Unit used in test configuration and system

Item	Equipment	Trade Name	Model No.	FCC ID	Data Cable	Power Cord
1.	LTE Base Station	Anritsu	MT8820C	N/A	N/A	Unshielded, 1.8 m
2.	DC Power Supply	GW INSTEK	GPS-3030D	N/A	N/A	Unshielded, 1.8m

### 2.4 Measurement Results Explanation Example

For all conducted test items:

The offset level is set in the spectrum analyzer to compensate the RF cable loss between EUT conducted output port and spectrum analyzer. With the offset compensation, the spectrum analyzer reading level is exactly the EUT RF output level.

The spectrum analyzer offset is derived from RF cable loss

$$\text{Offset} = \text{RF cable loss}$$

Following shows an offset computation example with cable loss 5.4 dB

Example :

$$\begin{aligned} \text{Offset(dB)} &= \text{RF cable loss(dB)} \\ &= 5.4 \text{ (dB)} \end{aligned}$$



### 2.5 Frequency List of Low/Middle/High Channels

LTE Band 2 Channel and Frequency List				
BW [MHz]	Channel/Frequency(MHz)	Lowest	Middle	Highest
20	Channel	18700	18900	19100
	Frequency	1860	1880	1900
15	Channel	18675	18900	19125
	Frequency	1857.5	1880	1902.5
10	Channel	18650	18900	19150
	Frequency	1855	1880	1905
5	Channel	18625	18900	19175
	Frequency	1852.5	1880	1907.5
3	Channel	18615	18900	19185
	Frequency	1851.5	1880	1908.5
1.4	Channel	18607	18900	19193
	Frequency	1850.7	1880	1909.3

LTE Band 4 Channel and Frequency List				
BW [MHz]	Channel/Frequency(MHz)	Lowest	Middle	Highest
20	Channel	20050	20175	20300
	Frequency	1720	1732.5	1745
15	Channel	20025	20175	20325
	Frequency	1717.5	1732.5	1747.5
10	Channel	20000	20175	20350
	Frequency	1715	1732.5	1750
5	Channel	19975	20175	20375
	Frequency	1712.5	1732.5	1752.5
3	Channel	19965	20175	20385
	Frequency	1711.5	1732.5	1753.5
1.4	Channel	19957	20175	20393
	Frequency	1710.7	1732.5	1754.3



LTE Band 5 Channel and Frequency List				
BW [MHz]	Channel/Frequency(MHz)	Lowest	Middle	Highest
10	Channel	20450	20525	20600
	Frequency	829	836.5	844
5	Channel	20425	20525	20625
	Frequency	826.5	836.5	846.5
3	Channel	20415	20525	20635
	Frequency	825.5	836.5	847.5
1.4	Channel	20407	20525	20643
	Frequency	824.7	836.5	848.3

LTE Band 7 Channel and Frequency List				
BW [MHz]	Channel/Frequency(MHz)	Lowest	Middle	Highest
20	Channel	20850	21100	21350
	Frequency	2510	2535	2560
15	Channel	20825	21100	21375
	Frequency	2507.5	2535	2562.5
10	Channel	20800	21100	21400
	Frequency	2505	2535	2565
5	Channel	20775	21100	21425
	Frequency	2502.5	2535	2567.5

### 3 Conducted Test Items

#### 3.1 Measuring Instruments

See list of measuring instruments of this test report.

#### 3.2 Test Setup

##### 3.2.1 Conducted Output Power

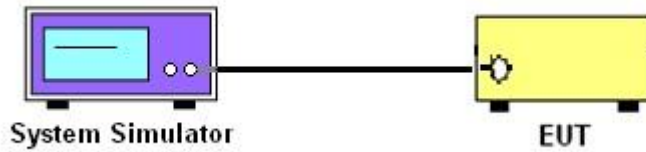

##### 3.2.2 Peak-to-Average Ratio, Occupied Bandwidth ,Conducted Band-Edge and Conducted Spurious Emission

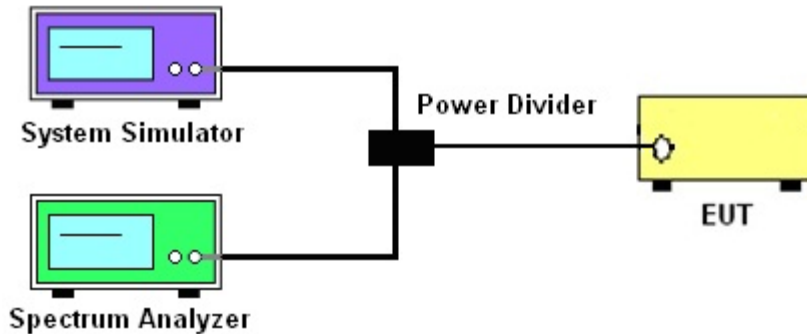

##### 3.2.3 Frequency Stability

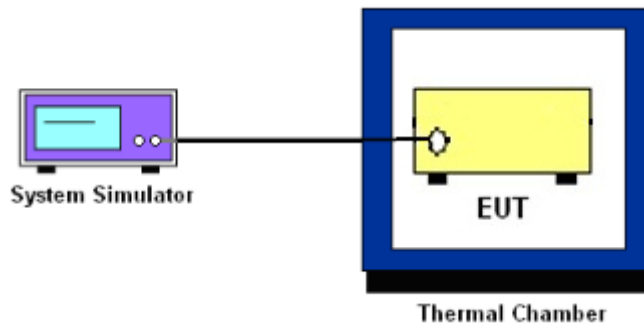

### 3.3 Test Result of Conducted Test

Please refer to Appendix A.



### 3.4 Conducted Output Power and ERP/EIRP

#### 3.4.1 Description of the Conducted Output Power Measurement and ERP/EIRP Measurement

A system simulator was used to establish communication with the EUT. Its parameters were set to force the EUT transmitting at maximum output power. The measured power in the radio frequency on the transmitter output terminals shall be reported.

The ERP of mobile transmitters must not exceed 7 Watts for LTE Band 5.

The EIRP of mobile transmitters must not exceed 2 Watts for LTE Band 2 and Band 7

The EIRP of mobile transmitters must not exceed 1 Watts for LTE Band 4.

According to KDB 412172 D01 Power Approach,

$EIRP = P_T + G_T - L_C$ ,  $ERP = EIRP - 2.15$ , where

$P_T$  = transmitter output power in dBm

$G_T$  = gain of the transmitting antenna in dBi

$L_C$  = signal attenuation in the connecting cable between the transmitter and antenna in dB

#### 3.4.2 Test Procedures

1. The testing follows ANSI C63.26 Section 5.2
2. The transmitter output port was connected to the system simulator.
3. Set EUT at maximum power through the system simulator.
4. Select lowest, middle, and highest channels for each band and different modulation.
5. Measure and record the power level from the system simulator.



## 3.5 Peak-to-Average Ratio

### 3.5.1 Description of the PAR Measurement

Power Complementary Cumulative Distribution Function (CCDF) curves provide a means for characterizing the power peaks of a digitally modulated signal on a statistical basis. A CCDF curve depicts the probability of the peak signal amplitude exceeding the average power level. Most contemporary measurement instrumentation include the capability to produce CCDF curves for an input signal provided that the instrument's resolution bandwidth can be set wide enough to accommodate the entire input signal bandwidth. In measuring transmissions in this band using an average power technique, the peak-to-average ratio (PAR) of the transmission may not exceed 13 dB.

### 3.5.2 Test Procedures

1. The testing follows ANSI C63.26 Section 5.2.3.4 (CCDF).
2. The EUT was connected to spectrum and system simulator via a power divider.
3. Set the CCDF (Complementary Cumulative Distribution Function) option in spectrum analyzer.
4. The highest RF powers were measured and recorded the maximum PAPR level associated with a probability of 0.1 %.
5. Record the deviation as Peak to Average Ratio.



### 3.6 Occupied Bandwidth

#### 3.6.1 Description of Occupied Bandwidth Measurement

The occupied bandwidth is the width of a frequency band such that, below the lower and above the upper frequency limits, the mean powers emitted are each equal to a specified percentage 0.5% of the total mean transmitted power.

The 26 dB emission bandwidth is defined as the frequency range between two points, one above and one below the carrier frequency, at which the spectral density of the emission is attenuated 26 dB below the maximum in-band spectral density of the modulated signal. Spectral density (power per unit bandwidth) is to be measured with a detector of resolution bandwidth equal to approximately 1.0% of the emission bandwidth.

#### 3.6.2 Test Procedures

1. The testing follows ANSI C63.26 Section 5.4
2. The EUT was connected to spectrum analyzer and system simulator via a power divider.
3. The spectrum analyzer center frequency is set to the nominal EUT channel center frequency. The span range for the spectrum analyzer shall be between two and five times the anticipated OBW.
4. The nominal resolution bandwidth (RBW) shall be in the range of 1 to 5 % of the anticipated OBW, and the VBW shall be at least 3 times the RBW.
5. Set the detection mode to peak, and the trace mode to max hold.
6. Determine the reference value: Set the EUT to transmit a modulated signal. Allow the trace to stabilize. Set the spectrum analyzer marker to the highest level of the displayed trace.  
(this is the reference value)
7. Determine the “-26 dB down amplitude” as equal to (Reference Value – X).
8. Place two markers, one at the lowest and the other at the highest frequency of the envelope of the spectral display such that each marker is at or slightly below the “-X dB down amplitude” determined in step 6. If a marker is below this “-X dB down amplitude” value it shall be placed as close as possible to this value. The OBW is the positive frequency difference between the two markers.
9. Use the 99 % power bandwidth function of the spectrum analyzer and report the measured bandwidth.



### 3.7 Conducted Band Edge

#### 3.7.1 Description of Conducted Band Edge Measurement

22.917(a)

For operations in the 824 – 849 MHz band, the FCC limit is  $43 + 10\log_{10}(P[\text{Watts}])$  dB below the transmitter power P(Watts) in a 100kHz bandwidth. However, in the 1MHz bands immediately outside and adjacent to the licensee's frequency block, a resolution bandwidth of at least one percent of the emission bandwidth of the fundamental emission of the transmitter may be employed.

24.238 (a)

For operations in the 1850-1910 and 1930-1990 MHz band, the FCC limit is  $43 + 10\log_{10}(P[\text{Watts}])$  dB below the transmitter power P(Watts) in a 1MHz bandwidth. However, in the 1 MHz bands immediately outside and adjacent to the frequency block a resolution bandwidth of at least one percent of the emission bandwidth of the fundamental emission of the transmitter may be employed.

27.53 (h)

For operations in the 1710 – 1755 MHz band, the FCC limit is  $43 + 10\log_{10}(P[\text{Watts}])$  dB below the transmitter power P(Watts) in a 1 MHz bandwidth. However, in the 1MHz bands immediately outside and adjacent to the licensee's frequency block, a resolution bandwidth of at least one percent of the emission bandwidth of the fundamental emission of the transmitter may be employed.

27.53(m)(4)

For mobile digital stations, the attenuation factor shall be not less than  $40 + 10 \log (P)$  dB on all frequencies between the channel edge and 5 megahertz from the channel edge,  $43 + 10 \log (P)$  dB on all frequencies between 5 megahertz and X megahertz from the channel edge, and  $55 + 10 \log (P)$  dB on all frequencies more than X megahertz from the channel edge, where X is the greater of 6 megahertz or the actual emission bandwidth as defined in paragraph (m)(6) of this section. In addition, the attenuation factor shall not be less that  $43 + 10 \log (P)$  dB on all frequencies between 2490.5 MHz and 2496 MHz and  $55 + 10 \log (P)$  dB at or below 2490.5 MHz. Mobile Satellite Service licensees operating on frequencies below 2495 MHz may also submit a documented interference complaint against BRS licensees operating on channel BRS Channel 1 on the same terms and conditions as adjacent channel BRS or EBS licensees.



### 3.7.2 Test Procedures

1. The testing follows ANSI C63.26 section 5.7
2. The EUT was connected to spectrum analyzer and system simulator via a power divider.
3. The band edges of low and high channels for the highest RF powers were measured.
4. Set RBW  $\geq$  1% EBW in the 1MHz band immediately outside and adjacent to the band edge.
5. Beyond the 1 MHz band from the band edge, RBW=1MHz was used
6. Set spectrum analyzer with RMS detector.
7. The RF fundamental frequency should be excluded against the limit line in the operating frequency band.
8. Checked that all the results comply with the emission limit line.

Example:

The limit line is derived from  $43 + 10\log(P)$ dB below the transmitter power P(Watts)

$$= P(W) - [43 + 10\log(P)] \text{ (dB)}$$

$$= [30 + 10\log(P)] \text{ (dBm)} - [43 + 10\log(P)] \text{ (dB)} = -13\text{dBm}.$$

9. For LTE Band 7, the other 40 dB, and 55 dB have additionally applied same calculation above.



### 3.8 Conducted Spurious Emission

#### 3.8.1 Description of Conducted Spurious Emission Measurement

The power of any emission outside of the authorized operating frequency ranges must be lower than the transmitter power (P) by a factor of at least  $43 + 10 \log (P)$  dB.

For Band 7:

The power of any emission outside of the authorized operating frequency ranges must be lower than the transmitter power (P) by a factor of at least  $55 + 10 \log (P)$  dB.

It is measured by means of a calibrated spectrum analyzer and scanned from 30 MHz up to a frequency including its 10<sup>th</sup> harmonic.

#### 3.8.2 Test Procedures

1. The testing follows ANSI C63.26 section 5.7
2. The EUT was connected to spectrum analyzer and system simulator via a power divider.
3. The RF output of EUT was connected to the spectrum analyzer by RF cable and attenuator. The path loss was compensated to the results for each measurement.
4. The middle channel for the highest RF power within the transmitting frequency was measured.
5. The conducted spurious emission for the whole frequency range was taken.
6. Make the measurement with the spectrum analyzer's RBW = 1MHz, VBW = 3MHz.
7. Set spectrum analyzer with RMS detector.
8. Taking the record of maximum spurious emission.
9. The RF fundamental frequency should be excluded against the limit line in the operating frequency band.
10. The limit line is derived from  $43 + 10\log(P)$ dB below the transmitter power P(Watts)  
=  $P(W) - [43 + 10\log(P)]$  (dB)  
=  $[30 + 10\log(P)]$  (dBm) -  $[43 + 10\log(P)]$  (dB)  
= -13dBm.
11. For Band 7  
The limit line is derived from  $55 + 10\log(P)$ dB below the transmitter power P(Watts)  
=  $P(W) - [55 + 10\log(P)]$  (dB)  
=  $[30 + 10\log(P)]$  (dBm) -  $[55 + 10\log(P)]$  (dB)  
= -25dBm.



## 3.9 Frequency Stability

### 3.9.1 Description of Frequency Stability Measurement

The frequency stability shall be measured by variation of ambient temperature and variation of primary supply voltage to ensure that the fundamental emission stays within the authorized frequency block. The frequency stability of the transmitter shall be maintained within  $\pm 0.00025\%$  ( $\pm 2.5\text{ppm}$ ) of the center frequency.

### 3.9.2 Test Procedures for Temperature Variation

1. The testing follows ANSI C63.26 section 5.6.4
2. The EUT was set up in the thermal chamber and connected with the system simulator.
3. With power OFF, the temperature was decreased to  $-30^{\circ}\text{C}$  and the EUT was stabilized before testing. Power was applied and the maximum change in frequency was recorded within one minute.
4. With power OFF, the temperature was raised in  $10^{\circ}\text{C}$  step up to  $50^{\circ}\text{C}$ . The EUT was stabilized at each step for at least half an hour. Power was applied and the maximum frequency change was recorded within one minute.

### 3.9.3 Test Procedures for Voltage Variation

1. The testing follows ANSI C63.26 section 5.6.5
2. The EUT was placed in a temperature chamber at  $20\pm 5^{\circ}\text{C}$  and connected with the system simulator.
3. The power supply voltage to the EUT was varied from 85% to 115% of the nominal value for other than hand carried battery equipment.
4. For hand carried, battery powered equipment, reduce the primary ac or dc supply voltage to the battery operating end point, which shall be specified by the manufacturer.
5. The variation in frequency was measured for the worst case.

## 4 Radiated Test Items

### 4.1 Measuring Instruments

See list of measuring instruments of this test report.

### 4.2 Test Setup

#### 4.2.1 For radiated test from 30MHz to 1GHz

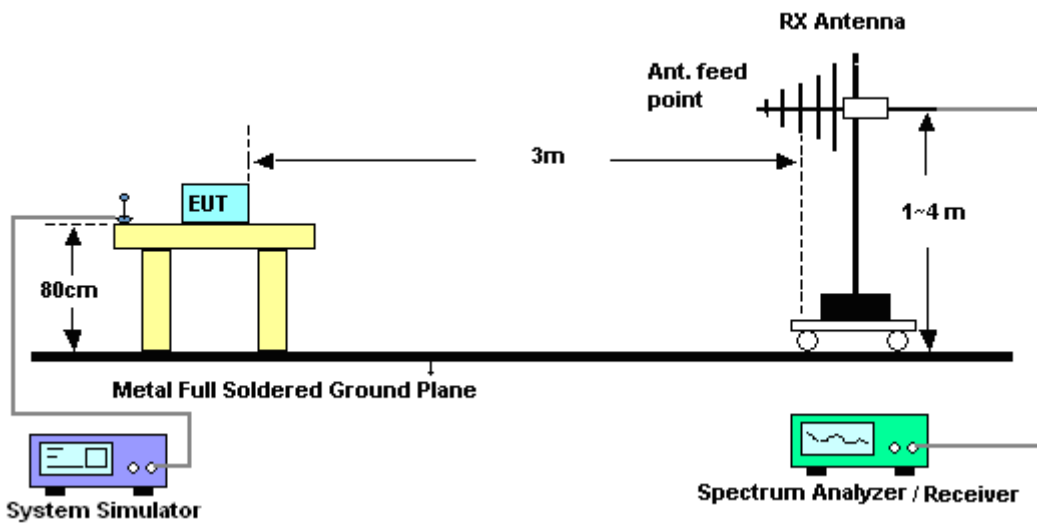

#### 4.2.2 For radiated test above 1GHz

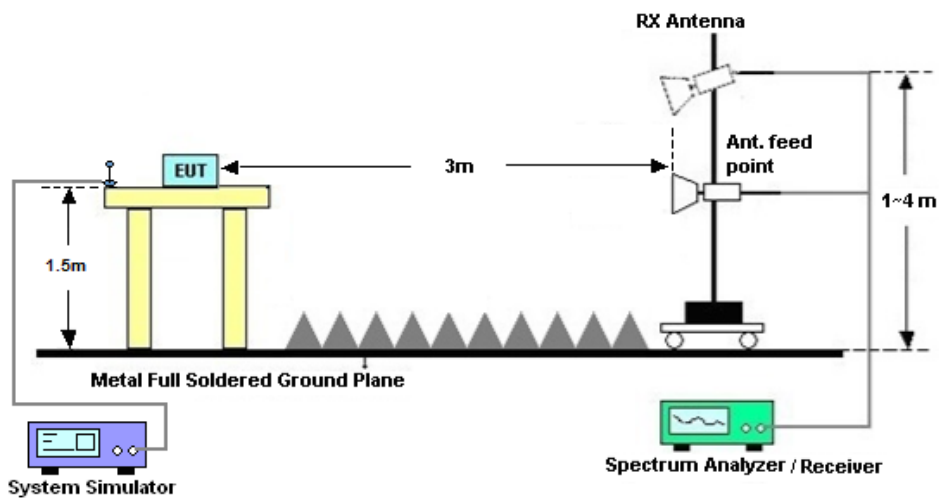

### 4.3 Test Result of Radiated Test

Please refer to Appendix B.



## 4.4 Radiated Spurious Emission

### 4.4.1 Description of Radiated Spurious Emission

The radiated spurious emission was measured by substitution method according to ANSI C63.26. The power of any emission outside of the authorized operating frequency ranges must be attenuated below the transmitter power (P) by a factor of at least  $43 + 10 \log (P)$  dB.

For Band 7

The power of any emission outside of the authorized operating frequency ranges must be attenuated below the transmitter power (P) by a factor of at least  $55 + 10 \log (P)$  dB.

The spectrum is scanned from 30 MHz up to a frequency including its 10th harmonic.

### 4.4.2 Test Procedures

1. The testing follows ANSI C63.26 Section 5.5
2. The EUT was placed on a turntable with 0.8 meter height for frequency below 1GHz and 1.5 meter height for frequency above 1GHz respectively above ground.
3. The EUT was set 3 meters from the receiving antenna mounted on the antenna tower.
4. The table was rotated 360 degrees to determine the position of the highest spurious emission.
5. The height of the receiving antenna is varied between 1m to 4m to search the maximum spurious emission for both horizontal and vertical polarizations.
6. During the measurement, the system simulator parameters were set to force the EUT transmitting at maximum output power.
7. Make the measurement with the spectrum analyzer's RBW = 1MHz, VBW = 3MHz, taking the record of maximum spurious emission.
8. A horn antenna was substituted in place of the EUT and was driven by a signal generator.
9. Tune the output power of signal generator to the same emission level with EUT maximum spurious emission.
10.  $EIRP (dBm) = S.G. Power - Tx Cable Loss + Tx Antenna Gain$
11.  $ERP (dBm) = EIRP - 2.15$
12. The RF fundamental frequency should be excluded against the limit line in the operating frequency band.

The limit line is derived from  $43 + 10\log(P)$ dB below the transmitter power P(Watts)  
 $= P(W) - [43 + 10\log(P)] (dB)$   
 $= [30 + 10\log(P)] (dBm) - [43 + 10\log(P)] (dB)$   
 $= -13dBm.$

13. For Band 7:

The limit line is derived from  $55 + 10\log(P)$ dB below the transmitter power P(Watts)



## 5 List of Measuring Equipment

Instrument	Manufacturer	Model No.	Serial No.	Characteristics	Calibration Date	Test Date	Due Date	Remark
Spectrum Analyzer	R&S	FSV30	101338	10Hz~30GHz	Apr. 16, 2019	Aug.01,2019~ Aug.08,2019	Apr. 15, 2020	Conducted (TH01-KS)
Thermal Chamber	Ten Billion	TTC-B3S	TBN-960502	-40~+150°C	Nov. 19, 2018	Aug.01,2019~ Aug.08,2019	Nov. 18, 2019	Conducted (TH01-KS)
EXA Spectrum Analyzer	Keysight	N9010A	MY55150244	10Hz-44G,MAX 30dB	Apr.16, 2019	Aug.13,2019	Apr. 15, 2020	Radiation (03CH04-KS)
Bilog Antenna	TeseQ	CBL6111D	44483	30MHz-1GHz	Dec. 28, 2018	Aug.13,2019	Dec. 27, 2019	Radiation (03CH04-KS)
Horn Antenna	Schwarzbeck	BBHA9120D	1648	1GHz~18GHz	Jan. 27, 2019	Aug.13,2019	Jan. 26, 2020	Radiation (03CH04-KS)
SHF-EHF Horn	Com-power	AH-840	101070	18GHz~40GHz	Jan. 05, 2019	Aug.13,2019	Jan. 04, 2020	Radiation (03CH04-KS)
Amplifier	Burgeon	BPA-530	102219	0.01MHz ~3000MHz	Nov. 19, 2018	Aug.13,2019	Nov. 18, 2019	Radiation (03CH04-KS)
Amplifier	MITEQ	TTA1840-35 -HG	2014749	18~40GHz	Jan. 14, 2019	Aug.13,2019	Jan.13, 2020	Radiation (03CH04-KS)
high gain Amplifier	MITEQ	AMF-7D-00 101800-30-1 AP	2025788	1Ghz-18Ghz	Aug.16.2018	Aug.13,2019	Aug.15,2019	Radiation (03CH04-KS)
Amplifier	Keysight	83017A	MY53270319	500MHz~26.5GHz	Oct. 12, 2018	Aug.13,2019	Oct. 11, 2019	Radiation (03CH04-KS)
AC Power Source	Chroma	61601	F104090004	N/A	NCR	Aug.13,2019	NCR	Radiation (03CH04-KS)
Turn Table	ChamPro	EM 1000-T	060762-T	0~360 degree	NCR	Aug.13,2019	NCR	Radiation (03CH04-KS)
Antenna Mast	ChamPro	EM 1000-A	060762-A	1 m~4 m	NCR	Aug.13,2019	NCR	Radiation (03CH04-KS)

NCR: No Calibration Required



## 6 Uncertainty of Evaluation

The measurement uncertainties shown below were calculated in accordance with the requirements of ANSI 63.26-2015. All the measurement uncertainty value were shown with a coverage K=2 to indicate 95% level of confidence. The measurement data show herein meets or exceeds the CISPR measurement uncertainty values specified in CISPR 16-4-2 and can be compared directly to specified limit to determine compliance.

### Uncertainty of Radiated Emission Measurement (30 MHz ~ 1000 MHz)

Measuring Uncertainty for a Level of Confidence of 95% (U = 2Uc(y))	3.3dB
---	-------

### Uncertainty of Radiated Emission Measurement (1 GHz ~ 40 GHz)

Measuring Uncertainty for a Level of Confidence of 95% (U = 2Uc(y))	2.8dB
---	-------



## Appendix A. Test Results of Conducted Test

### Conducted Output Power(Average power)

LTE Band 2 Maximum Average Power [dBm]						
BW [MHz]	RB Size	RB Offset	Mod	Lowest	Middle	Highest
20	1	0	QPSK	22.73	22.68	22.69
20	1	49		22.95	23.16	22.92
20	1	99		22.79	22.74	22.77
20	50	0		21.85	22.19	22.29
20	50	24		22.01	22.16	22.05
20	50	50		21.80	22.28	21.96
20	100	0		21.81	22.20	22.14
20	1	0	16-QAM	21.99	21.99	21.89
20	1	49		22.29	22.34	22.17
20	1	99		21.84	21.85	21.87
20	50	0		20.83	21.15	21.23
20	50	24		20.97	21.13	21.00
20	50	50		20.74	21.22	20.93
20	100	0		20.75	21.19	21.07
15	1	0	QPSK	22.87	22.94	22.80
15	1	37		23.06	23.15	23.01
15	1	74		22.72	22.82	22.71
15	36	0		21.98	22.16	22.15
15	36	20		22.04	22.14	21.98
15	36	39		21.95	22.20	22.00
15	75	0		21.99	22.17	22.09
15	1	0	16-QAM	22.21	22.21	22.06
15	1	37		22.34	22.49	22.31
15	1	74		22.03	22.13	22.03
15	36	0		20.97	21.16	21.13
15	36	20		21.03	21.12	20.97
15	36	39		20.92	21.16	20.96
15	75	0		20.94	21.14	21.03



LTE Band 2 Maximum Average Power [dBm]						
BW [MHz]	RB Size	RB Offset	Mod	Lowest	Middle	Highest
10	1	0	QPSK	22.93	22.99	22.80
10	1	25		23.06	23.09	22.96
10	1	49		22.84	22.95	22.69
10	25	0		21.96	22.16	22.04
10	25	12		22.06	22.19	21.99
10	25	25		22.10	22.23	22.08
10	50	0		22.06	22.24	22.11
10	1	0	16-QAM	22.25	22.32	22.14
10	1	25		22.35	22.44	22.29
10	1	49		22.13	22.29	21.97
10	25	0		20.93	21.16	21.03
10	25	12		21.04	21.17	20.98
10	25	25		21.08	21.21	21.05
10	50	0		21.01	21.21	21.05
5	1	0	QPSK	22.84	22.93	22.75
5	1	12		23.13	23.06	22.99
5	1	24		22.86	22.90	22.63
5	12	0		21.99	22.08	21.84
5	12	7		22.10	22.18	21.92
5	12	13		22.11	22.16	21.93
5	25	0		22.08	22.13	21.96
5	1	0	16-QAM	22.18	22.28	22.07
5	1	12		22.48	22.51	22.24
5	1	24		22.17	22.25	22.07
5	12	0		20.99	21.12	20.85
5	12	7		21.08	21.17	20.92
5	12	13		21.13	21.17	20.90
5	25	0		21.03	21.12	20.89



LTE Band 2 Maximum Average Power [dBm]						
BW [MHz]	RB Size	RB Offset	Mod	Lowest	Middle	Highest
3	1	0	QPSK	22.99	23.07	22.85
3	1	8		22.97	23.05	22.78
3	1	14		22.99	23.03	22.80
3	8	0		22.09	22.14	21.94
3	8	4		22.12	22.20	21.98
3	8	7		22.08	22.15	21.92
3	15	0		22.08	22.14	21.90
3	1	0	16-QAM	22.28	22.41	22.15
3	1	8		22.29	22.38	22.03
3	1	14		22.29	22.41	22.01
3	8	0		21.11	21.18	20.95
3	8	4		21.13	21.23	20.95
3	8	7		21.10	21.19	20.90
3	15	0		21.04	21.16	20.89
1.4	1	0	QPSK	22.90	22.97	22.70
1.4	1	3		23.02	23.09	22.83
1.4	1	5		22.91	22.98	22.70
1.4	3	0		22.98	23.04	22.80
1.4	3	1		23.03	23.11	22.86
1.4	3	3		22.99	23.05	22.79
1.4	6	0		22.05	22.16	21.89
1.4	1	0	16-QAM	22.24	22.32	21.94
1.4	1	3		22.32	22.41	22.07
1.4	1	5		22.26	22.29	21.92
1.4	3	0		22.05	22.13	21.83
1.4	3	1		22.13	22.17	21.87
1.4	3	3		22.05	22.12	21.83
1.4	6	0		21.13	21.19	20.91



LTE Band 4 Maximum Average Power [dBm]						
BW [MHz]	RB Size	RB Offset	Mod	Lowest	Middle	Highest
20	1	0	QPSK	22.88	22.89	23.00
20	1	49		23.17	23.35	23.17
20	1	99		22.94	22.88	22.85
20	50	0		22.21	22.49	22.47
20	50	24		22.26	22.41	22.29
20	50	50		22.21	22.20	22.10
20	100	0		22.20	22.35	22.27
20	1	0	16-QAM	22.10	22.18	22.24
20	1	49		22.44	22.53	22.45
20	1	99		22.10	22.03	22.03
20	50	0		21.15	21.41	21.40
20	50	24		21.20	21.34	21.23
20	50	50		21.16	21.14	21.02
20	100	0		21.14	21.24	21.21
15	1	0	QPSK	22.98	23.10	23.10
15	1	37		23.22	23.24	23.17
15	1	74		22.97	23.04	22.81
15	36	0		22.18	22.38	22.28
15	36	20		22.23	22.34	22.16
15	36	39		22.19	22.21	22.05
15	75	0		22.21	22.32	22.18
15	1	0	16-QAM	22.26	22.32	22.37
15	1	37		22.53	22.58	22.45
15	1	74		22.20	22.30	22.11
15	36	0		21.17	21.31	21.24
15	36	20		21.22	21.32	21.14
15	36	39		21.15	21.19	21.05
15	75	0		21.16	21.24	21.14



LTE Band 4 Maximum Average Power [dBm]						
BW [MHz]	RB Size	RB Offset	Mod	Lowest	Middle	Highest
10	1	0	QPSK	23.09	23.19	23.12
10	1	25		23.27	23.30	23.12
10	1	49		23.04	23.14	22.92
10	25	0		22.17	22.45	22.31
10	25	12		22.26	22.40	22.19
10	25	25		22.23	22.27	22.07
10	50	0		22.23	22.39	22.21
10	1	0	16-QAM	22.35	22.45	22.40
10	1	25		22.51	22.50	22.37
10	1	49		22.36	22.42	22.19
10	25	0		21.12	21.37	21.26
10	25	12		21.19	21.33	21.14
10	25	25		21.19	21.18	21.03
10	50	0		21.17	21.32	21.15
5	1	0	QPSK	22.93	23.10	22.90
5	1	12		23.22	23.30	23.15
5	1	24		22.96	23.08	22.83
5	12	0		22.14	22.32	22.07
5	12	7		22.18	22.33	22.11
5	12	13		22.14	22.22	22.00
5	25	0		22.18	22.32	22.07
5	1	0	16-QAM	22.20	22.32	22.17
5	1	12		22.49	22.57	22.40
5	1	24		22.20	22.31	22.14
5	12	0		21.11	21.28	21.08
5	12	7		21.15	21.30	21.07
5	12	13		21.12	21.22	20.98
5	25	0		21.11	21.28	21.04



LTE Band 4 Maximum Average Power [dBm]						
BW [MHz]	RB Size	RB Offset	Mod	Lowest	Middle	Highest
3	1	0	QPSK	23.06	23.22	23.00
3	1	8		23.06	23.20	22.94
3	1	14		23.07	23.20	22.95
3	8	0		22.15	22.33	22.08
3	8	4		22.17	22.33	22.11
3	8	7		22.14	22.31	22.03
3	15	0		22.16	22.32	22.07
3	1	0	16-QAM	22.31	22.43	22.29
3	1	8		22.36	22.42	22.23
3	1	14		22.31	22.43	22.28
3	8	0		21.15	21.31	21.08
3	8	4		21.20	21.33	21.12
3	8	7		21.16	21.30	21.08
3	15	0		21.10	21.28	21.03
1.4	1	0	QPSK	22.98	23.16	22.91
1.4	1	3		23.13	23.29	23.06
1.4	1	5		23.02	23.17	22.94
1.4	3	0		23.08	23.27	23.01
1.4	3	1		23.12	23.33	23.07
1.4	3	3		23.10	23.26	23.02
1.4	6	0		22.20	22.35	22.11
1.4	1	0	16-QAM	22.31	22.40	22.18
1.4	1	3		22.41	22.50	22.32
1.4	1	5		22.25	22.41	22.21
1.4	3	0		22.15	22.27	22.08
1.4	3	1		22.19	22.30	22.13
1.4	3	3		22.15	22.24	22.09
1.4	6	0		21.22	21.39	21.17



LTE Band 5 Maximum Average Power [dBm]						
BW [MHz]	RB Size	RB Offset	Mod	Lowest	Middle	Highest
10	1	0	QPSK	23.47	23.38	23.36
10	1	25		23.68	23.50	23.49
10	1	49		23.38	23.34	23.33
10	25	0		22.53	22.50	22.39
10	25	12		22.54	22.47	22.45
10	25	25		22.54	22.48	22.42
10	50	0		22.56	22.51	22.43
10	1	0	16-QAM	22.64	22.58	22.59
10	1	25		22.80	22.70	22.70
10	1	49		22.60	22.56	22.52
10	25	0		21.49	21.45	21.35
10	25	12		21.52	21.43	21.39
10	25	25		21.50	21.44	21.37
10	50	0		21.49	21.43	21.36
5	1	0	QPSK	23.35	23.24	23.22
5	1	12		23.67	23.55	23.54
5	1	24		23.35	23.25	23.20
5	12	0		22.48	22.37	22.33
5	12	7		22.52	22.39	22.36
5	12	13		22.55	22.37	22.29
5	25	0		22.52	22.38	22.32
5	1	0	16-QAM	22.56	22.44	22.44
5	1	12		22.87	22.72	22.73
5	1	24		22.59	22.46	22.40
5	12	0		21.47	21.35	21.28
5	12	7		21.52	21.38	21.34
5	12	13		21.51	21.31	21.26
5	25	0		21.47	21.35	21.30



LTE Band 5 Maximum Average Power [dBm]						
BW [MHz]	RB Size	RB Offset	Mod	Lowest	Middle	Highest
3	1	0	QPSK	23.45	23.34	23.35
3	1	8		23.45	23.33	23.34
3	1	14		23.43	23.34	23.34
3	8	0		22.50	22.41	22.34
3	8	4		22.52	22.39	22.39
3	8	7		22.47	22.34	22.35
3	15	0		22.52	22.38	22.37
3	1	0	16-QAM	22.64	22.53	22.56
3	1	8		22.71	22.56	22.56
3	1	14		22.69	22.58	22.50
3	8	0		21.51	21.39	21.34
3	8	4		21.55	21.41	21.38
3	8	7		21.47	21.36	21.37
3	15	0		21.46	21.35	21.32
1.4	1	0	QPSK	23.43	23.29	23.31
1.4	1	3		23.58	23.41	23.42
1.4	1	5		23.43	23.32	23.28
1.4	3	0		23.50	23.37	23.36
1.4	3	1		23.57	23.46	23.44
1.4	3	3		23.54	23.37	23.39
1.4	6	0		22.56	22.42	22.42
1.4	1	0	16-QAM	22.63	22.53	22.46
1.4	1	3		22.79	22.65	22.59
1.4	1	5		22.67	22.53	22.50
1.4	3	0		22.47	22.37	22.33
1.4	3	1		22.57	22.41	22.41
1.4	3	3		22.52	22.38	22.35
1.4	6	0		21.58	21.44	21.42



LTE Band 7 Maximum Average Power [dBm]						
BW [MHz]	RB Size	RB Offset	Mod	Lowest	Middle	Highest
20	1	0	QPSK	22.85	22.77	22.73
20	1	49		23.17	22.90	22.95
20	1	99		22.79	22.71	22.76
20	50	0		22.09	21.89	21.91
20	50	24		22.20	21.97	22.06
20	50	50		22.15	21.92	22.09
20	100	0		22.12	21.91	22.01
20	1	0	16-QAM	22.11	21.93	21.93
20	1	49		22.38	22.23	22.28
20	1	99		22.07	21.99	22.12
20	50	0		21.16	20.87	20.90
20	50	24		21.27	20.95	21.01
20	50	50		21.22	20.90	21.06
20	100	0		21.18	20.88	20.97
15	1	0	QPSK	22.91	22.62	22.68
15	1	37		23.10	22.79	22.92
15	1	74		22.81	22.61	22.79
15	36	0		21.99	21.72	21.78
15	36	20		21.99	21.72	21.86
15	36	39		21.97	21.73	21.92
15	75	0		22.02	21.72	21.85
15	1	0	16-QAM	22.14	21.87	21.86
15	1	37		22.32	22.12	22.20
15	1	74		22.11	21.91	22.09
15	36	0		21.04	20.74	20.76
15	36	20		21.07	20.76	20.86
15	36	39		21.06	20.76	20.93
15	75	0		21.04	20.70	20.85



LTE Band 7 Maximum Average Power [dBm]						
BW [MHz]	RB Size	RB Offset	Mod	Lowest	Middle	Highest
10	1	0	QPSK	23.00	22.58	22.60
10	1	25		23.06	22.71	22.89
10	1	49		22.89	22.58	22.80
10	25	0		22.01	21.78	21.87
10	25	12		22.01	21.76	21.90
10	25	25		22.02	21.75	21.94
10	50	0		22.03	21.81	21.94
10	1	0	16-QAM	22.23	21.95	21.97
10	1	25		22.28	22.07	22.18
10	1	49		22.13	21.95	22.13
10	25	0		21.06	20.75	20.82
10	25	12		21.09	20.74	20.87
10	25	25		21.09	20.76	20.91
10	50	0		21.06	20.79	20.87
5	1	0	QPSK	22.91	22.70	22.84
5	1	12		23.10	22.79	22.98
5	1	24		22.86	22.67	22.73
5	12	0		21.98	21.69	21.89
5	12	7		22.04	21.74	21.95
5	12	13		22.02	21.69	21.92
5	25	0		22.04	21.73	21.90
5	1	0	16-QAM	22.16	22.01	21.95
5	1	12		22.44	22.17	22.28
5	1	24		22.08	22.09	22.10
5	12	0		21.08	20.71	20.88
5	12	7		21.15	20.75	20.98
5	12	13		21.10	20.72	20.91
5	25	0		21.09	20.71	20.86



**ERP/EIRP**

LTE Band 2 (GT - LC = 0.19 dB) QPSK									
Bandwidth	1.4M			3M			5M		
Channel	18607	18900	19193	18615	18900	19185	18625	18900	19175
	(Low)	(Mid)	(High)	(Low)	(Mid)	(High)	(Low)	(Mid)	(High)
Frequency	1850.7	1880	1909.3	1851.5	1880	1908.5	1852.5	1880	1907.5
(MHz)									
Conducted Power (dBm)	23.03	23.11	22.86	22.99	23.07	22.85	23.13	23.06	22.99
Conducted Power (Watts)	0.2009	0.2046	0.1932	0.1991	0.2028	0.1928	0.2056	0.2023	0.1991
EIRP(dBm)	23.22	23.30	23.05	23.18	23.26	23.04	23.32	23.25	23.18
EIRP(Watts)	0.2099	0.2138	0.2018	0.2080	0.2118	0.2014	0.2148	0.2113	0.2080

LTE Band 2 (GT - LC = 0.19 dB) QPSK									
Bandwidth	10M			15M			20M		
Channel	18650	18900	19150	18675	18900	19125	18650	18900	19100
	(Low)	(Mid)	(High)	(Low)	(Mid)	(High)	(Low)	(Mid)	(High)
Frequency	1855	1880	1905	1857.5	1880	1902.5	1860	1880	1900
(MHz)									
Conducted Power (dBm)	23.06	23.09	22.96	23.06	23.15	23.01	22.95	23.16	22.92
Conducted Power (Watts)	0.2023	0.2037	0.1977	0.2023	0.2065	0.2000	0.1972	0.2070	0.1959
EIRP(dBm)	23.25	23.28	23.15	23.25	23.34	23.20	23.14	23.35	23.11
EIRP(Watts)	0.2113	0.2128	0.2065	0.2113	0.2158	0.2089	0.2061	0.2163	0.2046



LTE Band 2 (GT - LC = 0.19 dB) 16QAM									
Bandwidth	1.4M			3M			5M		
Channel	18607	18900	19193	18615	18900	19185	18625	18900	19175
	(Low)	(Mid)	(High)	(Low)	(Mid)	(High)	(Low)	(Mid)	(High)
Frequency (MHz)	1850.7	1880	1909.3	1851.5	1880	1908.5	1852.5	1880	1907.5
Conducted Power (dBm)	22.32	22.41	22.07	22.29	22.41	22.01	22.48	22.51	22.24
Conducted Power (Watts)	0.1706	0.1742	0.1611	0.1694	0.1742	0.1589	0.1770	0.1782	0.1675
EIRP(dBm)	22.51	22.60	22.26	22.48	22.60	22.20	22.67	22.70	22.43
EIRP(Watts)	0.1782	0.1820	0.1683	0.1770	0.1820	0.1660	0.1849	0.1862	0.1750

LTE Band 2 (GT - LC = 0.19 dB) 16QAM									
Bandwidth	10M			15M			20M		
Channel	18650	18900	19150	18675	18900	19125	18650	18900	19100
	(Low)	(Mid)	(High)	(Low)	(Mid)	(High)	(Low)	(Mid)	(High)
Frequency (MHz)	1855	1880	1905	1857.5	1880	1902.5	1860	1880	1900
Conducted Power (dBm)	22.35	22.44	22.29	22.34	22.49	22.31	22.29	22.34	22.17
Conducted Power (Watts)	0.1718	0.1754	0.1694	0.1714	0.1774	0.1702	0.1694	0.1714	0.1648
EIRP(dBm)	22.54	22.63	22.48	22.53	22.68	22.50	22.48	22.53	22.36
EIRP(Watts)	0.1795	0.1832	0.1770	0.1791	0.1854	0.1778	0.1770	0.1791	0.1722



LTE Band 4 (GT - LC = 0.19 dB) QPSK									
Bandwidth	1.4M			3M			5M		
Channel	19957	20175	20393	19965	20175	20385	19975	20175	20375
	(Low)	(Mid)	(High)	(Low)	(Mid)	(High)	(Low)	(Mid)	(High)
Frequency (MHz)	1710.7	1732.5	1754.3	1711.5	1732.5	1753.5	1712.5	1732.5	1752.5
Conducted Power (dBm)	23.12	23.33	23.07	23.06	23.22	23.00	23.22	23.30	23.15
Conducted Power (Watts)	0.2051	0.2153	0.2028	0.2023	0.2099	0.1995	0.2099	0.2138	0.2065
EIRP(dBm)	23.31	23.52	23.26	23.25	23.41	23.19	23.41	23.49	23.34
EIRP(Watts)	0.2143	0.2249	0.2118	0.2113	0.2193	0.2084	0.2193	0.2234	0.2158

LTE Band 4 (GT - LC = 0.19 dB) QPSK									
Bandwidth	10M			15M			20M		
Channel	20000	20175	20350	20025	20175	20325	20050	20175	20300
	(Low)	(Mid)	(High)	(Low)	(Mid)	(High)	(Low)	(Mid)	(High)
Frequency (MHz)	1715	1732.5	1750	1717.5	1732.5	1747.5	1720	1732.5	1745
Conducted Power (dBm)	23.27	23.30	23.12	23.22	23.24	23.17	23.17	23.35	23.17
Conducted Power (Watts)	0.2123	0.2138	0.2051	0.2099	0.2109	0.2075	0.2075	0.2163	0.2075
EIRP(dBm)	23.46	23.49	23.31	23.41	23.43	23.36	23.36	23.54	23.36
EIRP(Watts)	0.2218	0.2234	0.2143	0.2193	0.2203	0.2168	0.2168	0.2259	0.2168



LTE Band 4 (GT - LC = 0.19 dB) 16QAM									
Bandwidth	1.4M			3M			5M		
Channel	19957	20175	20393	19965	20175	20385	19975	20175	20375
	(Low)	(Mid)	(High)	(Low)	(Mid)	(High)	(Low)	(Mid)	(High)
Frequency (MHz)	1710.7	1732.5	1754.3	1711.5	1732.5	1753.5	1712.5	1732.5	1752.5
Conducted Power (dBm)	22.41	22.50	22.32	22.31	22.43	22.29	22.49	22.57	22.40
Conducted Power (Watts)	0.1742	0.1778	0.1706	0.1702	0.1750	0.1694	0.1774	0.1807	0.1738
EIRP(dBm)	22.60	22.69	22.51	22.50	22.62	22.48	22.68	22.76	22.59
EIRP(Watts)	0.1820	0.1858	0.1782	0.1778	0.1828	0.1770	0.1854	0.1888	0.1816

LTE Band 4 (GT - LC = 0.19 dB) 16QAM									
Bandwidth	10M			15M			20M		
Channel	20000	20175	20350	20025	20175	20325	20050	20175	20300
	(Low)	(Mid)	(High)	(Low)	(Mid)	(High)	(Low)	(Mid)	(High)
Frequency (MHz)	1715	1732.5	1750	1717.5	1732.5	1747.5	1720	1732.5	1745
Conducted Power (dBm)	22.51	22.50	22.37	22.53	22.58	22.45	22.44	22.53	22.45
Conducted Power (Watts)	0.1782	0.1778	0.1726	0.1791	0.1811	0.1758	0.1754	0.1791	0.1758
EIRP(dBm)	22.70	22.69	22.56	22.72	22.77	22.64	22.63	22.72	22.64
EIRP(Watts)	0.1862	0.1858	0.1803	0.1871	0.1892	0.1837	0.1832	0.1871	0.1837



LTE Band 5 (GT - LC = -1.53 dB) QPSK									
Bandwidth	1.4M			3M			5M		
Channel	20407	20525	20643	20415	20525	20635	20425	20525	20625
	(Low)	(Mid)	(High)	(Low)	(Mid)	(High)	(Low)	(Mid)	(High)
Frequency (MHz)	824.7	836.5	848.3	825.5	836.5	847.5	826.5	836.5	846.5
Conducted Power (dBm)	23.58	23.41	23.42	23.45	23.34	23.35	23.67	23.55	23.54
Conducted Power (Watts)	0.2280	0.2193	0.2198	0.2213	0.2158	0.2163	0.2328	0.2265	0.2259
ERP(dBm)	19.90	19.73	19.74	19.77	19.66	19.67	19.99	19.87	19.86
ERP(Watts)	0.0977	0.0940	0.0942	0.0948	0.0925	0.0927	0.0998	0.0971	0.0968

LTE Band 5 (GT - LC = -1.53 dB) QPSK			
Bandwidth	10M		
Channel	20450	20525	20600
	(Low)	(Mid)	(High)
Frequency (MHz)	829	836.5	844
Conducted Power (dBm)	23.68	23.50	23.49
Conducted Power (Watts)	0.2333	0.2239	0.2234
ERP(dBm)	20.00	19.82	19.81
ERP(Watts)	0.1000	0.0959	0.0957



LTE Band 5 (GT - LC = -1.53 dB) 16QAM									
Bandwidth	1.4M			3M			5M		
Channel	20407	20525	20643	20415	20525	20635	20425	20525	20625
	(Low)	(Mid)	(High)	(Low)	(Mid)	(High)	(Low)	(Mid)	(High)
Frequency (MHz)	824.7	836.5	848.3	825.5	836.5	847.5	826.5	836.5	846.5
Conducted Power (dBm)	22.79	22.65	22.59	22.71	22.56	22.56	22.87	22.72	22.73
Conducted Power (Watts)	0.1901	0.1841	0.1816	0.1866	0.1803	0.1803	0.1936	0.1871	0.1875
ERP(dBm)	19.11	18.97	18.91	19.03	18.88	18.88	19.19	19.04	19.05
ERP(Watts)	0.0815	0.0789	0.0778	0.0800	0.0773	0.0773	0.0830	0.0802	0.0804

LTE Band 5 (GT - LC = -1.53 dB) 16QAM			
Bandwidth	10M		
Channel	20450	20525	20600
	(Low)	(Mid)	(High)
Frequency (MHz)	829	836.5	844
Conducted Power (dBm)	22.80	22.70	22.70
Conducted Power (Watts)	0.1905	0.1862	0.1862
ERP(dBm)	19.12	19.02	19.02
ERP(Watts)	0.0817	0.0798	0.0798



LTE Band 7 (GT - LC = -0.45 dB) QPSK			
Bandwidth	5M		
Channel	20775	21100	21425
	(Low)	(Mid)	(High)
Frequency	2502.5	2535	2567.5
(MHz)			
Conducted Power (dBm)	23.10	22.79	22.98
Conducted Power (Watts)	0.2042	0.1901	0.1986
EIRP(dBm)	22.65	22.34	22.53
EIRP(Watts)	0.1841	0.1714	0.1791

LTE Band 7 (GT - LC = -0.45 dB) QPSK									
Bandwidth	10M			15M			20M		
Channel	20800	21100	21400	20825	21100	21375	20850	21100	21350
	(Low)	(Mid)	(High)	(Low)	(Mid)	(High)	(Low)	(Mid)	(High)
Frequency	2505	2535	2565	2507.5	2535	2562.5	2510	2535	2560
(MHz)									
Conducted Power (dBm)	23.06	22.71	22.89	23.10	22.79	22.92	23.17	22.90	22.95
Conducted Power (Watts)	0.2023	0.1866	0.1945	0.2042	0.1901	0.1959	0.2075	0.1950	0.1972
EIRP(dBm)	22.61	22.26	22.44	22.65	22.34	22.47	22.72	22.45	22.50
EIRP(Watts)	0.1824	0.1683	0.1754	0.1841	0.1714	0.1766	0.1871	0.1758	0.1778



LTE Band 7 (GT - LC = -0.45 dB) 16QAM			
Bandwidth	5M		
Channel	20775	21100	21425
	(Low)	(Mid)	(High)
Frequency	2502.5	2535	2567.5
(MHz)			
Conducted Power (dBm)	22.44	22.17	22.28
Conducted Power (Watts)	0.1754	0.1648	0.1690
EIRP(dBm)	21.99	21.72	21.83
EIRP(Watts)	0.1581	0.1486	0.1524

LTE Band 7 (GT - LC = -0.45 dB) 16QAM									
Bandwidth	10M			15M			20M		
Channel	20800	21100	21400	20825	21100	21375	20850	21100	21350
	(Low)	(Mid)	(High)	(Low)	(Mid)	(High)	(Low)	(Mid)	(High)
Frequency	2505	2535	2565	2507.5	2535	2562.5	2510	2535	2560
(MHz)									
Conducted Power (dBm)	22.28	22.07	22.18	22.32	22.12	22.20	22.38	22.23	22.28
Conducted Power (Watts)	0.1690	0.1611	0.1652	0.1706	0.1629	0.1660	0.1730	0.1671	0.1690
EIRP(dBm)	21.83	21.62	21.73	21.87	21.67	21.75	21.93	21.78	21.83
EIRP(Watts)	0.1524	0.1452	0.1489	0.1538	0.1469	0.1496	0.1560	0.1507	0.1524



**Peak-to-Average Ratio**

Mode	LTE Band 2 / 20MHz				
Mod.	QPSK		16QAM		Limit: 13dB
RB Size	1RB	Full RB	1RB	Full RB	Result
Lowest CH	4.29	5.04	5.86	6.06	PASS
Middle CH	3.74	5.33	4.49	6.23	
Highest CH	4.61	5.33	5.19	6.26	

Mode	LTE Band 4 / 20MHz				
Mod.	QPSK		16QAM		Limit: 13dB
RB Size	1RB	Full RB	1RB	Full RB	Result
Lowest CH	4.55	4.81	5.59	5.80	PASS
Middle CH	4.03	4.43	4.70	5.51	
Highest CH	3.62	4.93	4.52	5.88	

Mode	LTE Band 5 / 10MHz				
Mod.	QPSK		16QAM		Limit: 13dB
RB Size	1RB	Full RB	1RB	Full RB	Result
Lowest CH	3.74	5.01	4.52	5.97	PASS
Middle CH	4.26	4.72	5.57	5.8	
Highest CH	4.17	5.04	5.25	6.06	

Mode	LTE Band 7 / 20MHz				
Mod.	QPSK		16QAM		Limit: 13dB
RB Size	1RB	Full RB	1RB	Full RB	Result
Lowest CH	4.41	5.01	5.42	6.00	PASS
Middle CH	5.33	5.45	5.94	6.41	
Highest CH	4.84	5.19	5.80	6.20	



LTE Band 2 / 20MHz / QPSK

Lowest Channel / 1RB

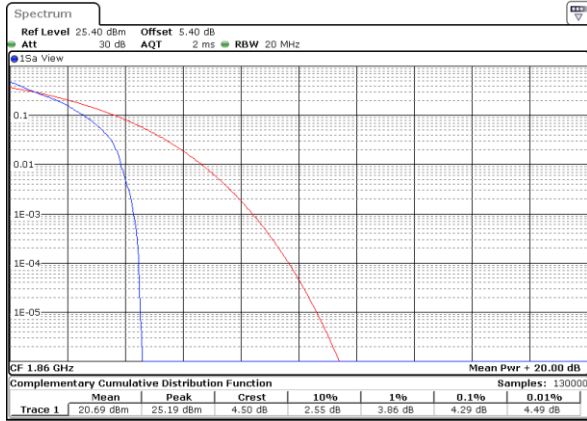

Date: 1 AUG 2019 03:19:30

Lowest Channel / Full RB

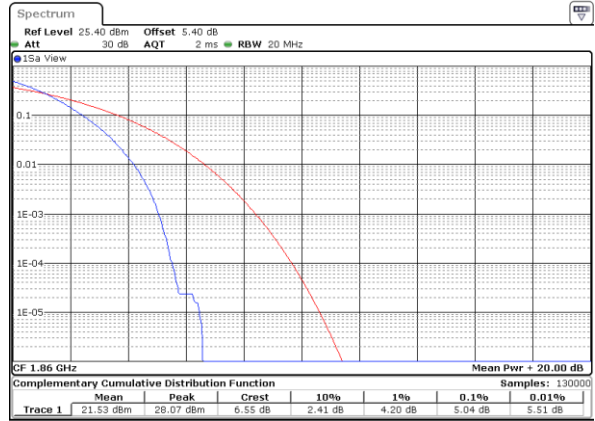

Date: 1 AUG 2019 03:19:39

Middle Channel / 1RB

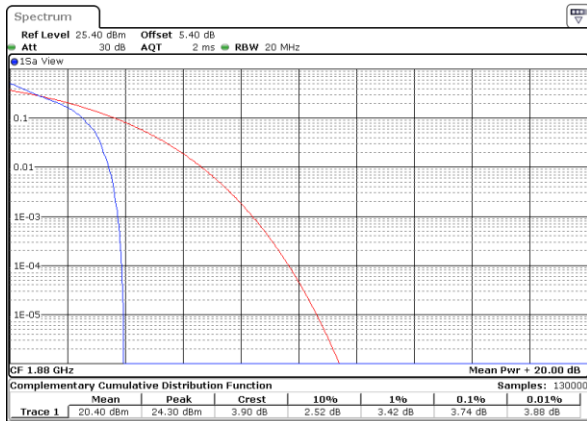

Date: 1 AUG 2019 03:19:48

Middle Channel / Full RB

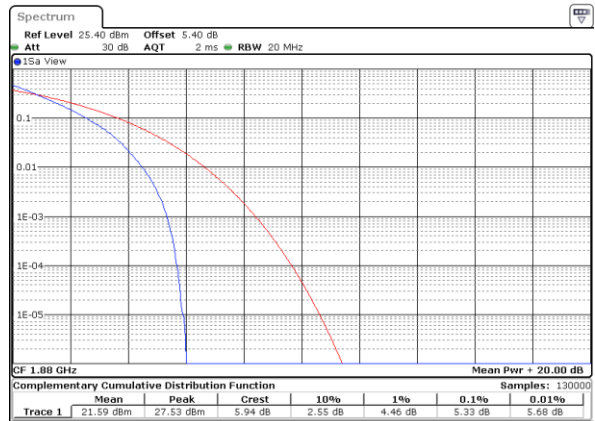

Date: 1 AUG 2019 03:19:57

Highest Channel / 1RB

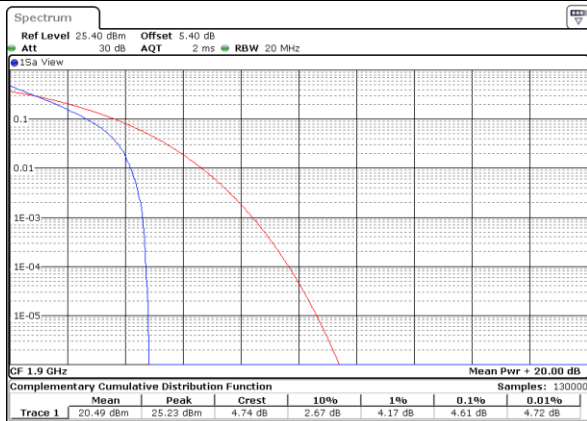

Date: 1 AUG 2019 03:20:05

Highest Channel / Full RB



Date: 1 AUG 2019 03:20:14



LTE Band 2 / 20MHz / 16QAM

Lowest Channel / 1RB

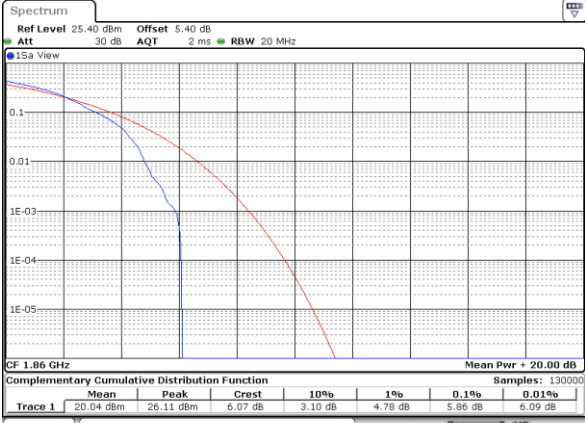

Date: 1 AUG 2019 03:17:34

Lowest Channel / Full RB

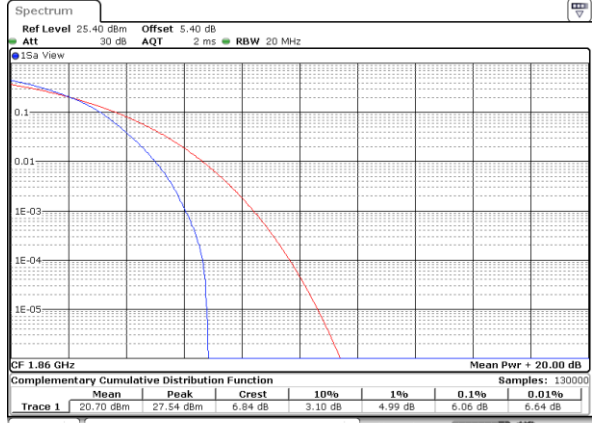

Date: 1 AUG 2019 03:17:43

Middle Channel / 1RB

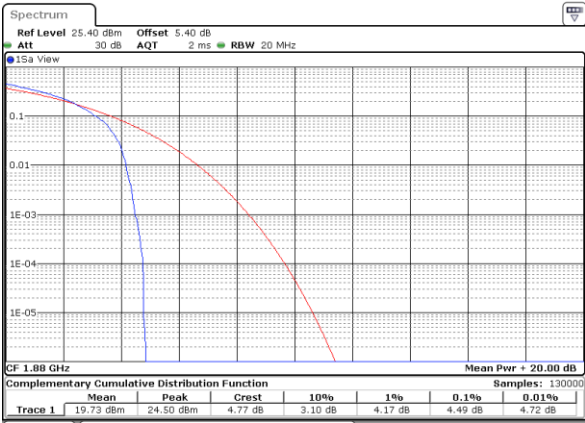

Date: 1 AUG 2019 03:17:52

Middle Channel / Full RB

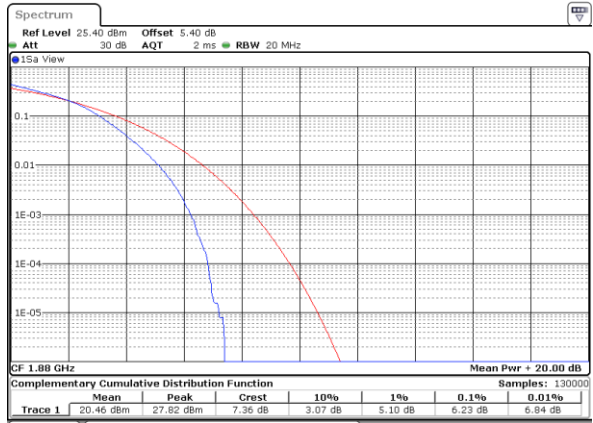

Date: 1 AUG 2019 03:18:01

Highest Channel / 1RB

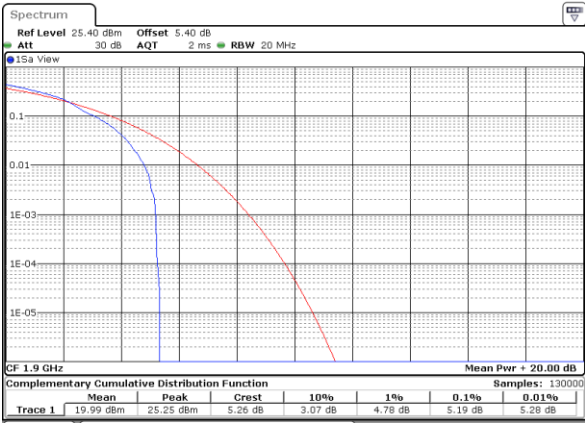

Date: 1 AUG 2019 03:18:10

Highest Channel / Full RB

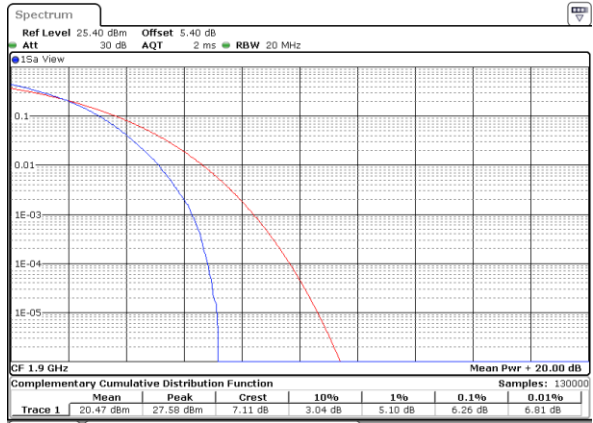

Date: 1 AUG 2019 03:18:18



LTE Band 4 / 20MHz / QPSK

Lowest Channel / 1RB

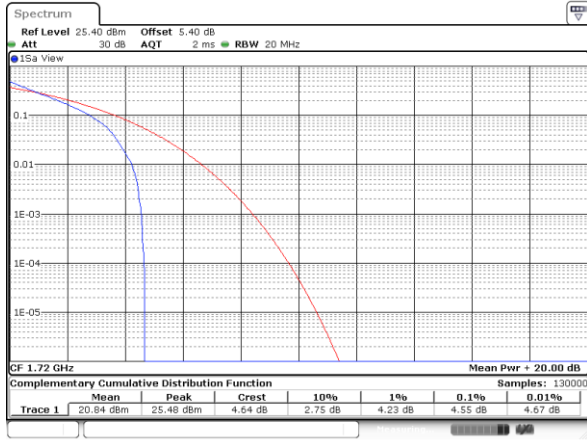

Date: 1 AUG 2019 05:43:59

Lowest Channel / Full RB

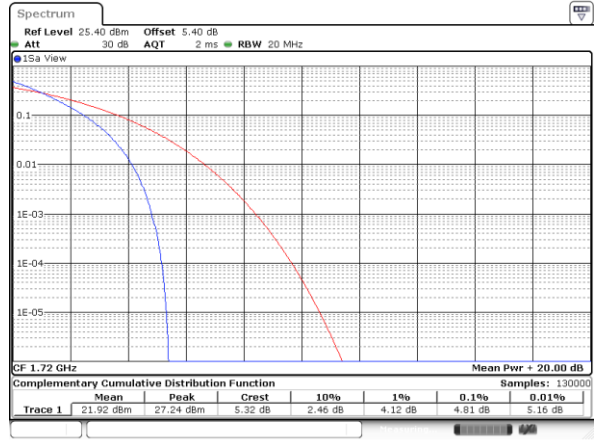

Date: 1 AUG 2019 05:43:50

Middle Channel / 1RB

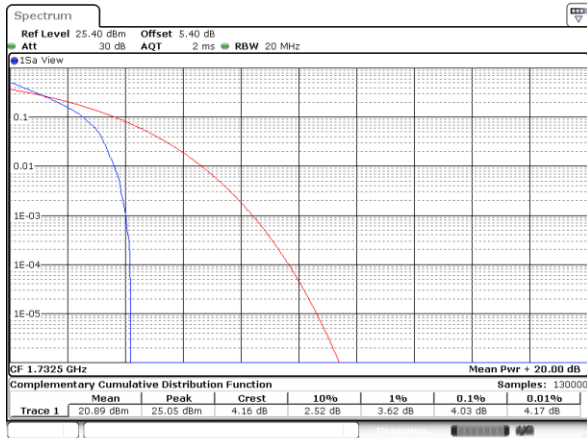

Date: 1 AUG 2019 05:44:17

Middle Channel / Full RB

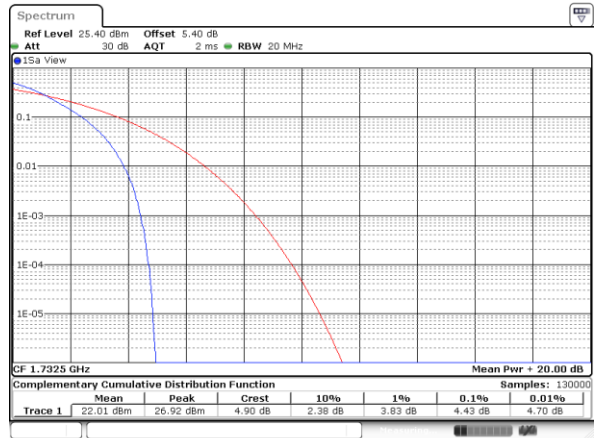

Date: 1 AUG 2019 05:44:08

Highest Channel / 1RB

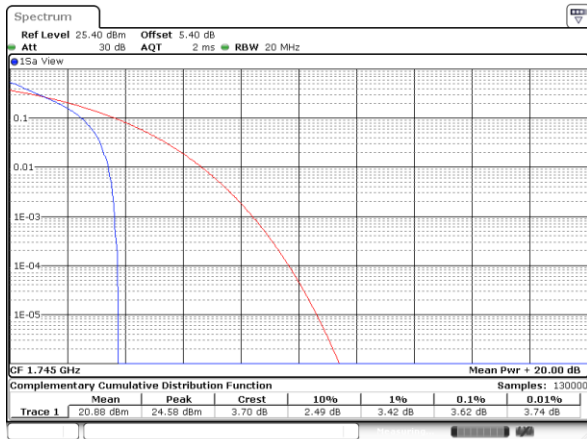

Date: 1 AUG 2019 05:44:36

Highest Channel / Full RB

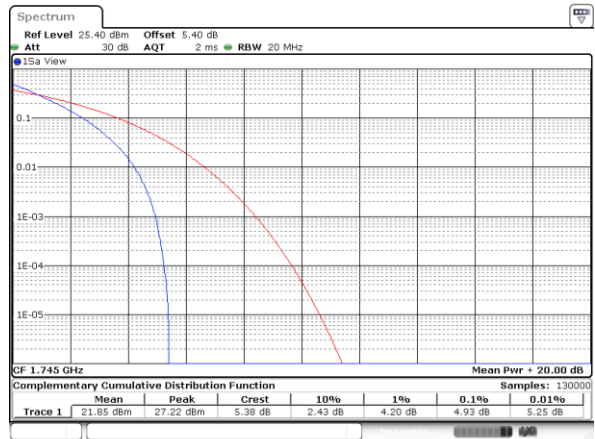

Date: 1 AUG 2019 05:44:26



LTE Band 4 / 20MHz / 16QAM

Lowest Channel / 1RB

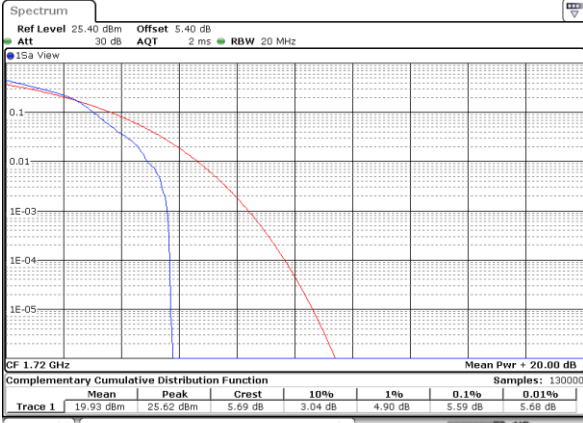

Date: 1 AUG 2019 05:39:54

Lowest Channel / Full RB

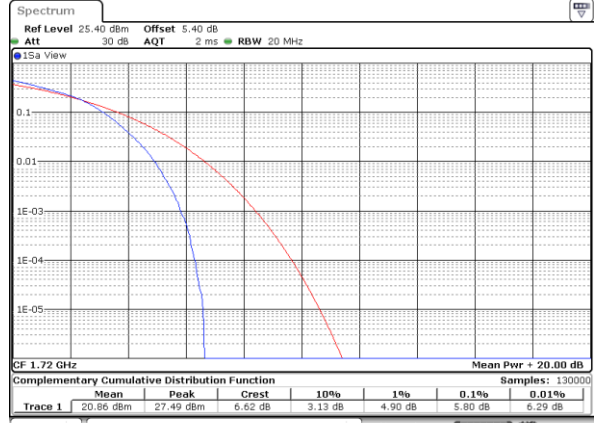

Date: 1 AUG 2019 05:40:03

Middle Channel / 1RB

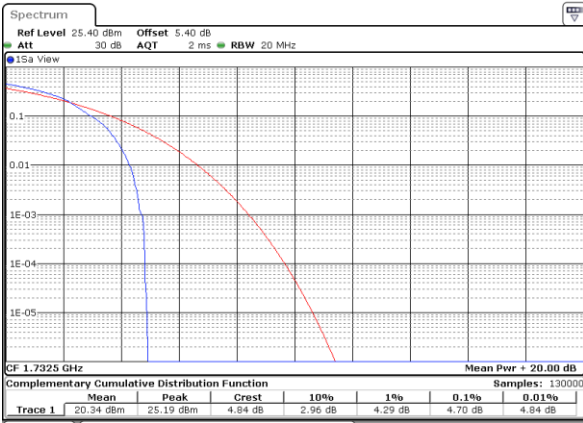

Date: 1 AUG 2019 05:40:11

Middle Channel / Full RB

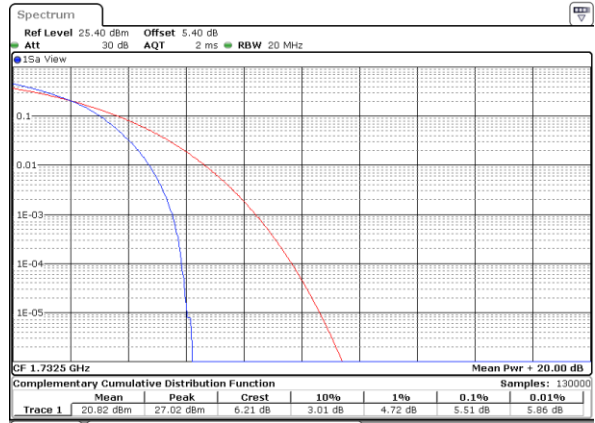

Date: 1 AUG 2019 05:40:20

Highest Channel / 1RB

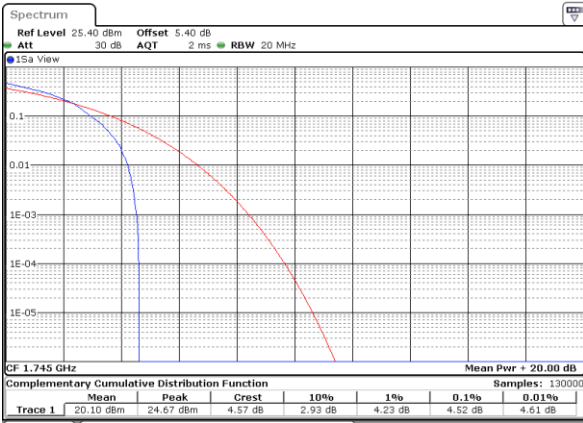

Date: 1 AUG 2019 05:40:30

Highest Channel / Full RB

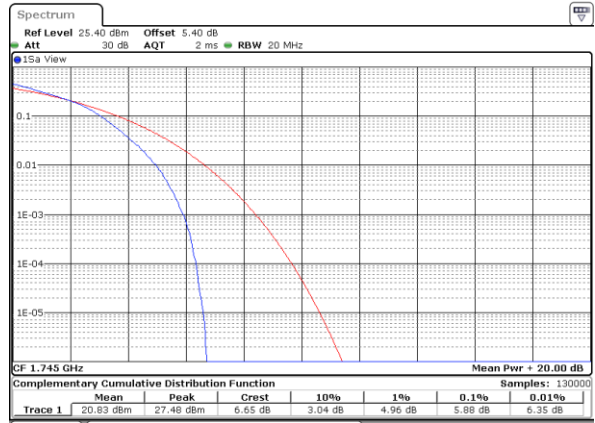

Date: 1 AUG 2019 05:40:39



LTE Band 5 / 10MHz / QPSK

Lowest Channel / 1RB

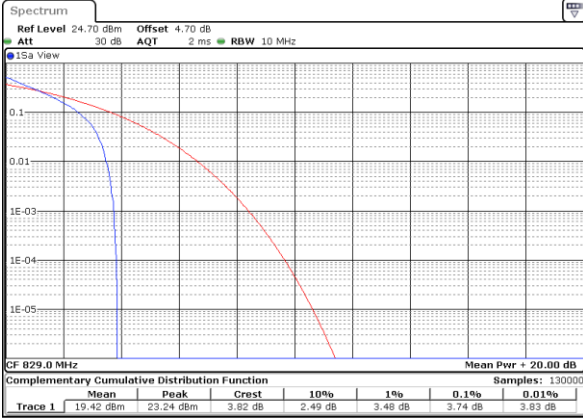

Date: 5 AUG 2019 16:20:41

Lowest Channel / Full RB

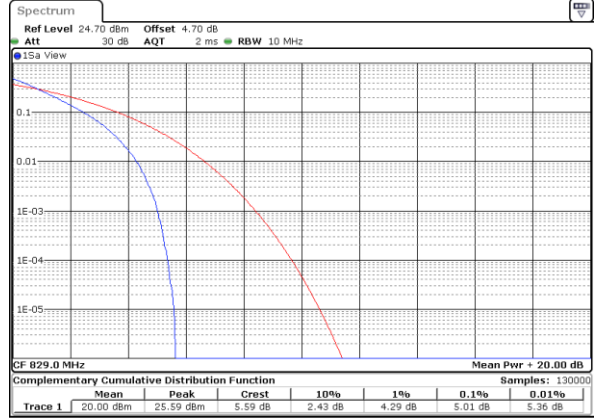

Date: 5 AUG 2019 16:20:50

Middle Channel / 1RB

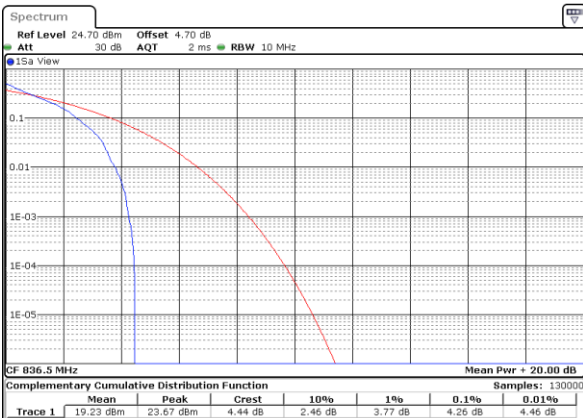

Date: 5 AUG 2019 16:21:12

Middle Channel / Full RB

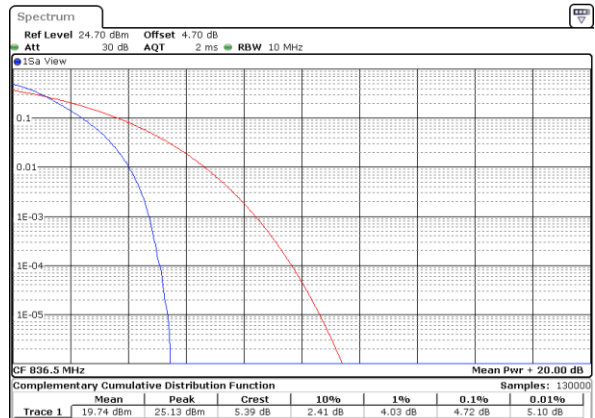

Date: 5 AUG 2019 16:21:03

Highest Channel / 1RB

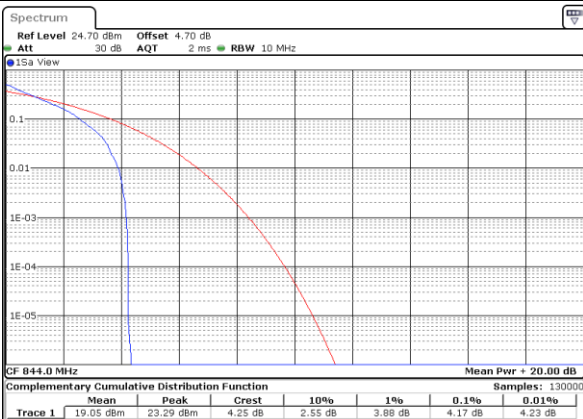

Date: 5 AUG 2019 16:21:22

Highest Channel / Full RB



Date: 5 AUG 2019 16:21:31



LTE Band 5 / 10MHz / 16QAM

Lowest Channel / 1RB

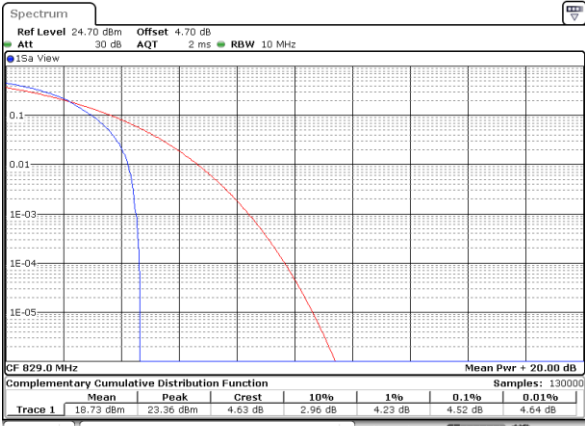

Date: 5 AUG 2019 16:19:44

Lowest Channel / Full RB

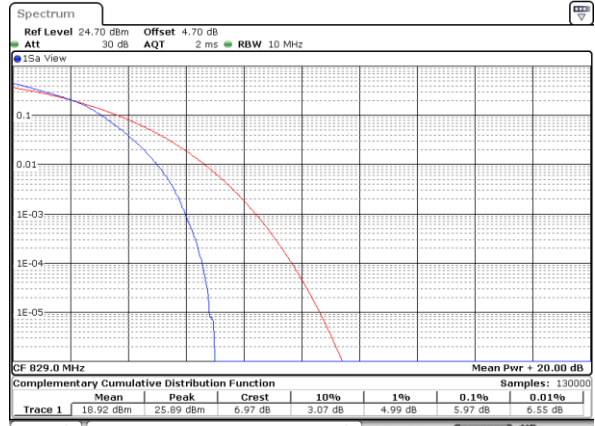

Date: 5 AUG 2019 16:19:53

Middle Channel / 1RB

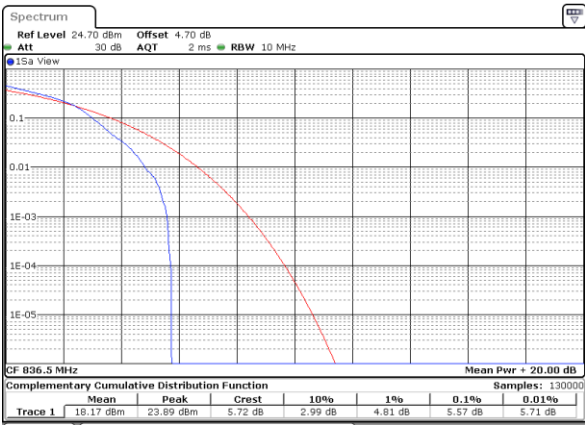

Date: 5 AUG 2019 16:20:02

Middle Channel / Full RB

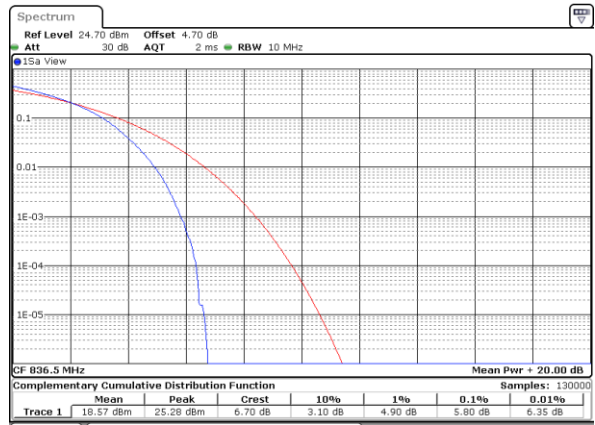

Date: 5 AUG 2019 16:20:13

Highest Channel / 1RB

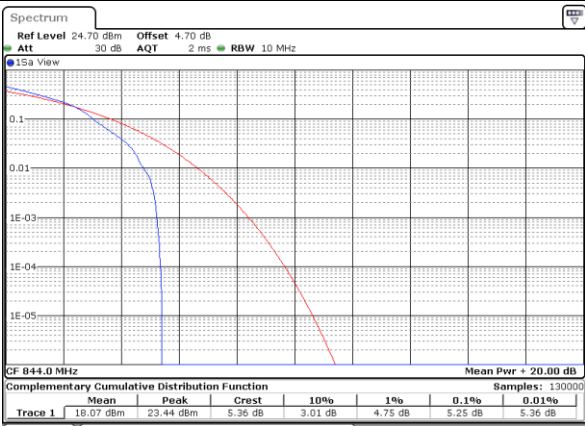

Date: 5 AUG 2019 16:20:22

Highest Channel / Full RB



Date: 5 AUG 2019 16:20:32



LTE Band 7 / 20MHz / QPSK

Lowest Channel / 1RB

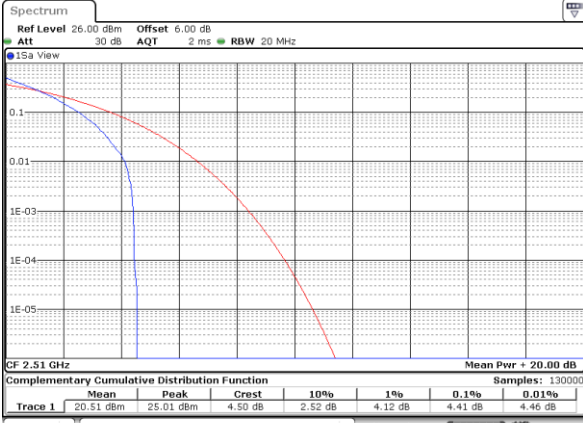

Date: 8 AUG 2019 11:02:41

Lowest Channel / Full RB

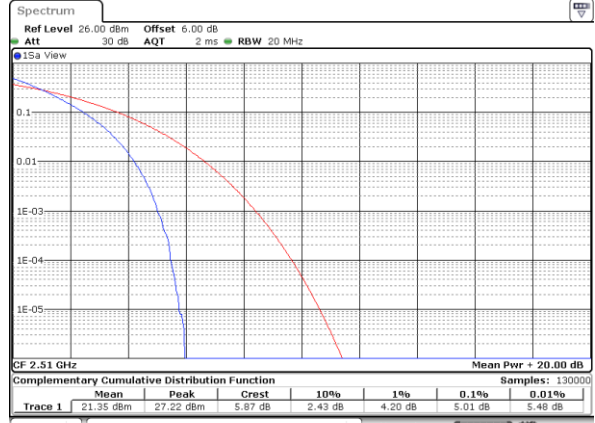

Date: 8 AUG 2019 11:02:53

Middle Channel / 1RB

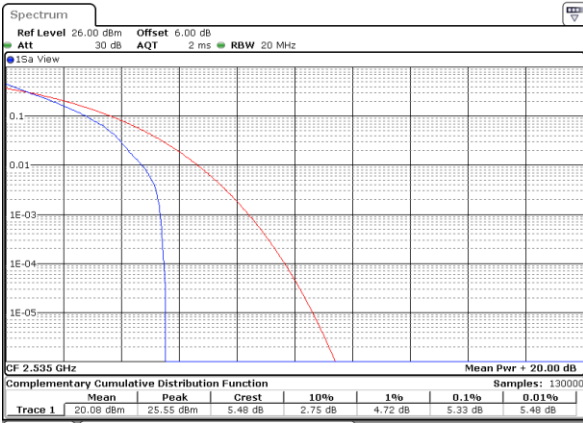

Date: 8 AUG 2019 11:04:04

Middle Channel / Full RB

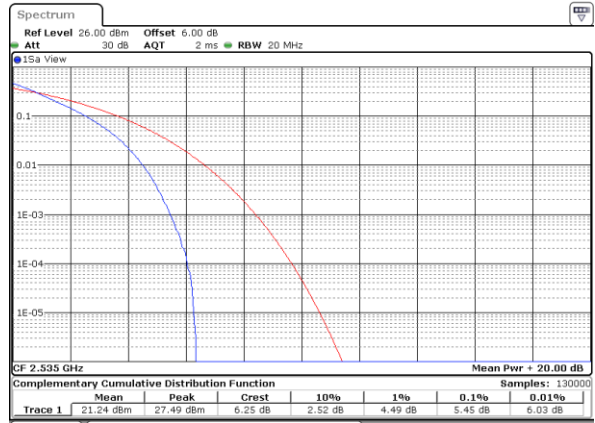

Date: 8 AUG 2019 11:03:34

Highest Channel / 1RB

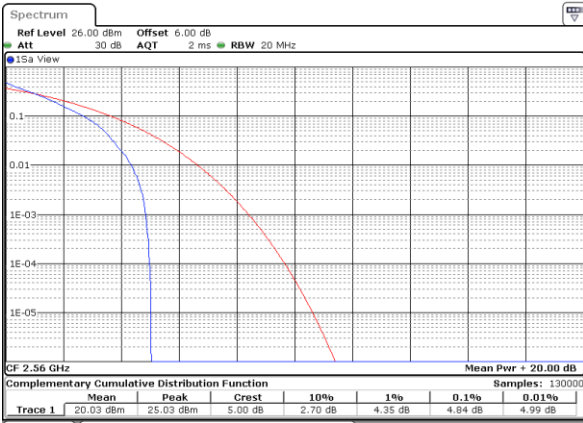

Date: 8 AUG 2019 11:04:43

Highest Channel / Full RB

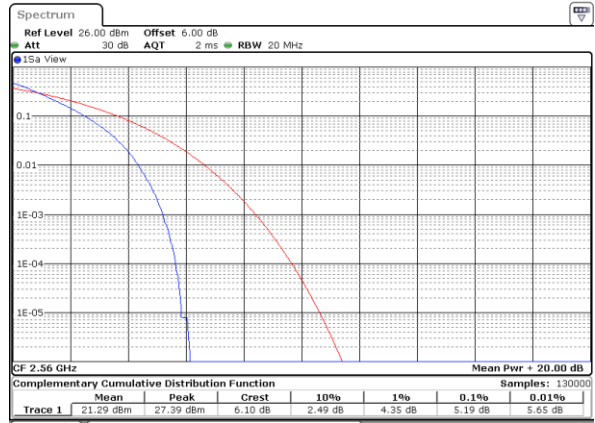

Date: 8 AUG 2019 11:04:52



LTE Band 7 / 20MHz / 16QAM

Lowest Channel / 1RB

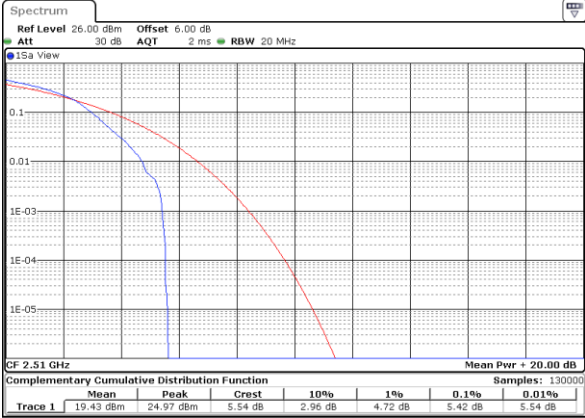

Date: 8 AUG 2019 11:02:32

Lowest Channel / Full RB

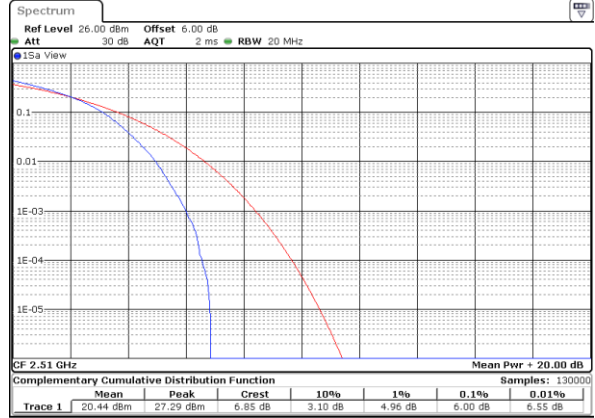

Date: 8 AUG 2019 11:03:02

Middle Channel / 1RB

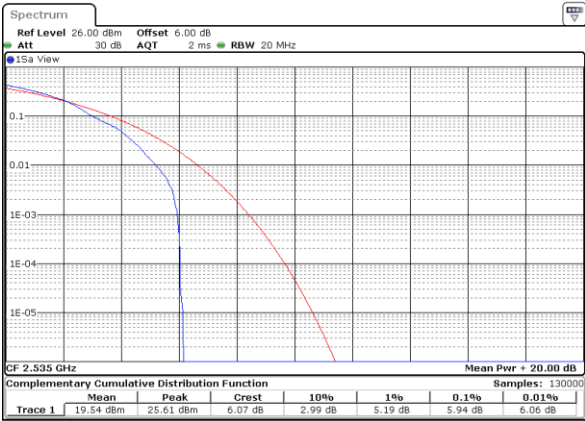

Date: 8 AUG 2019 11:04:13

Middle Channel / Full RB

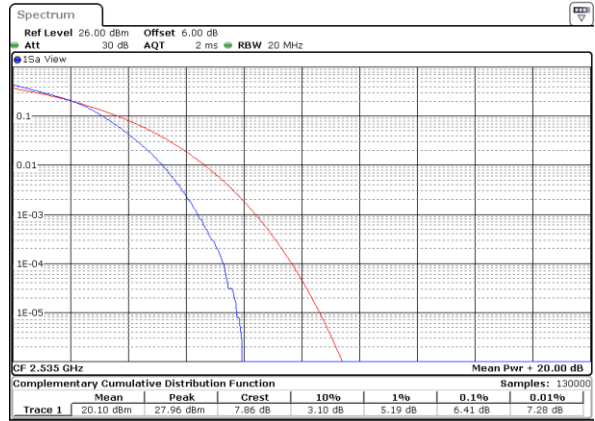

Date: 8 AUG 2019 11:03:18

Highest Channel / 1RB

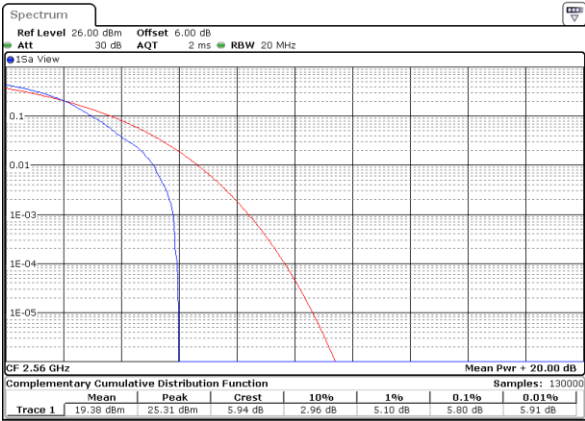

Date: 8 AUG 2019 11:04:22

Highest Channel / Full RB

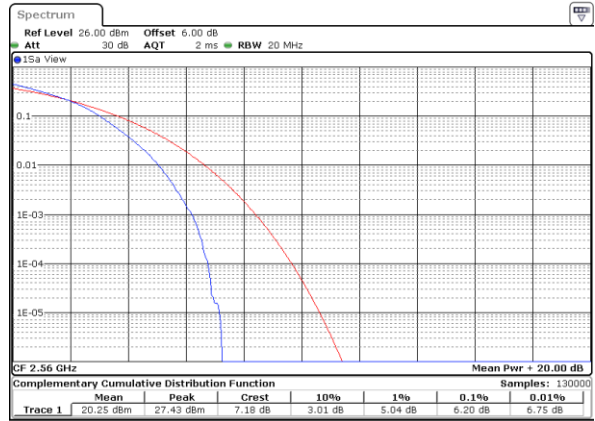

Date: 8 AUG 2019 11:05:01



**26dB Bandwidth**

Mode	LTE Band 2 : 26dB BW(MHz)											
	1.4MHz		3MHz		5MHz		10MHz		15MHz		20MHz	
Mod.	QPSK	16QAM	QPSK	16QAM	QPSK	16QAM	QPSK	16QAM	QPSK	16QAM	QPSK	16QAM
Lowest CH	1.245	1.295	2.961	2.985	5.085	4.885	9.850	10.010	14.925	14.835	20.100	20.140
Middle CH	1.267	1.273	2.937	2.979	4.895	5.115	10.07	9.950	14.715	14.446	20.220	20.300
Highest CH	1.273	1.253	2.967	2.979	5.015	5.165	9.930	9.910	14.685	14.535	20.220	20.100

Mode	LTE Band 4 : 26dB BW(MHz)											
	1.4MHz		3MHz		5MHz		10MHz		15MHz		20MHz	
Mod.	QPSK	16QAM	QPSK	16QAM	QPSK	16QAM	QPSK	16QAM	QPSK	16QAM	QPSK	16QAM
Lowest CH	1.28	1.25	2.95	2.94	5.12	4.98	9.89	9.87	14.69	14.69	20.3	20.06
Middle CH	1.29	1.29	2.93	2.94	4.93	4.96	9.83	10.03	14.36	14.48	20.02	20.38
Highest CH	1.26	1.28	2.97	2.99	4.89	5.16	9.79	9.73	14.48	14.54	20.22	20.18

Mode	LTE Band 5 : 26dB BW(MHz)											
	1.4MHz		3MHz		5MHz		10MHz		15MHz		20MHz	
Mod.	QPSK	16QAM	QPSK	16QAM	QPSK	16QAM	QPSK	16QAM	QPSK	16QAM	QPSK	16QAM
Lowest CH	1.281	1.259	2.943	2.937	5.085	5.065	10.15	9.93	-	-	-	-
Middle CH	1.295	1.264	2.961	2.949	4.995	4.995	10.21	9.79	-	-	-	-
Highest CH	1.273	1.245	2.955	2.973	5.015	4.995	10.19	9.81	-	-	-	-

Mode	LTE Band 7 : 26dB BW(MHz)											
	1.4MHz		3MHz		5MHz		10MHz		15MHz		20MHz	
Mod.	QPSK	16QAM	QPSK	16QAM	QPSK	16QAM	QPSK	16QAM	QPSK	16QAM	QPSK	16QAM
Lowest CH					5.03	4.97	9.81	9.83	14.60	14.21	20.06	20.06
Middle CH					5.00	5.08	10.03	9.81	14.48	15.23	20.42	20.66
Highest CH					4.97	5.01	9.91	9.95	14.63	14.42	20.18	20.50



LTE Band 2

Lowest Channel / 1.4MHz / QPSK

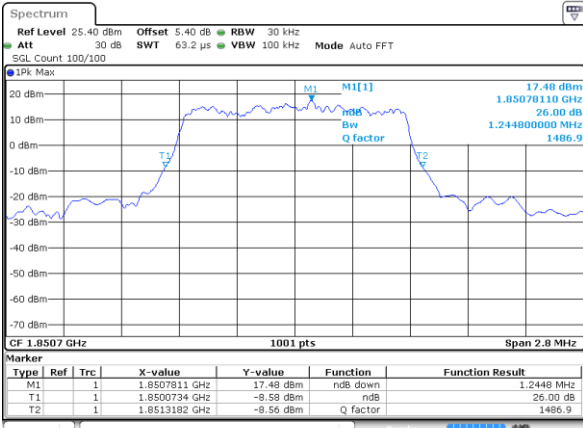

Date: 1 AUG 2019 01:30:29

Lowest Channel / 1.4MHz / 16QAM

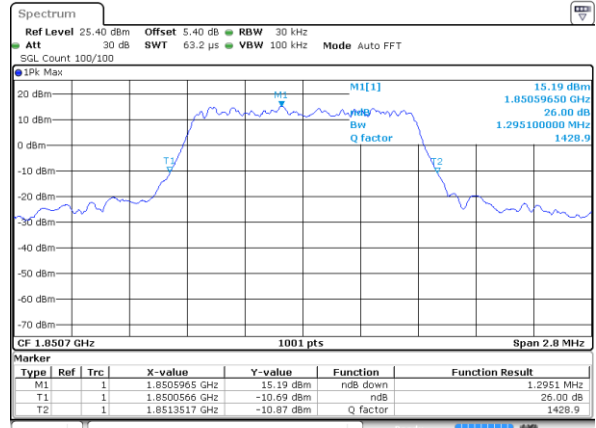

Date: 1 AUG 2019 01:30:39

Middle Channel / 1.4MHz / QPSK

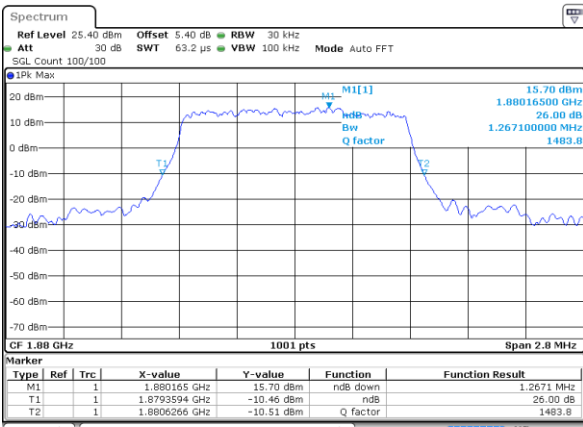

Date: 1 AUG 2019 01:37:29

Middle Channel / 1.4MHz / 16QAM

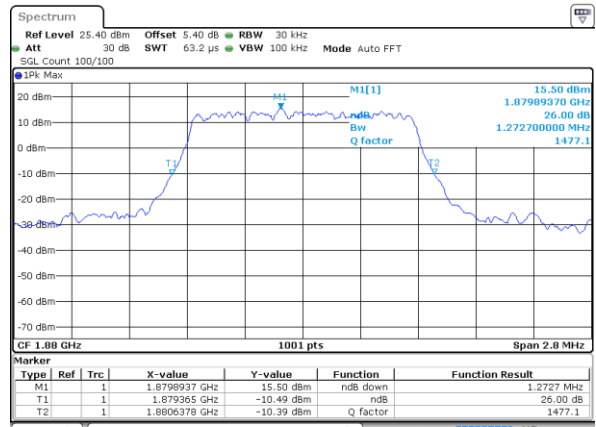

Date: 1 AUG 2019 01:37:39

Highest Channel / 1.4MHz / QPSK

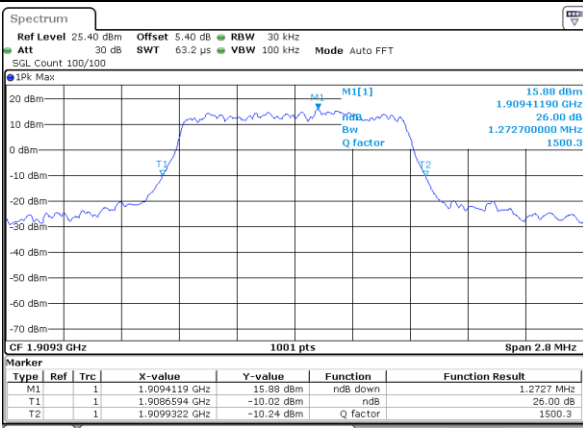

Date: 1 AUG 2019 01:39:59

Highest Channel / 1.4MHz / 16QAM

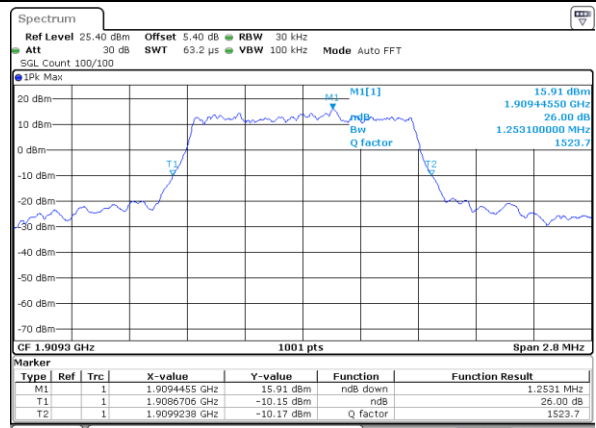

Date: 1 AUG 2019 01:40:09



LTE Band 2

Lowest Channel / 3MHz / QPSK

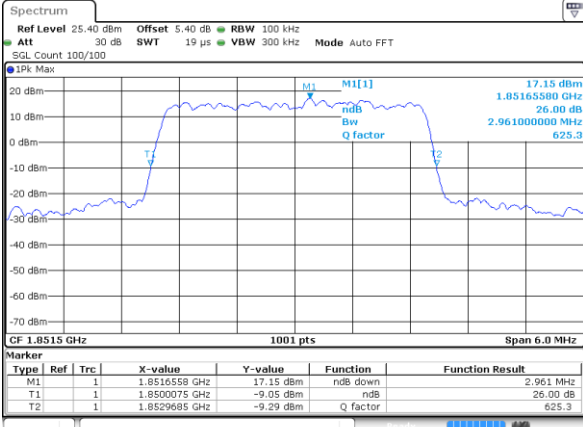

Date: 1 AUG 2019 01:46:59

Lowest Channel / 3MHz / 16QAM

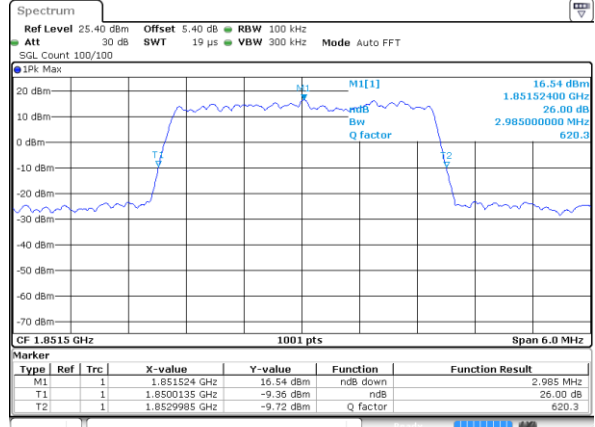

Date: 1 AUG 2019 01:47:09

Middle Channel / 3MHz / QPSK

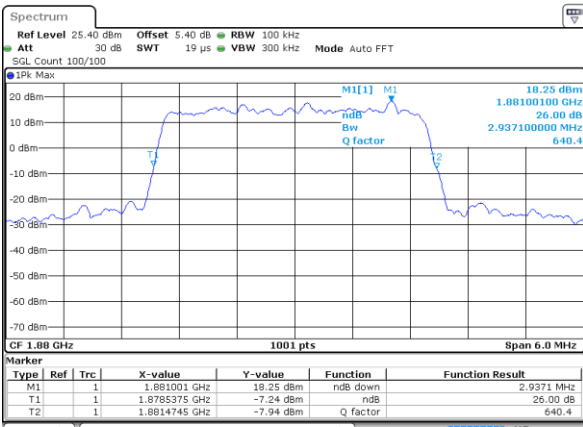

Date: 1 AUG 2019 01:53:59

Middle Channel / 3MHz / 16QAM

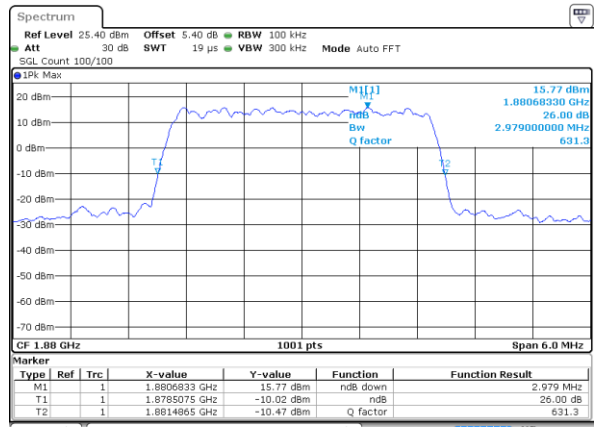

Date: 1 AUG 2019 01:54:09

Highest Channel / 3MHz / QPSK

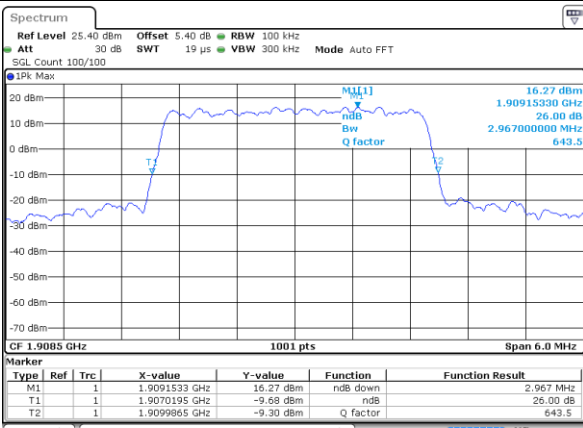

Date: 1 AUG 2019 01:56:29

Highest Channel / 3MHz / 16QAM

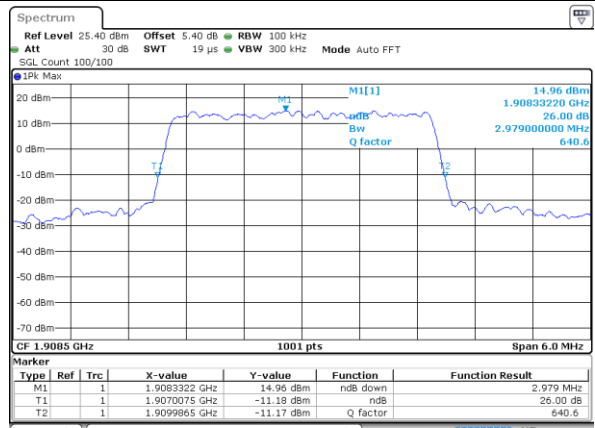

Date: 1 AUG 2019 01:56:39



LTE Band 2

Lowest Channel / 5MHz / QPSK

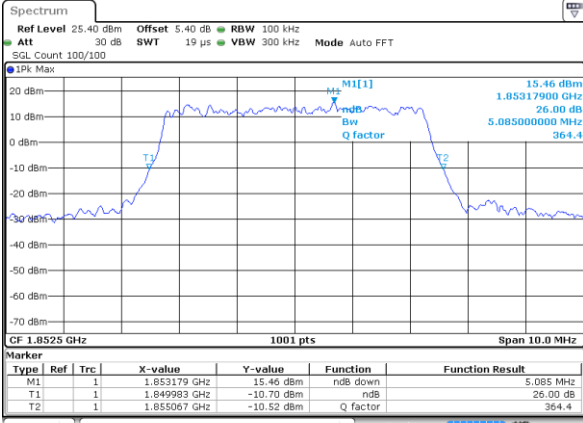

Date: 1 AUG 2019 02:03:29

Lowest Channel / 5MHz / 16QAM

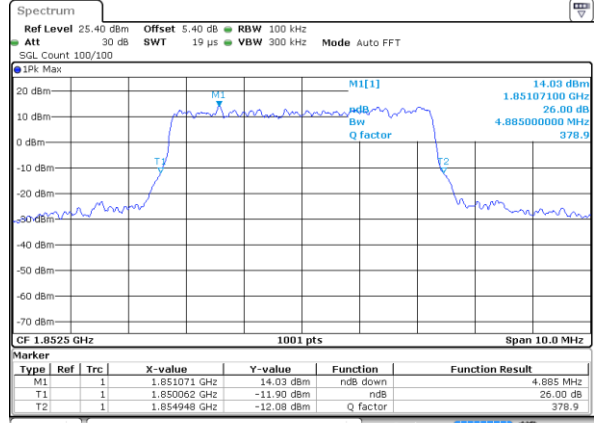

Date: 1 AUG 2019 02:03:39

Middle Channel / 5MHz / QPSK

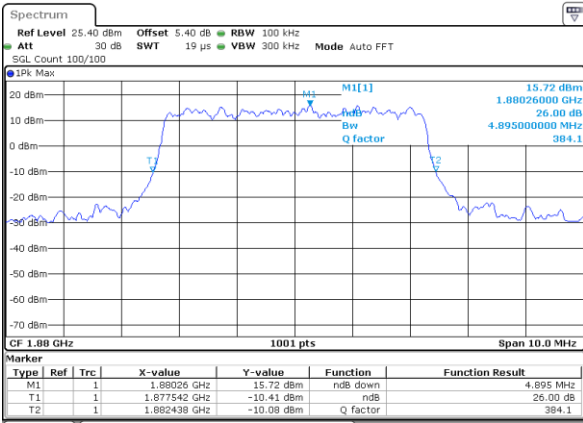

Date: 1 AUG 2019 02:10:29

Middle Channel / 5MHz / 16QAM

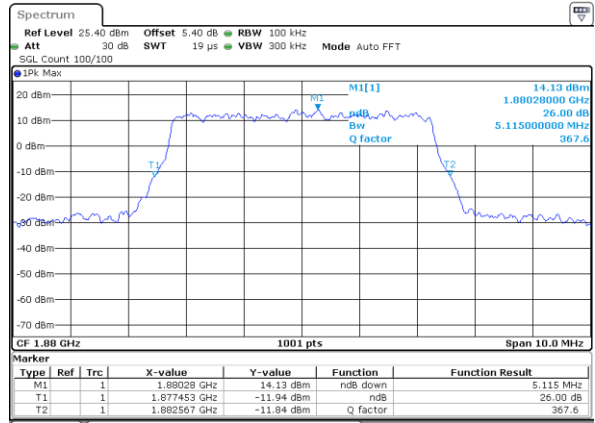

Date: 1 AUG 2019 02:10:39

Highest Channel / 5MHz / QPSK

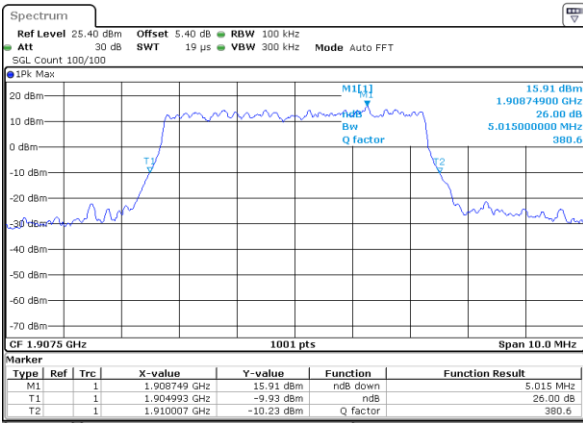

Date: 1 AUG 2019 02:12:59

Highest Channel / 5MHz / 16QAM

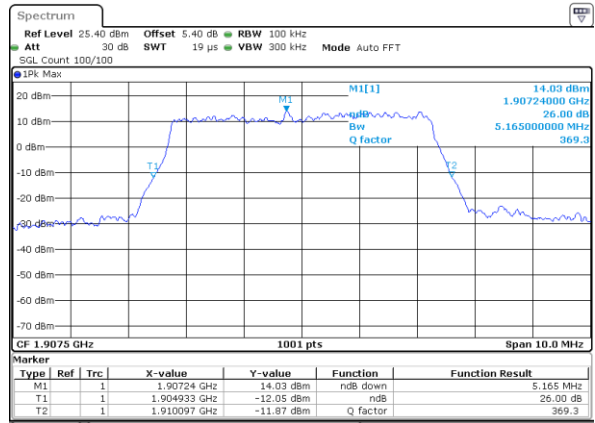

Date: 1 AUG 2019 02:13:09



LTE Band 2

Lowest Channel / 10MHz / QPSK

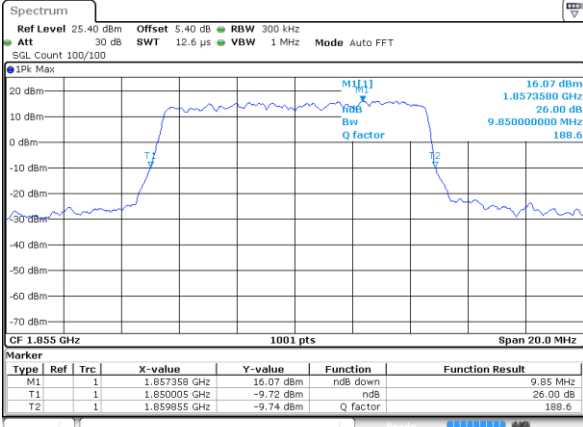

Date: 1 AUG 2019 02:19:59

Lowest Channel / 10MHz / 16QAM

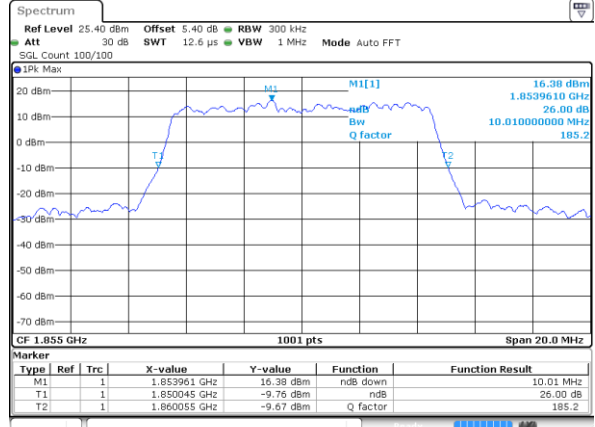

Date: 1 AUG 2019 02:20:09

Middle Channel / 10MHz / QPSK

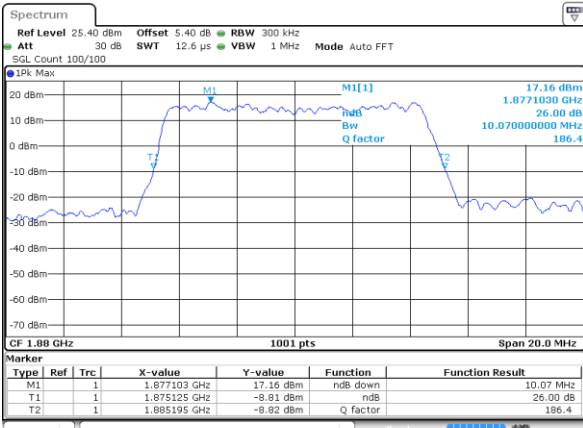

Date: 1 AUG 2019 02:26:59

Middle Channel / 10MHz / 16QAM

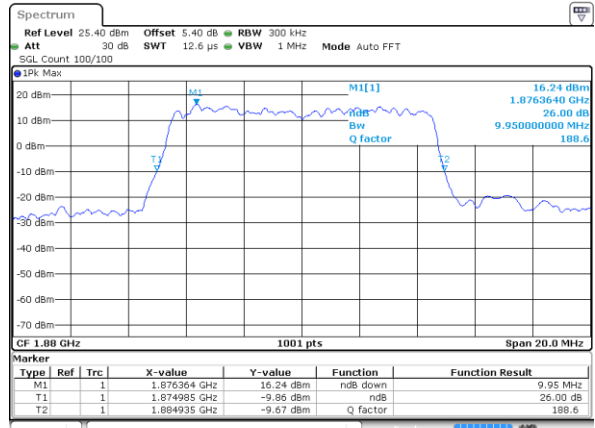

Date: 1 AUG 2019 02:27:09

Highest Channel / 10MHz / QPSK

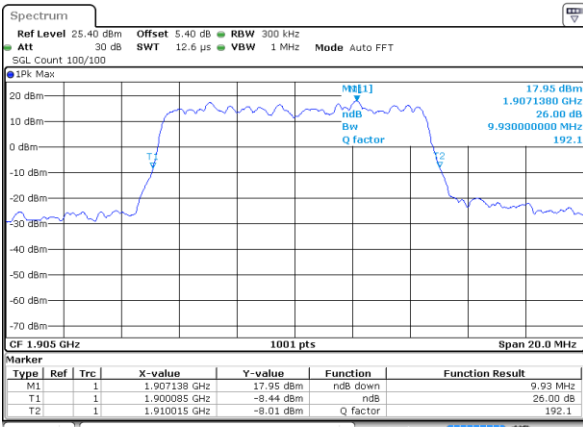

Date: 1 AUG 2019 02:29:29

Highest Channel / 10MHz / 16QAM

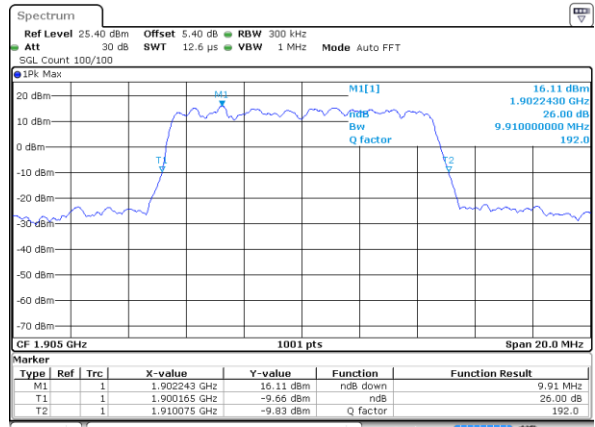

Date: 1 AUG 2019 02:29:39



LTE Band 2

Lowest Channel / 15MHz / QPSK

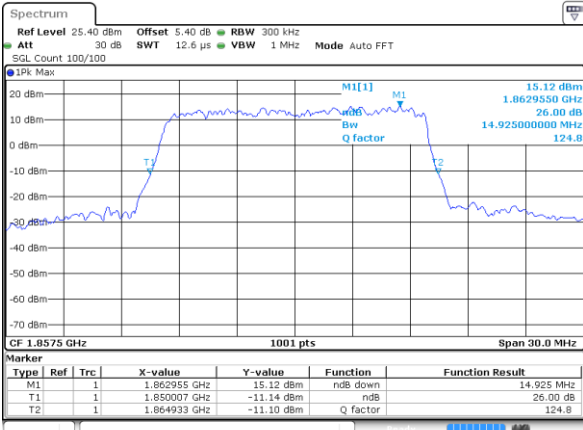

Date: 1 AUG 2019 02:36:29

Lowest Channel / 15MHz / 16QAM

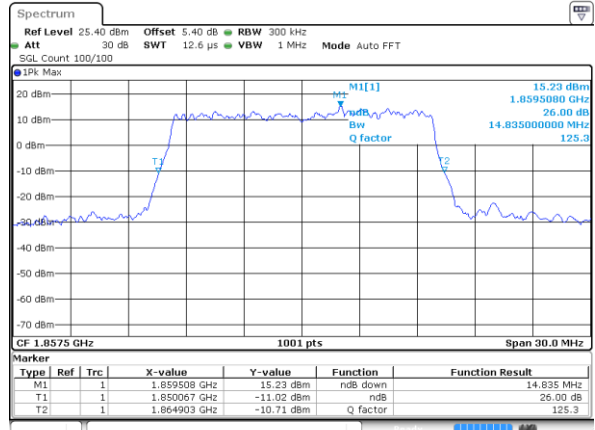

Date: 1 AUG 2019 02:36:39

Middle Channel / 15MHz / QPSK

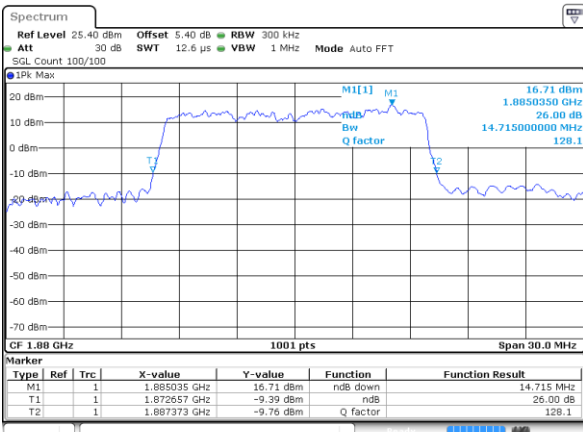

Date: 1 AUG 2019 02:43:29

Middle Channel / 15MHz / 16QAM

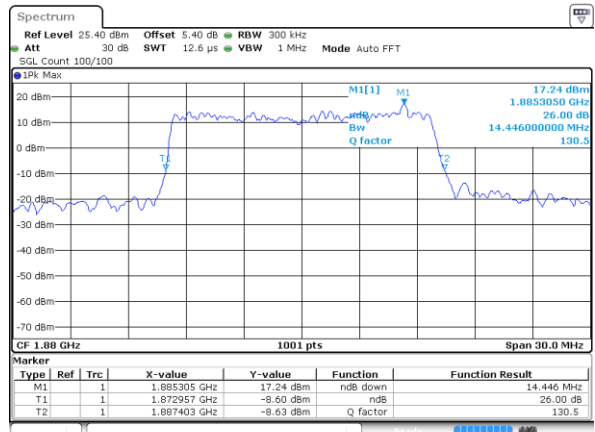

Date: 1 AUG 2019 02:43:40

Highest Channel / 15MHz / QPSK

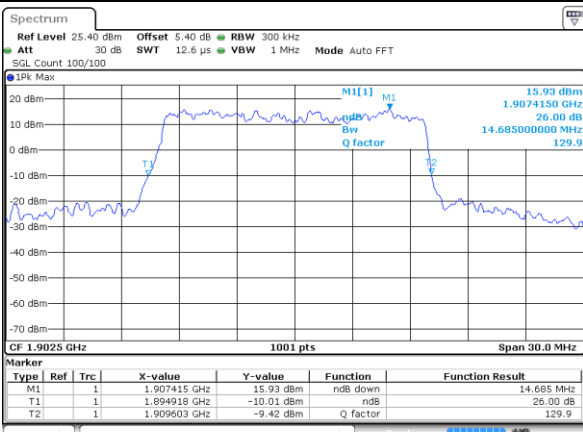

Date: 1 AUG 2019 02:53:40

Highest Channel / 15MHz / 16QAM

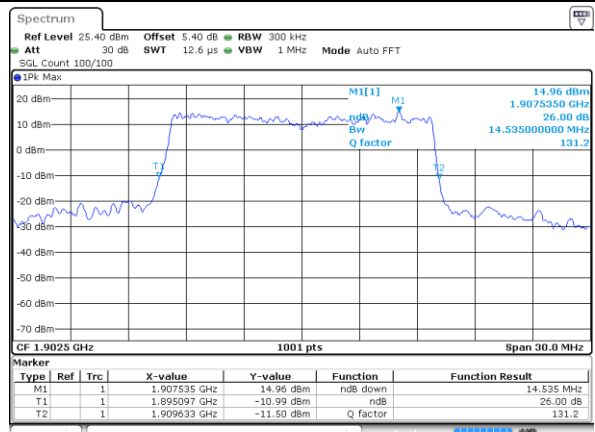

Date: 1 AUG 2019 02:53:50



LTE Band 2

Lowest Channel / 20MHz / QPSK

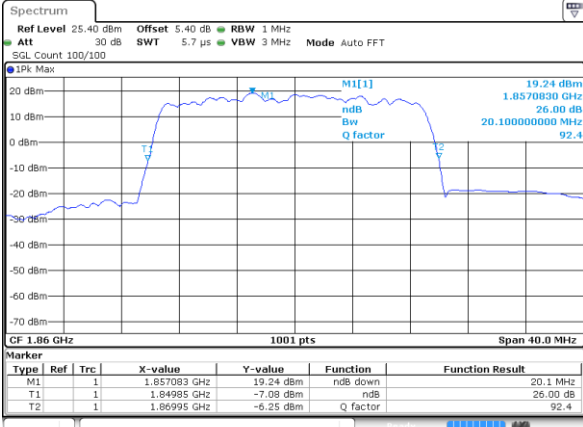

Date: 1 AUG 2019 03:00:40

Lowest Channel / 20MHz / 16QAM

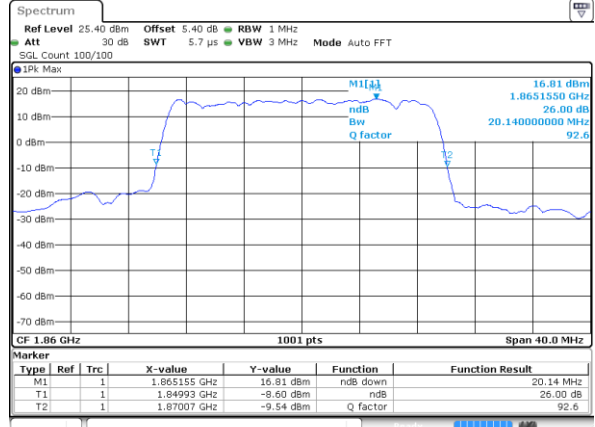

Date: 1 AUG 2019 03:00:50

Middle Channel / 20MHz / QPSK

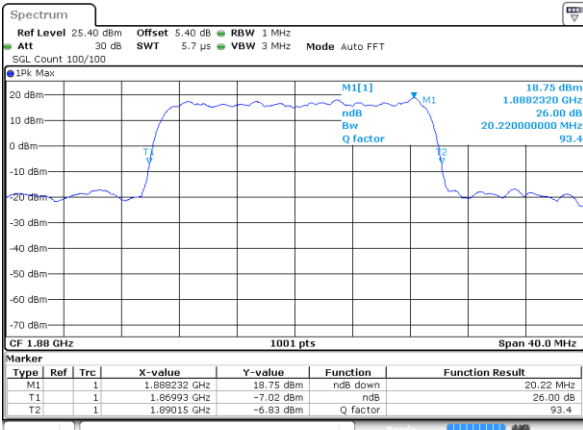

Date: 1 AUG 2019 03:07:40

Middle Channel / 20MHz / 16QAM

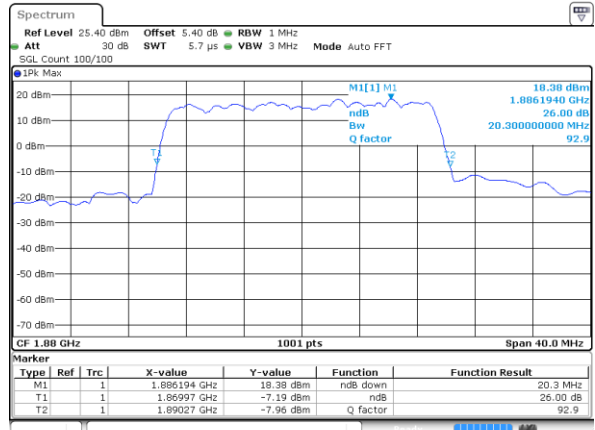

Date: 1 AUG 2019 03:07:50

Highest Channel / 20MHz / QPSK

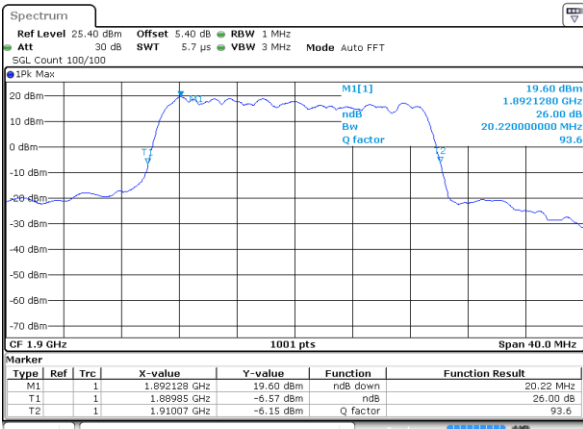

Date: 1 AUG 2019 03:10:10

Highest Channel / 20MHz / 16QAM

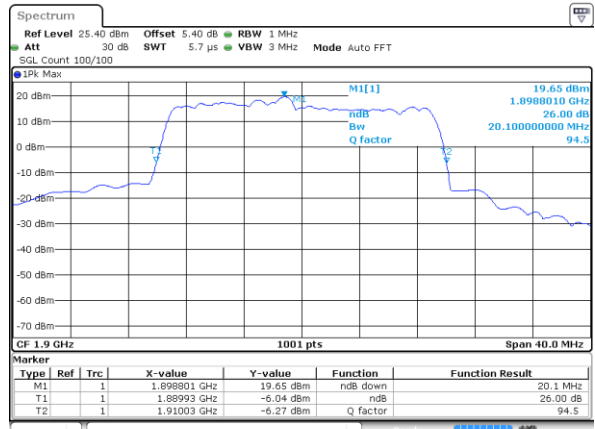

Date: 1 AUG 2019 03:10:20



LTE Band 4

Lowest Channel / 1.4MHz / QPSK

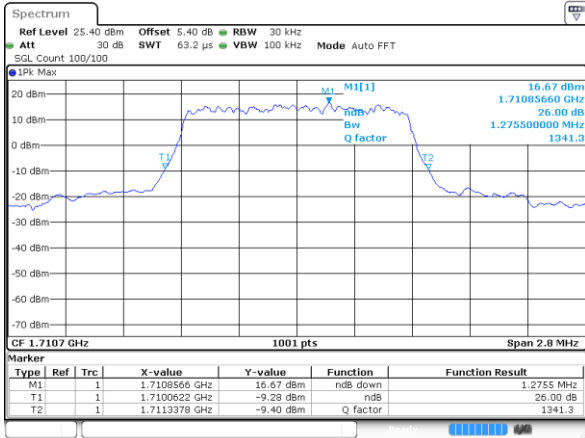

Date: 1 AUG 2019 03:21:46

Lowest Channel / 1.4MHz / 16QAM

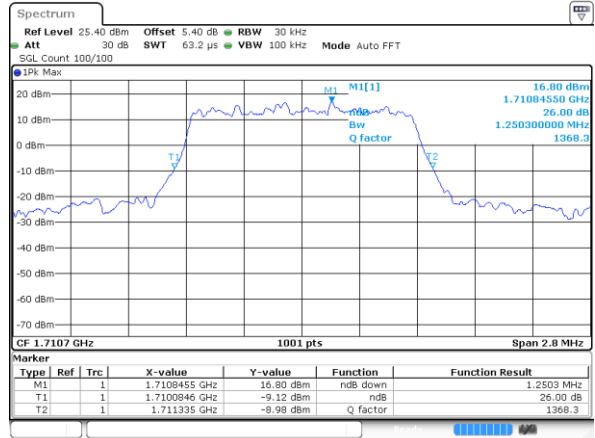

Date: 1 AUG 2019 03:21:56

Middle Channel / 1.4MHz / QPSK

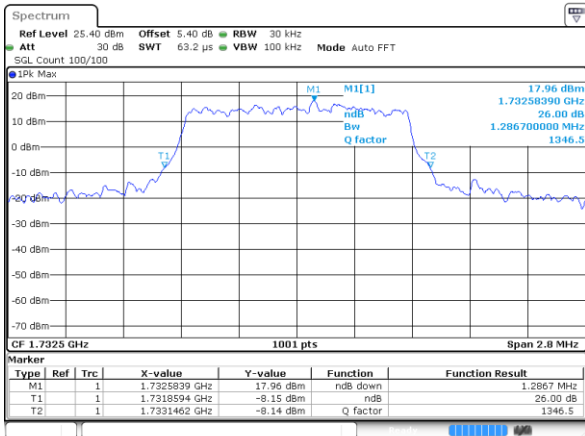

Date: 1 AUG 2019 03:28:46

Middle Channel / 1.4MHz / 16QAM

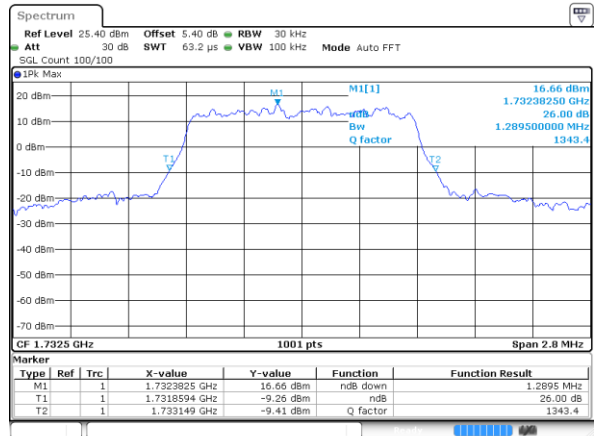

Date: 1 AUG 2019 03:28:56

Highest Channel / 1.4MHz / QPSK

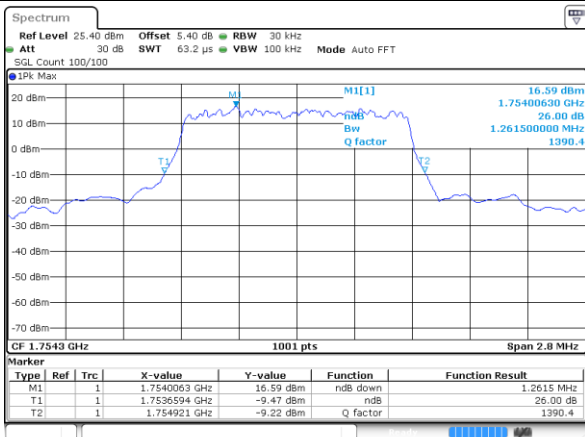

Date: 1 AUG 2019 03:31:16

Highest Channel / 1.4MHz / 16QAM

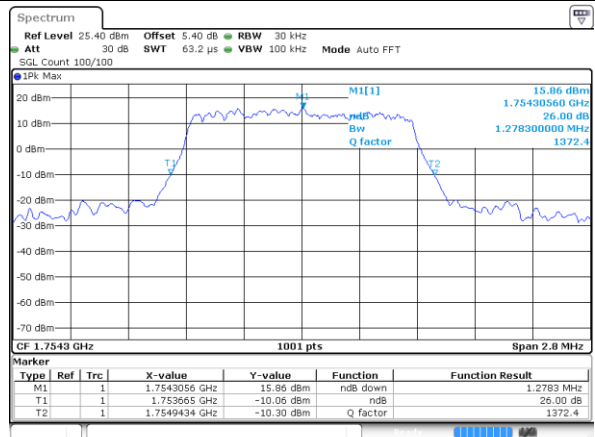

Date: 1 AUG 2019 03:31:26



LTE Band 4

Lowest Channel / 3MHz / QPSK

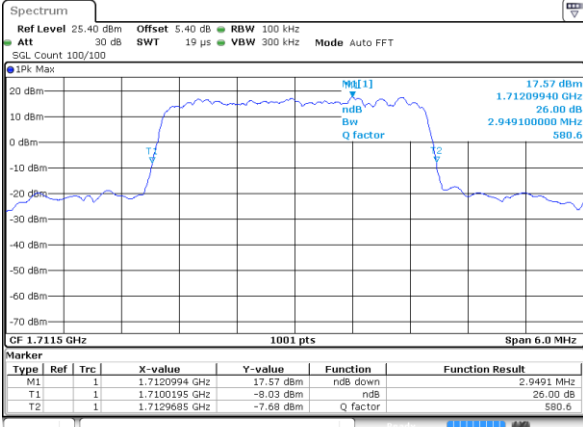

Date: 1 AUG 2019 03:38:16

Lowest Channel / 3MHz / 16QAM

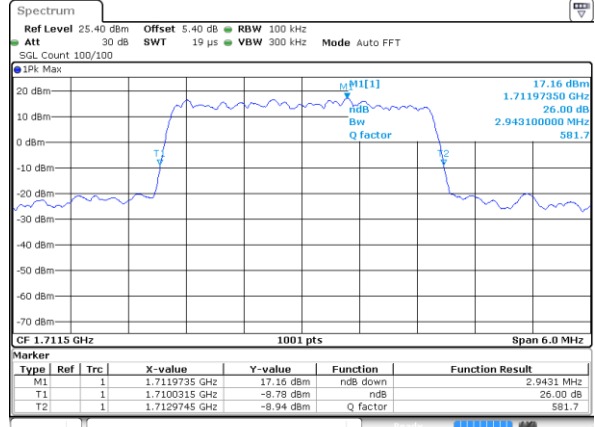

Date: 1 AUG 2019 03:38:26

Middle Channel / 3MHz / QPSK

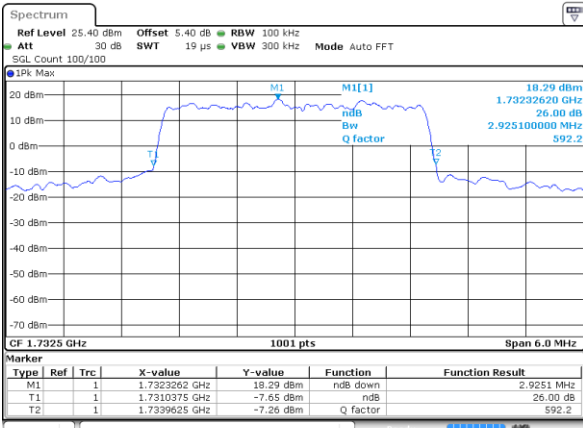

Date: 1 AUG 2019 03:45:16

Middle Channel / 3MHz / 16QAM

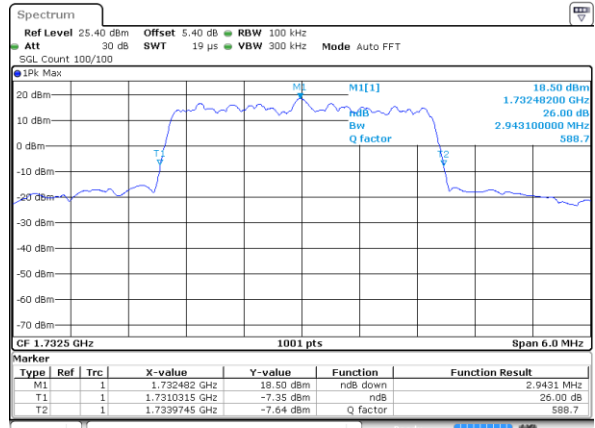

Date: 1 AUG 2019 03:45:26

Highest Channel / 3MHz / QPSK

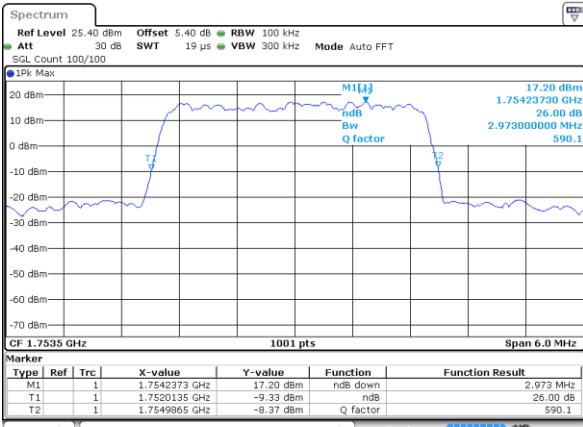

Date: 1 AUG 2019 03:47:46

Highest Channel / 3MHz / 16QAM

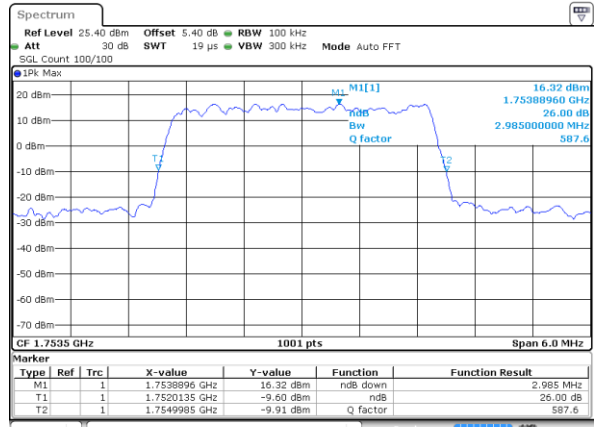

Date: 1 AUG 2019 03:47:56



LTE Band 4

Lowest Channel / 5MHz / QPSK

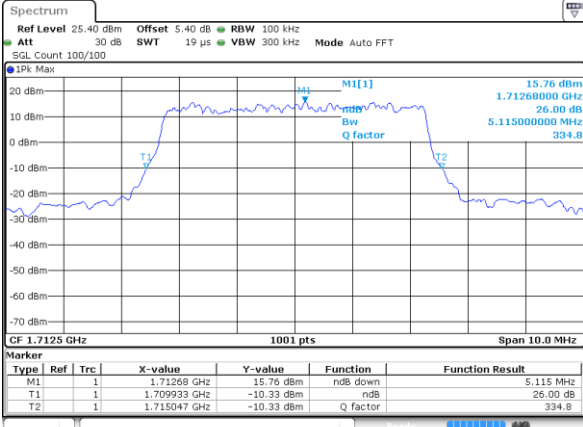

Date: 1 AUG 2019 03:54:46

Lowest Channel / 5MHz / 16QAM

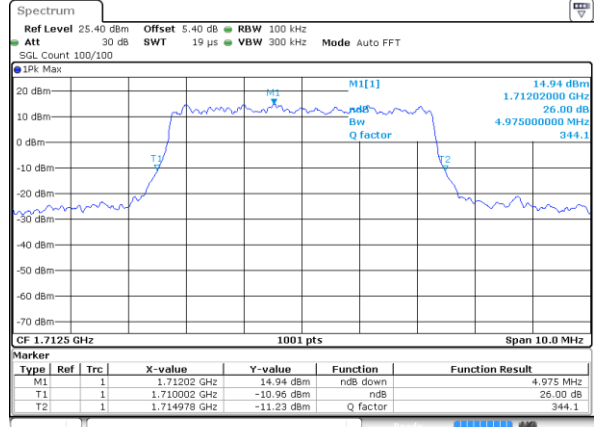

Date: 1 AUG 2019 03:54:56

Middle Channel / 5MHz / QPSK

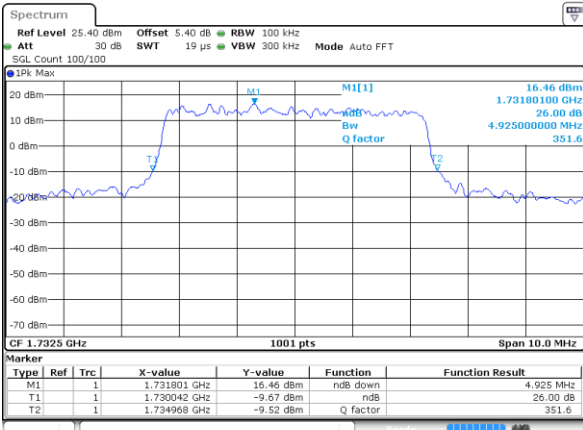

Date: 1 AUG 2019 04:01:46

Middle Channel / 5MHz / 16QAM

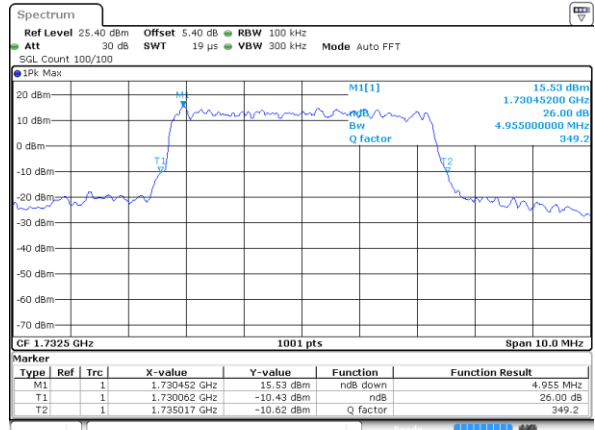

Date: 1 AUG 2019 04:01:56

Highest Channel / 5MHz / QPSK

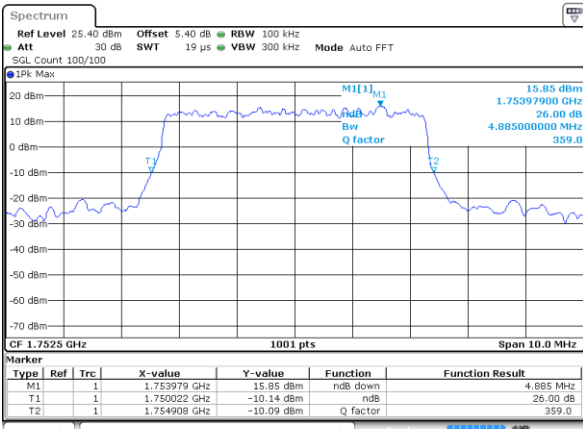

Date: 1 AUG 2019 04:04:16

Highest Channel / 5MHz / 16QAM

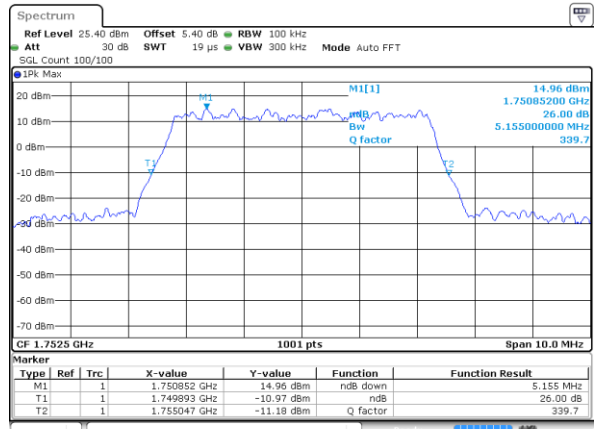

Date: 1 AUG 2019 04:04:26



LTE Band 4

Lowest Channel / 10MHz / QPSK

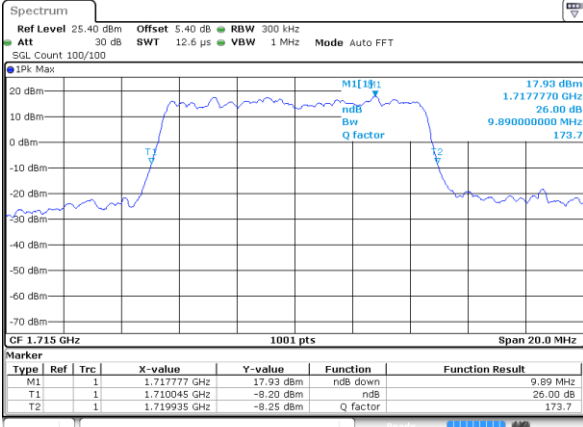

Date: 1 AUG 2019 04:34:16

Lowest Channel / 10MHz / 16QAM

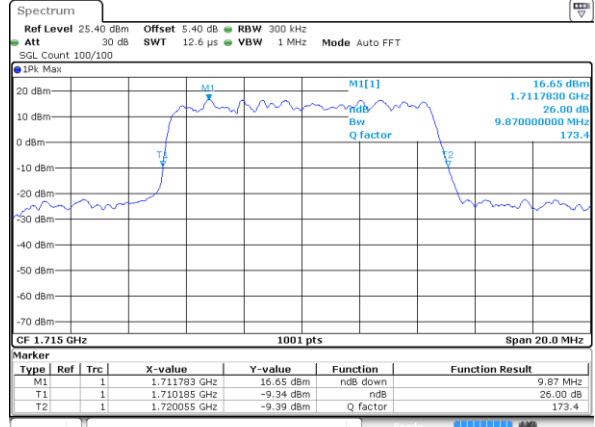

Date: 1 AUG 2019 04:34:26

Middle Channel / 10MHz / QPSK

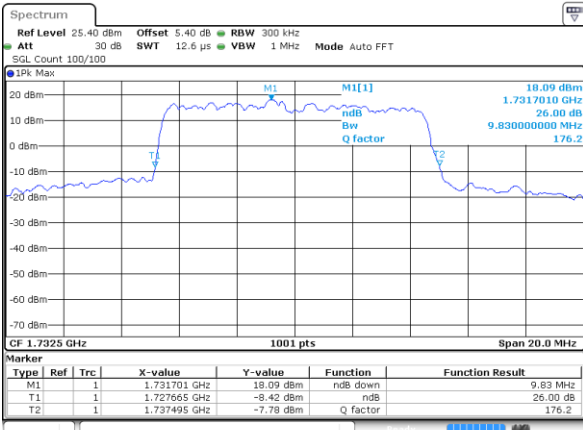

Date: 1 AUG 2019 04:41:16

Middle Channel / 10MHz / 16QAM

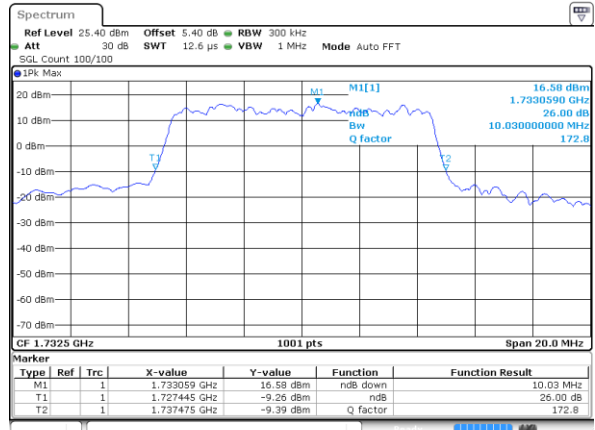

Date: 1 AUG 2019 04:41:26

Highest Channel / 10MHz / QPSK

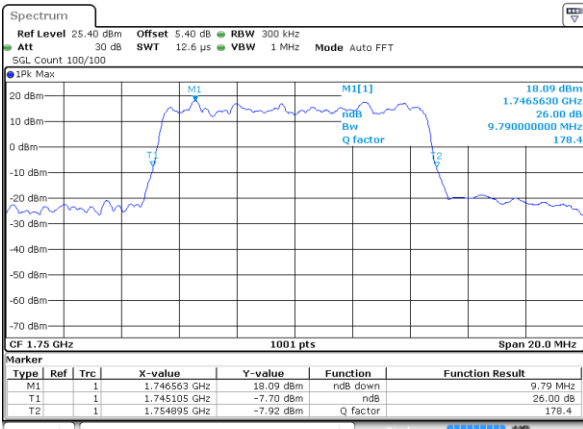

Date: 1 AUG 2019 04:43:46

Highest Channel / 10MHz / 16QAM

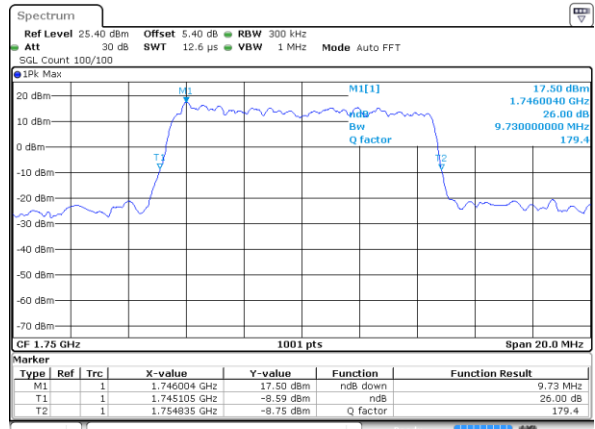

Date: 1 AUG 2019 04:43:56