



FCC RF Test Report

APPLICANT : Motorola Mobility LLC
EQUIPMENT : Mobile Cellular Phone
BRAND NAME : Motorola
MODEL NAME : XT2045-6
FCC ID : IHDT56YK4
STANDARD : 47 CFR Part 2, 22(H), 24(E), 27(L), 27(M)
CLASSIFICATION : PCS Licensed Transmitter Held to Ear (PCE)

The product was received on Dec. 10, 2019 and completely tested on Feb. 13, 2020. We, Sporton International (Kunshan) Inc., would like to declare that the tested sample has been evaluated in accordance with the procedures given in ANSI C63.26-2015 and shown compliance with the applicable technical standards.

The test results in this report apply exclusively to the tested model / sample. Without written approval of Sporton International (Kunshan) Inc., the test report shall not be reproduced except in full.

Reviewed by: Jason Jia / Supervisor

Approved by: James Huang / Manager



Sporton International (Kunshan) Inc.
No. 1098, Pengxi North Road, Kunshan Economic Development Zone Jiangsu Province 215300
People's Republic of China



TABLE OF CONTENTS

REVISION HISTORY 3
SUMMARY OF TEST RESULT 4
1 GENERAL DESCRIPTION 5
1.1 Applicant 5
1.2 Manufacturer 5
1.3 Product Feature of Equipment Under Test 5
1.4 Product Specification of Equipment Under Test 6
1.5 Modification of EUT 6
1.6 Specification of Accessory 7
1.7 Re-use of Measured Data 8
1.8 Maximum ERP, Frequency Tolerance, and Emission Designator 9
1.9 Testing Location 10
1.10 Test Software 10
1.11 Applicable Standards 10
2 TEST CONFIGURATION OF EQUIPMENT UNDER TEST 11
2.1 Test Mode 11
2.2 Connection Diagram of Test System 12
2.3 Support Unit used in test configuration and system 12
2.4 Measurement Results Explanation Example 12
2.5 Frequency List of Low/Middle/High Channels 13
3 CONDUCTED TEST ITEMS 14
3.1 Measuring Instruments 14
3.2 Test Setup 14
3.3 Test Result of Conducted Test 14
3.4 Conducted Output Power and ERP 15
3.5 Peak-to-Average Ratio 16
3.6 Occupied Bandwidth 17
3.7 Conducted Band Edge 18
3.8 Conducted Spurious Emission 19
3.9 Frequency Stability 20
4 RADIATED TEST ITEMS 21
4.1 Measuring Instruments 21
4.2 Test Setup 21
4.3 Test Result of Radiated Test 21
4.4 Radiated Spurious Emission 22
5 LIST OF MEASURING EQUIPMENT 23
6 UNCERTAINTY OF EVALUATION 24
APPENDIX A. TEST RESULTS OF CONDUCTED TEST
APPENDIX B. TEST RESULTS OF RADIATED TEST
APPENDIX C. TEST SETUP PHOTOGRAPHS
APPENDIX D. REFERENCE REPORT



SUMMARY OF TEST RESULT

Report Section	FCC Rule	Description	Limit	Result	Remark
3.4	§2.1046	Conducted Output Power	Reporting Only	PASS	-
	§22.913(a)(5)	Effective Radiated Power (Band 26)	ERP < 7 Watt	PASS	-
3.5	N/A	Peak-to-Average Ratio	<13 dB	PASS	-
3.6	§2.1049	Occupied Bandwidth	Reporting Only	PASS	-
3.7	§2.1051 §22.917(a)	Conducted Band Edge Measurement (Band 26)	< 43+10log ₁₀ (P[Watts])	PASS	-
3.8	§2.1051 §22.917(a)	Conducted Spurious Emission (Band 26)	< 43+10log ₁₀ (P[Watts])	PASS	-
3.9	§2.1055 §22.355	Frequency Stability Temperature & Voltage	< 2.5 ppm for Part 22H	PASS	-
4.4	§2.1053 §22.917(a)	Radiated Spurious Emission (Band 26)	< 43+10log ₁₀ (P[Watts])	PASS	Under limit 49.37 dB at 2490.000 MHz

Declaration of Conformity:
The test results with all measurement uncertainty excluded are presented in accordance with the regulation limits or requirements declared by manufacturers.

Comments and Explanations:
The declared of product specification for EUT presented in the report are provided by the manufacturer, and the manufacturer takes all the responsibilities for the accuracy of product specification.



1 General Description

1.1 Applicant

Motorola Mobility LLC
222 W,Merchandise Mart Plaza, Chicago IL 60654 USA

1.2 Manufacturer

Motorola Mobility LLC
222 W,Merchandise Mart Plaza, Chicago IL 60654 USA

1.3 Product Feature of Equipment Under Test

Product Feature	
Equipment	Mobile Cellular Phone
Brand Name	Motorola
Model Name	XT2045-6
FCC ID	IHDT56YK4
EUT supports Radios application	GSM/WCDMA/LTE WLAN 2.4GHz 802.11b/g/n HT20 Bluetooth BR/EDR/LE FM Receiver and GNSS
IMEI Code	Conducted: N/A Radiation: 351632110010290/351632110010308
HW Version	DVT2
SW Version	QPJ30.63
EUT Stage	Identical Prototype

Note: There are two types of EUT, the sample 1 is dual SIM slot, sample 2 is single SIM slot.



1.4 Product Specification of Equipment Under Test

Standards-related Product Specification	
Tx Frequency	LTE Band 2 : 1850.7 MHz ~ 1909.3 MHz LTE Band 4 : 1710.7 MHz ~ 1754.3 MHz LTE Band 5 : 824.7 MHz ~ 848.3 MHz LTE Band 7 : 2502.5 MHz ~ 2567.5 MHz LTE Band 26 : 824.7MHz ~ 848.3 MHz LTE Band 38 : 2572.5MHz ~ 2617.5MHz LTE Band 41 : 2537.5 MHz ~ 2652.5 MHz
Rx Frequency	LTE Band 2 : 1930.7 MHz ~ 1989.3 MHz LTE Band 4 : 2110.7 MHz ~ 2154.3 MHz LTE Band 5 : 869.7 MHz ~ 893.3 MHz LTE Band 7 : 2622.5MHz ~ 2687.5 MHz LTE Band 26 : 869.7MHz ~ 893.3MHz LTE Band 38 : 2572.5MHz ~ 2617.5MHz LTE Band 41 : 2537.5 MHz ~ 2652.5 MHz
Bandwidth	LTE Band 2 : 1.4MHz / 3MHz / 5MHz / 10MHz / 15MHz / 20MHz LTE Band 4 : 1.4MHz / 3MHz / 5MHz / 10MHz / 15MHz / 20MHz LTE Band 5 : 1.4MHz / 3MHz / 5MHz / 10MHz LTE Band 7 : 5MHz / 10MHz / 15MHz / 20MHz LTE Band 26 : 1.4MHz / 3MHz / 5MHz / 10MHz / 15MHz LTE Band 38 : 5MHz / 10MHz / 15MHz / 20MHz LTE Band 41 : 5MHz / 10MHz / 15MHz / 20MHz
Maximum Output Power to Antenna	LTE Band 26 : 22.75 dBm
Antenna Gain	LTE Band 26 : -1.40 dBi
Type of Modulation	QPSK / 16QAM / 64QAM

1.5 Modification of EUT

No modifications are made to the EUT during all test items.



1.6 Specification of Accessory

Specification of Accessory				
AC Adapter 1(US)	Brand Name	Motorola(Acbel)	Model Name	SC-41
	Power Rating	I/P: 100-240 Vac, 0.3A, O/P:5Vdc 2000mA		
AC Adapter 1(EU)	Brand Name	Motorola(Acbel)	Model Name	SC-42
	Power Rating	I/P: 100-240 Vac, 0.3A, O/P:5Vdc 2000mA		
AC Adapter 1(UK)	Brand Name	Motorola(Acbel)	Model Name	SC-43
	Power Rating	I/P: 100-240 Vac, 0.3A, O/P:5Vdc 2000mA		
AC Adapter 1(AU)	Brand Name	Motorola(Acbel)	Model Name	SC-45
	Power Rating	I/P: 100-240 Vac, 0.3A, O/P:5Vdc 2000mA		
AC Adapter 1(AR)	Brand Name	Motorola(Acbel)	Model Name	SC-46
	Power Rating	I/P: 100-240 Vac, 0.3A, O/P:5Vdc 2000mA		
AC Adapter 2(US)	Brand Name	Motorola (Chenyang)	Model Name	SC-41
	Power Rating	I/P: 100-240 Vac, 0.3A, O/P:5Vdc 2000mA		
AC Adapter 2(EU)	Brand Name	Motorola (Chenyang)	Model Name	SC-42
	Power Rating	I/P: 100-240 Vac, 0.3A, O/P:5Vdc 2000mA		
AC Adapter 2(AR)	Brand Name	Motorola (Chenyang)	Model Name	SC-46
	Power Rating	I/P: 100-240 Vac, 0.3A, O/P:5Vdc 2000mA		
AC Adapter 2(UK)	Brand Name	Motorola (Chenyang)	Model Name	SC-43
	Power Rating	I/P: 100-240 Vac, 0.3A, O/P:5Vdc 2000mA		
Battery	Brand Name	Motorola(ATL)	Model Name	KG40
	Power Rating	3.8Vdc,3760/4000(min/typ)mAh	Type	Li-ion, Polymer
USB Cable 1	Brand Name	Motorola(LiQi)	Model Name	L52B-053000100
	Signal Line Type	1.0 meter, shielded cable, without ferrite core		
USB Cable 2	Brand Name	Motorola(SaiBao)	Model Name	S52B-053000100
	Signal Line Type	1.0 meter, shielded cable, without ferrite core		
Earphone	Brand Name	Motorola(Lianyun)	Model Name	LYM500B-36C-001
	Signal Line Type	1.1 meter, shielded cable, without ferrite core		



1.7 Re-use of Measured Data

1.7.1 Introduction Section

This application re-uses data collected on a similar device. The subject device of this application (Model: XT2045-6, FCC ID: IHDT56YK4) is electrically identical to the reference device (Model: XT2045-2, FCC ID: IHDT56YK3) for the portions of the circuitry corresponding to the data being re-used, as treated by KDB Publication 484596 D01.

1.7.2 Difference Section

For details concerning the similarity with respect to component placement, mechanical/electrical design etc., please refer to the Product Equality Declaration.

The re-used RF data includes the following bands provided in Appendix D (Sporton RF Report No. FG902103-01B for the reference device Model: XT2045-2, FCC ID: IHDT56YK3).

1.7.3 Reference detail Section:

Equipment Class	Reference FCC ID	Folder Test	Report Title/Section
PCE (LTE)	IHDT56YK3	Part22H.24E.27L.27M (FG902103-01B)	All sections applicable for LTE Band 2/4/5/7/38/41

1.7.4 Spot Check Verification Data Section

In order to confirm hardware similarity of the subject device with the reference device, spot check measurements were performed on the subject device for the following test items, the test result were consistent with FCC ID: IHDT56YK3.

Assertions concerning the similarity of these devices are based on representations by the applicant. The applicant accepts full responsibility for the validity of the similarity claim, and for the determination that verification test data are sufficient to support it.

Test Item	Mode	IHDT56YK3 Worst Result	IHDT56YK4 Worst Result	Difference (dB)
Radiated Spurious Emission (dBm)	LTE Band 2	-48.95	-49.96	1.01
	LTE Band 4	-52.50	-52.46	-0.04
	LTE Band 5	-59.36	-61.76	2.40
	LTE Band 7	-54.22	-56.90	2.68
	LTE Band 41	-57.93	-57.98	0.05



1.8 Maximum ERP, Frequency Tolerance, and Emission Designator

LTE Band 26		QPSK			16QAM		
BW (MHz)	Frequency Range (MHz)	Emission Designator (99%OBW)	Frequency Tolerance (ppm)	Maximum ERP(W)	Emission Designator (99%OBW)	Frequency Tolerance (ppm)	Maximum ERP(W)
1.4	824.7 ~ 848.3	1M09G7D	-	0.0807	1M09W7D	-	0.0697
3	825.5 ~ 847.5	2M72G7D	-	0.0780	2M75W7D	-	0.0671
5	826.5 ~ 846.5	4M51G7D	-	0.0782	4M51W7D	-	0.0676
10	829.0 ~ 844.0	9M07G7D	0.0093	0.0782	9M05W7D	-	0.0678
15	831.5 ~ 841.5	13M4G7D	-	0.0832	13M4W7D	-	0.0681
CH26765	821.5	13M5G7D	-	0.0785	13M4W7D	-	0.0676
LTE Band 26		64QAM					
BW (MHz)	Frequency Range (MHz)	Emission Designator (99%OBW)		Frequency Tolerance (ppm)	Maximum ERP(W)		
1.4	824.7 ~ 848.3	1M09W7D		-	0.0581		
3	825.5 ~ 847.5	2M74W7D		-	0.0562		
5	826.5 ~ 846.5	4M53W7D		-	0.0562		
10	829.0 ~ 844.0	9M03W7D		-	0.0561		
15	831.5 ~ 841.5	13M4W7D		-	0.0568		
CH26765	821.5	13M4W7D		-	0.0561		



1.9 Testing Location

Sporton International (Kunshan) Inc. is accredited to ISO/IEC 17025:2017 by American Association for Laboratory Accreditation with Certificate Number 5145.02.

Test Firm	Sporton International (Kunshan) Inc.		
Test Site Location	No. 1098, Pengxi North Road, Kunshan Economic Development Zone Jiangsu Province 215300 People's Republic of China TEL : +86-512-57900158 FAX : +86-512-57900958		
Test Site No.	Sporton Site No.	FCC Designation No.	FCC Test Firm Registration No.
	03CH04-KS TH01-KS	CN1257	314309

1.10 Test Software

Item	Site	Manufacture	Name	Version
1.	03CH04-KS	AUDIX	E3	6.2009-8-24a

1.11 Applicable Standards

According to the specifications of the manufacturer, the EUT must comply with the requirements of the following standards:

- ♦ 47 CFR Part 2, 22(H), 24(E), 27(L), 27(M)
- ♦ ANSI C63.26-2015
- ♦ FCC KDB 971168 D01 Power Meas License Digital Systems v03r01
- ♦ FCC KDB 412172 D01 Determining ERP and EIRP v01r01

Remark:

1. All test items were verified and recorded according to the standards and without any deviation during the test.
2. This EUT has also been tested and complied with the requirements of FCC Part 15, Subpart B, recorded in a separate test report.



2 Test Configuration of Equipment Under Test

2.1 Test Mode

Antenna port conducted and radiated test items listed below are performed according to KDB 971168 D01 Power Meas License Digital Systems v03r01 with maximum output power.

Radiated measurements are performed by rotating the EUT in three different orthogonal test planes to find the maximum emission.

Test Items	Band	Bandwidth (MHz)						Modulation			RB #			Test Channel		
		1.4	3	5	10	15	20	QPSK	16QAM	64QAM	1	Half	Full	L	M	H
Max. Output Power	26	v	v	v	v	v	-	v	v	v	v	v	v	v	v	v
Peak-to-Average Ratio	26				v		-	v	v	v	v		v	v	v	v
26dB and 99% Bandwidth	26	v	v	v	v	v	-	v	v	v			v	v	v	v
Conducted Band Edge	26	v	v	v	v	v	-	v	v	v	v		v			v
Conducted Spurious Emission	26	v	v	v	v	v	-	v	v	v	v			v	v	v
Frequency Stability	26				v		-	v					v		v	
E.R.P	26	v	v	v	v	v	-	v	v	v	v			v	v	v
Radiated Spurious Emission	26	Worst Case												v		
Note	<ol style="list-style-type: none"> The mark "v" means that this configuration is chosen for testing The mark "-" means that this bandwidth is not supported. The device is investigated from 30MHz to 10 times of fundamental signal for radiated spurious emission test under different RB size/offset and modulations in exploratory test. Subsequently, only the worst case emissions are reported. 															

2.2 Connection Diagram of Test System

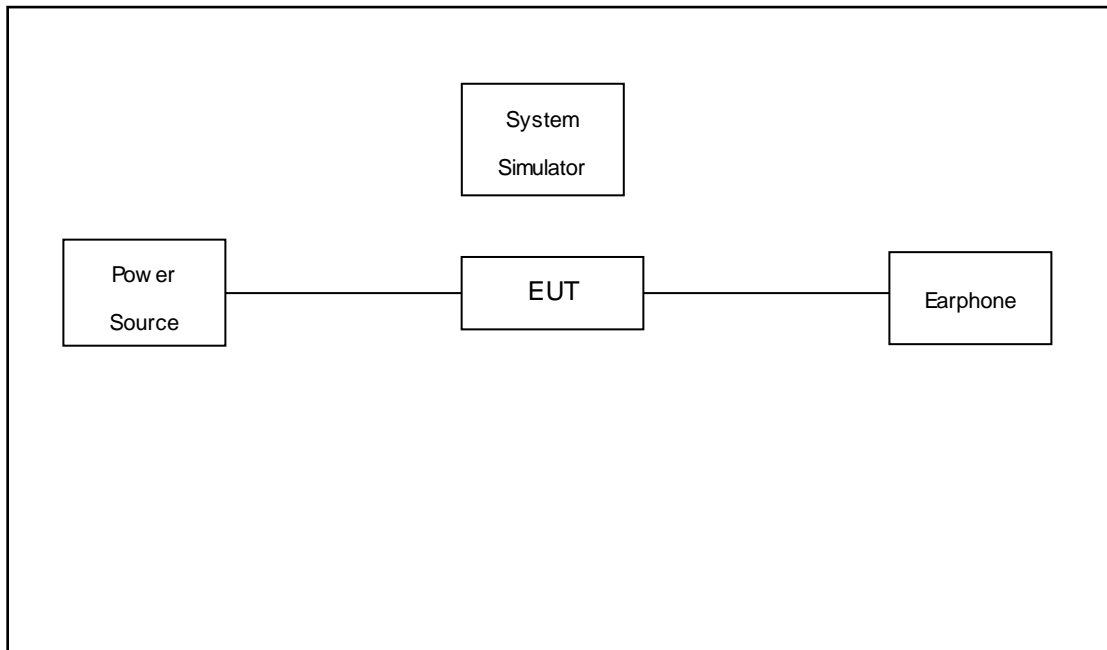

2.3 Support Unit used in test configuration and system

Item	Equipment	Trade Name	Model No.	FCC ID	Data Cable	Power Cord
1.	LTE Base Station	Anritsu	MT8820C	N/A	N/A	Unshielded, 1.8 m
2.	DC Power Supply	GW INSTEK	GPS-3030D	N/A	N/A	Unshielded, 1.8m

2.4 Measurement Results Explanation Example

For all conducted test items:

The offset level is set in the spectrum analyzer to compensate the RF cable loss between EUT conducted output port and spectrum analyzer. With the offset compensation, the spectrum analyzer reading level is exactly the EUT RF output level.

The spectrum analyzer offset is derived from RF cable loss.

Offset = RF cable loss.

Following shows an offset computation example with cable loss 4.7 dB.

Example :

$$\begin{aligned}
 \text{Offset(dB)} &= \text{RF cable loss(dB)}. \\
 &= 4.7 \text{ (dB)}
 \end{aligned}$$



2.5 Frequency List of Low/Middle/High Channels

LTE Band 26 Channel and Frequency List				
BW [MHz]	Channel/Frequency(MHz)	Lowest	Middle	Highest
15	Channel	26865	26915	26965
	Frequency	831.5	836.5	841.5
10	Channel	26840	26915	26990
	Frequency	829	836.5	844
5	Channel	26815	26915	27015
	Frequency	826.5	836.5	846.5
3	Channel	26805	26915	27025
	Frequency	825.5	836.5	847.5
1.4	Channel	26797	26915	27033
	Frequency	824.7	836.5	848.3

3 Conducted Test Items

3.1 Measuring Instruments

See list of measuring instruments of this test report.

3.2 Test Setup

3.2.1 Conducted Output Power

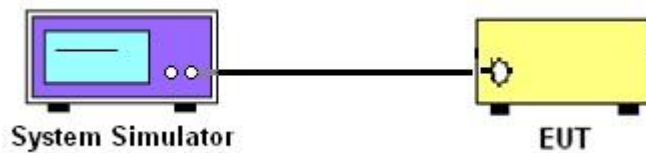

3.2.2 Peak-to-Average Ratio, Occupied Bandwidth ,Conducted Band-Edge and Conducted Spurious Emission

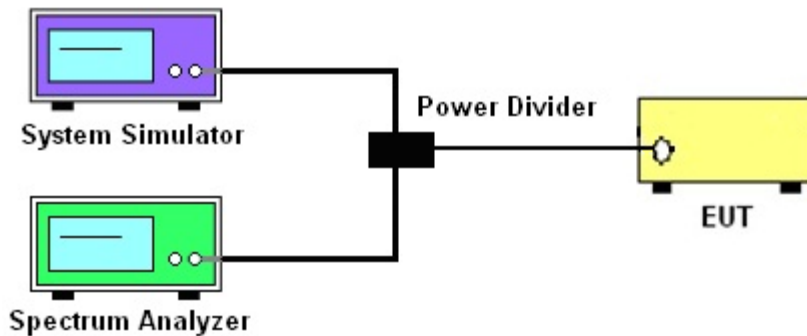

3.2.3 Frequency Stability

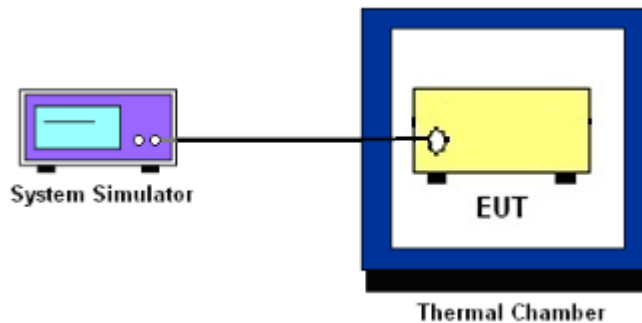

3.3 Test Result of Conducted Test

Please refer to Appendix A.



3.4 Conducted Output Power and ERP

3.4.1 Description of the Conducted Output Power Measurement and ERP Measurement

A system simulator was used to establish communication with the EUT. Its parameters were set to force the EUT transmitting at maximum output power. The measured power in the radio frequency on the transmitter output terminals shall be reported.

The ERP of mobile transmitters must not exceed 7 Watts for LTE Band 26.

According to KDB 412172 D01 Power Approach,

$EIRP = P_T + G_T - L_C$, $ERP = EIRP - 2.15$, where

P_T = transmitter output power in dBm

G_T = gain of the transmitting antenna in dBi

L_C = signal attenuation in the connecting cable between the transmitter and antenna in dB

3.4.2 Test Procedures

1. The testing follows ANSI C63.26 Section 5.2
2. The transmitter output port was connected to the system simulator.
3. Set EUT at maximum power through the system simulator.
4. Select lowest, middle, and highest channels for each band and different modulation.
5. Measure and record the power level from the system simulator.



3.5 Peak-to-Average Ratio

3.5.1 Description of the PAR Measurement

Power Complementary Cumulative Distribution Function (CCDF) curves provide a means for characterizing the power peaks of a digitally modulated signal on a statistical basis. A CCDF curve depicts the probability of the peak signal amplitude exceeding the average power level. Most contemporary measurement instrumentation include the capability to produce CCDF curves for an input signal provided that the instrument's resolution bandwidth can be set wide enough to accommodate the entire input signal bandwidth. In measuring transmissions in this band using an average power technique, the peak-to-average ratio (PAR) of the transmission may not exceed 13 dB.

3.5.2 Test Procedures

1. The testing follows ANSI C63.26 Section 5.2.3.4 (CCDF).
2. The EUT was connected to spectrum and system simulator via a power divider.
3. Set the CCDF (Complementary Cumulative Distribution Function) option in spectrum analyzer.
4. The highest RF powers were measured and recorded the maximum PAPR level associated with a probability of 0.1 %.
5. Record the deviation as Peak to Average Ratio.



3.6 Occupied Bandwidth

3.6.1 Description of Occupied Bandwidth Measurement

The occupied bandwidth is the width of a frequency band such that, below the lower and above the upper frequency limits, the mean powers emitted are each equal to a specified percentage 0.5% of the total mean transmitted power.

The 26 dB emission bandwidth is defined as the frequency range between two points, one above and one below the carrier frequency, at which the spectral density of the emission is attenuated 26 dB below the maximum in-band spectral density of the modulated signal. Spectral density (power per unit bandwidth) is to be measured with a detector of resolution bandwidth equal to approximately 1.0% of the emission bandwidth.

3.6.2 Test Procedures

1. The testing follows ANSI C63.26 Section 5.4
2. The EUT was connected to spectrum analyzer and system simulator via a power divider.
3. The spectrum analyzer center frequency is set to the nominal EUT channel center frequency. The span range for the spectrum analyzer shall be between two and five times the anticipated OBW.
4. The nominal resolution bandwidth (RBW) shall be in the range of 1 to 5 % of the anticipated OBW, and the VBW shall be at least 3 times the RBW.
5. Set the detection mode to peak, and the trace mode to max hold.
6. Determine the reference value: Set the EUT to transmit a modulated signal. Allow the trace to stabilize. Set the spectrum analyzer marker to the highest level of the displayed trace.
(this is the reference value)
7. Determine the “-26 dB down amplitude” as equal to (Reference Value – X).
8. Place two markers, one at the lowest and the other at the highest frequency of the envelope of the spectral display such that each marker is at or slightly below the “-X dB down amplitude” determined in step 6. If a marker is below this “-X dB down amplitude” value it shall be placed as close as possible to this value. The OBW is the positive frequency difference between the two markers.
9. Use the 99 % power bandwidth function of the spectrum analyzer and report the measured bandwidth.



3.7 Conducted Band Edge

3.7.1 Description of Conducted Band Edge Measurement

22.917(a)

For operations in the 824 – 849 MHz band, the FCC limit is $43 + 10\log_{10}(P[\text{Watts}])$ dB below the transmitter power P(Watts) in a 100kHz bandwidth. However, in the 1MHz bands immediately outside and adjacent to the licensee's frequency block, a resolution bandwidth of at least one percent of the emission bandwidth of the fundamental emission of the transmitter may be employed.

3.7.2 Test Procedures

1. The testing follows ANSI C63.26 section 5.7
2. The EUT was connected to spectrum analyzer and system simulator via a power divider.
3. The band edges of low and high channels for the highest RF powers were measured.
4. Set RBW $\geq 1\%$ EBW in the 1MHz band immediately outside and adjacent to the band edge.
5. Beyond the 1 MHz band from the band edge, RBW=1MHz was used.
6. Set spectrum analyzer with RMS detector.
7. Offset has included the duty factor for LTE Band 38/41. Duty factor = $10 \log (1/x)$, where x is the measured duty cycle.
8. The RF fundamental frequency should be excluded against the limit line in the operating frequency band.
9. Checked that all the results comply with the emission limit line.

Example:

$$\begin{aligned} &\text{The limit line is derived from } 43 + 10\log(P)\text{dB below the transmitter power P(Watts)} \\ &= P(W) - [43 + 10\log(P)] \text{ (dB)} \\ &= [30 + 10\log(P)] \text{ (dBm)} - [43 + 10\log(P)] \text{ (dB)} = -13\text{dBm}. \end{aligned}$$



3.8 Conducted Spurious Emission

3.8.1 Description of Conducted Spurious Emission Measurement

The power of any emission outside of the authorized operating frequency ranges must be lower than the transmitter power (P) by a factor of at least $43 + 10 \log (P)$ dB.

It is measured by means of a calibrated spectrum analyzer and scanned from 30 MHz up to a frequency including its 10th harmonic.

3.8.2 Test Procedures

1. The testing follows ANSI C63.26 section 5.7
2. The EUT was connected to spectrum analyzer and system simulator via a power divider.
3. The RF output of EUT was connected to the spectrum analyzer by RF cable and attenuator. The path loss was compensated to the results for each measurement.
4. The middle channel for the highest RF power within the transmitting frequency was measured.
5. The conducted spurious emission for the whole frequency range was taken.
6. Make the measurement with the spectrum analyzer's RBW = 1MHz, VBW = 3MHz.
7. Set spectrum analyzer with RMS detector.
8. Offset has included the duty factor for LTE Band 38/41. Duty factor = $10 \log (1/x)$, where x is the measured duty cycle.
9. Taking the record of maximum spurious emission.
10. The RF fundamental frequency should be excluded against the limit line in the operating frequency band.
11. The limit line is derived from $43 + 10\log(P)$ dB below the transmitter power P(Watts)
= $P(W) - [43 + 10\log(P)]$ (dB)
= $[30 + 10\log(P)]$ (dBm) - $[43 + 10\log(P)]$ (dB)
= -13dBm.



3.9 Frequency Stability

3.9.1 Description of Frequency Stability Measurement

The frequency stability shall be measured by variation of ambient temperature and variation of primary supply voltage to ensure that the fundamental emission stays within the authorized frequency block. The frequency stability of the transmitter shall be maintained within $\pm 0.00025\%$ ($\pm 2.5\text{ppm}$) of the center frequency.

3.9.2 Test Procedures for Temperature Variation

1. The testing follows ANSI C63.26 section 5.6.4
2. The EUT was set up in the thermal chamber and connected with the system simulator.
3. With power OFF, the temperature was decreased to -30°C and the EUT was stabilized before testing. Power was applied and the maximum change in frequency was recorded within one minute.
4. With power OFF, the temperature was raised in 10°C step up to 50°C . The EUT was stabilized at each step for at least half an hour. Power was applied and the maximum frequency change was recorded within one minute.

3.9.3 Test Procedures for Voltage Variation

1. The testing follows ANSI C63.26 section 5.6.5
2. The EUT was placed in a temperature chamber at $20\pm 5^{\circ}\text{C}$ and connected with the system simulator.
3. The power supply voltage to the EUT was varied from 85% to 115% of the nominal value for other than hand carried battery equipment.
4. For hand carried, battery powered equipment, reduce the primary ac or dc supply voltage to the battery operating end point, which shall be specified by the manufacturer.
5. The variation in frequency was measured for the worst case.

4 Radiated Test Items

4.1 Measuring Instruments

See list of measuring instruments of this test report.

4.2 Test Setup

4.2.1 For radiated test from 30MHz to 1GHz

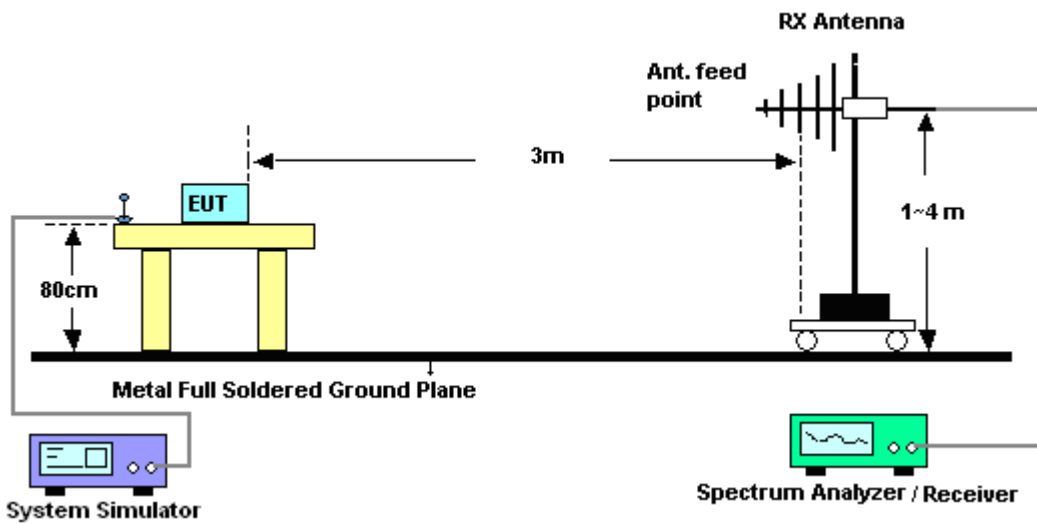

4.2.2 For radiated test above 1GHz

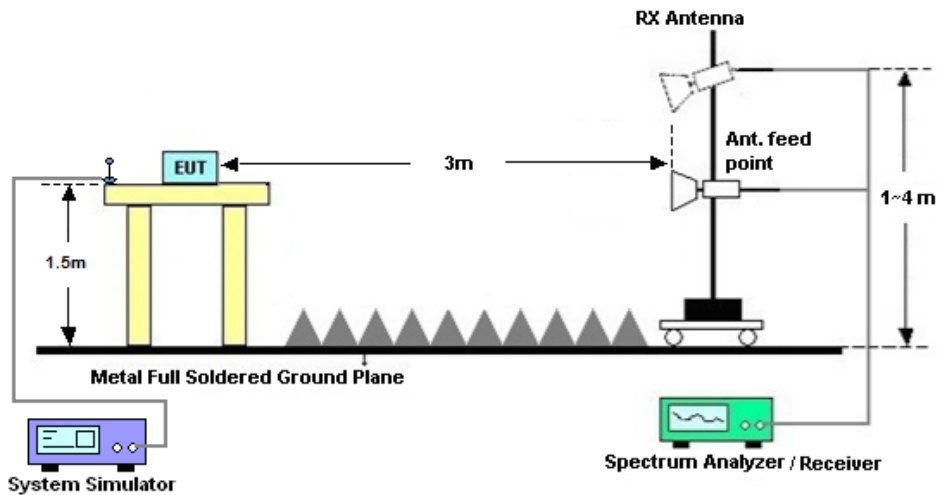

4.3 Test Result of Radiated Test

Please refer to Appendix B.



4.4 Radiated Spurious Emission

4.4.1 Description of Radiated Spurious Emission

The radiated spurious emission was measured by substitution method according to ANSI C63.26. The power of any emission outside of the authorized operating frequency ranges must be attenuated below the transmitter power (P) by a factor of at least $43 + 10 \log (P)$ dB.

The spectrum is scanned from 30 MHz up to a frequency including its 10th harmonic.

4.4.2 Test Procedures

1. The testing follows ANSI C63.26 Section 5.5
2. The EUT was placed on a turntable with 0.8 meter height for frequency below 1GHz and 1.5 meter height for frequency above 1GHz respectively above ground.
3. The EUT was set 3 meters from the receiving antenna mounted on the antenna tower.
4. The table was rotated 360 degrees to determine the position of the highest spurious emission.
5. The height of the receiving antenna is varied between 1m to 4m to search the maximum spurious emission for both horizontal and vertical polarizations.
6. During the measurement, the system simulator parameters were set to force the EUT transmitting at maximum output power.
7. Make the measurement with the spectrum analyzer's RBW = 1MHz, VBW = 3MHz, taking the record of maximum spurious emission.
8. A horn antenna was substituted in place of the EUT and was driven by a signal generator.
9. Tune the output power of signal generator to the same emission level with EUT maximum spurious emission.
10. $EIRP \text{ (dBm)} = S.G. \text{ Power} - Tx \text{ Cable Loss} + Tx \text{ Antenna Gain}$
11. $ERP \text{ (dBm)} = EIRP - 2.15$
12. The RF fundamental frequency should be excluded against the limit line in the operating frequency band.

The limit line is derived from $43 + 10\log(P)$ dB below the transmitter power P(Watts)
 $= P(W) - [43 + 10\log(P)] \text{ (dB)}$
 $= [30 + 10\log(P)] \text{ (dBm)} - [43 + 10\log(P)] \text{ (dB)}$
 $= -13\text{dBm}.$



5 List of Measuring Equipment

Instrument	Manufacturer	Model No.	Serial No.	Characteristics	Calibration Date	Test Date	Due Date	Remark
Spectrum Analyzer	R&S	FSV40	101040	10Hz~40GHz	Aug. 07, 2019	Feb. 06, 2020~ Feb. 13, 2020	Aug. 06, 2020	Conducted (TH01-KS)
Thermal Chamber	Ten Billion	TTC-B3S	TBN-960502	-40~+150°C	Nov. 18, 2019	Feb. 06, 2020~ Feb. 13, 2020	Nov. 17, 2020	Conducted (TH01-KS)
EXA Spectrum Analyzer	Keysight	N9010A	MY55150244	10Hz-44G,MAX 30dB	Apr. 16, 2019	Feb. 11, 2020	Apr. 15, 2020	Radiation (03CH04-KS)
Bilog Antenna	TeseQ	CBL6111D	49922	30MHz-1GHz	May 30, 2019	Feb. 11, 2020	May 29, 2020	Radiation (03CH04-KS)
Horn Antenna	Schw arzbeck	BBHA9120D	1648	1GHz~18GHz	Jan. 14, 2020	Feb. 11, 2020	Jan. 23, 2021	Radiation (03CH04-KS)
SHF- EHF Horn	Com-pow er	AH-840	101093	18GHz~40GHz	Feb. 23, 2019	Feb. 11, 2020	Feb. 22, 2020	Radiation (03CH04-KS)
Amplifier	SONOMA	310N	187289	9KHz-1GHz	Aug. 06, 2019	Feb. 11, 2020	Aug. 05, 2020	Radiation (03CH04-KS)
Amplifier	MITEQ	TTA1840-35 -HG	2014749	18~40GHz	Feb. 25, 2019	Feb. 11, 2020	Feb. 24, 2020	Radiation (03CH04-KS)
high gain Amplifier	MITEQ	AMF-7D-00 101800-30-1 0P	2025788	1Ghz-18Ghz	Aug. 16, 2019	Feb. 11, 2020	Aug. 15, 2020	Radiation (03CH04-KS)
Amplifier	Keysight	83017A	MY57280106	500MHz~26.5GHz	Apr. 15, 2019	Feb. 11, 2020	Apr. 14, 2020	Radiation (03CH04-KS)
AC Pow er Source	Chroma	61601	F104090004	N/A	NCR	Feb. 11, 2020	NCR	Radiation (03CH04-KS)
Turn Table	ChamPro	EM 1000-T	060762-T	0~360 degree	NCR	Feb. 11, 2020	NCR	Radiation (03CH04-KS)
Antenna Mast	ChamPro	EM 1000-A	060762-A	1 m~4 m	NCR	Feb. 11, 2020	NCR	Radiation (03CH04-KS)

NCR: No Calibration Required



6 Uncertainty of Evaluation

The measurement uncertainties shown below were calculated in accordance with the requirements of ANSI 63.26-2015. All the measurement uncertainty value were shown with a coverage K=2 to indicate 95% level of confidence. The measurement data show herein meets or exceeds the CISPR measurement uncertainty values specified in CISPR 16-4-2 and can be compared directly to specified limit to determine compliance.

Uncertainty of Radiated Emission Measurement (30 MHz ~ 1000 MHz)

Measuring Uncertainty for a Level of Confidence of 95% (U = 2Uc(y))	3.3dB
---	-------

Uncertainty of Radiated Emission Measurement (1 GHz ~ 40 GHz)

Measuring Uncertainty for a Level of Confidence of 95% (U = 2Uc(y))	2.8dB
---	-------



Appendix A. Test Results of Conducted Test

Conducted Output Power(Average power)

LTE Band 26 Maximum Average Power [dBm]						
BW [MHz]	RB Size	RB Offset	Mod	Lowest	Middle	Highest
15	1	0	QPSK	22.50	22.75	22.48
15	1	37		22.41	22.48	22.39
15	1	74		22.42	22.40	22.30
15	36	0		21.46	21.76	21.50
15	36	20		21.57	21.58	21.48
15	36	39		21.52	21.46	21.37
15	75	0		21.57	21.69	21.43
15	1	0	16-QAM	21.85	21.88	21.82
15	1	37		21.76	21.88	21.75
15	1	74		21.79	21.75	21.67
15	36	0		20.56	20.68	20.59
15	36	20		20.65	20.66	20.58
15	36	39		20.61	20.58	20.47
15	75	0		20.66	20.63	20.55
15	1	0	64QAM	21.04	21.08	21.06
15	1	37		20.98	21.09	20.95
15	1	74		20.98	20.98	20.90
15	36	0		19.90	20.03	19.91
15	36	20		19.97	19.98	19.89
15	36	39		19.93	19.86	19.79
15	75	0		19.98	19.96	19.87



LTE Band 26 Maximum Average Power [dBm]						
BW [MHz]	RB Size	RB Offset	Mod	Lowest	Middle	Highest
10	1	0	QPSK	22.46	22.44	22.39
10	1	25		22.43	22.48	22.37
10	1	49		22.46	22.41	22.30
10	25	0		21.53	21.56	21.42
10	25	12		21.49	21.55	21.42
10	25	25		21.56	21.46	21.41
10	50	0		21.61	21.50	21.41
10	1	0	16-QAM	21.83	21.84	21.78
10	1	25		21.81	21.86	21.76
10	1	49		21.85	21.77	21.65
10	25	0		20.58	20.67	20.51
10	25	12		20.59	20.65	20.52
10	25	25		20.67	20.56	20.52
10	50	0		20.70	20.61	20.51
10	1	0	64QAM	20.99	21.02	20.99
10	1	25		21.01	21.04	20.94
10	1	49		21.04	21.00	20.88
10	25	0		19.88	19.98	19.83
10	25	12		19.91	19.97	19.85
10	25	25		19.99	19.88	19.82
10	50	0		20.01	19.92	19.82
5	1	0	QPSK	22.46	22.48	22.35
5	1	12		22.45	22.44	22.31
5	1	24		22.39	22.42	22.28
5	12	0		21.50	21.55	21.36
5	12	7		21.53	21.57	21.43
5	12	13		21.49	21.49	21.38
5	25	0		21.46	21.51	21.36
5	1	0	16-QAM	21.77	21.84	21.70
5	1	12		21.80	21.85	21.70
5	1	24		21.76	21.77	21.64
5	12	0		20.61	20.64	20.52
5	12	7		20.62	20.67	20.52



5	12	13		20.59	20.61	20.47
5	25	0		20.55	20.61	20.45
5	1	0	64QAM	21.02	21.05	20.92
5	1	12		21.05	21.05	20.91
5	1	24		21.01	20.99	20.84
5	12	0		19.92	19.95	19.78
5	12	7		19.94	19.98	19.82
5	12	13		19.89	19.89	19.78
5	25	0		19.87	19.93	19.77



LTE Band 26 Maximum Average Power [dBm]						
BW [MHz]	RB Size	RB Offset	Mod	Lowest	Middle	Highest
3	1	0	QPSK	22.45	22.47	22.31
3	1	8		22.44	22.43	22.30
3	1	14		22.42	22.42	22.27
3	8	0		21.46	21.49	21.40
3	8	4		21.51	21.54	21.42
3	8	7		21.46	21.49	21.37
3	15	0		21.50	21.48	21.34
3	1	0	16-QAM	21.77	21.82	21.74
3	1	8		21.77	21.81	21.71
3	1	14		21.76	21.77	21.58
3	8	0		20.60	20.63	20.53
3	8	4		20.68	20.68	20.53
3	8	7		20.60	20.64	20.51
3	15	0		20.61	20.58	20.46
3	1	0	64QAM	21.02	21.05	20.85
3	1	8		21.02	21.01	20.91
3	1	14		20.98	21.03	20.83
3	8	0		19.89	19.93	19.78
3	8	4		19.94	19.95	19.80
3	8	7		19.89	19.91	19.78
3	15	0		19.89	19.90	19.75
1.4	1	0	QPSK	22.49	22.55	22.39
1.4	1	3		22.60	22.59	22.44
1.4	1	5		22.52	22.52	22.37
1.4	3	0		22.58	22.56	22.42
1.4	3	1		22.62	22.60	22.43
1.4	3	3		22.61	22.58	22.42
1.4	6	0		21.58	21.58	21.45
1.4	1	0	16-QAM	21.87	21.87	21.77
1.4	1	3		21.93	21.98	21.82
1.4	1	5		21.89	21.88	21.72
1.4	3	0		21.71	21.70	21.55
1.4	3	1		21.71	21.72	21.54



1.4	3	3		21.65	21.65	21.55
1.4	6	0		20.75	20.74	20.62
1.4	1	0	64QAM	21.12	21.05	20.93
1.4	1	3		21.19	21.14	20.99
1.4	1	5		21.09	21.07	20.95
1.4	3	0		21.01	20.99	20.90
1.4	3	1		21.10	21.06	20.91
1.4	3	3		20.99	21.00	20.88
1.4	6	0		19.99	20.00	19.84



ERP

LTE Band 26 (GT - LC = -1.40 dB) QPSK									
Bandwidth	1.4M			3M			5M		
Channel	26797	26915	27033	26805	26915	27025	26815	26915	27015
	(Low)	(Mid)	(High)	(Low)	(Mid)	(High)	(Low)	(Mid)	(High)
Frequency	824.7	836.5	848.3	825.5	836.5	847.5	826.5	836.5	846.5
(MHz)									
Conducted Power (dBm)	22.62	22.60	22.43	22.45	22.47	22.31	22.46	22.48	22.35
Conducted Power (Watts)	0.1828	0.1820	0.1750	0.1758	0.1766	0.1702	0.1762	0.1770	0.1718
ERP(dBm)	19.07	19.05	18.88	18.90	18.92	18.76	18.91	18.93	18.80
ERP(Watts)	0.0807	0.0804	0.0773	0.0776	0.0780	0.0752	0.0778	0.0782	0.0759

LTE Band 26 (GT - LC = -1.40 dB) QPSK							
Bandwidth	10M			15M			15M
Channel	26840	26915	26990	26865	26915	26965	26765
	(Low)	(Mid)	(High)	(Low)	(Mid)	(High)	(Low)
Frequency	829	836.5	844	831.5	836.5	841.5	821.5
(MHz)							
Conducted Power (dBm)	22.43	22.48	22.37	22.50	22.75	22.48	22.50
Conducted Power (Watts)	0.1750	0.1770	0.1726	0.1778	0.1884	0.1770	0.1778
ERP(dBm)	18.88	18.93	18.82	18.95	19.20	18.93	18.95
ERP(Watts)	0.0773	0.0782	0.0762	0.0785	0.0832	0.0782	0.0785



LTE Band 26 (GT - LC = -1.40 dB) 16QAM									
Bandwidth	1.4M			3M			5M		
Channel	26797	26915	27033	26805	26915	27025	26815	26915	27015
	(Low)	(Mid)	(High)	(Low)	(Mid)	(High)	(Low)	(Mid)	(High)
Frequency	824.7	836.5	848.3	825.5	836.5	847.5	826.5	836.5	846.5
(MHz)									
Conducted Power (dBm)	21.93	21.98	21.82	21.77	21.82	21.74	21.80	21.85	21.70
Conducted Power (Watts)	0.1560	0.1578	0.1521	0.1503	0.1521	0.1493	0.1514	0.1531	0.1479
ERP(dBm)	18.38	18.43	18.27	18.22	18.27	18.19	18.25	18.30	18.15
ERP(Watts)	0.0689	0.0697	0.0671	0.0664	0.0671	0.0659	0.0668	0.0676	0.0653

LTE Band 26 (GT - LC = -1.40 dB) 16QAM							
Bandwidth	10M			15M			15M
Channel	26840	26915	26990	26865	26915	26965	26765
	(Low)	(Mid)	(High)	(Low)	(Mid)	(High)	(Low)
Frequency	829	836.5	844	831.5	836.5	841.5	821.5
(MHz)							
Conducted Power (dBm)	21.81	21.86	21.76	21.85	21.88	21.82	21.85
Conducted Power (Watts)	0.1517	0.1535	0.1500	0.1531	0.1542	0.1521	0.1531
ERP(dBm)	18.26	18.31	18.21	18.30	18.33	18.27	18.30
ERP(Watts)	0.0670	0.0678	0.0662	0.0676	0.0681	0.0671	0.0676



LTE Band 26 (GT - LC = -1.40 dB) 64QAM									
Bandwidth	1.4M			3M			5M		
Channel	26797	26915	27033	26805	26915	27025	26815	26915	27015
	(Low)	(Mid)	(High)	(Low)	(Mid)	(High)	(Low)	(Mid)	(High)
Frequency	824.7	836.5	848.3	825.5	836.5	847.5	826.5	836.5	846.5
(MHz)									
Conducted Power (dBm)	21.19	21.14	20.99	21.02	21.05	20.85	21.02	21.05	20.92
Conducted Power (Watts)	0.1315	0.1300	0.1256	0.1265	0.1274	0.1216	0.1265	0.1274	0.1236
ERP(dBm)	17.64	17.59	17.44	17.47	17.50	17.30	17.47	17.50	17.37
ERP(Watts)	0.0581	0.0574	0.0555	0.0558	0.0562	0.0537	0.0558	0.0562	0.0546

LTE Band 26 (GT - LC = -1.40 dB) 64QAM							
Bandwidth	10M			15M			15M
Channel	26840	26915	26990	26865	26915	26965	26765
	(Low)	(Mid)	(High)	(Low)	(Mid)	(High)	(Low)
Frequency	829	836.5	844	831.5	836.5	841.5	821.5
(MHz)							
Conducted Power (dBm)	21.01	21.04	20.94	20.98	21.09	20.95	21.04
Conducted Power (Watts)	0.1262	0.1271	0.1242	0.1253	0.1285	0.1245	0.1271
ERP(dBm)	17.46	17.49	17.39	17.43	17.54	17.40	17.49
ERP(Watts)	0.0557	0.0561	0.0548	0.0553	0.0568	0.0550	0.0561



LTE Band 26_Part 22H

Peak-to-Average Ratio

Mode	LTE Band 26 / 15MHz				
Mod.	QPSK		16QAM		Limit: 13dB
RB Size	1RB	Full RB	1RB	Full RB	Result
Lowest CH	3.59	4.72	5.07	5.94	PASS
Middle CH	3.54	4.64	5.19	5.94	
Highest CH	3.54	4.70	5.48	6.06	
Mode	LTE Band 26 / 15MHz				
Mod.	64QAM				Limit: 13dB
RB Size	1RB	Full RB			Result
Lowest CH	6.67	6.61	-	-	PASS
Middle CH	6.78	6.61	-	-	
Highest CH	6.81	6.64	-	-	



LTE Band 26 / 15MHz / QPSK

Lowest Channel / 1RB

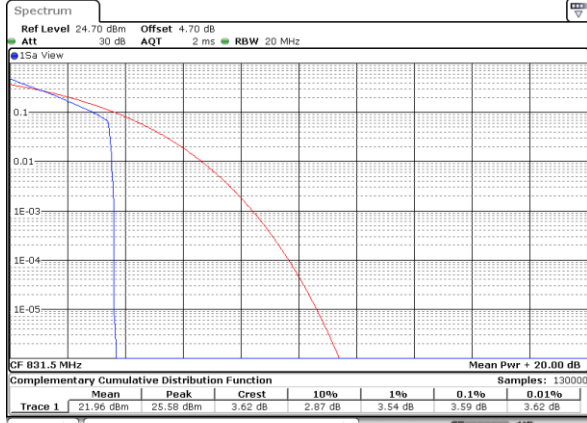

Date: 10 FEB 2020 04:22:35

Lowest Channel / Full RB

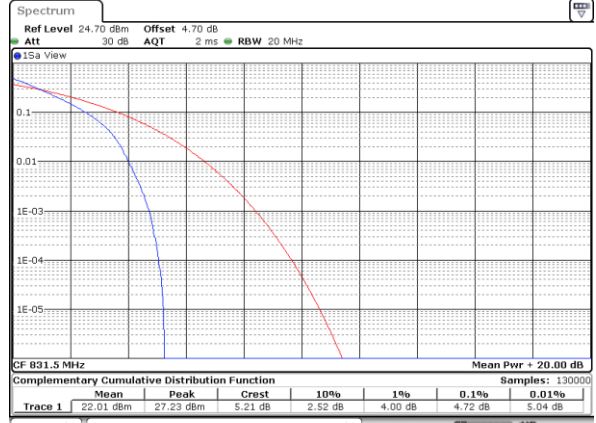

Date: 10 FEB 2020 04:24:47

Middle Channel / 1RB

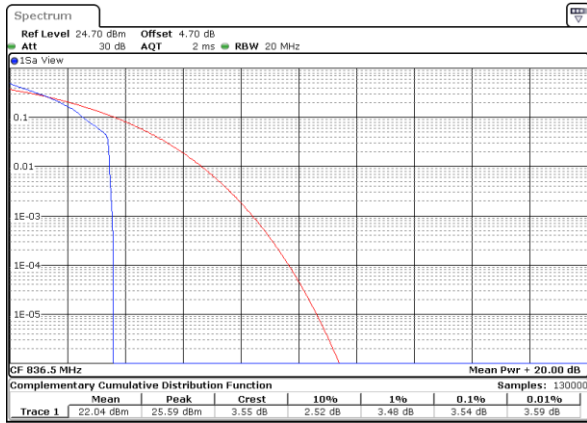

Date: 10 FEB 2020 04:24:12

Middle Channel / Full RB



Date: 10 FEB 2020 04:25:32

Highest Channel / 1RB

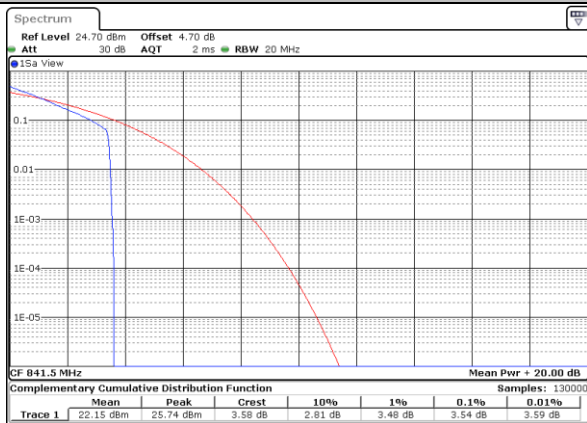

Date: 10 FEB 2020 04:24:20

Highest Channel / Full RB

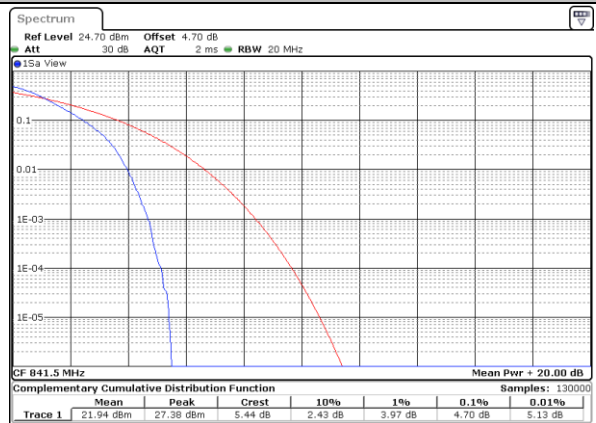

Date: 10 FEB 2020 04:25:41



LTE Band 26 / 15MHz / 16QAM

Lowest Channel / 1RB

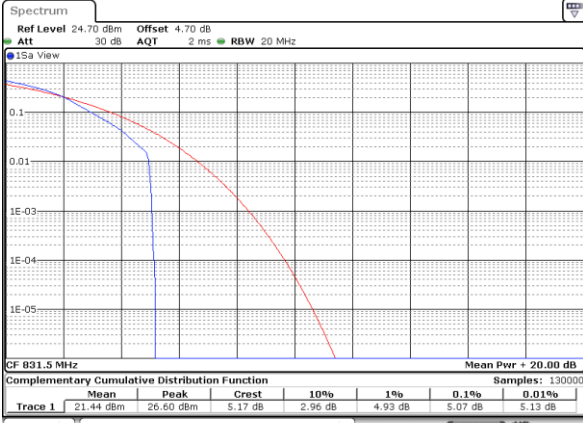

Date: 10 FEB 2020 04:22:44

Lowest Channel / Full RB

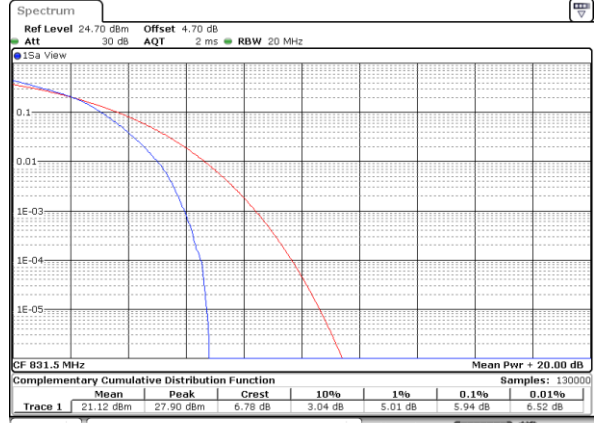

Date: 10 FEB 2020 04:24:56

Middle Channel / 1RB



Date: 10 FEB 2020 04:24:02

Middle Channel / Full RB

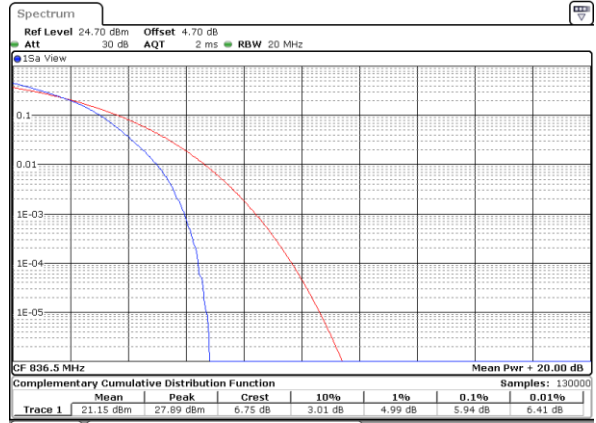

Date: 10 FEB 2020 04:25:24

Highest Channel / 1RB

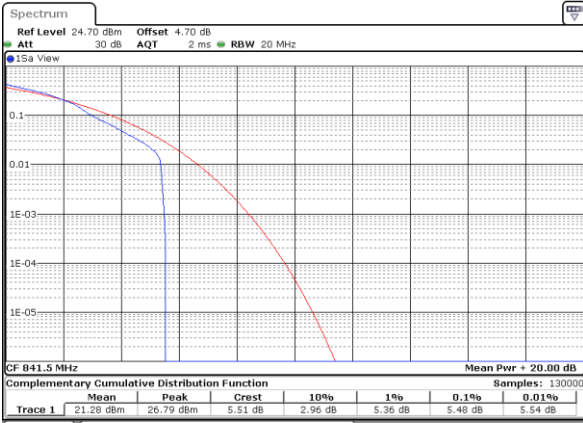

Date: 10 FEB 2020 04:24:29

Highest Channel / Full RB

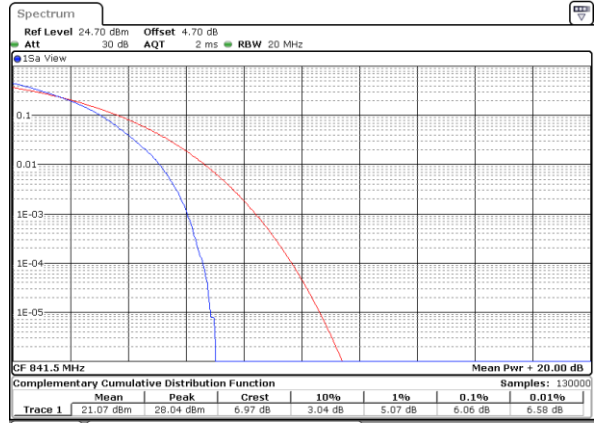

Date: 10 FEB 2020 04:25:59



LTE Band 26 / 15MHz / 64QAM

Lowest Channel / 1RB

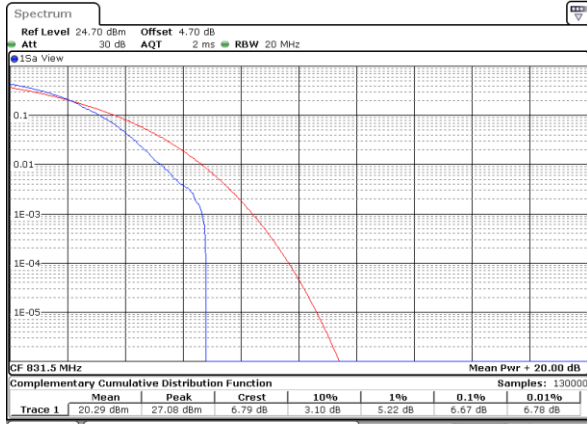

Date: 10 FEB 2020 04:22:59

Lowest Channel / Full RB

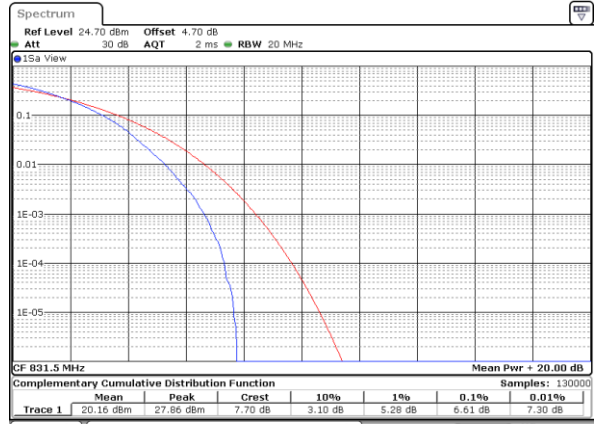

Date: 10 FEB 2020 04:25:06

Middle Channel / 1RB

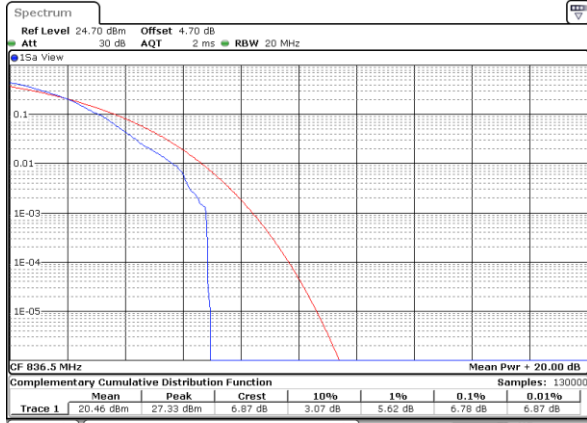

Date: 10 FEB 2020 04:23:08

Middle Channel / Full RB

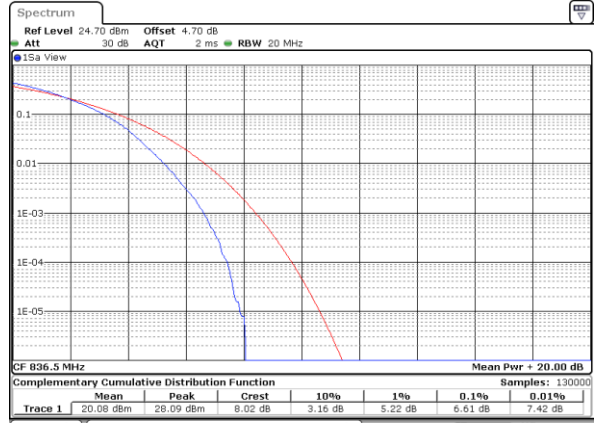

Date: 10 FEB 2020 04:25:15

Highest Channel / 1RB

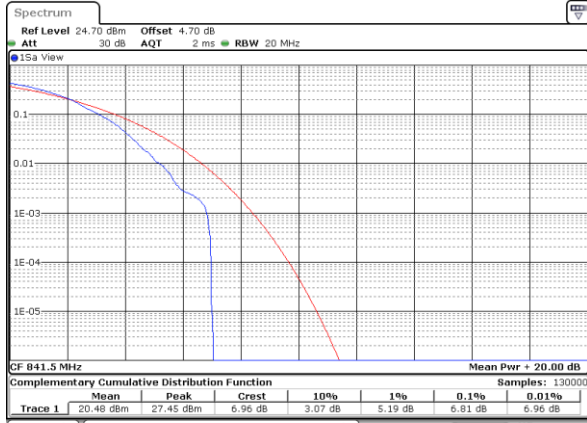

Date: 10 FEB 2020 04:24:38

Highest Channel / Full RB

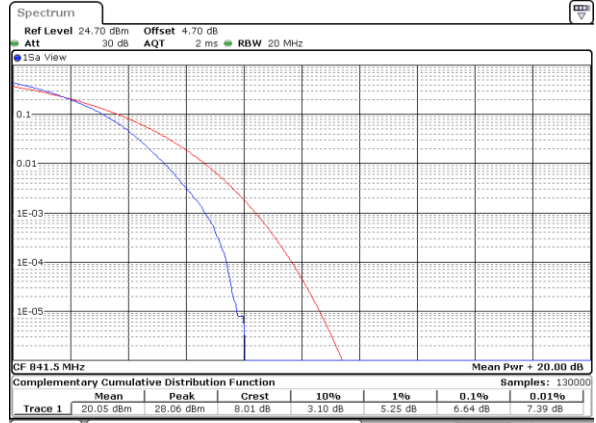

Date: 10 FEB 2020 04:26:08

26dB Bandwidth



Mode	LTE Band 26 : 26dB BW(MHz)											
BW	1.4MHz		3MHz		5MHz		10MHz		15MHz		20MHz	
Mod.	QPSK	16QAM	QPSK	16QAM	QPSK	16QAM	QPSK	16QAM	QPSK	16QAM	QPSK	16QAM
Lowest CH	1.24	1.24	3.03	3.02	4.97	4.91	9.79	9.75	14.27	14.39	-	-
Middle CH	1.23	1.22	3.04	2.99	4.79	4.85	9.67	9.79	14.36	14.36	-	-
Highest CH	1.24	1.23	3.02	3.06	4.95	4.94	9.85	9.69	14.36	14.54	-	-
Mode	LTE Band 26 : 26dB BW(MHz)											
BW	1.4MHz		3MHz		5MHz		10MHz		15MHz		20MHz	
Mod.	64QAM		64QAM		64QAM		64QAM		64QAM		64QAM	
Lowest CH	1.24	-	3.03	-	4.90	-	9.93	-	14.63	-	-	-
Middle CH	1.23	-	2.98	-	4.90	-	9.73	-	14.42	-	-	-
Highest CH	1.23	-	3.03	-	4.85	-	9.91	-	14.36	-	-	-



LTE Band 26

Lowest Channel / 1.4MHz / QPSK

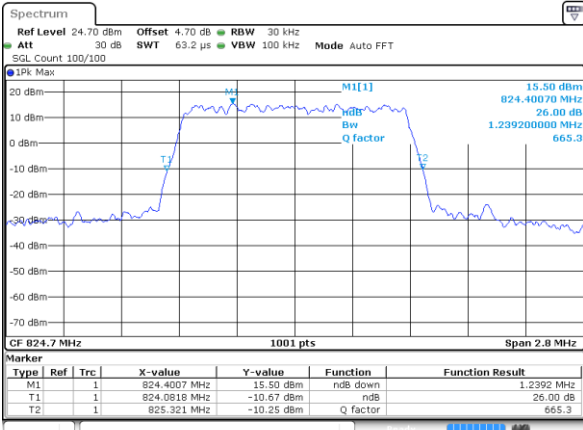

Date: 10 FEB 2020 03:18:26

Lowest Channel / 1.4MHz / 16QAM

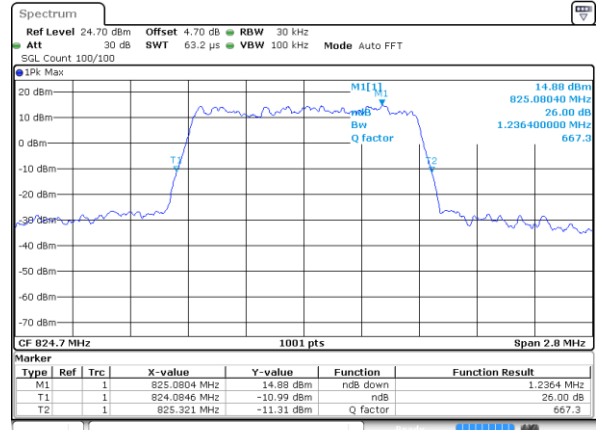

Date: 10 FEB 2020 03:18:45

Middle Channel / 1.4MHz / QPSK

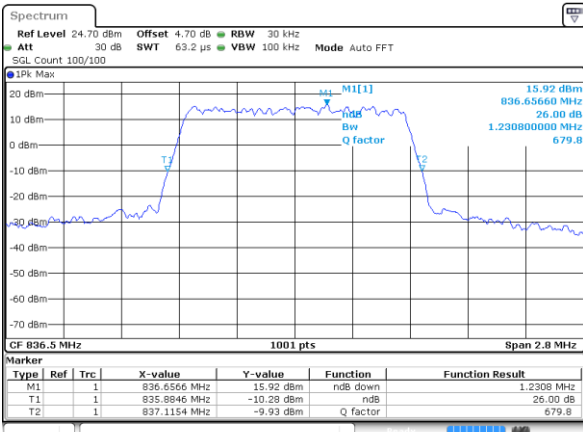

Date: 10 FEB 2020 03:28:18

Middle Channel / 1.4MHz / 16QAM

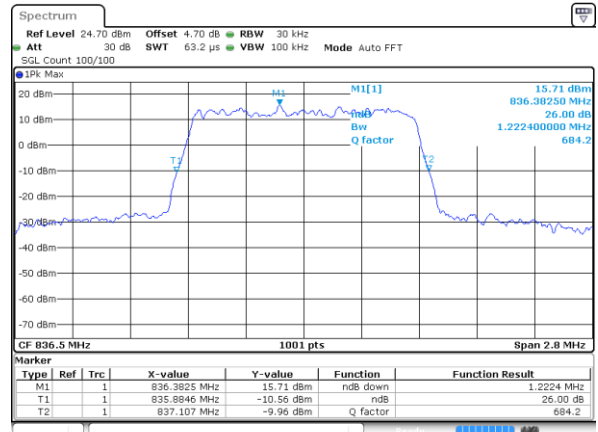

Date: 10 FEB 2020 03:27:58

Highest Channel / 1.4MHz / QPSK

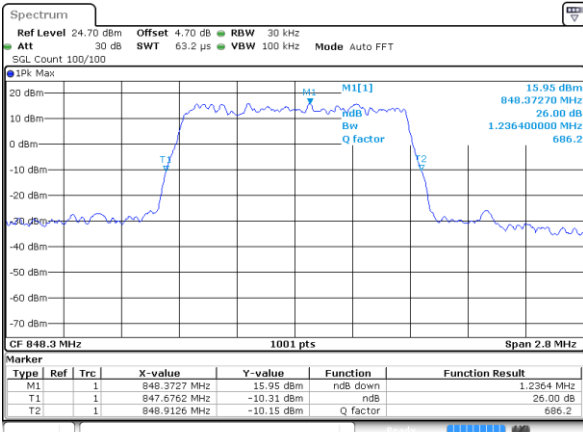

Date: 10 FEB 2020 03:28:38

Highest Channel / 1.4MHz / 16QAM

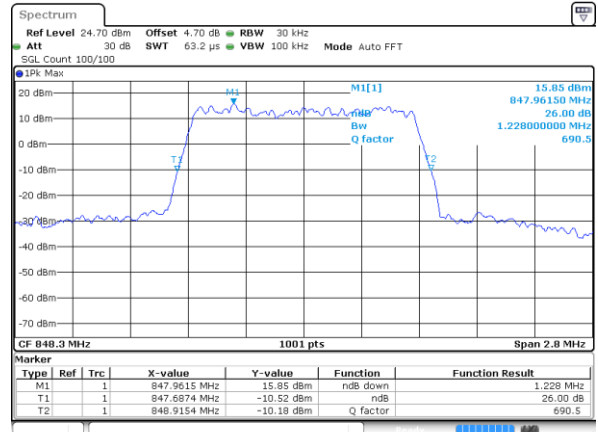

Date: 10 FEB 2020 03:28:58



LTE Band 26

Lowest Channel / 3MHz / QPSK

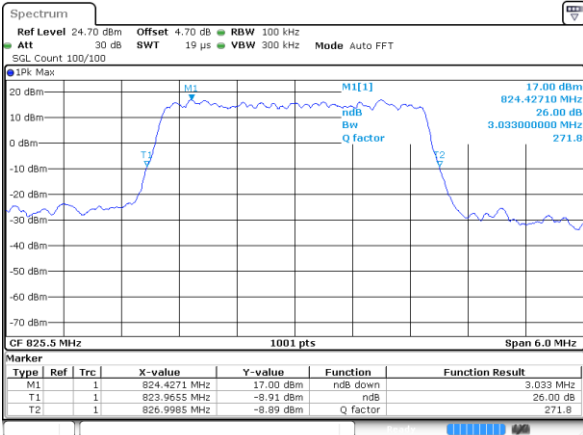

Date: 10 FEB 2020 03:29:38

Lowest Channel / 3MHz / 16QAM

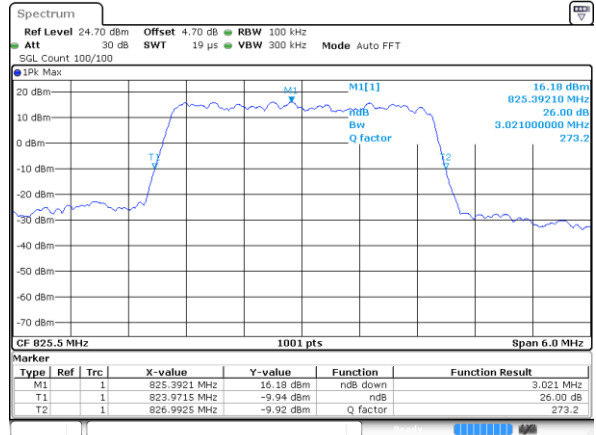

Date: 10 FEB 2020 03:29:58

Middle Channel / 3MHz / QPSK

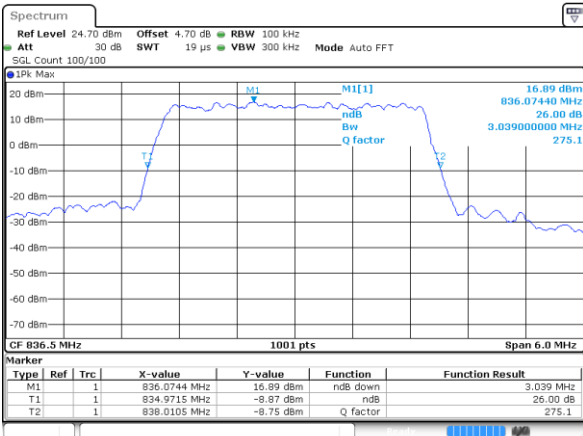

Date: 10 FEB 2020 03:31:19

Middle Channel / 3MHz / 16QAM

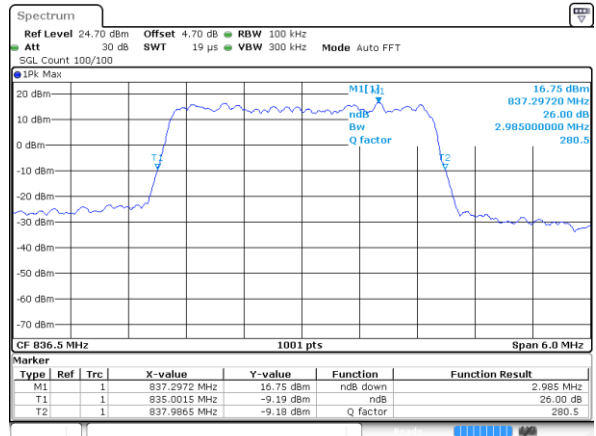

Date: 10 FEB 2020 03:30:59

Highest Channel / 3MHz / QPSK

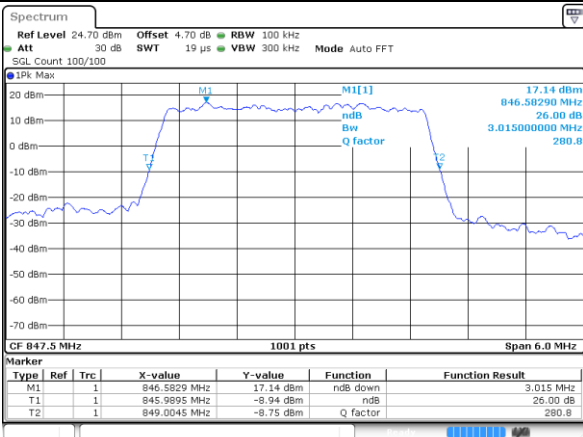

Date: 10 FEB 2020 03:31:39

Highest Channel / 3MHz / 16QAM

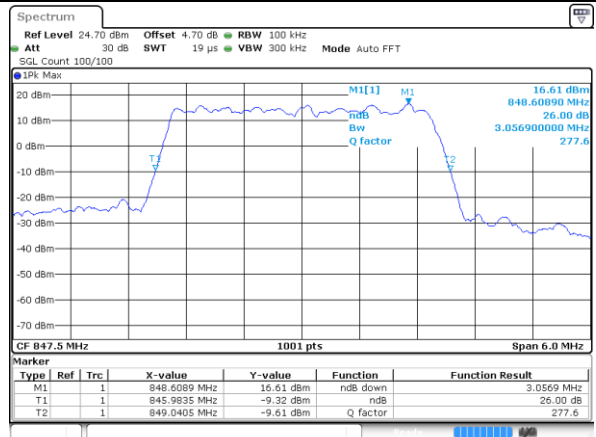

Date: 10 FEB 2020 03:31:59



LTE Band 26

Lowest Channel / 5MHz / QPSK

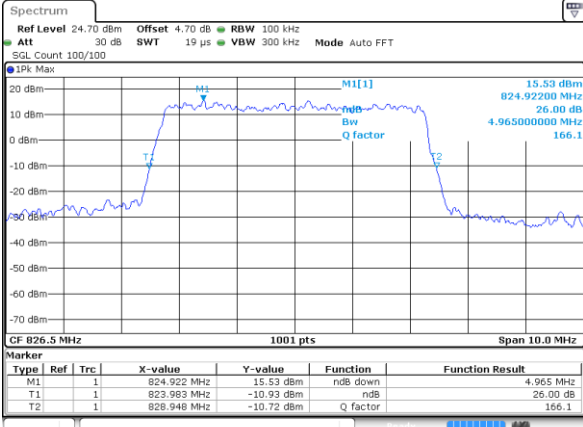

Date: 10 FEB 2020 03:40:51

Lowest Channel / 5MHz / 16QAM

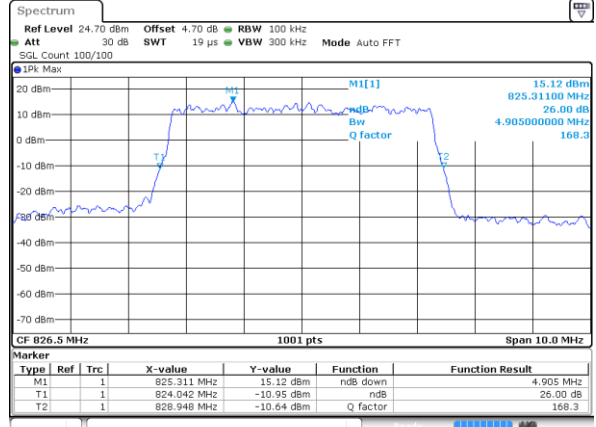

Date: 10 FEB 2020 03:41:11

Middle Channel / 5MHz / QPSK

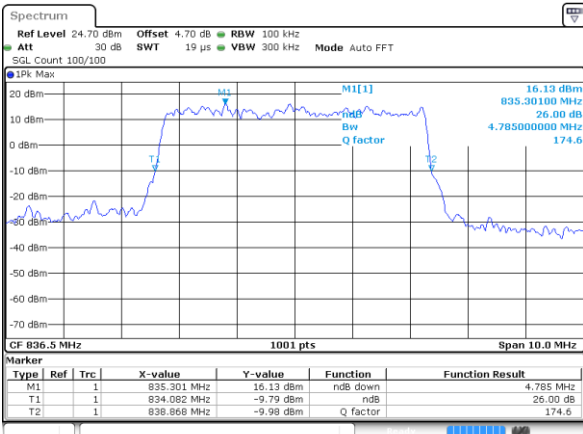

Date: 10 FEB 2020 03:42:31

Middle Channel / 5MHz / 16QAM

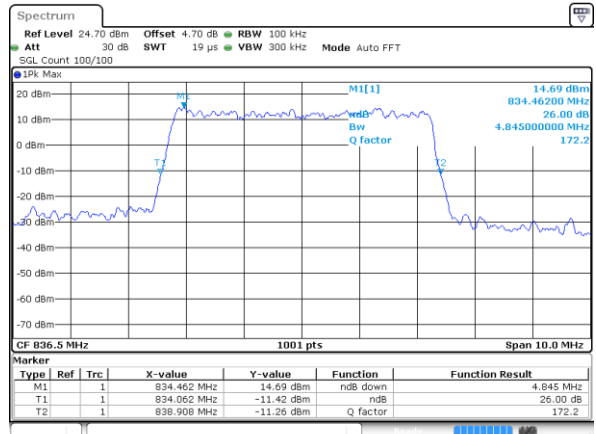

Date: 10 FEB 2020 03:42:11

Highest Channel / 5MHz / QPSK

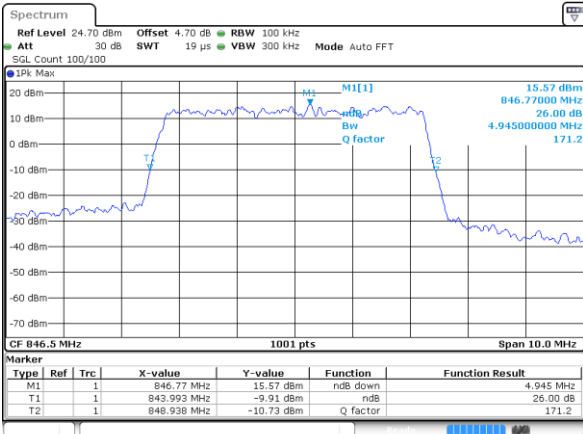

Date: 10 FEB 2020 03:42:51

Highest Channel / 5MHz / 16QAM

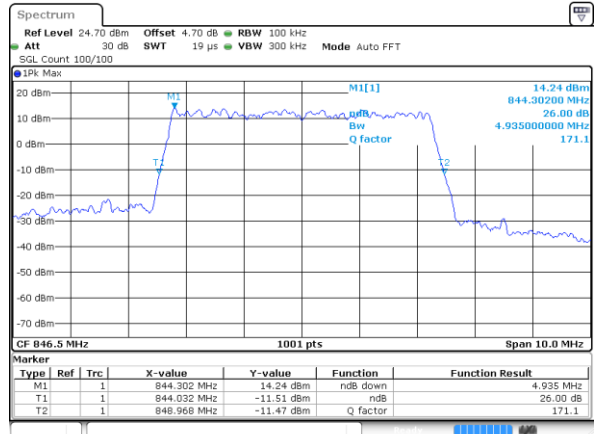

Date: 10 FEB 2020 03:43:11



LTE Band 26

Lowest Channel / 10MHz / QPSK

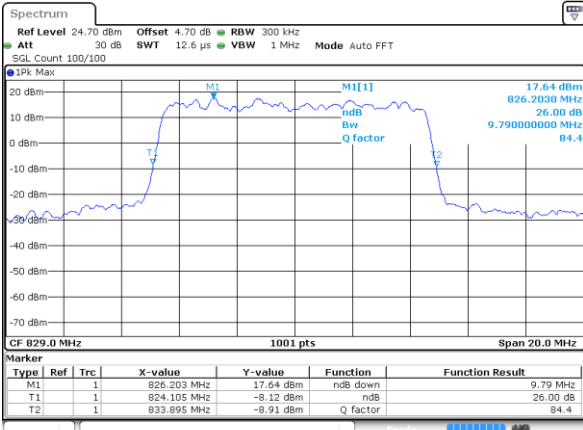

Date: 10 FEB 2020 03:52:03

Lowest Channel / 10MHz / 16QAM

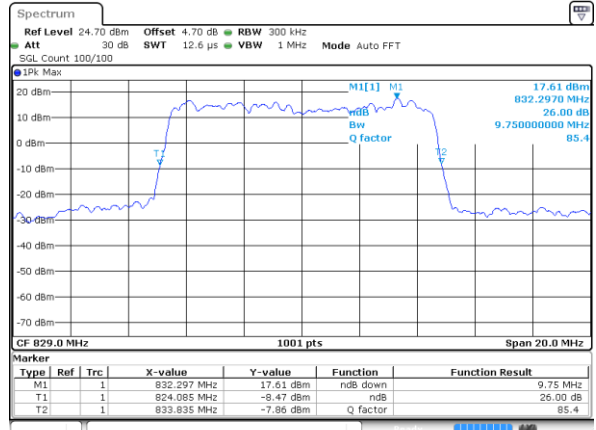

Date: 10 FEB 2020 03:52:23

Middle Channel / 10MHz / QPSK

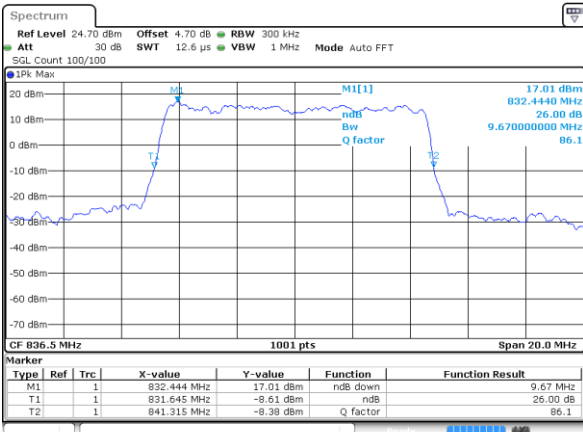

Date: 10 FEB 2020 03:53:43

Middle Channel / 10MHz / 16QAM

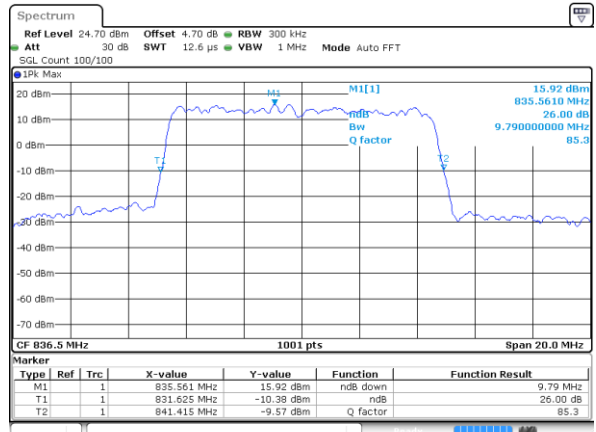

Date: 10 FEB 2020 03:53:23

Highest Channel / 10MHz / QPSK

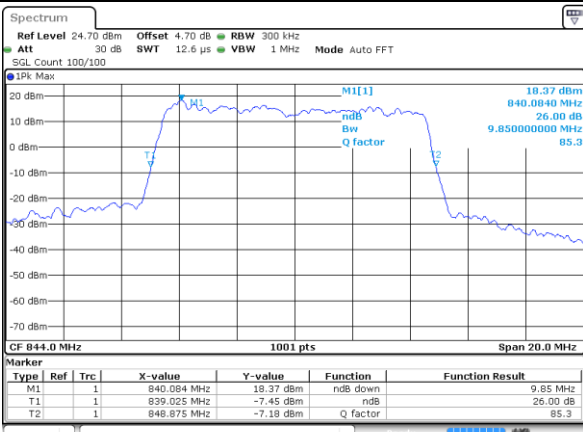

Date: 10 FEB 2020 03:54:04

Highest Channel / 10MHz / 16QAM

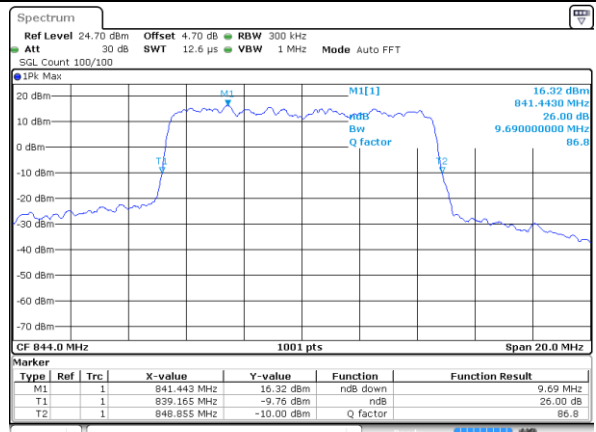

Date: 10 FEB 2020 03:54:24



LTE Band 26

Lowest Channel / 15MHz / QPSK

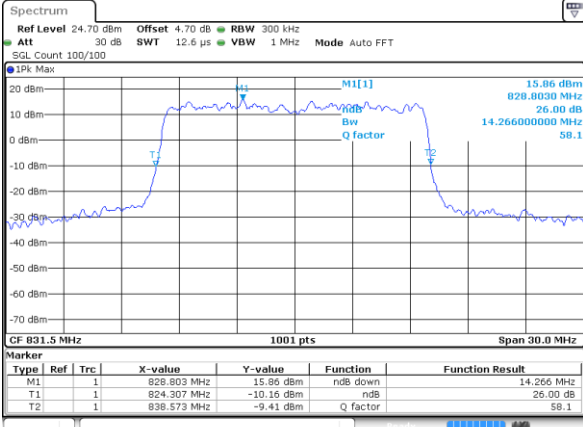

Date: 10 FEB 2020 04:03:17

Lowest Channel / 15MHz / 16QAM

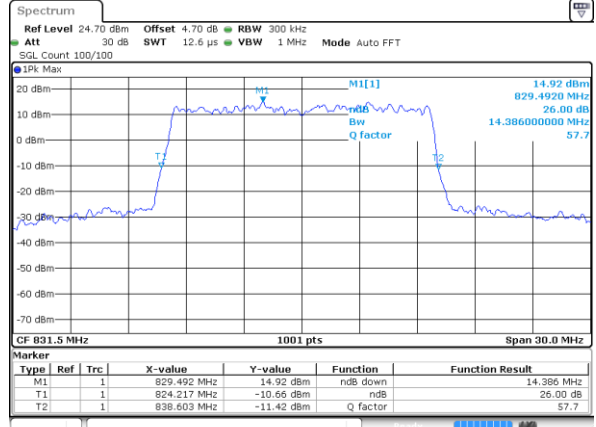

Date: 10 FEB 2020 04:03:37

Middle Channel / 15MHz / QPSK

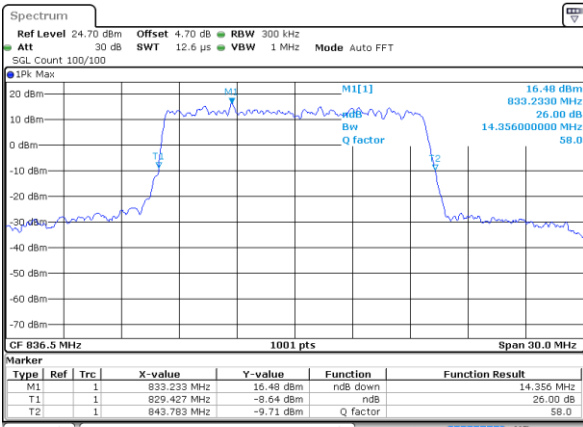

Date: 10 FEB 2020 04:05:04

Middle Channel / 15MHz / 16QAM

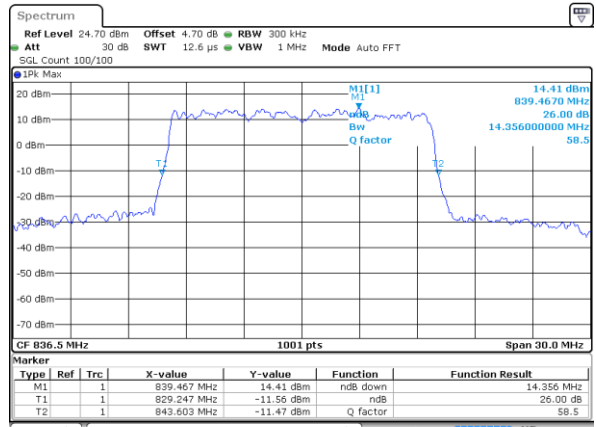

Date: 10 FEB 2020 04:04:44

Highest Channel / 15MHz / QPSK

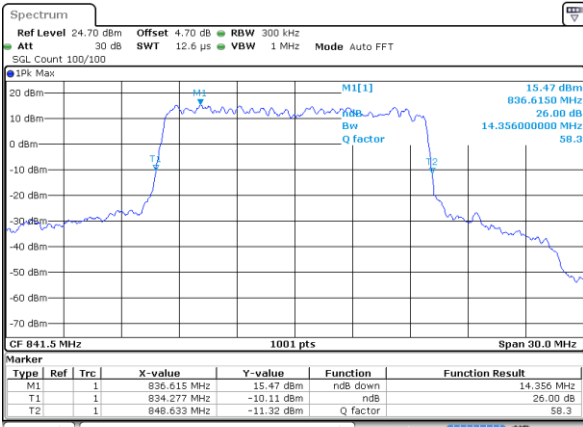

Date: 10 FEB 2020 04:05:25

Highest Channel / 15MHz / 16QAM

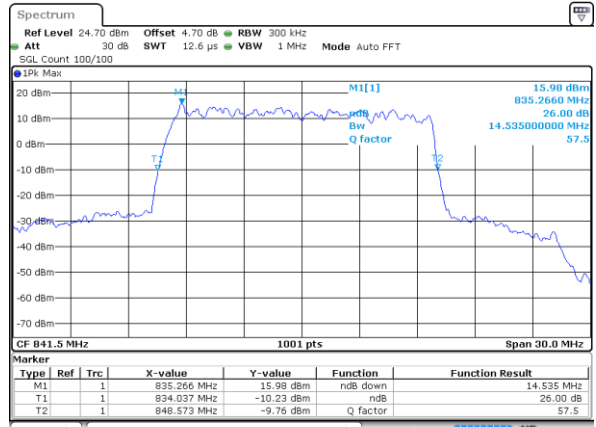

Date: 10 FEB 2020 04:05:45



LTE Band 26

Lowest Channel / 1.4MHz / 64QAM

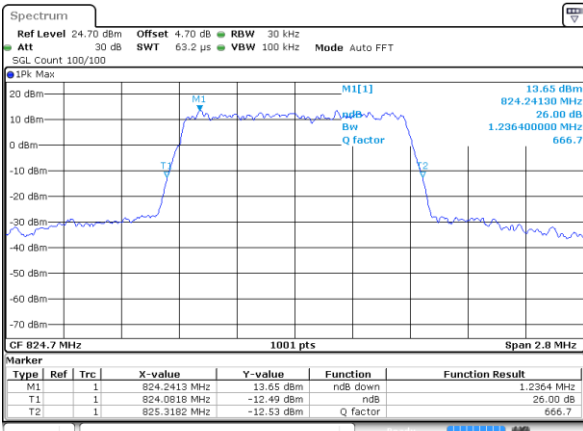

Date: 10 FEB 2020 03:19:05

Lowest Channel / 3MHz / 64QAM

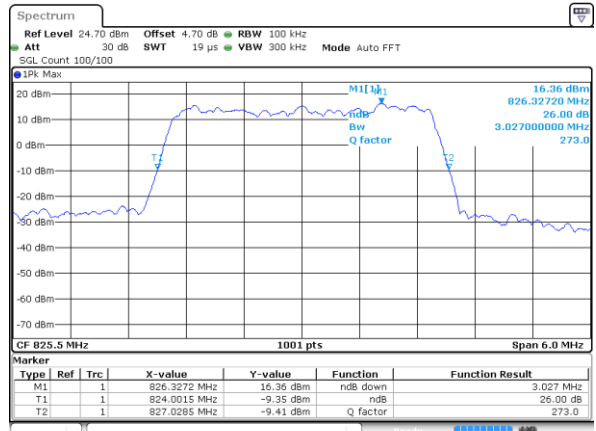

Date: 10 FEB 2020 03:30:19

Middle Channel / 1.4MHz / 64QAM

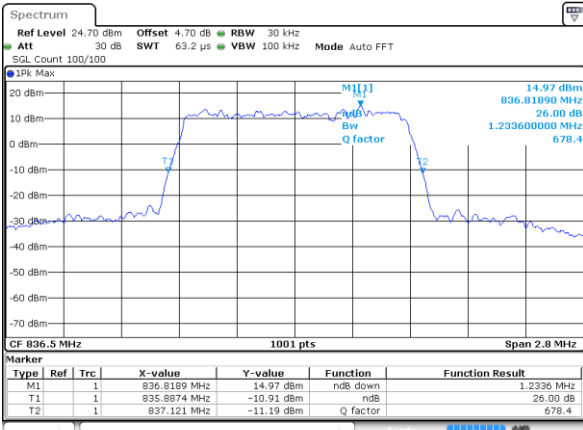

Date: 10 FEB 2020 03:27:38

Middle Channel / 3MHz / 64QAM

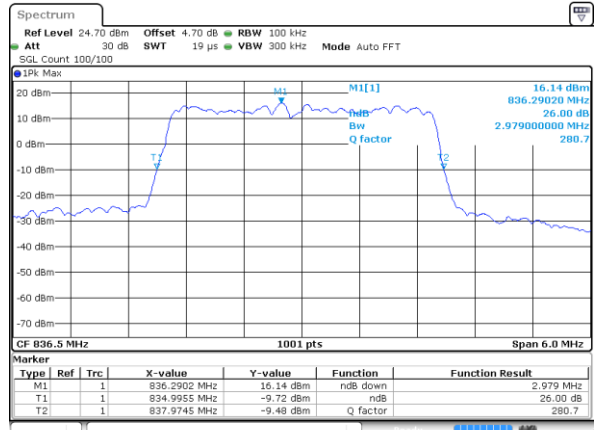

Date: 10 FEB 2020 03:30:39

Highest Channel / 1.4MHz / 64QAM

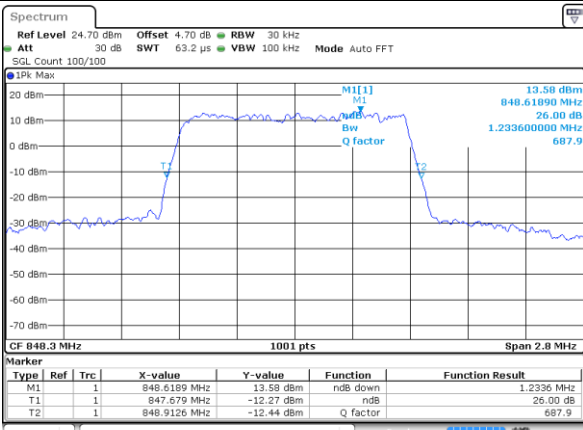

Date: 10 FEB 2020 03:29:18

Highest Channel / 3MHz / 64QAM

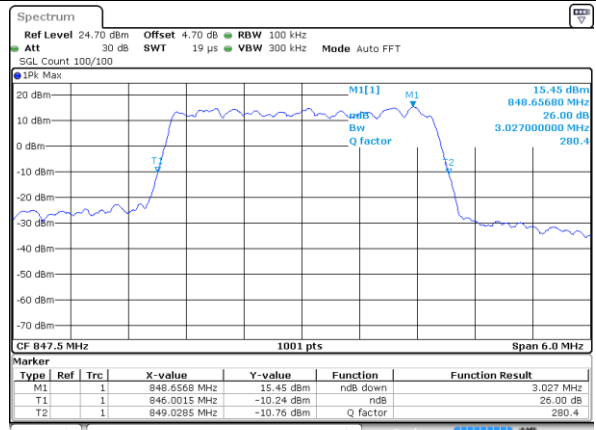

Date: 10 FEB 2020 03:32:19



LTE Band 26

Lowest Channel / 5MHz / 64QAM

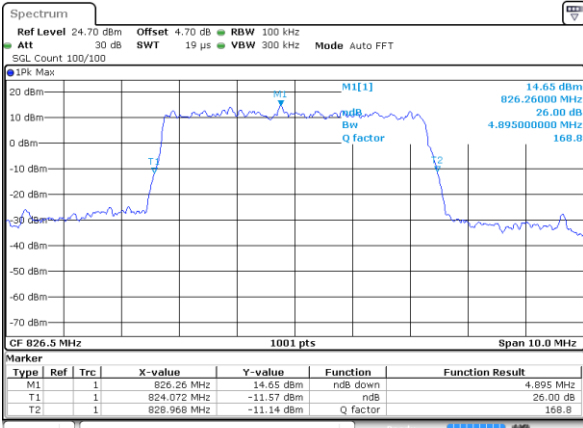

Date: 10 FEB 2020 03:41:31

Lowest Channel / 10MHz / 64QAM

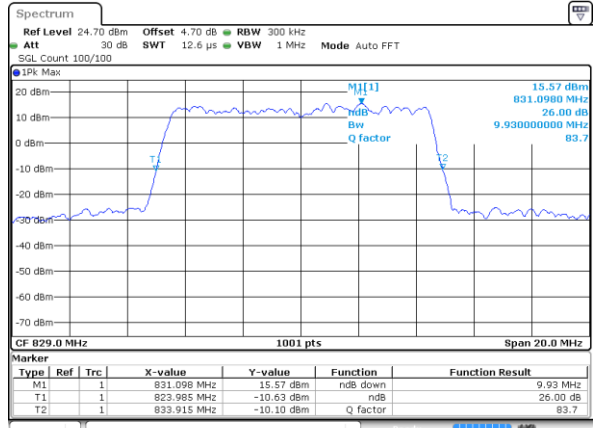

Date: 10 FEB 2020 03:52:43

Middle Channel / 5MHz / 64QAM

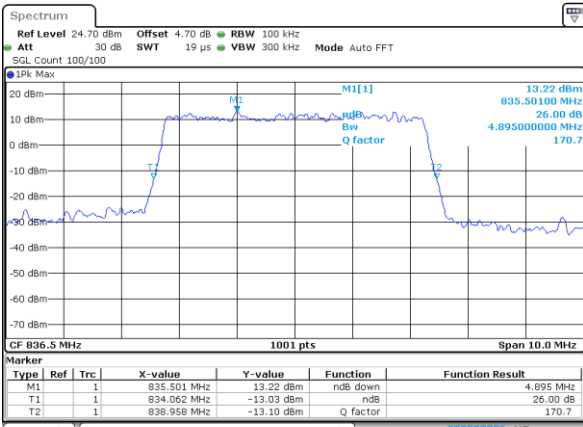

Date: 10 FEB 2020 03:41:51

Middle Channel / 10MHz / 64QAM

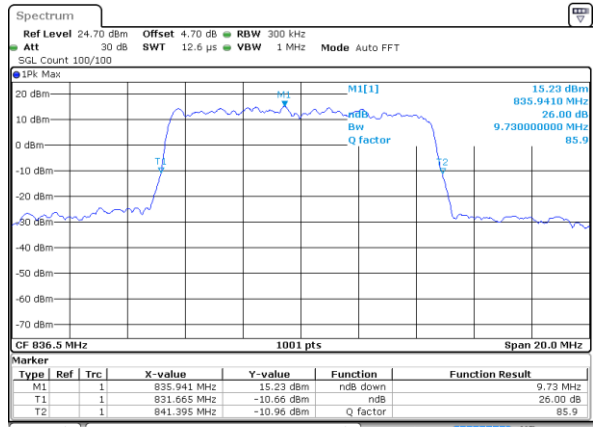

Date: 10 FEB 2020 03:53:03

Highest Channel / 5MHz / 64QAM

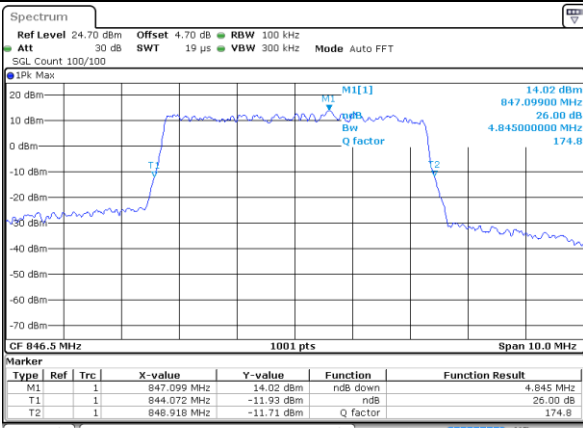

Date: 10 FEB 2020 03:43:31

Highest Channel / 10MHz / 64QAM

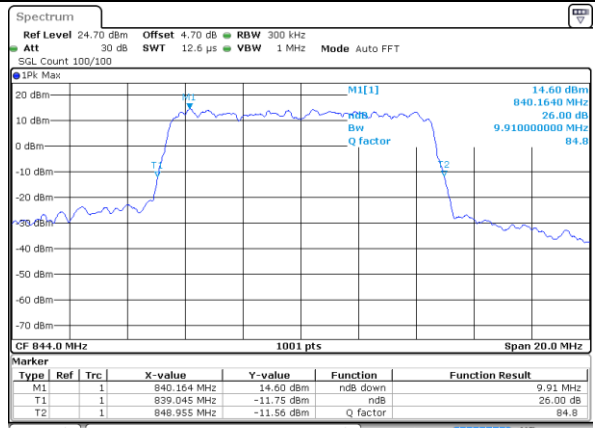

Date: 10 FEB 2020 03:54:44



LTE Band 26

Lowest Channel / 15MHz / 64QAM

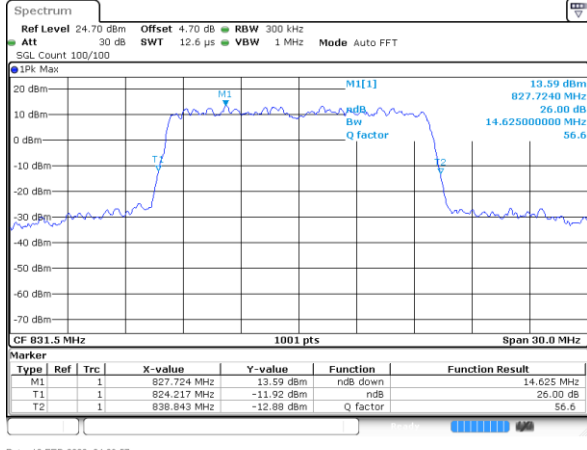

Date: 10 FEB 2020 04:03:57

Middle Channel / 15MHz / 64QAM

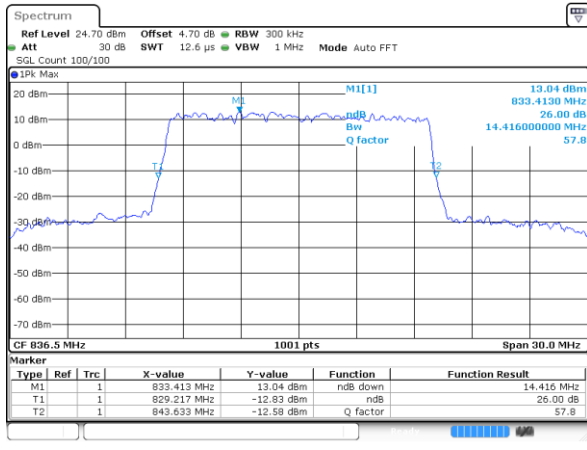

Date: 10 FEB 2020 04:04:18

Highest Channel / 15MHz / 64QAM

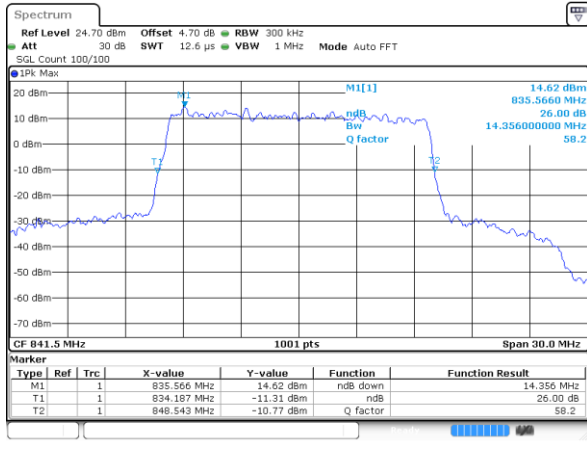

Date: 10 FEB 2020 04:06:05



Occupied Bandwidth

Mode	LTE Band 26 : 99%OBW(MHz)											
BW	1.4MHz		3MHz		5MHz		10MHz		15MHz		CH26765	
Mod.	QPSK	16QAM	QPSK	16QAM	QPSK	16QAM	QPSK	16QAM	QPSK	16QAM	QPSK	16QAM
Lowest CH	1.09	1.09	2.71	2.72	4.51	4.50	9.07	9.01	13.43	13.40	13.46	13.43
Middle CH	1.09	1.09	2.70	2.70	4.49	4.50	9.03	9.05	13.37	13.40	-	-
Highest CH	1.09	1.09	2.72	2.75	4.51	4.51	8.99	9.01	13.43	13.43	-	-
Mode	LTE Band 26 : 99%OBW(MHz)											
BW	1.4MHz		3MHz		5MHz		10MHz		15MHz		CH26765	
Mod.	64QAM		64QAM		64QAM		64QAM		64QAM		64QAM	
Lowest CH	1.09	-	2.74	-	4.50	-	9.03	-	13.40	-	13.40	-
Middle CH	1.08	-	2.73	-	4.49	-	9.03	-	13.40	-	-	-
Highest CH	1.09	-	2.72	-	4.53	-	9.01	-	13.43	-	-	-



LTE Band 26

Lowest Channel / 1.4MHz / QPSK

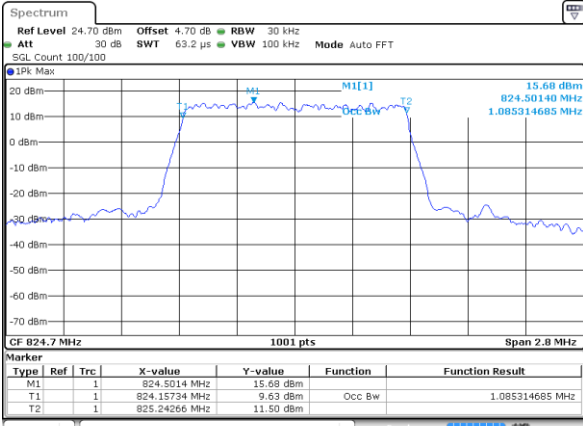

Date: 10.FEB.2020 03:18:15

Lowest Channel / 1.4MHz / 16QAM

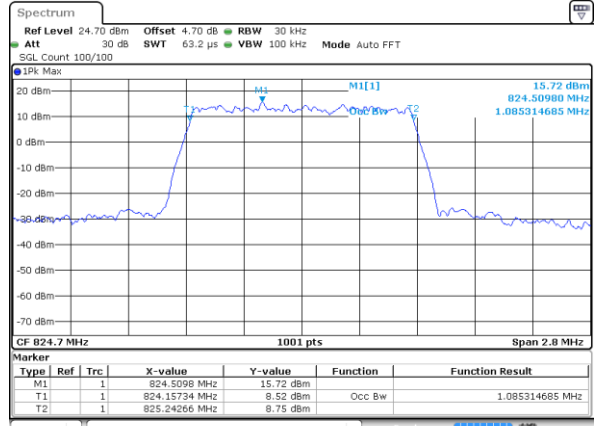

Date: 10.FEB.2020 03:18:35

Middle Channel / 1.4MHz / QPSK

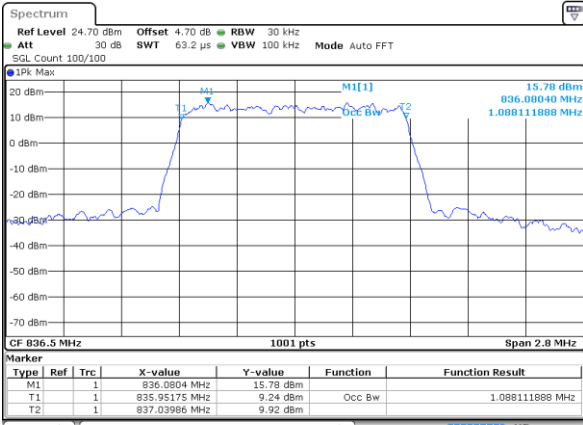

Date: 10.FEB.2020 03:28:08

Middle Channel / 1.4MHz / 16QAM

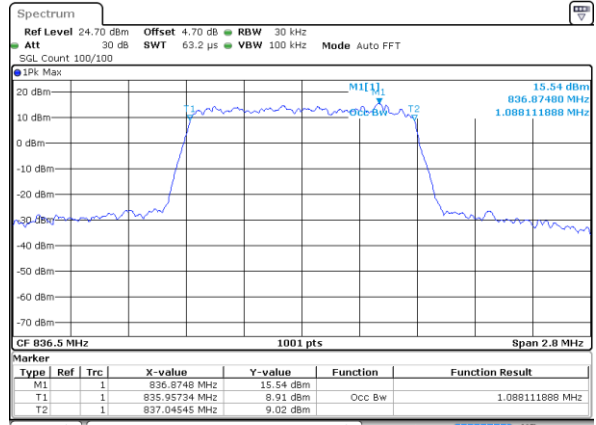

Date: 10.FEB.2020 03:27:48

Highest Channel / 1.4MHz / QPSK

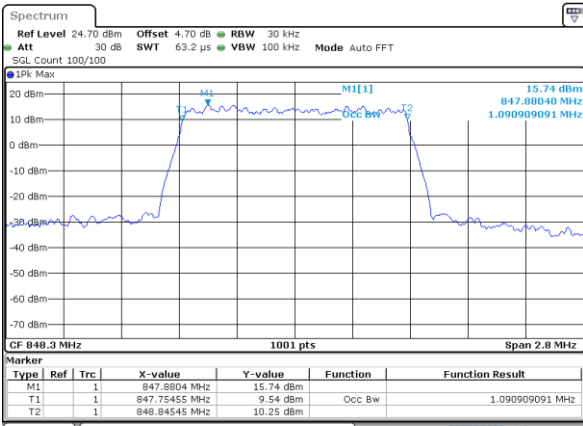

Date: 10.FEB.2020 03:28:28

Highest Channel / 1.4MHz / 16QAM

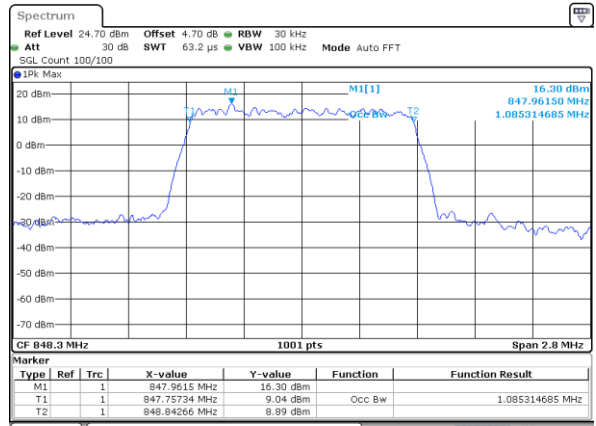

Date: 10.FEB.2020 03:28:48



LTE Band 26

Lowest Channel / 3MHz / QPSK

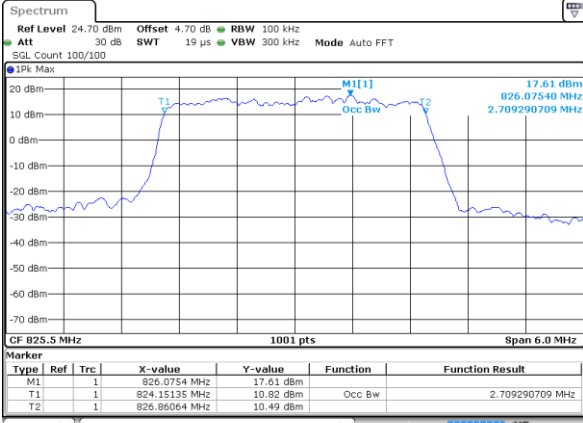

Date: 10 FEB 2020 03:29:28

Lowest Channel / 3MHz / 16QAM

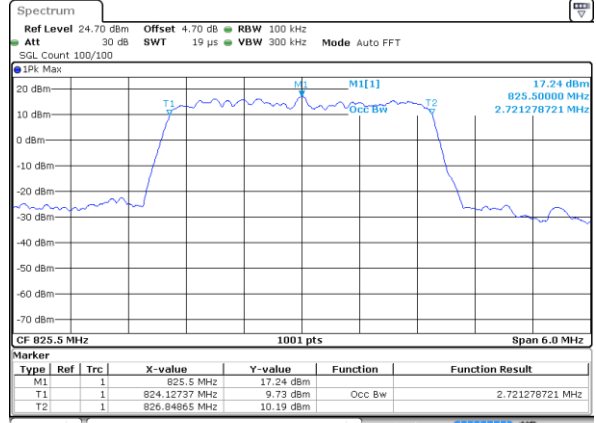

Date: 10 FEB 2020 03:29:48

Middle Channel / 3MHz / QPSK

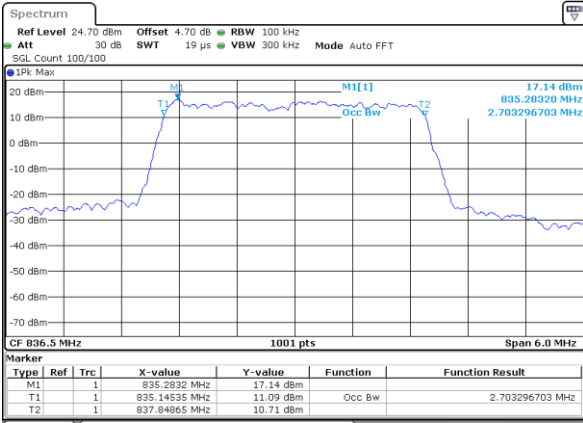

Date: 10 FEB 2020 03:31:09

Middle Channel / 3MHz / 16QAM

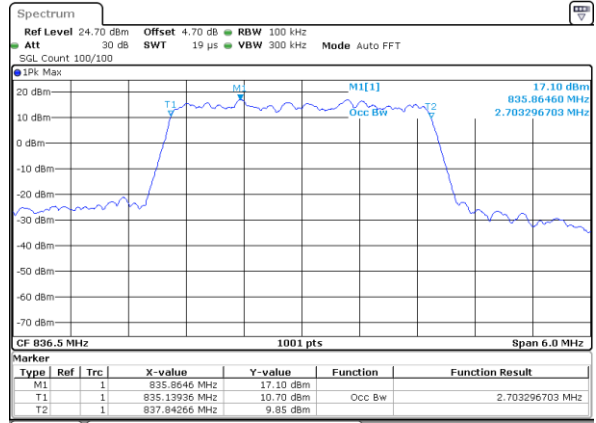

Date: 10 FEB 2020 03:30:49

Highest Channel / 3MHz / QPSK

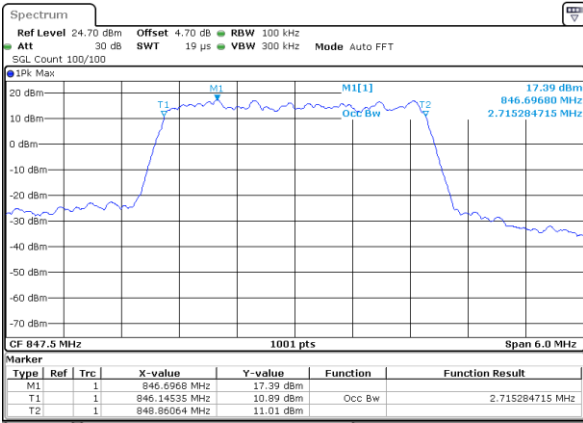

Date: 10 FEB 2020 03:31:29

Highest Channel / 3MHz / 16QAM

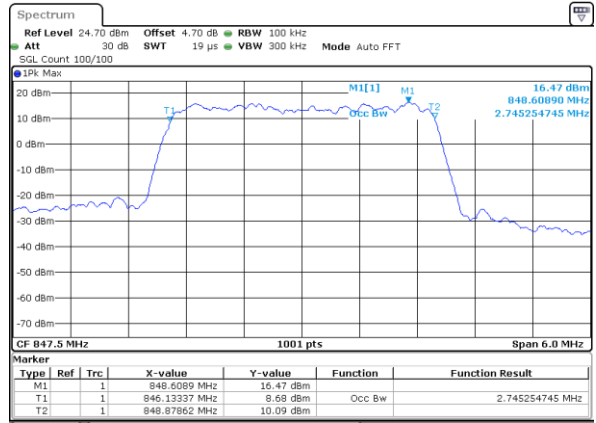

Date: 10 FEB 2020 03:31:49



LTE Band 26

Lowest Channel / 5MHz / QPSK

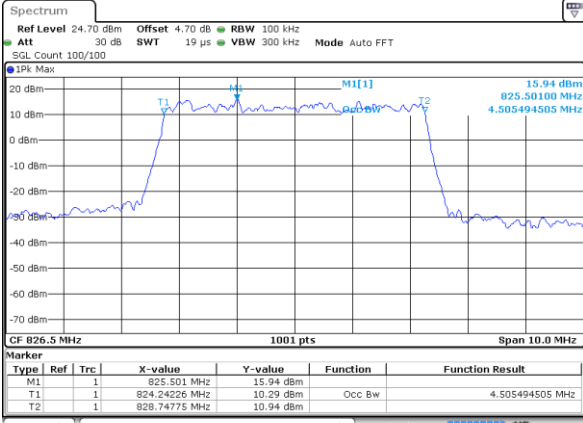

Date: 10 FEB 2020 03:40:41

Lowest Channel / 5MHz / 16QAM

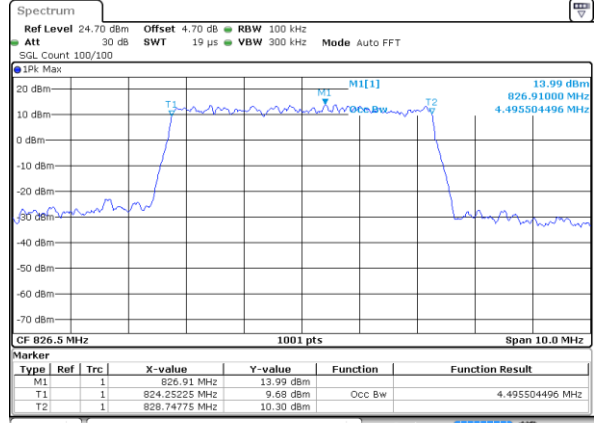

Date: 10 FEB 2020 03:41:01

Middle Channel / 5MHz / QPSK

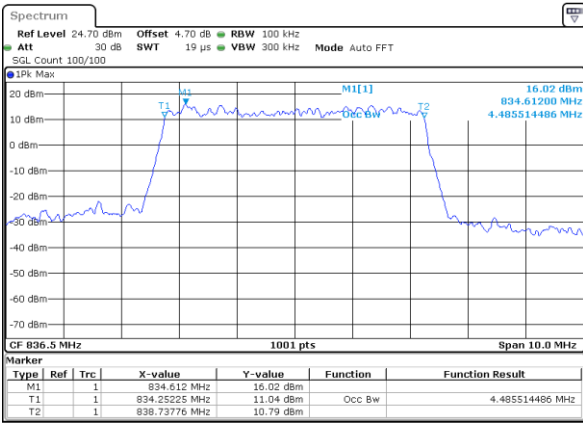

Date: 10 FEB 2020 03:42:21

Middle Channel / 5MHz / 16QAM

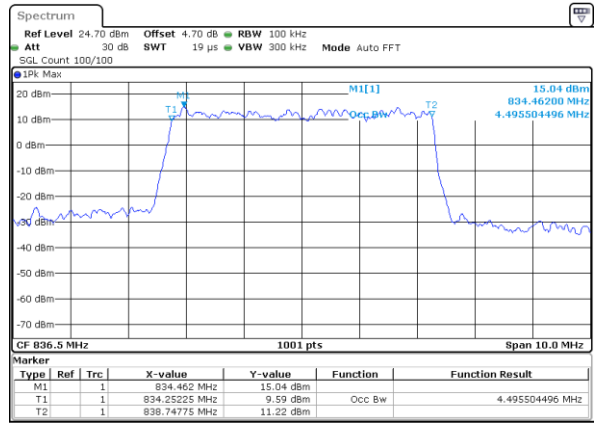

Date: 10 FEB 2020 03:42:01

Highest Channel / 5MHz / QPSK

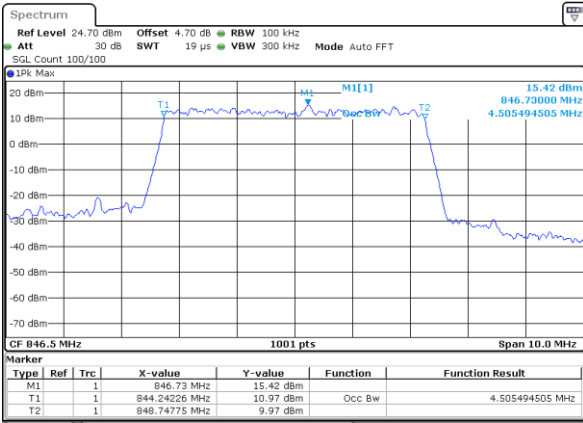

Date: 10 FEB 2020 03:42:41

Highest Channel / 5MHz / 16QAM

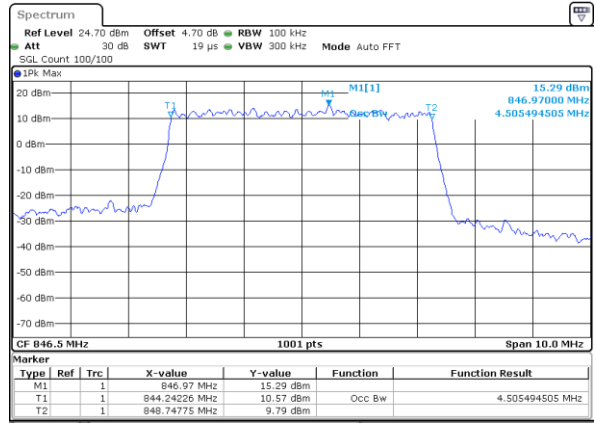

Date: 10 FEB 2020 03:43:01



LTE Band 26

Lowest Channel / 10MHz / QPSK

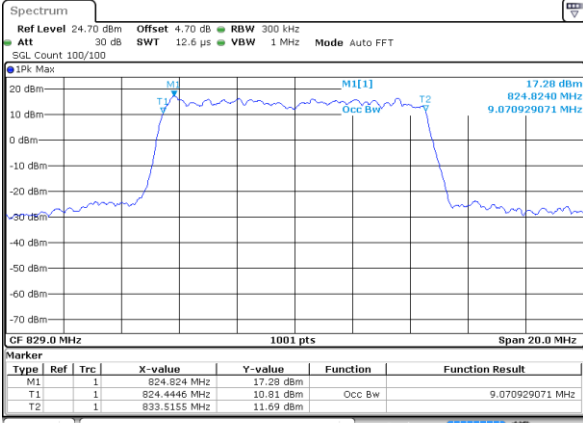

Date: 10 FEB 2020 03:51:53

Lowest Channel / 10MHz / 16QAM

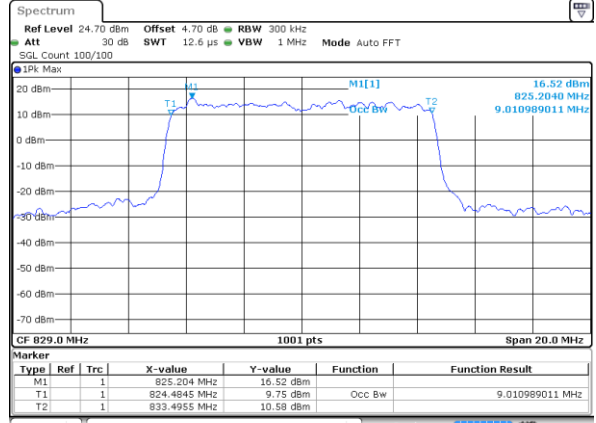

Date: 10 FEB 2020 03:52:13

Middle Channel / 10MHz / QPSK

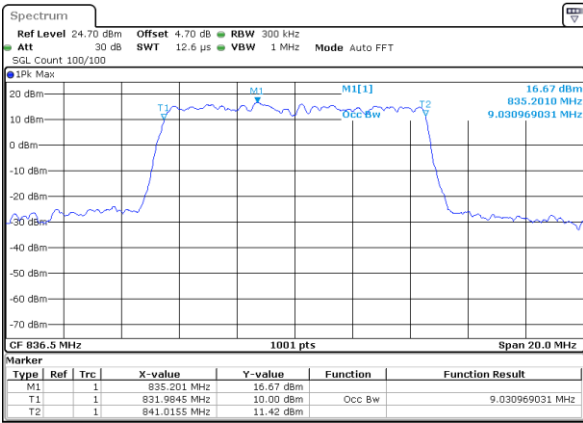

Date: 10 FEB 2020 03:53:33

Middle Channel / 10MHz / 16QAM

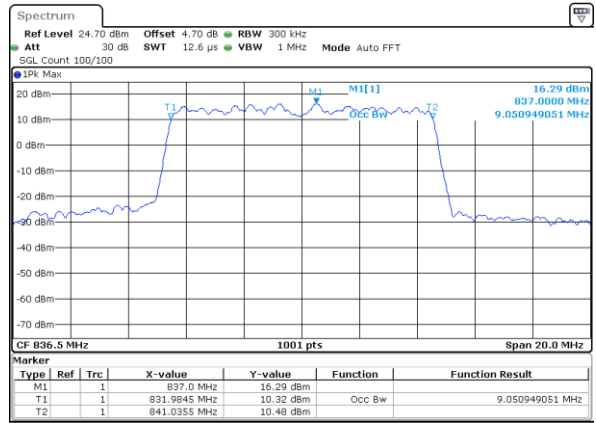

Date: 10 FEB 2020 03:53:13

Highest Channel / 10MHz / QPSK

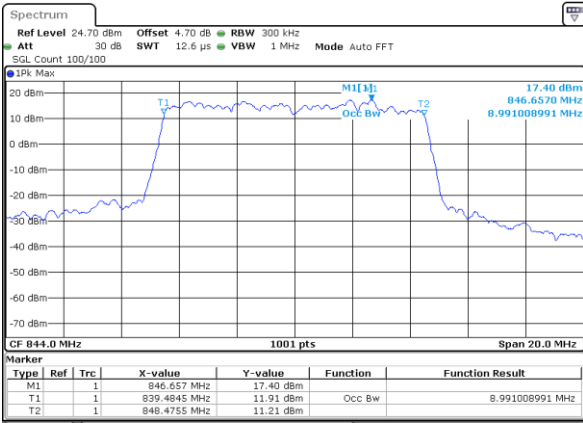

Date: 10 FEB 2020 03:53:54

Highest Channel / 10MHz / 16QAM

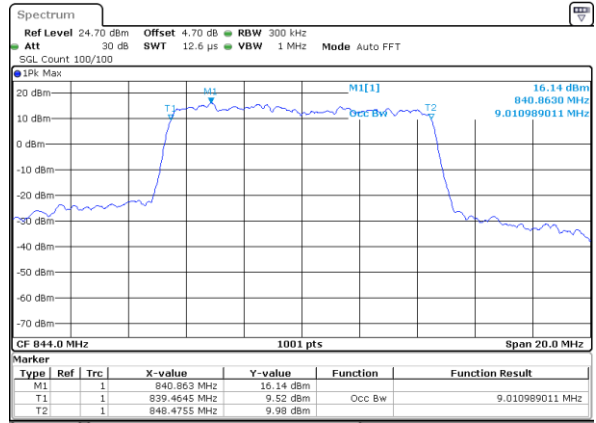

Date: 10 FEB 2020 03:54:14



LTE Band 26

Lowest Channel / 15MHz / QPSK

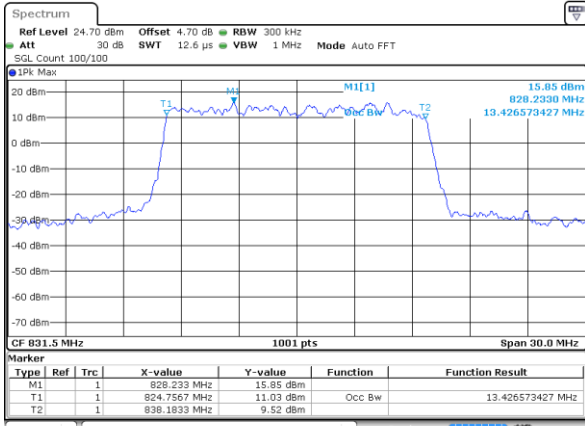

Date: 10 FEB 2020 04:03:07

Lowest Channel / 15MHz / 16QAM

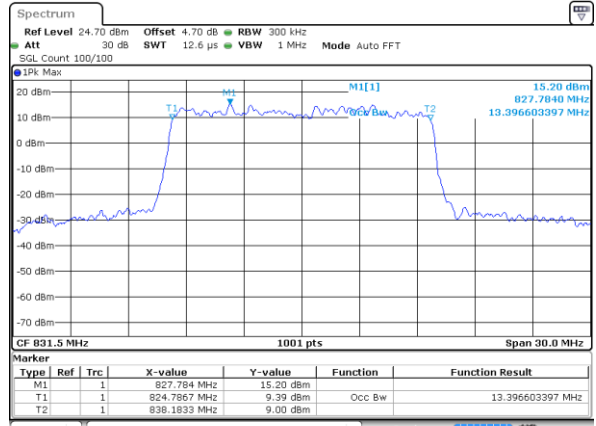

Date: 10 FEB 2020 04:03:27

Middle Channel / 15MHz / QPSK

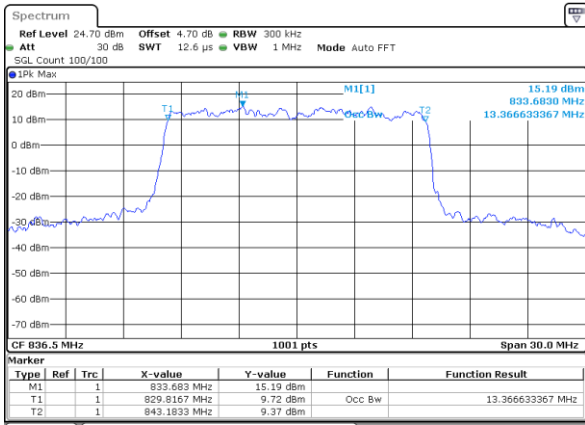

Date: 10 FEB 2020 04:04:54

Middle Channel / 15MHz / 16QAM

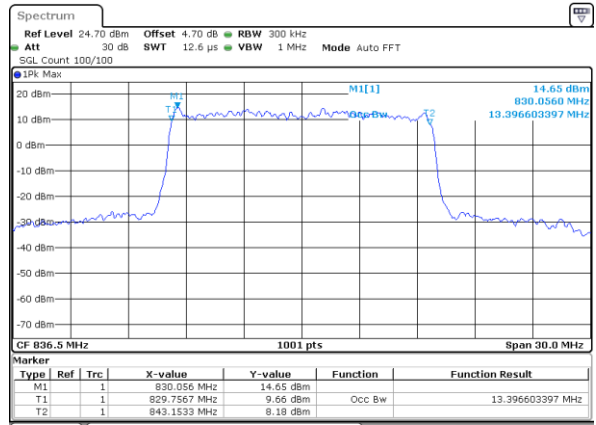

Date: 10 FEB 2020 04:04:34

Highest Channel / 15MHz / QPSK

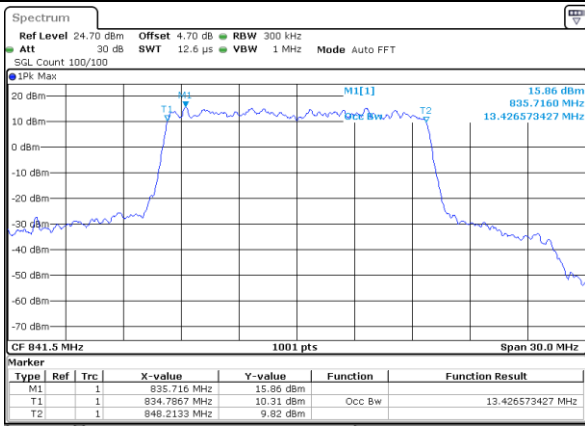

Date: 10 FEB 2020 04:05:15

Highest Channel / 15MHz / 16QAM

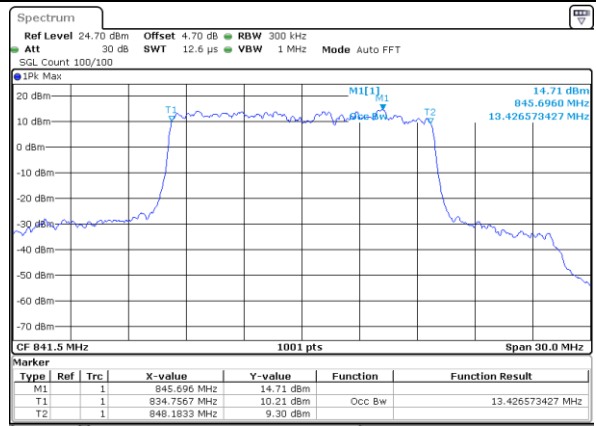

Date: 10 FEB 2020 04:05:35