



# FCC RADIO TEST REPORT

**FCC ID** : IHDT56YJ1  
**Equipment** : Mobile Cellular Phone  
**Brand Name** : Motorola  
**Model Name** : XT2061-1  
**Applicant** : Motorola Mobility, LLC  
222 W Merchandise Mart Plaza, Suite  
1800, Chicago, IL 60654, United States  
**Manufacturer** : Motorola Mobility, LLC  
222 W Merchandise Mart Plaza, Suite  
1800, Chicago, IL 60654, United States  
**Standard** : FCC Part 15 Subpart C §15.225

The product was received on Dec. 06, 2019 and testing was started from Jan. 02, 2020 and completed on Jan. 17, 2020. We, SPORTON INTERNATIONAL INC., EMC & Wireless Communications Laboratory, would like to declare that the tested sample has been evaluated in accordance with the test procedures and has been in compliance with the applicable technical standards.

The report must not be used by the client to claim product certification, approval, or endorsement by TAF or any agency of government.

The test results in this report apply exclusively to the tested model / sample. Without written approval of SPORTON INTERNATIONAL INC. EMC & Wireless Communications Laboratory, the test report shall not be reproduced except in full.

*Louis Wu*

Reviewed by: Louis Wu

**SPORTON INTERNATIONAL INC. EMC & Wireless Communications Laboratory**  
No. 52, Huaya 1st Rd., Guishan Dist., Taoyuan City, Taiwan (R.O.C.)



# Table of Contents

**History of this test report..... 3**

**Summary of Test Result..... 4**

**1. General Description ..... 5**

    1.1 Product Feature of Equipment Under Test ..... 5

    1.2 Product Specification of Equipment Under Test ..... 6

    1.3 Modification of EUT ..... 6

    1.4 Testing Location ..... 7

    1.5 Applicable Standards..... 7

**2. Test Configuration of Equipment Under Test..... 8**

    2.1 Descriptions of Test Mode ..... 8

    2.2 Connection Diagram of Test System ..... 8

    2.3 Table for Supporting Units ..... 10

    2.4 EUT Operation Test Setup ..... 10

**3. Test Results ..... 11**

    3.1 AC Power Line Conducted Emissions Measurement ..... 11

    3.2 20dB and 99% OBW Spectrum Bandwidth Measurement..... 13

    3.3 Frequency Stability Measurement ..... 14

    3.4 Field Strength of Fundamental Emissions and Mask Measurement..... 15

    3.5 Radiated Emissions Measurement ..... 17

    3.6 Antenna Requirements..... 20

**4. List of Measuring Equipment ..... 21**

**5. Uncertainty of Evaluation ..... 23**

**Appendix A. Test Results of Conducted Emission Test**

**Appendix B. Test Results of Conducted Test Items**

    B1. Test Result of 20dB Spectrum Bandwidth

    B2. Test Result of Frequency Stability

**Appendix C. Test Results of Radiated Test Items**

    C1. Test Result of Field Strength of Fundamental Emissions

    C2. Results of Radiated Emissions (9 kHz~30MHz)

    C3. Results of Radiated Emissions (30MHz~1GHz)





## Summary of Test Result

Report Clause	Ref Std. Clause	Test Items	Result (PASS/FAIL)	Remark
3.1	15.207	AC Power Line Conducted Emissions	Pass	Under limit 18.45 dB at 2.319MHz
3.2	15.215(c)	20dB Spectrum Bandwidth	Pass	-
	2.1049	99% OBW Spectrum Bandwidth	Reporting only	-
3.3	15.225(e)	Frequency Stability	Pass	-
3.4	15.225(a)(b)(c)	Field Strength of Fundamental Emissions	Pass	Max level 23.15 dB $\mu$ V/m at 13.56 MHz
3.5	15.225(d) 15.209	Radiated Spurious Emissions	Pass	Under limit 4.09 dB at 40.670MHz
3.6	15.203	Antenna Requirements	Pass	-

**Declaration of Conformity:**

The test results with all measurement uncertainty excluded are presented in accordance with the regulation limits or requirements declared by manufacturers.

**Comments and Explanations:**

The declared of product specification for EUT presented in the report are provided by the manufacturer, and the manufacturer takes all the responsibilities for the accuracy of product specification.

**Reviewed by: Wii Chang**

**Report Producer: Fiona Wu**



# 1. General Description

## 1.1 Product Feature of Equipment Under Test

Product Feature	
Equipment	Mobile Cellular Phone
Brand Name	Motorola
Model Name	XT2061-1
FCC ID	IHDT56YJ1
IMEI Code	<b>Conducted:</b> IMEI : 359120100011371 <b>Radiation:</b> IMEI : 359120100016305 <b>Conduction:</b> IMEI : 359120100016479 IMEI : 359120100019812
EUT supports Radios application	CDMA/EV-DO/GSM/EGPRS/WCDMA/HSPA/LTE/5G NR/ GNSS/NFC/WPC WLAN 11b/g/n HT20 WLAN 11a/n HT20/HT40 WLAN 11ac VHT20/VHT40/VHT80 WLAN 11ax HE20/HE40/HE80 Bluetooth BR/EDR/LE
HW Version	DVT2
EUT Stage	Identical Prototype

Remark: The above EUT's information was declared by manufacturer.

Accessory List	
AC Adapter 1	Brand Name : Motorola
	Model Name : SC-51 (SA18C30116)
	Manufacturer : Chenyang
AC Adapter 2	Brand Name : Motorola
	Model Name : SC-51 (SA18C62985)
	Manufacturer : Acbel
Battery	Brand Name : ATL
	Model Name : LW50
USB Cable 1	Brand Name : Motorola
	Model Name : SC18C24367
USB Cable 2	Brand Name : Motorola
	Model Name : SC18C24368



## 1.2 Product Specification of Equipment Under Test

Standards-related Product Specification	
Tx/Rx Frequency	13.56MHz
Channel Number	1
20dBW	2.64 KHz
99%OBW	2.24 KHz
Antenna Type	Flex antenna with winding coil pattern
Type of Modulation	ASK

Remark: The above EUT's information was declared by manufacturer.

## 1.3 Modification of EUT

No modifications are made to the EUT during all test items.



### 1.4 Testing Location

<b>Test Site</b>	SPORTON INTERNATIONAL INC. EMC & Wireless Communications Laboratory	
<b>Test Site Location</b>	No.52, Huaya 1st Rd., Guishan Dist., Taoyuan City, Taiwan (R.O.C.) TEL: +886-3-327-3456 FAX: +886-3-328-4978	
<b>Test Site No.</b>	<b>Sporton Site No.</b>	
	TH03-HY	CO05-HY
<b>Test Engineer</b>	Louis Chung	Tom Lee
<b>Temperature</b>	22-24°C	21-24°C
<b>Relative Humidity</b>	53-55%	42~45%

**Note:** The test site complies with ANSI C63.4 2014 requirement.

<b>Test Site</b>	SPORTON INTERNATIONAL INC. EMC & Wireless Communications Laboratory	
<b>Test Site Location</b>	No.58, Aly. 75, Ln. 564, Wenhua 3rd, Rd., Guishan Dist., Taoyuan City, Taiwan (R.O.C.) TEL: +886-3-327-0868 FAX: +886-3-327-0855	
<b>Test Site No.</b>	<b>Sporton Site No.</b>	
	03CH11-HY	
<b>Test Engineer</b>	Fu Chen, Cookie Ku, and Troye Hsieh	
<b>Temperature</b>	20.1~26.5°C	
<b>Relative Humidity</b>	44.1~68.9%	

**Note:** The test site complies with ANSI C63.4 2014 requirement.

FCC designation No.: TW1190 and TW0007

### 1.5 Applicable Standards

According to the specifications of the manufacturer, the EUT must comply with the requirements of the following standards:

- ♦ FCC Part 15 Subpart C §15.225
- ♦ FCC KDB 414788 D01 Radiated Test Site v01r01
- ♦ ANSI C63.10-2013

## 2. Test Configuration of Equipment Under Test

### 2.1 Descriptions of Test Mode

Investigation has been done on all the possible configurations.

The following table is a list of the test modes shown in this test report.

Test Items	
AC Power Line Conducted Emissions	Field Strength of Fundamental Emissions
20dB Spectrum Bandwidth	Frequency Stability
Radiated Emissions 9kHz~30MHz	Radiated Emissions 30MHz~1GHz

The EUT pre-scanned in four NFC type, A, B, F, V. The worst type (type F) was recorded in this report. Pre-scanned tests, X, Y, Z in three orthogonal panels to determine the final configuration (Z plane as worst plane) from all possible combinations.

Test Cases	
<b>AC Conducted Emission</b>	Mode 1: GSM 850 Idle + Bluetooth Link + WLAN (2.4GHz) Link + NFC Tx + Earphone + MPEG4 + USB Cable (Charging from Adapter 1)
<b>Remark:</b> For Radiated Test Cases, the tests were performed with Adapter 1 and USB Cable 1	

### 2.2 Connection Diagram of Test System

<AC Conducted Emission Mode>

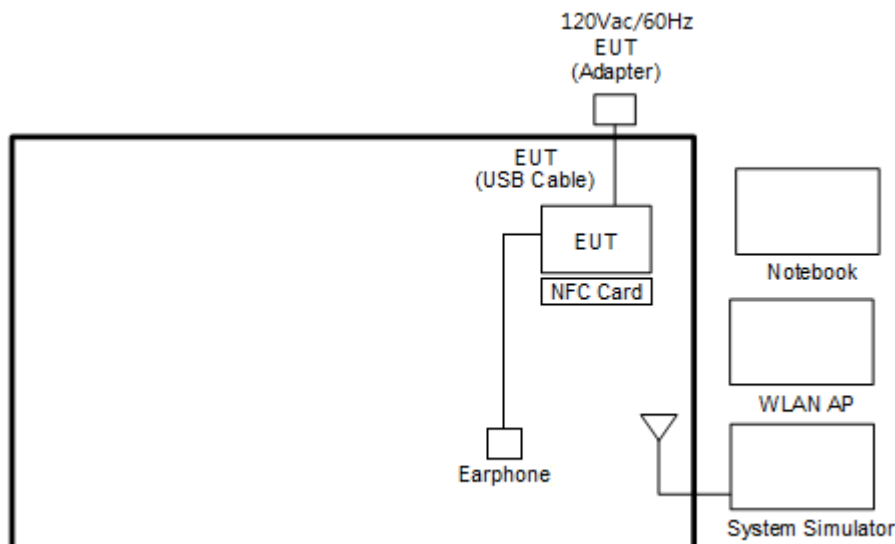

<NFC Tx Mode>

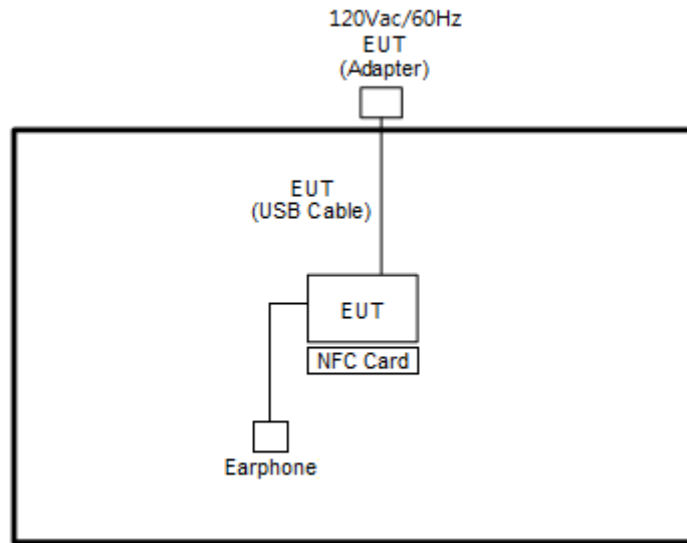

<NFC Tx Mode with WPC>

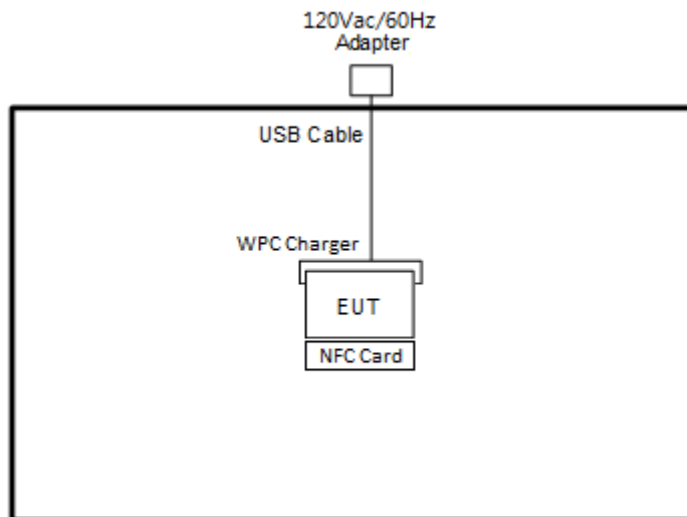

## 2.3 Table for Supporting Units

Item	Equipment	Trade Name	Model Name	FCC ID	Data Cable	Power Cord
1.	WLAN AP	ASUS	RT-AC66U	MSQ-RTAC66U	N/A	Unshielded, 1.8 m
2.	Notebook	DELL	Latitude E3400	FCC DoC	N/A	AC I/P : Unshielded, 1.2m DC O/P : Shielded, 1.8m
3.	Mobile Phone	Moto	moto burton	N/A	N/A	N/A
4.	System Simulator	R&S	CMU 200	N/A	N/A	Unshielded, 1.8 m
5.	NFC Card	N/A	N/A	N/A	N/A	N/A
6.	Earphone	Moto	NASH38C16618	N/A	Unshielded, 1.0 m	N/A
7.	Wireless Charger Stand	Samsung	EP-N5200	N/A	N/A	N/A
8.	Adapter	N/A	N/A	N/A	N/A	N/A
9.	USB Cable	N/A	N/A	N/A	N/A	N/A

## 2.4 EUT Operation Test Setup

The EUT was programmed to be in continuously transmitting mode.

The ancillary equipment, NFC card, is used to make the EUT (NFC) continuously transmit at 13.56MHz and is placed around 3 cm gap to the EUT.



### 3. Test Results

#### 3.1 AC Power Line Conducted Emissions Measurement

##### 3.1.1 Limit of AC Conducted Emission

For equipment that is designed to be connected to the public utility (AC) power line, the radio frequency voltage that is conducted back onto the AC power line on any frequency or frequencies within the band 150 kHz to 30 MHz shall not exceed the limits in the following table.

Frequency of Emission (MHz)	Conducted Limit (dBµV)	
	Quasi-Peak	Average
0.15-0.5	66 to 56*	56 to 46*
0.5-5	56	46
5-30	60	50

\*Decreases with the logarithm of the frequency.

For terminal test result, the testing follows FCC KDB 174176.

##### 3.1.2 Measuring Instruments

See list of measuring equipment of this test report.

##### 3.1.3 Test Procedures

1. The EUT was placed 0.4 meter from the conducting wall of the shielding room, and it was kept at least 80 centimeters from any other grounded conducting surface.
2. Connect EUT to the power mains through a line impedance stabilization network (LISN).
3. All the support units are connecting to the other LISN.
4. The LISN provides 50 ohm coupling impedance for the measuring instrument.
5. The FCC states that a 50 ohm, 50 microhenry LISN should be used.
6. Both sides of AC line were checked for maximum conducted interference.
7. The frequency range from 150 kHz to 30 MHz was searched.
8. Set the test-receiver system to Peak Detect Function and specified bandwidth (IF Bandwidth = 9kHz) with Maximum Hold Mode. Then measurement is also conducted by Average Detector and Quasi-Peak Detector Function respectively.

### 3.1.4 Test setup

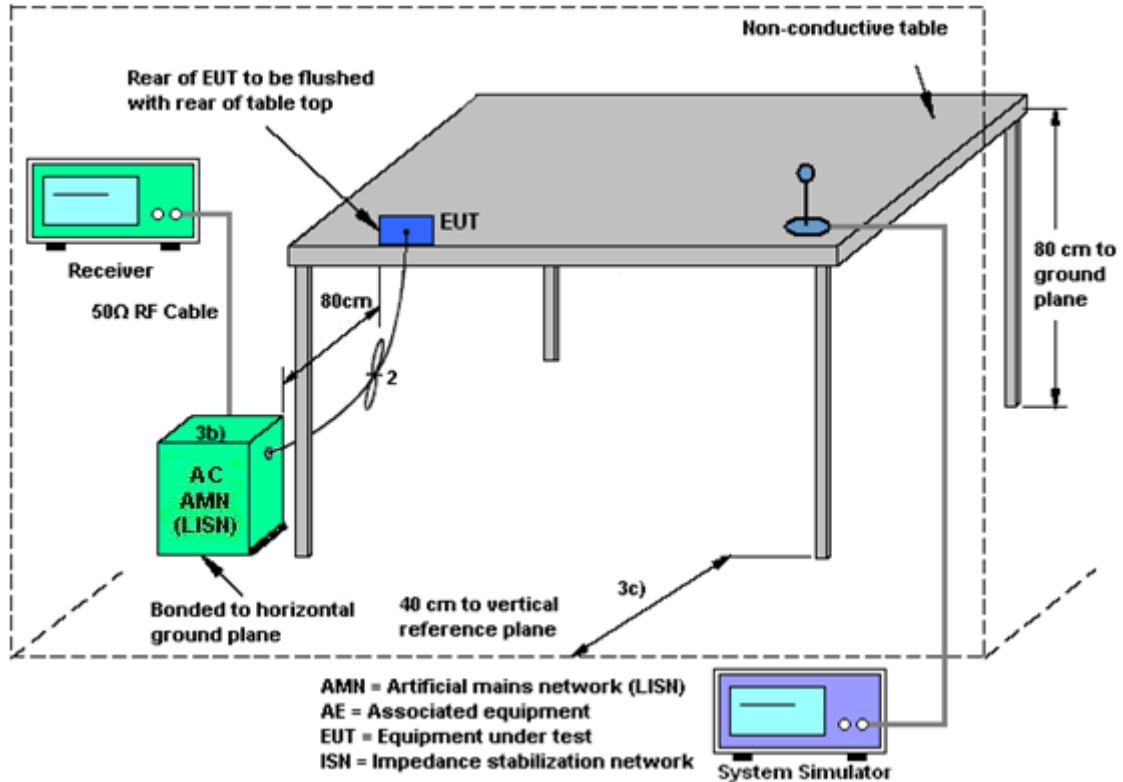

### 3.1.5 Test Result of AC Conducted Emission

Please refer to Appendix A.

**Note:**

(1) with antenna

Remark: 13.56MHz is the NFC RF fundamental signal.

(2) with dummy load

Remark: Only the fundamental NFC signal needs to be retested per C63.4.

## 3.2 20dB and 99% OBW Spectrum Bandwidth Measurement

### 3.2.1 Limit

Intentional radiators must be designed to ensure that the 20dB and 99% emission bandwidth in the specific band 13.553~13.567MHz.

### 3.2.2 Measuring Instruments

See list of measuring instruments of this test report.

### 3.2.3 Test Procedures

1. The spectrum analyzer connected via a receive antenna placed near the EUT in peak Max hold mode.
2. The resolution bandwidth of 1 kHz and the video bandwidth of 3 kHz were used.
3. Measured the spectrum width with power higher than 20dB below carrier.
4. Measured the 99% OBW.

### 3.2.4 Test Setup

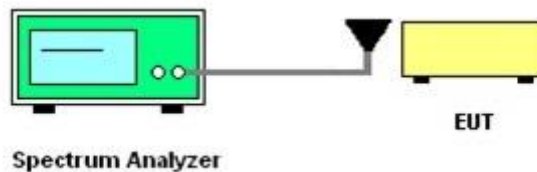

### 3.2.5 Test Result of Conducted Test Items

Please refer to Appendix B.

### 3.3 Frequency Stability Measurement

#### 3.3.1 Limit

The frequency tolerance of the carrier signal shall be maintained within +/- 0.01% (100ppm) of the operating frequency over a temperature variation of -20 degrees to +50 degrees C at normal supply voltage, and for a variation in the primary supply voltage from 85% to 115% of the rated supply voltage at a temperature of 20 degrees C. For battery operated equipment, the equipment tests shall be performed using a new battery.

#### 3.3.2 Measuring Instruments

See list of measuring instruments of this test report.

#### 3.3.3 Test Procedures

1. The spectrum analyzer connected via a receive antenna placed near the EUT.
2. EUT have transmitted signal and fixed channelize.
3. Set the spectrum analyzer span to view the entire emissions bandwidth.
4. Set RBW = 1 kHz, VBW = 3 kHz with peak detector and maxhold settings.
5. The  $f_c$  is declaring of channel frequency. Then the frequency error formula is  $(f_c - f) / f_c \times 10^6$  ppm and the limit is less than  $\pm 100$ ppm.
6. Extreme temperature rule is -20°C~50°C.

#### 3.3.4 Test Setup

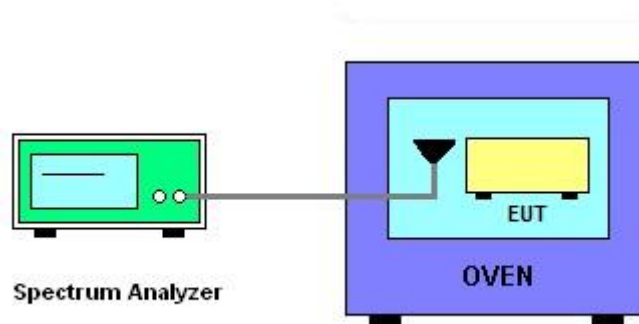

#### 3.3.5 Test Result of Conducted Test Items

Please refer to Appendix B.



### 3.4 Field Strength of Fundamental Emissions and Mask Measurement

#### 3.4.1 Limit

Rules and specifications	FCC CFR 47 Part 15 section 15.225			
Description	Compliance with the spectrum mask is tested with RBW set to 9kHz.			
Freq. of Emission (MHz)	Field Strength ( $\mu\text{V/m}$ ) at 30m	Field Strength ( $\text{dB}\mu\text{V/m}$ ) at 30m	Field Strength ( $\text{dB}\mu\text{V/m}$ ) at 10m	Field Strength ( $\text{dB}\mu\text{V/m}$ ) at 3m
1.705~13.110	30	29.5	48.58	69.5
13.110~13.410	106	40.5	59.58	80.5
13.410~13.553	334	50.5	69.58	90.5
13.553~13.567	15848	84.0	103.08	124.0
13.567~13.710	334	50.5	69.58	90.5
13.710~14.010	106	40.5	59.58	80.5
14.010~30.000	30	29.5	48.58	69.5

#### 3.4.2 Measuring Instruments

See list of measuring instruments of this test report.

### 3.4.3 Test Procedures

1. Configure the EUT according to ANSI C63.10. The EUT was placed on the top of the turntable 0.8 meter above ground. The phase center of the loop receiving antenna mounted antenna tower was placed 3 meters far away from the turntable.
2. Power on the EUT and all the supporting units. The turntable was rotated by 360 degrees to determine the position of the highest radiation.
3. The height of the receiving antenna was fixed at one meter above ground to find the maximum emissions field strength.
4. For Fundamental emissions, use the receiver to measure QP reading.
5. When the radiated emissions limits are expressed in terms of the average value of the emissions, and pulsed operation is employed, the measurement field strength shall be determined by averaging over one complete pulse train, including blanking intervals, as long as the pulse train does not exceed 0.1 seconds. As an alternative (provided the transmitter operates for longer than 0.1 seconds) or in cases where the pulse train exceeds 0.1 seconds, the measured field strength shall be determined from the average absolute voltage during a 0.1 second interval during which the field strength is at its maximum value.
6. Compliance with the spectrum mask is tested with RBW set to 9kHz.  
Note: Emission level (dB $\mu$ V/m) = 20 log Emission level ( $\mu$ V/m).

### 3.4.4 Test Setup

For radiated emissions below 30MHz

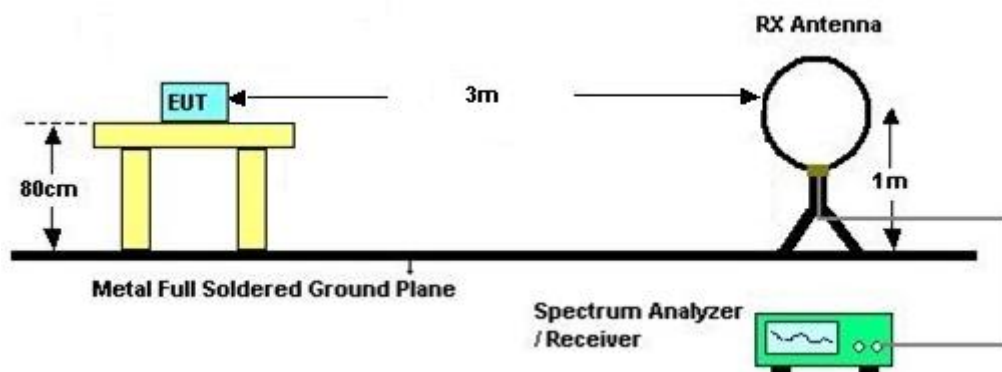

### 3.4.5 Test Result of Field Strength of Fundamental Emissions and Mask

Please refer to Appendix C.



### 3.5 Radiated Emissions Measurement

#### 3.5.1 Limit

The field strength of any emissions which appear outside of 13.110 ~14.010MHz band shall not exceed the general radiated emissions limits.

Frequencies (MHz)	Field Strength (µV/m)	Measurement Distance (meters)
0.009~0.490	2400/F(kHz)	300
0.490~1.705	24000/F(kHz)	30
1.705~30.0	30	30
30~88	100	3
88~216	150	3
216~960	200	3
Above 960	500	3

#### 3.5.2 Measuring Instruments

See list of measuring instruments of this test report.

#### 3.5.3 Measuring Instrument Setting

The following table is the setting of receiver:

Receiver Parameter	Setting
Attenuation	Auto
Frequency Range: 9kHz~150kHz	RBW 200Hz for QP
Frequency Range: 150kHz~30MHz	RBW 9kHz for QP
Frequency Range: 30MHz~1000MHz	RBW 120kHz for Peak

**Note:** The emission limits shown in the above table are based on measurements employing a CISPR quasi-peak detector except for the frequency bands 9-90 kHz and 110-490 kHz. Radiated emission limits in these two bands are based on measurements employing an average detector.



### 3.5.4 Test Procedures

1. Configure the EUT according to ANSI C63.10. The EUT was placed on the top of the turntable 0.8 meter above ground. The phase center of the receiving antenna mounted on the top of a height-variable antenna tower was placed 3 meters far away from the turntable.
2. Power on the EUT and all the supporting units. The turntable was rotated by 360 degrees to determine the position of the highest radiation.
3. The height of the broadband receiving antenna was varied between one meter and four meters above ground to find the maximum emissions field strength of both horizontal and vertical polarization.
4. For each suspected emissions, the antenna tower was scan (from 1 M to 4 M) and then the turntable was rotated (from 0 degree to 360 degrees) to find the maximum reading.
5. Set the test-receiver system to Peak or CISPR quasi-peak Detect Function with specified bandwidth under Maximum Hold Mode.
6. When the radiated emissions limits are expressed in terms of the average value of the emissions, and pulsed operation is employed, the measurement field strength shall be determined by averaging over one complete pulse train, including blanking intervals, as long as the pulse train does not exceed 0.1 seconds. As an alternative (provided the transmitter operates for longer than 0.1 seconds) or in cases where the pulse train exceeds 0.1 seconds, the measured field strength shall be determined from the average absolute voltage during a 0.1 second interval during which the field strength is at its maximum value.
7. In case the emission is lower than 30MHz, loop antenna has to be used for measurement and the recorded data should be QP measured by receiver.

### 3.5.5 Test Setup

For radiated emissions below 30MHz

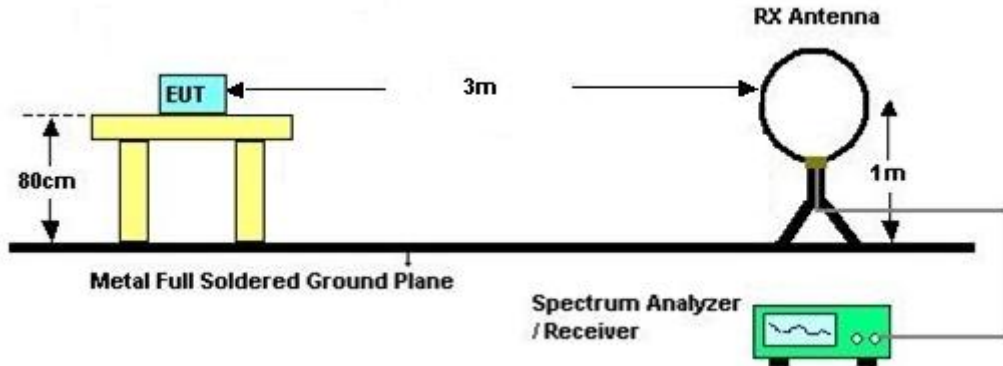

For radiated emissions above 30MHz

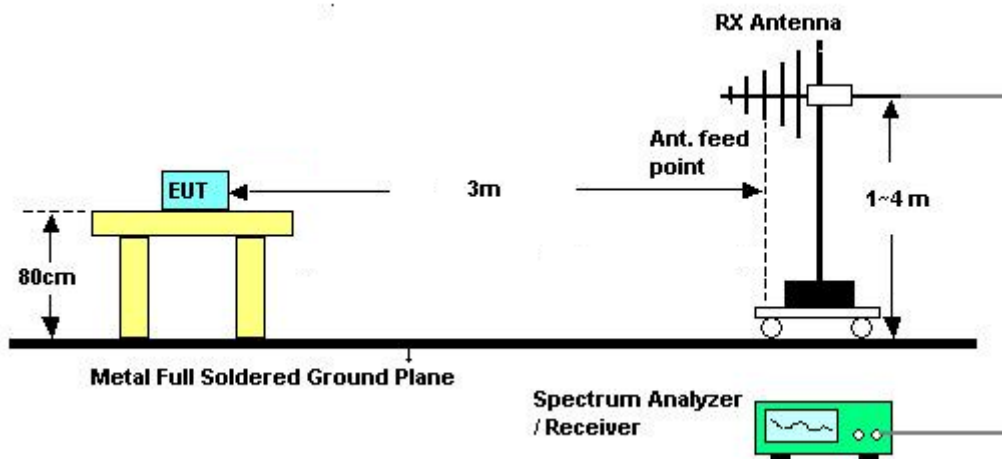

### 3.5.6 Test Result of Radiated Emissions Measurement

Please refer to Appendix C.

**Remark:** There is a comparison data of both open-field test site and alternative test site - semi-Anechoic chamber according to 414788 D01 Radiated Test Site v01r01, and the result came out very similar.



## **3.6 Antenna Requirements**

### **3.6.1 Standard Applicable**

Except for special regulations, the Low-power Radio-frequency Devices must not be equipped with any jacket for installing an antenna with extension cable. An intentional radiator shall be designed to ensure that no antenna other than that furnished by the responsible party shall be used with the device. The use of a permanently attached antenna or of an antenna that uses a unique coupling to the intentional radiator shall be considered sufficient to comply with the provisions of this Section. The manufacturer may design the unit so that the user can replace a broken antenna, but the use of a standard antenna jack or electrical connector is prohibited.

The use of a permanently attached antenna or of an antenna that uses a unique coupling to the intentional radiator shall be considered sufficient to comply with the rule.

### **3.6.2 Antenna Anti-Replacement Construction**

An embedded-in antenna design is used.



## 4. List of Measuring Equipment

Instrument	Manufacturer	Model No.	Serial No.	Characteristics	Calibration Date	Test Date	Due Date	Remark
AC Power Source	AC POWER	AFC-500W	F10407001 1	50Hz~60Hz	Apr. 12, 2019	Jan. 02, 2020	Apr. 11, 2020	Conducted (TH03-HY)
Hygrometer	Testo	608-H1	34893241	N/A	Mar. 06, 2019	Jan. 02, 2020	Mar. 05, 2020	Conducted (TH03-HY)
Spectrum Analyzer	Rohde & Schwarz	FSP30	101329	9kHz~30GHz	Sep. 04, 2019	Jan. 02, 2020	Sep. 03, 2020	Conducted (TH03-HY)
Temperature Chamber	ESPEC	SU-641	92013721	-30°C ~70°C	Nov. 26, 2019	Jan. 02, 2020	Nov. 25, 2020	Conducted (TH03-HY)
AC Power Source	ChainTek	APC-1000W	N/A	N/A	N/A	Jan. 07, 2020~ Jan. 17, 2020	N/A	Conduction (CO05-HY)
EMI Test Receiver	Rohde & Schwarz	ESR3	102388	9kHz~3.6GHz	Nov. 15, 2019	Jan. 07, 2020~ Jan. 17, 2020	Nov. 14, 2020	Conduction (CO05-HY)
Hygrometer	Testo	608-H1	34913912	N/A	Mar. 19, 2019	Jan. 07, 2020~ Jan. 17, 2020	Mar. 18, 2020	Conduction (CO05-HY)
LISN	Rohde & Schwarz	ENV216	100081	9kHz~30MHz	Nov. 15, 2019	Jan. 07, 2020~ Jan. 17, 2020	Nov. 14, 2020	Conduction (CO05-HY)
Software	Rohde & Schwarz	EMC32 V10.30	N/A	N/A	N/A	Jan. 07, 2020~ Jan. 17, 2020	N/A	Conduction (CO05-HY)
LF Cable	HUBER + SUHNER	RG-214/U	LF01	N/A	Jan. 02, 2020	Jan. 07, 2020~ Jan. 17, 2020	Jan. 01, 2021	Conduction (CO05-HY)
Pulse Limiter	Rohde & Schwarz	ESH3-Z2	100851	N/A	Jan. 02, 2020	Jan. 07, 2020~ Jan. 17, 2020	Jan. 01, 2021	Conduction (CO05-HY)



Instrument	Manufacturer	Model No.	Serial No.	Characteristics	Calibration Date	Test Date	Due Date	Remark
Software	Audix	E3 6.2009-8-24	RK-00105 3	N/A	N/A	Jan. 03, 2020~ Jan. 04, 2020	N/A	Radiation (03CH11-HY)
Amplifier	SONOMA	310N	187312	9kHz~1GHz	Dec. 03, 2019	Jan. 03, 2020~ Jan. 04, 2020	Dec. 02, 2020	Radiation (03CH11-HY)
Bilog Antenna	TESEQ	CBL 6111D & N-6-06	35414 & AT-N0602	30MHz~1GHz	Oct. 12, 2019	Jan. 03, 2020~ Jan. 04, 2020	Oct. 11, 2020	Radiation (03CH11-HY)
Loop Antenna	Rohde & Schwarz	HFH2-Z2	100488	9 kHz~30 MHz	Jan. 07, 2019	Jan. 03, 2020~ Jan. 04, 2020	Jan. 06, 2020	Radiation (03CH11-HY)
Controller	EMEC	EM 1000	N/A	Control Turn table & Ant Mast	N/A	Jan. 03, 2020~ Jan. 04, 2020	N/A	Radiation (03CH11-HY)
Antenna Mast	EMEC	AM-BS-4500- B	N/A	1~4m	N/A	Jan. 03, 2020~ Jan. 04, 2020	N/A	Radiation (03CH11-HY)
Turn Table	EMEC	TT 2000	N/A	0~360 Degree	N/A	Jan. 03, 2020~ Jan. 04, 2020	N/A	Radiation (03CH11-HY)
EMI Test Receiver	Agilent	N9038A(MXE )	MY554201 70	20MHz~8.4GHz	Mar. 08, 2019	Jan. 03, 2020~ Jan. 04, 2020	Mar. 07, 2020	Radiation (03CH11-HY)
Spectrum Analyzer	Keysight	N9010A	MY542004 86	10Hz~44GHz	Oct. 28, 2019	Jan. 03, 2020~ Jan. 04, 2020	Oct. 27, 2020	Radiation (03CH11-HY)
Filter	Wainwright	WHK20/1000 C7/40SS	SN2	20M High Pass	Sep. 15, 2019	Jan. 03, 2020~ Jan. 04, 2020	Sep. 14, 2020	Radiation (03CH11-HY)
RF Cable	HUBER + SUHNER	SUCOFLEX 104	MY9837/4 PE	9kHz-30MHz	Mar. 13, 2019	Jan. 03, 2020~ Jan. 04, 2020	Mar. 12, 2020	Radiation (03CH11-HY)
RF Cable	HUBER + SUHNER	SUCOFLEX 104	MY9837/4 PE	30M-18G	Mar. 13, 2019	Jan. 03, 2020~ Jan. 04, 2020	Mar. 12, 2020	Radiation (03CH11-HY)
RF Cable	HUBER + SUHNER	SUCOFLEX 102	MY2859/2	30MHz-40GHz	Mar. 13, 2019	Jan. 03, 2020~ Jan. 04, 2020	Mar. 12, 2020	Radiation (03CH11-HY)
Hygrometer	TECPEL	DTN-303B	TP140325	N/A	Nov. 07, 2019	Jan. 03, 2020~ Jan. 04, 2020	Nov. 06, 2020	Radiation (03CH11-HY)
Hygrometer	TECPEL	DTN-303B	TP161237	N/A	Oct. 25, 2019	Jan. 03, 2020~ Jan. 04, 2020	Oct. 24, 2020	Radiation (03CH11-HY)



## 5. Uncertainty of Evaluation

### Uncertainty of Conducted Emission Measurement (150 kHz ~ 30 MHz)

Measuring Uncertainty for a Level of Confidence of 95% ( $U = 2Uc(y)$ )	2.00
---	------

### Uncertainty of Radiated Emission Measurement (9 kHz ~ 30 MHz)

Measuring Uncertainty for a Level of Confidence of 95% ( $U = 2Uc(y)$ )	3.12
---	------

### Uncertainty of Radiated Emission Measurement (30 MHz ~ 1000 MHz)

Measuring Uncertainty for a Level of Confidence of 95% ( $U = 2Uc(y)$ )	5.20
---	------



## Appendix A. Test Results of Conducted Emission Test

Test Engineer :	Tom Lee	Temperature :	21~24°C
		Relative Humidity :	42~45%

## <Original Mode>

Report NO : 9D0635  
 Test Mode : Mode 1  
 Test Voltage : 120Vac/60Hz  
 Phase : Line

Full Spectrum

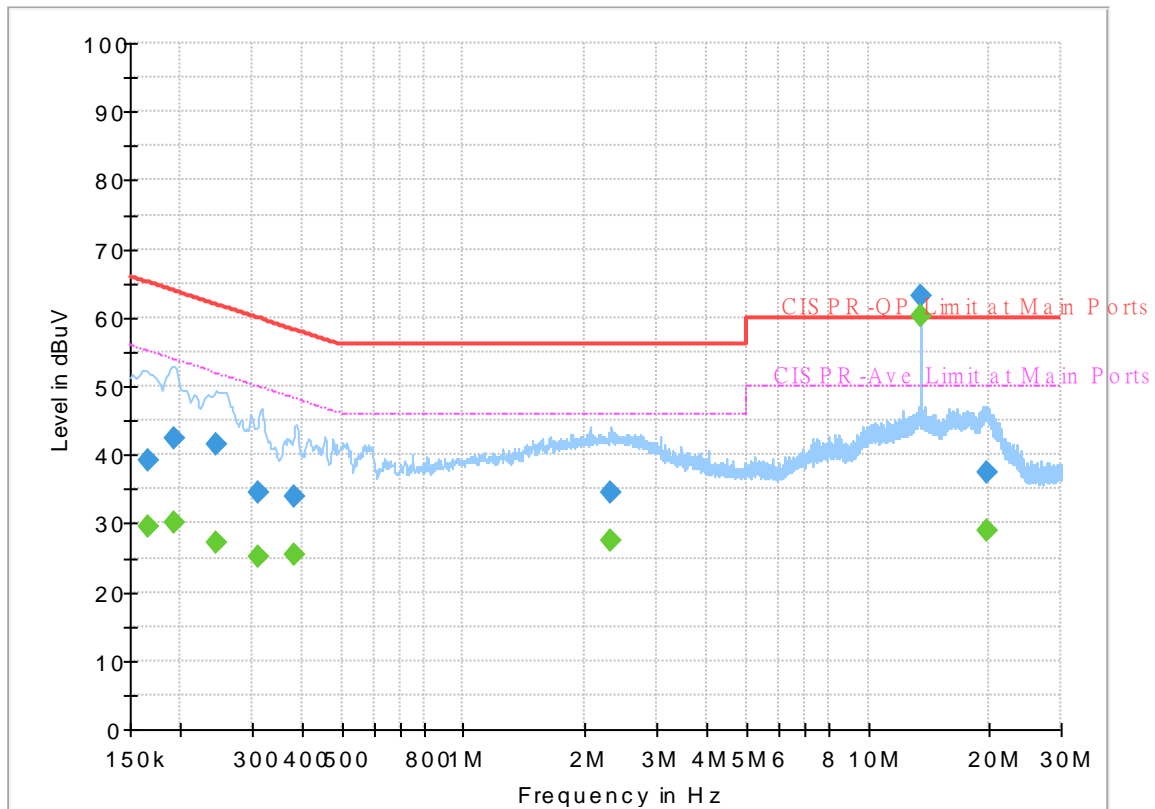

## Final\_Result

Frequency (MHz)	QuasiPeak (dBuV)	CAverage (dBuV)	Limit (dBuV)	Margin (dB)	Line	Filter	Corr. (dB)
0.165750	---	29.55	55.17	25.62	L1	OFF	19.5
0.165750	39.09	---	65.17	26.08	L1	OFF	19.5
0.191670	---	30.21	53.96	23.75	L1	OFF	19.5
0.191670	42.35	---	63.96	21.61	L1	OFF	19.5
0.244500	---	27.14	51.94	24.80	L1	OFF	19.5
0.244500	41.47	---	61.94	20.47	L1	OFF	19.5
0.312720	---	25.06	49.90	24.84	L1	OFF	19.5
0.312720	34.39	---	59.90	25.51	L1	OFF	19.5
0.381750	---	25.41	48.24	22.83	L1	OFF	19.5
0.381750	34.02	---	58.24	24.22	L1	OFF	19.5
2.319000	---	27.55	46.00	18.45	L1	OFF	19.7
2.319000	34.44	---	56.00	21.56	L1	OFF	19.7
13.560000	---	60.34	50.00	-10.34	L1	OFF	20.1
13.560000	63.14	---	60.00	-3.14	L1	OFF	20.1
19.692150	---	29.00	50.00	21.00	L1	OFF	20.2
19.692150	37.41	---	60.00	22.59	L1	OFF	20.2

Report NO : 9D0635  
 Test Mode : Mode 1  
 Test Voltage : 120Vac/60Hz  
 Phase : Neutral

Full Spectrum

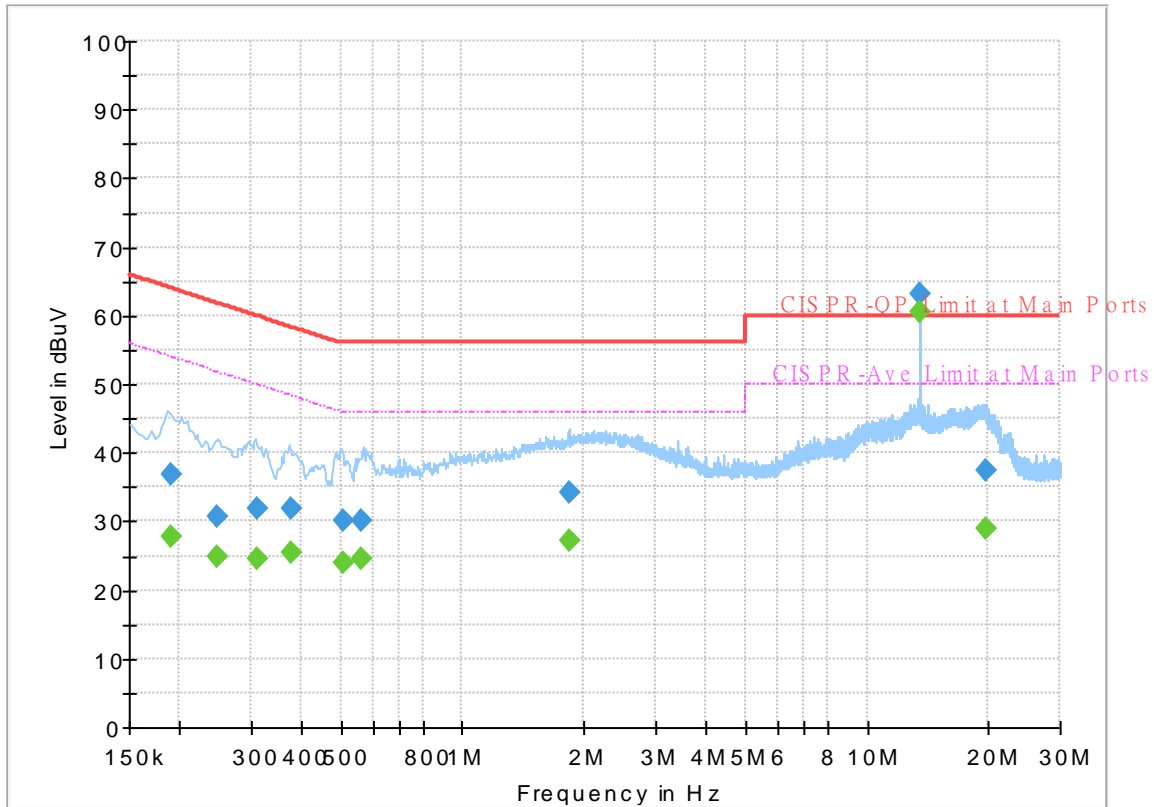

Final\_Result

Frequency (MHz)	QuasiPeak (dBuV)	CAverage (dBuV)	Limit (dBuV)	Margin (dB)	Line	Filter	Corr. (dB)
0.190770	---	27.92	54.00	26.08	N	OFF	19.6
0.190770	36.79	---	64.00	27.21	N	OFF	19.6
0.247380	---	24.87	51.85	26.98	N	OFF	19.6
0.247380	30.77	---	61.85	31.08	N	OFF	19.6
0.309750	---	24.45	49.98	25.53	N	OFF	19.6
0.309750	31.74	---	59.98	28.24	N	OFF	19.6
0.376800	---	25.40	48.35	22.95	N	OFF	19.6
0.376800	31.75	---	58.35	26.60	N	OFF	19.6
0.507750	---	24.11	46.00	21.89	N	OFF	19.6
0.507750	30.22	---	56.00	25.78	N	OFF	19.6
0.564000	---	24.66	46.00	21.34	N	OFF	19.6
0.564000	29.99	---	56.00	26.01	N	OFF	19.6
1.835250	---	27.07	46.00	18.93	N	OFF	19.6
1.835250	34.23	---	56.00	21.77	N	OFF	19.6
13.560000	---	60.42	50.00	-10.42	N	OFF	20.1
13.560000	63.25	---	60.00	-3.25	N	OFF	20.1
19.577850	---	28.97	50.00	21.03	N	OFF	20.3
19.577850	37.51	---	60.00	22.49	N	OFF	20.3

## <Terminal Mode>

Report NO : 9D0635  
 Test Mode : Mode 1  
 Test Voltage : 120Vac/60Hz  
 Phase : Line

Full Spectrum

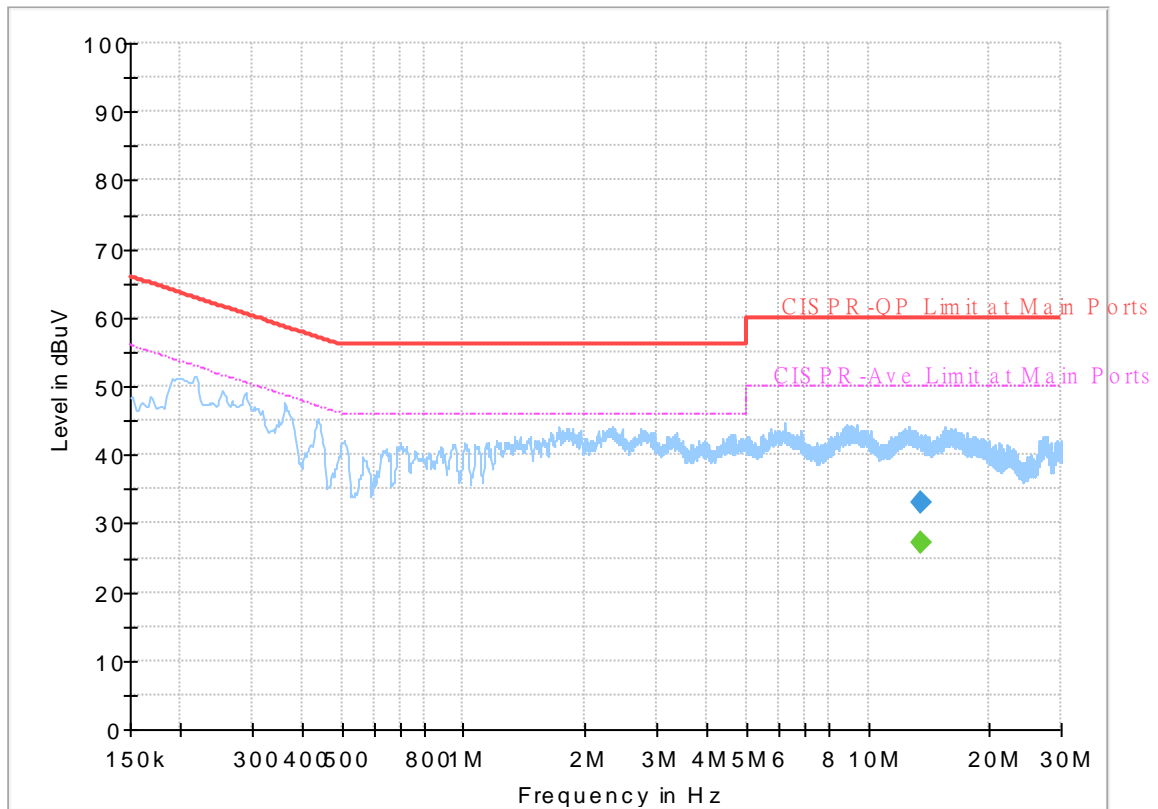

## Final\_Result

Frequency (MHz)	QuasiPeak (dBuV)	CAverage (dBuV)	Limit (dBuV)	Margin (dB)	Line	Filter	Corr. (dB)
13.560000	---	27.33	50.00	22.67	L1	OFF	20.1
13.560000	32.96	---	60.00	27.04	L1	OFF	20.1

Report NO : 9D0635  
 Test Mode : Mode 1  
 Test Voltage : 120Vac/60Hz  
 Phase : Neutral

Full Spectrum

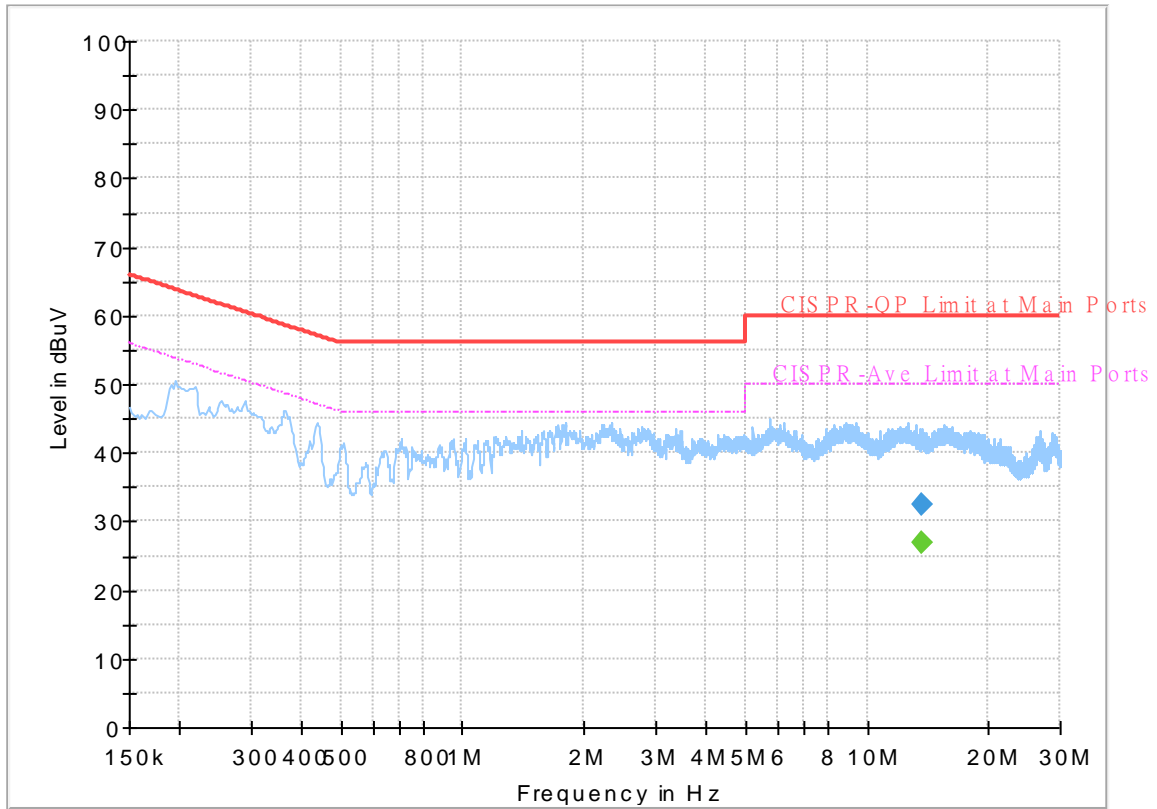

Final\_Result

Frequency (MHz)	QuasiPeak (dBuV)	CAverage (dBuV)	Limit (dBuV)	Margin (dB)	Line	Filter	Corr. (dB)
13.560000	---	26.96	50.00	23.04	N	OFF	20.1
13.560000	32.42	---	60.00	27.58	N	OFF	20.1



# Appendix B. Test Results of Conducted Test Items

## B1. Test Result of 20dB Spectrum Bandwidth

Test mode	NFC Tx	Test Frequency (MHz)	13.56
Date: 2.JAN.2020 10:45:28		Date: 2.JAN.2020 10:45:09	
<b>20dB Bandwidth (kHz)</b>	2.640	<b>99% OccupiedBW(kHz)</b>	2.240
<b>Frequency range (MHz)</b>	$f_L > 13.553$	13.55862	<b>Test Result</b>
	$f_H < 13.567$	13.56126	<b>Complies</b>

**Remark:** Because the measured signal is CW adjusting the RBW per C63.10 would not be practical since measured bandwidth will always follow the RBW and the result will be approximately twice the RBW.



B2. Test Result of Frequency Stability

Voltage vs. Frequency Stability		Temperature vs. Frequency Stability		
Voltage (Vac)	Measurement Frequency (MHz)	Temperature (°C)	Time	Measurement Frequency (MHz)
120	13.559940	-20	0	13.560030
			2	13.560020
			5	13.560020
			10	13.560020
		-10	0	13.560030
			2	13.560040
			5	13.560030
			10	13.560040
		0	0	13.560020
			2	13.560020
			5	13.560020
			10	13.560020
		10	0	13.560020
			2	13.560020
			5	13.560000
			10	13.560000
		20	0	13.559940
			2	13.559940
			5	13.559920
			10	13.559920
		30	0	13.559900
			2	13.559900
			5	13.559920
			10	13.559920
		40	0	13.559930
			2	13.559900
			5	13.559890
			10	13.559900



Voltage vs. Frequency Stability		Temperature vs. Frequency Stability		
Voltage (Vac)	Measurement Frequency (MHz)	Temperature (°C)	Time	Measurement Frequency (MHz)
		50	0	13.559900
			2	13.559900
			5	13.559875
			10	13.559880
Max.Deviation (MHz)	-0.000070	Max.Deviation (MHz)		-0.000125
Max.Deviation (ppm)	-5.1622	Max.Deviation (ppm)		-9.2183
Limit	FS < ±100 ppm	Limit		FS < ±100 ppm
Test Result	PASS	Test Result		PASS



## Appendix C. Test Results of Radiated Test Items

### C1. Test Result of Field Strength of Fundamental Emissions

Test Mode :	NFC Tx	Test Frequency (MHz)	13.56																																
Site : 03CH11-HY Condition : 15.225 3m LOOP_ANT(H) HORIZONTAL : RBW:9.000KHz VBW:9.000KHz SWT:Auto Project : 9D0635																																			
<table border="1"> <thead> <tr> <th>Over</th> <th>Limit</th> <th>ReadAntenna</th> <th>Cable</th> <th>A/Pos</th> <th>T/Pos</th> <th>Remark</th> </tr> <tr> <th>Limit</th> <th>Line</th> <th>Level</th> <th>Loss</th> <th></th> <th></th> <th></th> </tr> <tr> <th>dB</th> <th>dBuV/m</th> <th>dBuV</th> <th>dB</th> <th>cm</th> <th>deg</th> <th></th> </tr> </thead> <tbody> <tr> <td>1</td> <td>13.56</td> <td>22.49</td> <td>-61.51</td> <td>84.00</td> <td>41.17</td> <td>21.18</td> <td>0.14</td> <td>100</td> <td>354</td> <td>QP</td> </tr> </tbody> </table>				Over	Limit	ReadAntenna	Cable	A/Pos	T/Pos	Remark	Limit	Line	Level	Loss				dB	dBuV/m	dBuV	dB	cm	deg		1	13.56	22.49	-61.51	84.00	41.17	21.18	0.14	100	354	QP
Over	Limit	ReadAntenna	Cable	A/Pos	T/Pos	Remark																													
Limit	Line	Level	Loss																																
dB	dBuV/m	dBuV	dB	cm	deg																														
1	13.56	22.49	-61.51	84.00	41.17	21.18	0.14	100	354	QP																									
Site : 03CH11-HY Condition : 15.225 3m LOOP_ANT(V) VERTICAL : RBW:9.000KHz VBW:9.000KHz SWT:Auto Project : 9D0635																																			
<table border="1"> <thead> <tr> <th>Over</th> <th>Limit</th> <th>ReadAntenna</th> <th>Cable</th> <th>A/Pos</th> <th>T/Pos</th> <th>Remark</th> </tr> <tr> <th>Limit</th> <th>Line</th> <th>Level</th> <th>Loss</th> <th></th> <th></th> <th></th> </tr> <tr> <th>dB</th> <th>dBuV/m</th> <th>dBuV</th> <th>dB</th> <th>cm</th> <th>deg</th> <th></th> </tr> </thead> <tbody> <tr> <td>1</td> <td>13.56</td> <td>18.90</td> <td>-65.10</td> <td>84.00</td> <td>37.58</td> <td>21.18</td> <td>0.14</td> <td>100</td> <td>84</td> <td>QP</td> </tr> </tbody> </table>				Over	Limit	ReadAntenna	Cable	A/Pos	T/Pos	Remark	Limit	Line	Level	Loss				dB	dBuV/m	dBuV	dB	cm	deg		1	13.56	18.90	-65.10	84.00	37.58	21.18	0.14	100	84	QP
Over	Limit	ReadAntenna	Cable	A/Pos	T/Pos	Remark																													
Limit	Line	Level	Loss																																
dB	dBuV/m	dBuV	dB	cm	deg																														
1	13.56	18.90	-65.10	84.00	37.58	21.18	0.14	100	84	QP																									



<b>Test Mode :</b>	NFC Tx with WPC	<b>Test Frequency (MHz)</b>	13.56
--------------------	-----------------	-----------------------------	-------

Date: 2020-01-03

Site : 03CH11-HY  
 Condition : 15.225 3m LOOP\_ANT(H) HORIZONTAL  
 : RBW:9.000KHz VBW:9.000KHz SWT:Auto  
 Project : 9D0635

	Over	Limit	ReadAntenna	Cable	A/Pos	T/Pos	Remark
Freq	Level	Limit	Line	Level	Factor	Loss	
MHz	dBuV/m	dB	dBuV/m	dBuV	dB/m	dB	cm deg
1	13.56	23.15	-60.85	84.00	41.83	21.18	0.14 100 359 QP

  

Date: 2020-01-03

Site : 03CH11-HY  
 Condition : 15.225 3m LOOP\_ANT(V) VERTICAL  
 : RBW:9.000KHz VBW:9.000KHz SWT:Auto  
 Project : 9D0635

	Over	Limit	ReadAntenna	Cable	A/Pos	T/Pos	Remark
Freq	Level	Limit	Line	Level	Factor	Loss	
MHz	dBuV/m	dB	dBuV/m	dBuV	dB/m	dB	cm deg
1	13.56	17.00	-67.00	84.00	35.68	21.18	0.14 100 89 QP

**C2. Results of Radiated Spurious Emissions (9 kHz~30MHz)**

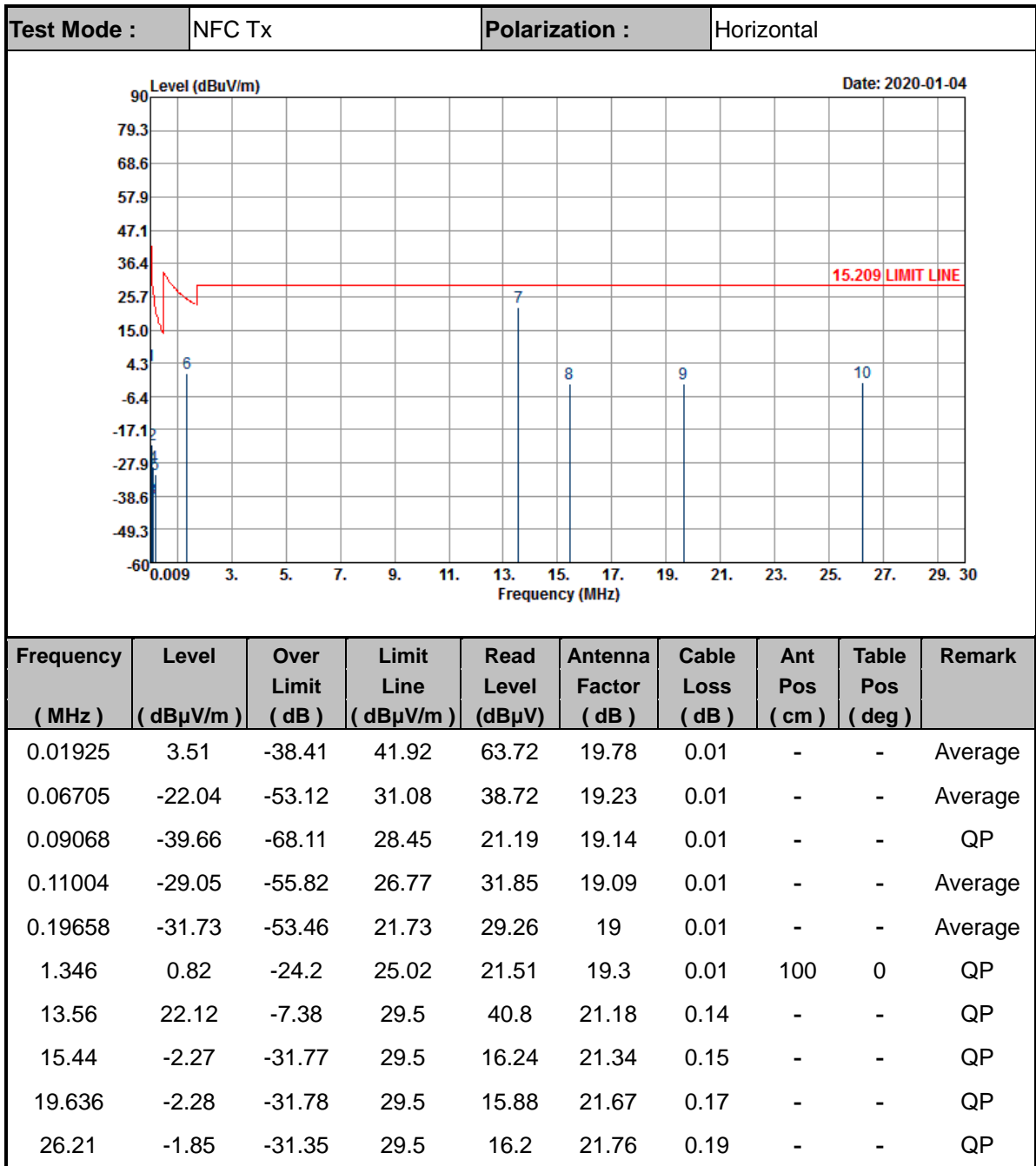

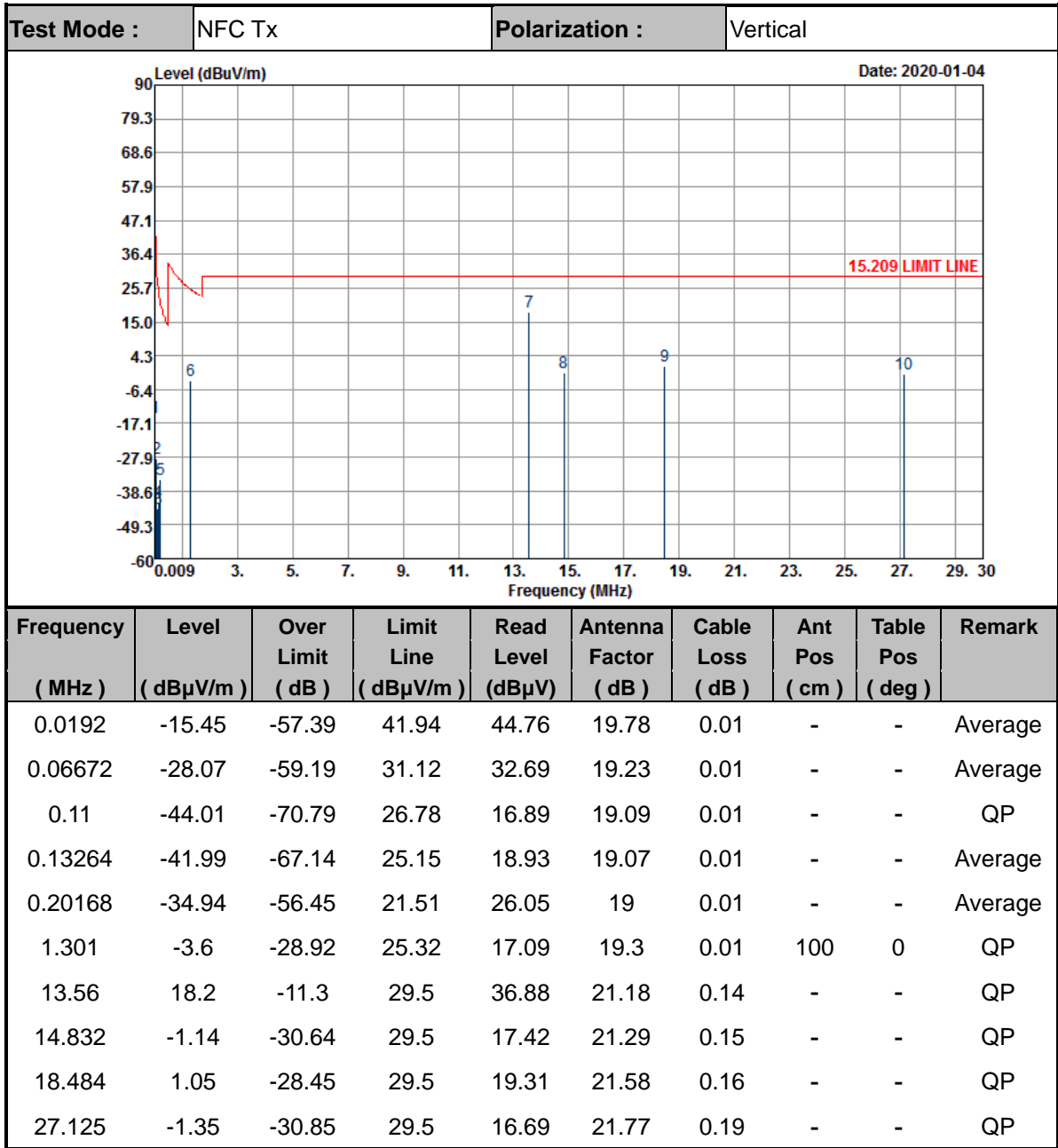

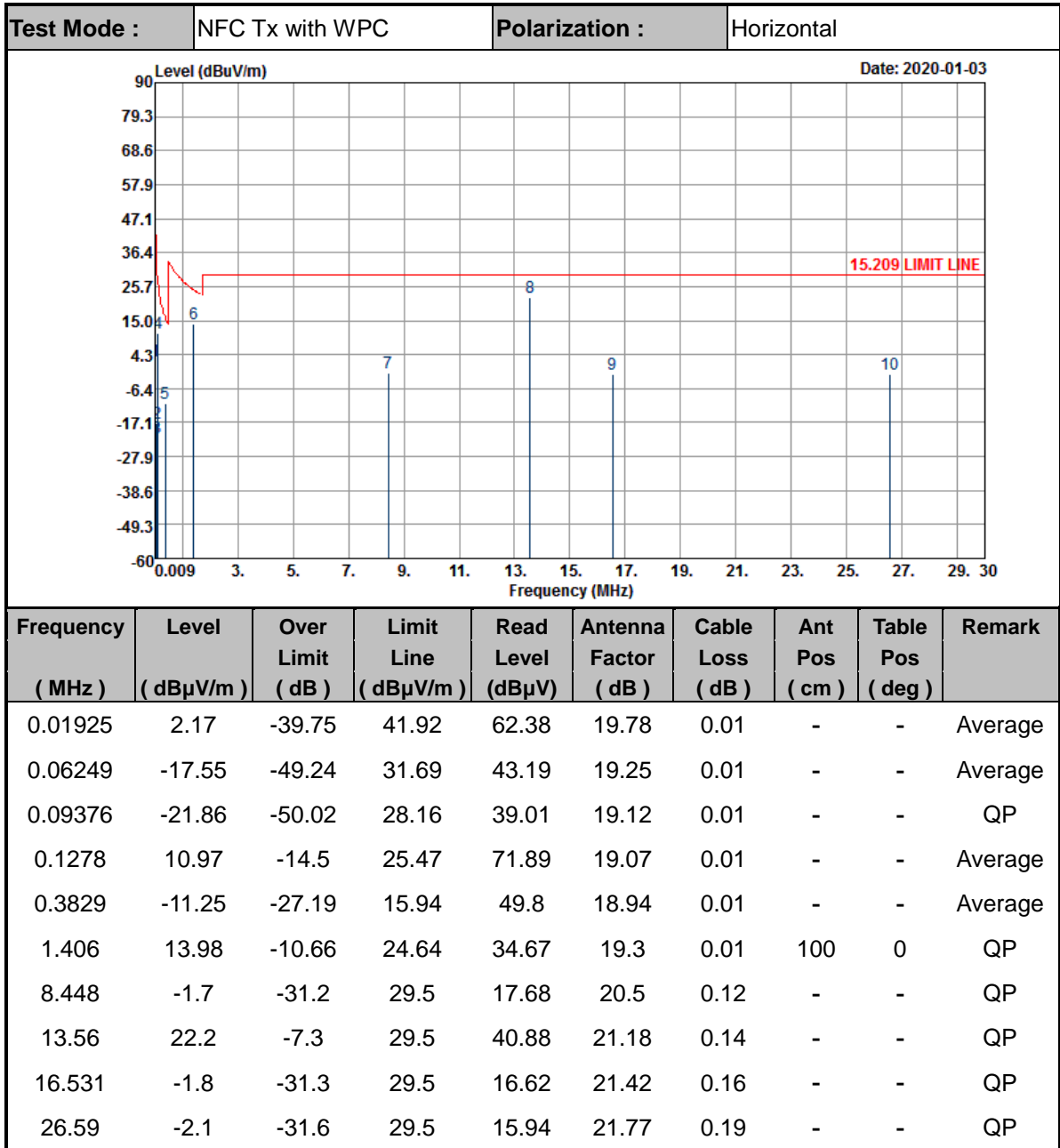

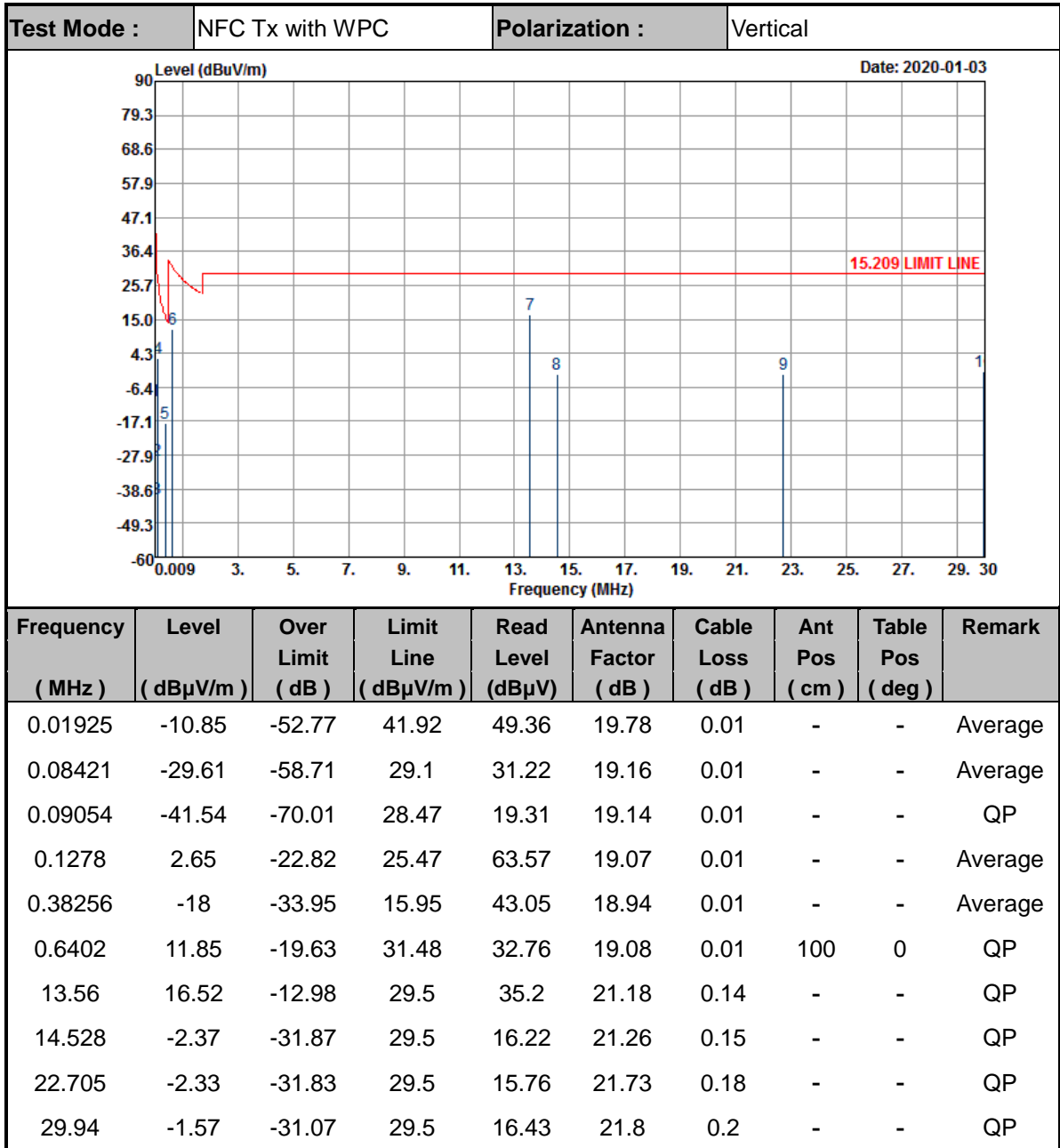

**Note:**

1. 13.56 MHz is fundamental signal which can be ignored.
2. The amplitude of spurious emissions which are attenuated by more than 20dB below the permissible value has no need to be reported.
3. Distance extrapolation factor = 40 log (specific distance / test distance) (dB);
4. Limit line = specific limits (dBμV) + distance extrapolation factor.



C3. Results of Radiated Spurious Emissions (30MHz~1GHz)

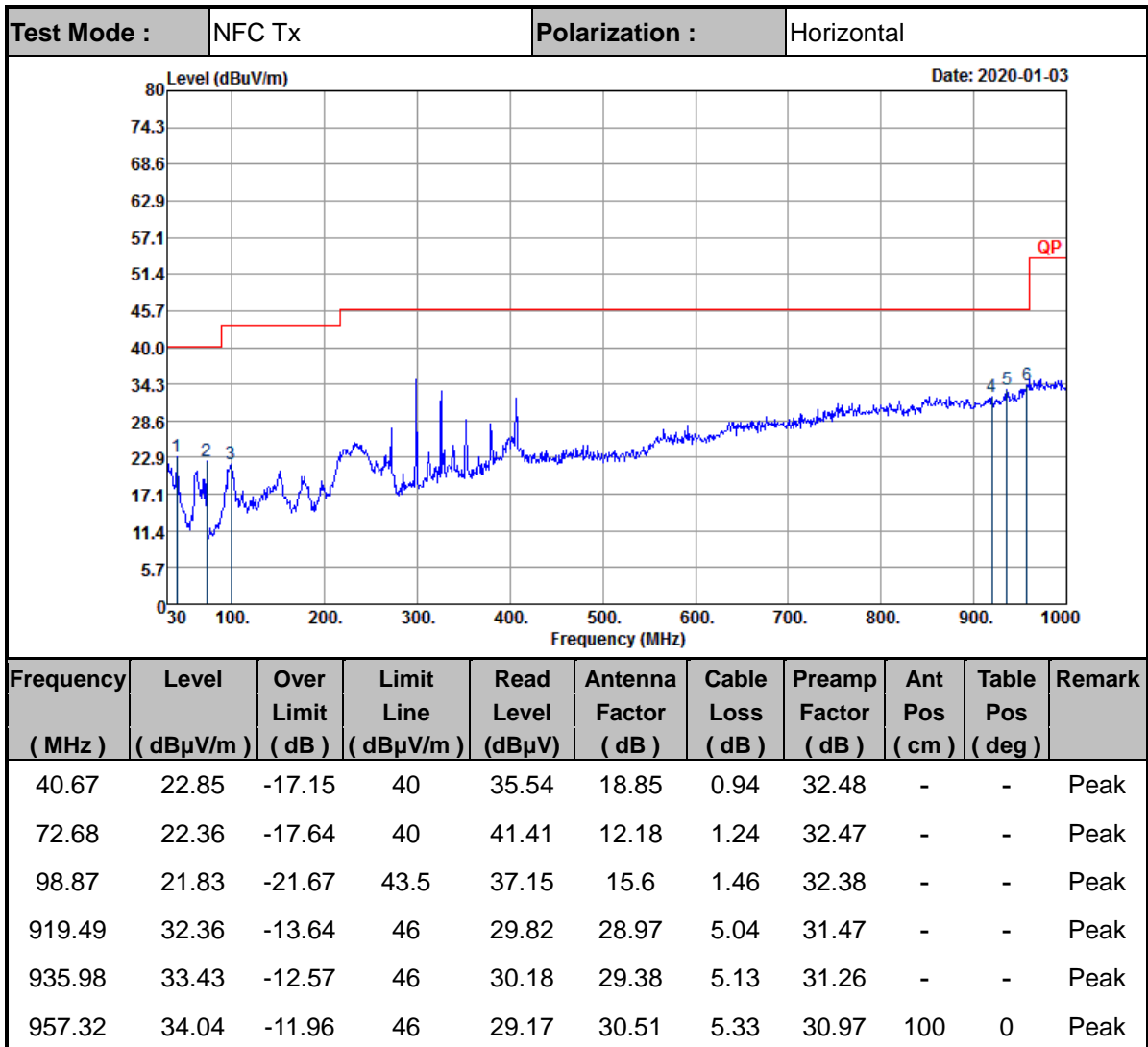

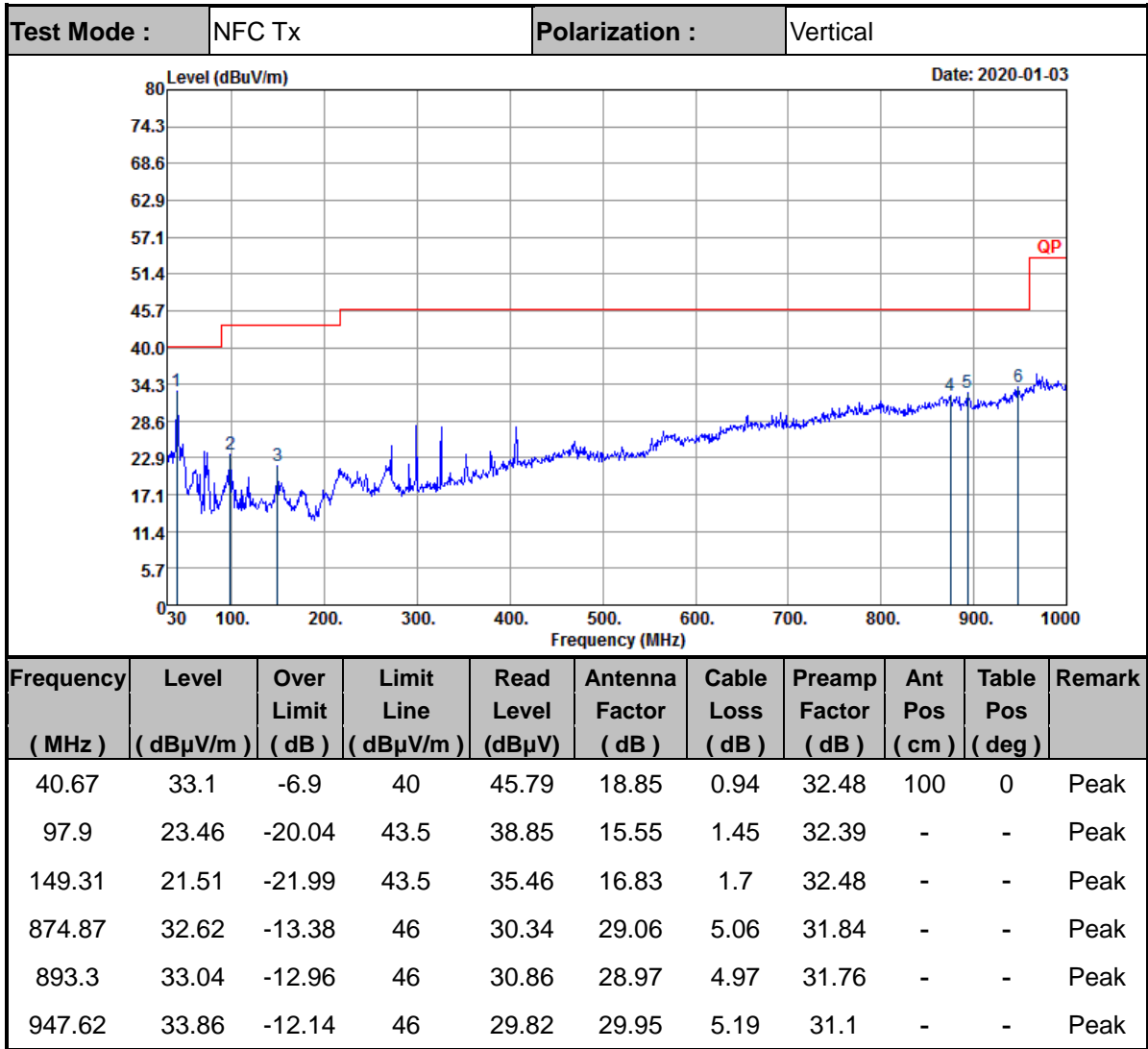

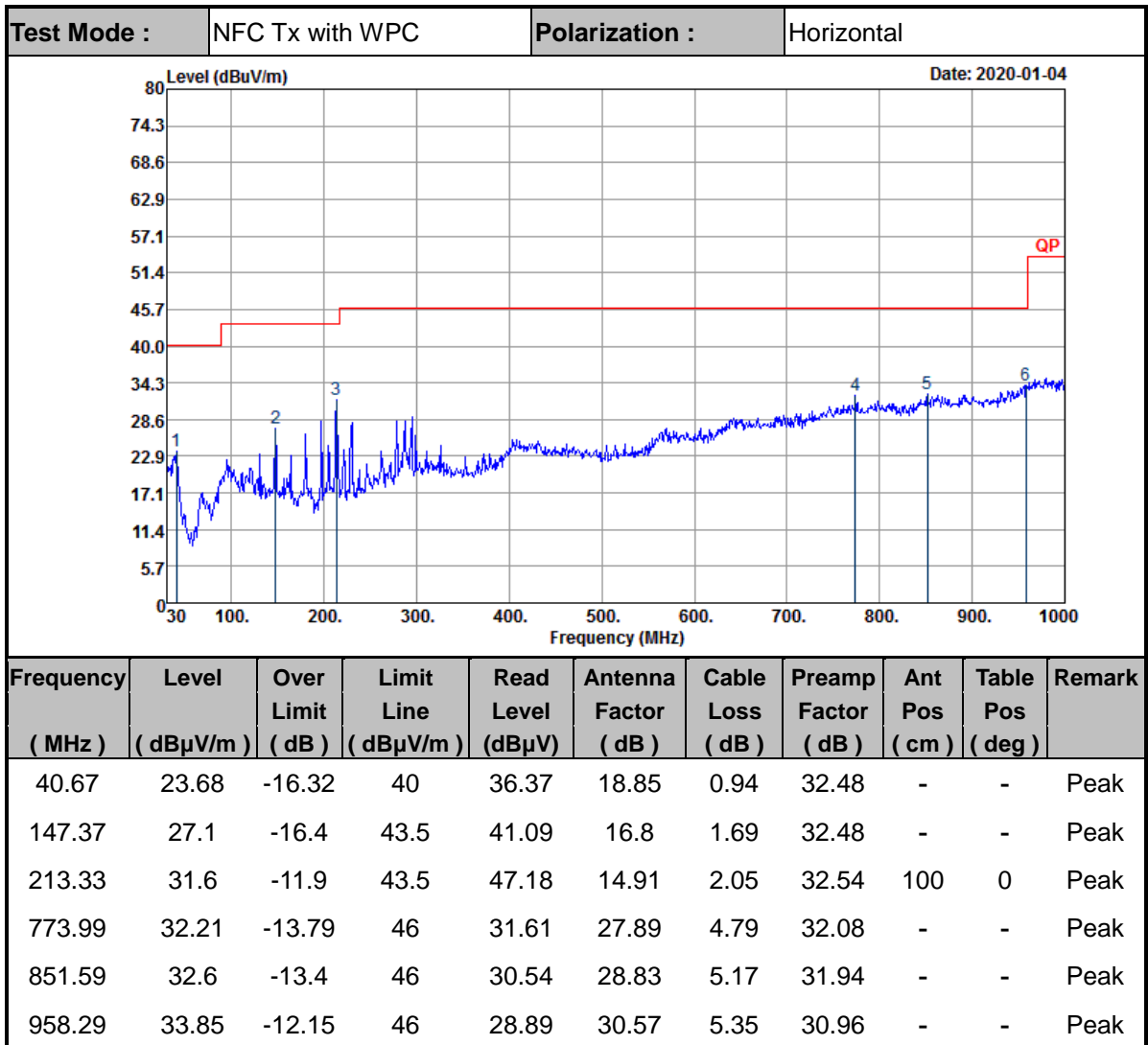

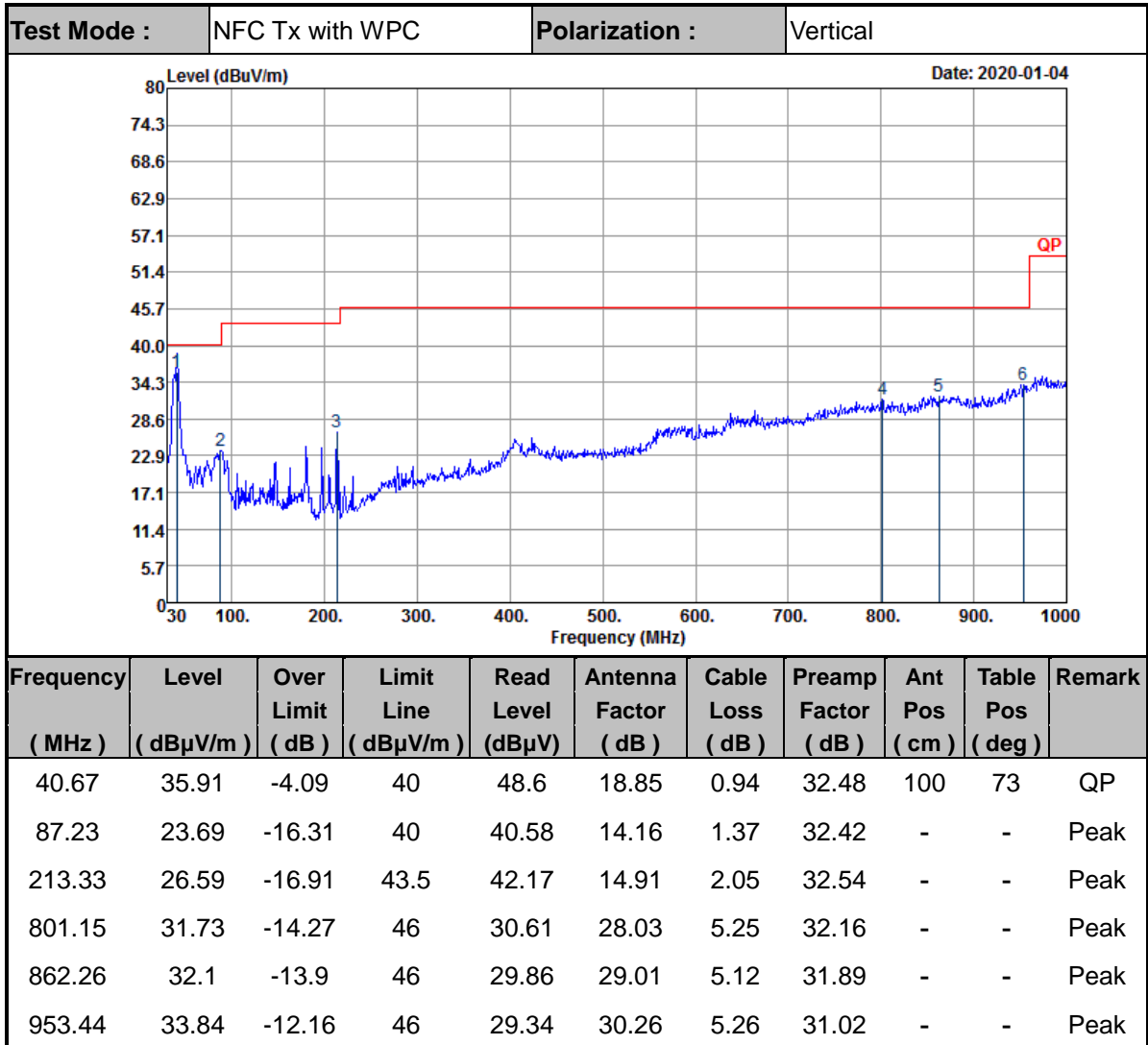

**Note:**

1. The amplitude of spurious emissions which are attenuated by more than 20dB below the permissible value has no need to be reported.
2. Emission level (dBμV/m) = 20 log Emission level (μV/m).
3. Corrected Reading: Antenna Factor + Cable Loss + Read Level - Preamp Factor= Level.