

#01_GSM850_GPRS (3 Tx slots)_Right Cheek_Ch128

Communication System: GSM850; Frequency: 824.2 MHz; Duty Cycle: 1:2.77

Medium: HSL_850_200131 Medium parameters used : $f = 824.2$ MHz; $\sigma = 0.89$ S/m; $\epsilon_r = 42.606$; $\rho = 1000$ kg/m³

Ambient Temperature : 23.6 °C ; Liquid Temperature : 22.6 °C

DASY5 Configuration:

- Probe: ES3DV3 - SN3169; ConvF(6.42, 6.42, 6.42) @ 824.2 MHz; Calibrated: 2019/5/24
- Sensor-Surface: 3mm (Mechanical Surface Detection)
- Electronics: DAE4 Sn376; Calibrated: 2019/12/6
- Phantom: SAM_Left; Type: QD000P40CD; Serial: 1719
- Measurement SW: DASY52, Version 52.10 (2); SEMCAD X Version 14.6.12 (7450)

Area Scan (71x101x1): Interpolated grid: dx=1.500 mm, dy=1.500 mm

Maximum value of SAR (interpolated) = 0.189 W/kg

Zoom Scan (5x5x7)/Cube 0: Measurement grid: dx=8mm, dy=8mm, dz=5mm

Reference Value = 14.18 V/m; Power Drift = 0.14 dB

Peak SAR (extrapolated) = 0.215 W/kg

SAR(1 g) = 0.173 W/kg; SAR(10 g) = 0.133 W/kg

Maximum value of SAR (measured) = 0.189 W/kg

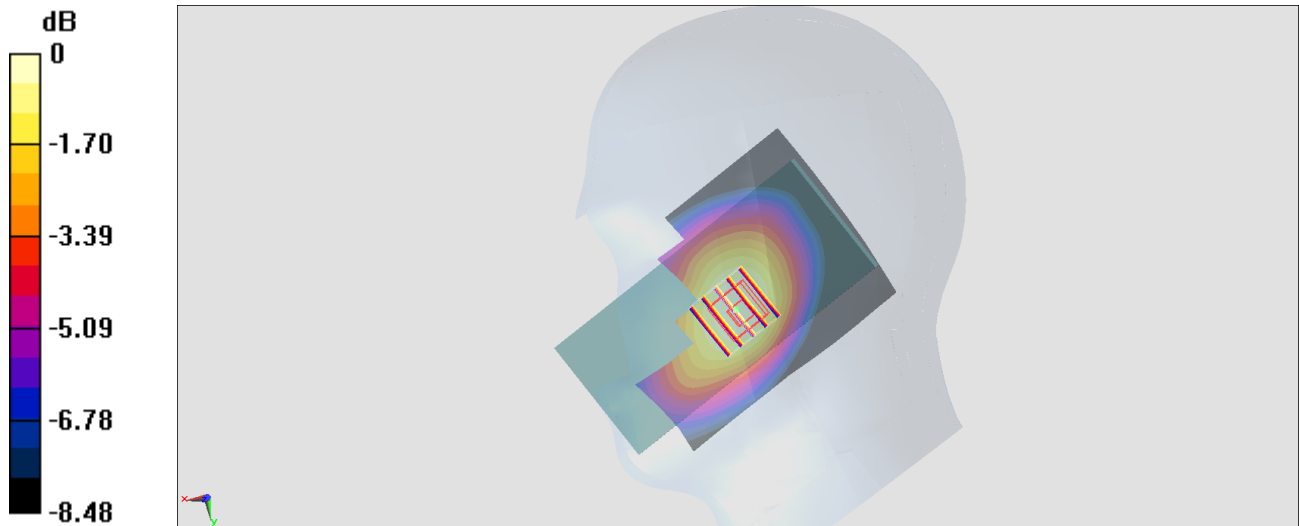

0 dB = 0.189 W/kg = -7.24 dBW/kg

#02_GSM1900_GPRS (2 Tx slots)_Left Cheek_Ch661

Communication System: PCS; Frequency: 1880 MHz; Duty Cycle: 1:4.15

Medium: HSL_1900_200131 Medium parameters used: $f = 1880$ MHz; $\sigma = 1.394$ S/m; $\epsilon_r = 40.799$; $\rho = 1000$ kg/m³

Ambient Temperature : 23.4 °C ; Liquid Temperature : 22.4 °C

DASY5 Configuration:

- Probe: ES3DV3 - SN3169; ConvF(5.14, 5.14, 5.14) @ 1880 MHz; Calibrated: 2019/5/24
- Sensor-Surface: 3mm (Mechanical Surface Detection)
- Electronics: DAE4 Sn376; Calibrated: 2019/12/6
- Phantom: SAM_Right; Type: SAM; Serial: TP:1446
- Measurement SW: DASY52, Version 52.10 (2); SEMCAD X Version 14.6.12 (7450)

Area Scan (71x101x1): Interpolated grid: dx=1.500 mm, dy=1.500 mm

Maximum value of SAR (interpolated) = 0.108 W/kg

Zoom Scan (5x5x7)/Cube 0: Measurement grid: dx=8mm, dy=8mm, dz=5mm

Reference Value = 7.974 V/m; Power Drift = 0.01 dB

Peak SAR (extrapolated) = 0.142 W/kg

SAR(1 g) = 0.090 W/kg; SAR(10 g) = 0.054 W/kg

Maximum value of SAR (measured) = 0.109 W/kg

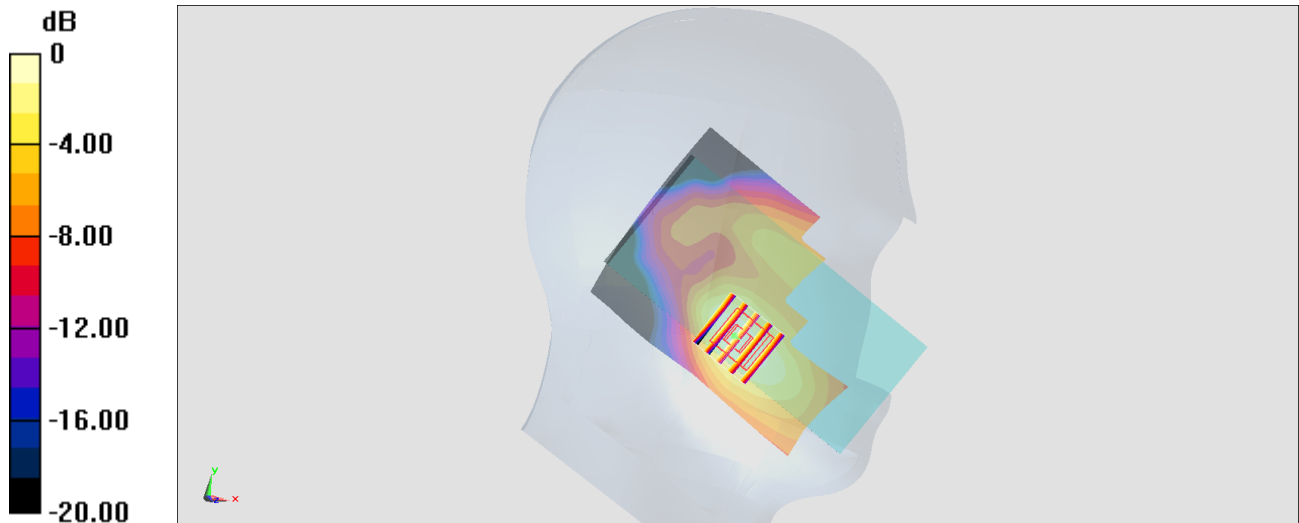

0 dB = 0.109 W/kg = -9.63 dBW/kg

#03_WCDMA II_RMC 12.2Kbps_Left Cheek_Ch9400

Communication System: WCDMA ; Frequency: 1880 MHz;Duty Cycle: 1:1
Medium: HSL_1900_200105 Medium parameters used: $f = 1880$ MHz; $\sigma = 1.435$ S/m; $\epsilon_r = 41.17$; $\rho = 1000$ kg/m³
Ambient Temperature : 23.5 °C ; Liquid Temperature : 22.5 °C

DASY5 Configuration

- Probe: ES3DV3 - SN3169;ConvF(5.14, 5.14, 5.14) @ 1880 MHz;Calibrated: 2019/5/24
- Sensor-Surface: 3mm (Mechanical Surface Detection)
- Electronics: DAE3 Sn577; Calibrated: 2019/9/17
- Phantom: Twin-SAM V5.0 (30deg probe tilt); Type: QD 000 P40 CD; Serial: 1885
- Measurement SW: DASY52, Version 52.10 (2); SEMCAD X Version 14.6.12 (7450)

Area Scan (71x121x1): Interpolated grid: dx=1.500 mm, dy=1.500 mm
Maximum value of SAR (interpolated) = 0.115 W/kg

Zoom Scan (5x5x7)/Cube 0: Measurement grid: dx=8mm, dy=8mm, dz=5mm
Reference Value = 5.175 V/m; Power Drift = 0.08 dB
Peak SAR (extrapolated) = 0.153 W/kg
SAR(1 g) = 0.100 W/kg; SAR(10 g) = 0.060 W/kg
Maximum value of SAR (measured) = 0.116 W/kg



0 dB = 0.116 W/kg = -9.36 dBW/kg

#04_WCDMA V_RMC 12.2Kbps_Right Cheek_Ch4182

Communication System: WCDMA ; Frequency: 836.4 MHz;Duty Cycle: 1:1
Medium: HSL_850_200105 Medium parameters used : $f = 836.4$ MHz; $\sigma = 0.896$ S/m; $\epsilon_r = 42.057$;
 $\rho = 1000$ kg/m³
Ambient Temperature : 23.5 °C ; Liquid Temperature : 22.5 °C

DASY5 Configuration

- Probe: ES3DV3 - SN3169;ConvF(6.42, 6.42, 6.42) @ 836.4 MHz;Calibrated: 2019/5/24
- Sensor-Surface: 3mm (Mechanical Surface Detection)
- Electronics: DAE3 Sn577; Calibrated: 2019/9/17
- Phantom: Twin-SAM V5.0 (30deg probe tilt); Type: QD 000 P40 CD; Serial: 1885
- Measurement SW: DASY52, Version 52.10 (2); SEMCAD X Version 14.6.12 (7450)

Area Scan (71x121x1): Interpolated grid: dx=1.500 mm, dy=1.500 mm
Maximum value of SAR (interpolated) = 0.111 W/kg

Zoom Scan (5x5x7)/Cube 0: Measurement grid: dx=8mm, dy=8mm, dz=5mm
Reference Value = 11.21 V/m; Power Drift = 0.09 dB
Peak SAR (extrapolated) = 0.134 W/kg
SAR(1 g) = 0.102 W/kg; SAR(10 g) = 0.074 W/kg
Maximum value of SAR (measured) = 0.113 W/kg

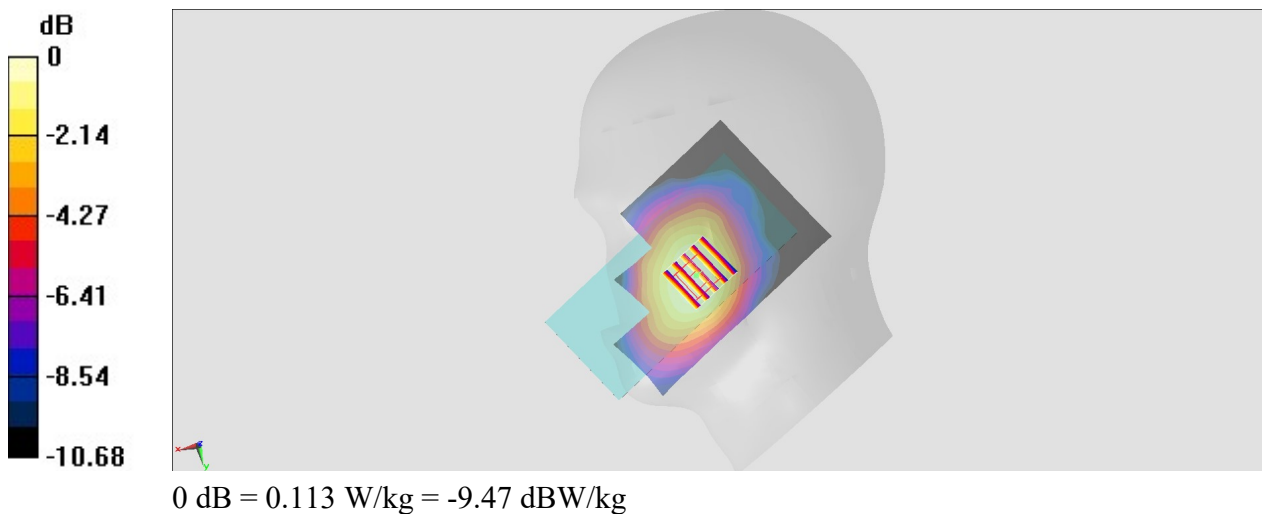

#05_CDMA BC0_1xRTT RC3 SO55 _Right Cheek_Ch384

Communication System: CDMA ; Frequency: 836.52 MHz;Duty Cycle: 1:1
Medium: HSL_850_200105 Medium parameters used: $f = 837$ MHz; $\sigma = 0.907$ S/m; $\epsilon_r = 42.031$; $\rho = 1000$ kg/m³
Ambient Temperature : 23.5 °C ; Liquid Temperature : 22.5 °C

DASY5 Configuration

- Probe: ES3DV3 - SN3169;ConvF(6.42, 6.42, 6.42) @ 836.52 MHz;Calibrated: 2019/5/24
- Sensor-Surface: 3mm (Mechanical Surface Detection)
- Electronics: DAE3 Sn577; Calibrated: 2019/9/17
- Phantom: Twin-SAM V5.0 (30deg probe tilt); Type: QD 000 P40 CD; Serial: 1885
- Measurement SW: DASY52, Version 52.10 (2); SEMCAD X Version 14.6.12 (7450)

Area Scan (71x121x1): Interpolated grid: dx=1.500 mm, dy=1.500 mm
Maximum value of SAR (interpolated) = 0.282 W/kg

Zoom Scan (5x5x7)/Cube 0: Measurement grid: dx=8mm, dy=8mm, dz=5mm
Reference Value = 17.71 V/m; Power Drift = -0.15 dB
Peak SAR (extrapolated) = 0.338 W/kg
SAR(1 g) = 0.251 W/kg; SAR(10 g) = 0.182 W/kg
Maximum value of SAR (measured) = 0.276 W/kg

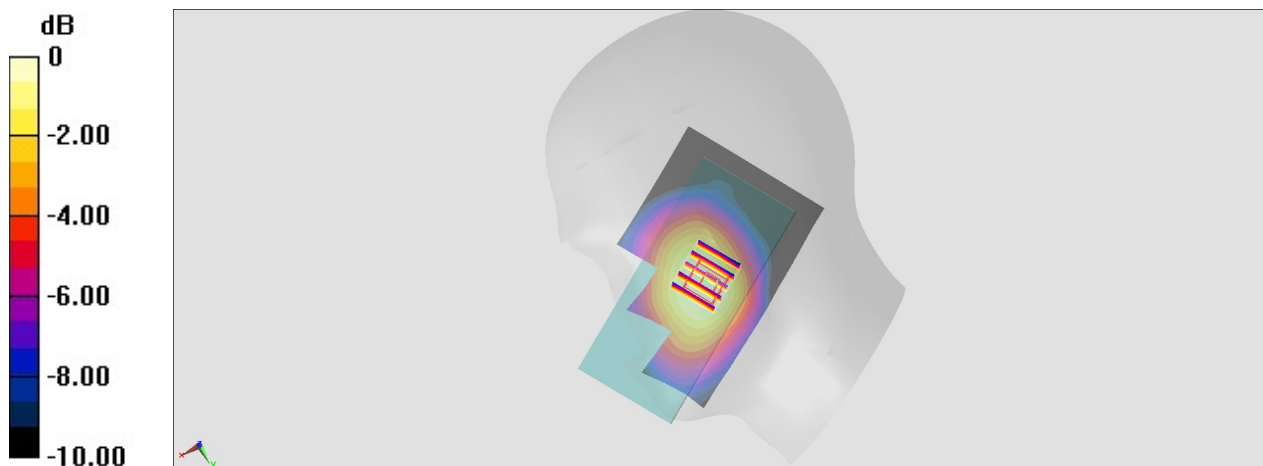

0 dB = 0.276 W/kg = -5.59 dBW/kg

#06_CDMA BC1_1xRTT RC3 SO55 _Left Cheek_Ch600

Communication System: CDMA ; Frequency: 1880 MHz;Duty Cycle: 1:1
Medium: HSL_1900_200105 Medium parameters used: $f = 1880$ MHz; $\sigma = 1.435$ S/m; $\epsilon_r = 41.17$; $\rho = 1000$ kg/m³
Ambient Temperature : 23.5 °C ; Liquid Temperature : 22.5 °C

DASY5 Configuration

- Probe: ES3DV3 - SN3169;ConvF(5.14, 5.14, 5.14) @ 1880 MHz;Calibrated: 2019/5/24
- Sensor-Surface: 3mm (Mechanical Surface Detection)
- Electronics: DAE3 Sn577; Calibrated: 2019/9/17
- Phantom: Twin-SAM V5.0 (30deg probe tilt); Type: QD 000 P40 CD; Serial: 1885
- Measurement SW: DASY52, Version 52.10 (2); SEMCAD X Version 14.6.12 (7450)

Area Scan (71x121x1): Interpolated grid: dx=1.500 mm, dy=1.500 mm
Maximum value of SAR (interpolated) = 0.173 W/kg

Zoom Scan (5x5x7)/Cube 0: Measurement grid: dx=8mm, dy=8mm, dz=5mm
Reference Value = 10.07 V/m; Power Drift = -0.11 dB
Peak SAR (extrapolated) = 0.224 W/kg
SAR(1 g) = 0.147 W/kg; SAR(10 g) = 0.089 W/kg
Maximum value of SAR (measured) = 0.174 W/kg

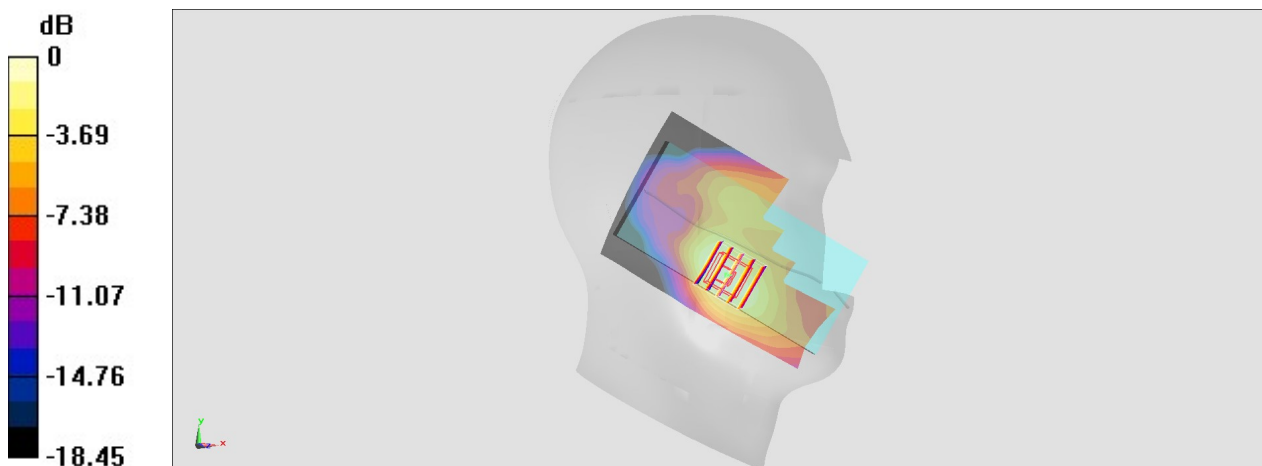

0 dB = 0.174 W/kg = -7.59 dBW/kg

#07_LTE Band 2_20M_QPSK_1_0_Left Cheek_Ch18900

Communication System: LTE ; Frequency: 1880 MHz;Duty Cycle: 1:1
Medium: HSL_1900_200105 Medium parameters used: $f = 1880$ MHz; $\sigma = 1.435$ S/m; $\epsilon_r = 41.17$; $\rho = 1000$ kg/m³
Ambient Temperature : 23.5 °C ; Liquid Temperature : 22.5 °C

DASY5 Configuration

- Probe: ES3DV3 - SN3169;ConvF(5.14, 5.14, 5.14) @ 1880 MHz;Calibrated: 2019/5/24
- Sensor-Surface: 3mm (Mechanical Surface Detection)
- Electronics: DAE3 Sn577; Calibrated: 2019/9/17
- Phantom: Twin-SAM V5.0 (30deg probe tilt); Type: QD 000 P40 CD; Serial: 1885
- Measurement SW: DASY52, Version 52.10 (2); SEMCAD X Version 14.6.12 (7450)

Area Scan (71x121x1): Interpolated grid: dx=1.500 mm, dy=1.500 mm
Maximum value of SAR (interpolated) = 0.135 W/kg

Zoom Scan (5x5x7)/Cube 0: Measurement grid: dx=8mm, dy=8mm, dz=5mm
Reference Value = 8.996 V/m; Power Drift = -0.05 dB
Peak SAR (extrapolated) = 0.180 W/kg
SAR(1 g) = 0.116 W/kg; SAR(10 g) = 0.070 W/kg
Maximum value of SAR (measured) = 0.135 W/kg

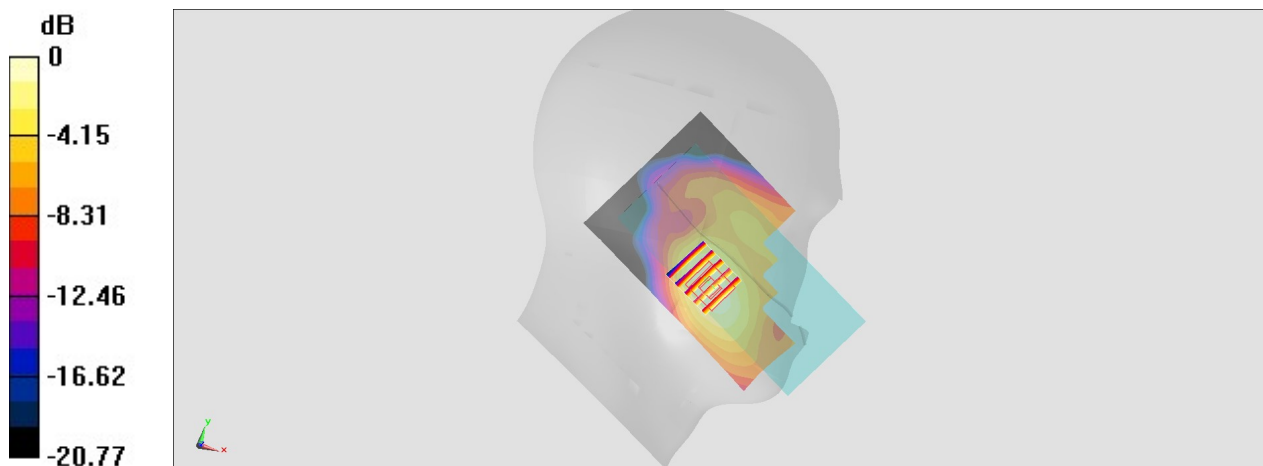

0 dB = 0.135 W/kg = -8.70 dBW/kg

#08_LTE Band 5_10M_QPSK_1_0_Right Cheek_Ch20525

Communication System: LTE; Frequency: 836.5 MHz; Duty Cycle: 1:1
Medium: HSL_850_200105 Medium parameters used : $f = 836.5$ MHz; $\sigma = 0.898$ S/m; $\epsilon_r = 42.053$;
 $\rho = 1000$ kg/m³
Ambient Temperature : 23.5 °C ; Liquid Temperature : 22.5 °C

DASY5 Configuration

- Probe: ES3DV3 - SN3169; ConvF(6.42, 6.42, 6.42) @ 836.5 MHz; Calibrated: 2019/5/24
- Sensor-Surface: 3mm (Mechanical Surface Detection)
- Electronics: DAE3 Sn577; Calibrated: 2019/9/17
- Phantom: Twin-SAM V5.0 (30deg probe tilt); Type: QD 000 P40 CD; Serial: 1885
- Measurement SW: DASY52, Version 52.10 (2); SEMCAD X Version 14.6.12 (7450)

Area Scan (71x121x1): Interpolated grid: dx=1.500 mm, dy=1.500 mm
Maximum value of SAR (interpolated) = 0.212 W/kg

Zoom Scan (5x5x7)/Cube 0: Measurement grid: dx=8mm, dy=8mm, dz=5mm
Reference Value = 15.33 V/m; Power Drift = 0.04 dB
Peak SAR (extrapolated) = 0.254 W/kg
SAR(1 g) = 0.191 W/kg; SAR(10 g) = 0.139 W/kg
Maximum value of SAR (measured) = 0.212 W/kg

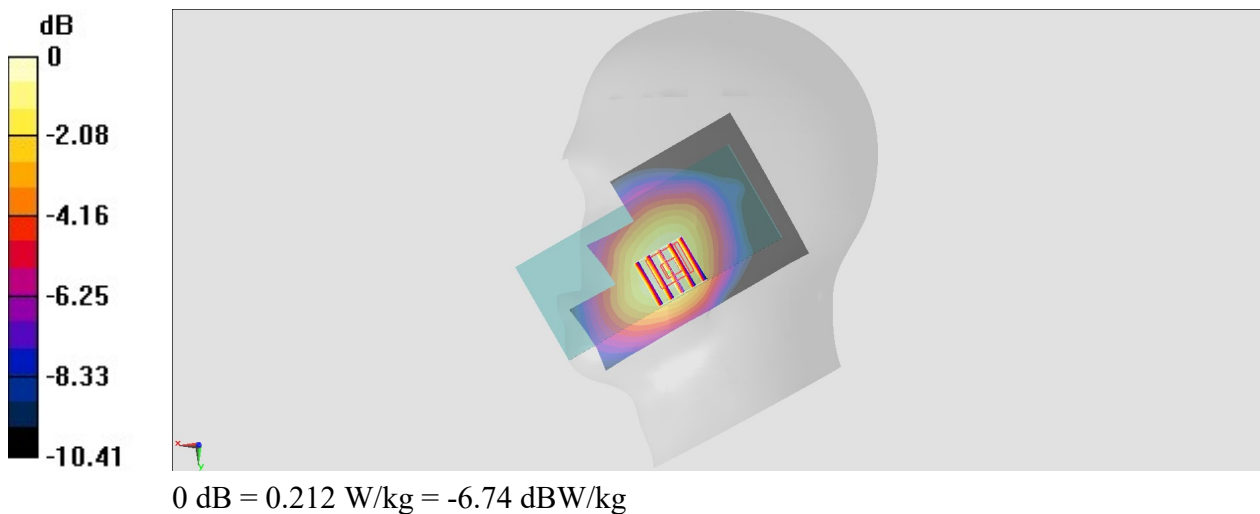

#09_LTE Band 7_20M_QPSK_1_0_Left Tilted_Ch21100

Communication System: LTE ; Frequency: 2535 MHz;Duty Cycle: 1:1
Medium: HSL_2600_200106 Medium parameters used : $f = 2535$ MHz; $\sigma = 1.928$ S/m; $\epsilon_r = 38.804$;
 $\rho = 1000$ kg/m³
Ambient Temperature : 23.4 °C ; Liquid Temperature : 22.4 °C

DASY5 Configuration

- Probe: ES3DV3 - SN3169;ConvF(4.38, 4.38, 4.38) @ 2535 MHz;Calibrated: 2019/5/24
- Sensor-Surface: 3mm (Mechanical Surface Detection)
- Electronics: DAE3 Sn577; Calibrated: 2019/9/17
- Phantom: Twin-SAM V5.0 (30deg probe tilt); Type: QD 000 P40 CD; Serial: 1885
- Measurement SW: DASY52, Version 52.10 (2); SEMCAD X Version 14.6.12 (7450)

Area Scan (91x151x1): Interpolated grid: dx=1.200 mm, dy=1.200 mm
Maximum value of SAR (interpolated) = 0.0582 W/kg

Zoom Scan (7x7x7)/Cube 0: Measurement grid: dx=5mm, dy=5mm, dz=5mm
Reference Value = 2.746 V/m; Power Drift = 0.11 dB
Peak SAR (extrapolated) = 0.0760 W/kg
SAR(1 g) = 0.039 W/kg; SAR(10 g) = 0.018 W/kg
Maximum value of SAR (measured) = 0.0529 W/kg

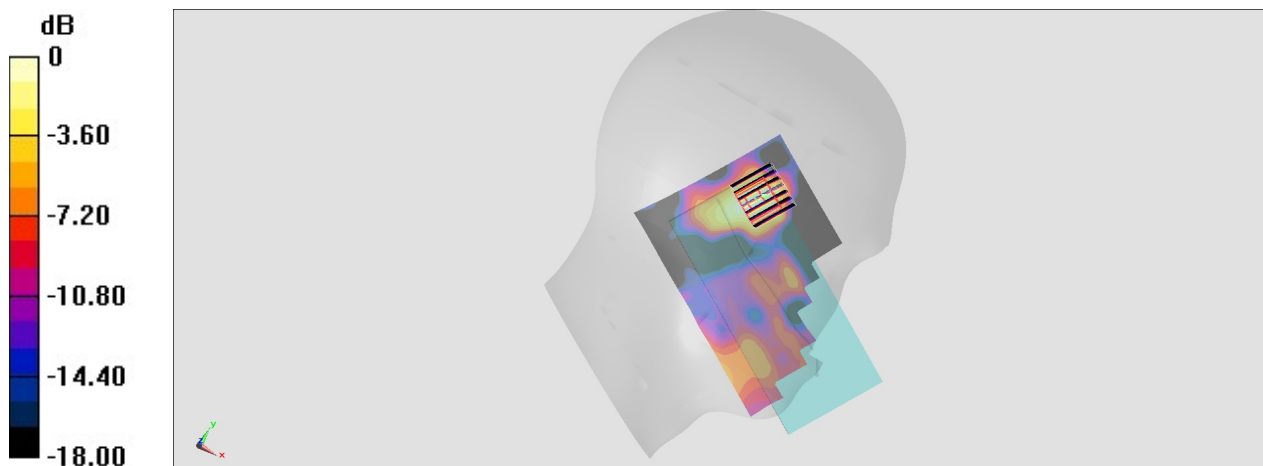

0 dB = 0.0529 W/kg = -12.77 dBW/kg

#10_LTE Band 12_10M_QPSK_1_0_Right Cheek_Ch23095

Communication System: LTE; Frequency: 707.5 MHz; Duty Cycle: 1:1
Medium: HSL_750_200105 Medium parameters used : $f = 707.5$ MHz; $\sigma = 0.869$ S/m; $\epsilon_r = 43.213$;
 $\rho = 1000$ kg/m³
Ambient Temperature : 23.5 °C ; Liquid Temperature : 22.5 °C

DASY5 Configuration

- Probe: ES3DV3 - SN3169; ConvF(6.68, 6.68, 6.68) @ 707.5 MHz; Calibrated: 2019/5/24
- Sensor-Surface: 3mm (Mechanical Surface Detection)
- Electronics: DAE3 Sn577; Calibrated: 2019/9/17
- Phantom: Twin-SAM V5.0 (30deg probe tilt); Type: QD 000 P40 CD; Serial: 1885
- Measurement SW: DASY52, Version 52.10 (2); SEMCAD X Version 14.6.12 (7450)

Area Scan (71x121x1): Interpolated grid: dx=1.500 mm, dy=1.500 mm
Maximum value of SAR (interpolated) = 0.133 W/kg

Zoom Scan (5x5x7)/Cube 0: Measurement grid: dx=8mm, dy=8mm, dz=5mm
Reference Value = 12.93 V/m; Power Drift = -0.17 dB
Peak SAR (extrapolated) = 0.155 W/kg
SAR(1 g) = 0.122 W/kg; SAR(10 g) = 0.091 W/kg
Maximum value of SAR (measured) = 0.134 W/kg

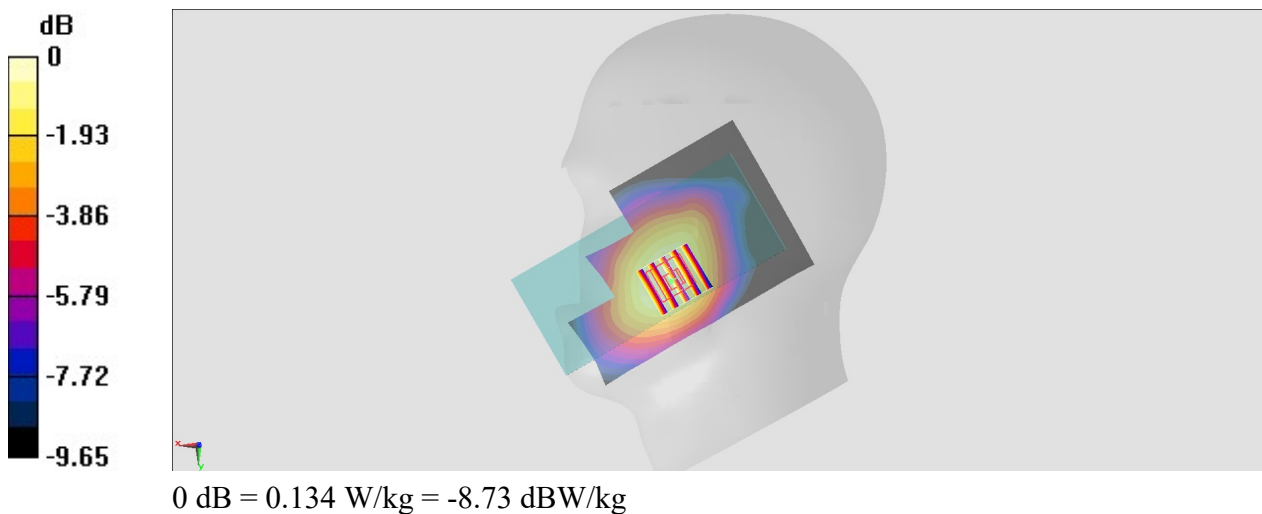

#11_LTE Band 13_10M_QPSK_1_0_Right Cheek_Ch23230

Communication System: LTE; Frequency: 782 MHz; Duty Cycle: 1:1
Medium: HSL_750_200105 Medium parameters used: $f = 782 \text{ MHz}$; $\sigma = 0.916 \text{ S/m}$; $\epsilon_r = 42.209$; $\rho = 1000 \text{ kg/m}^3$
Ambient Temperature : $23.5 \text{ }^\circ\text{C}$; Liquid Temperature : $22.5 \text{ }^\circ\text{C}$

DASY5 Configuration

- Probe: ES3DV3 - SN3169; ConvF(6.68, 6.68, 6.68) @ 782 MHz; Calibrated: 2019/5/24
- Sensor-Surface: 3mm (Mechanical Surface Detection)
- Electronics: DAE3 Sn577; Calibrated: 2019/9/17
- Phantom: Twin-SAM V5.0 (30deg probe tilt); Type: QD 000 P40 CD; Serial: 1885
- Measurement SW: DASY52, Version 52.10 (2); SEMCAD X Version 14.6.12 (7450)

Area Scan (71x121x1): Interpolated grid: $dx=1.500 \text{ mm}$, $dy=1.500 \text{ mm}$
Maximum value of SAR (interpolated) = 0.200 W/kg

Zoom Scan (5x5x7)/Cube 0: Measurement grid: $dx=8\text{mm}$, $dy=8\text{mm}$, $dz=5\text{mm}$
Reference Value = 14.76 V/m ; Power Drift = 0.02 dB
Peak SAR (extrapolated) = 0.232 W/kg
SAR(1 g) = 0.179 W/kg ; SAR(10 g) = 0.132 W/kg
Maximum value of SAR (measured) = 0.197 W/kg

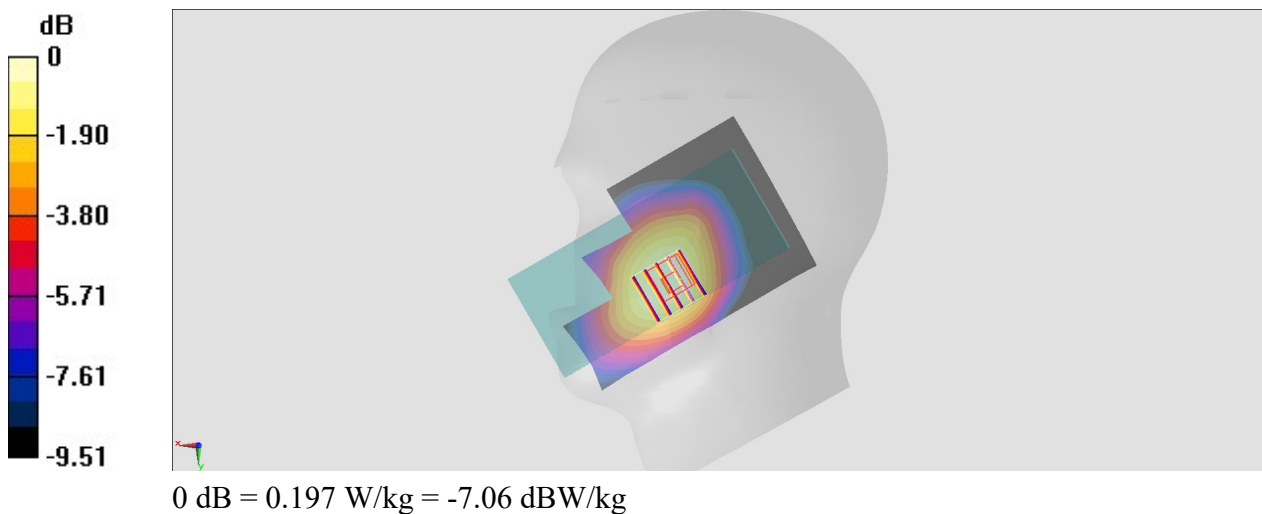

#12_LTE Band 66_20M_QPSK_1_0_Left Cheek_Ch132322

Communication System: LTE ; Frequency: 1745 MHz;Duty Cycle: 1:1

Medium: HSL_1750_200106 Medium parameters used : $f = 1745$ MHz; $\sigma = 1.392$ S/m; $\epsilon_r = 41.094$;

$\rho = 1000$ kg/m³

Ambient Temperature : 23.4 °C ; Liquid Temperature : 22.4 °C

DASY5 Configuration

- Probe: ES3DV3 - SN3169;ConvF(5.34, 5.34, 5.34) @ 1745 MHz;Calibrated: 2019/5/24

- Sensor-Surface: 3mm (Mechanical Surface Detection)

- Electronics: DAE3 Sn577; Calibrated: 2019/9/17

- Phantom: Twin-SAM V5.0 (30deg probe tilt); Type: QD 000 P40 CD; Serial: 1885

- Measurement SW: DASY52, Version 52.10 (2); SEMCAD X Version 14.6.12 (7450)

Area Scan (71x121x1): Interpolated grid: dx=1.500 mm, dy=1.500 mm

Maximum value of SAR (interpolated) = 0.120 W/kg

Zoom Scan (5x5x7)/Cube 0: Measurement grid: dx=8mm, dy=8mm, dz=5mm

Reference Value = 7.673 V/m; Power Drift = -0.04 dB

Peak SAR (extrapolated) = 0.155 W/kg

SAR(1 g) = 0.104 W/kg; SAR(10 g) = 0.064 W/kg

Maximum value of SAR (measured) = 0.123 W/kg

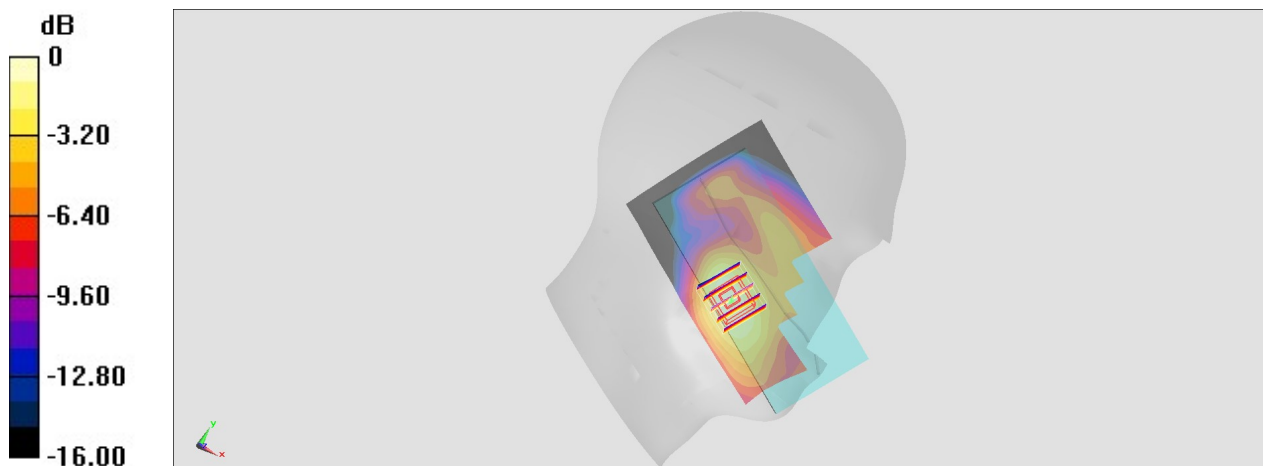

0 dB = 0.123 W/kg = -9.10 dBW/kg

#13_LTE Band 48_20M_QPSK_1_0_Right Tilted_Ch55830

Communication System: LTE; Frequency: 3609 MHz; Duty Cycle: 1:1.59

Medium: HSL_3500_200204 Medium parameters used : $f = 3609$ MHz; $\sigma = 3.038$ S/m; $\epsilon_r = 38.977$; $\rho = 1000$ kg/m³

Ambient Temperature : 23.5 °C ; Liquid Temperature : 22.5 °C

DASY5 Configuration:

- Probe: EX3DV4 - SN3925; ConvF(6.91, 6.91, 6.91) @ 3609 MHz; Calibrated: 2019/9/20
- Sensor-Surface: 1.4mm (Mechanical Surface Detection)
- Electronics: DAE4 Sn778; Calibrated: 2019/5/21
- Phantom: SAM_Left; Type: QD000P40CD; Serial: TP:1815
- Measurement SW: DASY52, Version 52.10 (2); SEMCAD X Version 14.6.12 (7470)

Area Scan (81x71x1): Interpolated grid: dx=1.200 mm, dy=1.200 mm

Maximum value of SAR (interpolated) = 1.40 W/kg

Zoom Scan (7x7x7)/Cube 0: Measurement grid: dx=5mm, dy=5mm, dz=1.4mm

Reference Value = 10.83 V/m; Power Drift = 0.11 dB

Peak SAR (extrapolated) = 1.96 W/kg

SAR(1 g) = 0.672 W/kg; SAR(10 g) = 0.196 W/kg

Maximum value of SAR (measured) = 1.20 W/kg

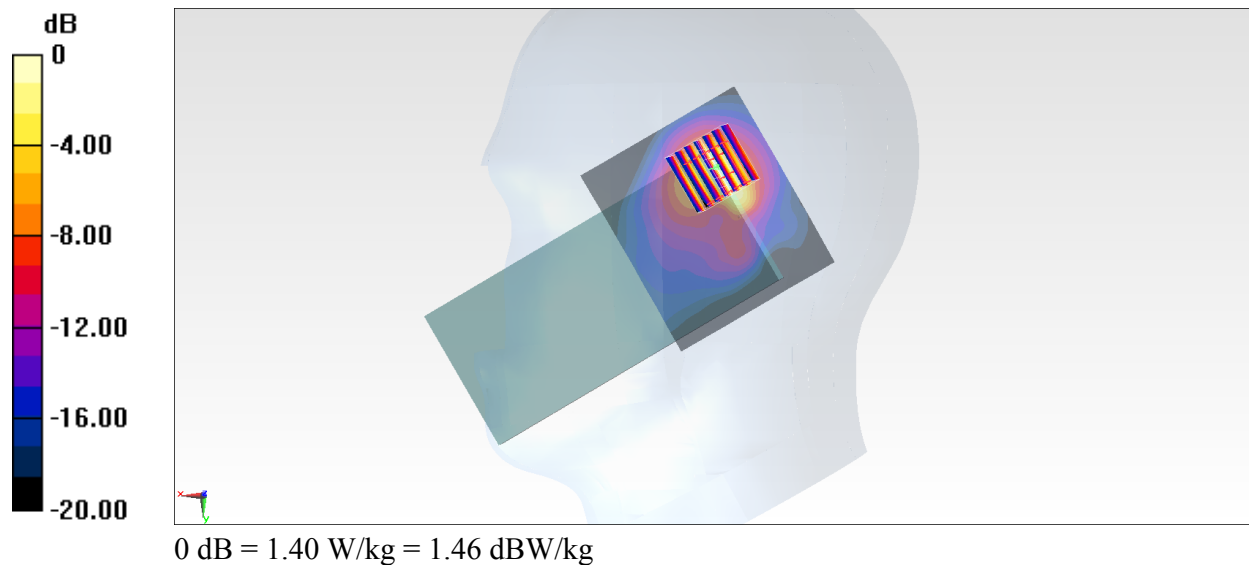

#14_WLAN2.4GHz_802.11b 1Mbps_Right Cheek_Ch6;Ant 4+6

Communication System: 802.11b; Frequency: 2437 MHz; Duty Cycle: 1:1.015
Medium: HSL_2450_200204 Medium parameters used : $f = 2437$ MHz; $\sigma = 1.813$ S/m; $\epsilon_r = 38.826$;
 $\rho = 1000$ kg/m³
Ambient Temperature : 23.5 °C ; Liquid Temperature : 22.5 °C

DASY5 Configuration

- Probe: ES3DV3 - SN3169; ConvF(4.54, 4.54, 4.54) @ 2437 MHz; Calibrated: 2019/5/24
- Sensor-Surface: 3mm (Mechanical Surface Detection)
- Electronics: DAE3 Sn495; Calibrated: 2019/5/21
- Phantom: Twin-SAM V5.0 (30deg probe tilt); Type: QD 000 P40 CD; Serial: 1885
- Measurement SW: DASY52, Version 52.10 (2); SEMCAD X Version 14.6.12 (7450)

Area Scan (91x101x1): Interpolated grid: dx=1.200 mm, dy=1.200 mm
Maximum value of SAR (interpolated) = 0.0935 W/kg

Zoom Scan (7x7x7)/Cube 0: Measurement grid: dx=5mm, dy=5mm, dz=5mm
Reference Value = 5.830 V/m; Power Drift = -0.08 dB
Peak SAR (extrapolated) = 0.356 W/kg
SAR(1 g) = 0.068 W/kg; SAR(10 g) = 0.034 W/kg
Maximum value of SAR (measured) = 0.0858 W/kg

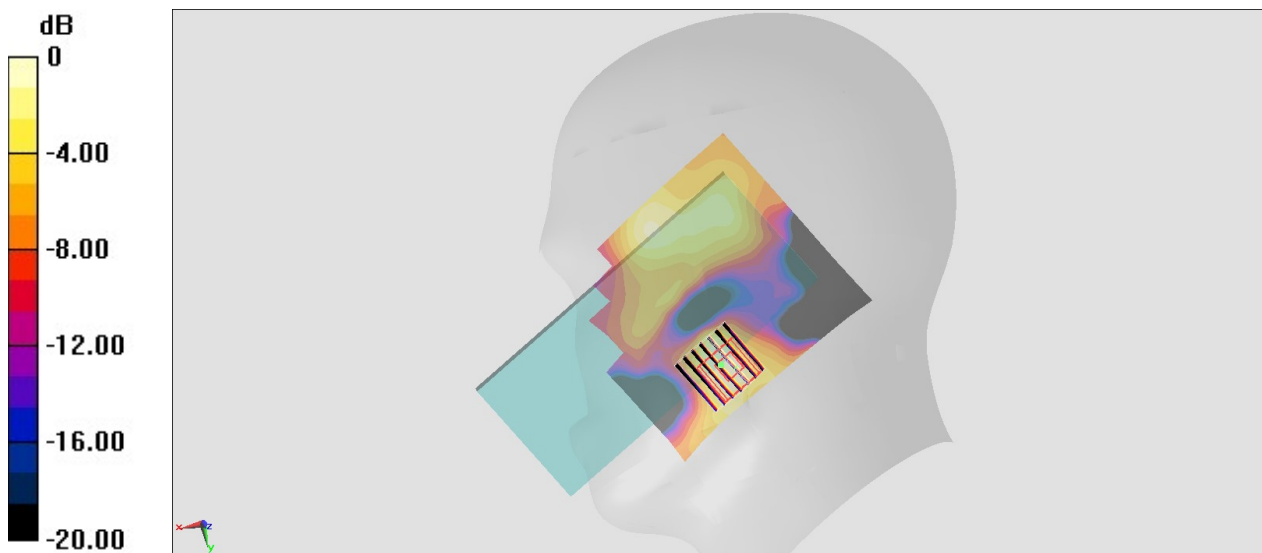

0 dB = 0.0858 W/kg = -10.67 dBW/kg

#15_WLAN5GHz_802.11a 6Mbps_Right Tilted_Ch56;Ant 3+6

Communication System: 802.11a; Frequency: 5280 MHz; Duty Cycle: 1:1.008

Medium: HSL_5G_200203 Medium parameters used: $f = 5280$ MHz; $\sigma = 4.764$ S/m; $\epsilon_r = 36.067$; $\rho = 1000$ kg/m³

Ambient Temperature : 23.7 °C; Liquid Temperature : 22.7 °C

DASY5 Configuration:

- Probe: EX3DV4 - SN3931; ConvF(5.08, 5.08, 5.08); Calibrated: 2019/9/26;
- Sensor-Surface: 1.4mm (Mechanical Surface Detection)
- Electronics: DAE4 Sn1311; Calibrated: 2019/8/27
- Phantom: SAM LEFT; Type: QD000P40CD; Serial: TP:1718
- Measurement SW: DASY52, Version 52.10 (2); SEMCAD X Version 14.6.12 (7470)

Area Scan (91x101x1): Interpolated grid: dx=1.000 mm, dy=1.000 mm

Maximum value of SAR (interpolated) = 0.433 W/kg

Zoom Scan (7x7x7)/Cube 0: Measurement grid: dx=4mm, dy=4mm, dz=1.4mm

Reference Value = 6.797 V/m; Power Drift = 0.16 dB

Peak SAR (extrapolated) = 1.01 W/kg

SAR(1 g) = 0.206 W/kg; SAR(10 g) = 0.059 W/kg

Maximum value of SAR (measured) = 0.579 W/kg

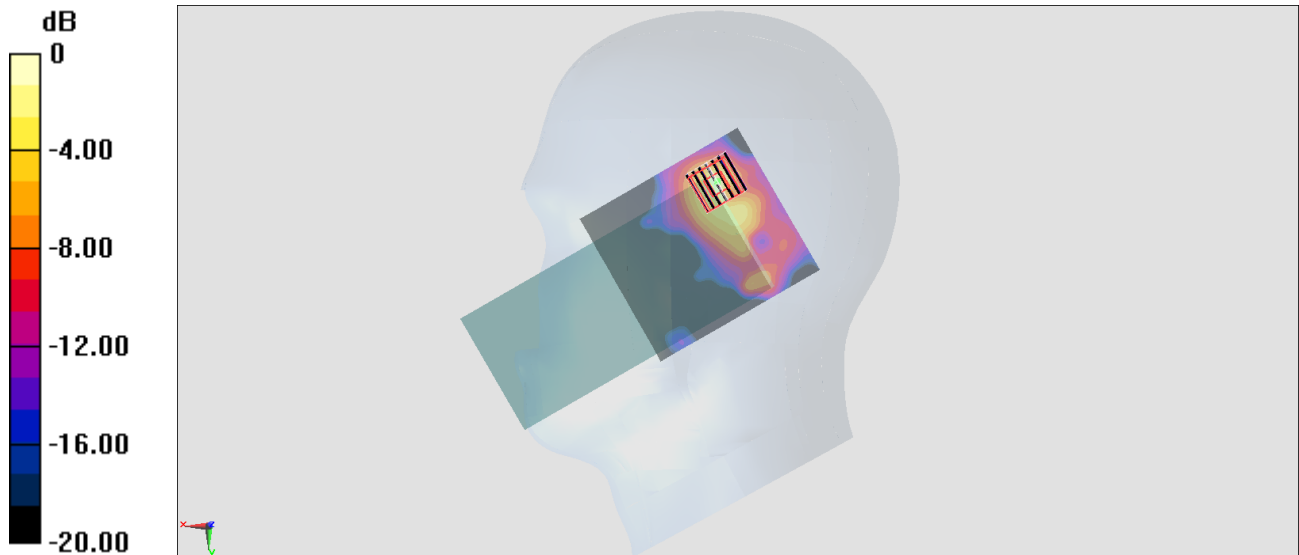

0 dB = 0.579 W/kg = -2.37 dBW/kg

#16_WLAN5GHz_802.11ac-VHT80 MCS0_Right Tilted_Ch122

Communication System: 802.11ac; Frequency: 5610 MHz; Duty Cycle: 1:1

Medium: HSL_5G_200203 Medium parameters used: $f = 5610$ MHz; $\sigma = 5.09$ S/m; $\epsilon_r = 35.56$; $\rho = 1000$ kg/m³

Ambient Temperature : 23.7 °C ; Liquid Temperature : 22.7 °C

DASY5 Configuration:

- Probe: EX3DV4 - SN3931; ConvF(4.49, 4.49, 4.49) @ 5610 MHz; Calibrated: 2019/9/26
- Sensor-Surface: 1.4mm (Mechanical Surface Detection)
- Electronics: DAE4 Sn1311; Calibrated: 2019/8/27
- Phantom: SAM LEFT; Type: QD000P40CD; Serial: TP:1718
- Measurement SW: DASY52, Version 52.10 (2); SEMCAD X Version 14.6.12 (7470)

Area Scan (91x101x1): Interpolated grid: dx=1.000 mm, dy=1.000 mm

Maximum value of SAR (interpolated) = 0.807 W/kg

Zoom Scan (7x7x7)/Cube 0: Measurement grid: dx=4mm, dy=4mm, dz=1.4mm

Reference Value = 5.790 V/m; Power Drift = 0.08 dB

Peak SAR (extrapolated) = 1.89 W/kg

SAR(1 g) = 0.344 W/kg; SAR(10 g) = 0.090 W/kg

Maximum value of SAR (measured) = 1.04 W/kg

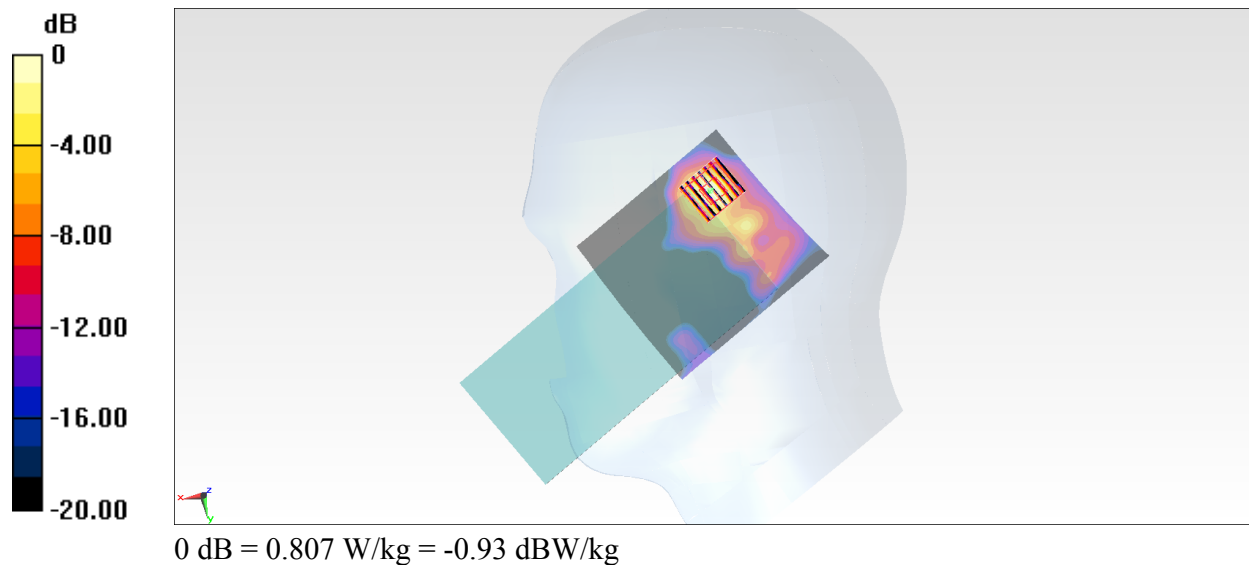

#17_WLAN5GHz_802.11ac-VHT80 MCS0_Right Tilted_Ch155;Ant 3+6

Communication System: 802.11ac; Frequency: 5775 MHz; Duty Cycle: 1:1

Medium: HSL_5G_200203 Medium parameters used: $f = 5775$ MHz; $\sigma = 5.109$ S/m; $\epsilon_r = 35.322$; $\rho = 1000$ kg/m³

Ambient Temperature : 23.7 °C ; Liquid Temperature : 22.7 °C

DASY5 Configuration:

- Probe: EX3DV4 - SN3931; ConvF(4.75, 4.75, 4.75) @ 5775 MHz; Calibrated: 2019/9/26
- Sensor-Surface: 1.4mm (Mechanical Surface Detection)
- Electronics: DAE4 Sn1311; Calibrated: 2019/8/27
- Phantom: SAM LEFT; Type: QD000P40CD; Serial: TP:1718
- Measurement SW: DASY52, Version 52.10 (2); SEMCAD X Version 14.6.12 (7470)

Area Scan (91x101x1): Interpolated grid: dx=1.000 mm, dy=1.000 mm

Maximum value of SAR (interpolated) = 0.911 W/kg

Zoom Scan (7x7x7)/Cube 0: Measurement grid: dx=4mm, dy=4mm, dz=1.4mm

Reference Value = 5.968 V/m; Power Drift = 0.10 dB

Peak SAR (extrapolated) = 2.12 W/kg

SAR(1 g) = 0.394 W/kg; SAR(10 g) = 0.101 W/kg

Maximum value of SAR (measured) = 1.15 W/kg

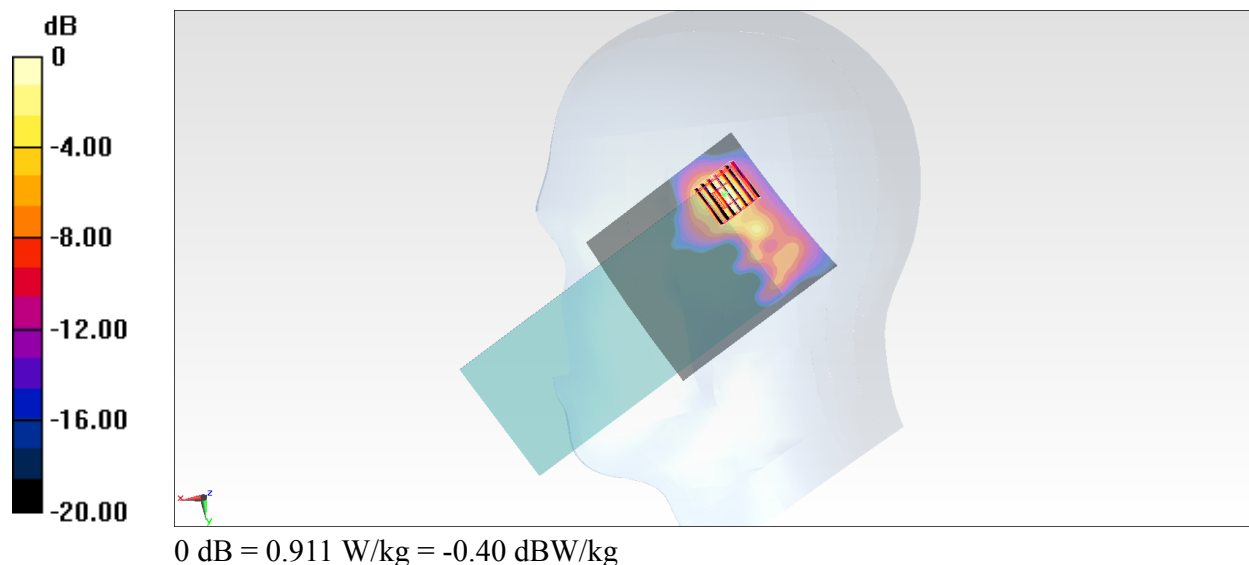

#18_Bluetooth_1M_Right Cheek_Ch39

Communication System: Bluetooth; Frequency: 2441 MHz; Duty Cycle: 1:1.301
Medium: HSL_2450_200204 Medium parameters used : $f = 2441$ MHz; $\sigma = 1.817$ S/m; $\epsilon_r = 38.812$;
 $\rho = 1000$ kg/m³
Ambient Temperature : 23.5 °C ; Liquid Temperature : 22.5 °C

DASY5 Configuration

- Probe: ES3DV3 - SN3169; ConvF(4.54, 4.54, 4.54) @ 2441 MHz; Calibrated: 2019/5/24
- Sensor-Surface: 3mm (Mechanical Surface Detection)
- Electronics: DAE3 Sn495; Calibrated: 2019/5/21
- Phantom: Twin-SAM V5.0 (30deg probe tilt); Type: QD 000 P40 CD; Serial: 1885
- Measurement SW: DASY52, Version 52.10 (2); SEMCAD X Version 14.6.12 (7450)

Area Scan (91x101x1): Interpolated grid: dx=1.200 mm, dy=1.200 mm
Reference Value = 0.5450 V/m; Power Drift = -0.01 dB
Fast SAR: SAR(1 g) = 0.001 W/kg; SAR(10 g) = 0.001 W/kg
Maximum value of SAR (interpolated) = 0 W/kg

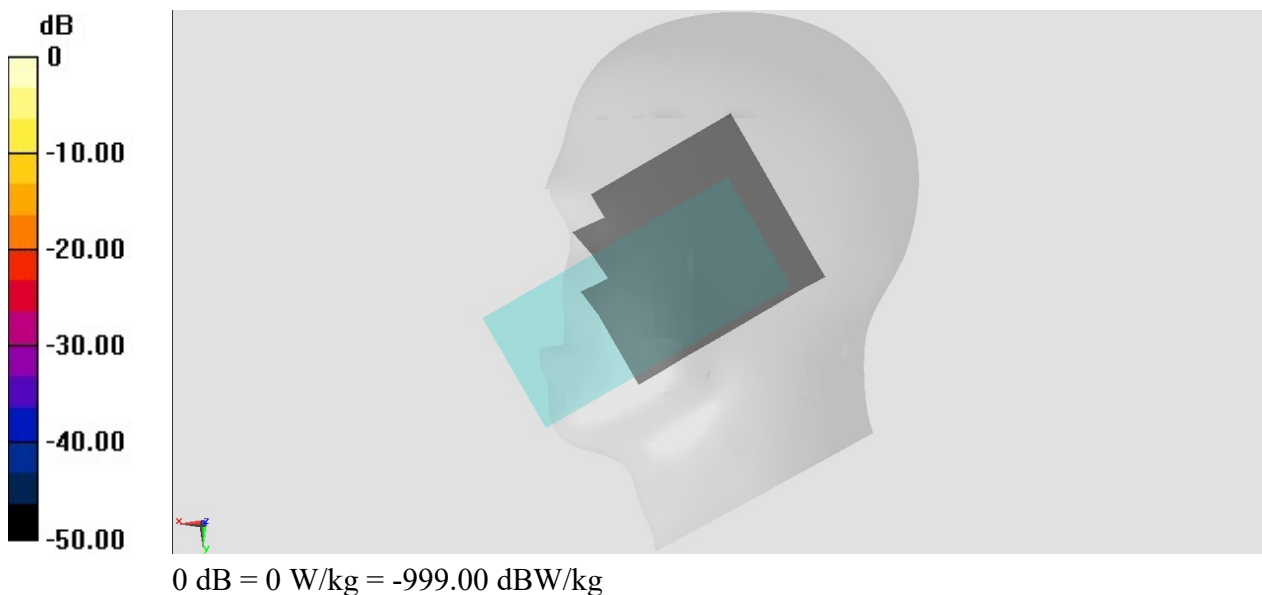

#19_GSM850_GPRS (3 Tx slots)_Bottom Side_Ch128

Communication System: GSM850; Frequency: 824.2 MHz; Duty Cycle: 1:2.77

Medium: HSL_850_200131 Medium parameters used : $f = 824.2$ MHz; $\sigma = 0.89$ S/m; $\epsilon_r = 42.606$; $\rho = 1000$ kg/m³

Ambient Temperature : 23.6 °C ; Liquid Temperature : 22.6 °C

DASY5 Configuration:

- Probe: ES3DV3 - SN3169; ConvF(6.42, 6.42, 6.42) @ 824.2 MHz; Calibrated: 2019/5/24
- Sensor-Surface: 3mm (Mechanical Surface Detection)
- Electronics: DAE4 Sn376; Calibrated: 2019/12/6
- Phantom: SAM_Left; Type: QD000P40CD; Serial: 1719
- Measurement SW: DASY52, Version 52.10 (2); SEMCAD X Version 14.6.12 (7450)

Area Scan (41x71x1): Interpolated grid: dx=1.500 mm, dy=1.500 mm

Maximum value of SAR (interpolated) = 0.881 W/kg

Zoom Scan (5x5x7)/Cube 0: Measurement grid: dx=8mm, dy=8mm, dz=5mm

Reference Value = 29.87 V/m; Power Drift = -0.07 dB

Peak SAR (extrapolated) = 1.43 W/kg

SAR(1 g) = 0.623 W/kg; SAR(10 g) = 0.298 W/kg

Maximum value of SAR (measured) = 0.862 W/kg

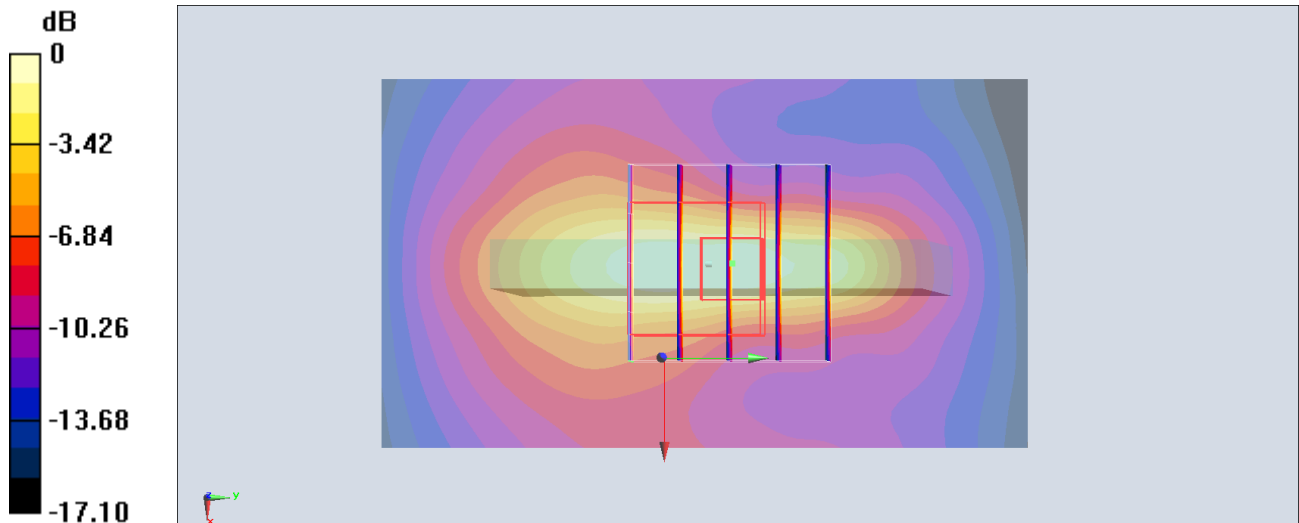

0 dB = 0.862 W/kg = -0.64 dBW/kg

#20_GSM1900_GPRS (4 Tx slots)_Bottom Side_5mm_Ch810

Communication System: PCS ; Frequency: 1909.8 MHz; Duty Cycle: 1:2.08

Medium: HSL_1900_200202 Medium parameters used: $f = 1910$ MHz; $\sigma = 1.418$ S/m; $\epsilon_r = 40.253$; $\rho = 1000$ kg/m³

Ambient Temperature : 23.4 °C ; Liquid Temperature : 22.4 °C

DASY5 Configuration:

- Probe: EX3DV4 - SN7306; ConvF(8.15, 8.15, 8.15); Calibrated: 2019/7/22;
- Sensor-Surface: 1.4mm (Mechanical Surface Detection)
- Electronics: DAE3 Sn577; Calibrated: 2019/9/17
- Phantom: SAM_Left; Type: QD000P40CD; Serial: TP:1801
- Measurement SW: DASY52, Version 52.8 (8); SEMCAD X Version 14.6.10 (7373)

Area Scan (61x81x1): Interpolated grid: dx=1.500 mm, dy=1.500 mm

Maximum value of SAR (interpolated) = 1.15 W/kg

Zoom Scan (5x5x7)/Cube 0: Measurement grid: dx=8mm, dy=8mm, dz=5mm

Reference Value = 7.333 V/m; Power Drift = -0.00 dB

Peak SAR (extrapolated) = 1.42 W/kg

SAR(1 g) = 0.691 W/kg; SAR(10 g) = 0.317 W/kg

Maximum value of SAR (measured) = 1.16 W/kg

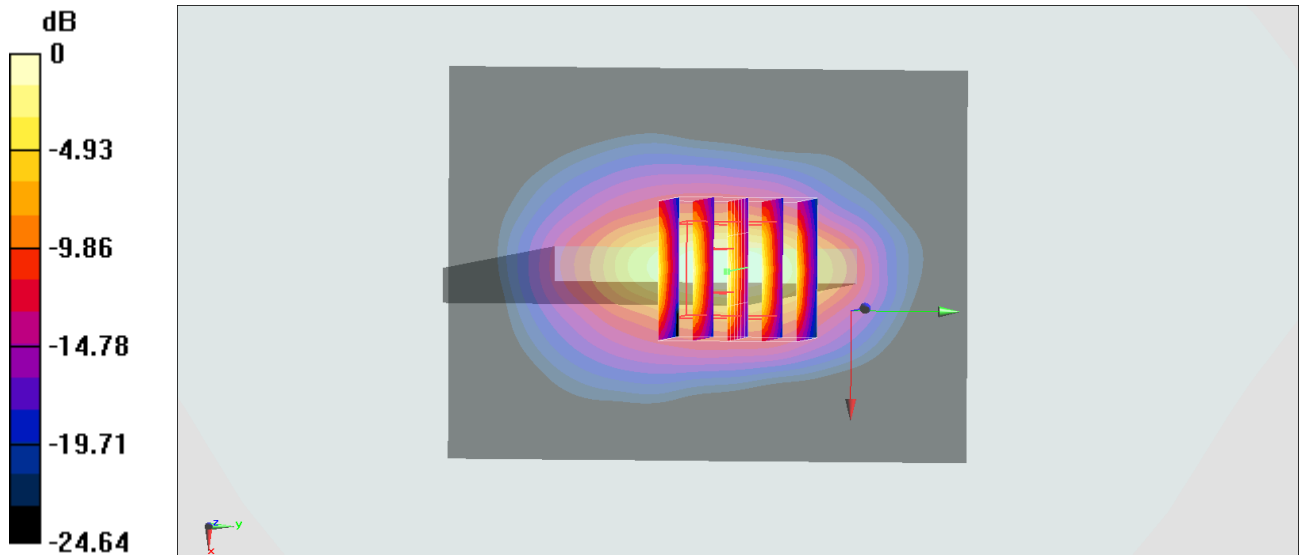

0 dB = 1.16 W/kg = 0.64 dBW/kg

#21_WCDMA II_RMC 12.2Kbps_Bottom Side_5mm_Ch9400

Communication System: WCDMA ; Frequency: 1880 MHz; Duty Cycle: 1:1

Medium: HSL_1900_200202 Medium parameters used: $f = 1880$ MHz; $\sigma = 1.387$ S/m; $\epsilon_r = 40.376$; $\rho = 1000$ kg/m³

Ambient Temperature : 23.4 °C ; Liquid Temperature : 22.4 °C

DASY5 Configuration:

- Probe: ES3DV3 - SN3169; ConvF(5.14, 5.14, 5.14) @ 1880 MHz; Calibrated: 2019/5/24
- Sensor-Surface: 3mm (Mechanical Surface Detection)
- Electronics: DAE4 Sn376; Calibrated: 2019/12/6
- Phantom: SAM_Right; Type: SAM; Serial: TP:1446
- Measurement SW: DASY52, Version 52.10 (2); SEMCAD X Version 14.6.12 (7450)

Area Scan (41x71x1): Interpolated grid: dx=1.500 mm, dy=1.500 mm

Maximum value of SAR (interpolated) = 1.64 W/kg

Zoom Scan (5x5x7)/Cube 0: Measurement grid: dx=8mm, dy=8mm, dz=5mm

Reference Value = 28.37 V/m; Power Drift = -0.11 dB

Peak SAR (extrapolated) = 2.38 W/kg

SAR(1 g) = 1.22 W/kg; SAR(10 g) = 0.567 W/kg

Maximum value of SAR (measured) = 1.60 W/kg

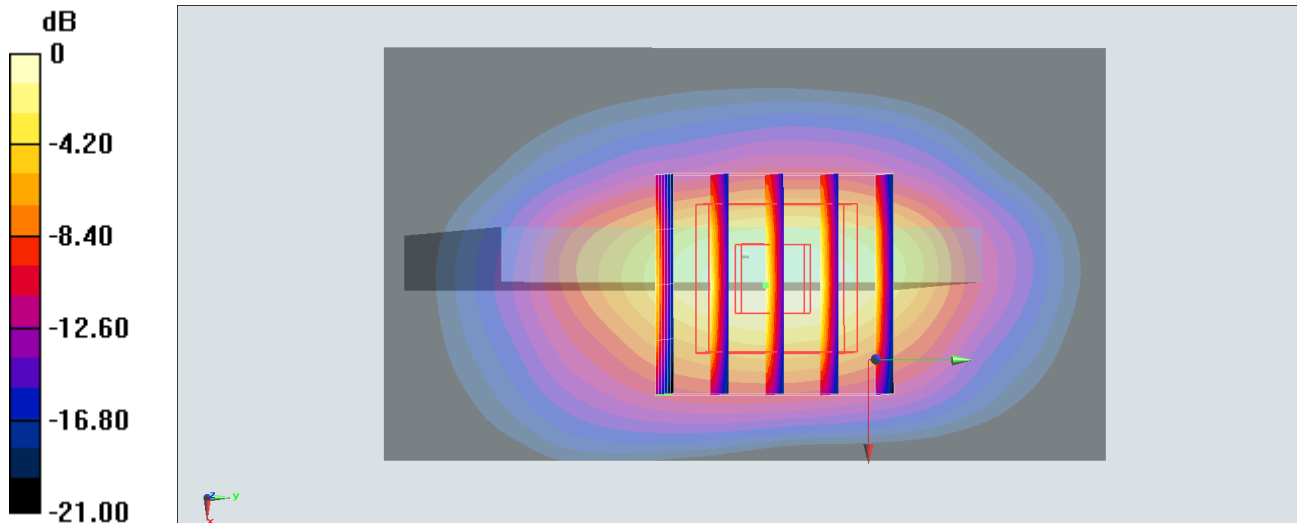

0 dB = 1.60 W/kg = 2.04 dBW/kg

#22_WCDMA V_RMC 12.2Kbps_Back_5mm_Ch4182

Communication System: WCDMA; Frequency: 836.4 MHz; Duty Cycle: 1:1
Medium: HSL_850_200107 Medium parameters used : $f = 836.4$ MHz; $\sigma = 0.887$ S/m; $\epsilon_r = 42.118$;
 $\rho = 1000$ kg/m³
Ambient Temperature : 23.4 °C; Liquid Temperature : 22.4 °C

DASY5 Configuration

- Probe: ES3DV3 - SN3169; ConvF(6.42, 6.42, 6.42) @ 836.4 MHz; Calibrated: 2019/5/24
- Sensor-Surface: 3mm (Mechanical Surface Detection)
- Electronics: DAE3 Sn577; Calibrated: 2019/9/17
- Phantom: Twin-SAM V5.0 (30deg probe tilt); Type: QD 000 P40 CD; Serial: 1885
- Measurement SW: DASY52, Version 52.10 (2); SEMCAD X Version 14.6.12 (7450)

Area Scan (71x61x1): Interpolated grid: dx=1.500 mm, dy=1.500 mm
Maximum value of SAR (interpolated) = 0.417 W/kg

Zoom Scan (5x5x7)/Cube 0: Measurement grid: dx=8mm, dy=8mm, dz=5mm
Reference Value = 20.90 V/m; Power Drift = -0.06 dB
Peak SAR (extrapolated) = 0.625 W/kg
SAR(1 g) = 0.341 W/kg; SAR(10 g) = 0.200 W/kg
Maximum value of SAR (measured) = 0.419 W/kg

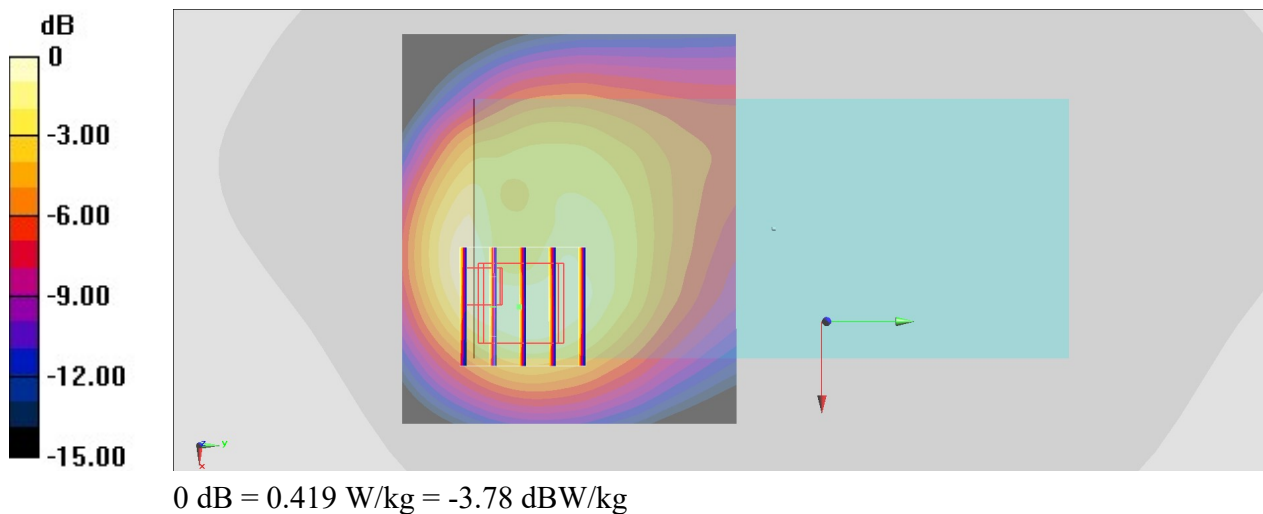

#23_CDMA BC0_RTAP 153.6Kbps_Back_5mm_Ch777

Communication System: CDMA; Frequency: 848.31 MHz; Duty Cycle: 1:1
Medium: HSL_850_200107 Medium parameters used : $f = 848.31 \text{ MHz}$; $\sigma = 0.898 \text{ S/m}$; $\epsilon_r = 41.961$; $\rho = 1000 \text{ kg/m}^3$
Ambient Temperature : $23.4 \text{ }^\circ\text{C}$; Liquid Temperature : $22.4 \text{ }^\circ\text{C}$

DASY5 Configuration

- Probe: ES3DV3 - SN3169; ConvF(6.42, 6.42, 6.42) @ 848.31 MHz; Calibrated: 2019/5/24
- Sensor-Surface: 3mm (Mechanical Surface Detection)
- Electronics: DAE3 Sn577; Calibrated: 2019/9/17
- Phantom: Twin-SAM V5.0 (30deg probe tilt); Type: QD 000 P40 CD; Serial: 1885
- Measurement SW: DASY52, Version 52.10 (2); SEMCAD X Version 14.6.12 (7450)

Area Scan (71x61x1): Interpolated grid: $dx=1.500 \text{ mm}$, $dy=1.500 \text{ mm}$
Maximum value of SAR (interpolated) = 0.635 W/kg

Zoom Scan (5x5x7)/Cube 0: Measurement grid: $dx=8\text{mm}$, $dy=8\text{mm}$, $dz=5\text{mm}$
Reference Value = 11.69 V/m ; Power Drift = 0.05 dB
Peak SAR (extrapolated) = 1.16 W/kg
SAR(1 g) = 0.614 W/kg ; SAR(10 g) = 0.353 W/kg
Maximum value of SAR (measured) = 0.776 W/kg

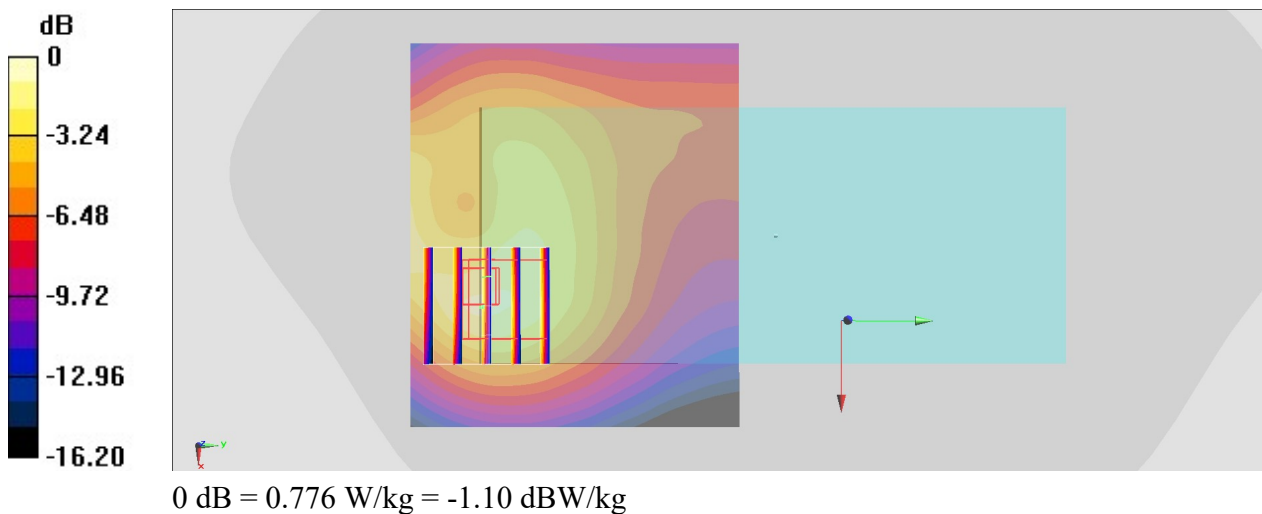

#24_CDMA BC1_RTAP 153.6Kbps_Bottom Side_5mm_Ch1175

Communication System: CDMA ; Frequency: 1908.75 MHz;Duty Cycle: 1:1

Medium: HSL_1900_200202 Medium parameters used: $f = 1909$ MHz; $\sigma = 1.416$ S/m; $\epsilon_r = 40.258$; $\rho = 1000$ kg/m³

Ambient Temperature : 23.4 °C ; Liquid Temperature : 22.4 °C

DASY5 Configuration:

- Probe: EX3DV4 - SN7306;ConvF(8.15, 8.15, 8.15); Calibrated: 2019/7/22;
- Sensor-Surface: 1.4mm (Mechanical Surface Detection)
- Electronics: DAE3 Sn577; Calibrated: 2019/9/17
- Phantom: SAM_Left; Type: QD000P40CD; Serial: TP:1801
- Measurement SW: DASY52, Version 52.8 (8);SEMCAD X Version 14.6.10 (7373)

Area Scan (61x81x1): Interpolated grid: dx=1.500 mm, dy=1.500 mm

Maximum value of SAR (interpolated) = 1.78 W/kg

Zoom Scan (5x5x7)/Cube 0: Measurement grid: dx=8mm, dy=8mm, dz=5mm

Reference Value = 8.029 V/m; Power Drift = 0.05 dB

Peak SAR (extrapolated) = 2.21 W/kg

SAR(1 g) = 1.08 W/kg; SAR(10 g) = 0.489 W/kg

Maximum value of SAR (measured) = 1.83 W/kg

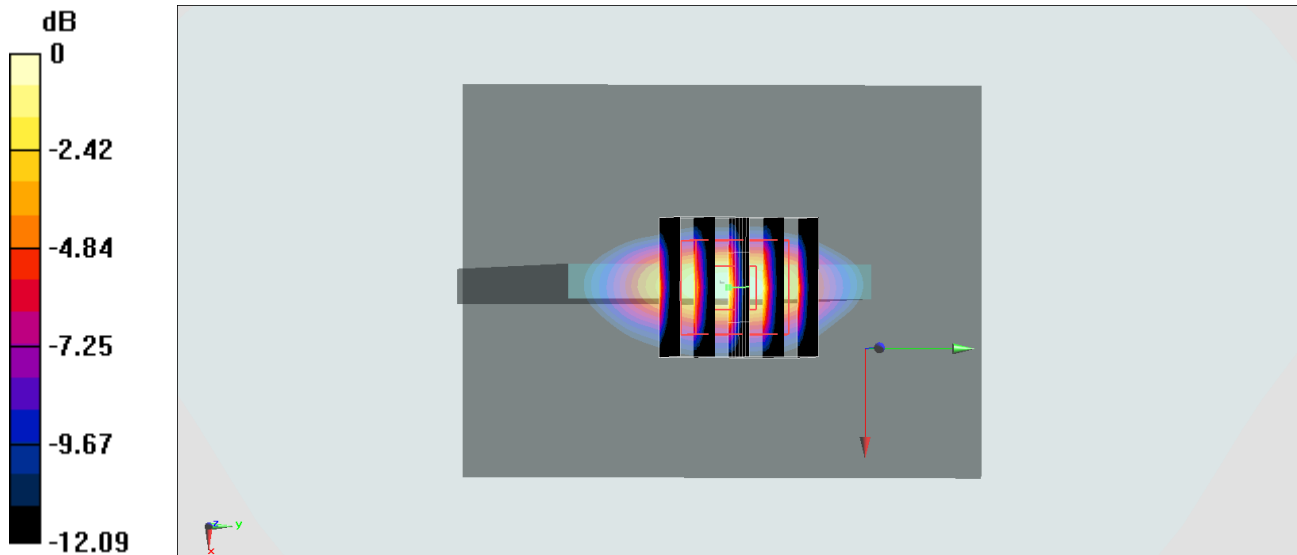

0 dB = 1.83 W/kg = 2.62 dBW/kg

#25_LTE Band 2_20M_QPSK_1_0_Bottom Side_5mm_Ch18700

Communication System: Frequency: 1860 MHz; Duty Cycle: 1:1

Medium: HSL_1900_200202 Medium parameters used: $f = 1860$ MHz; $\sigma = 1.369$ S/m; $\epsilon_r = 40.442$; $\rho = 1000$ kg/m³

Ambient Temperature : 23.4 °C; Liquid Temperature : 22.4 °C

DASY5 Configuration:

- Probe: EX3DV4 - SN7306; ConvF(8.15, 8.15, 8.15); Calibrated: 2019/7/22;
- Sensor-Surface: 1.4mm (Mechanical Surface Detection)
- Electronics: DAE3 Sn577; Calibrated: 2019/9/17
- Phantom: SAM_Left; Type: QD000P40CD; Serial: TP:1801
- Measurement SW: DASY52, Version 52.8 (8); SEMCAD X Version 14.6.10 (7373)

Area Scan (61x81x1): Interpolated grid: dx=1.500 mm, dy=1.500 mm

Maximum value of SAR (interpolated) = 1.65 W/kg

Zoom Scan (5x5x7)/Cube 0: Measurement grid: dx=8mm, dy=8mm, dz=5mm

Reference Value = 10.62 V/m; Power Drift = -0.09 dB

Peak SAR (extrapolated) = 2.02 W/kg

SAR(1 g) = 1.08 W/kg; SAR(10 g) = 0.505 W/kg

Maximum value of SAR (measured) = 1.65 W/kg

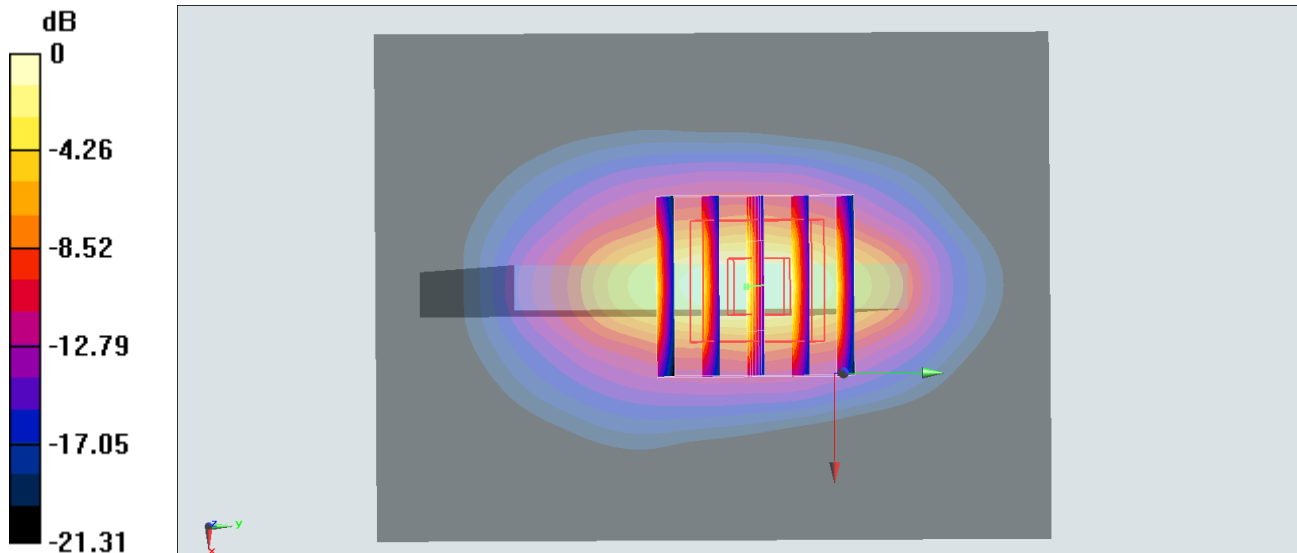

0 dB = 1.65 W/kg = 2.17 dBW/kg

#26_LTE Band 5_10M_QPSK_1_0_Back_5mm_Ch20525

Communication System: LTE ; Frequency: 836.5 MHz;Duty Cycle: 1:1
Medium: HSL_850_200107 Medium parameters used : $f = 836.5$ MHz; $\sigma = 0.887$ S/m; $\epsilon_r = 42.117$;
 $\rho = 1000$ kg/m³
Ambient Temperature : 23.4 °C ; Liquid Temperature : 22.4 °C

DASY5 Configuration

- Probe: ES3DV3 - SN3169;ConvF(6.42, 6.42, 6.42) @ 836.5 MHz;Calibrated: 2019/5/24
- Sensor-Surface: 3mm (Mechanical Surface Detection)
- Electronics: DAE3 Sn577; Calibrated: 2019/9/17
- Phantom: Twin-SAM V5.0 (30deg probe tilt); Type: QD 000 P40 CD; Serial: 1885
- Measurement SW: DASY52, Version 52.10 (2); SEMCAD X Version 14.6.12 (7450)

Area Scan (71x61x1): Interpolated grid: dx=1.500 mm, dy=1.500 mm
Maximum value of SAR (interpolated) = 0.485 W/kg

Zoom Scan (5x5x7)/Cube 0: Measurement grid: dx=8mm, dy=8mm, dz=5mm
Reference Value = 21.37 V/m; Power Drift = 0.03 dB
Peak SAR (extrapolated) = 0.701 W/kg
SAR(1 g) = 0.361 W/kg; SAR(10 g) = 0.205 W/kg
Maximum value of SAR (measured) = 0.469 W/kg

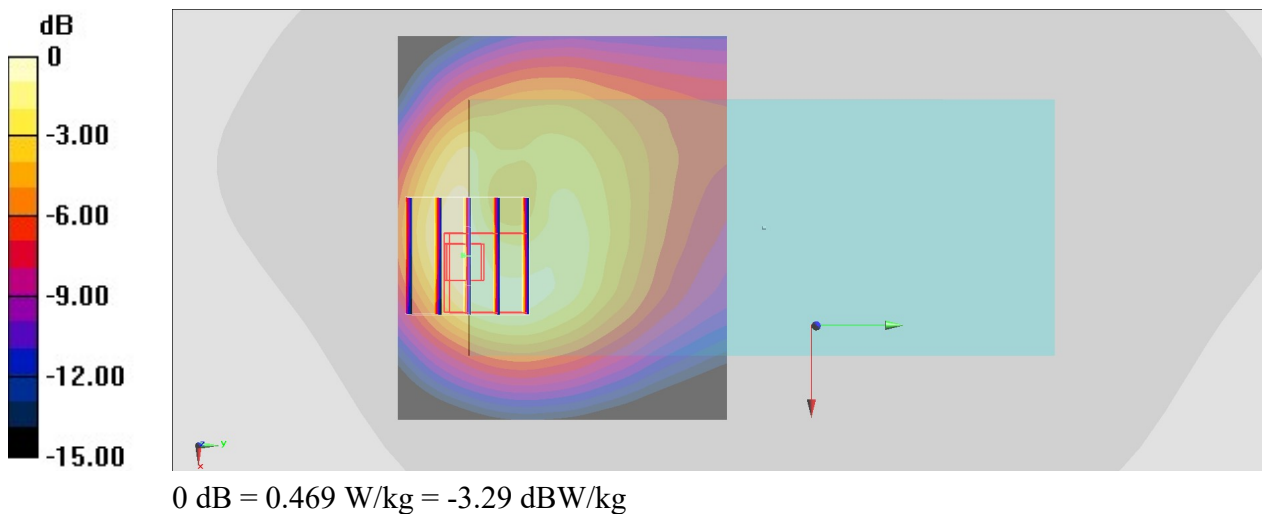

#27_LTE Band 7_20M_QPSK_50_0_Bottom Side_5mm_Ch20850

Communication System: LTE; Frequency: 2510 MHz; Duty Cycle: 1:1
Medium: HSL_2600_200205 Medium parameters used: $f = 2510$ MHz; $\sigma = 1.841$ S/m; $\epsilon_r = 38.916$;
 $\rho = 1000$ kg/m³
Ambient Temperature : 23.5 °C ; Liquid Temperature : 22.5 °C

DASY5 Configuration

- Probe: ES3DV3 - SN3169; ConvF(4.38, 4.38, 4.38) @ 2510 MHz; Calibrated: 2019/5/24
- Sensor-Surface: 3mm (Mechanical Surface Detection)
- Electronics: DAE3 Sn495; Calibrated: 2019/5/21
- Phantom: Twin-SAM V5.0 (30deg probe tilt); Type: QD 000 P40 CD; Serial: 1885
- Measurement SW: DASY52, Version 52.10 (2); SEMCAD X Version 14.6.12 (7450)

Area Scan (51x91x1): Interpolated grid: dx=1.200 mm, dy=1.200 mm
Maximum value of SAR (interpolated) = 1.57 W/kg

Zoom Scan (7x7x7)/Cube 0: Measurement grid: dx=5mm, dy=5mm, dz=5mm
Reference Value = 25.97 V/m; Power Drift = 0.19 dB
Peak SAR (extrapolated) = 2.97 W/kg
SAR(1 g) = 1.2 W/kg; SAR(10 g) = 0.483 W/kg
Maximum value of SAR (measured) = 1.68 W/kg

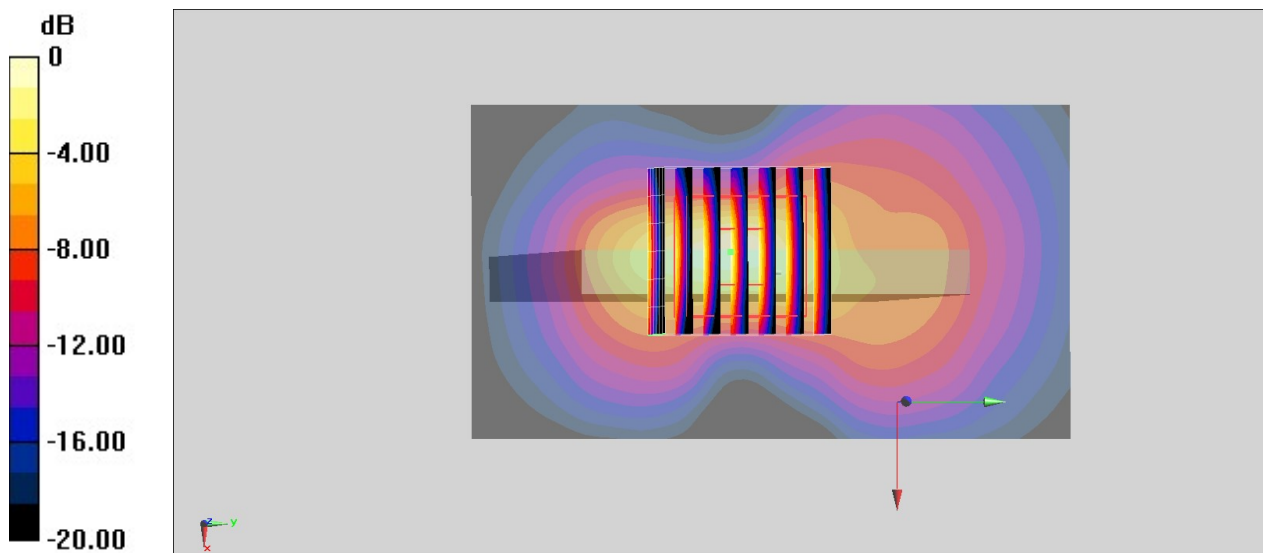

0 dB = 1.68 W/kg = 2.25 dBW/kg

#28_LTE Band 12_10M_QPSK_1_0_Back_5mm_Ch23095

Communication System: LTE ; Frequency: 707.5 MHz;Duty Cycle: 1:1
Medium: HSL_750_200108 Medium parameters used : $f = 707.5$ MHz; $\sigma = 0.849$ S/m; $\epsilon_r = 43.504$;
 $\rho = 1000$ kg/m³
Ambient Temperature : 23.4 °C ; Liquid Temperature : 22.4 °C

DASY5 Configuration

- Probe: ES3DV3 - SN3169;ConvF(6.68, 6.68, 6.68) @ 707.5 MHz;Calibrated: 2019/5/24
- Sensor-Surface: 3mm (Mechanical Surface Detection)
- Electronics: DAE3 Sn577; Calibrated: 2019/9/17
- Phantom: Twin-SAM V5.0 (30deg probe tilt); Type: QD 000 P40 CD; Serial: 1885
- Measurement SW: DASY52, Version 52.10 (2); SEMCAD X Version 14.6.12 (7450)

Area Scan (71x61x1): Interpolated grid: dx=1.500 mm, dy=1.500 mm
Maximum value of SAR (interpolated) = 0.433 W/kg

Zoom Scan (5x5x7)/Cube 0: Measurement grid: dx=8mm, dy=8mm, dz=5mm
Reference Value = 21.91 V/m; Power Drift = -0.01 dB
Peak SAR (extrapolated) = 0.651 W/kg
SAR(1 g) = 0.318 W/kg; SAR(10 g) = 0.170 W/kg
Maximum value of SAR (measured) = 0.424 W/kg

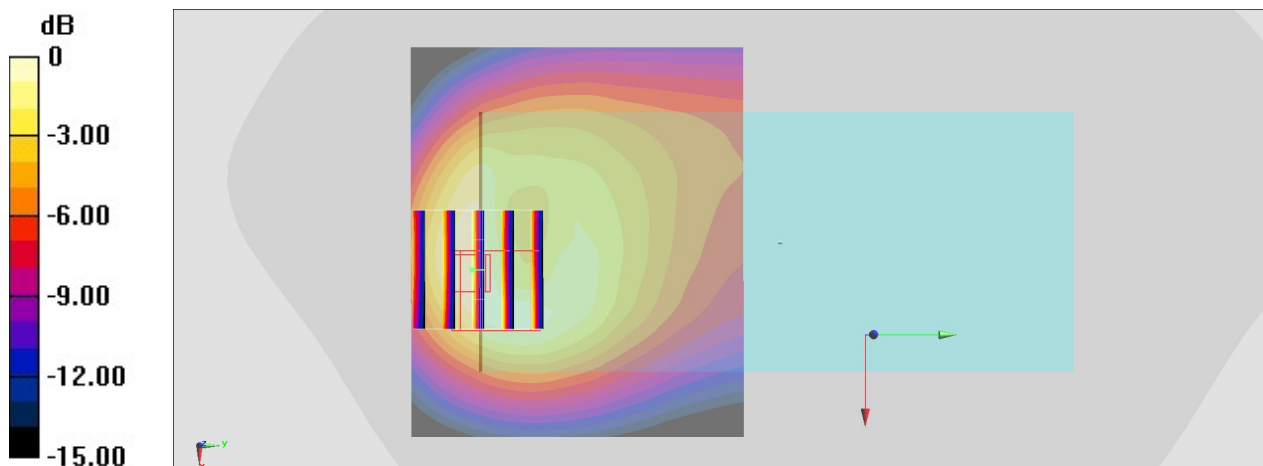

0 dB = 0.424 W/kg = -3.73 dBW/kg

#29_LTE Band 13_10M_QPSK_1_0_Back_5mm_Ch23230

Communication System: LTE ; Frequency: 782 MHz;Duty Cycle: 1:1
Medium: HSL_750_200108 Medium parameters used: $f = 782 \text{ MHz}$; $\sigma = 0.917 \text{ S/m}$; $\epsilon_r = 42.552$; $\rho = 1000 \text{ kg/m}^3$
Ambient Temperature : $23.4 \text{ }^\circ\text{C}$; Liquid Temperature : $22.4 \text{ }^\circ\text{C}$

DASY5 Configuration

- Probe: ES3DV3 - SN3169;ConvF(6.68, 6.68, 6.68) @ 782 MHz;Calibrated: 2019/5/24
- Sensor-Surface: 3mm (Mechanical Surface Detection)
- Electronics: DAE3 Sn577; Calibrated: 2019/9/17
- Phantom: Twin-SAM V5.0 (30deg probe tilt); Type: QD 000 P40 CD; Serial: 1885
- Measurement SW: DASY52, Version 52.10 (2); SEMCAD X Version 14.6.12 (7450)

Area Scan (71x61x1): Interpolated grid: $dx=1.500 \text{ mm}$, $dy=1.500 \text{ mm}$
Maximum value of SAR (interpolated) = 0.507 W/kg

Zoom Scan (5x5x7)/Cube 0: Measurement grid: $dx=8\text{mm}$, $dy=8\text{mm}$, $dz=5\text{mm}$
Reference Value = 22.24 V/m ; Power Drift = 0.02 dB
Peak SAR (extrapolated) = 0.752 W/kg
SAR(1 g) = 0.376 W/kg ; SAR(10 g) = 0.205 W/kg
Maximum value of SAR (measured) = 0.489 W/kg

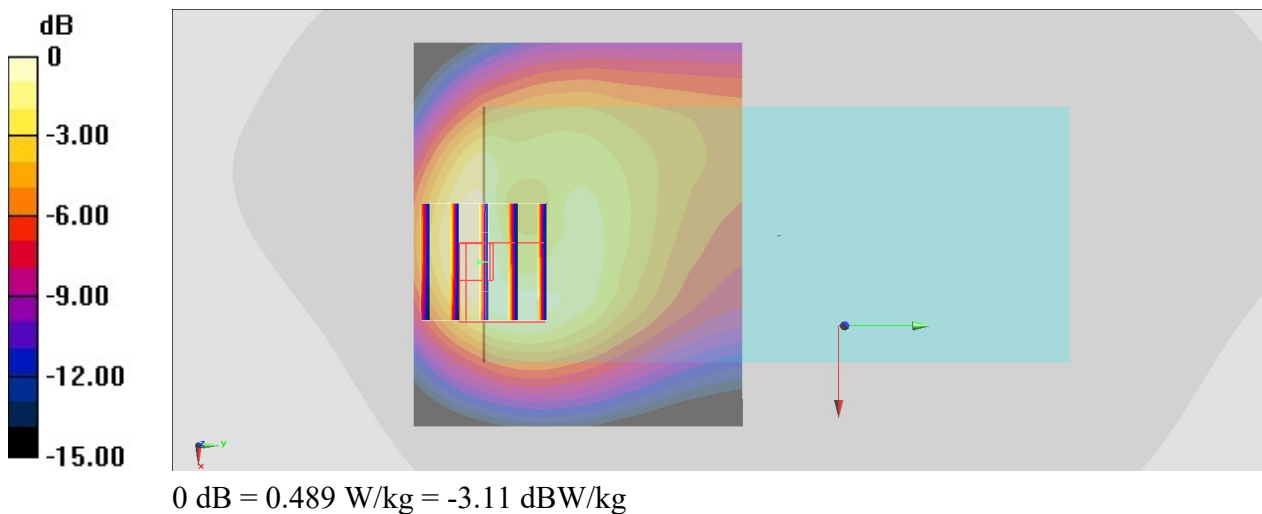

#30_LTE Band 66_20M_QPSK_1_0_Bottom Side_5mm_Ch132572

Communication System: LTE ; Frequency: 1770 MHz;Duty Cycle: 1:1

Medium: HSL_1750_200203 Medium parameters used: $f = 1770$ MHz; $\sigma = 1.413$ S/m; $\epsilon_r = 40.638$; $\rho = 1000$ kg/m³

Ambient Temperature : 23.3 °C ; Liquid Temperature : 22.3 °C

DASY5 Configuration:

- Probe: EX3DV4 - SN7306;ConvF(8.51, 8.51, 8.51); Calibrated: 2019/7/22;
- Sensor-Surface: 1.4mm (Mechanical Surface Detection)
- Electronics: DAE3 Sn577; Calibrated: 2019/9/17
- Phantom: SAM_Left; Type: QD000P40CD; Serial: TP:1801
- Measurement SW: DASY52, Version 52.8 (8);SEMCAD X Version 14.6.10 (7373)

Area Scan (61x81x1): Interpolated grid: dx=1.500 mm, dy=1.500 mm

Maximum value of SAR (interpolated) = 1.69 W/kg

Zoom Scan (5x5x7)/Cube 0: Measurement grid: dx=8mm, dy=8mm, dz=5mm

Reference Value = 11.57 V/m; Power Drift = 0.10 dB

Peak SAR (extrapolated) = 2.05 W/kg

SAR(1 g) = 1.03 W/kg; SAR(10 g) = 0.494 W/kg

Maximum value of SAR (measured) = 1.66 W/kg

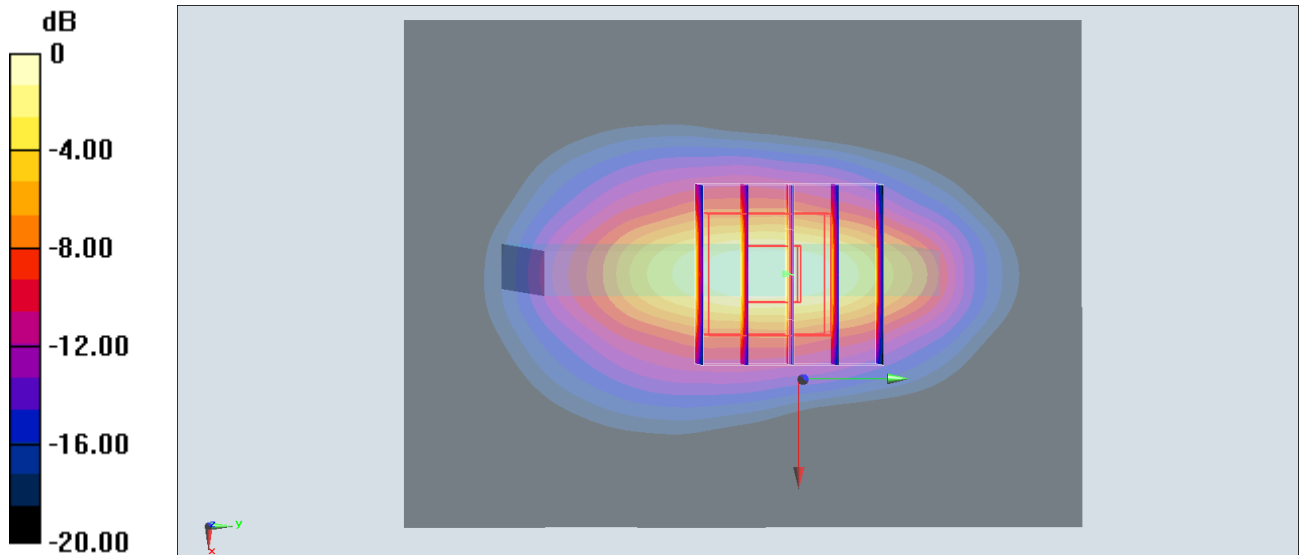

0 dB = 1.66 W/kg = 2.2 dBW/kg

#31_LTE Band 48_20M_QPSK_50_0_Top Side_5mm_Ch56150

Communication System: LTE; Frequency: 3641 MHz; Duty Cycle: 1:1.59

Medium: HSL_3500_200204 Medium parameters used: $f = 3641$ MHz; $\sigma = 3.066$ S/m; $\epsilon_r = 38.932$; $\rho = 1000$ kg/m³

Ambient Temperature : 23.5 °C ; Liquid Temperature : 22.5 °C

DASY5 Configuration:

- Probe: EX3DV4 - SN3925; ConvF(6.91, 6.91, 6.91) @ 3641 MHz; Calibrated: 2019/9/20
- Sensor-Surface: 1.4mm (Mechanical Surface Detection)
- Electronics: DAE4 Sn778; Calibrated: 2019/5/21
- Phantom: SAM_Left; Type: QD000P40CD; Serial: TP:1815
- Measurement SW: DASY52, Version 52.10 (2); SEMCAD X Version 14.6.12 (7470)

Area Scan (51x91x1): Interpolated grid: dx=1.200 mm, dy=1.200 mm

Maximum value of SAR (interpolated) = 1.38 W/kg

Zoom Scan (7x7x7)/Cube 0: Measurement grid: dx=5mm, dy=5mm, dz=1.4mm

Reference Value = 19.29 V/m; Power Drift = -0.02 dB

Peak SAR (extrapolated) = 2.60 W/kg

SAR(1 g) = 0.774 W/kg; SAR(10 g) = 0.264 W/kg

Maximum value of SAR (measured) = 1.72 W/kg

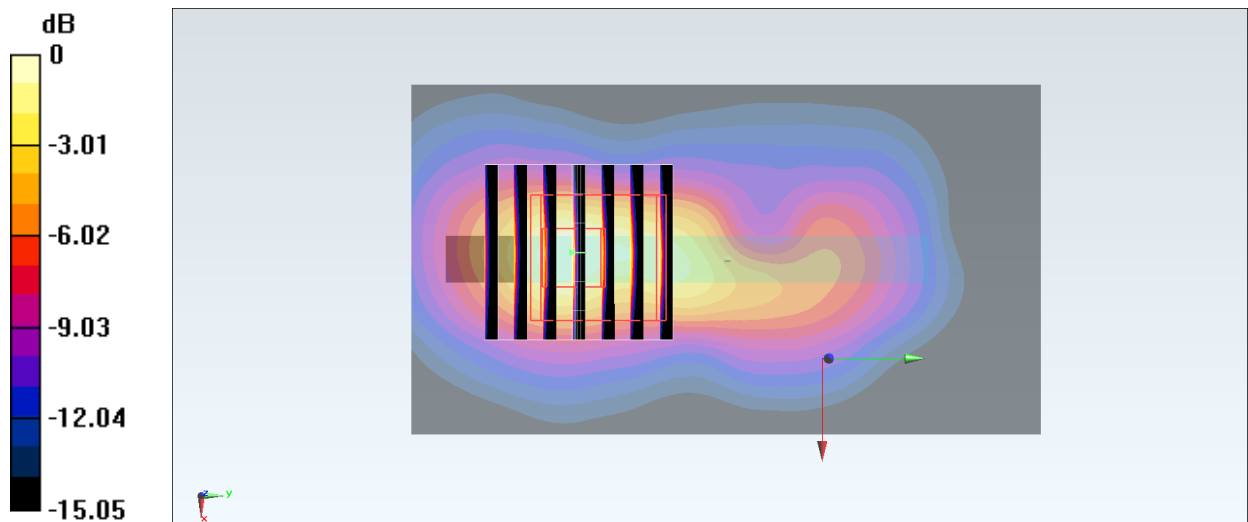

0 dB = 1.38 W/kg = 1.40 dBW/kg

#32_WLAN2.4GHz_802.11b 1Mbps_Back_5mm_Ch1;Ant 4+6

Communication System: 802.11b; Frequency: 2412 MHz; Duty Cycle: 1:1.015
Medium: HSL_2450_200204 Medium parameters used: $f = 2412$ MHz; $\sigma = 1.786$ S/m; $\epsilon_r = 38.929$;
 $\rho = 1000$ kg/m³
Ambient Temperature : 23.5 °C ; Liquid Temperature : 22.5 °C

DASY5 Configuration

- Probe: ES3DV3 - SN3169; ConvF(4.54, 4.54, 4.54) @ 2412 MHz; Calibrated: 2019/5/24
- Sensor-Surface: 3mm (Mechanical Surface Detection)
- Electronics: DAE3 Sn495; Calibrated: 2019/5/21
- Phantom: Twin-SAM V5.0 (30deg probe tilt); Type: QD 000 P40 CD; Serial: 1885
- Measurement SW: DASY52, Version 52.10 (2); SEMCAD X Version 14.6.12 (7450)

Area Scan (91x61x1): Interpolated grid: dx=1.200 mm, dy=1.200 mm
Maximum value of SAR (interpolated) = 0.304 W/kg

Zoom Scan (7x7x7)/Cube 0: Measurement grid: dx=5mm, dy=5mm, dz=5mm
Reference Value = 7.329 V/m; Power Drift = -0.02 dB
Peak SAR (extrapolated) = 0.844 W/kg
SAR(1 g) = 0.317 W/kg; SAR(10 g) = 0.111 W/kg
Maximum value of SAR (measured) = 0.424 W/kg

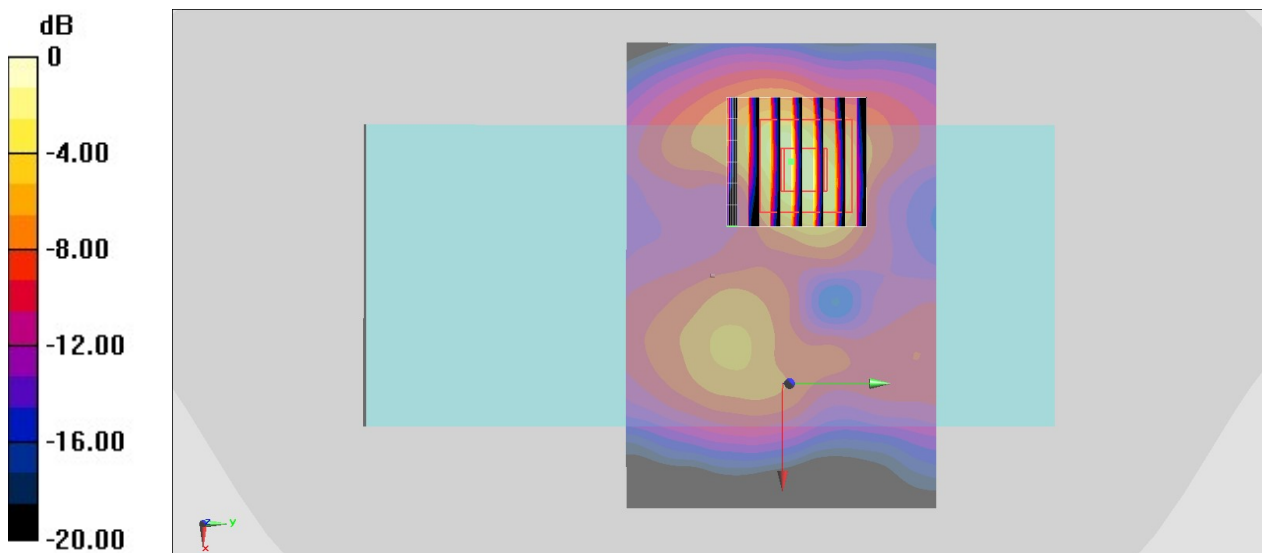

0 dB = 0.424 W/kg = -3.73 dBW/kg

#33_WLAN5GHz_802.11ac-VHT80 MCS0_Back_5mm_Ch42;Ant 3+6

Communication System: 802.11ac; Frequency: 5210 MHz; Duty Cycle: 1:1

Medium: HSL_5G_200203 Medium parameters used : $f = 5210$ MHz; $\sigma = 4.672$ S/m; $\epsilon_r = 36.085$; $\rho = 1000$ kg/m³

Ambient Temperature : 23.7 °C ; Liquid Temperature : 22.7 °C

DASY5 Configuration:

- Probe: EX3DV4 - SN3931; ConvF(5.08, 5.08, 5.08) @ 5210 MHz; Calibrated: 2019/9/26
- Sensor-Surface: 1.4mm (Mechanical Surface Detection)
- Electronics: DAE4 Sn1311; Calibrated: 2019/8/27
- Phantom: SAM LEFT; Type: QD000P40CD; Serial: TP:1718
- Measurement SW: DASY52, Version 52.10 (2); SEMCAD X Version 14.6.12 (7470)

Area Scan (101x121x1): Interpolated grid: dx=1.000 mm, dy=1.000 mm

Maximum value of SAR (interpolated) = 0.496 W/kg

Zoom Scan (8x9x7)/Cube 0: Measurement grid: dx=4mm, dy=4mm, dz=1.4mm

Reference Value = 7.187 V/m; Power Drift = -0.16 dB

Peak SAR (extrapolated) = 1.70 W/kg

SAR(1 g) = 0.280 W/kg; SAR(10 g) = 0.049 W/kg

Maximum value of SAR (measured) = 0.883 W/kg

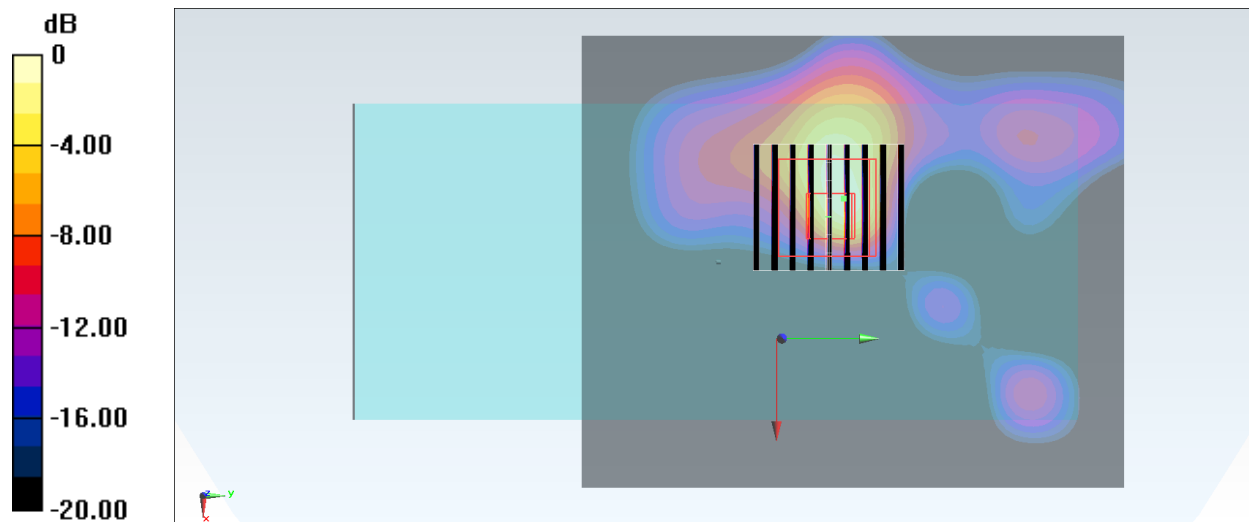

0 dB = 0.496 W/kg = -3.05 dBW/kg

#34_WLAN5GHz_802.11ac-VHT80 MCS0_Back_5mm_Ch155;Ant 3+6

Communication System: 802.11ac; Frequency: 5775 MHz; Duty Cycle: 1:1

Medium: HSL_5G_200203 Medium parameters used: $f = 5775$ MHz; $\sigma = 5.109$ S/m; $\epsilon_r = 35.322$; $\rho = 1000$ kg/m³

Ambient Temperature : 23.7 °C ; Liquid Temperature : 22.7 °C

DASY5 Configuration:

- Probe: EX3DV4 - SN3931; ConvF(4.75, 4.75, 4.75) @ 5775 MHz; Calibrated: 2019/9/26
- Sensor-Surface: 1.4mm (Mechanical Surface Detection)
- Electronics: DAE4 Sn1311; Calibrated: 2019/8/27
- Phantom: SAM LEFT; Type: QD000P40CD; Serial: TP:1718
- Measurement SW: DASY52, Version 52.10 (2); SEMCAD X Version 14.6.12 (7470)

Area Scan (101x121x1): Interpolated grid: dx=1.000 mm, dy=1.000 mm

Maximum value of SAR (interpolated) = 0.500 W/kg

Zoom Scan (9x8x7)/Cube 0: Measurement grid: dx=4mm, dy=4mm, dz=1.4mm

Reference Value = 4.009 V/m; Power Drift = -0.08 dB

Peak SAR (extrapolated) = 1.41 W/kg

SAR(1 g) = 0.248 W/kg; SAR(10 g) = 0.057 W/kg

Maximum value of SAR (measured) = 0.775 W/kg

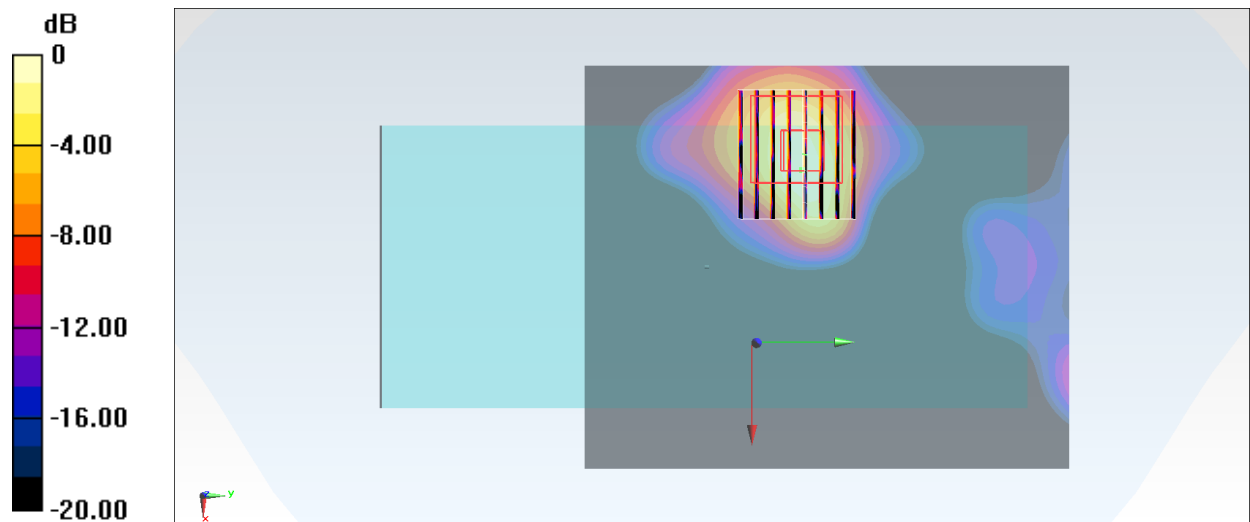

0 dB = 0.500 W/kg = -3.01 dBW/kg

#35_Bluetooth_1M_Back_5mm_Ch39

Communication System: Bluetooth; Frequency: 2441 MHz; Duty Cycle: 1:1.301
Medium: HSL_2450_200204 Medium parameters used : $f = 2441$ MHz; $\sigma = 1.817$ S/m; $\epsilon_r = 38.812$;
 $\rho = 1000$ kg/m³
Ambient Temperature : 23.5 °C ; Liquid Temperature : 22.5 °C

DASY5 Configuration

- Probe: ES3DV3 - SN3169; ConvF(4.54, 4.54, 4.54) @ 2441 MHz; Calibrated: 2019/5/24
- Sensor-Surface: 3mm (Mechanical Surface Detection)
- Electronics: DAE3 Sn495; Calibrated: 2019/5/21
- Phantom: Twin-SAM V5.0 (30deg probe tilt); Type: QD 000 P40 CD; Serial: 1885
- Measurement SW: DASY52, Version 52.10 (2); SEMCAD X Version 14.6.12 (7450)

Area Scan (91x61x1): Interpolated grid: dx=1.200 mm, dy=1.200 mm
Maximum value of SAR (interpolated) = 0.181 W/kg

Zoom Scan (7x7x7)/Cube 0: Measurement grid: dx=5mm, dy=5mm, dz=5mm
Reference Value = 4.797 V/m; Power Drift = -0.00 dB
Peak SAR (extrapolated) = 0.510 W/kg
SAR(1 g) = 0.171 W/kg; SAR(10 g) = 0.056 W/kg
Maximum value of SAR (measured) = 0.242 W/kg

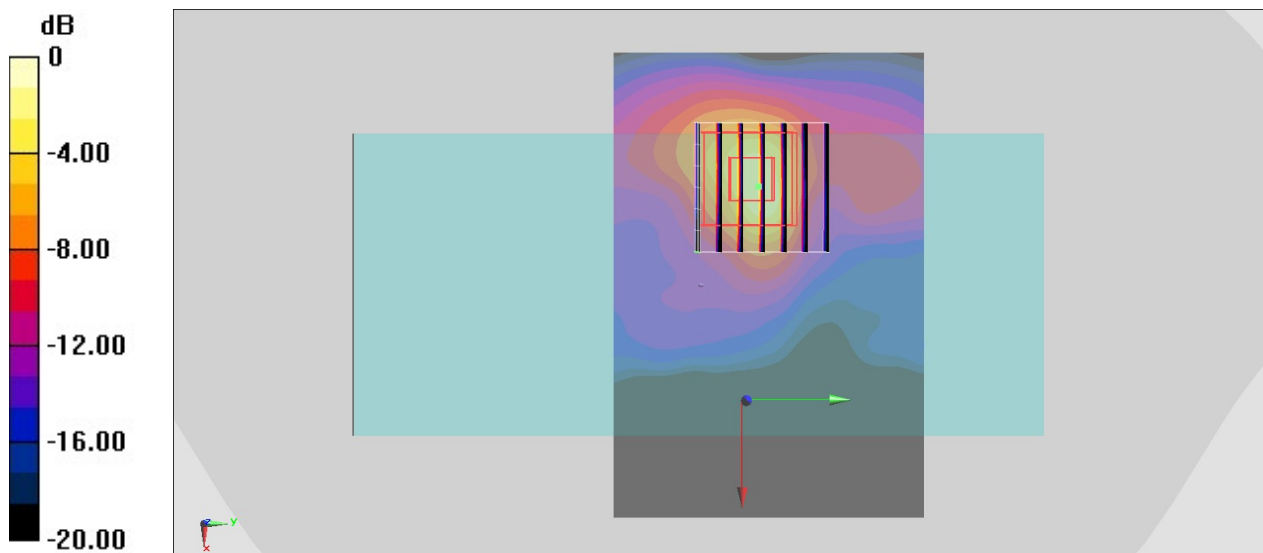

0 dB = 0.242 W/kg = -6.16 dBW/kg