



FCC RADIO TEST REPORT

FCC ID : IHDT56XS1
Equipment : Mobile Cellular Phone
Brand Name : Motorola
Model Name : XT1980-4
Applicant : Motorola Mobility LLC
222 W, Merchandise Mart Plaza, Chicago IL 60654 USA
Manufacturer : Motorola Mobility LLC
222 W, Merchandise Mart Plaza, Chicago IL 60654 USA
Standard : FCC Part 15 Subpart C §15.247

The product was received on Mar. 05, 2019 and testing was started from Mar. 21, 2019 and completed on Mar. 29, 2019. We, SPORTON INTERNATIONAL INC. EMC & Wireless Communications Laboratory, would like to declare that the tested sample has been evaluated in accordance with the test procedures and has been in compliance with the applicable technical standards.

The report must not be used by the client to claim product certification, approval, or endorsement by TAF or any agency of government.

The test results in this partial report apply exclusively to the tested model / sample. Without written approval of SPORTON INTERNATIONAL INC. EMC & Wireless Communications Laboratory, the test report shall not be reproduced except in full.

Reviewed by: Jones Tsai

SPORTON INTERNATIONAL INC. EMC & Wireless Communications Laboratory
No. 52, Huaya 1st Rd., Guishan Dist., Taoyuan City, Taiwan (R.O.C.)



Table of Contents

Summary of Test Result	4
1 General Description	5
1.1 Product Feature of Equipment Under Test.....	5
1.2 Product Specification of Equipment Under Test.....	5
1.3 Modification of EUT	5
1.4 Testing Location	6
1.5 Applicable Standards.....	6
2 Test Configuration of Equipment Under Test	7
2.1 Carrier Frequency Channel	7
2.2 Test Mode.....	8
2.3 Connection Diagram of Test System.....	9
2.4 Support Unit used in test configuration and system	11
2.5 EUT Operation Test Setup	11
3 Test Result	12
3.1 Radiated Band Edges and Spurious Emission Measurement	12
3.2 AC Conducted Emission Measurement.....	16
4 List of Measuring Equipment	18
5 Uncertainty of Evaluation	19
Appendix A. AC Conducted Emission Test Result	
Appendix B. Radiated Spurious Emission	
Appendix C. Radiated Spurious Emission Plots	
Appendix D. Duty Cycle Plots	



Summary of Test Result

Report Clause	Ref Std. Clause	Test Items	Result (PASS/FAIL)	Remark
3.1	15.247(d)	Radiated Band Edges and Radiated Spurious Emission	Pass	Under limit 6.19 dB at 44.550 MHz
3.2	15.207	AC Conducted Emission	Pass	Under limit 10.19 dB at 0.211 MHz

Reviewed by: Wii Chang

Report Producer: Elise Chang



1 General Description

1.1 Product Feature of Equipment Under Test

Product Feature	
Equipment	Mobile Cellular Phone
Brand Name	Motorola
Model Name	XT1980-4
FCC ID	IHDT56XS1
IMEI Code	Conduction : 352157100008509 Radiation : 352157100011206
EUT supports Radios application	CDMA/EV-DO/GSM/EGPRS/WCDMA/HSPA/LTE/GNSS/NFC/FM/WPC WLAN 11a/b/g/n HT20/HT40 WLAN 11ac VHT20/VHT40/VHT80 Bluetooth BR/EDR/LE
HW Version	DVT2
EUT Stage	Identical Prototype

Remark: The above EUT's information was declared by manufacturer.

Accessory List	
WPC Cover	Brand Name : Motorola
	Model Name : MD100W

1.2 Product Specification of Equipment Under Test

Standards-related Product Specification	
Tx/Rx Frequency Range	2402 MHz ~ 2480 MHz
Number of Channels	79
Carrier Frequency of Each Channel	2402+n*1 MHz; n=0~78
Antenna Type / Gain	Loop Antenna type with gain -8.0 dBi
Type of Modulation	Bluetooth BR (1Mbps) : GFSK Bluetooth EDR (2Mbps) : $\pi/4$ -DQPSK Bluetooth EDR (3Mbps) : 8-DPSK

1.3 Modification of EUT

No modifications are made to the EUT during all test items.



1.4 Testing Location

Test Site	SPORTON INTERNATIONAL INC.
Test Site Location	No.52, Huaya 1st Rd., Guishan Dist., Taoyuan City, Taiwan (R.O.C.) TEL: +886-3-327-3456 FAX: +886-3-328-4978
Test Site No.	Sporton Site No.
	CO05-HY

Note: The test site complies with ANSI C63.4 2014 requirement.

Test Site	SPORTON INTERNATIONAL INC.
Test Site Location	No.58, Aly. 75, Ln. 564, Wenhua 3rd, Rd., Guishan Dist., Taoyuan City, Taiwan (R.O.C.) TEL: +886-3-327-0868 FAX: +886-3-327-0855
Test Site No.	Sporton Site No.
	03CH11-HY

Note: The test site complies with ANSI C63.4 2014 requirement.

FCC Designation No. TW1190 and TW0007

1.5 Applicable Standards

According to the specifications of the manufacturer, the EUT must comply with the requirements of the following standards:

- ♦ FCC Part 15 Subpart C §15.247
- ♦ FCC KDB Publication No. 558074 D01 DTS Meas. Guidance v05r01
- ♦ FCC KDB 414788 D01 Radiated Test Site v01r01.
- ♦ ANSI C63.10-2013

Remark:

1. All test items were verified and recorded according to the standards and without any deviation during the test.
2. This EUT has also been tested and complied with the requirements of FCC Part 15, Subpart B, recorded in a separate test report.



2 Test Configuration of Equipment Under Test

2.1 Carrier Frequency Channel

Frequency Band	Channel	Freq. (MHz)	Channel	Freq. (MHz)	Channel	Freq. (MHz)
2400-2483.5 MHz	0	2402	27	2429	54	2456
	1	2403	28	2430	55	2457
	2	2404	29	2431	56	2458
	3	2405	30	2432	57	2459
	4	2406	31	2433	58	2460
	5	2407	32	2434	59	2461
	6	2408	33	2435	60	2462
	7	2409	34	2436	61	2463
	8	2410	35	2437	62	2464
	9	2411	36	2438	63	2465
	10	2412	37	2439	64	2466
	11	2413	38	2440	65	2467
	12	2414	39	2441	66	2468
	13	2415	40	2442	67	2469
	14	2416	41	2443	68	2470
	15	2417	42	2444	69	2471
	16	2418	43	2445	70	2472
	17	2419	44	2446	71	2473
	18	2420	45	2447	72	2474
	19	2421	46	2448	73	2475
	20	2422	47	2449	74	2476
	21	2423	48	2450	75	2477
	22	2424	49	2451	76	2478
	23	2425	50	2452	77	2479
	24	2426	51	2453	78	2480
	25	2427	52	2454	-	-
	26	2428	53	2455	-	-



2.2 Test Mode

- a. The EUT has been associated with peripherals and configuration operated in a manner tended to maximize its emission characteristics in a typical application. Frequency range investigated: conduction emission (150 kHz to 30 MHz), radiation emission (9 kHz to the 10th harmonic of the highest fundamental frequency or to 40 GHz, whichever is lower).The worst mode of radiated spurious emissions is Bluetooth 1Mbps mode, and recorded in this report.
- b. AC power line Conducted Emission was tested under maximum output power.

The following summary table is showing all test modes to demonstrate in compliance with the standard.

Summary table of Test Cases	
Test Item	Data Rate / Modulation
Radiated Test Cases	Bluetooth BR 1Mbps GFSK
	Mode 1: CH78_2480 MHz for WPC Charging Mode
	Mode 2: CH78_2480 MHz for PMA Charging Mode
AC Conducted Emission	Mode 1: GSM850 Idle + Bluetooth Link + WLAN Link + Camera + Battery + WPC Back Cover + LG Charging Pad + USB Cable (Charging from Adapter) + SIM 1 Mode 2: WCDMA Band V Idle + Bluetooth Link + WLAN Link + MPEG4 + Battery + WPC Back Cover + PMA Charging Pad + Adapter + SIM 1
Remark:	
<ol style="list-style-type: none"> 1. For radiated test cases, the worst mode data rate 1Mbps was reported only since the highest RF output power in the preliminary tests. The conducted spurious emissions and conducted band edge measurement for other data rates were not worse than 1Mbps, and no other significantly frequencies found in conducted spurious emission. 2. The worst case of conducted emission is mode 2; only the test data of it was reported. 	

2.3 Connection Diagram of Test System

<Bluetooth Tx with LG Charging Mode>

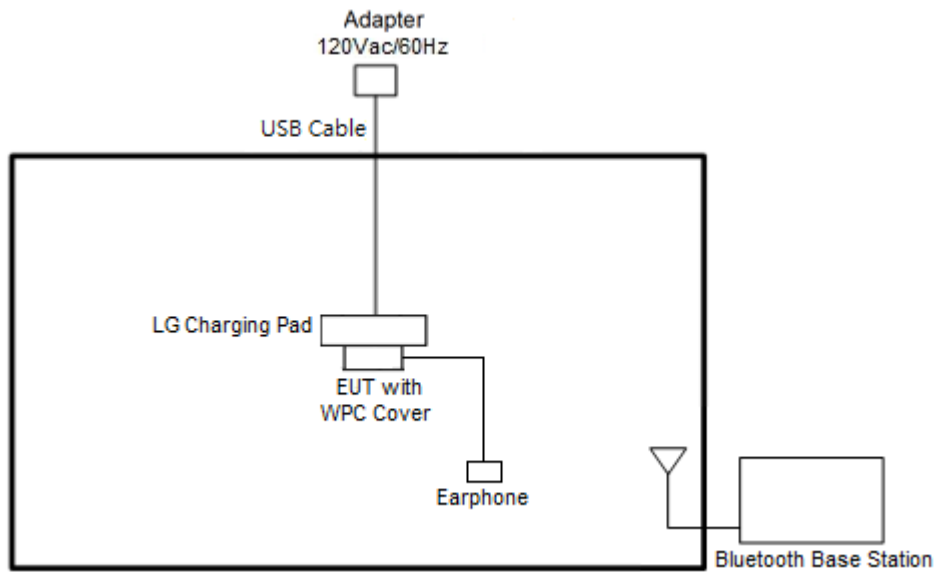

<Bluetooth Tx with PMA Charging Mode>

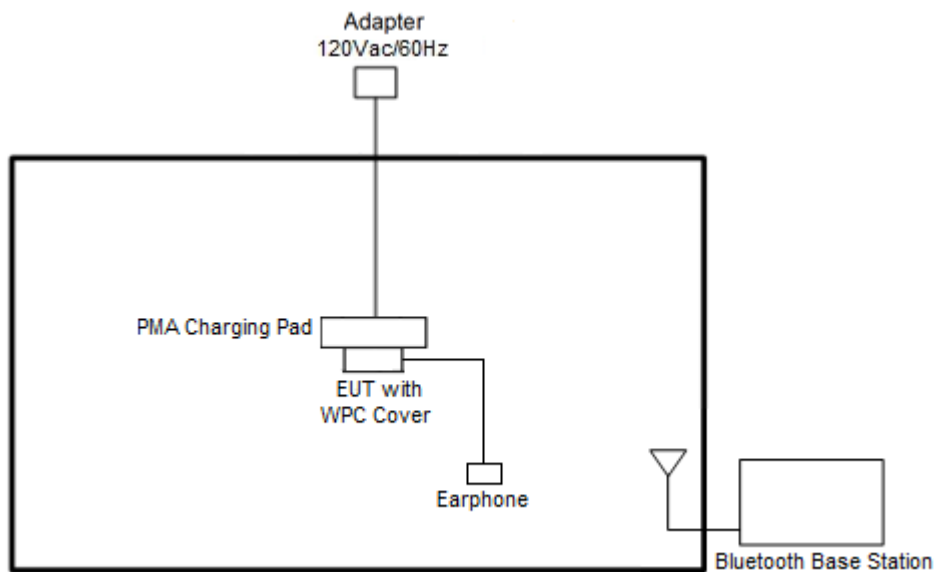

<AC Conducted Emission with WPC Charging Mode>

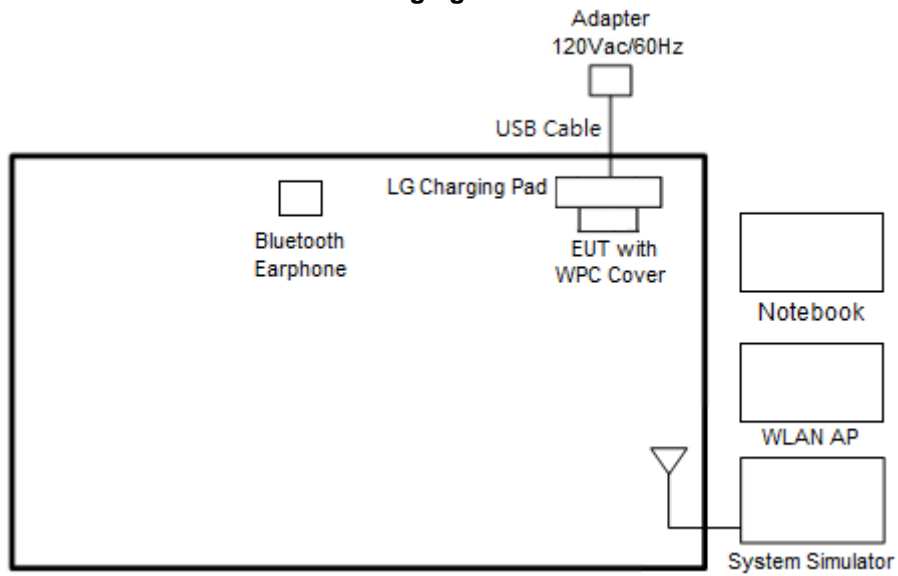

<AC Conducted Emissions with PMA Charging Mode>

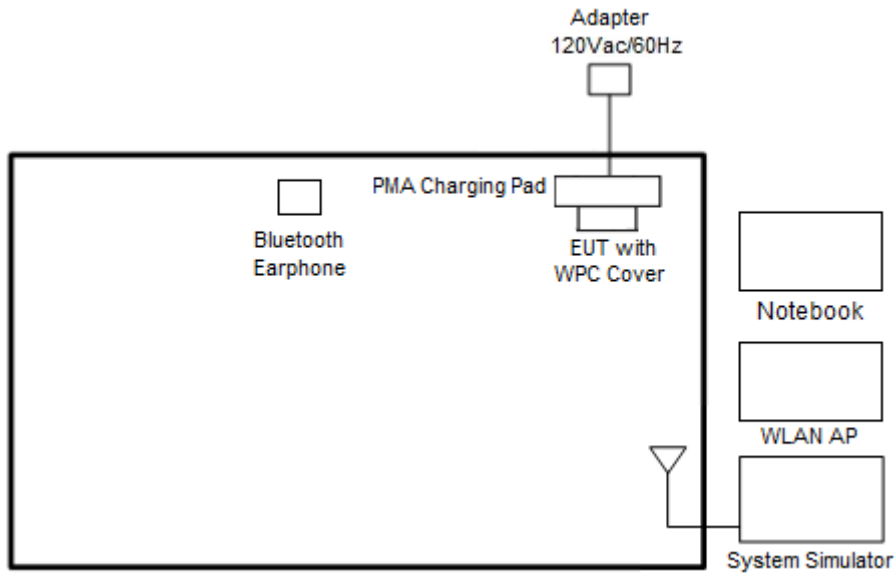



2.4 Support Unit used in test configuration and system

Item	Equipment	Trade Name	Model Name	FCC ID	Data Cable	Power Cord
1.	Bluetooth Base Station	R&S	CBT32	N/A	N/A	Unshielded, 1.8 m
2.	System Simulator	Anritsu	MT8820C	N/A	N/A	Unshielded, 1.8 m
3.	WLAN AP	ASUS	RT-AC66U	MSQ-RTAC66U	N/A	Unshielded,1.8m
4.	Bluetooth Earphone	Sony Ericsson	MW600	PY7DDA-2029	N/A	N/A
5.	Notebook	DELL	Latitude E6320	FCC DoC/ Contains FCC ID: QDS-BRCM1054	N/A	AC I/P: Unshielded, 1.2 m DC O/P: Shielded, 1.8 m
6.	LG Charging Pad	LG	WCD-110	FCC DoC	N/A	N/A
7.	PMA Charging Pad	DURACELL	M-018B518A	FCC DoC	N/A	N/A
8.	USB Cable	N/A	N/A	N/A	N/A	N/A
9.	Adapter	N/A	N/A	N/A	N/A	N/A
10.	Earphone	Moto	SH38C16618	FCC DoC	Unshielded, 1.0 m	N/A
11.	SD Card	SanDisk	MicroSD HC	FCC DoC	N/A	N/A

2.5 EUT Operation Test Setup

The RF test items, utility “QRCT” was installed in Notebook which was programmed in order to make the EUT get into the engineering modes to contact with base station to provide channel selection, power level, data rate and the application type and for continuous transmitting signals.



3 Test Result

3.1 Radiated Band Edges and Spurious Emission Measurement

3.1.1 Limit of Radiated Band Edges and Spurious Emission

In any 100 kHz bandwidth outside the intentional radiator frequency band, all harmonics/spurious must be at least 20 dB below the highest emission level within the authorized band. In addition, radiated emissions which fall in the restricted bands must also comply with the limits as below.

Frequency (MHz)	Field Strength (microvolts/meter)	Measurement Distance (meters)
0.009 – 0.490	2400/F(kHz)	300
0.490 – 1.705	24000/F(kHz)	30
1.705 – 30.0	30	30
30 – 88	100	3
88 – 216	150	3
216 - 960	200	3
Above 960	500	3

3.1.2 Measuring Instruments

See list of measuring equipment of this test report.



3.1.3 Test Procedures

1. The EUT was placed on a turntable with 0.8 meter for frequency below 1GHz and 1.5 meter for frequency above 1GHz respectively above ground.
1. The EUT was set 3 meters from the interference receiving antenna, which was mounted on the top of a variable height antenna tower.
2. For each suspected emission, the EUT was arranged to its worst case and then tune the Antenna tower (from 1 m to 4 m) and turntable (from 0 degree to 360 degrees) to find the maximum reading. A pre-amp and a high pass filter are used for the test in order to get better signal level to comply with the guidelines.
3. Set to the maximum power setting and enable the EUT transmit continuously.
4. Use the following spectrum analyzer settings:
 - (1) Span shall wide enough to fully capture the emission being measured;
 - (2) Set RBW=100 kHz for $f < 1$ GHz, RBW=1MHz for $f > 1$ GHz ; VBW \geq RBW; Sweep = auto; Detector function = peak; Trace = max hold for peak
 - (3) For average measurement: use duty cycle correction factor method per 15.35(c).
Duty cycle = On time/100 milliseconds
On time = $N_1 * L_1 + N_2 * L_2 + \dots + N_{n-1} * L_{n-1} + N_n * L_n$
Where N_1 is number of type 1 pulses, L_1 is length of type 1 pulses, etc.
Average Emission Level = Peak Emission Level + $20 * \log(\text{Duty cycle})$
5. Corrected Reading: Antenna Factor + Cable Loss + Read Level - Preamp Factor = Level
6. For testing below 1GHz, if the emission level of the EUT in peak mode was 3 dB lower than the limit specified, then peak values of EUT will be reported, otherwise, the emissions will be repeated one by one using the CISPR quasi-peak method and reported.
7. For testing above 1GHz, the emission level of the EUT in peak mode was 20dB lower than average limit (that means the emission level in average mode also complies with the limit in average mode), then peak values of EUT will be reported, otherwise, the emissions will be measured in average mode again and reported.

Note: The average levels were calculated from the peak level corrected with duty cycle correction factor (-24.79dB) derived from $20 \log(\text{dwell time}/100\text{ms})$. This correction is only for signals that hop with the fundamental signal, such as band-edge and harmonic. Other spurious signals that are independent of the hopping signal would not use this correction.

3.1.4 Test Setup

For radiated emissions below 30MHz

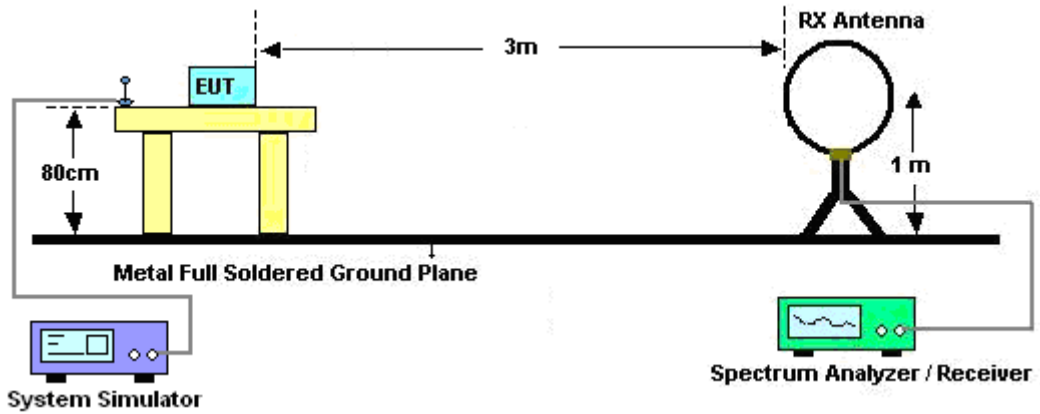

For radiated emissions from 30MHz to 1GHz

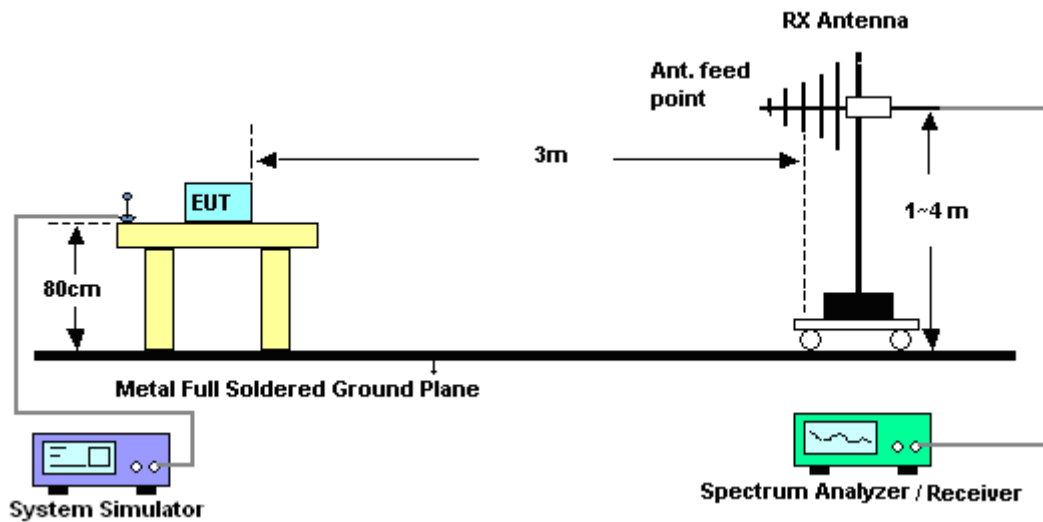

For radiated emissions above 1GHz

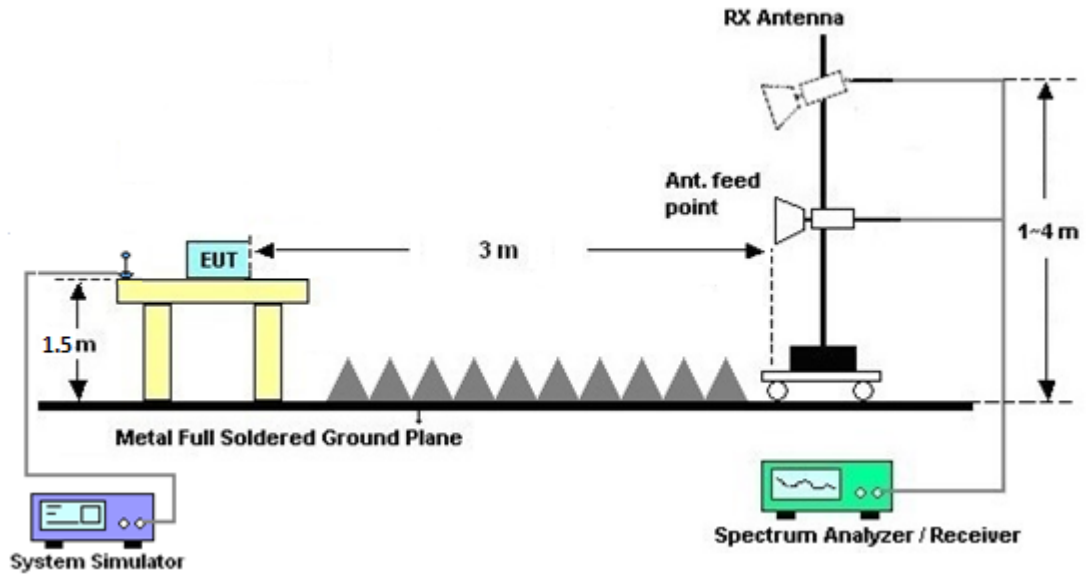

3.1.5 Test Results of Radiated Spurious Emissions (9 kHz ~ 30 MHz)

The low frequency, which started from 9 kHz to 30MHz, was pre-scanned and the result which was 20dB lower than the limit line was not reported.

There is a comparison data of both open-field test site and alternative test site - semi-Anechoic chamber according to 414788 D01 Radiated Test Site v01r01, and the result came out very similar.

3.1.6 Test Result of Radiated Spurious at Band Edges

Please refer to Appendix B and C.

3.1.7 Duty Cycle

Please refer to Appendix D.

3.1.8 Test Result of Radiated Spurious Emission (30MHz ~ 10th Harmonic)

Please refer to Appendix B and C.



3.2 AC Conducted Emission Measurement

3.2.1 Limit of AC Conducted Emission

For equipment that is designed to be connected to the public utility (AC) power line, the radio frequency voltage that is conducted back onto the AC power line on any frequency or frequencies within the band 150 kHz to 30 MHz shall not exceed the limits in the following table.

Frequency of emission (MHz)	Conducted limit (dB μ V)	
	Quasi-peak	Average
0.15-0.5	66 to 56*	56 to 46*
0.5-5	56	46
5-30	60	50

*Decreases with the logarithm of the frequency.

3.2.2 Measuring Instruments

See list of measuring equipment of this test report.

3.2.3 Test Procedures

1. The EUT was placed 0.4 meter from the conducting wall of the shielding room was kept at least 80 centimeters from any other grounded conducting surface.
2. Connect EUT to the power mains through a line impedance stabilization network (LISN).
3. All the support units are connecting to the other LISN.
4. The LISN provides 50 ohm coupling impedance for the measuring instrument.
5. The FCC states that a 50 ohm, 50 microhenry LISN should be used.
6. Both sides of AC line were checked for maximum conducted interference.
7. The frequency range from 150 kHz to 30 MHz was searched.
8. Set the test-receiver system to Peak Detect Function and specified bandwidth (IF Bandwidth = 9kHz) with Maximum Hold Mode. Then measurement is also conducted by Average Detector and Quasi-Peak Detector Function respectively.

3.2.4 Test Setup

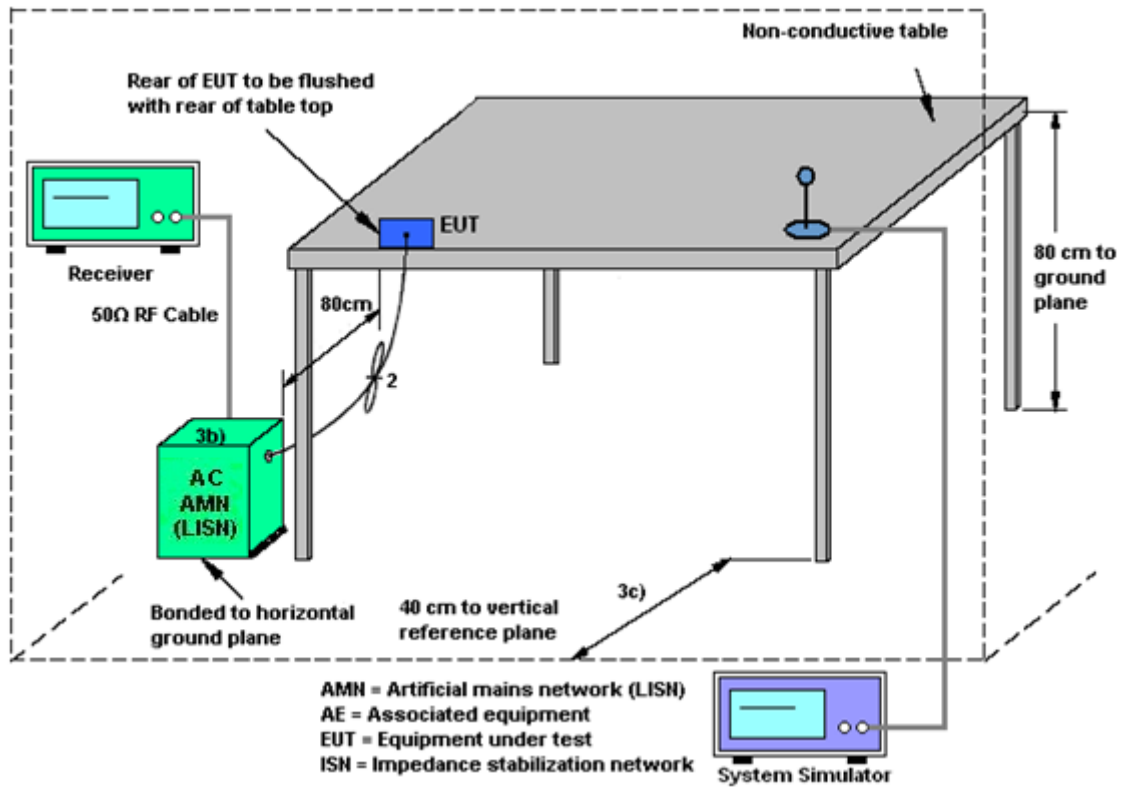

3.2.5 Test Result of AC Conducted Emission

Please refer to Appendix A.



4 List of Measuring Equipment

Instrument	Manufacturer	Model No.	Serial No.	Characteristics	Calibration Date	Test Date	Due Date	Remark
AC Power Source	ChainTek	APC-1000W	N/A	N/A	N/A	Mar. 29, 2019	N/A	Conduction (CO05-HY)
EMI Test Receiver	Rohde & Schwarz	ESR3	102388	9kHz~3.6GHz	Nov. 12, 2018	Mar. 29, 2019	Nov. 11, 2019	Conduction (CO05-HY)
LISN	Rohde & Schwarz	ENV216	100080	9kHz~30MHz	Nov. 14, 2018	Mar. 29, 2019	Nov. 13, 2019	Conduction (CO05-HY)
Software	Rohde & Schwarz	EMC32 V10.30	N/A	N/A	N/A	Mar. 29, 2019	N/A	Conduction (CO05-HY)
LF Cable	HUBER + SUHNER	RG-214/U	LF01	N/A	Dec. 31, 2018	Mar. 29, 2019	Dec. 30, 2019	Conduction (CO05-HY)
Pulse Limiter	Rohde & Schwarz	ESH3-Z2	100851	N/A	Dec. 31, 2018	Mar. 29, 2019	Dec. 30, 2019	Conduction (CO05-HY)
Amplifier	MITEQ	TTA1840-35-HG	1871923	18GHz~40GHz, VSWR : 2.5:1 max	Jul. 16, 2018	Mar. 21, 2019~ Mar. 27, 2019	Jul. 15, 2019	Radiation (03CH11-HY)
Amplifier	SONOMA	310N	187312	9kHz~1GHz	Dec. 04, 2018	Mar. 21, 2019~ Mar. 27, 2019	Dec. 03, 2019	Radiation (03CH11-HY)
Bilog Antenna	TESEQ	CBL 6111D&N-6-06	35414&AT-N0602	30MHz~1GHz	Oct. 13, 2018	Mar. 21, 2019~ Mar. 27, 2019	Oct. 12, 2019	Radiation (03CH11-HY)
Horn Antenna	SCHWARZBECK	BBHA 9120 D	9120D-1326	1GHz ~ 18GHz	Oct. 30, 2018	Mar. 21, 2019~ Mar. 27, 2019	Oct. 29, 2019	Radiation (03CH11-HY)
Loop Antenna	Rohde & Schwarz	HFH2-Z2	100488	9 kHz~30 MHz	Nov. 22, 2018	Mar. 21, 2019~ Mar. 27, 2019	Nov. 21, 2019	Radiation (03CH11-HY)
Preamplifier	Keysight	83017A	MY53270080	1GHz~26.5GHz	Nov. 14, 2018	Mar. 21, 2019~ Mar. 27, 2019	Nov. 13, 2020	Radiation (03CH11-HY)
Spectrum Analyzer	Keysight	N9010A	MY54200486	10Hz ~ 44GHz	Oct. 19, 2018	Mar. 21, 2019~ Mar. 27, 2019	Oct. 18, 2019	Radiation (03CH11-HY)
Antenna Mast	EMEC	AM-BS-4500-B	N/A	1~4m	N/A	Mar. 21, 2019~ Mar. 27, 2019	N/A	Radiation (03CH11-HY)
Turn Table	EMEC	TT 2000	N/A	0~360 Degree	N/A	Mar. 21, 2019~ Mar. 27, 2019	N/A	Radiation (03CH11-HY)
Preamplifier	Jet-Power	JPA0118-55-303K	1710001800054002	1GHz~18GHz	Apr. 17, 2018	Mar. 21, 2019~ Mar. 27, 2019	Apr. 16, 2019	Radiation (03CH11-HY)
SHF-EHF Horn Antenna	SCHWARZBECK	BBHA 9170	BBHA9170584	18GHz- 40GHz	Dec. 05, 2018	Mar. 21, 2019~ Mar. 27, 2019	Dec. 04, 2019	Radiation (03CH11-HY)
EMI Test Receiver	Keysight	N9038A(MXE)	MY53290045	N/A	Jan. 19, 2019	Mar. 21, 2019~ Mar. 27, 2019	Jan. 18, 2020	Radiation (03CH11-HY)
Software	Audix	E3 6.2009-8-24	RK-001042	N/A	N/A	Mar. 21, 2019~ Mar. 27, 2019	N/A	Radiation (03CH11-HY)
RF Cable	HUBER + SUHNER	SUCOFLEX 104	MY9837/4PE	9kHz-30MHz	Mar. 13, 2019	Mar. 21, 2019~ Mar. 27, 2019	Mar. 12, 2020	Radiation (03CH11-HY)
RF Cable	HUBER + SUHNER	SUCOFLEX 102	MY2859/2	30MHz-40GHz	Mar. 13, 2019	Mar. 21, 2019~ Mar. 27, 2019	Mar. 12, 2020	Radiation (03CH11-HY)
RF Cable	HUBER + SUHNER	SUCOFLEX 104	MY9837/4PE	30M-18G	Mar. 13, 2019	Mar. 21, 2019~ Mar. 27, 2019	Mar. 12, 2020	Radiation (03CH11-HY)
RF Cable	HUBER + SUHNER	SUCOFLEX 102	MY4274/2	30MHz-40GHz	Mar. 13, 2019	Mar. 21, 2019~ Mar. 27, 2019	Mar. 12, 2020	Radiation (03CH11-HY)
Filter	Wainwright	WHKX8-5872.5-6750-18000-40ST	SN3	6.75GHz High Pass	Sep. 17, 2018	Mar. 21, 2019~ Mar. 27, 2019	Sep. 16, 2019	Radiation (03CH11-HY)
Filter	Wainwright	WLK4-1000-1530-8000-40SS	SN11	1G Low Pass	Sep. 16, 2018	Mar. 21, 2019~ Mar. 27, 2019	Sep. 15, 2019	Radiation (03CH11-HY)
Filter	Wainwright	WHKX12-2700-3000-18000-60SS	SN3	2.7G High Pass	Sep. 16, 2018	Mar. 21, 2019~ Mar. 27, 2019	Sep. 15, 2019	Radiation (03CH11-HY)



5 Uncertainty of Evaluation

Uncertainty of Conducted Emission Measurement (150 kHz ~ 30 MHz)

Measuring Uncertainty for a Level of Confidence of 95% ($U = 2Uc(y)$)	2.2
-------------------------------------------------------------------------	-----

Uncertainty of Radiated Emission Measurement (30 MHz ~ 1000 MHz)

Measuring Uncertainty for a Level of Confidence of 95% ($U = 2Uc(y)$)	5.2
-------------------------------------------------------------------------	-----

Uncertainty of Radiated Emission Measurement (1000 MHz ~ 18000 MHz)

Measuring Uncertainty for a Level of Confidence of 95% ($U = 2Uc(y)$)	5.5
-------------------------------------------------------------------------	-----

Uncertainty of Radiated Emission Measurement (18000 MHz ~ 40000 MHz)

Measuring Uncertainty for a Level of Confidence of 95% ($U = 2Uc(y)$)	5.2
-------------------------------------------------------------------------	-----



Appendix A. AC Conducted Emission Test Results

Test Engineer : Rick Lin and Jimmy Chang	Temperature : 24~26°C
	Relative Humidity : 51~53%

EUT Information

Report NO : 930415-06
 Test Mode : Mode 2
 Test Voltage : 120Vac/60Hz
 Phase : Line

Full Spectrum

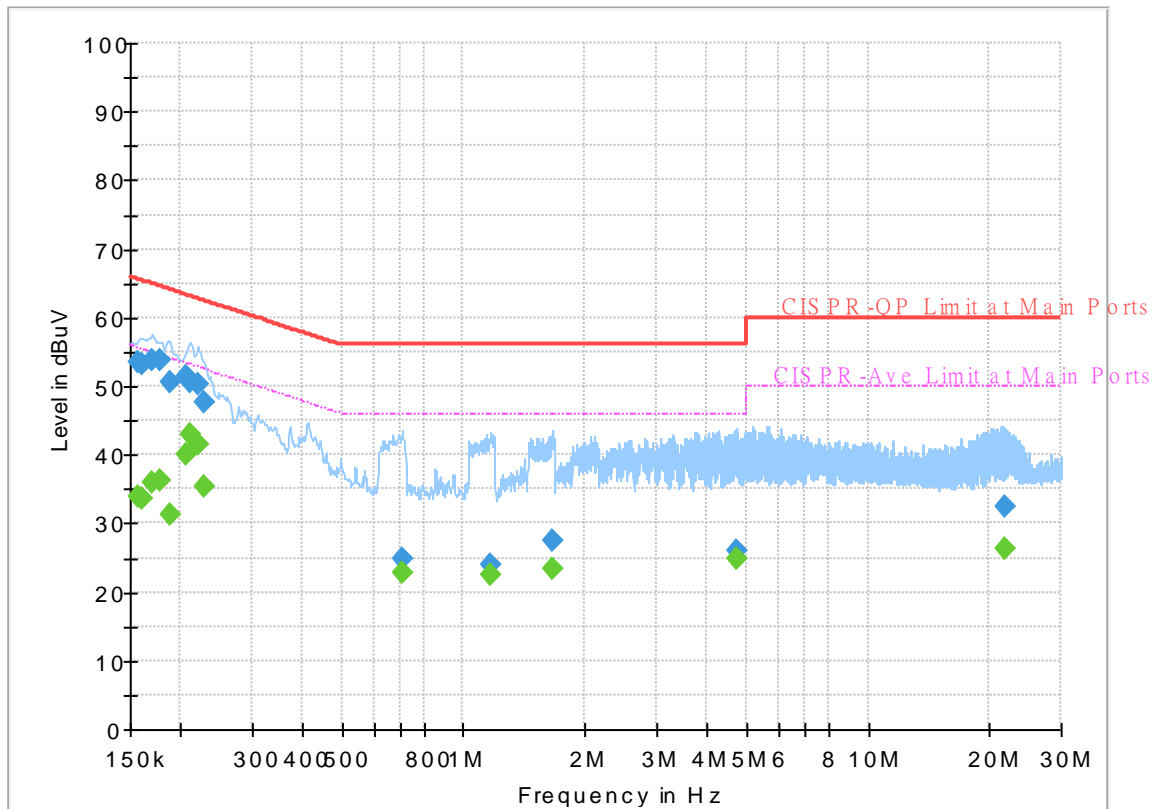

Final_Result

Frequency (MHz)	QuasiPeak (dBuV)	CAverage (dBuV)	Limit (dBuV)	Margin (dB)	Line	Filter	Corr. (dB)
0.156750	---	34.05	55.63	21.58	L1	OFF	19.5
0.156750	53.39	---	65.63	12.24	L1	OFF	19.5
0.161250	---	33.55	55.40	21.85	L1	OFF	19.5
0.161250	53.14	---	65.40	12.26	L1	OFF	19.5
0.170250	---	35.89	54.95	19.06	L1	OFF	19.5
0.170250	53.77	---	64.95	11.18	L1	OFF	19.5
0.177000	---	36.37	54.63	18.26	L1	OFF	19.5
0.177000	53.78	---	64.63	10.85	L1	OFF	19.5
0.188250	---	31.20	54.11	22.91	L1	OFF	19.5
0.188250	50.53	---	64.11	13.58	L1	OFF	19.5
0.206250	---	40.14	53.36	13.22	L1	OFF	19.5
0.206250	51.46	---	63.36	11.90	L1	OFF	19.5
0.210750	---	42.99	53.18	10.19	L1	OFF	19.5
0.210750	50.47	---	63.18	12.71	L1	OFF	19.5
0.219750	---	41.46	52.83	11.37	L1	OFF	19.5
0.219750	50.30	---	62.83	12.53	L1	OFF	19.5
0.228750	---	35.43	52.50	17.07	L1	OFF	19.5
0.228750	47.62	---	62.50	14.88	L1	OFF	19.5
0.705750	---	22.82	46.00	23.18	L1	OFF	19.6
0.705750	24.91	---	56.00	31.09	L1	OFF	19.6
1.164750	---	22.63	46.00	23.37	L1	OFF	19.6

1.164750	24.00	---	56.00	32.00	L1	OFF	19.6
1.662000	---	23.53	46.00	22.47	L1	OFF	19.6
1.662000	27.43	---	56.00	28.57	L1	OFF	19.6
4.724250	---	24.91	46.00	21.09	L1	OFF	19.7
4.724250	25.97	---	56.00	30.03	L1	OFF	19.7
21.864750	---	26.44	50.00	23.56	L1	OFF	20.3
21.864750	32.58	---	60.00	27.42	L1	OFF	20.3

EUT Information

Report NO : 930415-06
 Test Mode : Mode 2
 Test Voltage : 120Vac/60Hz
 Phase : Neutral

Full Spectrum

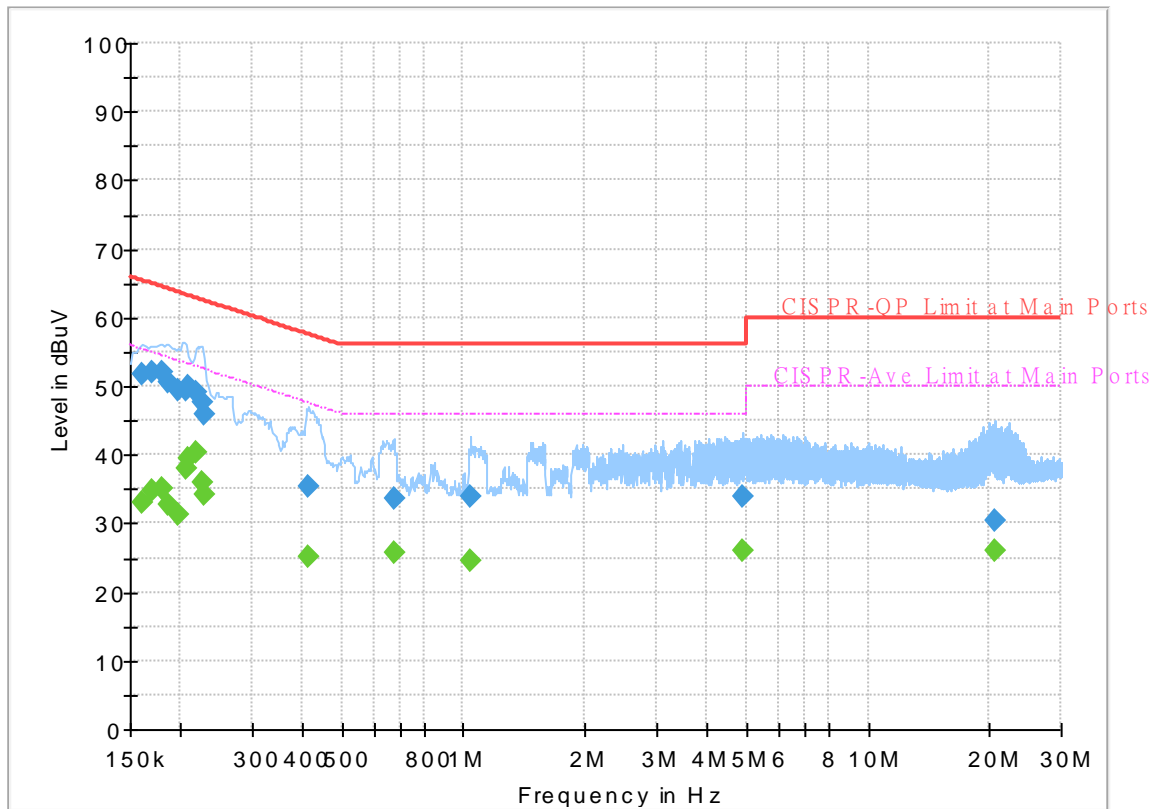

Final_Result

Frequency (MHz)	QuasiPeak (dBuV)	CAverage (dBuV)	Limit (dBuV)	Margin (dB)	Line	Filter	Corr. (dB)
0.161250	51.78	---	65.40	13.62	N	OFF	19.5
0.161250	---	32.95	55.40	22.45	N	OFF	19.5
0.170250	52.03	---	64.95	12.92	N	OFF	19.5
0.170250	---	34.78	54.95	20.17	N	OFF	19.5
0.179250	52.02	---	64.52	12.50	N	OFF	19.5
0.179250	---	34.95	54.52	19.57	N	OFF	19.5
0.186000	50.62	---	64.21	13.59	N	OFF	19.5
0.186000	---	32.64	54.21	21.57	N	OFF	19.5
0.197250	49.49	---	63.73	14.24	N	OFF	19.5
0.197250	---	31.20	53.73	22.53	N	OFF	19.5
0.206250	49.47	---	63.36	13.89	N	OFF	19.5
0.206250	---	38.07	53.36	15.29	N	OFF	19.5
0.208500	50.03	---	63.27	13.24	N	OFF	19.5
0.208500	---	39.48	53.27	13.79	N	OFF	19.5
0.217500	49.20	---	62.91	13.71	N	OFF	19.5
0.217500	---	40.45	52.91	12.46	N	OFF	19.5
0.226500	47.67	---	62.58	14.91	N	OFF	19.5
0.226500	---	35.85	52.58	16.73	N	OFF	19.5
0.228750	45.78	---	62.50	16.72	N	OFF	19.5
0.228750	---	34.18	52.50	18.32	N	OFF	19.5
0.415500	35.42	---	57.54	22.12	N	OFF	19.5

0.415500	---	25.19	47.54	22.35	N	OFF	19.5
0.674250	33.48	---	56.00	22.52	N	OFF	19.6
0.674250	---	25.71	46.00	20.29	N	OFF	19.6
1.043250	33.78	---	56.00	22.22	N	OFF	19.6
1.043250	---	24.68	46.00	21.32	N	OFF	19.6
4.884000	34.04	---	56.00	21.96	N	OFF	19.7
4.884000	---	26.01	46.00	19.99	N	OFF	19.7
20.586750	30.54	---	60.00	29.46	N	OFF	20.3
20.586750	---	26.09	50.00	23.91	N	OFF	20.3



Appendix B. Radiated Spurious Emission

Test Engineer :	Hao Shu and Ken Wu	Temperature :	21~26°C
		Relative Humidity :	50~56%

<WPC Charging Mode>

2.4GHz 2400~2483.5MHz

BT (Band Edge @ 3m)

BT	Note	Frequency (MHz)	Level (dBμV/m)	Over Limit (dB)	Limit Line (dBμV/m)	Read Level (dBμV)	Antenna Factor (dB/m)	Path Loss (dB)	Preamp Factor (dB)	Ant Pos (cm)	Table Pos (deg)	Peak Avg. (P/A)	Pol. (H/V)	
BT CH 78 2480MHz	*	2480	99.46	-	-	98.96	27.3	6.8	33.6	111	127	P	H	
	*	2480	74.67	-	-	-	-	-	-	-	-	A	H	
		2483.52	48.85	-25.15	74	48.34	27.3	6.81	33.6	111	127	P	H	
		2483.52	24.06	-29.94	54	-	-	-	-	-	-	A	H	
													H	
														H
	*	2480	100.41	-	-	99.91	27.3	6.8	33.6	137	310	P	V	
	*	2480	75.62	-	-	-	-	-	-	-	-	-	A	V
		2483.6	50.16	-23.84	74	49.65	27.3	6.81	33.6	137	310	P	V	
		2483.6	25.37	-28.63	54	-	-	-	-	-	-	-	A	V
														V
														V
Remark	1. No other spurious found. 2. All results are PASS against Peak and Average limit line.													



2.4GHz 2400~2483.5MHz
BT (Harmonic @ 3m)

BT	Note	Frequency (MHz)	Level (dBμV/m)	Over Limit (dB)	Limit Line (dBμV/m)	Read Level (dBμV)	Antenna Factor (dB/m)	Path Loss (dB)	Preamp Factor (dB)	Ant Pos (cm)	Table Pos (deg)	Peak Avg. (P/A)	Pol. (H/V)
BT CH 78 2480MHz		4960	39.57	-34.43	74	56.08	31.32	10.68	58.51	100	0	P	H
		4960	14.78	-39.22	54	-	-	-	-	-	-	A	H
		7440	43.67	-30.33	74	52.77	36.48	13.08	58.66	100	0	P	H
		7440	18.88	-35.12	54	-	-	-	-	-	-	A	H
		4960	39.85	-34.15	74	56.36	31.32	10.68	58.51	100	0	P	V
		4960	15.06	-38.94	54	-	-	-	-	-	-	A	V
		7440	45.06	-28.94	74	54.16	36.48	13.08	58.66	100	0	P	V
		7440	20.27	-33.73	54	-	-	-	-	-	-	A	V
Remark	1. No other spurious found. 2. All results are PASS against Peak and Average limit line.												



<PMA Charging Mode>
2.4GHz 2400~2483.5MHz
BT (Band Edge @ 3m)

BT	Note	Frequency (MHz)	Level (dBμV/m)	Over Limit (dB)	Limit Line (dBμV/m)	Read Level (dBμV)	Antenna Factor (dB/m)	Path Loss (dB)	Preamp Factor (dB)	Ant Pos (cm)	Table Pos (deg)	Peak Avg. (P/A)	Pol. (H/V)	
BT CH 78 2480MHz	*	2480	99.51	-	-	99.01	27.3	6.8	33.6	107	277	P	H	
	*	2480	74.72	-	-	-	-	-	-	-	-	A	H	
		2483.52	49.05	-24.95	74	48.54	27.3	6.81	33.6	107	277	P	H	
		2483.52	24.26	-29.74	54	-	-	-	-	-	-	A	H	
													H	
													H	
	*	2480	99.05	-	-	98.55	27.3	6.8	33.6	367	131	P	V	
	*	2480	74.26	-	-	-	-	-	-	-	-	-	A	V
		2483.68	48.86	-25.14	74	48.35	27.3	6.81	33.6	367	131	P	V	
		2483.68	24.07	-29.93	54	-	-	-	-	-	-	A	V	
													V	
													V	
Remark	1. No other spurious found. 2. All results are PASS against Peak and Average limit line.													

2.4GHz 2400~2483.5MHz
BT (Harmonic @ 3m)

BT	Note	Frequency (MHz)	Level (dBμV/m)	Over Limit (dB)	Limit Line (dBμV/m)	Read Level (dBμV)	Antenna Factor (dB/m)	Path Loss (dB)	Preamp Factor (dB)	Ant Pos (cm)	Table Pos (deg)	Peak Avg. (P/A)	Pol. (H/V)
BT CH 78 2480MHz		4960	39.5	-34.5	74	56.01	31.32	10.68	58.51	100	0	P	H
		4960	14.71	-39.29	54	-	-	-	-	-	-	A	H
		7440	43.69	-30.31	74	52.79	36.48	13.08	58.66	100	0	P	H
		7440	18.9	-35.1	54	-	-	-	-	-	-	A	H
		4960	39.93	-34.07	74	56.44	31.32	10.68	58.51	100	0	P	V
		4960	15.14	-38.86	54	-	-	-	-	-	-	A	V
		7440	45.11	-28.89	74	54.21	36.48	13.08	58.66	100	0	P	V
		7440	20.32	-33.68	54	-	-	-	-	-	-	A	V
Remark	1. No other spurious found. 2. All results are PASS against Peak and Average limit line.												



Note symbol

*	Fundamental Frequency which can be ignored. However, the level of any unwanted emissions shall not exceed the level of the fundamental frequency.
!	Test result is over limit line.
P/A	Peak or Average
H/V	Horizontal or Vertical



A calculation example for radiated spurious emission is shown as below:

BT	Note	Frequency	Level	Over	Limit	Read	Antenna	Path	Preamp	Ant	Table	Peak	Pol.
		(MHz)	(dBμV/m)	(dB)	Line	Level	Factor	Loss	Factor	Pos	Pos	Avg.	
					(dBμV/m)	(dBμV)	(dB/m)	(dB)	(dB)	(cm)	(deg)	(P/A)	(H/V)
BT		2390	55.45	-18.55	74	54.51	32.22	4.58	35.86	103	308	P	H
CH 00		2390	43.54	-10.46	54	42.6	32.22	4.58	35.86	103	308	A	H
2402MHz													

1. Path Loss(dB) = Cable loss(dB) + Filter loss(dB) + Attenuator loss(dB)
2. Level(dBμV/m) =
Antenna Factor(dB/m) + Path Loss(dB) + Read Level(dBμV) - Preamp Factor(dB)
3. Over Limit(dB) = Level(dBμV/m) – Limit Line(dBμV/m)

For Peak Limit @ 2390MHz:

1. Level(dBμV/m)
= Antenna Factor(dB/m) + Path Loss(dB) + Read Level(dBμV) - Preamp Factor(dB)
= 32.22(dB/m) + 4.58(dB) + 54.51(dBμV) – 35.86 (dB)
= 55.45 (dBμV/m)
2. Over Limit(dB)
= Level(dBμV/m) – Limit Line(dBμV/m)
= 55.45(dBμV/m) – 74(dBμV/m)
= -18.55(dB)

For Average Limit @ 2390MHz:

1. Level(dBμV/m)
= Antenna Factor(dB/m) + Path Loss(dB) + Read Level(dBμV) - Preamp Factor(dB)
= 32.22(dB/m) + 4.58(dB) + 42.6(dBμV) – 35.86 (dB)
= 43.54 (dBμV/m)
2. Over Limit(dB)
= Level(dBμV/m) – Limit Line(dBμV/m)
= 43.54(dBμV/m) – 54(dBμV/m)
= -10.46(dB)

Both peak and average measured complies with the limit line, so test result is “PASS”.



Appendix C. Radiated Spurious Emission Plots

Test Engineer :	Hao Shu and Ken Wu	Temperature :	21~26°C
		Relative Humidity :	50~56%

<WPC Charging Mode>

2.4GHz 2400~2483.5MHz

BT (Band Edge @ 3m)

BT	2.4GHz 2400~2483.5MHz Band Edge @ 3m	
	BT CH78 2480MHz	
	Horizontal	Fundamental
Peak	<p>Site : 03CH11-HY Condition : PEAK_BE_74 3m HORN 91200-HF HORIZONTAL RBW:1000.000KHz VBW:3000.000KHz SWT:Auto Detector : Peak Project : 930415-06</p>	<p>Site : 03CH11-HY Condition : PEAK_74 3m HORN 91200-HF HORIZONTAL RBW:1000.000KHz VBW:3000.000KHz SWT:Auto Detector : Peak Project : 930415-06</p>

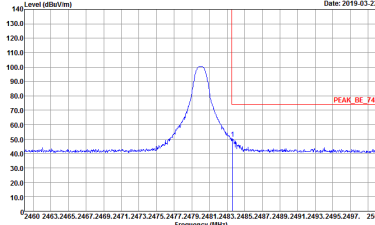
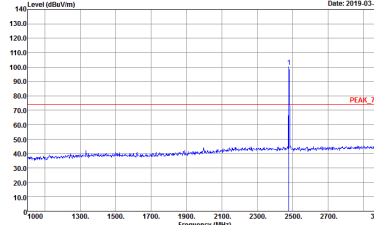

BT	2.4GHz 2400~2483.5MHz Band Edge @ 3m	
BT CH78 2480MHz		
	Vertical	Fundamental
Peak	 <p>Date: 2019-03-22</p> <p>Site : 03CH11-HY Condition : PEAK_BE_74 3m HORN 91200-HF VERTICAL RBW:1000.000KHz VBW:3000.000KHz SWT:Auto Detector : Peak Project : 930415-06</p>	 <p>Date: 2019-03-22</p> <p>Site : 03CH11-HY Condition : PEAK_74 3m HORN 91200-HF VERTICAL RBW:1000.000KHz VBW:3000.000KHz SWT:Auto Detector : Peak Project : 930415-06</p>



2.4GHz 2400~2483.5MHz
BT (Harmonic @ 3m)

BT	2.4GHz 2400~2483.5MHz Harmonic @ 3m	
	BT CH78 2480MHz	
	Horizontal	Vertical
Peak Avg.	<p>Site : 03CH11-HY Condition : PEAK_74 3m HORN 91200-HF HORIZONTAL Detector : Peak Project : 930415-06</p>	<p>Site : 03CH11-HY Condition : PEAK_74 3m HORN 91200-HF VERTICAL Detector : Peak Project : 930415-06</p>

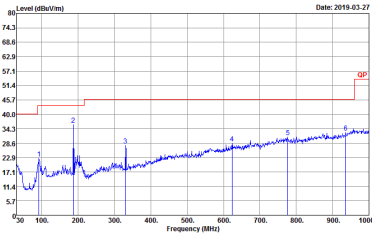
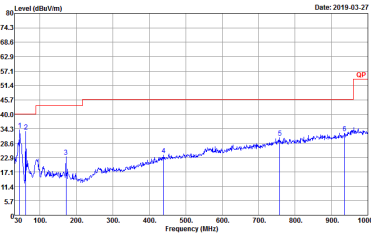

Emission below 1GHz
2.4GHz BT (LF)

BT	2.4GHz 2400~2483.5MHz	
BT LF		
Horizontal		Vertical
QP / Peak	 <p data-bbox="430 761 686 817">Site : 03CH11-HY Condition : QP 3m BE-LO6 6111D-LF_ETC HORIZONTAL Detector : Peak Project : 930415-06</p>	 <p data-bbox="906 761 1161 817">Site : 03CH11-HY Condition : QP 3m BE-LO6 6111D-LF_ETC VERTICAL Detector : Peak Project : 930415-06</p>

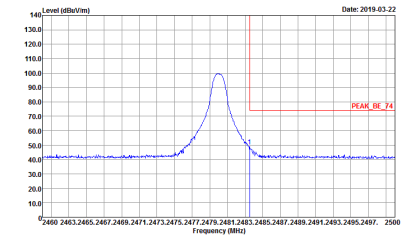
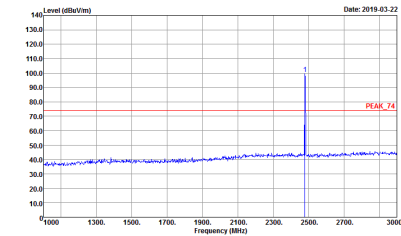

<PMA Charging Mode>
2.4GHz 2400~2483.5MHz
BT (Band Edge @ 3m)

BT	2.4GHz 2400~2483.5MHz Band Edge @ 3m	
BT CH78 2480MHz		
Horizontal		Fundamental
Peak	 <p>Date: 2019-03-22</p> <p>PEAK_BE_74</p> <p>Site : 03CH11-HY Condition : PEAK_BE_74 3m HORN 91200-HF HORIZONTAL RBW:1000.000KHz VBW:3000.000KHz SWT:Auto Detector : Peak Project : 930415-06</p>	 <p>Date: 2019-03-22</p> <p>PEAK_74</p> <p>Site : 03CH11-HY Condition : PEAK_74 3m HORN 91200-HF HORIZONTAL RBW:1000.000KHz VBW:3000.000KHz SWT:Auto Detector : Peak Project : 930415-06</p>

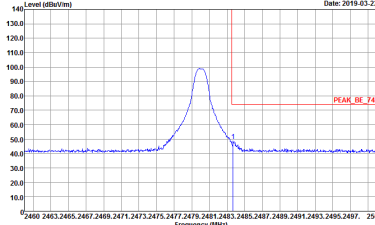
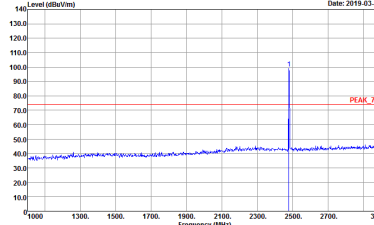

BT	2.4GHz 2400~2483.5MHz Band Edge @ 3m	
BT CH78 2480MHz		
	Vertical	Fundamental
Peak	 <p>Date: 2019-03-22</p> <p>Site : 03CH11-HY Condition : PEAK_BE_74 3m HORN 91200-HF VERTICAL RBW:1000.000KHz VBW:3000.000KHz SWT:Auto Detector : Peak Project : 930415-06</p>	 <p>Date: 2019-03-22</p> <p>Site : 03CH11-HY Condition : PEAK_74 3m HORN 91200-HF VERTICAL RBW:1000.000KHz VBW:3000.000KHz SWT:Auto Detector : Peak Project : 930415-06</p>

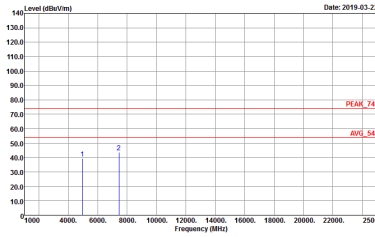
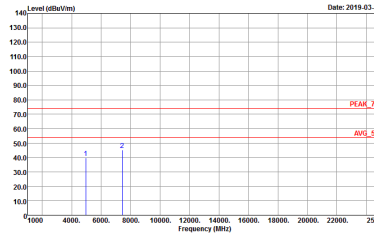

2.4GHz 2400~2483.5MHz
BT (Harmonic @ 3m)

BT	2.4GHz 2400~2483.5MHz Harmonic @ 3m	
BT CH78 2480MHz		
Horizontal		Vertical
<p>Peak Avg.</p>	 <p>Site : 03CH11-HY Condition : PEAK_74 3m HORN 91200-HF HORIZONTAL Detector : Peak Project : 930415-06</p>	 <p>Site : 03CH11-HY Condition : PEAK_74 3m HORN 91200-HF VERTICAL Detector : Peak Project : 930415-06</p>

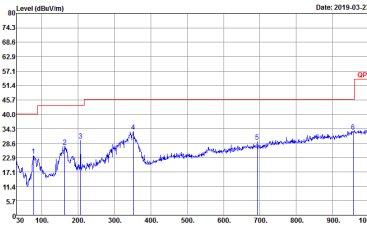
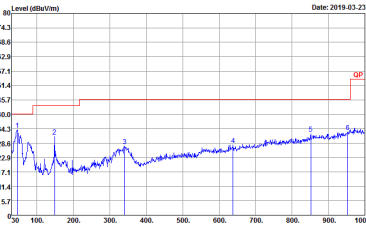

Emission below 1GHz
2.4GHz BT (LF)

BT	2.4GHz 2400~2483.5MHz	
BT LF		
Horizontal		Vertical
QP / Peak	 <p>Site : 03CH11-HY Condition : QP 3m BE-LO6 6111D-LF_ETC HORIZONTAL Detector : Peak Project : 930415-06</p>	 <p>Site : 03CH11-HY Condition : QP 3m BE-LO6 6111D-LF_ETC VERTICAL Detector : Peak Project : 930415-06</p>

Appendix D. Duty Cycle Plots

<WPC Charging Mode>

DH5 on time (One Pulse) Plot on Channel 39

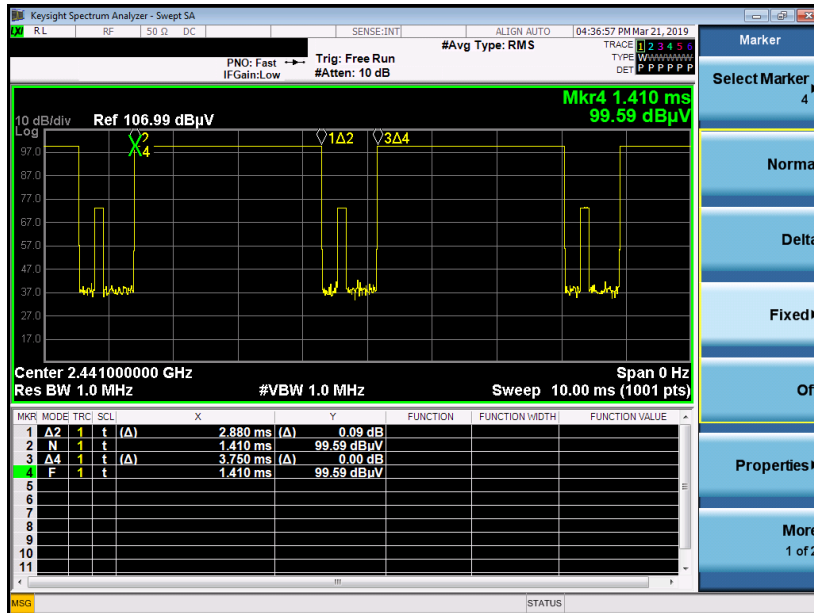

on time (Count Pulses) Plot on Channel 39

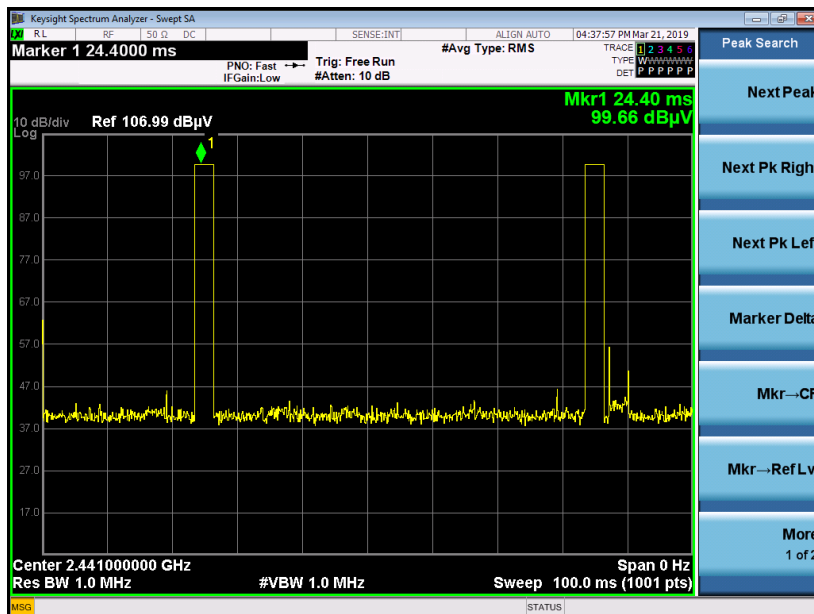

Note:

1. Worst case Duty cycle = on time/100 milliseconds = $2 * 2.88 / 100 = 5.76 \%$
2. Worst case Duty cycle correction factor = $20 * \log(\text{Duty cycle}) = -24.79 \text{ dB}$
3. DH5 has the highest duty cycle worst case and is reported.

<PMA Charging Mode>

DH5 on time (One Pulse) Plot on Channel 39

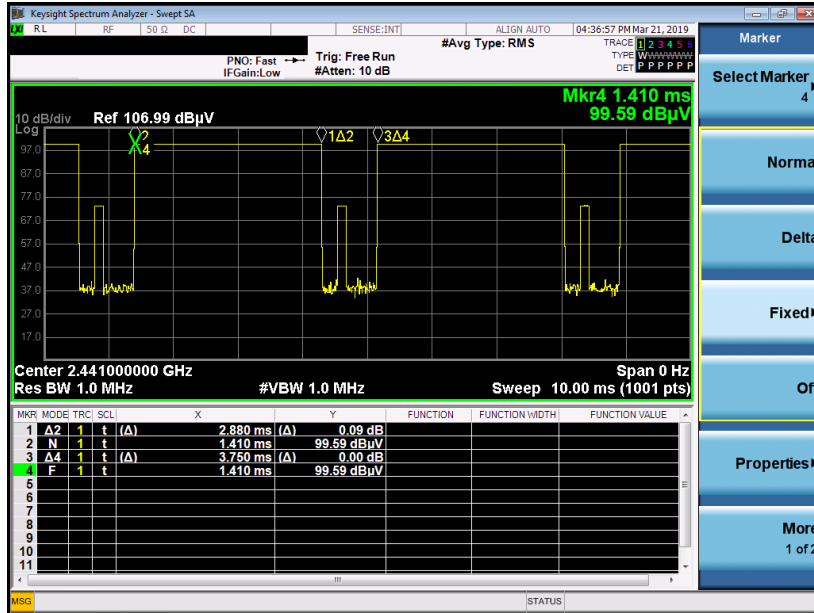

on time (Count Pulses) Plot on Channel 39

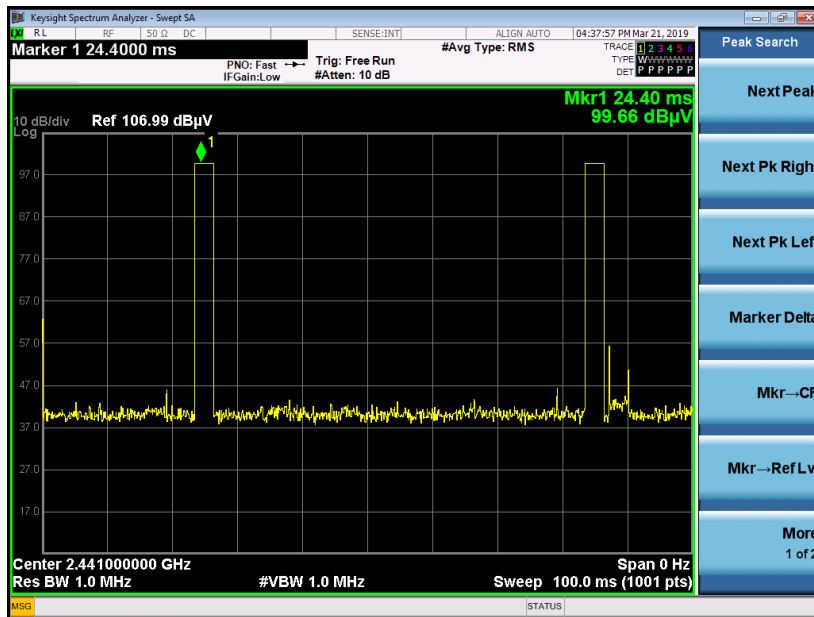

Note:

1. Worst case Duty cycle = on time/100 milliseconds = 2 * 2.88 / 100 = 5.76 %
2. Worst case Duty cycle correction factor = 20*log(Duty cycle) = -24.79 dB
3. DH5 has the highest duty cycle worst case and is reported.



Duty Cycle Correction Factor Consideration for AFH mode:

Bluetooth normal hopping rate is 1600Hz and reduced to 800Hz in AFH mode; due to the reduced number of hopping frequencies, with the same packet configuration the dwell time in each channel frequency within 100msec period is longer in AFH mode than normal mode.

In AFH mode, the minimum hopping frequencies are 20, to get the longest dwell time DH5 packet is observed; the period to have DH5 packet completing one hopping sequence is

$$2.88 \text{ ms} \times 20 \text{ channels} = 57.6 \text{ ms}$$

There cannot be 2 complete hopping sequences within 100ms period, considering the random hopping behavior, maximum 2 hops can be possibly observed within the period. $[100\text{ms} / 57.6\text{ms}] = 2$ hops

Thus, the maximum possible ON time:

$$2.88 \text{ ms} \times 2 = 5.76 \text{ ms}$$

Worst case Duty Cycle Correction factor, which is derived from the maximum possible ON time,

$$20 \times \log(5.76 \text{ ms}/100\text{ms}) = -24.79 \text{ dB}$$

—————THE END—————