



FCC RF Test Report

APPLICANT : Motorola Mobility LLC
EQUIPMENT : Mobile Cellular Phone
BRAND NAME : Motorola
MODEL NAME : XT1920-16
FCC ID : IHDT56XH1
STANDARD : 47 CFR Part 2, 22(H), 27(M)
CLASSIFICATION : PCS Licensed Transmitter Held to Ear (PCE)

The product was received on Apr. 12, 2018 and completely tested on May 15, 2018. We, Sporton International (Kunshan) Inc., would like to declare that the tested sample has been evaluated in accordance with the procedures given in ANSI C63.26-2015 and shown compliance with the applicable technical standards.

The test results in this report apply exclusively to the tested model / sample. Without written approval of Sporton International (Kunshan) Inc., the test report shall not be reproduced except in full.



Approved by: James Huang / Manager

Sporton International (Kunshan) Inc.

**No.3-2 Ping-Xiang Rd, Kunshan Development Zone Kunshan City Jiangsu Province 215335
China**



TABLE OF CONTENTS

REVISION HISTORY... 3
SUMMARY OF TEST RESULT ... 4
1 GENERAL DESCRIPTION ... 5
1.1 Applicant ... 5
1.2 Manufacturer ... 5
1.3 Product Feature of Equipment Under Test ... 5
1.4 Product Specification of Equipment Under Test ... 6
1.5 Modification of EUT ... 6
1.6 Specification of Accessory ... 7
1.7 Re-use of Measured Data ... 8
1.8 Maximum ERP/EIRP Power, Frequency Tolerance, and Emission Designator ... 9
1.9 Testing Location ... 10
1.10 Applicable Standards ... 10
2 TEST CONFIGURATION OF EQUIPMENT UNDER TEST ... 11
2.1 Test Mode ... 11
2.2 Connection Diagram of Test System ... 12
2.3 Support Unit used in test configuration and system ... 12
2.4 Measurement Results Explanation Example ... 12
2.5 Frequency List of Low/Middle/High Channels ... 13
3 CONDUCTED TEST ITEMS ... 15
3.1 Measuring Instruments ... 15
3.2 Test Setup ... 15
3.3 Test Result of Conducted Test ... 15
3.4 Conducted Output Power and ERP/EIRP ... 16
3.5 Peak-to-Average Ratio ... 17
3.6 Occupied Bandwidth ... 18
3.7 Conducted Band Edge ... 19
3.8 Conducted Spurious Emission ... 21
3.9 Frequency Stability ... 22
4 RADIATED TEST ITEMS ... 23
4.1 Measuring Instruments ... 23
4.2 Test Setup ... 23
4.3 Test Result of Radiated Test ... 23
4.4 Radiated Spurious Emission ... 24
5 LIST OF MEASURING EQUIPMENT ... 25
6 UNCERTAINTY OF EVALUATION ... 26
APPENDIX A. TEST RESULTS OF CONDUCTED TEST
APPENDIX B. TEST RESULTS OF RADIATED TEST
APPENDIX C. TEST SETUP PHOTOGRAPHS
APPENDIX D. REFERENCE REPORT



SUMMARY OF TEST RESULT

Report Section	FCC Rule	Description	Limit	Result	Remark
3.4	§2.1046	Conducted Output Power	Reporting Only	PASS	-
	§22.913(a)(5)	Effective Radiated Power (Band 5)	ERP < 7 Watt	PASS	-
	§27.50(h)(2)	Equivalent Isotropic Radiated Power (Band 7) (Band 38) (Band 41)	EIRP < 2Watt	PASS	-
3.5	N/A	Peak-to-Average Ratio	<13 dB	PASS	-
3.6	§2.1049	Occupied Bandwidth	Reporting Only	PASS	-
3.7	§27.53(m)(4)	Conducted Band Edge Measurement (Band 7) (Band 38) (Band 41)	§27.53(m)(4)	PASS	-
3.8	§2.1051 §27.53(m)(4)	Conducted Spurious Emission (Band 7) (Band 38) (Band 41)	< 55+10log ₁₀ (P[Watts])	PASS	-
3.9	§2.1055 §27.54	Frequency Stability Temperature & Voltage	Within Authorized Band	PASS	-
4.4	§2.1053 §22.917(a)	Radiated Spurious Emission (Band 5)	< 43+10log ₁₀ (P[Watts])	PASS	Under limit 25.02 dB at 7580.000 MHz
	§2.1053 §27.53(m)(4)	Radiated Spurious Emission (Band 7) (Band 38) (Band 41)	< 55+10log ₁₀ (P[Watts])		



1 General Description

1.1 Applicant

Motorola Mobility LLC
222 W, Merchandise Mart Plaza, Chicago IL 60654 USA

1.2 Manufacturer

Motorola Mobility LLC
222 W, Merchandise Mart Plaza, Chicago IL 60654 USA

1.3 Product Feature of Equipment Under Test

Product Feature	
Equipment	Mobile Cellular Phone
Brand Name	Motorola
Model Name	XT1920-16
FCC ID	IHDT56XH1
EUT supports Radios application	GSM/GPRS/EGPRS/WCDMA/HSPA/DC-HSDPA/ HSPA+(16QAM uplink is not supported)/LTE WLAN 2.4GHz 802.11b/g/n HT20 Bluetooth v3.0 + EDR/Bluetooth v4.0 LE/ Bluetooth v4.1 LE/Bluetooth v4.2 LE
IMEI Code	Conducted: 355531090019071/355531090019089 Radiation: 355531090019550/355531090019568 for LTE Band 5/7/38 355531090019295/355531090019303 for LTE Band 41
HW Version	DVT2
SW Version	OPG28.25
EUT Stage	Identical Prototype

Remark: The above EUT's information was declared by manufacturer. Please refer to the specifications or user's manual for more detailed description.



1.4 Product Specification of Equipment Under Test

Standards-related Product Specification	
Tx Frequency	LTE Band 5 : 824.7 MHz ~ 848.3 MHz LTE Band 7 : 2502.5 MHz ~ 2567.5 MHz LTE Band 38 : 2572.5MHz ~ 2617.5MHz LTE Band 41 : 2537.5 MHz ~ 2652.5 MHz
Rx Frequency	LTE Band 5 : 869.7 MHz ~ 893.3 MHz LTE Band 7 : 2622.5MHz ~ 2687.5 MHz LTE Band 38 : 2572.5MHz ~ 2617.5MHz LTE Band 41 : 2537.5 MHz ~ 2652.5 MHz
Bandwidth	LTE Band 5 : 1.4MHz / 3MHz / 5MHz / 10MHz LTE Band 7 : 5MHz/ 10MHz / 15MHz / 20MHz LTE Band 38 : 5MHz / 10MHz / 15MHz / 20MHz LTE Band 41 : 5MHz / 10MHz / 15MHz / 20MHz
Maximum Output Power to Antenna	LTE Band 5 : 23.27 dBm LTE Band 7 : 23.24 dBm LTE Band 38 : 23.13 dBm LTE Band 41 : 23.16 dBm
Antenna Gain	LTE Band 5 : -5.4 dBi LTE Band 7 : -1.1 dBi LTE Band 38 : -4.4 dBi LTE Band 41 : -4.5 dBi
Type of Modulation	QPSK / 16QAM

1.5 Modification of EUT

No modifications are made to the EUT during all test items.



1.6 Specification of Accessory

Specification of Accessory				
AC Adapter 1(EU)	Brand Name	Motorola (Acbel)	Model Name	C-P57 SPN5948A
	Power Rating	I/P: 100 - 240 Vac, 0.13A,50/60HZ O/P: 5Vdc 1000mA		
AC Adapter 1(UK)	Brand Name	Motorola (Acbel)	Model Name	C-P58 SPN5950A
	Power Rating	I/P: 100 - 240 Vac, 0.13A,50/60HZ O/P: 5Vdc 1000mA		
AC Adapter 2(EU)	Brand Name	Motorola (Chenyang)	Model Name	C-P57 SPN5985A
	Power Rating	I/P: 100 - 240 Vac, 0.13A,50/60HZ O/P: 5Vdc 1000mA		
AC Adapter 2(UK)	Brand Name	Motorola (Chenyang)	Model Name	C-P58 SPN5981A
	Power Rating	I/P: 100 - 240 Vac, 0.13A,50/60HZ O/P: 5Vdc 1000mA		
Battery	Brand Name	Motorola (Amperex)	Model Name	JE30
	Power Rating	3.8Vdc,2000/2120mAh		
Earphone 1	Brand Name	Motorola(JuWei)	Model Name	711411000731
	Signal Line Type	1.1 meter, non-shielded cable, without ferrite core		
Earphone 2	Brand Name	Motorola(New Leader)	Model Name	711411000711
	Signal Line Type	1.1 meter, non-shielded cable, without ferrite core		
USB Cable	Brand Name	Motorola (Saibao)	Model Name	711310002261
	Signal Line Type	1.0 meter, non-shielded cable, without ferrite core		



1.7 Re-use of Measured Data

1.7.1 Introduction Section

This application re-uses data collected on a similar device. The subject device of this application (Model: XT1920-16, FCC ID: IHDT56XH1) is electrically identical to the reference device (Model: XT1920-18, XT1920-19, FCC ID: IHDT56XH2) for the portions of the circuitry corresponding to the data being re-used, as treated by KDB Publication 484596 D01.

1.7.2 Difference Section

For details concerning the similarity with respect to component placement, mechanical/electrical design etc., some difference of population/depoulation to enable support of different cellular bands, please refer to the Product Equality Declaration.

The re-used RF data includes the following bands provided in Appendix D (Sporton RF Report No. FG841203B for the reference device Model: XT1920-18, XT1920-19, FCC ID: IHDT56XH2):

1.7.3 Spot Check Verification Data Section

In order to confirm hardware similarity of the subject device with the reference device, spot check measurements were performed on the subject device for Conducted Power based on the judgement of applicant, the test result were consistent with FCC ID: IHDT56XH2, all the conducted test items from the original model are representative for the variant model of LTE Band 5/7 (Except Power/ERP/EIRP are re-tested).

Note: LTE Band 38/41 are full test.

Test Item	Mode	IHDT56XH2 Worst Result	IHDT56XH1 Worst Result	Difference (dB)
Average Conducted Power (dBm)	LTE Band 5	23.26	23.27	0.01
	LTE Band 7	23.43	23.24	0.19

1.7.4 Reference detail Section

Equipment Class	Reference FCC ID	Folder Test	Report Title/Section
PCE (LTE)	IHDT56XH2	Part22H.24E.27L.27M (FG841203B)	All conducted sections applicable for LTE Band 5/7 except Power/ERP/EIRP



1.8 Maximum ERP/EIRP Power, Frequency Tolerance, and Emission Designator

LTE Band 5		QPSK			16QAM		
BW (MHz)	Frequency Range (MHz)	Emission Designator (99%OBW)	Frequency Tolerance (ppm)	Maximum ERP(W)	Emission Designator (99%OBW)	Frequency Tolerance (ppm)	Maximum ERP(W)
1.4	824.7 ~ 848.3	-	-	0.0351	-	-	0.0291
3	825.5 ~ 847.5	-	-	0.0345	-	-	0.0296
5	826.5 ~ 846.5	-	-	0.0356	-	-	0.0299
10	829.0 ~ 844.0	-	-	0.0373	-	-	0.0291
LTE Band 7		QPSK			16QAM		
BW (MHz)	Frequency Range (MHz)	Emission Designator (99%OBW)	Frequency Tolerance (ppm)	Maximum EIRP(W)	Emission Designator (99%OBW)	Frequency Tolerance (ppm)	Maximum EIRP(W)
5	2502.5 ~ 2567.5	-	-	0.1528	-	-	0.1300
10	2505.0 ~ 2565.0	-	-	0.1552	-	-	0.1303
15	2507.5 ~ 2562.5	-	-	0.1552	-	-	0.1346
20	2510.0 ~ 2560.0	-	-	0.1637	-	-	0.1309
LTE Band 38		QPSK			16QAM		
BW (MHz)	Frequency Range (MHz)	Emission Designator (99%OBW)	Frequency Tolerance (ppm)	Maximum EIRP(W)	Emission Designator (99%OBW)	Frequency Tolerance (ppm)	Maximum EIRP(W)
5	2572.5 ~ 2617.5	4M51G7D	-	0.0700	4M49W7D	-	0.0562
10	2575.0 ~ 2615.0	9M05G7D	0.0018	0.0714	9M03W7D	-	0.0565
15	2577.5 ~ 2612.5	13M5G7D	-	0.0716	13M5W7D	-	0.0570
20	2580.0 ~ 2610.0	18M4G7D	-	0.0746	18M3W7D	-	0.0582
LTE Band 41		QPSK			16QAM		
BW (MHz)	Frequency Range (MHz)	Emission Designator (99%OBW)	Frequency Tolerance (ppm)	Maximum EIRP(W)	Emission Designator (99%OBW)	Frequency Tolerance (ppm)	Maximum EIRP(W)
5	2537.5 ~ 2652.5	4M50G7D	-	0.0711	4M51W7D	-	0.0530
10	2540.0 ~ 2650.0	9M03G7D	0.0023	0.0716	9M05W7D	-	0.0522
15	2542.5 ~ 2647.5	13M4G7D	-	0.0733	13M5W7D	-	0.0525
20	2545.0 ~ 2645.0	18M4G7D	-	0.0735	18M3W7D	-	0.0537



1.9 Testing Location

Sporton International (Kunshan) Inc. is accredited to ISO 17025 by National Voluntary Laboratory Accreditation Program (NVLAP code: 600155-0) and the FCC designation No. is CN5013.

Test Site	Sporton International (Kunshan) Inc.		
Test Site Location	No.3-2 Ping-Xiang Rd, Kunshan Development Zone Kunshan City Jiangsu Province 215335 China TEL : +86-512-57900158 FAX : +86-512-57900958		
Test Site No.	Sporton Site No.		FCC Test Firm Registration No.
	TH01-KS	03CH03-KS	630927

Note: The test site complies with ANSI C63.4 2014 requirement.

1.10 Applicable Standards

According to the specifications of the manufacturer, the EUT must comply with the requirements of the following standards:

- ♦ 47 CFR Part 2, 22(H), 27(M)
- ♦ ANSI C63.26-2015
- ♦ FCC KDB 971168 D01 Power Meas License Digital Systems v03r01
- ♦ FCC KDB 412172 D01 Determining ERP and EIRP v01r01

Remark:

1. All test items were verified and recorded according to the standards and without any deviation during the test.
2. This EUT has also been tested and complied with the requirements of FCC Part 15, Subpart B, recorded in a separate test report.



2 Test Configuration of Equipment Under Test

2.1 Test Mode

Antenna port conducted and radiated test items listed below are performed according to KDB 971168 D01 Power Meas License Digital Systems v03r01 with maximum output power.

Radiated measurements are performed by rotating the EUT in three different orthogonal test planes to find the maximum emission.

Test Items	Band	Bandwidth (MHz)						Modulation			RB #			Test Channel		
		1.4	3	5	10	15	20	QPSK	16QAM	64QAM	1	Half	Full	L	M	H
Max. Output Power	5	v	v	v	v	-	-	v	v	-	v	v	v	v	v	v
	7	-	-	v	v	v	v	v	v	-	v	v	v	v	v	v
	38	-	-	v	v	v	v	v	v	-	v	v	v	v	v	v
	41	-	-	v	v	v	v	v	v	-	v	v	v	v	v	v
Peak-to-Average Ratio	38	-	-				v	v	v	-	v		v	v	v	v
	41	-	-				v	v	v	-	v		v	v	v	v
26dB and 99% Bandwidth	38	-	-	v	v	v	v	v	v	-			v	v	v	v
	41	-	-	v	v	v	v	v	v	-			v	v	v	v
Conducted Band Edge	38	-	-	v	v	v	v	v	v	-	v		v	v		v
	41	-	-	v	v	v	v	v	v	-	v		v	v		v
Conducted Spurious Emission	38	-	-	v	v	v	v	v	v	-	v			v	v	v
	41	-	-	v	v	v	v	v	v	-	v			v	v	v
Frequency Stability	38	-	-		v			v		-			v		v	
	41	-	-		v			v		-			v		v	
E.R.P / E.I.R.P	5	v	v	v	v	-	-	v	v	-	v			v	v	v
	7	-	-	v	v	v	v	v	v	-	v			v	v	v
	38	-	-	v	v	v	v	v	v	-	v			v	v	v
	41	-	-	v	v	v	v	v	v	-	v			v	v	v
Radiated Spurious Emission	5	Worst Case													v	
	7	Worst Case													v	
	38	Worst Case													v	
	41	Worst Case													v	
Note	<ol style="list-style-type: none"> The mark "v" means that this configuration is chosen for testing The mark "-" means that this bandwidth is not supported. The device is investigated from 30MHz to 10 times of fundamental signal for radiated spurious emission test under different RB size/offset and modulations in exploratory test. Subsequently, only the worst case emissions are reported. 															

2.2 Connection Diagram of Test System

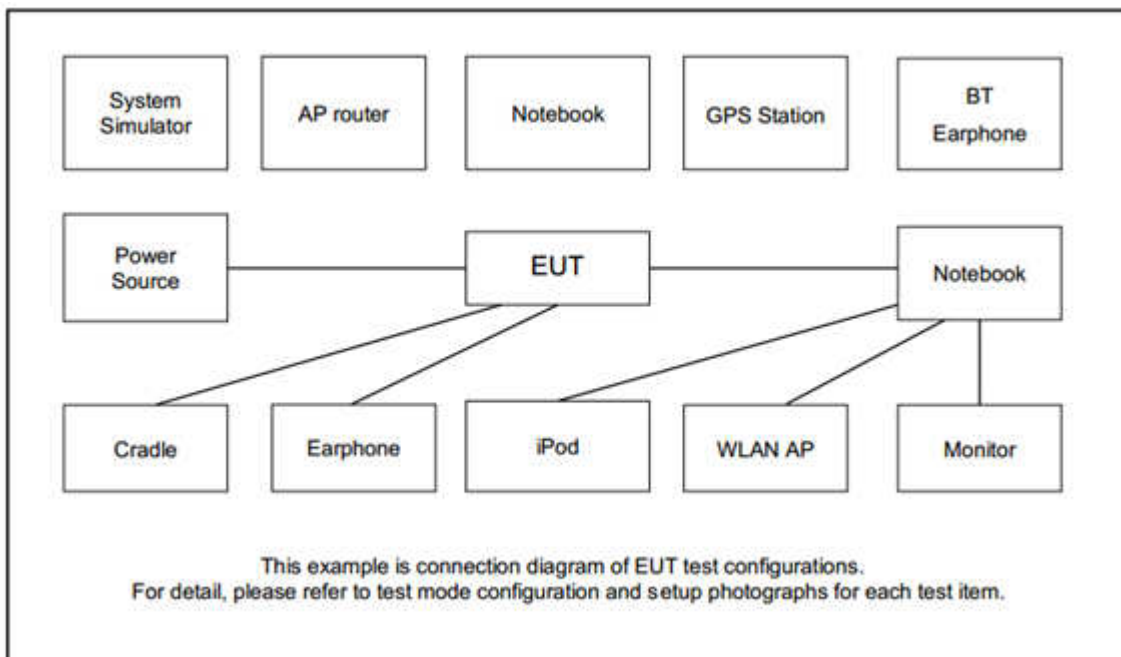

2.3 Support Unit used in test configuration and system

Item	Equipment	Trade Name	Model No.	FCC ID	Data Cable	Power Cord
1.	Power Supply	GW	GPS-3030D	N/A	N/A	Unshielded, 1.8 m
2.	LTE Base Station	Anritsu	MT8820C	N/A	N/A	Unshielded, 1.8 m

2.4 Measurement Results Explanation Example

For all conducted test items:

The offset level is set in the spectrum analyzer to compensate the RF cable loss between EUT conducted output port and spectrum analyzer. With the offset compensation, the spectrum analyzer reading level is exactly the EUT RF output level.

The spectrum analyzer offset is derived from RF cable loss.

Offset = RF cable loss.

Following shows an offset computation example with cable loss 5.5 dB.

Example :

$$\begin{aligned} \text{Offset(dB)} &= \text{RF cable loss(dB)}. \\ &= 5.5 \text{ (dB)} \end{aligned}$$



2.5 Frequency List of Low/Middle/High Channels

LTE Band 5 Channel and Frequency List				
BW [MHz]	Channel/Frequency(MHz)	Lowest	Middle	Highest
10	Channel	20450	20525	20600
	Frequency	829	836.5	844
5	Channel	20425	20525	20625
	Frequency	826.5	836.5	846.5
3	Channel	20415	20525	20635
	Frequency	825.5	836.5	847.5
1.4	Channel	20407	20525	20643
	Frequency	824.7	836.5	848.3

LTE Band 7 Channel and Frequency List				
BW [MHz]	Channel/Frequency(MHz)	Lowest	Middle	Highest
20	Channel	20850	21100	21350
	Frequency	2510	2535	2560
15	Channel	20825	21100	21375
	Frequency	2507.5	2535	2562.5
10	Channel	20800	21100	21400
	Frequency	2505	2535	2565
5	Channel	20775	21100	21425
	Frequency	2502.5	2535	2567.5



LTE Band 38 Channel and Frequency List				
BW [MHz]	Channel/Frequency(MHz)	Lowest	Middle	Highest
20	Channel	37850	38000	38150
	Frequency	2580	2595	2610
15	Channel	37825	38000	38175
	Frequency	2577.5	2595	2612.5
10	Channel	37800	38000	38200
	Frequency	2575	2595	2615
5	Channel	37775	38000	38225
	Frequency	2572.5	2595	2617.5

LTE Band 41 Channel and Frequency List				
BW [MHz]	Channel/Frequency(MHz)	Lowest	Middle	Highest
20	Channel	40140	40640	41140
	Frequency	2545	2595	2645
15	Channel	40115	40640	41165
	Frequency	2542.5	2595	2647.5
10	Channel	40090	40640	41190
	Frequency	2540	2595	2650
5	Channel	40065	40640	41215
	Frequency	2537.5	2595	2652.5

3 Conducted Test Items

3.1 Measuring Instruments

See list of measuring instruments of this test report.

3.2 Test Setup

3.2.1 Conducted Output Power

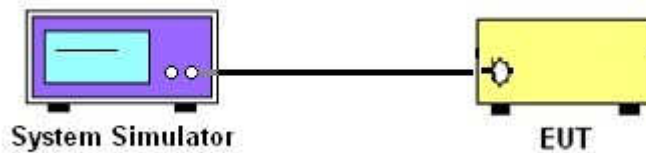

3.2.2 Peak-to-Average Ratio, Occupied Bandwidth ,Conducted Band-Edge and Conducted Spurious Emission

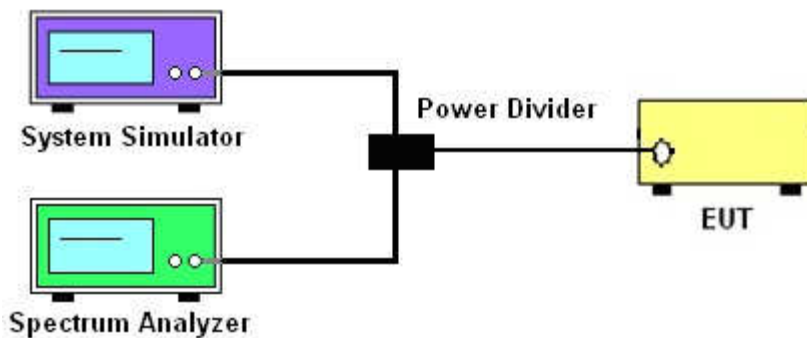

3.2.3 Frequency Stability

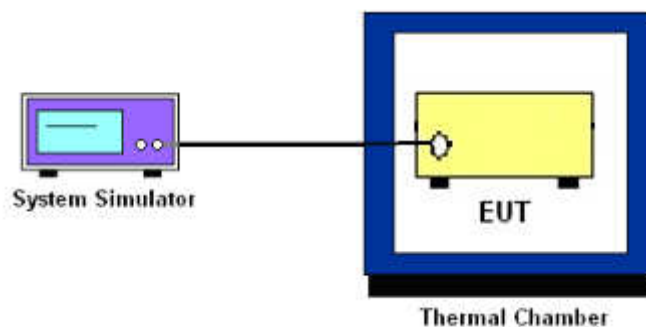

3.3 Test Result of Conducted Test

Please refer to Appendix A.



3.4 Conducted Output Power and ERP/EIRP

3.4.1 Description of the Conducted Output Power Measurement and ERP/EIRP Measurement

A system simulator was used to establish communication with the EUT. Its parameters were set to force the EUT transmitting at maximum output power. The measured power in the radio frequency on the transmitter output terminals shall be reported.

The ERP of mobile transmitters must not exceed 7 Watts for LTE Band 5.

The EIRP of mobile transmitters must not exceed 2 Watts for LTE Band 7 and Band 38 and Band 41.

According to KDB 412172 D01 Power Approach,

$EIRP = P_T + G_T - L_C$, $ERP = EIRP - 2.15$, where

P_T = transmitter output power in dBm

G_T = gain of the transmitting antenna in dBi

L_C = signal attenuation in the connecting cable between the transmitter and antenna in dB

3.4.2 Test Procedures

1. The testing follows ANSI C63.26 Section 5.2
2. The transmitter output port was connected to the system simulator.
3. Set EUT at maximum power through the system simulator.
4. Select lowest, middle, and highest channels for each band and different modulation.
5. Measure and record the power level from the system simulator.



3.5 Peak-to-Average Ratio

3.5.1 Description of the PAR Measurement

Power Complementary Cumulative Distribution Function (CCDF) curves provide a means for characterizing the power peaks of a digitally modulated signal on a statistical basis. A CCDF curve depicts the probability of the peak signal amplitude exceeding the average power level. Most contemporary measurement instrumentation include the capability to produce CCDF curves for an input signal provided that the instrument's resolution bandwidth can be set wide enough to accommodate the entire input signal bandwidth. In measuring transmissions in this band using an average power technique, the peak-to-average ratio (PAR) of the transmission may not exceed 13 dB.

3.5.2 Test Procedures

1. The testing follows ANSI C63.26 Section 5.2.3.4 (CCDF).
2. The EUT was connected to spectrum and system simulator via a power divider.
3. Set the CCDF (Complementary Cumulative Distribution Function) option in spectrum analyzer.
4. The highest RF powers were measured and recorded the maximum PAPR level associated with a probability of 0.1 %.
5. Record the deviation as Peak to Average Ratio.



3.6 Occupied Bandwidth

3.6.1 Description of Occupied Bandwidth Measurement

The occupied bandwidth is the width of a frequency band such that, below the lower and above the upper frequency limits, the mean powers emitted are each equal to a specified percentage 0.5% of the total mean transmitted power.

The 26 dB emission bandwidth is defined as the frequency range between two points, one above and one below the carrier frequency, at which the spectral density of the emission is attenuated 26 dB below the maximum in-band spectral density of the modulated signal. Spectral density (power per unit bandwidth) is to be measured with a detector of resolution bandwidth equal to approximately 1.0% of the emission bandwidth.

3.6.2 Test Procedures

1. The testing follows ANSI C63.26 Section 5.4
2. The EUT was connected to spectrum analyzer and system simulator via a power divider.
3. The spectrum analyzer center frequency is set to the nominal EUT channel center frequency. The span range for the spectrum analyzer shall be between two and five times the anticipated OBW.
4. The nominal resolution bandwidth (RBW) shall be in the range of 1 to 5 % of the anticipated OBW, and the VBW shall be at least 3 times the RBW.
5. Set the detection mode to peak, and the trace mode to max hold.
6. Determine the reference value: Set the EUT to transmit a modulated signal. Allow the trace to stabilize. Set the spectrum analyzer marker to the highest level of the displayed trace.
(this is the reference value)
7. Determine the “-26 dB down amplitude” as equal to (Reference Value – X).
8. Place two markers, one at the lowest and the other at the highest frequency of the envelope of the spectral display such that each marker is at or slightly below the “-X dB down amplitude” determined in step 6. If a marker is below this “-X dB down amplitude” value it shall be placed as close as possible to this value. The OBW is the positive frequency difference between the two markers.
9. Use the 99 % power bandwidth function of the spectrum analyzer and report the measured bandwidth.



3.7 Conducted Band Edge

3.7.1 Description of Conducted Band Edge Measurement

22.917(a)

For operations in the 824 – 849 MHz band, the FCC limit is $43 + 10\log_{10}(P[\text{Watts}])$ dB below the transmitter power $P(\text{Watts})$ in a 100kHz bandwidth. However, in the 1MHz bands immediately outside and adjacent to the licensee's frequency block, a resolution bandwidth of at least one percent of the emission bandwidth of the fundamental emission of the transmitter may be employed.

27.53(m)(4)

For mobile digital stations, the attenuation factor shall be not less than $40 + 10 \log (P)$ dB on all frequencies between the channel edge and 5 megahertz from the channel edge, $43 + 10 \log (P)$ dB on all frequencies between 5 megahertz and X megahertz from the channel edge, and $55 + 10 \log (P)$ dB on all frequencies more than X megahertz from the channel edge, where X is the greater of 6 megahertz or the actual emission bandwidth as defined in paragraph (m)(6) of this section. In addition, the attenuation factor shall not be less that $43 + 10 \log (P)$ dB on all frequencies between 2490.5 MHz and 2496 MHz and $55 + 10 \log (P)$ dB at or below 2490.5 MHz. Mobile Satellite Service licensees operating on frequencies below 2495 MHz may also submit a documented interference complaint against BRS licensees operating on channel BRS Channel 1 on the same terms and conditions as adjacent channel BRS or EBS licensees.



3.7.2 Test Procedures

1. The testing follows ANSI C63.26 section 5.7
2. The EUT was connected to spectrum analyzer and system simulator via a power divider.
3. The band edges of low and high channels for the highest RF powers were measured.
4. Set RBW \geq 1% EBW in the 1MHz band immediately outside and adjacent to the band edge.
5. Beyond the 1 MHz band from the band edge, RBW=1MHz was used.
6. Set spectrum analyzer with RMS detector.
7. Offset has included the duty factor for LTE Band 38/41. Duty factor = $10 \log (1/x)$, where x is the measured duty cycle
8. The RF fundamental frequency should be excluded against the limit line in the operating frequency band.
9. Checked that all the results comply with the emission limit line.

Example:

The limit line is derived from $43 + 10\log(P)$ dB below the transmitter power P(Watts)

$$= P(W) - [43 + 10\log(P)] \text{ (dB)}$$

$$= [30 + 10\log(P)] \text{ (dBm)} - [43 + 10\log(P)] \text{ (dB)} = -13\text{dBm.}$$

10. For LTE Band 7, 38, 41, the other 40 dB, and 55 dB have additionally applied same calculation above.



3.8 Conducted Spurious Emission

3.8.1 Description of Conducted Spurious Emission Measurement

The power of any emission outside of the authorized operating frequency ranges must be lower than the transmitter power (P) by a factor of at least $43 + 10 \log (P)$ dB.

For Band 7,38,41:

The power of any emission outside of the authorized operating frequency ranges must be lower than the transmitter power (P) by a factor of at least $55 + 10 \log (P)$ dB.

It is measured by means of a calibrated spectrum analyzer and scanned from 30 MHz up to a frequency including its 10th harmonic.

3.8.2 Test Procedures

1. The testing follows ANSI C63.26 section 5.7
2. The EUT was connected to spectrum analyzer and system simulator via a power divider.
3. The RF output of EUT was connected to the spectrum analyzer by RF cable and attenuator. The path loss was compensated to the results for each measurement.
4. The middle channel for the highest RF power within the transmitting frequency was measured.
5. The conducted spurious emission for the whole frequency range was taken.
6. Make the measurement with the spectrum analyzer's RBW = 1MHz, VBW = 3MHz.
7. Offset has included the duty factor for LTE Band 38/41. Duty factor = $10 \log (1/x)$, where x is the measured duty cycle
8. Set spectrum analyzer with RMS detector.
9. Taking the record of maximum spurious emission.
10. The RF fundamental frequency should be excluded against the limit line in the operating frequency band.
11. The limit line is derived from $43 + 10 \log (P)$ dB below the transmitter power P(Watts)
= $P(W) - [43 + 10 \log (P)]$ (dB)
= $[30 + 10 \log (P)]$ (dBm) - $[43 + 10 \log (P)]$ (dB)
= -13dBm.
12. For Band 7, 38, 41
The limit line is derived from $55 + 10 \log (P)$ dB below the transmitter power P(Watts)
= $P(W) - [55 + 10 \log (P)]$ (dB)
= $[30 + 10 \log (P)]$ (dBm) - $[55 + 10 \log (P)]$ (dB)
= -25dBm.



3.9 Frequency Stability

3.9.1 Description of Frequency Stability Measurement

The frequency stability shall be measured by variation of ambient temperature and variation of primary supply voltage to ensure that the fundamental emission stays within the authorized frequency block. The frequency stability of the transmitter shall be maintained within $\pm 0.00025\%$ ($\pm 2.5\text{ppm}$) of the center frequency.

3.9.2 Test Procedures for Temperature Variation

1. The testing follows ANSI C63.26 section 5.6.4
2. The EUT was set up in the thermal chamber and connected with the system simulator.
3. With power OFF, the temperature was decreased to -30°C and the EUT was stabilized before testing. Power was applied and the maximum change in frequency was recorded within one minute.
4. With power OFF, the temperature was raised in 10°C step up to 50°C . The EUT was stabilized at each step for at least half an hour. Power was applied and the maximum frequency change was recorded within one minute.

3.9.3 Test Procedures for Voltage Variation

1. The testing follows ANSI C63.26 section 5.6.5
2. The EUT was placed in a temperature chamber at $20\pm 5^{\circ}\text{C}$ and connected with the system simulator.
3. The power supply voltage to the EUT was varied from 85% to 115% of the nominal value for other than hand carried battery equipment.
4. For hand carried, battery powered equipment, reduce the primary ac or dc supply voltage to the battery operating end point, which shall be specified by the manufacturer.
5. The variation in frequency was measured for the worst case.

4 Radiated Test Items

4.1 Measuring Instruments

See list of measuring instruments of this test report.

4.2 Test Setup

4.2.1 For radiated test from 30MHz to 1GHz

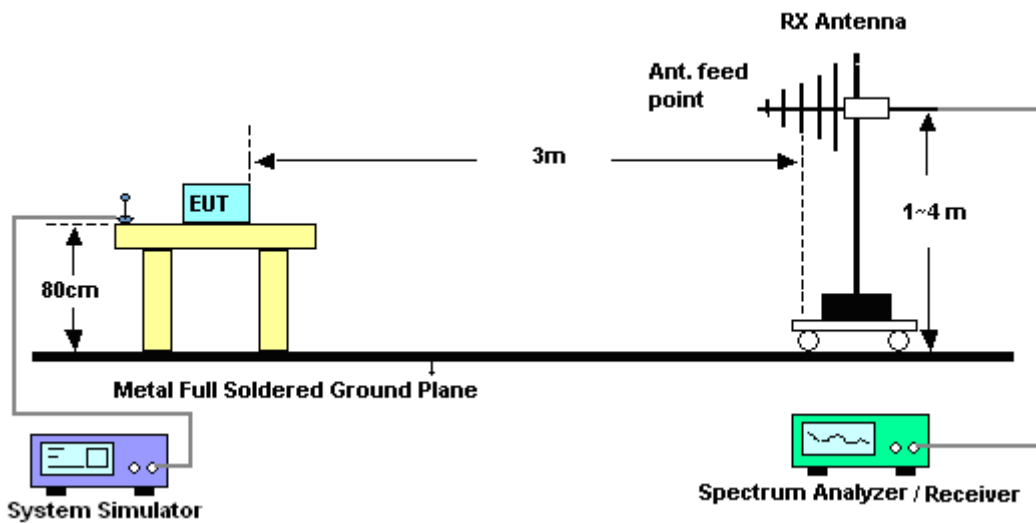

4.2.2 For radiated test above 1GHz

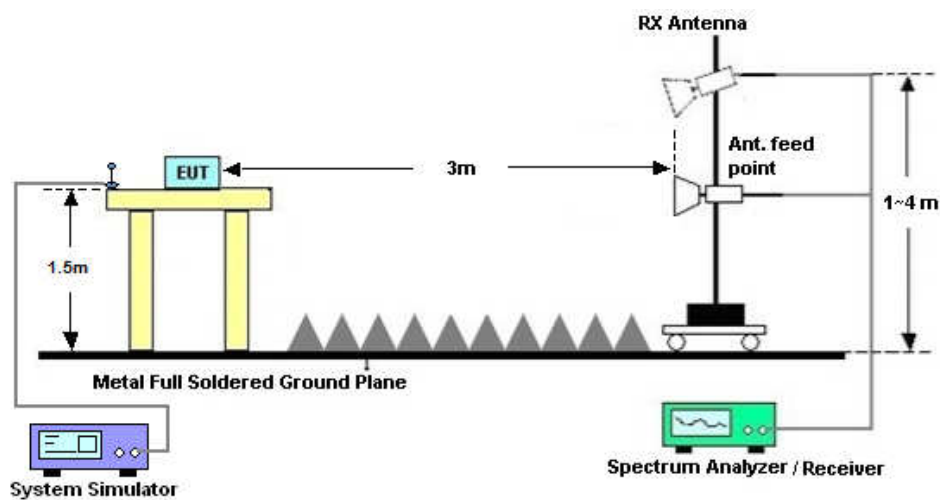

4.3 Test Result of Radiated Test

Please refer to Appendix B.



4.4 Radiated Spurious Emission

4.4.1 Description of Radiated Spurious Emission

The radiated spurious emission was measured by substitution method according to ANSI C63.26. The power of any emission outside of the authorized operating frequency ranges must be attenuated below the transmitter power (P) by a factor of at least $43 + 10 \log (P)$ dB.

For Band 7, 38, 41

The power of any emission outside of the authorized operating frequency ranges must be attenuated below the transmitter power (P) by a factor of at least $55 + 10 \log (P)$ dB.

The spectrum is scanned from 30 MHz up to a frequency including its 10th harmonic.

4.4.2 Test Procedures

1. The testing follows ANSI C63.26 Section 5.5
2. The EUT was placed on a turntable with 0.8 meter height for frequency below 1GHz and 1.5 meter height for frequency above 1GHz respectively above ground.
3. The EUT was set 3 meters from the receiving antenna mounted on the antenna tower.
4. The table was rotated 360 degrees to determine the position of the highest spurious emission.
5. The height of the receiving antenna is varied between 1m to 4m to search the maximum spurious emission for both horizontal and vertical polarizations.
6. During the measurement, the system simulator parameters were set to force the EUT transmitting at maximum output power.
7. Make the measurement with the spectrum analyzer's RBW = 1MHz, VBW = 3MHz, taking the record of maximum spurious emission.
8. A horn antenna was substituted in place of the EUT and was driven by a signal generator.
9. Tune the output power of signal generator to the same emission level with EUT maximum spurious emission.
10. $EIRP (dBm) = S.G. Power - Tx Cable Loss + Tx Antenna Gain$
11. $ERP (dBm) = EIRP - 2.15$
12. The RF fundamental frequency should be excluded against the limit line in the operating frequency band.

The limit line is derived from $43 + 10\log(P)$ dB below the transmitter power P(Watts)
 $= P(W) - [43 + 10\log(P)] (dB)$
 $= [30 + 10\log(P)] (dBm) - [43 + 10\log(P)] (dB)$
 $= -13dBm.$

13. For Band 7, 38, 41:

The limit line is derived from $55 + 10\log(P)$ dB below the transmitter power P(Watts)



5 List of Measuring Equipment

Instrument	Manufacturer	Model No.	Serial No.	Characteristics	Calibration Date	Test Date	Due Date	Remark
Spectrum Analyzer	R&S	FSV40	101040	10Hz~40GHz	Aug. 08, 2017	May 14, 2018~ May 15, 2018	Aug. 07, 2018	Conducted (TH01-KS)
Radio communication analyzer	Anritsu	MT8820C	6201300652	2G/3G/LTE_ full band	Aug. 08, 2017	May 14, 2018~ May 15, 2018	Aug. 07, 2018	Conducted (TH01-KS)
Thermal Chamber	Ten Billion	TTC-B3S	TBN-960502	-40~+150°C	Oct. 12, 2017	May 14, 2018~ May 15, 2018	Oct. 11, 2018	Conducted (TH01-KS)
EXA Spectrum Analyzer	Keysight	N9010A	MY55150244	10Hz-44GHz	Apr. 17, 2018	May 14, 2018	Apr. 16, 2019	Radiation (03CH03-KS)
Bilog Antenna	TeseQ	CBL6112D	35406	25MHz-2GHz	Sep. 12, 2017	May 14, 2018	Sep. 11, 2018	Radiation (03CH03-KS)
Double Ridge Horn Antenna	ETS-Lindgren	3117	75959	1GHz~18GHz	Jan. 21, 2018	May 14, 2018	Jan. 20, 2019	Radiation (03CH03-KS)
SHF-EHF Horn	Schwarzbeck	BBHA 9170	BBHA170249	15GHz~40GHz	Feb. 07, 2018	May 14, 2018	Feb. 06, 2019	Radiation (03CH03-KS)
Amplifier	com-power	PA-103A	161069	1MHz ~1000MHz / 32 dB	Apr. 17, 2018	May 14, 2018	Apr. 16, 2019	Radiation (03CH03-KS)
high gain Amplifier	MITEQ	AMF-7D-00 101800-30-1 0P	2025788	1Ghz-18Ghz	Apr. 17, 2018	May 14, 2018	Apr. 16, 2019	Radiation (03CH03-KS)
Amplifier	MITEQ	TTA1840-35 -HG	1887435	18~40GHz	Oct. 12, 2017	May 14, 2018	Oct. 11, 2018	Radiation (03CH03-KS)
Amplifier	Agilent	8449B	3008A02370	1GHz~26.5GHz	Oct. 12, 2017	May 14, 2018	Oct. 11, 2018	Radiation (03CH03-KS)
AC Power Source	Chroma	61601	F104090004	N/A	NCR	May 14, 2018	NCR	Radiation (03CH03-KS)
Turn Table	ChamPro	EM 1000-T	060762-T	0~360 degree	NCR	May 14, 2018	NCR	Radiation (03CH03-KS)
Antenna Mast	ChamPro	EM 1000-A	060762-A	1 m~4 m	NCR	May 14, 2018	NCR	Radiation (03CH03-KS)

NCR: No Calibration Required



6 Uncertainty of Evaluation

Uncertainty of Radiated Emission Measurement (30 MHz ~ 1000 MHz)

Measuring Uncertainty for a Level of Confidence of 95% ($U = 2Uc(y)$)	3.3dB
---	-------

Uncertainty of Radiated Emission Measurement (1 GHz ~ 18 GHz)

Measuring Uncertainty for a Level of Confidence of 95% ($U = 2Uc(y)$)	2.8dB
---	-------

Uncertainty of Radiated Emission Measurement (18 GHz ~ 40 GHz)

Measuring Uncertainty for a Level of Confidence of 95% ($U = 2Uc(y)$)	3.0dB
---	-------



Appendix A. Test Results of Conducted Test

Conducted Output Power(Average power)

LTE Band 5 Maximum Average Power [dBm]						
BW [MHz]	RB Size	RB Offset	Mod	Lowest	Middle	Highest
10	1	0	QPSK	22.73	22.74	22.82
10	1	25		23.24	23.27	23.18
10	1	49		22.71	22.82	22.80
10	25	0		22.03	22.26	22.08
10	25	12		22.09	22.10	22.20
10	25	25		22.01	22.11	22.13
10	50	0		22.09	22.04	22.19
10	1	0	16-QAM	21.61	21.58	21.51
10	1	25		21.87	22.19	21.69
10	1	49		21.46	21.57	21.55
10	25	0		21.09	21.14	21.21
10	25	12		21.15	21.16	21.17
10	25	25		21.07	20.96	21.20
10	50	0		21.15	21.01	21.21
5	1	0	QPSK	22.67	22.60	22.91
5	1	12		23.07	22.89	23.00
5	1	24		22.79	22.65	22.60
5	12	0		21.90	21.81	22.01
5	12	7		21.94	21.92	22.05
5	12	13		21.87	21.88	21.88
5	25	0		21.86	21.95	21.95
5	1	0	16-QAM	21.43	21.97	22.05
5	1	12		22.15	22.31	21.69
5	1	24		21.97	21.41	21.83
5	12	0		20.93	20.73	21.04
5	12	7		20.89	20.70	21.00
5	12	13		20.93	20.65	20.83
5	25	0		20.86	20.88	20.73



LTE Band 5 Maximum Average Power [dBm]						
BW [MHz]	RB Size	RB Offset	Mod	Lowest	Middle	Highest
3	1	0	QPSK	22.75	22.72	22.93
3	1	8		22.70	22.71	22.93
3	1	14		22.82	22.69	22.82
3	8	0		21.94	21.77	21.97
3	8	4		21.83	21.86	21.87
3	8	7		21.88	21.82	21.92
3	15	0		21.99	21.90	21.85
3	1	0	16-QAM	22.11	21.95	21.62
3	1	8		22.18	21.50	21.23
3	1	14		22.26	21.60	21.72
3	8	0		20.95	20.83	20.95
3	8	4		20.90	20.76	20.99
3	8	7		20.90	20.76	20.90
3	15	0		20.96	20.93	20.92
1.4	1	0	QPSK	22.67	22.84	22.76
1.4	1	3		22.64	22.83	22.94
1.4	1	5		22.48	22.67	22.86
1.4	3	0		22.82	22.88	22.83
1.4	3	1		22.94	23.00	22.90
1.4	3	3		22.93	22.91	22.85
1.4	6	0		21.89	21.88	21.90
1.4	1	0	16-QAM	21.36	21.31	22.00
1.4	1	3		21.42	21.54	21.62
1.4	1	5		21.33	21.73	21.24
1.4	3	0		21.63	21.67	21.81
1.4	3	1		22.14	21.80	21.85
1.4	3	3		22.13	21.82	22.19
1.4	6	0		20.74	20.85	20.69



LTE Band 7 Maximum Average Power [dBm]						
BW [MHz]	RB Size	RB Offset	Mod	Lowest	Middle	Highest
20	1	0	QPSK	22.64	22.73	22.58
20	1	49		23.00	23.19	23.24
20	1	99		22.74	22.69	22.81
20	50	0		21.91	22.12	22.03
20	50	24		21.96	22.13	22.14
20	50	50		21.96	22.03	22.12
20	100	0		21.94	22.17	22.12
20	1	0	16-QAM	21.46	21.70	21.51
20	1	49		22.14	21.67	22.27
20	1	99		22.08	21.47	21.73
20	50	0		20.88	21.21	21.09
20	50	24		20.94	21.22	21.21
20	50	50		20.94	21.03	21.20
20	100	0		20.84	21.15	21.09
15	1	0	QPSK	22.46	22.71	22.68
15	1	37		22.97	23.01	22.95
15	1	74		22.62	22.65	22.98
15	36	0		21.61	21.97	22.06
15	36	20		21.79	21.94	22.08
15	36	39		21.67	21.93	22.05
15	75	0		21.67	21.91	22.04
15	1	0	16-QAM	21.45	21.53	21.43
15	1	37		21.89	21.61	22.39
15	1	74		21.92	21.41	22.38
15	36	0		20.52	20.93	20.95
15	36	20		20.74	20.88	20.92
15	36	39		20.58	20.87	21.08
15	75	0		20.74	20.88	20.95



LTE Band 7 Maximum Average Power [dBm]						
BW [MHz]	RB Size	RB Offset	Mod	Lowest	Middle	Highest
10	1	0	QPSK	22.39	22.79	22.91
10	1	25		22.72	22.87	23.00
10	1	49		22.57	22.80	23.01
10	25	0		21.69	21.93	22.05
10	25	12		21.59	22.04	22.21
10	25	25		21.65	21.90	22.12
10	50	0		21.71	22.03	21.98
10	1	0	16-QAM	21.74	22.12	21.78
10	1	25		21.65	22.25	21.66
10	1	49		21.66	21.43	21.64
10	25	0		20.59	20.88	21.02
10	25	12		20.69	20.97	21.06
10	25	25		20.68	20.87	21.16
10	50	0		20.67	20.82	21.02
5	1	0	QPSK	22.43	22.85	22.70
5	1	12		22.88	22.88	22.94
5	1	24		22.58	22.90	22.68
5	12	0		21.65	21.99	22.02
5	12	7		21.71	22.01	22.11
5	12	13		21.62	21.95	21.96
5	25	0		21.67	21.93	22.01
5	1	0	16-QAM	21.56	21.43	21.38
5	1	12		21.70	21.88	22.24
5	1	24		21.47	21.50	21.51
5	12	0		20.54	20.77	20.91
5	12	7		20.52	20.91	21.00
5	12	13		20.37	20.72	20.95
5	25	0		20.60	20.82	20.88



LTE Band 38 Maximum Average Power [dBm]						
BW [MHz]	RB Size	RB Offset	Mod	Lowest	Middle	Highest
20	1	0	QPSK	22.67	22.81	22.62
20	1	49		23.04	23.08	23.13
20	1	99		22.69	22.68	22.89
20	50	0		22.00	22.01	21.99
20	50	24		22.07	22.09	22.13
20	50	50		21.96	22.01	21.92
20	100	0		22.02	22.00	22.10
20	1	0	16-QAM	21.71	21.46	21.47
20	1	49		21.67	22.05	21.84
20	1	99		21.46	21.49	21.75
20	50	0		20.95	21.06	21.02
20	50	24		21.10	20.98	20.98
20	50	50		20.98	20.98	21.05
20	100	0		20.99	21.06	21.05
15	1	0	QPSK	22.90	22.54	22.65
15	1	37		22.95	22.80	22.86
15	1	74		22.80	22.74	22.86
15	36	0		22.04	21.85	21.94
15	36	20		21.96	22.00	22.09
15	36	39		21.95	21.88	22.04
15	75	0		21.98	21.82	22.07
15	1	0	16-QAM	21.59	21.41	21.35
15	1	37		21.96	21.64	21.66
15	1	74		21.51	21.46	21.47
15	36	0		20.97	20.81	20.78
15	36	20		20.83	20.78	20.83
15	36	39		20.85	20.75	20.92
15	75	0		20.86	21.00	20.81



LTE Band 38 Maximum Average Power [dBm]						
BW [MHz]	RB Size	RB Offset	Mod	Lowest	Middle	Highest
10	1	0	QPSK	22.84	22.54	22.65
10	1	25		22.94	22.73	22.77
10	1	49		22.77	22.69	22.77
10	25	0		22.00	21.79	21.84
10	25	12		21.88	21.99	22.06
10	25	25		21.92	21.80	22.00
10	50	0		21.97	21.79	21.97
10	1	0	16-QAM	21.51	21.33	21.34
10	1	25		21.92	21.60	21.62
10	1	49		21.43	21.41	21.38
10	25	0		20.92	20.76	20.73
10	25	12		20.77	20.71	20.78
10	25	25		20.78	20.67	20.86
10	50	0		20.79	20.93	20.73
5	1	0	QPSK	22.80	22.52	22.57
5	1	12		22.85	22.65	22.73
5	1	24		22.69	22.63	22.73
5	12	0		21.96	21.77	21.78
5	12	7		21.79	21.91	21.98
5	12	13		21.82	21.79	21.95
5	25	0		21.97	21.75	21.88
5	1	0	16-QAM	21.47	21.23	21.25
5	1	12		21.90	21.50	21.52
5	1	24		21.36	21.37	21.36
5	12	0		20.91	20.67	20.70
5	12	7		20.69	20.67	20.76
5	12	13		20.77	20.62	20.80
5	25	0		20.71	20.91	20.68



LTE Band 41 Maximum Average Power [dBm]						
BW [MHz]	RB Size	RB Offset	Mod	Lowest	Middle	Highest
20	1	0	QPSK	22.52	22.61	22.68
20	1	49		23.16	23.16	23.00
20	1	99		22.96	22.64	22.53
20	50	0		22.04	21.98	21.87
20	50	24		22.00	21.98	21.79
20	50	50		22.04	21.91	21.68
20	100	0		22.03	21.95	21.84
20	1	0	16-QAM	21.27	21.65	21.67
20	1	49		21.80	21.73	21.65
20	1	99		21.80	21.36	21.18
20	50	0		20.97	20.90	20.81
20	50	24		20.98	20.87	20.74
20	50	50		20.97	20.74	20.64
20	100	0		21.02	20.97	20.75
15	1	0	QPSK	22.50	22.64	22.68
15	1	37		23.14	23.15	22.90
15	1	74		22.88	22.55	22.50
15	36	0		21.98	21.95	21.81
15	36	20		21.98	21.87	21.71
15	36	39		22.03	21.87	21.63
15	75	0		21.94	22.02	21.82
15	1	0	16-QAM	21.22	21.62	21.57
15	1	37		21.70	21.70	21.55
15	1	74		21.70	21.29	21.13
15	36	0		20.87	20.83	20.73
15	36	20		20.95	20.86	20.72
15	36	39		20.96	20.75	20.59
15	75	0		20.96	20.90	20.67



LTE Band 41 Maximum Average Power [dBm]						
BW [MHz]	RB Size	RB Offset	Mod	Lowest	Middle	Highest
10	1	0	QPSK	22.45	22.50	22.66
10	1	25		23.05	23.01	22.80
10	1	49		22.78	22.48	22.48
10	25	0		21.97	21.92	21.76
10	25	12		21.90	21.75	21.65
10	25	25		21.96	21.81	21.53
10	50	0		21.85	21.94	21.73
10	1	0	16-QAM	21.21	21.45	21.49
10	1	25		21.68	21.61	21.45
10	1	49		21.67	21.22	21.09
10	25	0		20.85	20.65	20.70
10	25	12		20.89	20.68	20.67
10	25	25		20.92	20.65	20.50
10	50	0		20.95	20.81	20.57
5	1	0	QPSK	22.36	22.49	22.57
5	1	12		23.02	22.93	22.79
5	1	24		22.77	22.54	22.45
5	12	0		21.94	21.85	21.71
5	12	7		21.85	21.71	21.56
5	12	13		21.94	21.77	21.45
5	25	0		21.77	21.85	21.66
5	1	0	16-QAM	21.18	21.51	21.49
5	1	12		21.61	21.74	21.35
5	1	24		21.62	21.13	21.08
5	12	0		20.83	20.64	20.65
5	12	7		20.82	20.70	20.66
5	12	13		20.82	20.74	20.44
5	25	0		20.87	20.80	20.54



ERP/EIRP

LTE Band 5 (GT - LC = -5.4 dBi) QPSK									
Bandwidth	1.4M			3M			5M		
Channel	20407	20525	20643	20415	20525	20635	20425	20525	20625
	(Low)	(Mid)	(High)	(Low)	(Mid)	(High)	(Low)	(Mid)	(High)
Frequency	824.7	836.5	848.3	825.5	836.5	847.5	826.5	836.5	846.5
(MHz)									
Conducted Power (dBm)	22.94	23.00	22.90	22.75	22.72	22.93	23.07	22.89	23.00
Conducted Power (Watts)	0.1968	0.1995	0.1950	0.1884	0.1871	0.1963	0.2028	0.1945	0.1995
ERP(dBm)	15.39	15.45	15.35	15.20	15.17	15.38	15.52	15.34	15.45
ERP(Watts)	0.0346	0.0351	0.0343	0.0331	0.0329	0.0345	0.0356	0.0342	0.0351

LTE Band 5 (GT - LC = -5.4 dBi) QPSK			
Bandwidth	10M		
Channel	20450	20525	20600
	(Low)	(Mid)	(High)
Frequency	829	836.5	844
(MHz)			
Conducted Power (dBm)	23.24	23.27	23.18
Conducted Power (Watts)	0.2109	0.2123	0.2080
ERP(dBm)	15.69	15.72	15.63
ERP(Watts)	0.0371	0.0373	0.0366



LTE Band 5 (GT - LC = -5.4 dBi) 16QAM									
Bandwidth	1.4M			3M			5M		
Channel	20407	20525	20643	20415	20525	20635	20425	20525	20625
	(Low)	(Mid)	(High)	(Low)	(Mid)	(High)	(Low)	(Mid)	(High)
Frequency (MHz)	824.7	836.5	848.3	825.5	836.5	847.5	826.5	836.5	846.5
Conducted Power (dBm)	22.13	21.82	22.19	22.26	21.60	21.72	22.15	22.31	21.69
Conducted Power (Watts)	0.1633	0.1521	0.1656	0.1683	0.1445	0.1486	0.1641	0.1702	0.1476
ERP(dBm)	14.58	14.27	14.64	14.71	14.05	14.17	14.60	14.76	14.14
ERP(Watts)	0.0287	0.0267	0.0291	0.0296	0.0254	0.0261	0.0288	0.0299	0.0259

LTE Band 5 (GT - LC = -5.4 dBi) 16QAM			
Bandwidth	10M		
Channel	20450	20525	20600
	(Low)	(Mid)	(High)
Frequency (MHz)	829	836.5	844
Conducted Power (dBm)	21.87	22.19	21.69
Conducted Power (Watts)	0.1538	0.1656	0.1476
ERP(dBm)	14.32	14.64	14.14
ERP(Watts)	0.0270	0.0291	0.0259



LTE Band 7 (GT - LC = -1.1 dBi) QPSK			
Bandwidth	5M		
Channel	20775	21100	21425
	(Low)	(Mid)	(High)
Frequency	2502.5	2535	2567.5
(MHz)			
Conducted Power (dBm)	22.88	22.88	22.94
Conducted Power (Watts)	0.1941	0.1941	0.1968
EIRP(dBm)	21.78	21.78	21.84
EIRP(Watts)	0.1507	0.1507	0.1528

LTE Band 7 (GT - LC = -1.1 dBi) QPSK									
Bandwidth	10M			15M			20M		
Channel	20800	21100	21400	20825	21100	21375	20850	21100	21350
	(Low)	(Mid)	(High)	(Low)	(Mid)	(High)	(Low)	(Mid)	(High)
Frequency	2505	2535	2565	2507.5	2535	2562.5	2510	2535	2560
(MHz)									
Conducted Power (dBm)	22.57	22.80	23.01	22.97	23.01	22.95	23.00	23.19	23.24
Conducted Power (Watts)	0.1807	0.1905	0.2000	0.1982	0.2000	0.1972	0.1995	0.2084	0.2109
EIRP(dBm)	21.47	21.70	21.91	21.87	21.91	21.85	21.90	22.09	22.14
EIRP(Watts)	0.1403	0.1479	0.1552	0.1538	0.1552	0.1531	0.1549	0.1618	0.1637



LTE Band 7 (GT - LC = -1.1 dBi) 16QAM			
Bandwidth	5M		
Channel	20775	21100	21425
	(Low)	(Mid)	(High)
Frequency (MHz)	2502.5	2535	2567.5
	Conducted Power (dBm)	21.70	21.88
Conducted Power (Watts)	0.1479	0.1542	0.1675
EIRP(dBm)	20.60	20.78	21.14
EIRP(Watts)	0.1148	0.1197	0.1300

LTE Band 7 (GT - LC = -1.1 dBi) 16QAM									
Bandwidth	10M			15M			20M		
Channel	20800	21100	21400	20825	21100	21375	20850	21100	21350
	(Low)	(Mid)	(High)	(Low)	(Mid)	(High)	(Low)	(Mid)	(High)
Frequency (MHz)	2505	2535	2565	2507.5	2535	2562.5	2510	2535	2560
	Conducted Power (dBm)	21.65	22.25	21.66	21.89	21.61	22.39	22.14	21.67
Conducted Power (Watts)	0.1462	0.1679	0.1466	0.1545	0.1449	0.1734	0.1637	0.1469	0.1687
EIRP(dBm)	20.55	21.15	20.56	20.79	20.51	21.29	21.04	20.57	21.17
EIRP(Watts)	0.1135	0.1303	0.1138	0.1199	0.1125	0.1346	0.1271	0.1140	0.1309



LTE Band 38 (GT - LC = -4.4 dBi) QPSK			
Bandwidth	5M		
Channel	37775	38000	38225
	(Low)	(Mid)	(High)
Frequency	2572.5	2595	2617.5
(MHz)			
Conducted Power (dBm)	22.85	22.65	22.73
Conducted Power (Watts)	0.1928	0.1841	0.1875
EIRP(dBm)	18.45	18.25	18.33
EIRP(Watts)	0.0700	0.0668	0.0681

LTE Band 38 (GT - LC = -4.4 dBi) QPSK									
Bandwidth	10M			15M			20M		
Channel	37800	38000	38200	37825	38000	38175	37850	38000	38150
	(Low)	(Mid)	(High)	(Low)	(Mid)	(High)	(Low)	(Mid)	(Mid)
Frequency	2575	2595	2615	2577.5	2595	2612.5	2580	2595	2610
(MHz)									
Conducted Power (dBm)	22.94	22.73	22.77	22.95	22.80	22.86	23.04	23.08	23.13
Conducted Power (Watts)	0.1968	0.1875	0.1892	0.1972	0.1905	0.1932	0.2014	0.2032	0.2056
EIRP(dBm)	18.54	18.33	18.37	18.55	18.40	18.46	18.64	18.68	18.73
EIRP(Watts)	0.0714	0.0681	0.0687	0.0716	0.0692	0.0701	0.0731	0.0738	0.0746



LTE Band 38 (GT - LC = -4.4 dBi) 16QAM			
Bandwidth	5M		
Channel	37775	38000	38225
	(Low)	(Mid)	(High)
Frequency	2572.5	2595	2617.5
(MHz)			
Conducted Power (dBm)	21.90	21.50	21.52
Conducted Power (Watts)	0.1549	0.1413	0.1419
EIRP(dBm)	17.50	17.10	17.12
EIRP(Watts)	0.0562	0.0513	0.0515

LTE Band 38 (GT - LC = -4.4 dBi) 16QAM									
Bandwidth	10M			15M			20M		
Channel	37800	38000	38200	37825	38000	38175	37850	38000	38150
	(Low)	(Mid)	(High)	(Low)	(Mid)	(High)	(Low)	(Mid)	(Mid)
Frequency	2575	2595	2615	2577.5	2595	2612.5	2580	2595	2610
(MHz)									
Conducted Power (dBm)	21.92	21.60	21.62	21.96	21.64	21.66	21.67	22.05	21.84
Conducted Power (Watts)	0.1556	0.1445	0.1452	0.1570	0.1459	0.1466	0.1469	0.1603	0.1528
EIRP(dBm)	17.52	17.20	17.22	17.56	17.24	17.26	17.27	17.65	17.44
EIRP(Watts)	0.0565	0.0525	0.0527	0.0570	0.0530	0.0532	0.0533	0.0582	0.0555



LTE Band 41 (G _T - L _C = -4.5dBi) QPSK									
Bandwidth	5M			10M			15M		
Channel	40065	40640	41215	40090	40640	41190	40115	40640	41165
	(Low)	(Mid)	(High)	(Low)	(Mid)	(High)	(Low)	(Mid)	(High)
Frequency (MHz)	2537.5	2595	2652.5	2540	2595	2650	2542.5	2595	2647.5
Conducted Power (dBm)	23.02	22.93	22.79	23.05	23.01	22.80	23.14	23.15	22.90
Conducted Power (Watts)	0.2004	0.1963	0.1901	0.2018	0.2000	0.1905	0.2061	0.2065	0.1950
EIRP(dBm)	18.52	18.43	18.29	18.55	18.51	18.30	18.64	18.65	18.40
EIRP(Watts)	0.0711	0.0697	0.0675	0.0716	0.0710	0.0676	0.0731	0.0733	0.0692

LTE Band 41 (G _T - L _C = -4.5dBi) QPSK			
Bandwidth	20M		
Channel	40140	40640	41140
	(Low)	(Mid)	(High)
Frequency (MHz)	2545	2595	2645
Conducted Power (dBm)	23.16	23.16	23.00
Conducted Power (Watts)	0.2070	0.2070	0.1995
EIRP(dBm)	18.66	18.66	18.50
EIRP(Watts)	0.0735	0.0735	0.0708



LTE Band 41 (G _T - L _C = -4.5dBi) 16QAM									
Bandwidth	5M			10M			15M		
Channel	40065	40640	41215	40090	40640	41190	40115	40640	41165
	(Low)	(Mid)	(High)	(Low)	(Mid)	(High)	(Low)	(Mid)	(High)
Frequency (MHz)	2537.5	2595	2652.5	2540	2595	2650	2542.5	2595	2647.5
Conducted Power (dBm)	21.61	21.74	21.35	21.68	21.61	21.45	21.70	21.70	21.55
Conducted Power (Watts)	0.1449	0.1493	0.1365	0.1472	0.1449	0.1396	0.1479	0.1479	0.1429
EIRP(dBm)	17.11	17.24	16.85	17.18	17.11	16.95	17.20	17.20	17.05
EIRP(Watts)	0.0514	0.0530	0.0484	0.0522	0.0514	0.0495	0.0525	0.0525	0.0507

LTE Band 41 (G _T - L _C = -4.5dBi) 16QAM			
Bandwidth	20M		
Channel	40140	40640	41140
	(Low)	(Mid)	(High)
Frequency (MHz)	2545	2595	2645
Conducted Power (dBm)	21.80	21.73	21.65
Conducted Power (Watts)	0.1514	0.1489	0.1462
EIRP(dBm)	17.30	17.23	17.15
EIRP(Watts)	0.0537	0.0528	0.0519



Peak-to-Average Ratio

Mode	LTE Band 38 / 20MHz				
Mod.	QPSK		16QAM		Limit: 13dB
RB Size	1RB	Full RB	1RB	Full RB	Result
Lowest CH	4.78	5.57	5.74	5.97	PASS
Middle CH	5.07	5.59	5.74	6.03	
Highest CH	5.83	5.04	5.74	6.12	

Mode	LTE Band 41 / 20MHz				
Mod.	QPSK		16QAM		Limit: 13dB
RB Size	1RB	Full RB	1RB	Full RB	Result
Lowest CH	6.06	4.84	5.68	5.88	PASS
Middle CH	5.59	5.59	6.12	5.94	
Highest CH	4.96	5.04	5.62	5.97	



LTE Band 38 / 20MHz / QPSK

Lowest Channel / 1RB

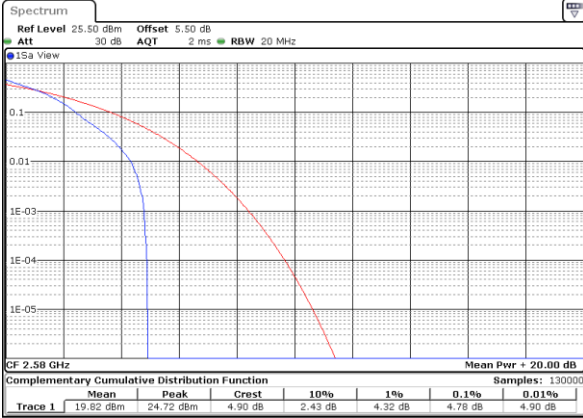

Date: 15 MAY 2018 09:12:48

Lowest Channel / Full RB

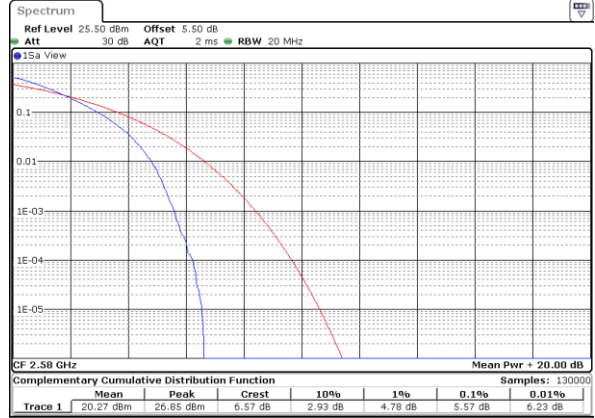

Date: 15 MAY 2018 09:14:25

Middle Channel / 1RB



Date: 15 MAY 2018 09:16:17

Middle Channel / Full RB

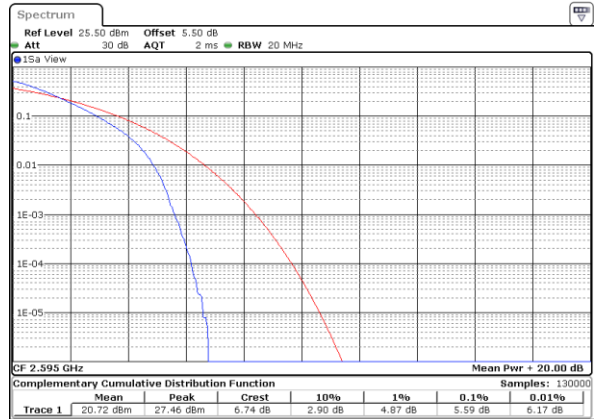

Date: 15 MAY 2018 09:14:51

Highest Channel / 1RB

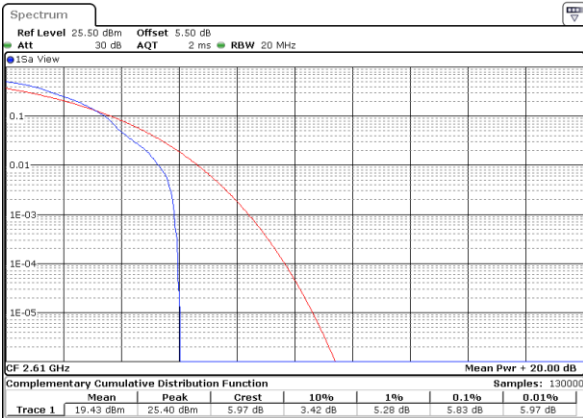

Date: 15 MAY 2018 09:16:39

Highest Channel / Full RB

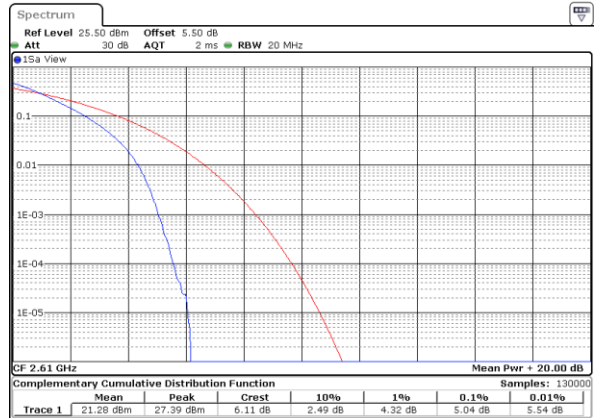

Date: 15 MAY 2018 09:17:56



LTE Band 38 / 20MHz / 16QAM

Lowest Channel / 1RB

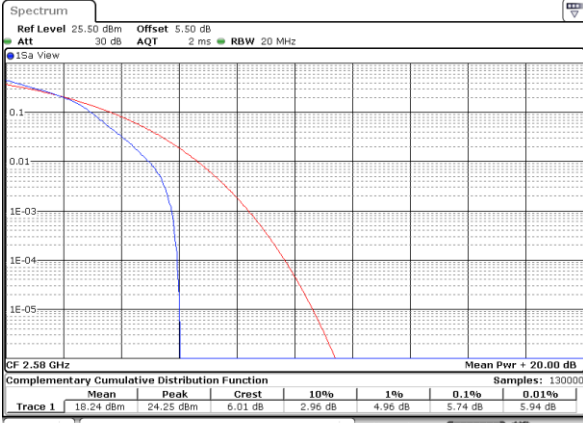

Date: 15 MAY 2018 09:13:11

Lowest Channel / Full RB

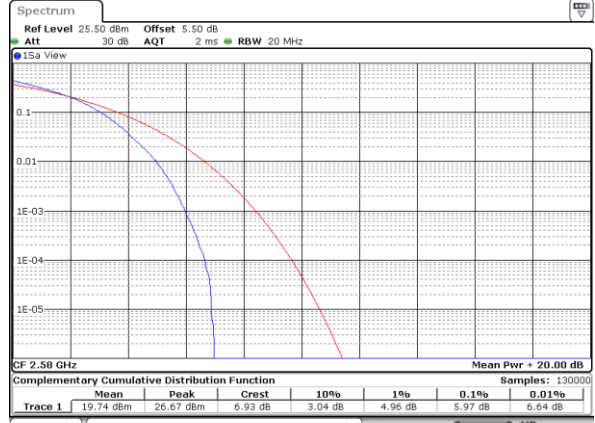

Date: 15 MAY 2018 09:13:58

Middle Channel / 1RB

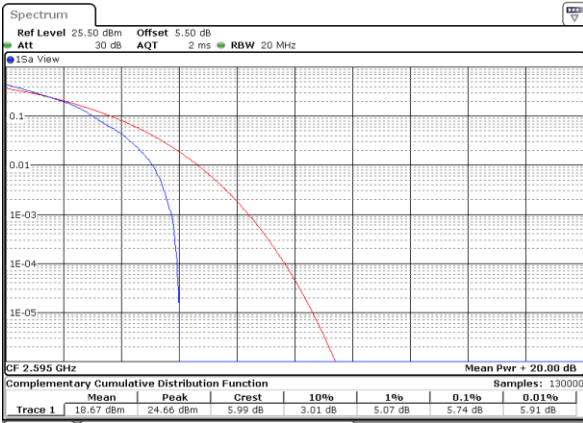

Date: 15 MAY 2018 09:16:00

Middle Channel / Full RB

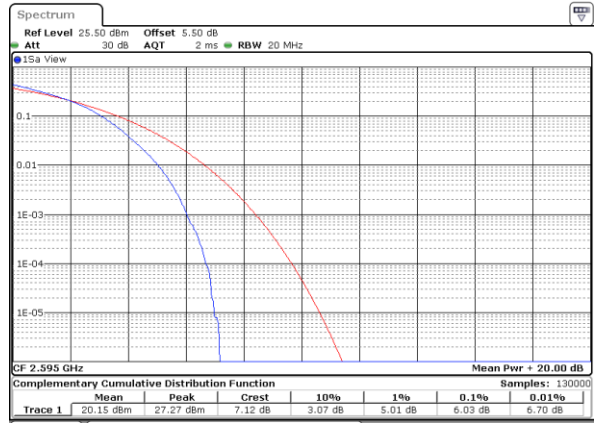

Date: 15 MAY 2018 09:15:31

Highest Channel / 1RB

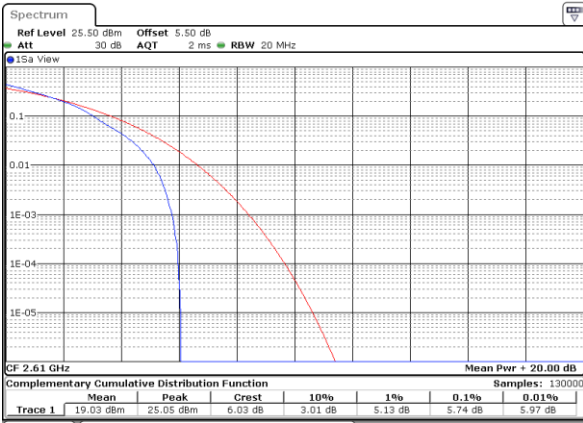

Date: 15 MAY 2018 09:16:54

Highest Channel / Full RB

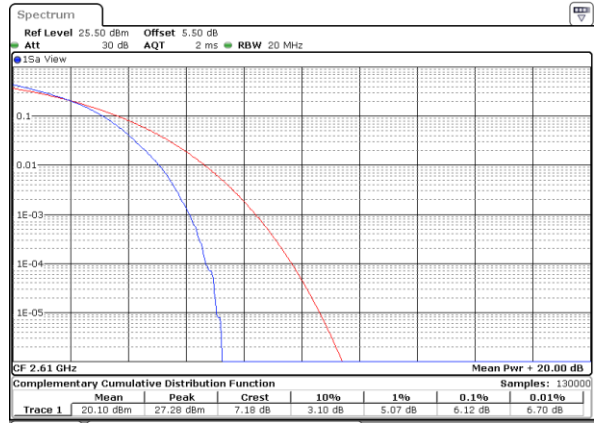

Date: 15 MAY 2018 09:17:26



LTE Band 41 / 20MHz / QPSK

Lowest Channel / 1RB

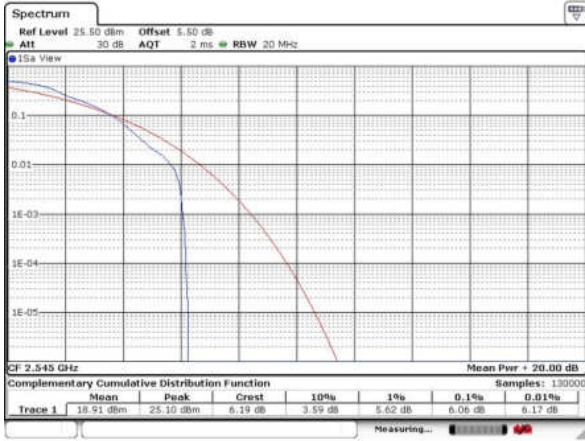

Date: 15 MAY 2018 14:41:53

Lowest Channel / Full RB

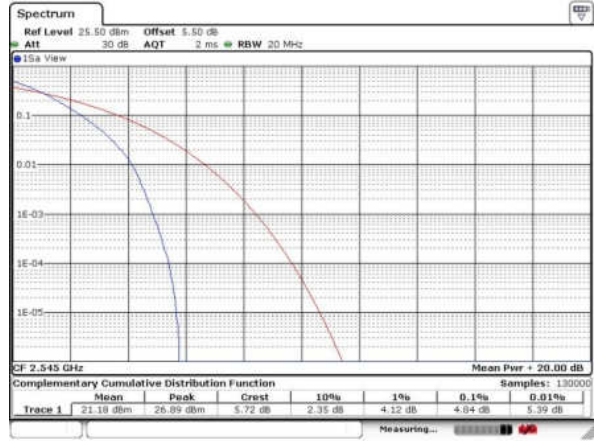

Date: 15 MAY 2018 14:43:30

Middle Channel / 1RB

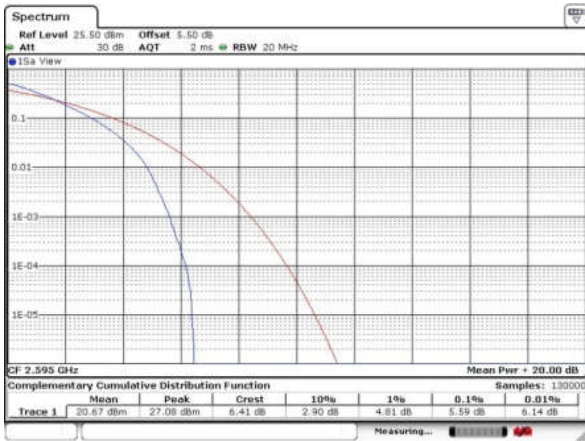

Date: 15 MAY 2018 14:43:37

Middle Channel / Full RB

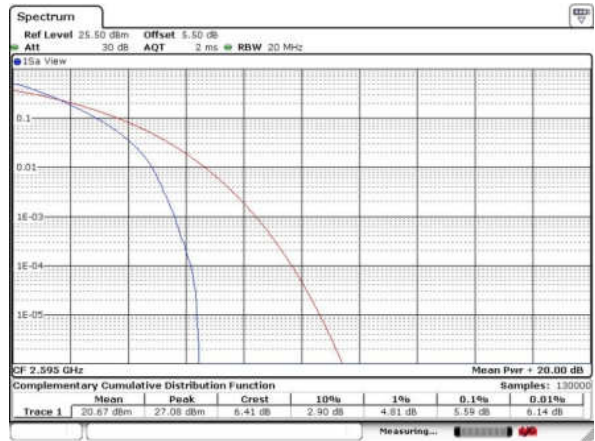

Date: 15 MAY 2018 14:43:37

Highest Channel / 1RB

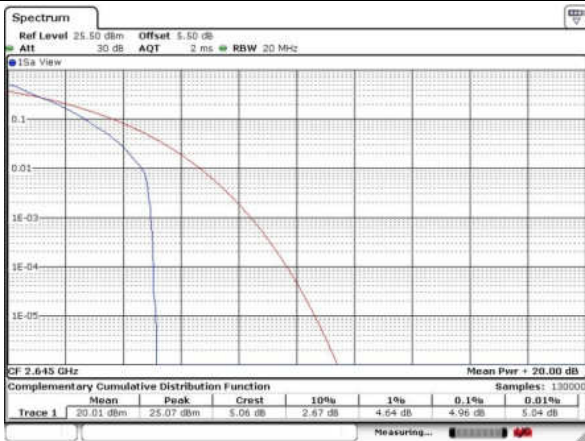

Date: 15 MAY 2018 14:45:54

Highest Channel / Full RB

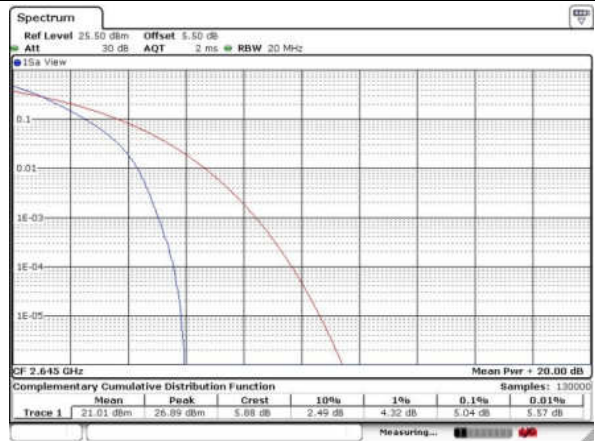

Date: 15 MAY 2018 14:44:06



LTE Band 41 / 20MHz / 16QAM

Lowest Channel / 1RB

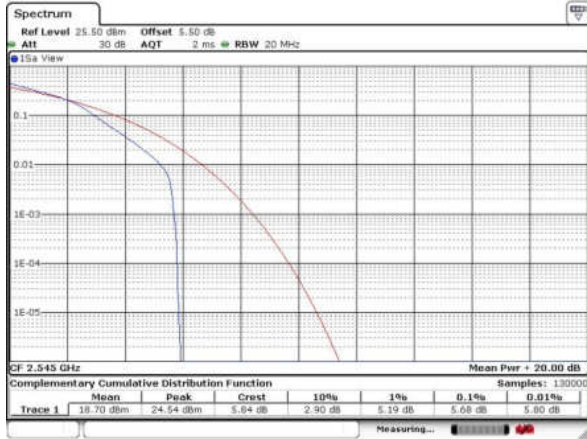

Date: 15 MAY 2018 14:41:26

Lowest Channel / Full RB

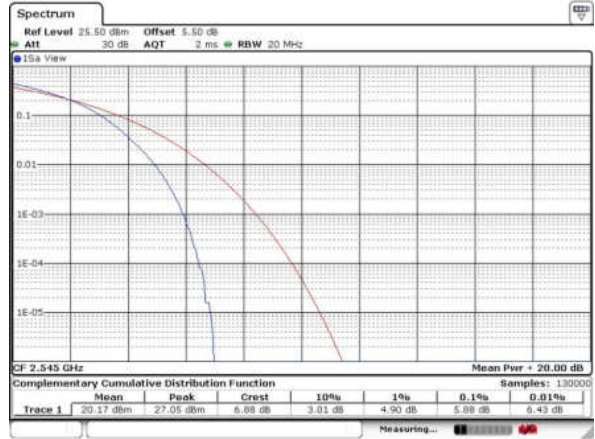

Date: 15 MAY 2018 14:41:08

Middle Channel / 1RB

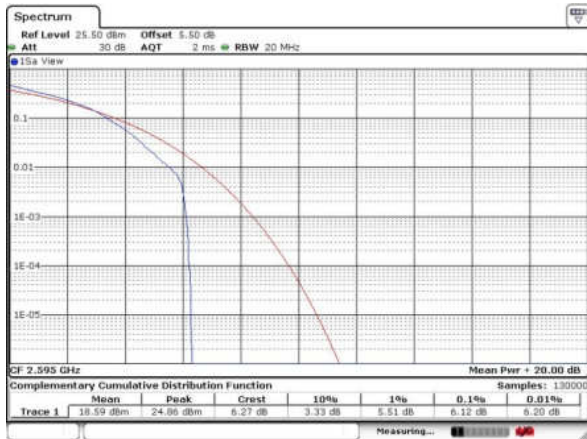

Date: 15 MAY 2018 14:42:48

Middle Channel / Full RB

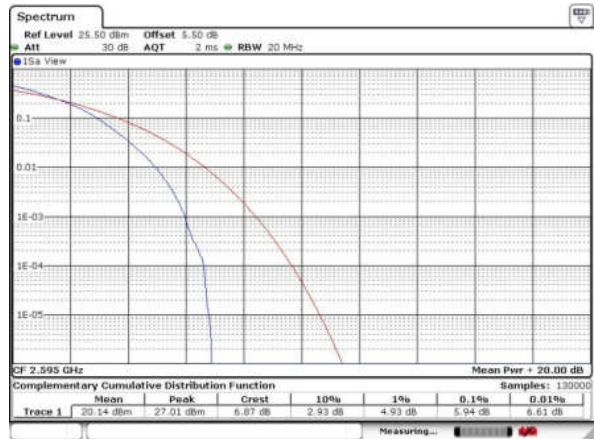

Date: 15 MAY 2018 14:43:03

Highest Channel / 1RB

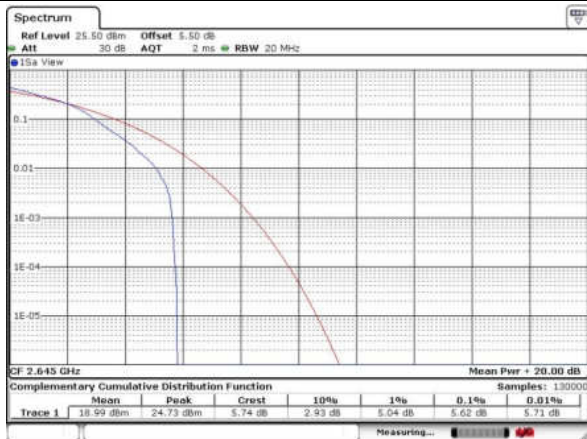

Date: 15 MAY 2018 14:44:50

Highest Channel / Full RB

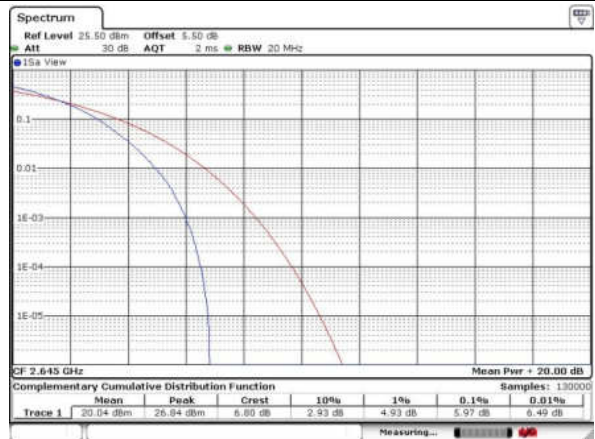

Date: 15 MAY 2018 14:44:26



26dB Bandwidth

Mode	LTE Band 38 : 26dB BW(MHz)											
	1.4MHz		3MHz		5MHz		10MHz		15MHz		20MHz	
Mod.	QPSK	16QAM	QPSK	16QAM	QPSK	16QAM	QPSK	16QAM	QPSK	16QAM	QPSK	16QAM
Lowest CH	-	-	-	-	4.85	4.81	9.69	9.73	14.15	14.30	20.02	20.10
Middle CH	-	-	-	-	4.88	4.94	9.71	9.89	14.27	14.30	20.10	20.10
Highest CH	-	-	-	-	4.89	4.91	9.81	9.71	14.21	14.18	20.18	20.06

Mode	LTE Band 41 : 26dB BW(MHz)											
	1.4MHz		3MHz		5MHz		10MHz		15MHz		20MHz	
Mod.	QPSK	16QAM	QPSK	16QAM	QPSK	16QAM	QPSK	16QAM	QPSK	16QAM	QPSK	16QAM
Lowest CH	-	-	-	-	4.80	4.94	9.73	9.63	14.18	14.09	19.98	20.10
Middle CH	-	-	-	-	4.89	4.74	9.87	9.69	14.33	14.21	20.30	20.06
Highest CH	-	-	-	-	4.82	4.86	9.67	9.87	14.36	14.18	20.18	20.10



LTE Band 38

Lowest Channel / 5MHz / QPSK

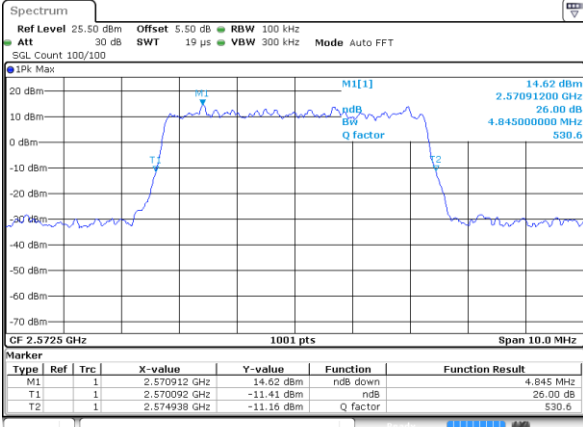

Date: 14 MAY 2018 17:51:57

Lowest Channel / 5MHz / 16QAM

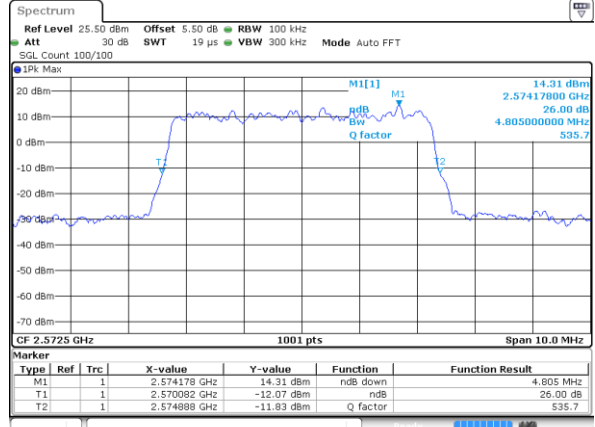

Date: 15 MAY 2018 09:19:51

Middle Channel / 5MHz / QPSK

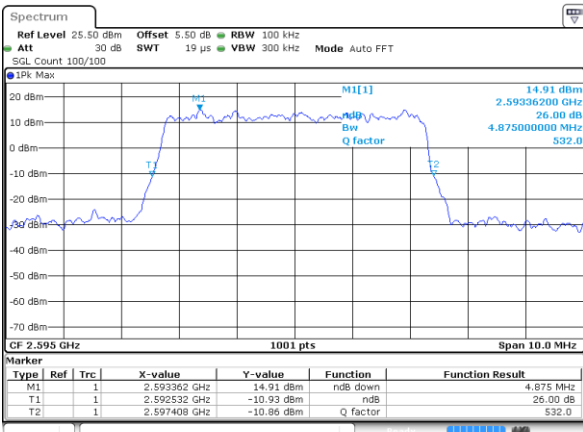

Date: 14 MAY 2018 17:52:39

Middle Channel / 5MHz / 16QAM

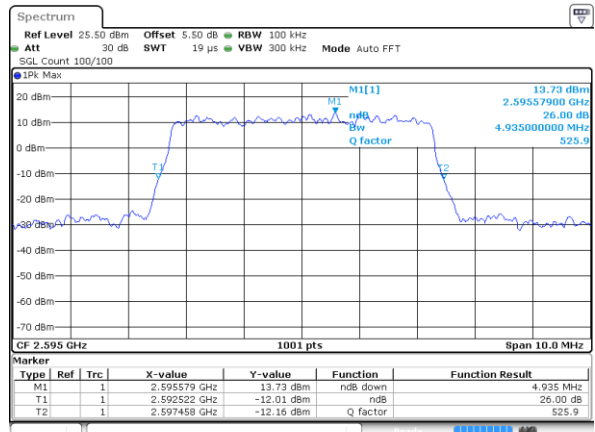

Date: 15 MAY 2018 09:18:33

Highest Channel / 5MHz / QPSK

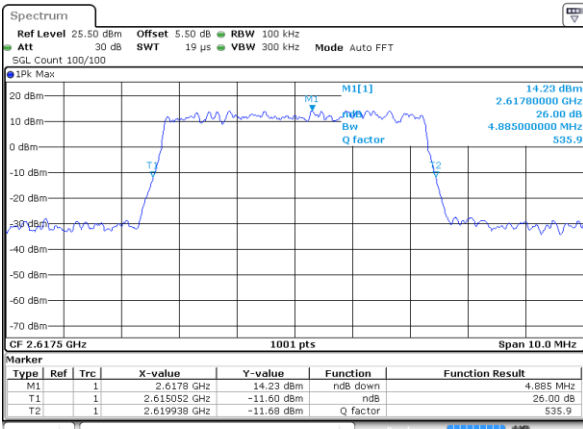

Date: 14 MAY 2018 17:53:22

Highest Channel / 5MHz / 16QAM

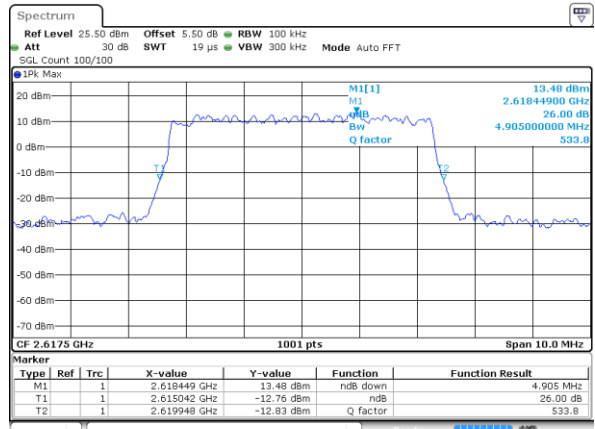

Date: 14 MAY 2018 17:53:33



LTE Band 38

Lowest Channel / 10MHz / QPSK

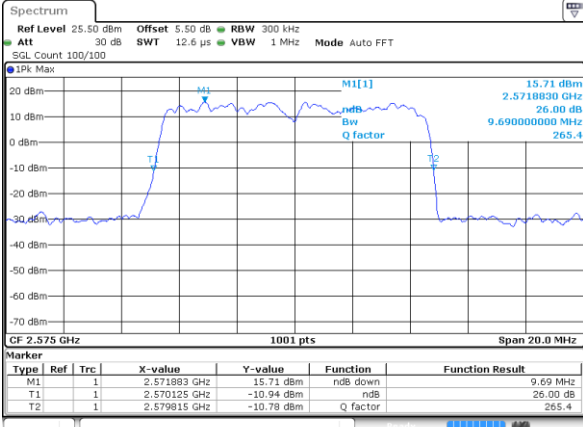

Date: 15 MAY 2018 09:20:31

Lowest Channel / 10MHz / 16QAM

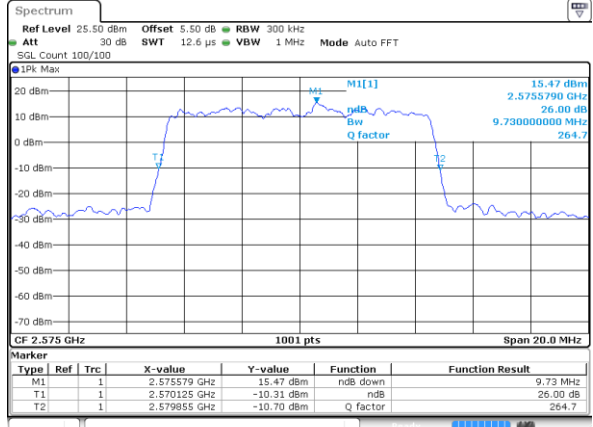

Date: 14 MAY 2018 17:54:19

Middle Channel / 10MHz / QPSK

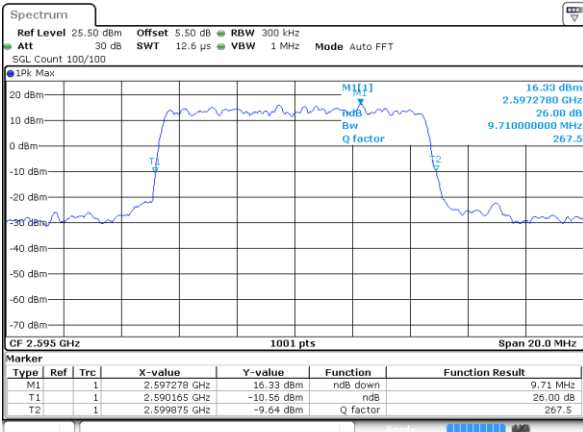

Date: 14 MAY 2018 17:54:53

Middle Channel / 10MHz / 16QAM



Date: 14 MAY 2018 17:55:03

Highest Channel / 10MHz / QPSK

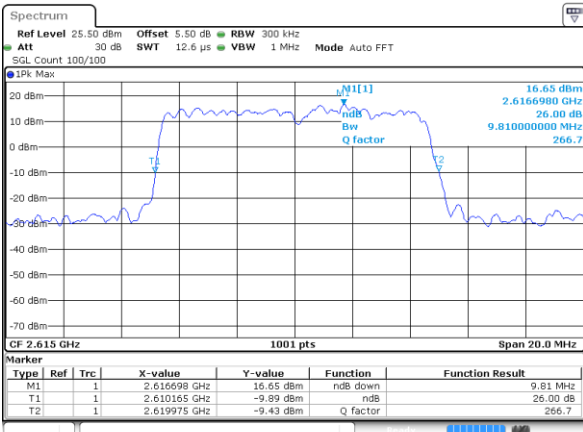

Date: 14 MAY 2018 17:55:35

Highest Channel / 10MHz / 16QAM

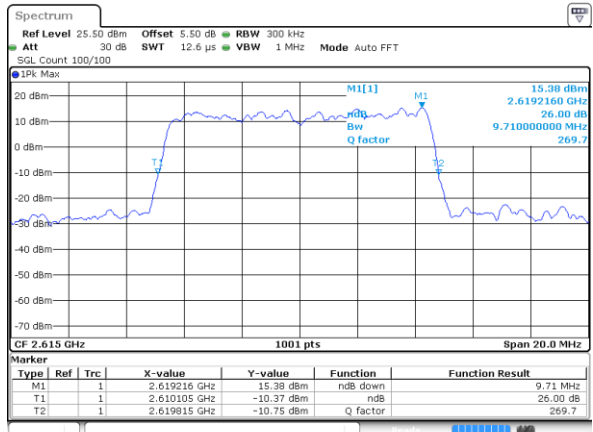

Date: 14 MAY 2018 17:55:46



LTE Band 38

Lowest Channel / 15MHz / QPSK

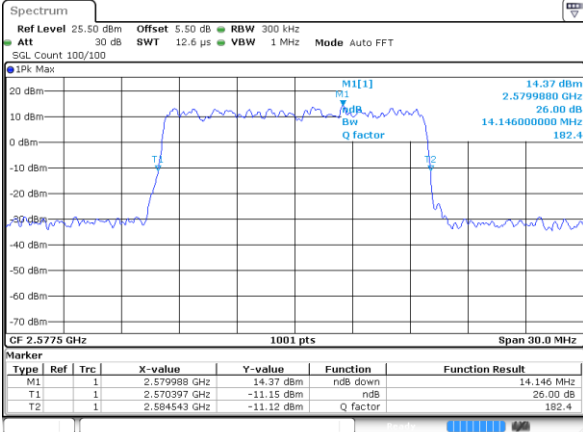

Date: 14 MAY 2018 17:56:18

Lowest Channel / 15MHz / 16QAM

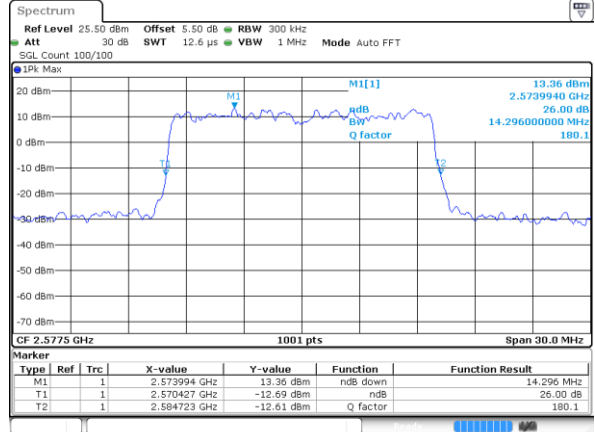

Date: 14 MAY 2018 17:56:29

Middle Channel / 15MHz / QPSK

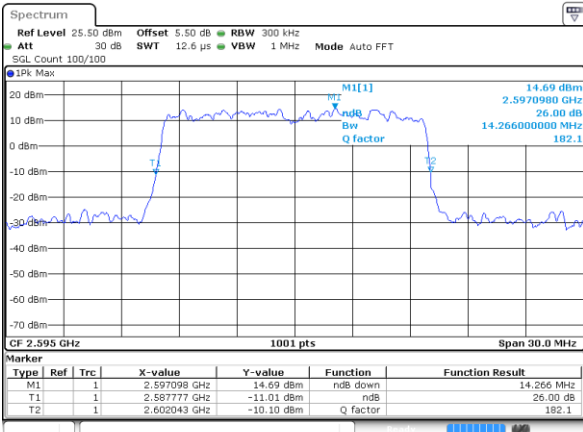

Date: 14 MAY 2018 17:57:01

Middle Channel / 15MHz / 16QAM

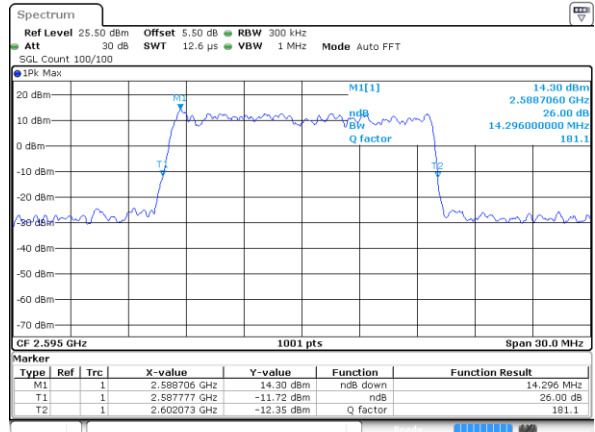

Date: 14 MAY 2018 17:57:12

Highest Channel / 15MHz / QPSK

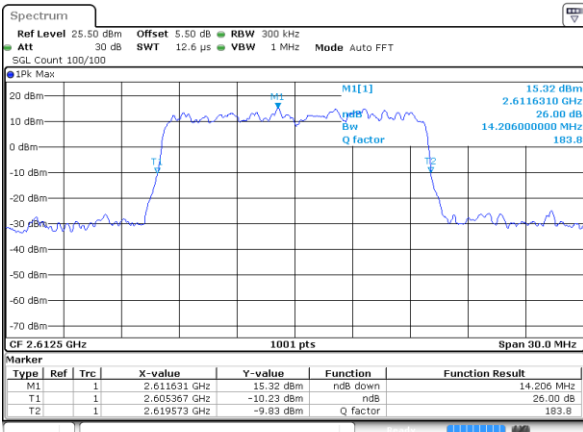

Date: 14 MAY 2018 17:57:44

Highest Channel / 15MHz / 16QAM

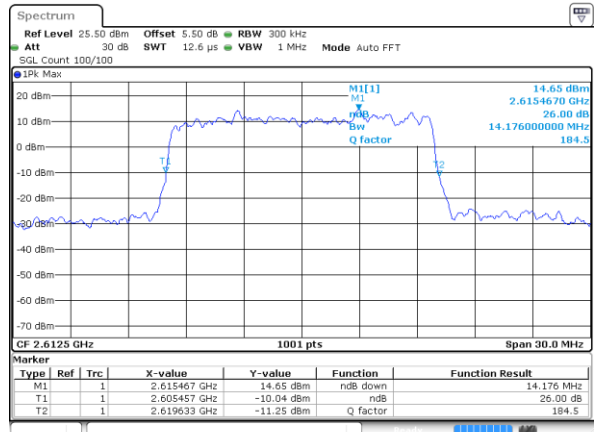

Date: 14 MAY 2018 17:57:55



LTE Band 38

Lowest Channel / 20MHz / QPSK

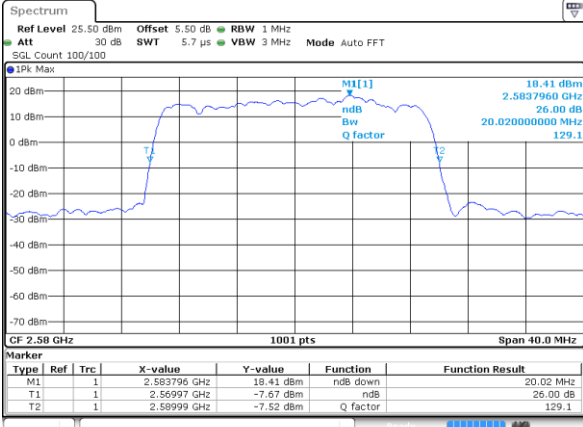

Date: 14 MAY 2018 17:58:28

Lowest Channel / 20MHz / 16QAM

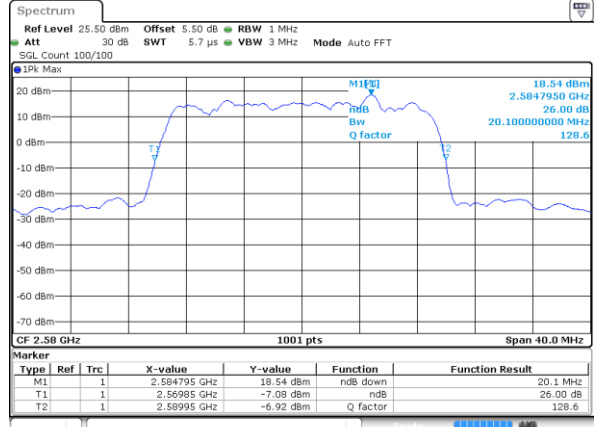

Date: 14 MAY 2018 17:58:39

Middle Channel / 20MHz / QPSK

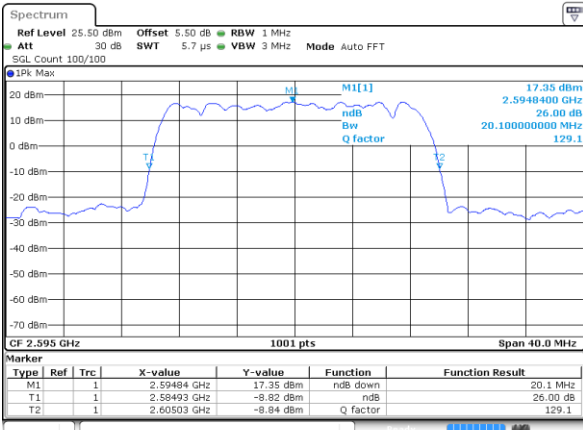

Date: 14 MAY 2018 17:58:13

Middle Channel / 20MHz / 16QAM

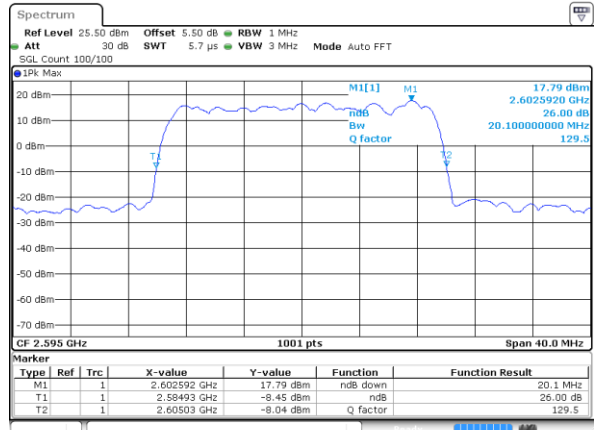

Date: 14 MAY 2018 17:58:24

Highest Channel / 20MHz / QPSK

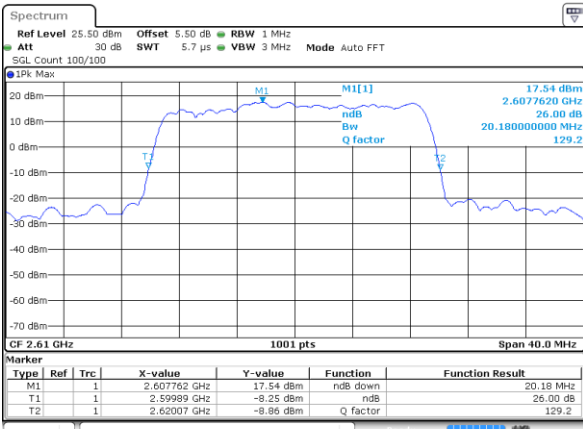

Date: 14 MAY 2018 17:59:57

Highest Channel / 20MHz / 16QAM

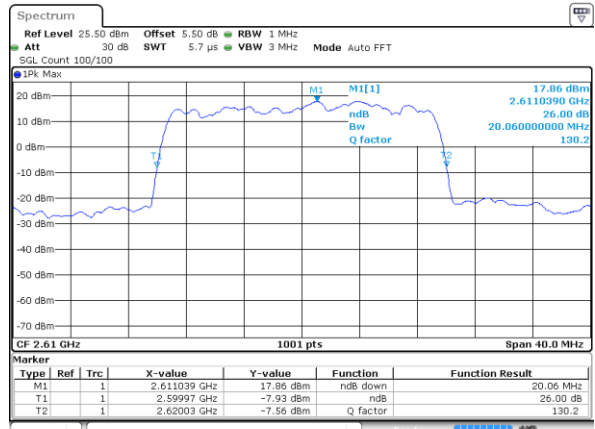

Date: 14 MAY 2018 18:00:08



LTE Band 41

Lowest Channel / 5MHz / QPSK

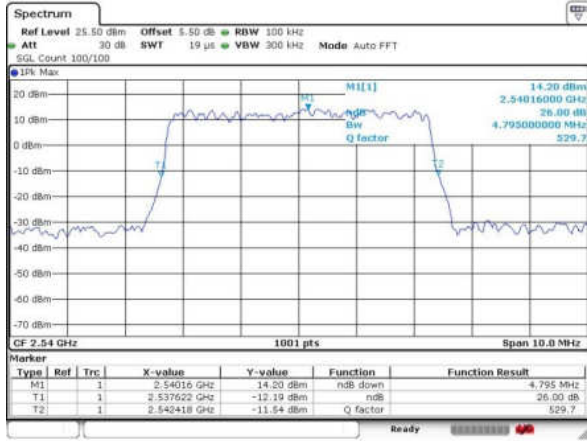

Date: 15 MAY 2018 14:31:08

Lowest Channel / 5MHz / 16QAM

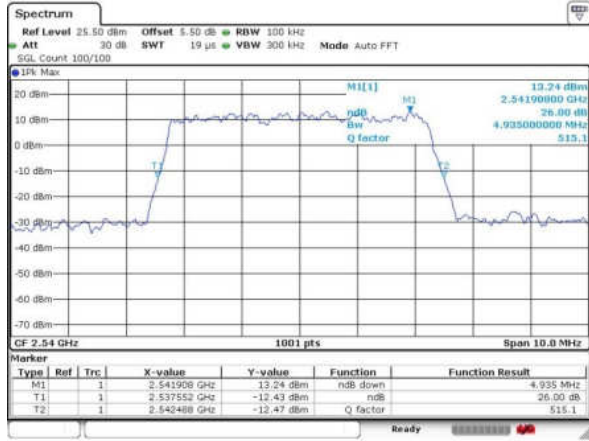

Date: 15 MAY 2018 14:30:37

Middle Channel / 5MHz / QPSK

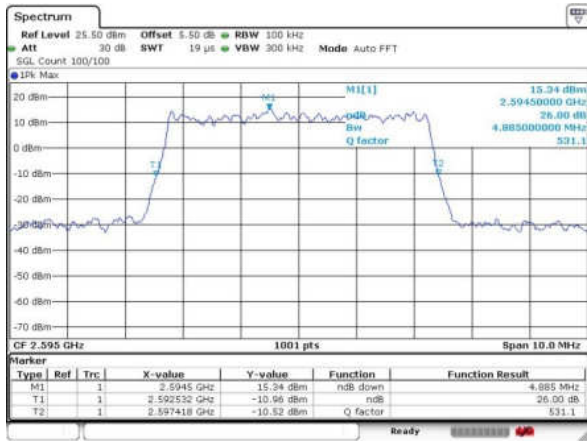

Date: 15 MAY 2018 14:31:28

Middle Channel / 5MHz / 16QAM

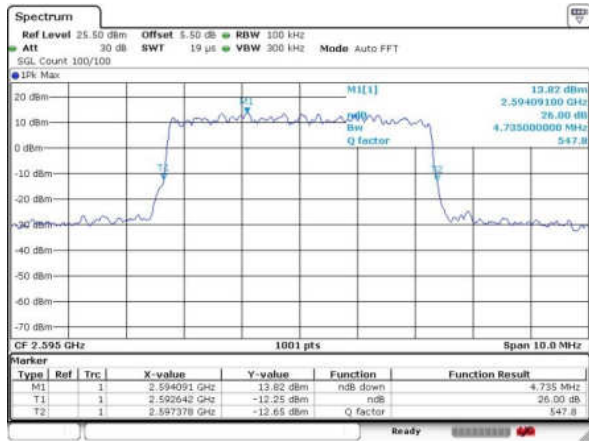

Date: 15 MAY 2018 14:31:53

Highest Channel / 5MHz / QPSK

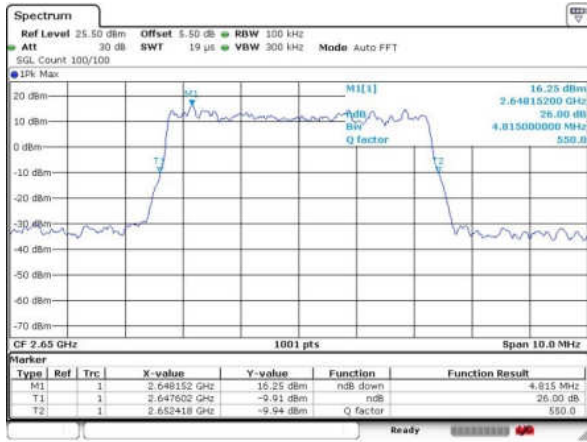

Date: 15 MAY 2018 14:32:45

Highest Channel / 5MHz / 16QAM

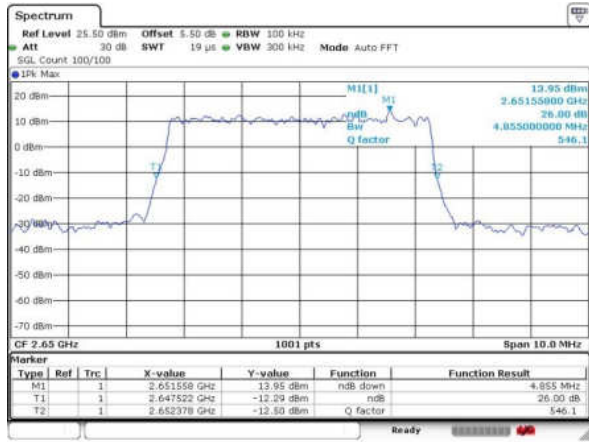

Date: 15 MAY 2018 14:32:22



LTE Band 41

Lowest Channel / 10MHz / QPSK

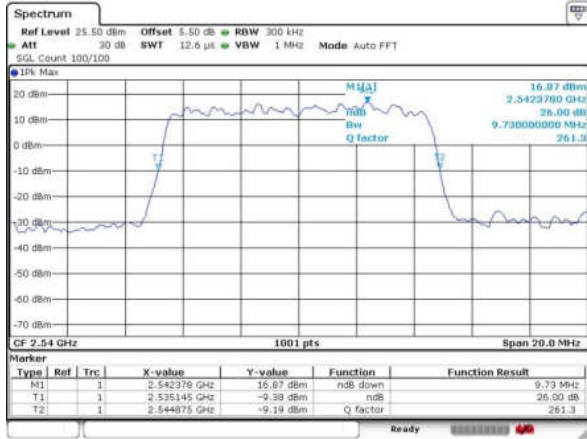

Date: 15 MAY 2018 14:27:09

Lowest Channel / 10MHz / 16QAM

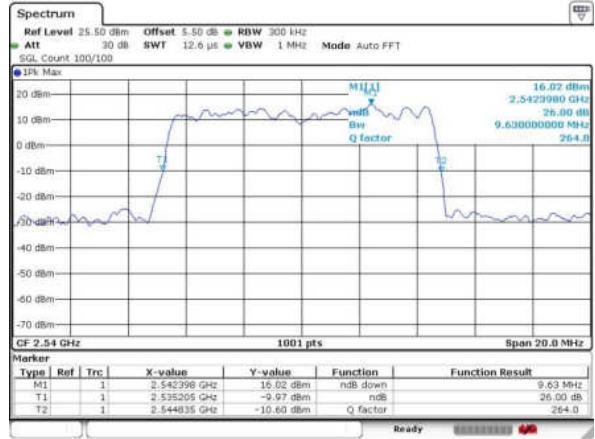

Date: 15 MAY 2018 14:27:57

Middle Channel / 10MHz / QPSK

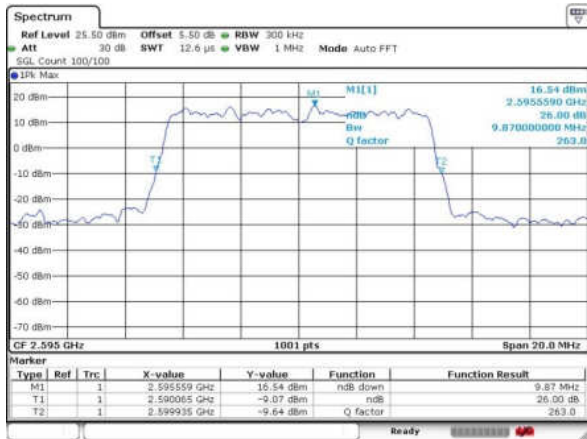

Date: 15 MAY 2018 14:28:47

Middle Channel / 10MHz / 16QAM

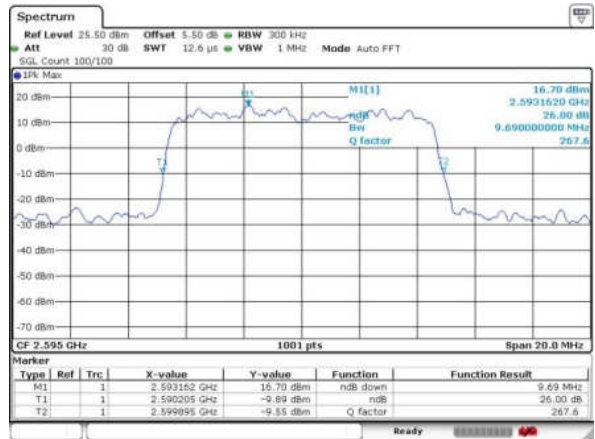

Date: 15 MAY 2018 14:28:27

Highest Channel / 10MHz / QPSK

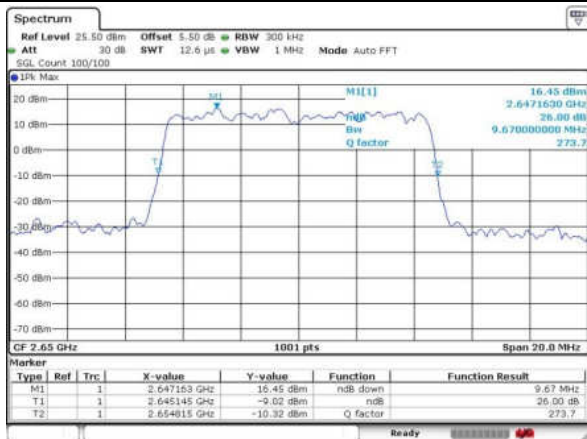

Date: 15 MAY 2018 14:29:18

Highest Channel / 10MHz / 16QAM

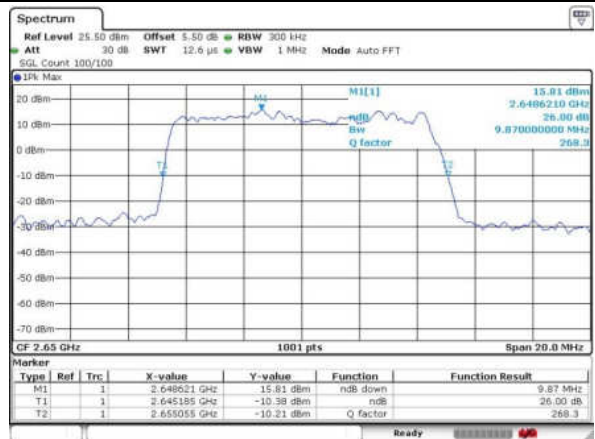

Date: 15 MAY 2018 14:29:38



LTE Band 41

Lowest Channel / 15MHz / QPSK

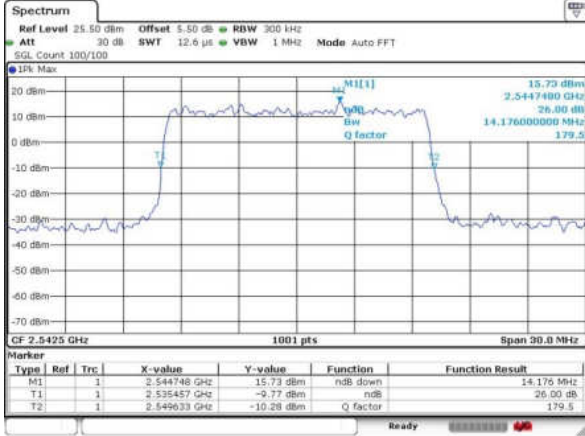

Date: 15 MAY 2018 14:23:14

Lowest Channel / 15MHz / 16QAM

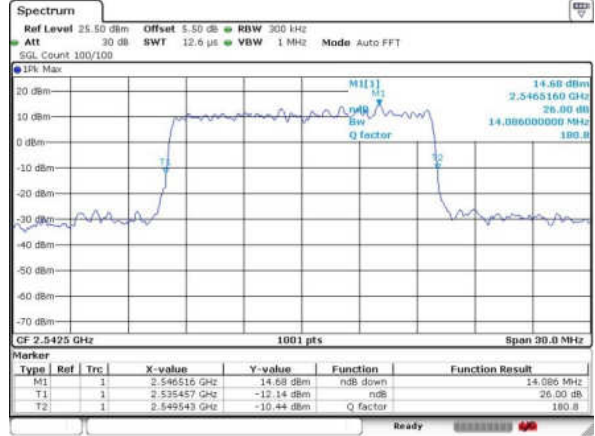

Date: 15 MAY 2018 14:23:43

Middle Channel / 15MHz / QPSK

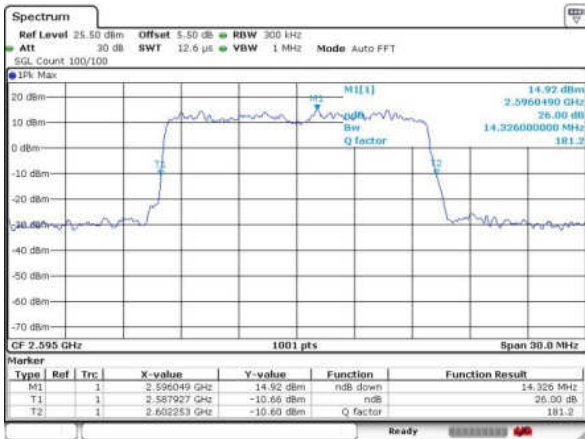

Date: 15 MAY 2018 14:24:31

Middle Channel / 15MHz / 16QAM

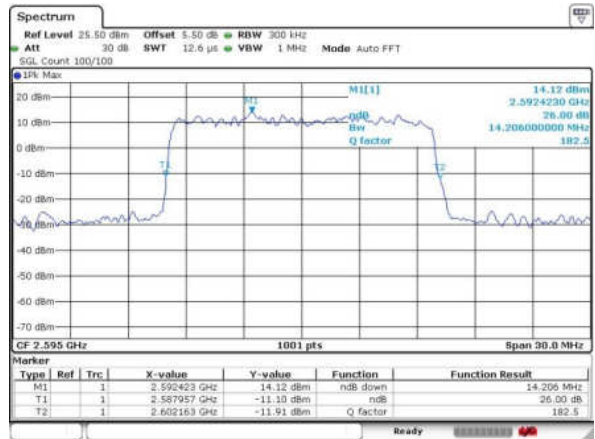

Date: 15 MAY 2018 14:24:07

Highest Channel / 15MHz / QPSK

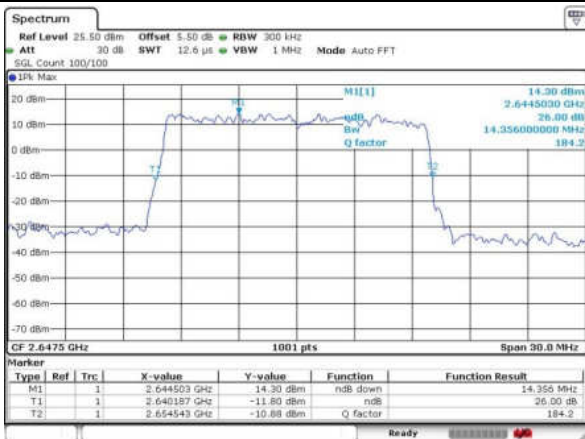

Date: 15 MAY 2018 14:25:06

Highest Channel / 15MHz / 16QAM

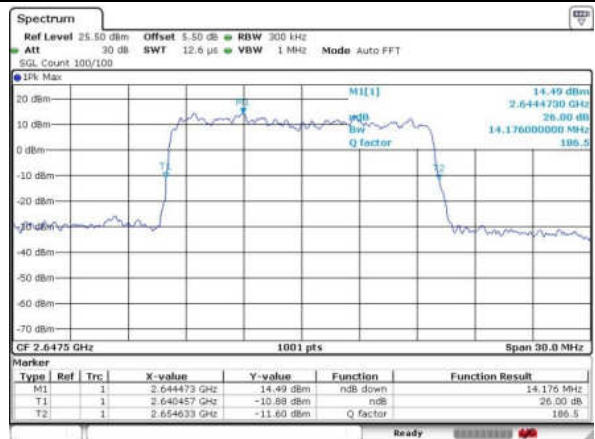

Date: 15 MAY 2018 14:25:30



LTE Band 41

Lowest Channel / 20MHz / QPSK

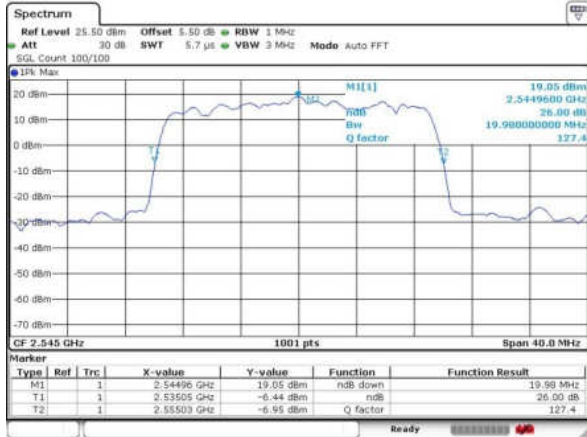

Date: 15 MAY 2018 14:21:01

Lowest Channel / 20MHz / 16QAM

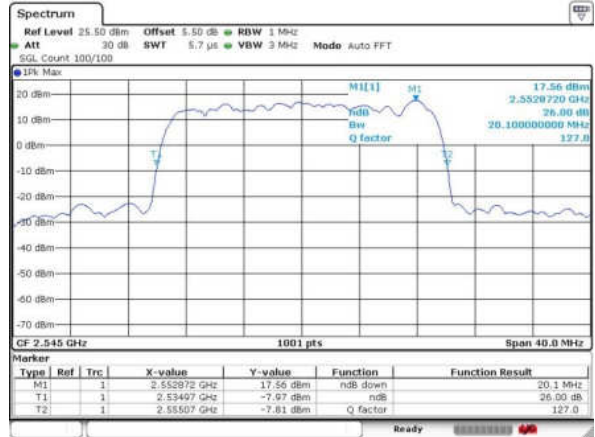

Date: 15 MAY 2018 14:20:36

Middle Channel / 20MHz / QPSK

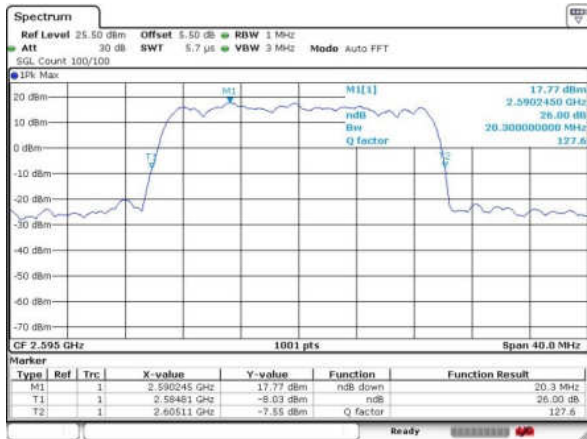

Date: 15 MAY 2018 14:19:38

Middle Channel / 20MHz / 16QAM

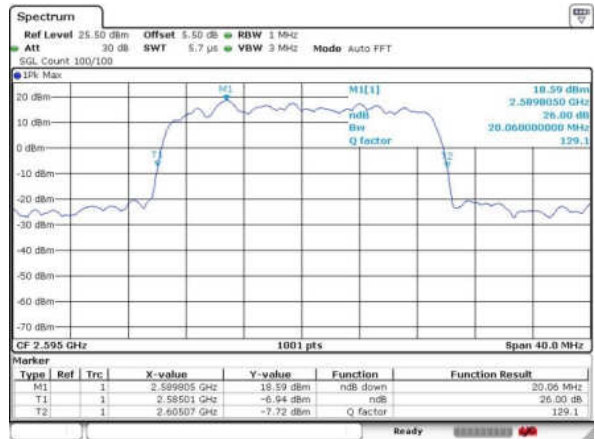

Date: 15 MAY 2018 14:20:03

Highest Channel / 20MHz / QPSK

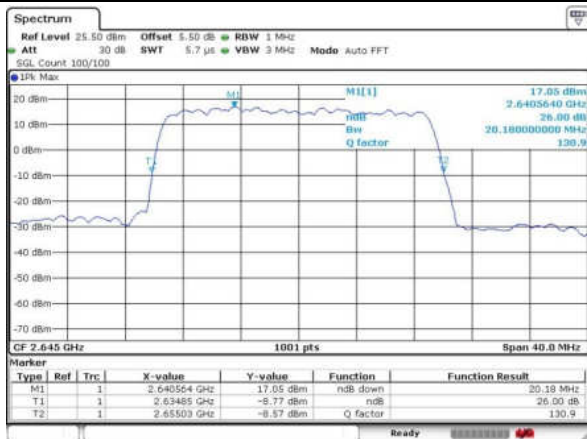

Date: 15 MAY 2018 14:19:17

Highest Channel / 20MHz / 16QAM

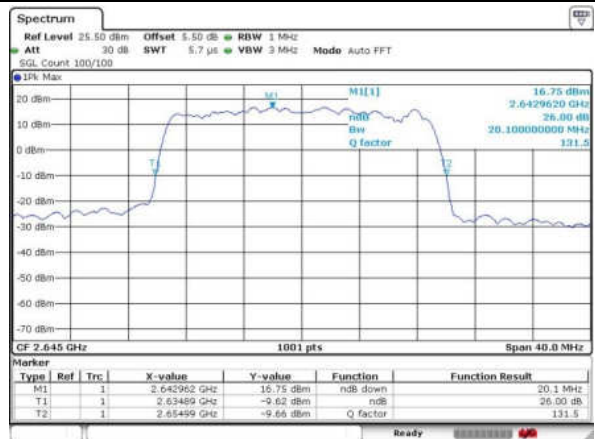

Date: 15 MAY 2018 14:18:46



Occupied Bandwidth

Mode	LTE Band 38 : 99%OBW(MHz)											
	1.4MHz		3MHz		5MHz		10MHz		15MHz		20MHz	
Mod.	QPSK	16QAM	QPSK	16QAM	QPSK	16QAM	QPSK	16QAM	QPSK	16QAM	QPSK	16QAM
Lowest CH	-	-	-	-	4.48	4.48	9.05	9.01	13.46	13.46	18.18	18.14
Middle CH	-	-	-	-	4.48	4.49	8.97	9.03	13.43	13.46	18.22	18.34
Highest CH	-	-	-	-	4.51	4.46	9.03	8.97	13.43	13.49	18.42	18.30

Mode	LTE Band 41 : 99%OBW(MHz)											
	1.4MHz		3MHz		5MHz		10MHz		15MHz		20MHz	
Mod.	QPSK	16QAM	QPSK	16QAM	QPSK	16QAM	QPSK	16QAM	QPSK	16QAM	QPSK	16QAM
Lowest CH	-	-	-	-	4.50	4.49	8.93	8.95	13.43	13.43	18.42	18.18
Middle CH	-	-	-	-	4.50	4.50	9.03	8.95	13.43	13.49	18.34	18.18
Highest CH	-	-	-	-	4.49	4.51	8.99	9.05	13.43	13.43	18.22	18.34



LTE Band 38

Lowest Channel / 5MHz / QPSK

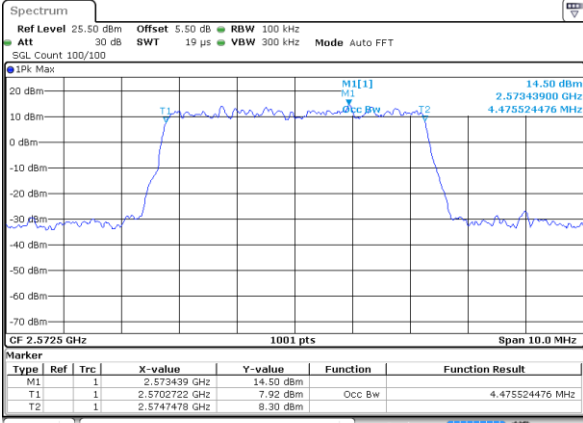

Date: 14 MAY 2018 17:51:35

Lowest Channel / 5MHz / 16QAM

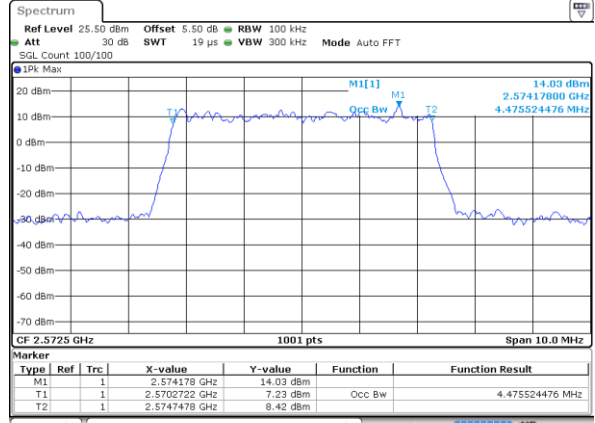

Date: 15 MAY 2018 09:19:26

Middle Channel / 5MHz / QPSK

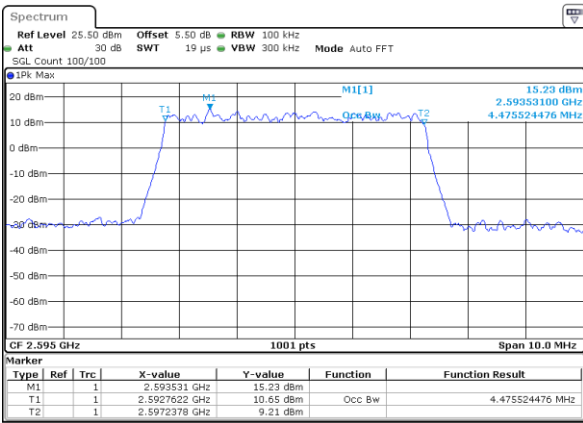

Date: 14 MAY 2018 17:52:18

Middle Channel / 5MHz / 16QAM

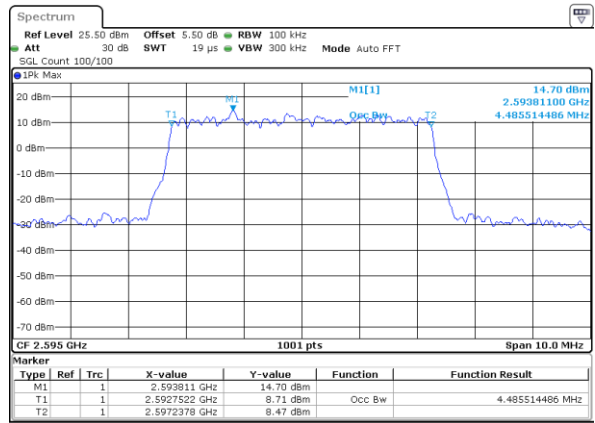

Date: 14 MAY 2018 17:52:29

Highest Channel / 5MHz / QPSK

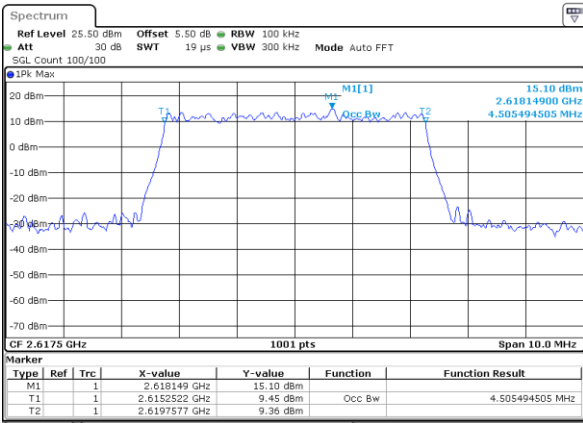

Date: 14 MAY 2018 17:53:01

Highest Channel / 5MHz / 16QAM

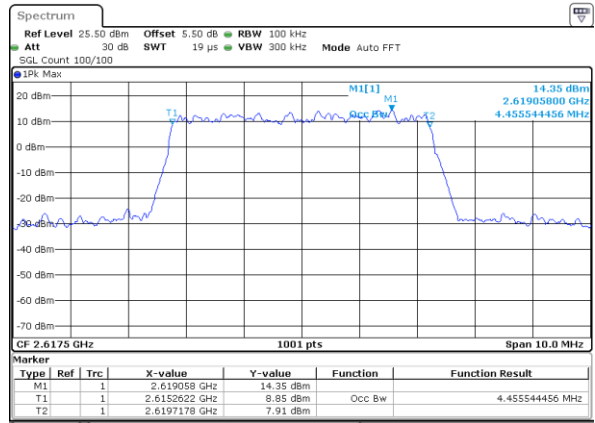

Date: 14 MAY 2018 17:53:12



LTE Band 38

Lowest Channel / 10MHz / QPSK

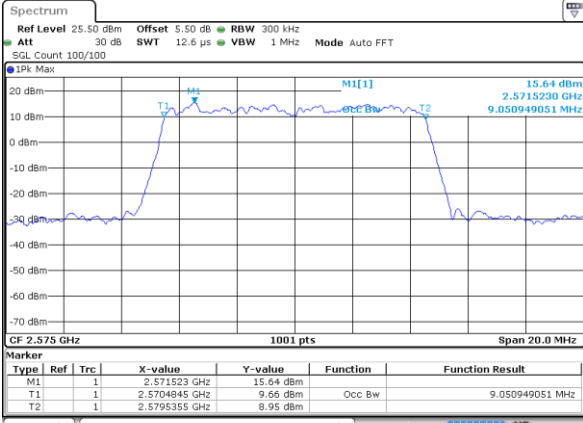

Date: 14.MAY.2018 17:53:45

Lowest Channel / 10MHz / 16QAM

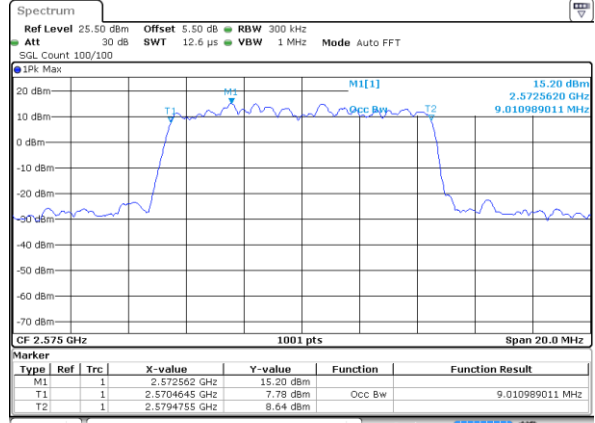

Date: 14.MAY.2018 17:53:57

Middle Channel / 10MHz / QPSK

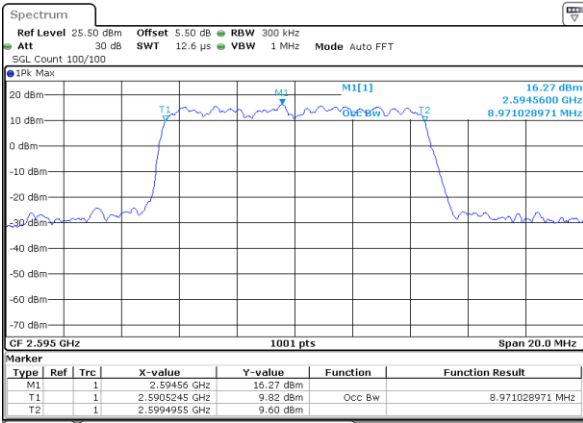

Date: 14.MAY.2018 17:54:31

Middle Channel / 10MHz / 16QAM

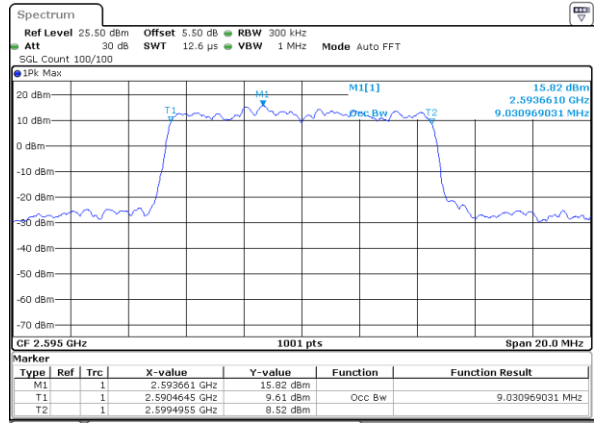

Date: 14.MAY.2018 17:54:42

Highest Channel / 10MHz / QPSK

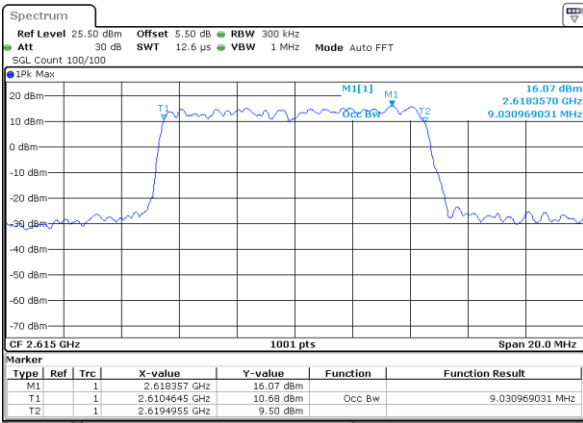

Date: 14.MAY.2018 17:55:14

Highest Channel / 10MHz / 16QAM

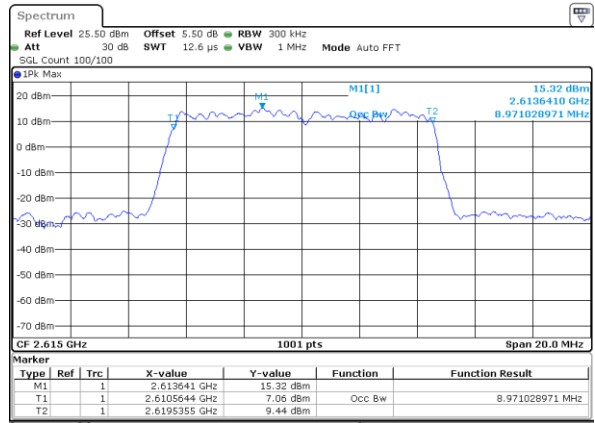

Date: 14.MAY.2018 17:55:25



LTE Band 38

Lowest Channel / 15MHz / QPSK

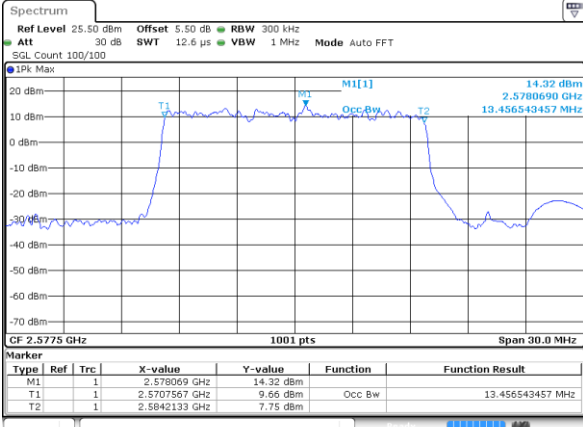

Date: 14 MAY 2018 17:55:57

Lowest Channel / 15MHz / 16QAM

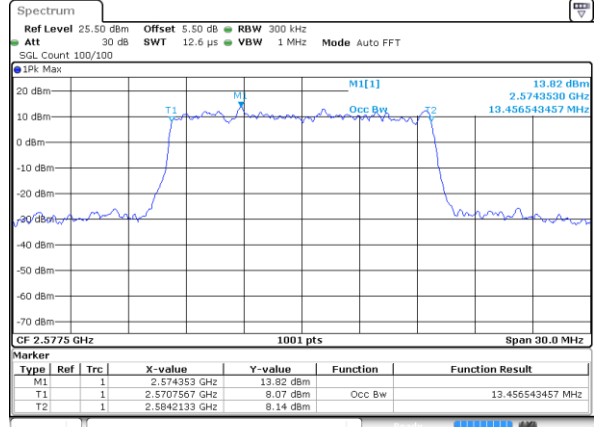

Date: 15 MAY 2018 09:05:01

Middle Channel / 15MHz / QPSK

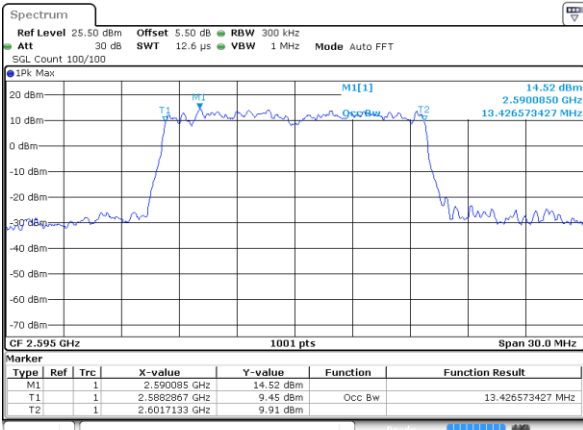

Date: 14 MAY 2018 17:56:40

Middle Channel / 15MHz / 16QAM

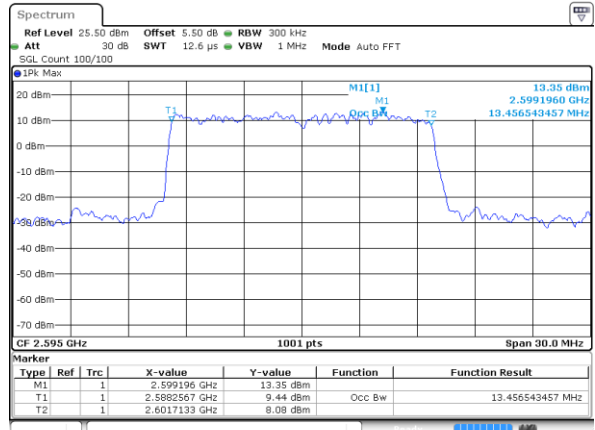

Date: 14 MAY 2018 17:56:50

Highest Channel / 15MHz / QPSK

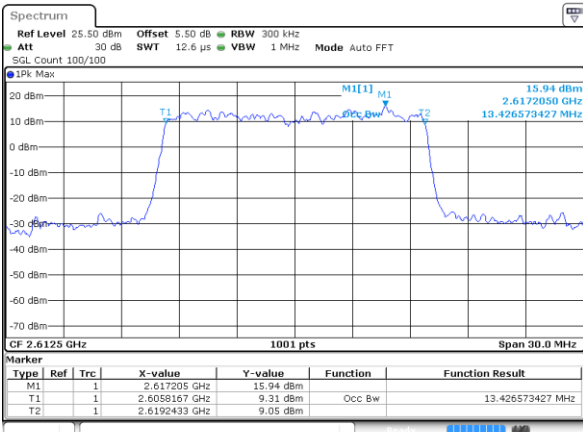

Date: 14 MAY 2018 17:57:23

Highest Channel / 15MHz / 16QAM

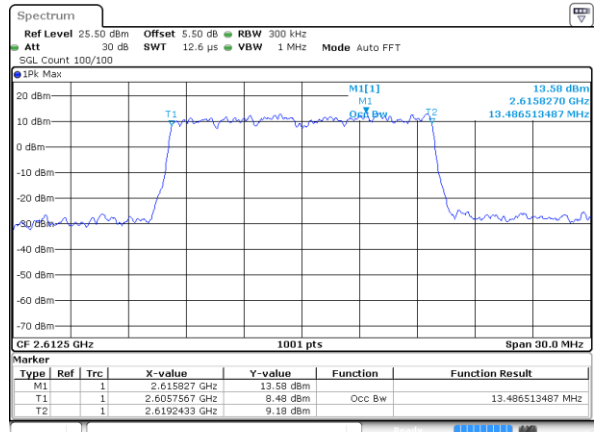

Date: 14 MAY 2018 17:57:33



LTE Band 38

Lowest Channel / 20MHz / QPSK

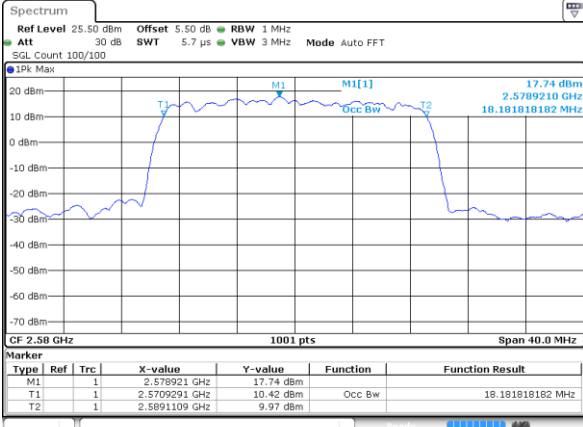

Date: 14 MAY 2018 17:58:06

Lowest Channel / 20MHz / 16QAM

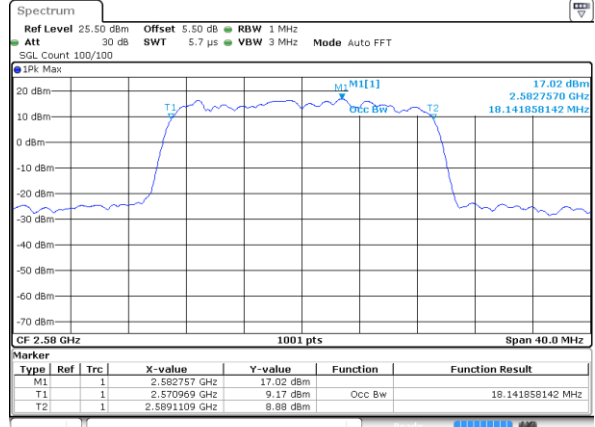

Date: 14 MAY 2018 17:58:17

Middle Channel / 20MHz / QPSK

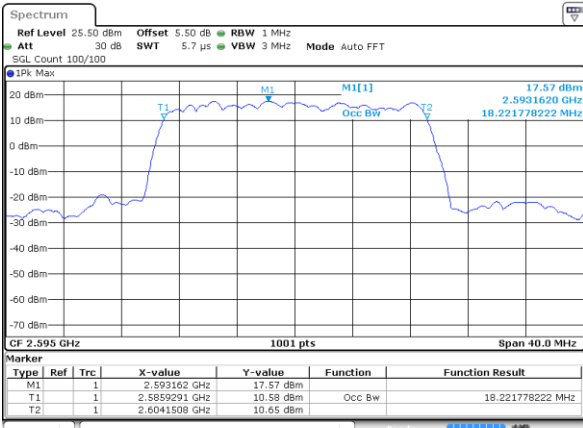

Date: 14 MAY 2018 17:58:50

Middle Channel / 20MHz / 16QAM

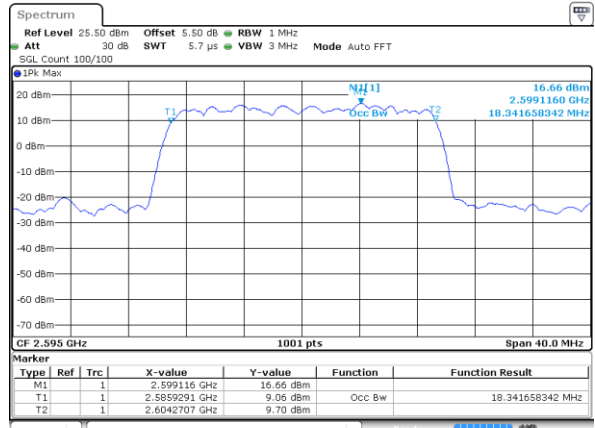

Date: 14 MAY 2018 17:59:01

Highest Channel / 20MHz / QPSK

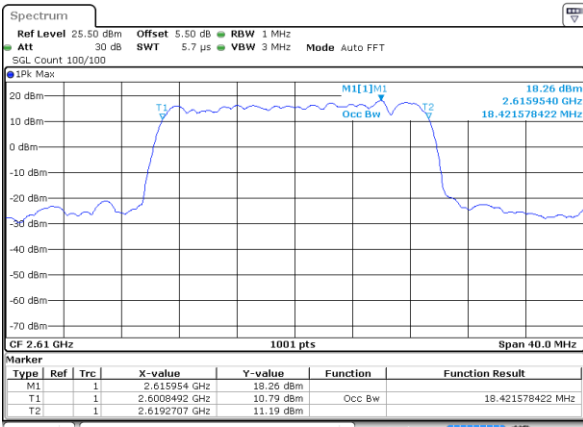

Date: 14 MAY 2018 17:59:35

Highest Channel / 20MHz / 16QAM

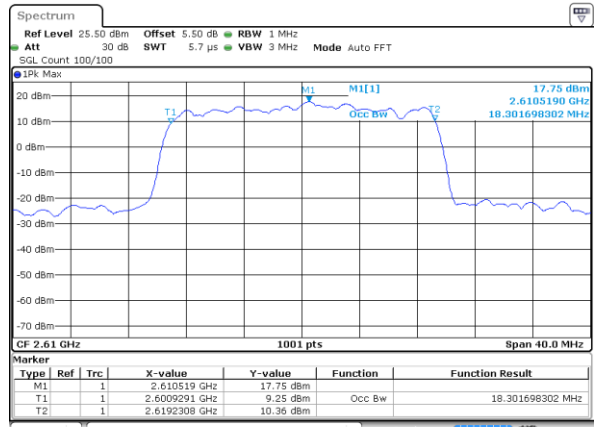

Date: 14 MAY 2018 17:59:46



LTE Band 41

Lowest Channel / 5MHz / QPSK

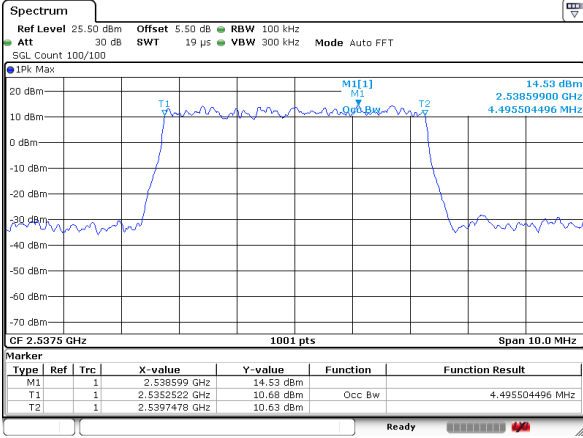

Date: 15 MAY 2018 14:02:20

Lowest Channel / 5MHz / 16QAM

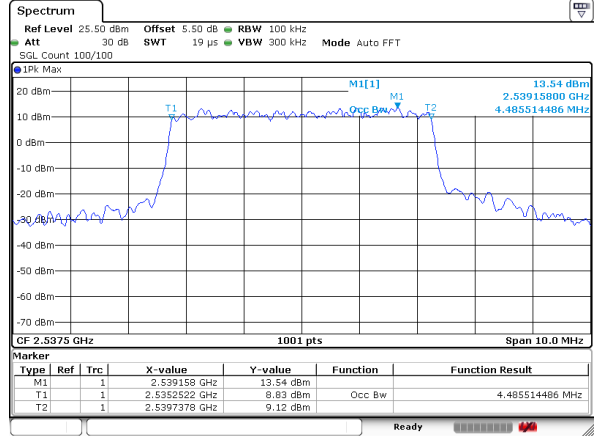

Date: 15 MAY 2018 14:01:29

Middle Channel / 5MHz / QPSK

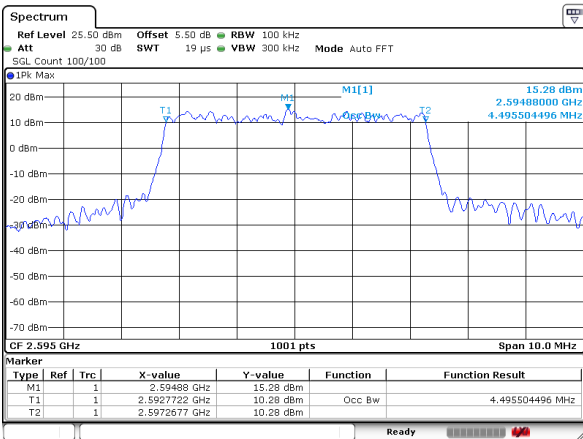

Date: 15 MAY 2018 14:02:37

Middle Channel / 5MHz / 16QAM

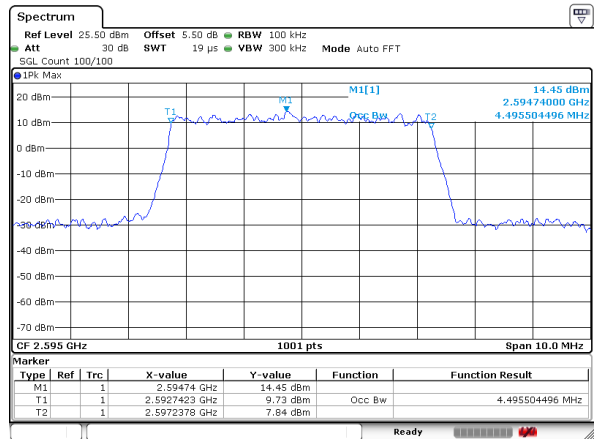

Date: 15 MAY 2018 14:03:17

Highest Channel / 5MHz / QPSK

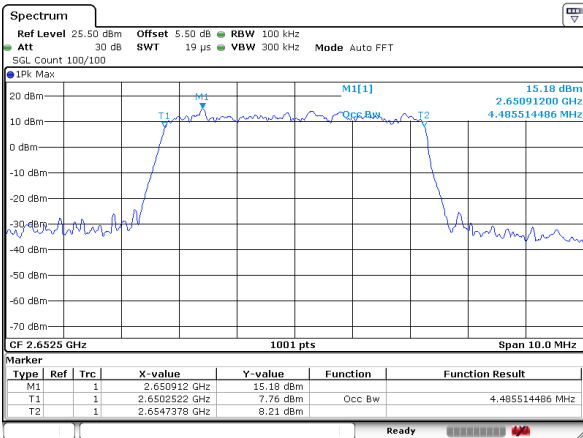

Date: 15 MAY 2018 14:04:26

Highest Channel / 5MHz / 16QAM

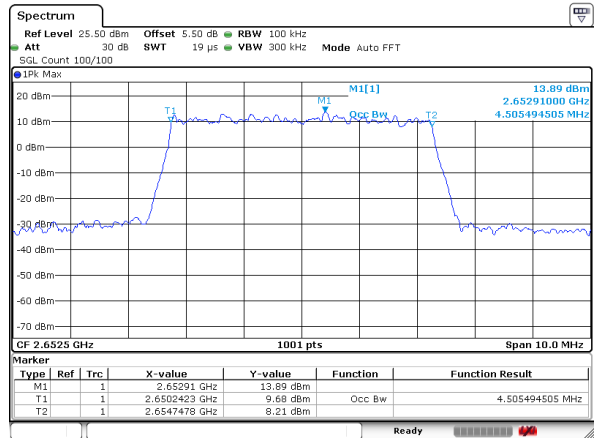

Date: 15 MAY 2018 14:03:57



LTE Band 41

Lowest Channel / 10MHz / QPSK

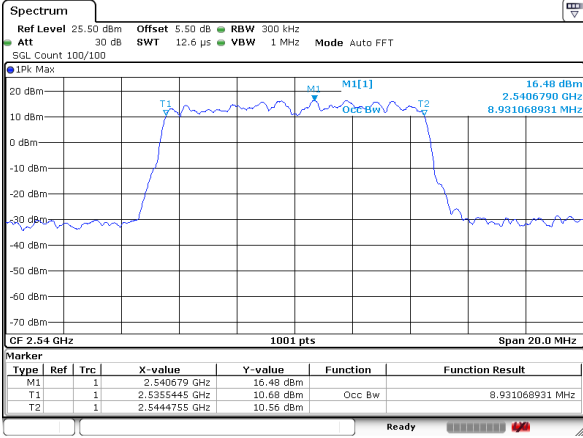

Date: 15 MAY 2018 14:06:20

Lowest Channel / 10MHz / 16QAM

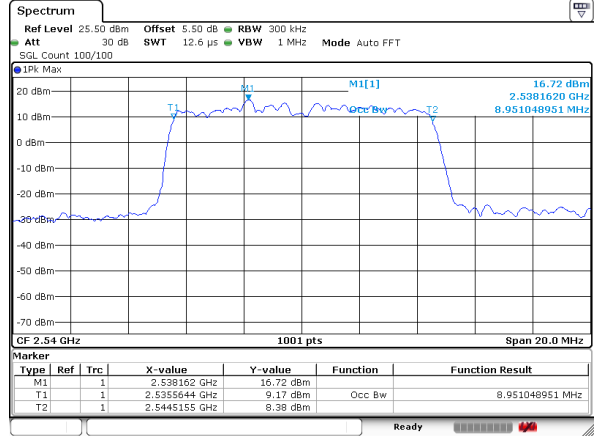

Date: 15 MAY 2018 14:06:31

Middle Channel / 10MHz / QPSK

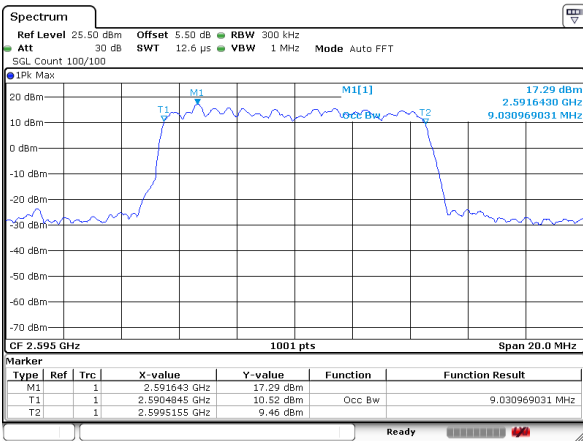

Date: 15 MAY 2018 14:07:27

Middle Channel / 10MHz / 16QAM

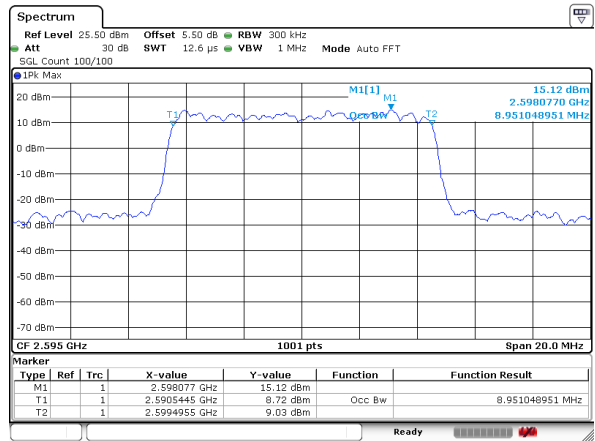

Date: 15 MAY 2018 14:07:24

Highest Channel / 10MHz / QPSK

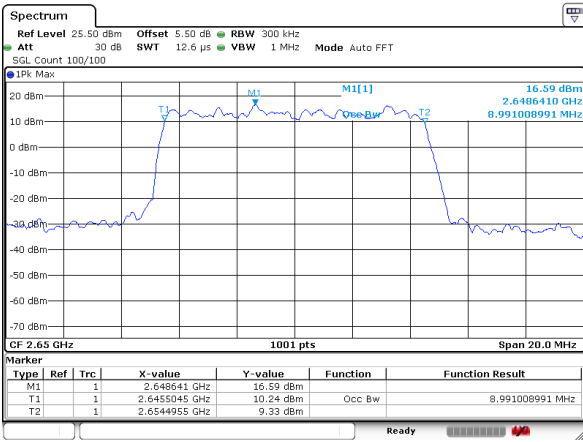

Date: 15 MAY 2018 14:07:55

Highest Channel / 10MHz / 16QAM

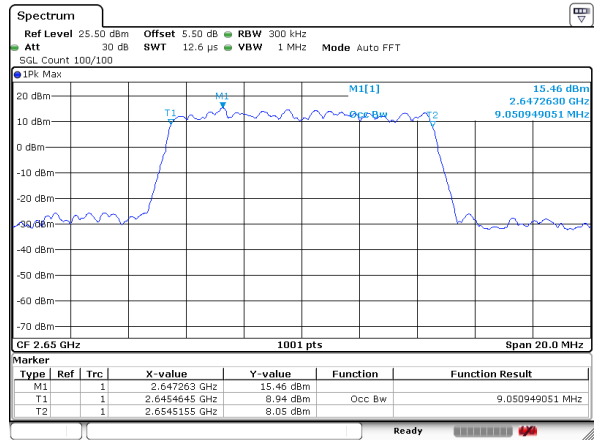

Date: 15 MAY 2018 14:08:19



LTE Band 41

Lowest Channel / 15MHz / QPSK

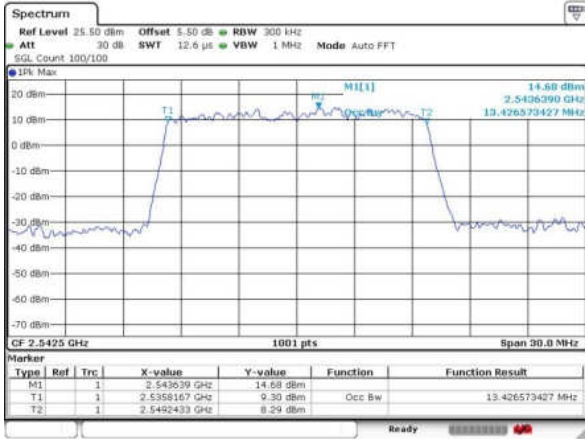

Date: 15 MAY 2018 14:11:57

Lowest Channel / 15MHz / 16QAM

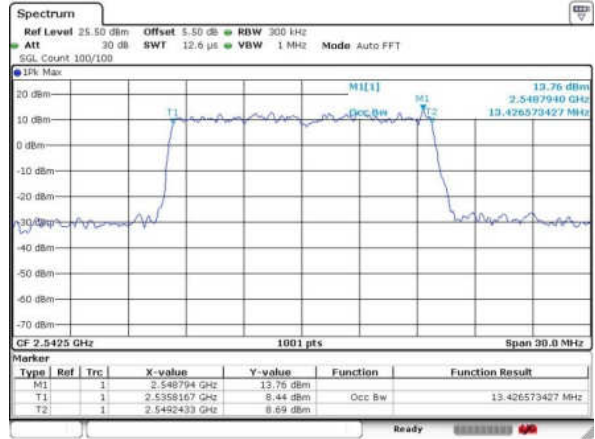

Date: 15 MAY 2018 14:10:56

Middle Channel / 15MHz / QPSK

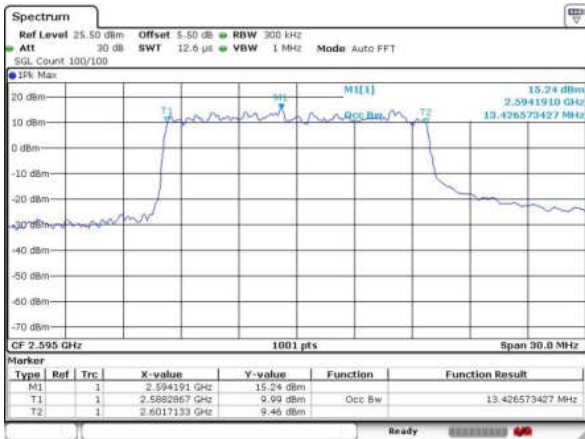

Date: 15 MAY 2018 14:12:35

Middle Channel / 15MHz / 16QAM

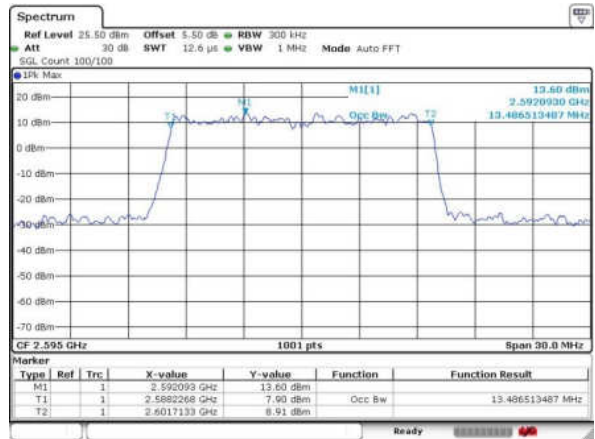

Date: 15 MAY 2018 14:13:03

Highest Channel / 15MHz / QPSK

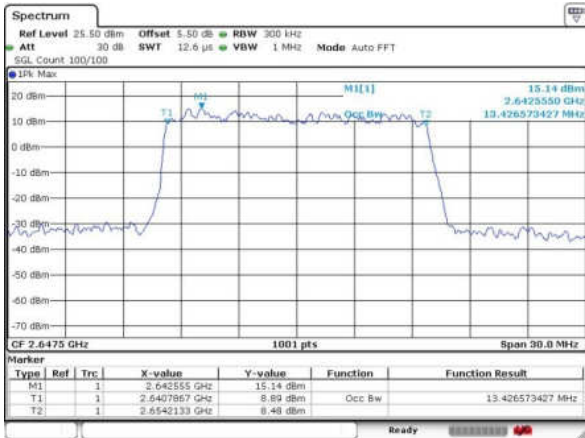

Date: 15 MAY 2018 14:13:57

Highest Channel / 15MHz / 16QAM

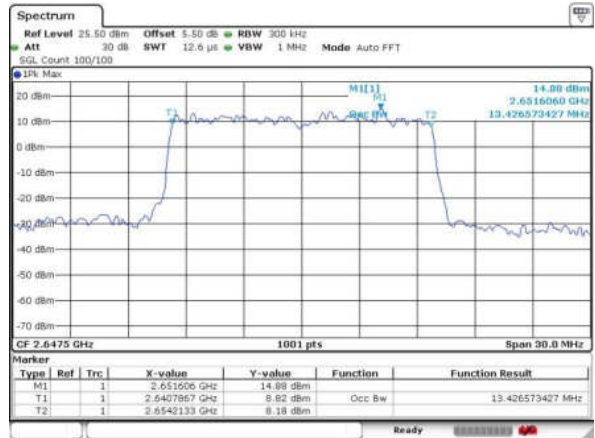

Date: 15 MAY 2018 14:13:30



LTE Band 41

Lowest Channel / 20MHz / QPSK

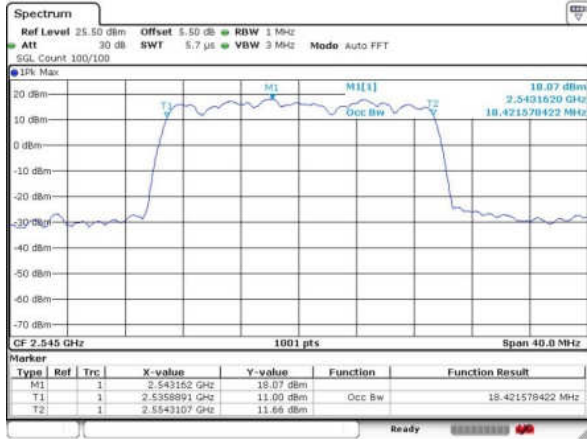

Date: 15 MAY 2018 14:15:24

Lowest Channel / 20MHz / 16QAM

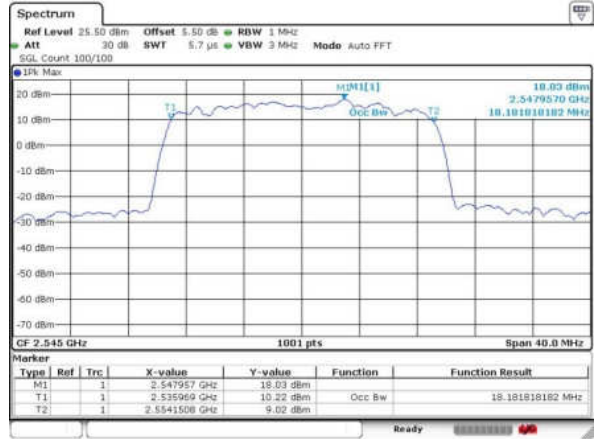

Date: 15 MAY 2018 14:15:52

Middle Channel / 20MHz / QPSK

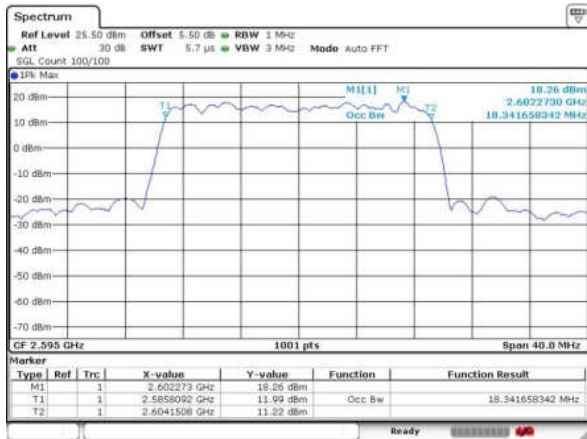

Date: 15 MAY 2018 14:17:00

Middle Channel / 20MHz / 16QAM

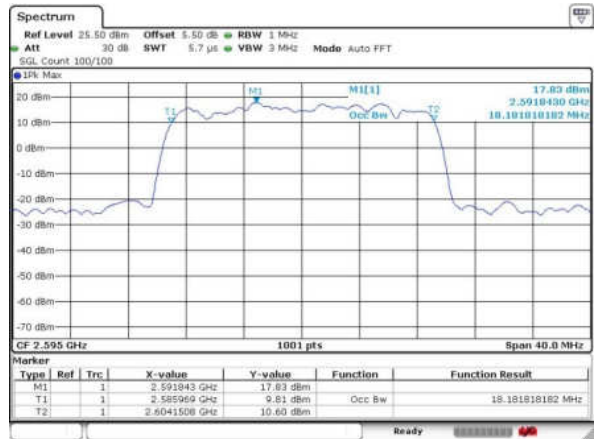

Date: 15 MAY 2018 14:18:35

Highest Channel / 20MHz / QPSK

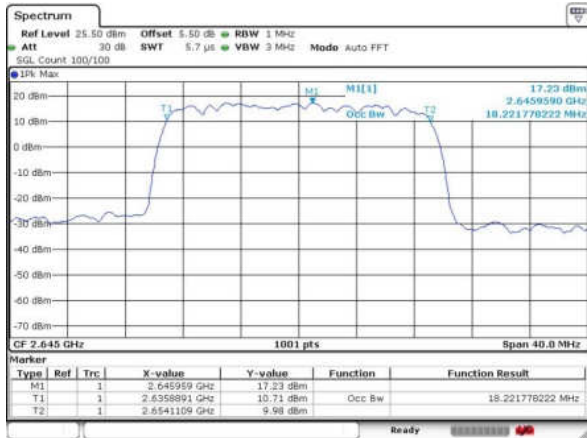

Date: 15 MAY 2018 14:17:28

Highest Channel / 20MHz / 16QAM

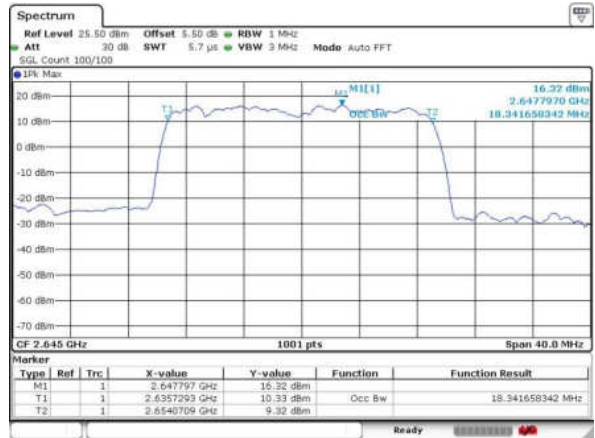

Date: 15 MAY 2018 14:17:58



Conducted Band Edge

LTE Band 38 / 5MHz / QPSK

Lowest Band Edge / 1 RB

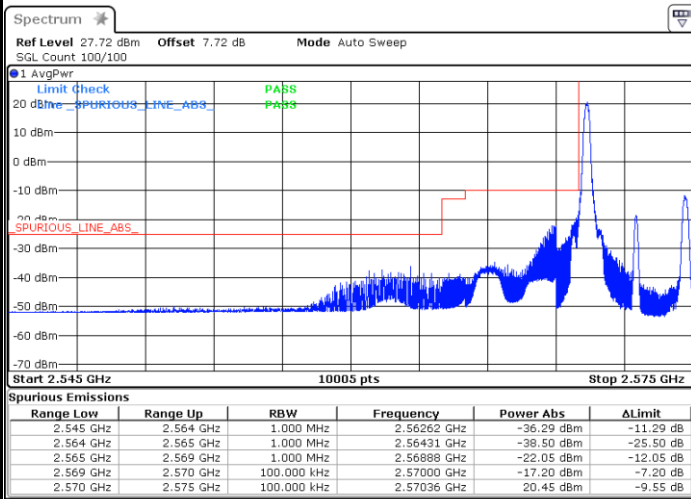

Highest Band Edge / 1 RB

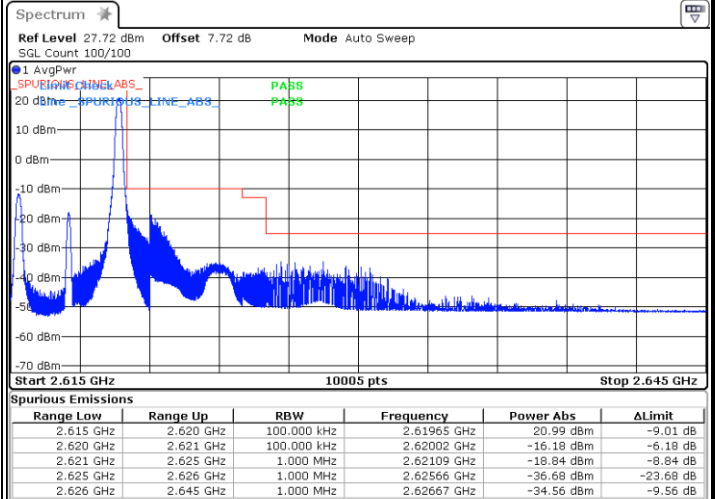

Lowest Band Edge / Full RB

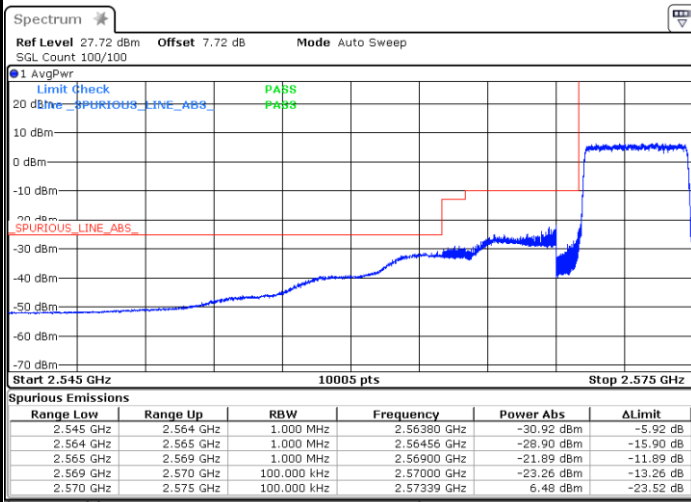

Highest Band Edge / Full RB

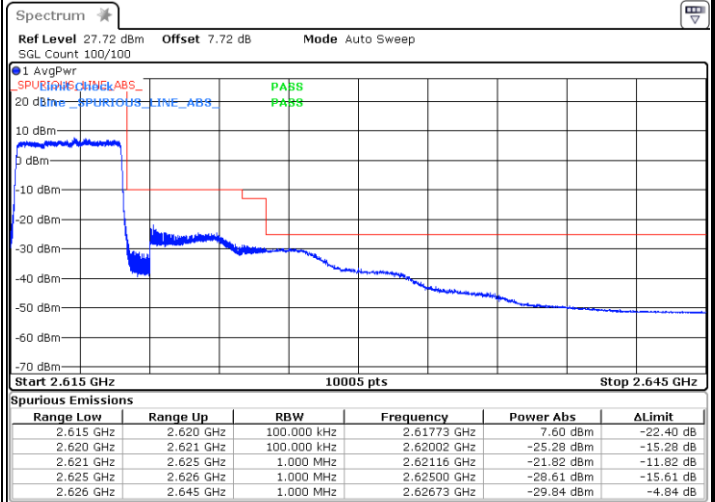



LTE Band 38 / 5MHz / 16QAM

Lowest Band Edge / 1RB

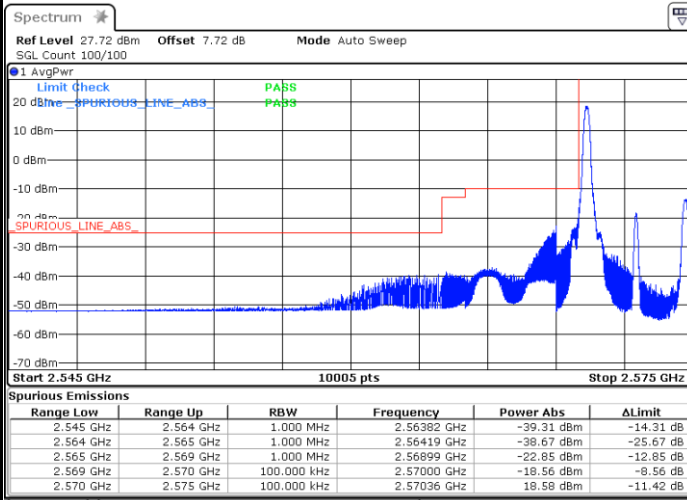

Date: 14.MAY.2018 17:07:57

Highest Band Edge / 1 RB

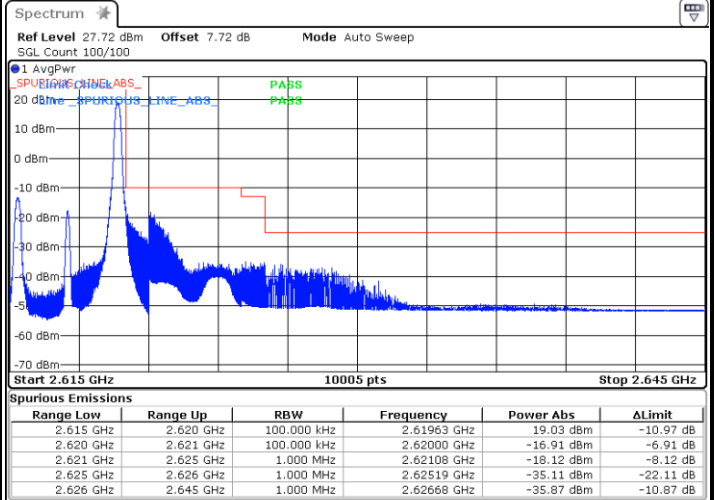

Date: 14.MAY.2018 17:14:03

Lowest Band Edge / Full RB

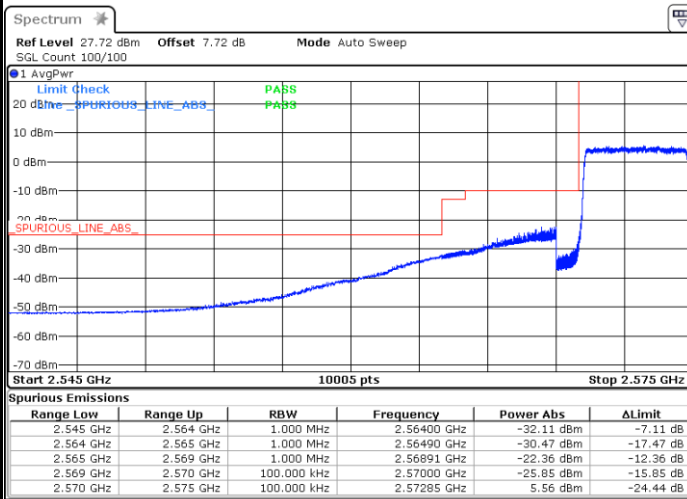

Date: 14.MAY.2018 17:09:06

Highest Band Edge / Full RB

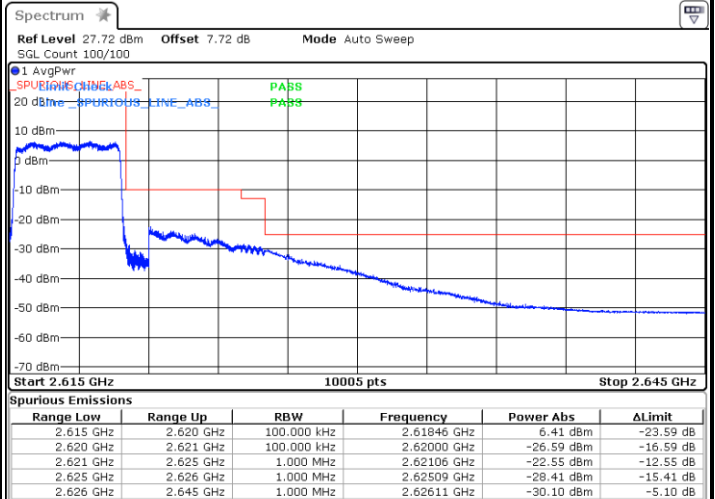

Date: 14.MAY.2018 17:12:34



LTE Band 38 / 10MHz / QPSK

Lowest Band Edge / 1 RB

Highest Band Edge / 1 RB

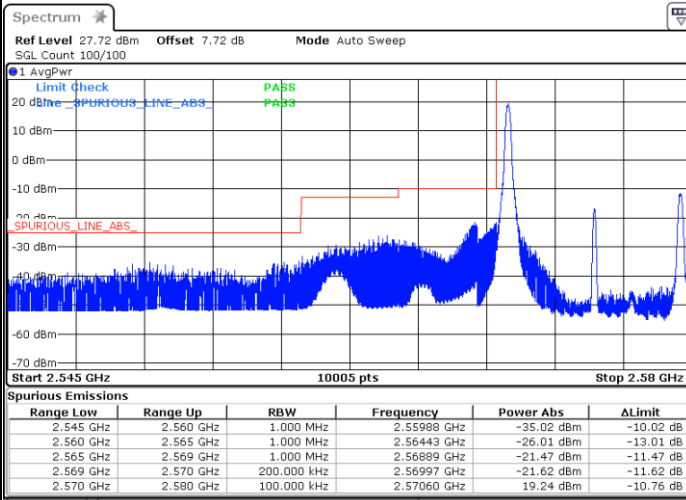

Date: 14.MAY.2018 17:18:30

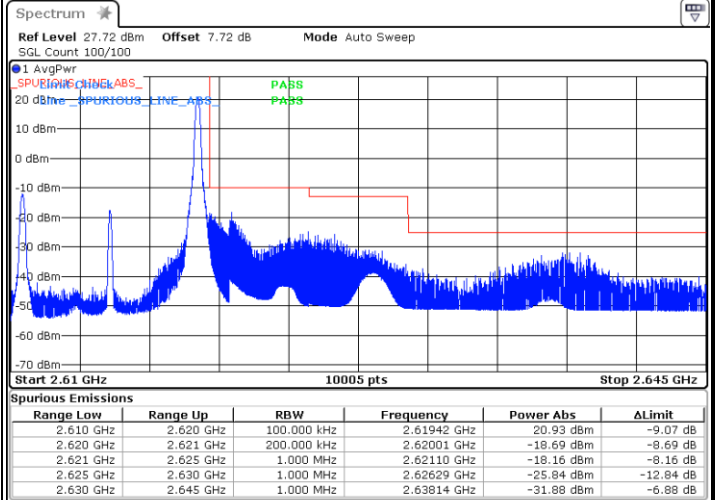

Date: 14.MAY.2018 17:23:30

Lowest Band Edge / Full RB

Highest Band Edge / Full RB

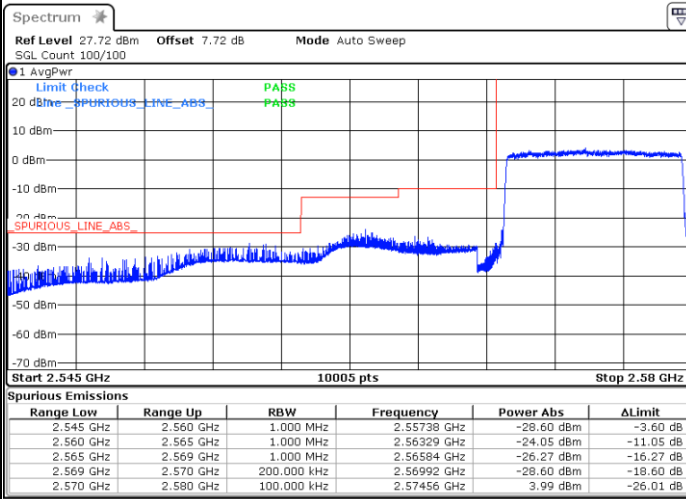

Date: 14.MAY.2018 17:21:44

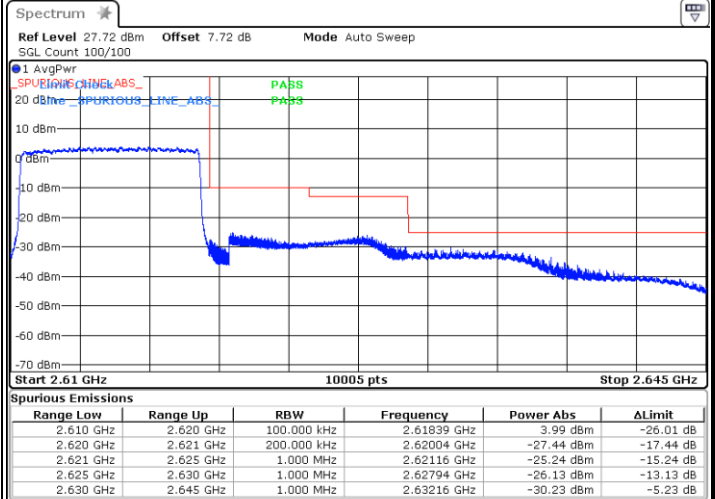

Date: 14.MAY.2018 17:30:10