



FCC RF Test Report

APPLICANT : Motorola Mobility LLC
EQUIPMENT : Mobile Cellular Phone
BRAND NAME : Motorola
MODEL NAME : XT1929-5
FCC ID : IHDT56XE5
STANDARD : FCC Part 15 Subpart C §15.225
CLASSIFICATION : (DXX) Low Power Communication Device Transmitter

This is a variant report. The product was received on Jan. 18, 2018 and testing was completed on Mar. 02, 2018. We, SPORTON INTERNATIONAL INC., would like to declare that the tested sample has been evaluated in accordance with the test procedures and has been in compliance with the applicable technical standards.

The test results in this report apply exclusively to the tested model / sample. Without written approval of SPORTON INTERNATIONAL INC., the test report shall not be reproduced except in full.

Reviewed by: Joseph Lin / Supervisor

Approved by: Jones Tsai / Manager



SPORTON INTERNATIONAL INC.

No. 52, Hwa Ya 1st Rd., Hwa Ya Technology Park, Kwei-Shan District, Tao Yuan City, Taiwan, R.O.C.

SPORTON INTERNATIONAL INC.

TEL : 886-3-327-3456

FAX : 886-3-328-4978

FCC ID: IHDT56XE5

Page Number : 1 of 17

Report Issued Date : Mar. 14, 2018

Report Version : Rev. 01

Report Template No.: BU5-FR15CNFC Version 2.0



TABLE OF CONTENTS

REVISION HISTORY.....3

SUMMARY OF THE TEST RESULT4

1. GENERAL DESCRIPTION5

 1.1 Applicant..... 5

 1.2 Manufacturer 5

 1.3 Product Feature of Equipment Under Test 5

 1.4 Product Specification of Equipment Under Test 7

 1.5 Modification of EUT 7

 1.6 Testing Location 7

 1.7 Applicable Standards..... 7

2. TEST CONFIGURATION OF EQUIPMENT UNDER TEST8

 2.1 Descriptions of Test Mode 8

 2.2 Connection Diagram of Test System 9

 2.3 EUT Operation Test Setup 9

3. TEST RESULTS.....10

 3.1 Field Strength of Fundamental Emissions and Mask Measurement..... 10

 3.2 Radiated Emissions Measurement 12

 3.3 Antenna Requirements..... 15

4. LIST OF MEASURING EQUIPMENT16

5. UNCERTAINTY OF EVALUATION17

APPENDIX A. TEST RESULTS OF RADIATED TEST ITEMS

 A1. Test Result of Field Strength of Fundamental Emissions

 A2. Results of Radiated Emissions (9 kHz~30MHz)

 A3. Results of Radiated Emissions (30MHz~1GHz)



SUMMARY OF THE TEST RESULT

Applied Standard: 47 CFR FCC Part 15 Subpart C §15.225				
Part	FCC Rule	Description of Test	Result	Remark
-	15.207	AC Power Line Conducted Emissions	Not Required	-
-	15.215(c)	20dB Spectrum Bandwidth	Not Required	-
	-	99% OBW Spectrum Bandwidth	Not Required	-
-	15.225(e)	Frequency Stability	Not Required	-
3.1	15.225(a)(b)(c)	Field Strength of Fundamental Emissions	Complies	Max level 69.81 dB μ V/m at 13.560 MHz
3.2	15.225(d) & 15.209	Radiated Spurious Emissions	Complies	Under limit 3.19 dB at 40.680MHz for Quasi-Peak
3.3	15.203	Antenna Requirements	Complies	-

Remark: Not required means after assessing, test items are not necessary to carry out.



1. General Description

1.1 Applicant

Motorola Mobility LLC

222 W,Merchandise Mart Plaza, Chicago IL 60654 USA

1.2 Manufacturer

Motorola Mobility LLC

222 W,Merchandise Mart Plaza, Chicago IL 60654 USA

1.3 Product Feature of Equipment Under Test

Product Feature	
Equipment	Mobile Cellular Phone
Brand Name	Motorola
Model Name	XT1929-5
FCC ID	IHDT56XE5
IMEI Code	Radiation: IMEI 1: 354106090007979 IMEI 2: 354106090007987
EUT supports Radios application	GSM/EGPRS/WCDMA/HSPA/LTE/GNSS/NFC WLAN 11b/g/n HT20 WLAN 11a/n HT20/HT40 WLAN 11ac VHT20/VHT40/VHT80 Bluetooth BR/EDR/LE
HW Version	DVT2
EUT Stage	Identical Prototype

Remark:

1. The above EUT's information was declared by manufacturer. Please refer to the specifications or user's manual for more detailed description.
2. This is a variant report. All the test cases were performed on original report which can be referred to Sporton Report Number FR811821-02D.



Accessory List	
AC Adapter 1	Brand Name : Motorola
	Model Name : SC-28 SPN5997A
	Manufacturer : Salom
AC Adapter 2	Brand Name : Motorola
	Model Name : SC-28 SPN5976A
	Manufacturer : Salom
AC Adapter 3	Brand Name : Motorola
	Model Name : SC-28 SPN5998A
	Manufacturer : Cliptech
Battery	Manufacturer : Chenyang
	Brand Name : Motorola
	Model Name : JS40
Earphone	Manufacturer : SUNWODA
	Brand Name : Motorola
	Model Name : SH38C16618
C2Audio Cable 1	Brand Name : Motorola
	Model Name : SC18C27844
	Manufacturer : Luxshare
C2Audio Cable 2	Brand Name : Motorola
	Model Name : SC18C27845
	Manufacturer : Cabletech
USB Cable 1	Brand Name : Cabletech
	Model Name : SKN6473A
USB Cable 2	Brand Name : FOXLINK
	Model Name : SKN6473A 17195-C 0403532
USB Cable 3	Brand Name : SAIBAO
	Model Name : SKN6473A 17214-C 1127044
USB Cable 4	Brand Name : Luxshare
	Model Name : SKN6473A 17227-C 1126538



1.4 Product Specification of Equipment Under Test

Standards-related Product Specification	
Tx/Rx Frequency Range	13.553 ~ 13.567MHz
Channel Number	1
Antenna Type	Loop Antenna
Type of Modulation	ASK

Remark: The above EUT's information was declared by manufacturer. Please refer to the specifications or user's manual for more detailed description.

1.5 Modification of EUT

No modifications are made to the EUT during all test items.

1.6 Testing Location

Sporton Lab is accredited to ISO 17025 by Taiwan Accreditation Foundation (TAF code : 1190) and the FCC designation No. TW0007 under the FCC 2.948(e) by Mutual Recognition Agreement (MRA) in FCC Test.

Test Site	SPORTON INTERNATIONAL INC.
Test Site Location	No.58, Aly. 75, Ln. 564, Wenhua 3rd Rd. Guishan Dist, Taoyuan City, Taiwan (R.O.C.) TEL: +886-3-327-3456 FAX: +886-3-328-4978
Test Site No.	Sporton Site No. 03CH11-HY
Test Engineer	Ken Wu
Temperature	22~24°C
Relative Humidity	53~58%

1.7 Applicable Standards

According to the specifications of the manufacturer, the EUT must comply with the requirements of the following standards:

- ♦ FCC Part 15 Subpart C §15.225
- ♦ ANSI C63.10-2013



2. Test Configuration of Equipment Under Test

2.1 Descriptions of Test Mode

Investigation has been done on all the possible configurations.

The following table is a list of the test modes shown in this test report.

Test Items	
Field Strength of Fundamental Emissions	Radiated Emissions 30MHz~1GHz
Radiated Emissions 9kHz~30MHz	

Remark: For Radiated Test Cases, The tests were performance with AC Adapter 1 and USB Cable 1.

The EUT pre-scanned in four NFC type, A, B, F, V. The worst type (type F) was recorded in this report. Pre-scanned tests, X, Y, Z in three orthogonal panels to determine the final configuration (Z plane as worst plane) from all possible combinations.

2.2 Connection Diagram of Test System

< For Fundamental Emissions and Mask and Radiated Emissions Measurement >

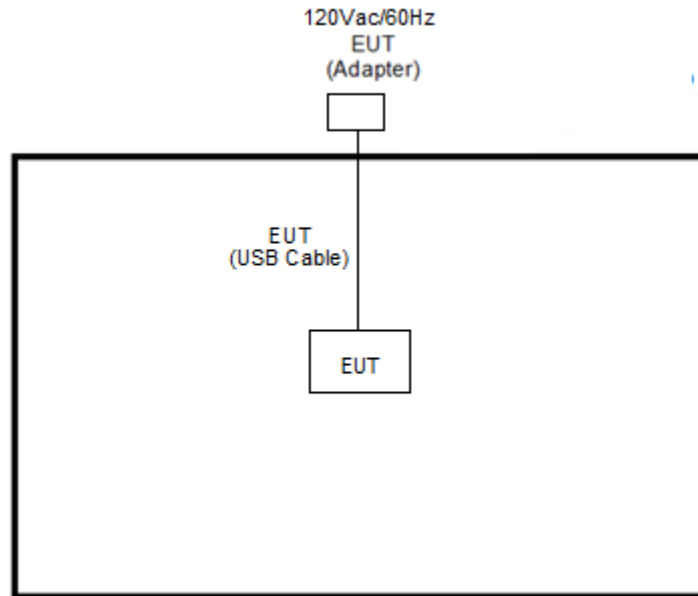

2.3 EUT Operation Test Setup

The EUT was programmed to be in continuously transmitting mode.

The ancillary equipment, NFC card, is used to make the EUT (NFC) continuously transmit at 13.56MHz and is placed around 2 cm gap to the EUT.



3. Test Results

3.1 Field Strength of Fundamental Emissions and Mask Measurement

3.1.1 Limit

Rules and specifications	FCC CFR 47 Part 15 section 15.225			
Description	Compliance with the spectrum mask is tested with RBW set to 9kHz.			
Freq. of Emission (MHz)	Field Strength ($\mu\text{V/m}$) at 30m	Field Strength ($\text{dB}\mu\text{V/m}$) at 30m	Field Strength ($\text{dB}\mu\text{V/m}$) at 10m	Field Strength ($\text{dB}\mu\text{V/m}$) at 3m
1.705~13.110	30	29.5	48.58	69.5
13.110~13.410	106	40.5	59.58	80.5
13.410~13.553	334	50.5	69.58	90.5
13.553~13.567	15848	84.0	103.08	124.0
13.567~13.710	334	50.5	69.58	90.5
13.710~14.010	106	40.5	59.58	80.5
14.010~30.000	30	29.5	48.58	69.5

3.1.2 Measuring Instruments

See list of measuring instruments of this test report.

3.1.3 Test Procedures

1. Configure the EUT according to ANSI C63.10. The EUT was placed on the top of the turntable 0.8 meter above ground. The phase center of the loop receiving antenna mounted antenna tower was placed 3 meters far away from the turntable.
2. Power on the EUT and all the supporting units. The turntable was rotated by 360 degrees to determine the position of the highest radiation.
3. The height of the receiving antenna was fixed at one meter above ground to find the maximum emissions field strength.
4. For Fundamental emissions, use the receiver to measure QP reading.
5. When the radiated emissions limits are expressed in terms of the average value of the emissions, and pulsed operation is employed, the measurement field strength shall be determined by averaging over one complete pulse train, including blanking intervals, as long as the pulse train does not exceed 0.1 seconds. As an alternative (provided the transmitter operates for longer than 0.1 seconds) or in cases where the pulse train exceeds 0.1 seconds, the measured field strength shall be determined from the average absolute voltage during a 0.1 second interval during which the field strength is at its maximum value.
6. Compliance with the spectrum mask is tested with RBW set to 9kHz.

Note: Emission level (dB μ V/m) = 20 log Emission level (μ V/m).

3.1.4 Test Setup

For radiated emissions below 30MHz

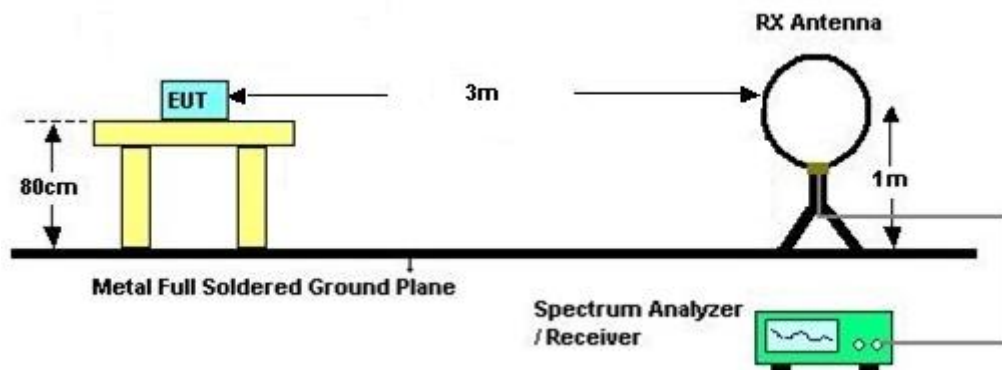

3.1.5 Test Result of Field Strength of Fundamental Emissions and Mask

Please refer to Appendix A.

3.2 Radiated Emissions Measurement

3.2.1 Limit

The field strength of any emissions which appear outside of 13.110 ~14.010MHz band shall not exceed the general radiated emissions limits.

Frequencies (MHz)	Field Strength (µV/m)	Measurement Distance (meters)
0.009~0.490	2400/F(kHz)	300
0.490~1.705	24000/F(kHz)	30
1.705~30.0	30	30
30~88	100	3
88~216	150	3
216~960	200	3
Above 960	500	3

3.2.2 Measuring Instruments

See list of measuring instruments of this test report.

3.2.3 Measuring Instrument Setting

The following table is the setting of receiver.

Receiver Parameter	Setting
Attenuation	Auto
Frequency Range: 9kHz~150kHz	RBW 200Hz for QP
Frequency Range: 150kHz~30MHz	RBW 9kHz for QP
Frequency Range: 30MHz~1000MHz	RBW 120kHz for Peak

Note: The emission limits shown in the above table are based on measurements employing a CISPR quasi-peak detector except for the frequency bands 9-90 kHz, 110-490 kHz. Radiated emission limits in these two bands are based on measurements employing an average detector.



3.2.4 Test Procedures

1. Configure the EUT according to ANSI C63.10. The EUT was placed on the top of the turntable 0.8 meter above ground. The phase center of the receiving antenna mounted on the top of a height-variable antenna tower was placed 3 meters far away from the turntable.
2. Power on the EUT and all the supporting units. The turntable was rotated by 360 degrees to determine the position of the highest radiation.
3. The height of the broadband receiving antenna was varied between one meter and four meters above ground to find the maximum emissions field strength of both horizontal and vertical polarization.
4. For each suspected emissions, the antenna tower was scan (from 1 M to 4 M) and then the turntable was rotated (from 0 degree to 360 degrees) to find the maximum reading.
5. Set the test-receiver system to Peak or CISPR quasi-peak Detect Function with specified bandwidth under Maximum Hold Mode.
6. When the radiated emissions limits are expressed in terms of the average value of the emissions, and pulsed operation is employed, the measurement field strength shall be determined by averaging over one complete pulse train, including blanking intervals, as long as the pulse train does not exceed 0.1 seconds. As an alternative (provided the transmitter operates for longer than 0.1 seconds) or in cases where the pulse train exceeds 0.1 seconds, the measured field strength shall be determined from the average absolute voltage during a 0.1 second interval during which the field strength is at its maximum value.
7. In case the emission is lower than 30MHz, loop antenna has to be used for measurement and the recorded data should be QP measured by receiver. Antenna Requirements

3.2.5 Test Setup

For radiated emissions below 30MHz

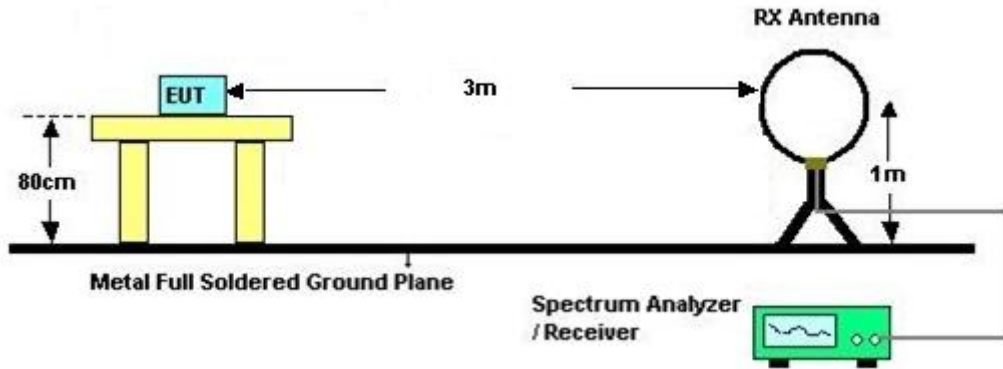

For radiated emissions above 30MHz

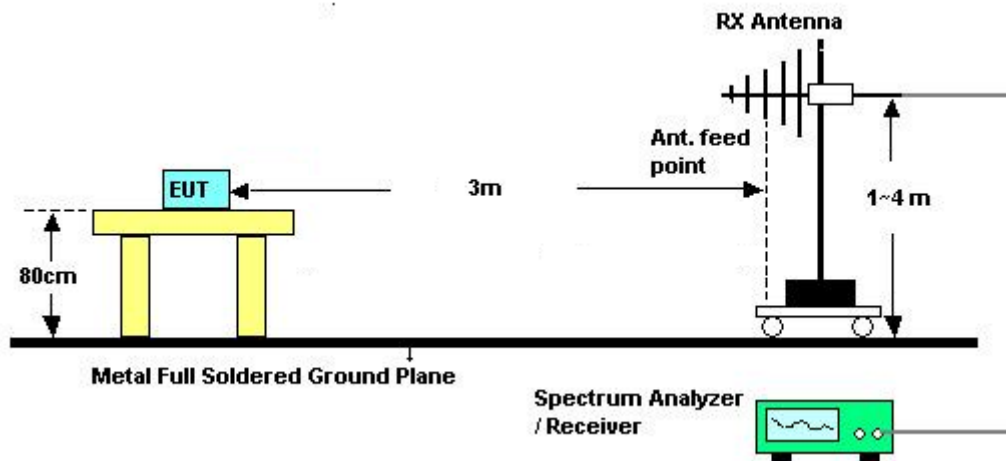

3.2.6 Test Result of Radiated Emissions Measurement

Please refer to Appendix A.

Remark: There is a comparison data of both open-field test site and semi-Anechoic chamber, and the result came out very similar.



3.3 Antenna Requirements

3.3.1 Standard Applicable

Except for special regulations, the Low-power Radio-frequency Devices must not be equipped with any jacket for installing an antenna with extension cable. An intentional radiator shall be designed to ensure that no antenna other than that furnished by the responsible party shall be used with the device. The use of a permanently attached antenna or of an antenna that uses a unique coupling to the intentional radiator shall be considered sufficient to comply with the provisions of this Section. The manufacturer may design the unit so that the user can replace a broken antenna, but the use of a standard antenna jack or electrical connector is prohibited.

The use of a permanently attached antenna or of an antenna that uses a unique coupling to the intentional radiator shall be considered sufficient to comply with the rule.

3.3.2 Antenna Anti-Replacement Construction

An embedded-in antenna design is used.



4. List of Measuring Equipment

Instrument	Manufacturer	Model No.	Serial No.	Characteristics	Calibration Date	Test Date	Due Date	Remark
Amplifier	SONOMA	310N	187312	9kHz~1GHz	Nov. 10, 2016	Mar. 02, 2018	Nov. 09, 2018	Radiation (03CH11-HY)
Bilog Antenna	TESEQ	CBL 6111D&N-6-0 6	35414&AT- N0602	30MHz~1GHz	Oct. 14, 2017	Mar. 02, 2018	Oct. 13, 2018	Radiation (03CH11-HY)
Loop Antenna	Rohde & Schwarz	HFH2-Z2	100488	9 kHz~30 MHz	Nov. 23, 2017	Mar. 02, 2018	Nov. 22, 2019	Radiation (03CH11-HY)
Spectrum Analyzer	Keysight	N9010A	MY542004 86	10Hz ~ 44GHz	Oct. 19, 2017	Mar. 02, 2018	Oct. 18, 2018	Radiation (03CH11-HY)
Antenna Mast	EMEC	AM-BS-4500- B	N/A	1~4m	N/A	Mar. 02, 2018	N/A	Radiation (03CH11-HY)
EMI Test Receiver	Agilent Technologies	N9038A(MXE)	MY532900 45	20MHz~8.4GHz	Jan. 18, 2018	Mar. 02, 2018	Jan. 17, 2019	Radiation (03CH11-HY)
Turn Table	EMEC	TT 2000	N/A	0~360 Degree	N/A	Mar. 02, 2018	N/A	Radiation (03CH11-HY)



5. Uncertainty of Evaluation

Uncertainty of Radiated Emission Measurement (9 kHz ~ 30 MHz)

Measuring Uncertainty for a Level of Confidence of 95% ($U = 2Uc(y)$)	3.45
---	------

Uncertainty of Radiated Emission Measurement (30 MHz ~ 1000 MHz)

Measuring Uncertainty for a Level of Confidence of 95% ($U = 2Uc(y)$)	5.20
---	------



Appendix A. Test Results of Radiated Test Items

A1. Test Result of Field Strength of Fundamental Emissions

Test Mode :	NFC Tx	Test Frequency (MHz)	13.56
--------------------	--------	-----------------------------	-------

Date: 2018-03-02

Site : 03CH11-HY
 Condition : 15.225 3m LOOP_ANT(H) HORIZONTAL
 : RBW:9.000KHz VBW:9.000KHz SWT:Auto
 Project : 811821-04

Over	Limit	ReadAntenna	Cable	A/Pos	T/Pos	Remark				
Freq	Level	Line	Level	Factor	Loss					
MHz	dBuV/m	dB	dBuV/m	dBuV	dB/m	dB				
1	13.56	69.81	-54.19	124.00	48.53	21.02	0.26	100	0	QP

Date: 2018-03-02

Site : 03CH11-HY
 Condition : 15.225 3m LOOP_ANT(V) VERTICAL
 : RBW:9.000KHz VBW:9.000KHz SWT:Auto
 Project : 811821-04

Over	Limit	ReadAntenna	Cable	A/Pos	T/Pos	Remark				
Freq	Level	Line	Level	Factor	Loss					
MHz	dBuV/m	dB	dBuV/m	dBuV	dB/m	dB				
1	13.56	66.76	-57.24	124.00	45.48	21.02	0.26	100	72	QP

A2. Results of Radiated Spurious Emissions (9 kHz~30MHz)

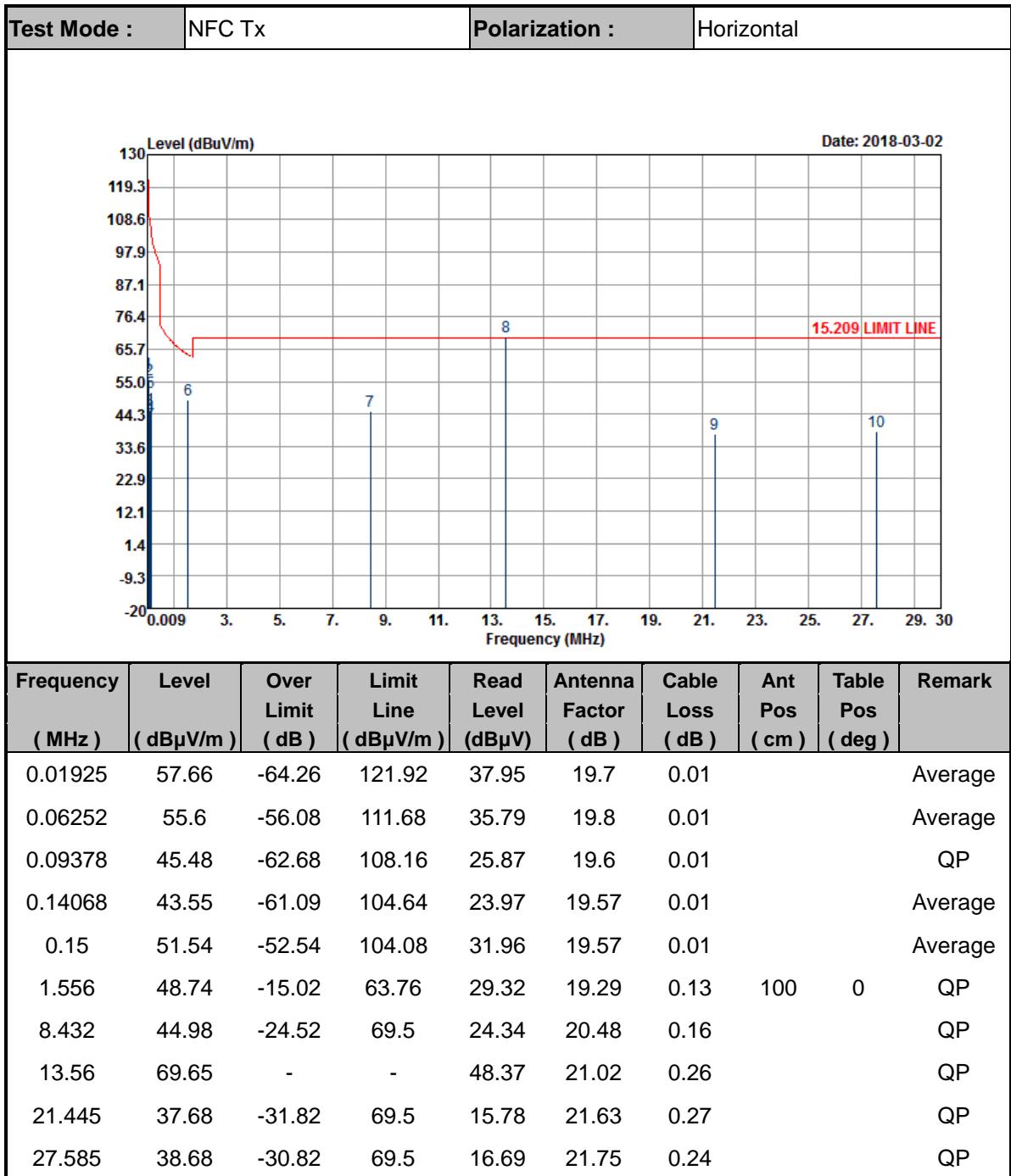

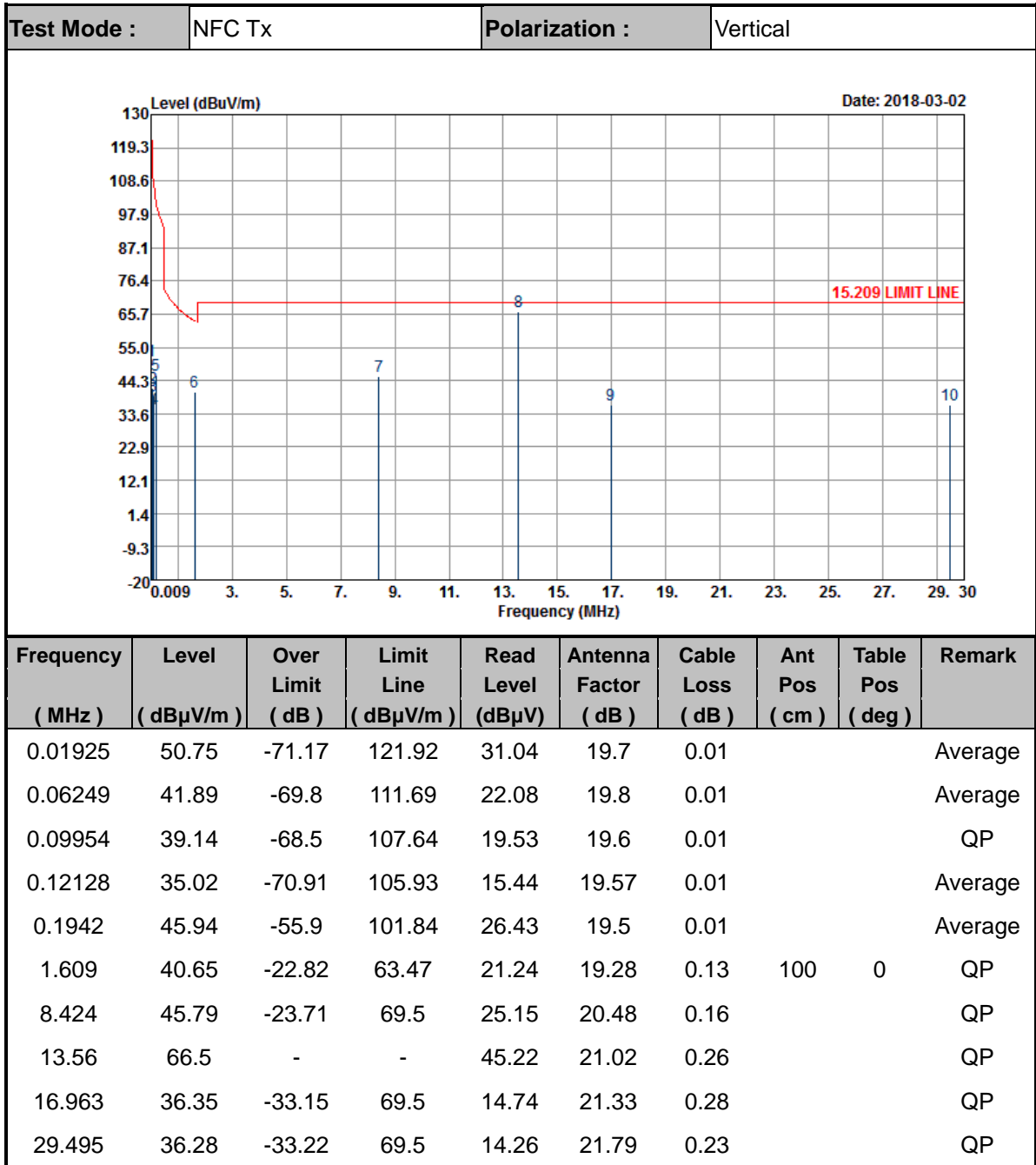

Note:

1. 13.56 MHz is fundamental signal which can be ignored.
2. The amplitude of spurious emissions which are attenuated by more than 20dB below the permissible value has no need to be reported.
3. Distance extrapolation factor = 40 log (specific distance / test distance) (dB);
4. Limit line = specific limits (dBμV) + distance extrapolation factor.



A3. Results of Radiated Spurious Emissions (30MHz~1GHz)

Test Mode :	NFC Tx	Polarization :	Horizontal
-------------	--------	----------------	------------

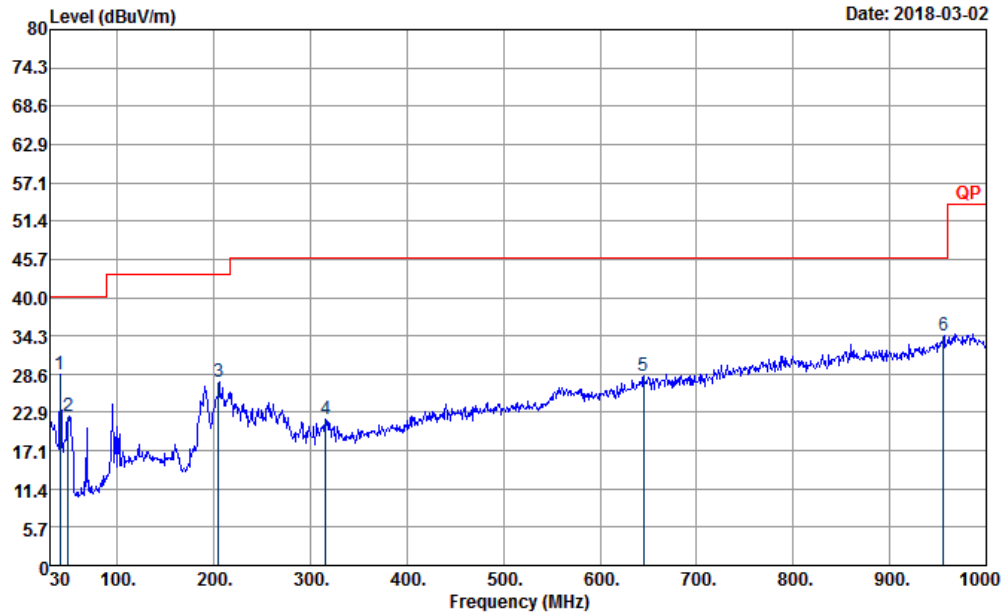

Frequency (MHz)	Level (dB μ V/m)	Over Limit (dB)	Limit Line (dB μ V/m)	Read Level (dB μ V)	Antenna Factor (dB)	Cable Loss (dB)	Preamp Factor (dB)	Ant Pos (cm)	Table Pos (deg)	Remark
40.68	28.6	-11.4	40	41.38	18.68	0.82	32.49	100	0	Peak
48.9	22.24	-17.76	40	38.64	14.9	1.02	32.49			Peak
204.96	27.4	-16.1	43.5	43	14.92	1.72	32.39			Peak
315.4	21.83	-24.17	46	32.51	19.19	2.31	32.36			Peak
645.1	28.33	-17.67	46	30.32	26.31	3.2	32.46			Peak
955.9	34.25	-11.75	46	29.61	30.92	3.9	31.14			Peak

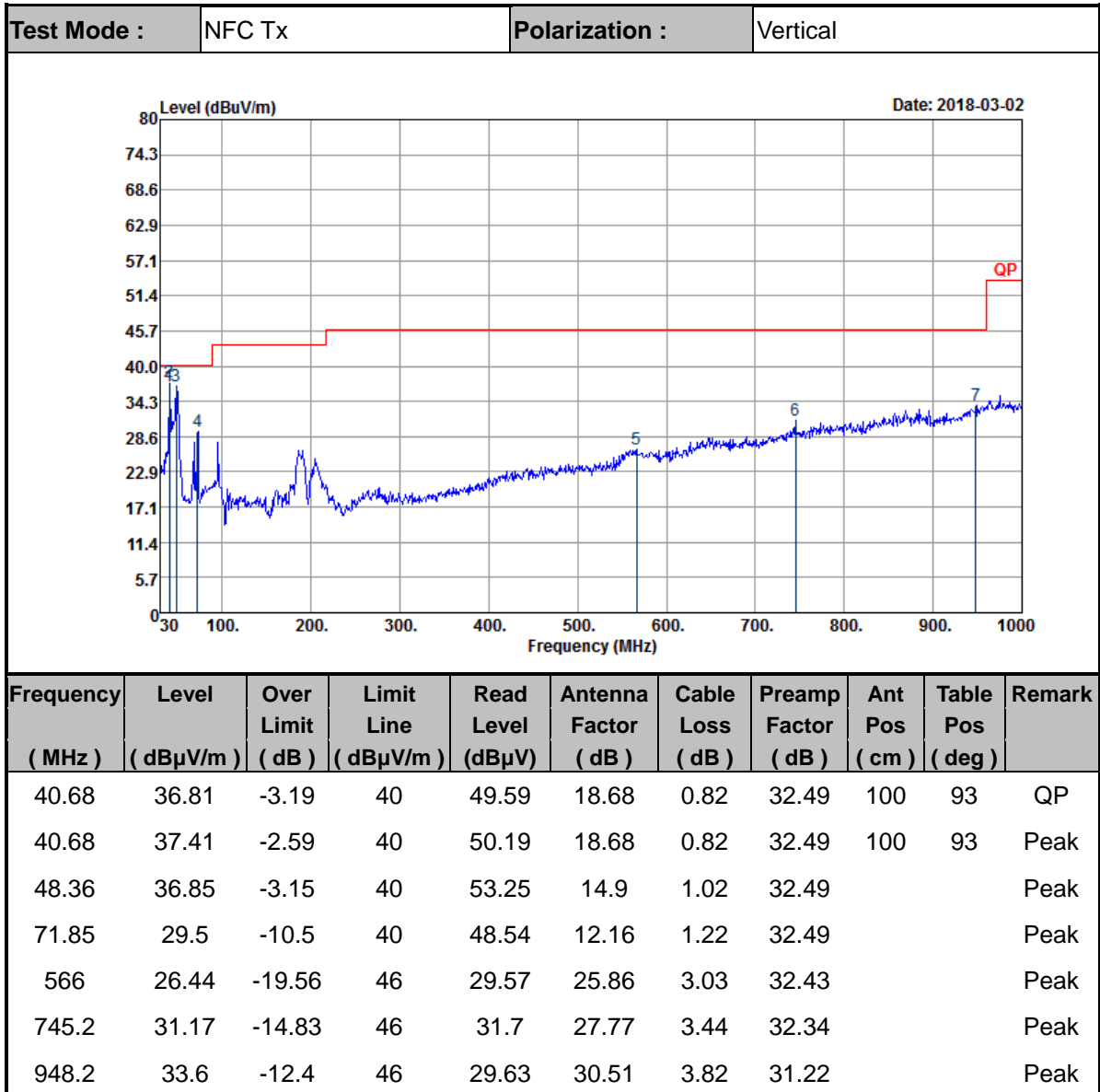

Note:

1. The amplitude of spurious emissions which are attenuated by more than 20dB below the permissible value has no need to be reported.
2. Emission level (dBμV/m) = 20 log Emission level (μV/m).
3. Corrected Reading: Antenna Factor + Cable Loss + Read Level - Preamp Factor= Level.