



FCC RF Test Report

APPLICANT : Motorola Mobility LLC
EQUIPMENT : Mobile Cellular Phone
BRAND NAME : Motorola
MODEL NAME : XT1929-4(SS)
FCC ID : IHDT56XE1
STANDARD : FCC Part 15 Subpart E §15.407
CLASSIFICATION : (NII) Unlicensed National Information Infrastructure

This is partial report. The product was received on Jan. 18, 2018 and testing was completed on Feb. 23, 2018. We, SPORTON INTERNATIONAL INC., would like to declare that the tested sample has been evaluated in accordance with the test procedures and has been in compliance with the applicable technical standards.

The test results in this report apply exclusively to the tested model / sample. Without written approval of SPORTON INTERNATIONAL INC., the test report shall not be reproduced except in full.

Reviewed by: Joseph Lin / Supervisor

Approved by: Jones Tsai / Manager



SPORTON INTERNATIONAL INC.

No. 52, Hwa Ya 1st Rd., Hwa Ya Technology Park, Kwei-Shan District, Tao Yuan City, Taiwan, R.O.C.

SPORTON INTERNATIONAL INC.

TEL : 886-3-327-3456

FAX : 886-3-328-4978

FCC ID: IHDT56XE1

Page Number : 1 of 26

Report Issued Date : Mar. 05, 2018

Report Version : Rev. 01

Report Template No.: BU5-FR15EWLAC MA Version 2.0



TABLE OF CONTENTS

REVISION HISTORY..... 3

SUMMARY OF TEST RESULT 4

1 GENERAL DESCRIPTION 5

 1.1 Applicant 5

 1.2 Manufacturer 5

 1.3 Product Feature of Equipment Under Test 5

 1.4 Product Specification of Equipment Under Test 7

 1.5 Modification of EUT 7

 1.6 Testing Location 8

 1.7 Applicable Standards 8

2 TEST CONFIGURATION OF EQUIPMENT UNDER TEST 9

 2.1 Carrier Frequency and Channel 9

 2.2 Test Mode 10

 2.3 Connection Diagram of Test System 12

 2.4 Support Unit used in test configuration and system 12

 2.5 EUT Operation Test Setup 13

 2.6 Measurement Results Explanation Example 13

3 TEST RESULT 14

 3.1 26dB & 99% Occupied Bandwidth Measurement 14

 3.2 Maximum Conducted Output Power Measurement 16

 3.3 Power Spectral Density Measurement 18

 3.4 AC Conducted Emission Measurement 21

 3.5 Automatically Discontinue Transmission 23

 3.6 Antenna Requirements 24

4 LIST OF MEASURING EQUIPMENT 25

5 UNCERTAINTY OF EVALUATION 26

APPENDIX A. CONDUCTED TEST RESULTS

APPENDIX B. AC CONDUCTED EMISSION TEST RESULT



SUMMARY OF TEST RESULT

Report Section	FCC Rule	Description	Limit	Result	Remark
3.1	2.1049 & 15.403(i)	26dB & 99% Bandwidth	-	Pass	-
3.2	15.407(a)	Maximum Conducted Output Power	≤ 24 dBm	Pass	-
3.3	15.407(a)	Power Spectral Density	≤ 11 dBm	Pass	-
3.4	15.207	AC Conducted Emission	15.207(a)	Pass	Under limit 14.44 dB at 0.198 MHz
3.5	15.407(c)	Automatically Discontinue Transmission	Discontinue Transmission	Pass	-
3.6	15.203 & 15.407(a)	Antenna Requirement	N/A	Pass	-



1 General Description

1.1 Applicant

Motorola Mobility LLC
222 W, Merchandise Mart Plaza, Chicago IL 60654 USA

1.2 Manufacturer

Motorola Mobility LLC
222 W, Merchandise Mart Plaza, Chicago IL 60654 USA

1.3 Product Feature of Equipment Under Test

Product Feature	
Equipment	Mobile Cellular Phone
Brand Name	Motorola
Model Name	XT1929-4(SS)
FCC ID	IHDT56XE1
IMEI Code	Conducted : IMEI: 351886090013118 Conduction : IMEI: 351886090018703
EUT supports Radios application	CDMA/EV-DO/GSM/EGPRS/WCDMA/HSPA/LTE/GNSS/NFC WLAN 11b/g/n HT20 WLAN 11a/n HT20/HT40 WLAN 11ac VHT20/VHT40/VHT80 Bluetooth BR/EDR/LE
HW Version	DVT2
EUT Stage	Identical Prototype

Remark: The above EUT's information was declared by manufacturer. Please refer to the specifications or user's manual for more detailed description.



Accessory List	
AC Adapter 1	Brand Name : Motorola
	Model Name : SC-22 SPN5970A
	Manufacturer : Salom
AC Adapter 2	Brand Name : Motorola
	Model Name : SC-22 SPN5993A
	Manufacturer : Chenyang
Battery	Brand Name : Motorola
	Model Name : JS40
	Manufacturer : SUNWODA
C2Audio Cable 1	Brand Name : Motorola
	Model Name : SC18C27844
	Manufacturer : Luxshare
C2Audio Cable 2	Brand Name : Motorola
	Model Name : SC18C27845
	Manufacturer : Cabletech
USB Cable 1	Brand Name : Cabletech
	Model Name : SKN6473A
USB Cable 2	Brand Name : FOXLINK
	Model Name : SKN6473A 17195-C 0403532
USB Cable 3	Brand Name : SAIBAO
	Model Name : SKN6473A 17214-C 1127044
USB Cable 4	Brand Name : Luxshare
	Model Name : SKN6473A 17227-C 1126538



1.4 Product Specification of Equipment Under Test

Standards-related Product Specification	
Tx/Rx Channel Frequency Range	5180 MHz ~ 5240 MHz 5260 MHz ~ 5320 MHz 5500 MHz ~ 5700 MHz
Maximum Output Power	<p><5180 MHz ~ 5240 MHz> 802.11a : 19.99 dBm / 0.0998 W 802.11n HT20 : 19.93 dBm / 0.0984 W 802.11n HT40 : 18.95 dBm / 0.0785 W 802.11ac VHT20 : 19.84 dBm / 0.0964 W 802.11ac VHT40 : 18.94 dBm / 0.0783 W 802.11ac VHT80 : 17.83 dBm / 0.0607 W</p> <p><5260 MHz ~ 5320 MHz> 802.11a : 19.98 dBm / 0.0995 W 802.11n HT20 : 19.80 dBm / 0.0955 W 802.11n HT40 : 18.84 dBm / 0.0766 W 802.11ac VHT20 : 19.79 dBm / 0.0953 W 802.11ac VHT40 : 18.82 dBm / 0.0762 W 802.11ac VHT80 : 17.93 dBm / 0.0621 W</p> <p><5500 MHz ~ 5700 MHz> 802.11a : 19.96 dBm / 0.0991 W 802.11n HT20 : 19.99 dBm / 0.0998 W 802.11n HT40 : 18.99 dBm / 0.0793 W 802.11ac VHT20 : 19.94 dBm / 0.0986 W 802.11ac VHT40 : 18.96 dBm / 0.0787 W 802.11ac VHT80 : 17.70 dBm / 0.0589 W</p>
99% Occupied Bandwidth	802.11a : 17.80 MHz 802.11n HT20 : 18.85 MHz 802.11n HT40 : 36.60 MHz 802.11ac VHT80 : 75.84 MHz
Antenna Type / Gain	<p><5150 MHz ~ 5250 MHz> Internal Antenna with gain -6.50 dBi</p> <p><5250 MHz ~ 5350 MHz> Internal Antenna with gain -6.50 dBi</p> <p><5470 MHz ~ 5725 MHz> Internal Antenna with gain -7.00 dBi</p>
Type of Modulation	802.11a/n : OFDM (BPSK / QPSK / 16QAM / 64QAM) 802.11ac : OFDM (BPSK / QPSK / 16QAM / 64QAM / 256QAM)

Note: The WLAN operation in 5600 MHz ~ 5650 MHz is notched.

1.5 Modification of EUT

No modifications are made to the EUT during all test items.



1.6 Testing Location

Sporton Lab is accredited to ISO 17025 by Taiwan Accreditation Foundation (TAF code : 1190) and the FCC designation No. TW1190 under the FCC 2.948(e) by Mutual Recognition Agreement (MRA) in FCC Test.

Test Site	SPORTON INTERNATIONAL INC.	
Test Site Location	No. 52, Hwa Ya 1 st Rd., Hwa Ya Technology Park, Kwei-Shan District, Tao Yuan City, Taiwan, R.O.C. TEL: +886-3-327-3456 FAX: +886-3-328-4978	
Test Site No.	Sporton Site No.	
	TH05-HY	CO05-HY

Note: The test site complies with ANSI C63.4 2014 requirement.

1.7 Applicable Standards

According to the specifications of the manufacturer, the EUT must comply with the requirements of the following standards:

- ♦ FCC Part 15 Subpart E
- ♦ FCC KDB 789033 D02 General UNII Test Procedures New Rules v02r01.
- ♦ ANSI C63.10-2013

Remark:

1. All test items were verified and recorded according to the standards and without any deviation during the test.
2. This EUT has also been tested and complied with the requirements of FCC Part 15, Subpart B, recorded in a separate test report.



2 Test Configuration of Equipment Under Test

- a. The EUT has been associated with peripherals and configuration operated in a manner tended to maximize its emission characteristics in a typical application. Frequency range investigated: conduction emission (150 kHz to 30 MHz),
- b. AC power line Conducted Emission was tested under maximum output power.

2.1 Carrier Frequency and Channel

Frequency Band	Channel	Freq. (MHz)	Channel	Freq. (MHz)
5150-5250 MHz Band 1 (U-NII-1)	36	5180	44	5220
	38*	5190	46*	5230
	40	5200	48	5240
	42 [#]	5210		

Frequency Band	Channel	Freq. (MHz)	Channel	Freq. (MHz)
5250-5350 MHz Band 2 (U-NII-2A)	52	5260	60	5300
	54*	5270	62*	5310
	56	5280	64	5320
	58 [#]	5290		

Frequency Band	Channel	Freq. (MHz)	Channel	Freq. (MHz)
5470-5725 MHz Band 3 (U-NII-2C)	100	5500	112	5560
	102*	5510	116	5580
	104	5520	132	5660
	106 [#]	5530	134*	5670
	108	5540	136	5680
	110*	5550	140	5700

Note:

- 1. The above Frequency and Channel in "*" were 802.11n HT40 and 802.11ac VHT40.
- 2. The above Frequency and Channel in "[#]" were 802.11ac VHT80.



2.2 Test Mode

Final test modes are considering the modulation and worse data rates as below table.

Modulation	Data Rate
802.11a	6 Mbps
802.11n HT20	MCS0
802.11n HT40	MCS0
802.11ac VHT20 (Covered by HT20)	MCS0
802.11ac VHT40 (Covered by HT40)	MCS0
802.11ac VHT80	MCS0

Test Cases	
AC Conducted Emission	Mode 1 : GSM1900 Idle + Bluetooth Link + WLAN (5GHz) Link + MP3 + Battery + USB Cable 1 Type C (Charging from Adapter 1)



Ch. #		Band I : 5150-5250 MHz	Band II : 5250-5350 MHz	Band III : 5470-5725MHz
		802.11a	802.11a	802.11a
L	Low	36	52	100
M	Middle	44	60	116
H	High	48	64	140

Ch. #		Band I : 5150-5250 MHz	Band II : 5250-5350 MHz	Band III : 5470-5725MHz
		802.11n HT20	802.11n HT20	802.11n HT20
L	Low	36	52	100
M	Middle	44	60	116
H	High	48	64	140

Ch. #		Band I : 5150-5250 MHz	Band II : 5250-5350 MHz	Band III : 5470-5725MHz
		802.11n HT40	802.11n HT40	802.11n HT40
L	Low	38	54	102
M	Middle	-	-	110
H	High	46	62	134

Ch. #		Band I : 5150-5250 MHz	Band II : 5250-5350 MHz	Band III : 5470-5725MHz
		802.11ac VHT80	802.11ac VHT80	802.11ac VHT80
L	Low	-	-	106
M	Middle	42	58	-
H	High	-	-	-

2.3 Connection Diagram of Test System

<AC Conducted Emission Mode>

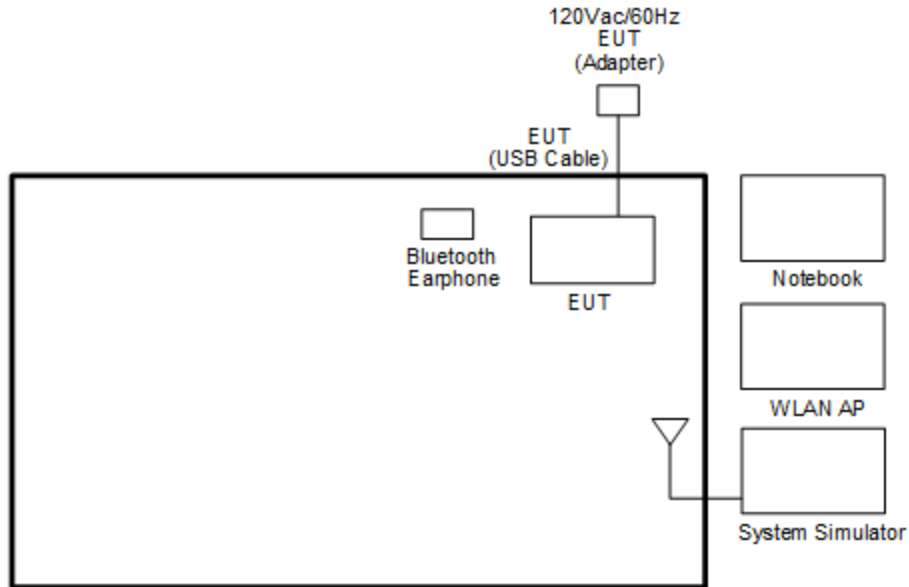

2.4 Support Unit used in test configuration and system

Item	Equipment	Trade Name	Model Name	FCC ID	Data Cable	Power Cord
1.	System Simulator	R&S	CMU 200	N/A	N/A	Unshielded, 1.8 m
2.	WLAN AP	D-Link	DIR-628	KA2DIR628A2	N/A	Unshielded, 1.8 m
3.	Notebook	DELL	Latitude E6320	FCC DoC/ Contains FCC ID: QDS-BRCM1054	N/A	AC I/P: Unshielded, 1.2 m DC O/P: Shielded, 1.8 m
4.	SD Card	SanDisk	MicroSD HC	FCC DoC	N/A	N/A
5.	Earphone	Motorola	SH38C16618	N/A	Unshielded, 1.2 m	N/A



2.5 EUT Operation Test Setup

The RF test items, utility “QRCT” was installed in Notebook which was programmed in order to make the EUT get into the engineering modes to provide channel selection, power level, data rate and the application type and for continuous transmitting signals.

2.6 Measurement Results Explanation Example

For all conducted test items:

The offset level is set in the spectrum analyzer to compensate the RF cable loss and attenuator factor between EUT conducted output port and spectrum analyzer. With the offset compensation, the spectrum analyzer reading level is exactly the EUT RF output level.

Example :

The spectrum analyzer offset is derived from RF cable loss and attenuator factor.

Offset = RF cable loss + attenuator factor.

Following shows an offset computation example with cable loss 4.2 dB and 10dB attenuator.

$$\begin{aligned} \text{Offset(dB)} &= \text{RF cable loss(dB)} + \text{attenuator factor(dB)}. \\ &= 4.2 + 10 = 14.2 \text{ (dB)} \end{aligned}$$

3 Test Result

3.1 26dB & 99% Occupied Bandwidth Measurement

3.1.1 Description of 26dB & 99% Occupied Bandwidth

This section is for reporting purpose only.

There is no restriction limits for bandwidth.

3.1.2 Measuring Instruments

The measuring equipment is listed in the section 4 of this test report.

3.1.3 Test Procedures

1. The testing follows FCC KDB 789033 D02 General UNII Test Procedures New Rules v02r01. Section C) Emission bandwidth
2. Set RBW = approximately 1% of the emission bandwidth.
3. Set the VBW > RBW.
4. Detector = Peak.
5. Trace mode = max hold
6. Measure the maximum width of the emission that is 26 dB down from the peak of the emission. Compare this with the RBW setting of the analyzer. Readjust RBW and repeat measurement as needed until the RBW/EBW ratio is approximately 1%.
7. For 99% Bandwidth Measurement, the spectrum analyzer's resolution bandwidth (RBW) is set 1MHz and set the Video bandwidth (VBW) $\geq 3 * RBW$.
8. Measure and record the results in the test report.

3.1.4 Test Setup

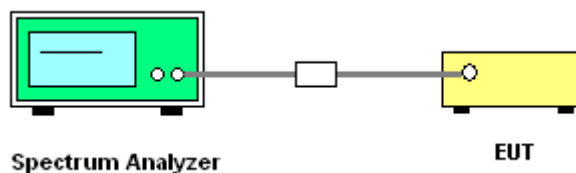

3.1.5 Test Result of 26dB & 99% Occupied Bandwidth

Please refer to Appendix A.

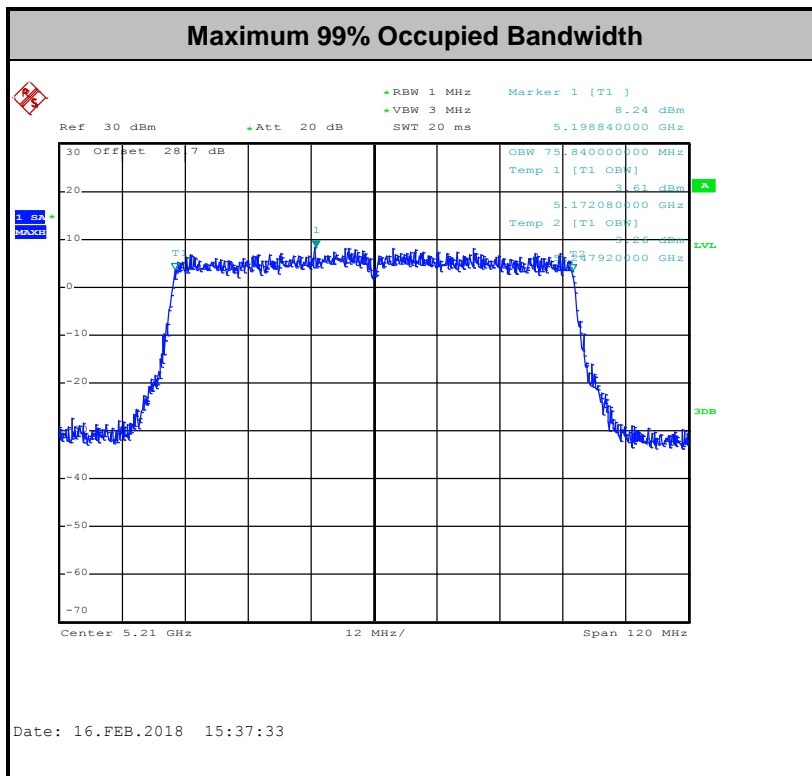
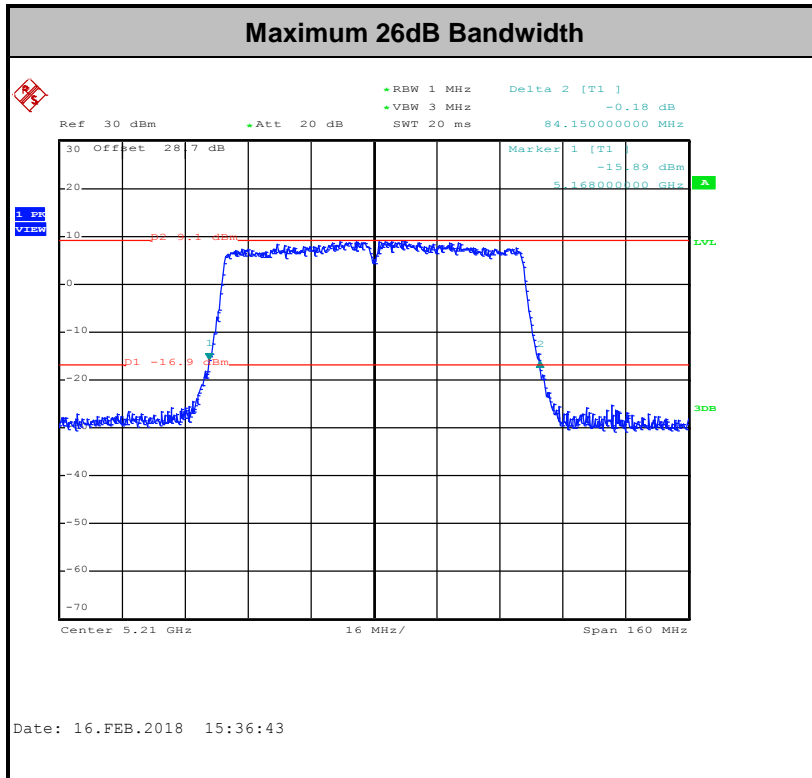

Note: The occupied channel bandwidth is maintained within the band of operation for all of the modulations.



3.2 Maximum Conducted Output Power Measurement

3.2.1 Limit of Maximum Conducted Output Power

<FCC 14-30 CFR 15.407>

For mobile and portable client devices in the 5.15–5.25 GHz band, the maximum conducted output power over the frequency band of operation shall not exceed 250 mW.

For the 5.25–5.725 GHz bands, the maximum conducted output power over the frequency bands of operation shall not exceed the lesser of 250 mW or 11 dBm $10 \log B$, where B is the 26 dB emission bandwidth in megahertz.

If transmitting antennas of directional gain greater than 6 dBi are used, the peak output power shall be reduced by the amount in dB that the directional gain of the antenna exceeds 6 dBi.

Note that U-NII-2 band, devices with a maximum e.i.r.p. greater than 500 mW shall implement TPC in order to have the capability to operate at least 6 dB below the maximum permitted e.i.r.p. of 1 W.

3.2.2 Measuring Instruments

The measuring equipment is listed in the section 4 of this test report.

3.2.3 Test Procedures

The testing follows Method PM of FCC KDB 789033 D02 General UNII Test Procedures New Rules v02r01.

Method PM (Measurement using an RF average power meter):

1. Measurement is performed using a wideband RF power meter.
2. The EUT is configured to transmit continuously with a consistent duty cycle at its maximum power control level.
3. Measure the average power of the transmitter, and the average power is corrected with duty factor, $10 \log(1/x)$, where x is the duty cycle.

3.2.4 Test Setup

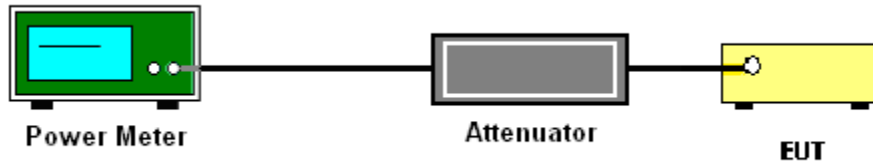

3.2.5 Test Result of Maximum Conducted Output Power

Please refer to Appendix A.



3.3 Power Spectral Density Measurement

3.3.1 Limit of Power Spectral Density

<FCC 14-30 CFR 15.407>

For an indoor access point operating in the band 5.15-5.25 GHz, the maximum power spectral density shall not exceed 17 dBm in any 1 megahertz band.

For the 5.25–5.725 GHz bands, the maximum power spectral density shall not exceed 11 dBm in any 1 megahertz band.

If transmitting antennas of directional gain greater than 6 dBi are used, the peak output power shall be reduced by the amount in dB that the directional gain of the antenna exceeds 6 dBi.

3.3.2 Measuring Instruments

The measuring equipment is listed in the section 4 of this test report.

3.3.3 Test Procedures

The testing follows FCC KDB 789033 D02 General UNII Test Procedures New Rules v02r01. Section F) Maximum power spectral density.

Method SA-2

(trace averaging across on and off times of the EUT transmissions, followed by duty cycle correction).

- Measure the duty cycle.
- Set span to encompass the entire emission bandwidth (EBW) of the signal.
- Set RBW = 1 MHz.
- Set VBW \geq 3 MHz.
- Number of points in sweep \geq 2 Span / RBW.
- Sweep time = auto.
- Detector = RMS
- Trace average at least 100 traces in power averaging mode.
- Add $10 \log(1/x)$, where x is the duty cycle, to the measured power in order to compute the average power during the actual transmission times. For example, add $10 \log(1/0.25) = 6$ dB if the duty cycle is 25 percent.

1. The RF output of EUT was connected to the spectrum analyzer by a low loss cable.
2. Each plot has already offset with cable loss, and attenuator loss. Measure the PPSD and record it.

3.3.4 Test Setup

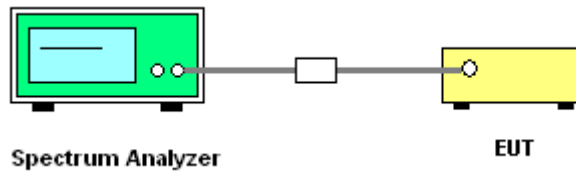

3.3.5 Test Result of Power Spectral Density

Please refer to Appendix A.

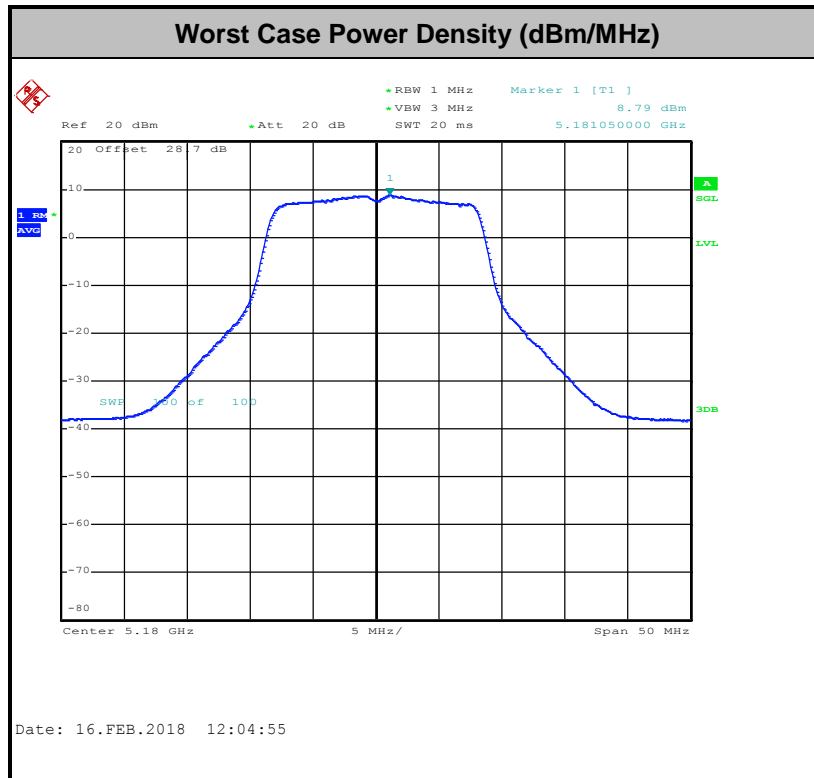

Note: Average Power Density (dB) = Measured value+ Duty Factor



3.4 AC Conducted Emission Measurement

3.4.1 Limit of AC Conducted Emission

For equipment that is designed to be connected to the public utility (AC) power line, the radio frequency voltage that is conducted back onto the AC power line on any frequency or frequencies within the band 150 kHz to 30 MHz shall not exceed the limits in the following table.

Frequency of emission (MHz)	Conducted limit (dBµV)	
	Quasi-peak	Average
0.15-0.5	66 to 56*	56 to 46*
0.5-5	56	46
5-30	60	50

*Decreases with the logarithm of the frequency.

3.4.2 Measuring Instruments

The measuring equipment is listed in the section 4 of this test report.

3.4.3 Test Procedures

1. The EUT was placed 0.4 meter from the conducting wall of the shielding room was kept at least 80 centimeters from any other grounded conducting surface.
2. Connect EUT to the power mains through a line impedance stabilization network (LISN).
3. All the support units are connecting to the other LISN.
4. The LISN provides 50 ohm coupling impedance for the measuring instrument.
5. The FCC states that a 50 ohm, 50 microhenry LISN should be used.
6. Both sides of AC line were checked for maximum conducted interference.
7. The frequency range from 150 kHz to 30 MHz was searched.
8. Set the test-receiver system to Peak Detect Function and specified bandwidth with Maximum Hold Mode.

3.4.4 Test Setup

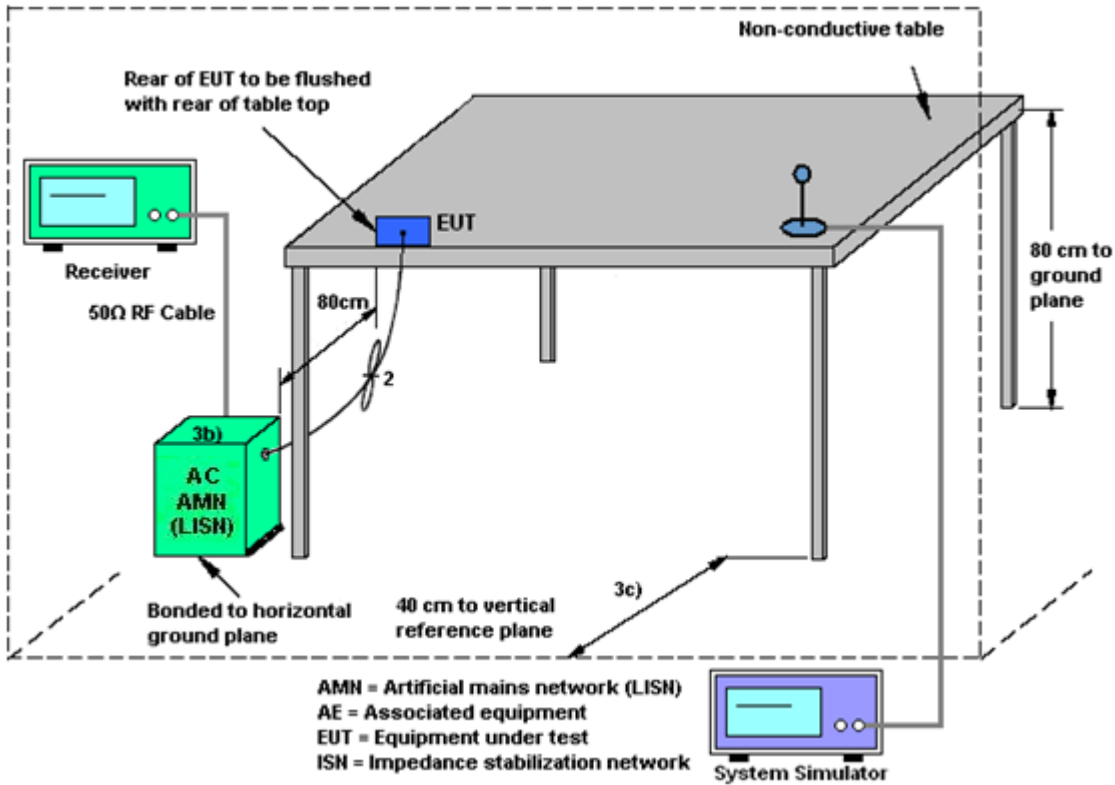

3.4.5 Test Result of AC Conducted Emission

Please refer to Appendix B.



3.5 Automatically Discontinue Transmission

3.5.1 Limit of Automatically Discontinue Transmission

The device shall automatically discontinue transmission in case of either absence of information to transmit or operational failure. These provisions are not intended to preclude the transmission of control or signaling information or the use of repetitive codes used by certain digital technologies to complete frame or burst intervals. Applicants shall include in their application for equipment authorization to describe how this requirement is met.

3.5.2 Measuring Instruments

The measuring equipment is listed in the section 4 of this test report.

3.5.3 Test Result of Automatically Discontinue Transmission

While the EUT is not transmitting any information, the EUT can automatically discontinue transmission and become standby mode for power saving. The EUT can detect the controlling signal of ACK message transmitting from remote device and verify whether it shall resend or discontinue transmission.



3.6 Antenna Requirements

3.6.1 Standard Applicable

If transmitting antenna directional gain is greater than 6 dBi, both the peak transmit power and the peak power spectral density shall be reduced by the amount in dB that the directional gain of the antenna exceeds 6 dBi.

3.6.2 Antenna Anti-Replacement Construction

An embedded-in antenna design is used.

3.6.3 Antenna Gain

The antenna peak gain of EUT is less than 6 dBi. Therefore, it is not necessary to reduce maximum peak output power limit.



4 List of Measuring Equipment

Instrument	Manufacturer	Model No.	Serial No.	Characteristics	Calibration Date	Test Date	Due Date	Remark
Power Meter	Anritsu	ML2495A	1240001	N/A	Sep. 07, 2017	Jan. 23, 2018~ Feb. 23, 2018	Sep. 06, 2018	Conducted (TH05-HY)
Power Sensor	Anritsu	MA2411B	1207349	300MHz~40GHz	Sep. 07, 2017	Jan. 23, 2018~ Feb. 23, 2018	Sep. 06, 2018	Conducted (TH05-HY)
Spectrum Analyzer	Rohde & Schwarz	FSP40	100055	9kHz~40GHz	Jun. 20, 2017	Jan. 23, 2018~ Feb. 23, 2018	Jun. 19, 2018	Conducted (TH05-HY)
AC Power Source	ChainTek	APC-1000W	N/A	N/A	N/A	Feb. 09, 2018	N/A	Conduction (CO05-HY)
EMI Test Receiver	Rohde & Schwarz	ESCI 7	100724	9kHz~7GHz	Sep. 20, 2017	Feb. 09, 2018	Sep. 19, 2018	Conduction (CO05-HY)
LISN	Rohde & Schwarz	ENV216	100080	9kHz~30MHz	Nov. 30, 2017	Feb. 09, 2018	Nov. 29, 2018	Conduction (CO05-HY)



5 Uncertainty of Evaluation

Uncertainty of Conducted Emission Measurement (150kHz ~ 30MHz)

Measuring Uncertainty for a Level of Confidence of 95% ($U = 2Uc(y)$)	2.70
---	------

Appendix A. Test Result of Conducted Test Items

Test Engineer:	Kai Liao/Derek Hsu/Reece Lin	Temperature:	21~25	°C
Test Date:	2018/1/23~2018/2/23	Relative Humidity:	51~54	%

TEST RESULTS DATA
26dB and 99% OBW

Band I										
Mod.	Data Rate	NTX	CH.	Freq. (MHz)	99% Bandwidth (MHz)	26 dB Bandwidth (MHz)	IC 99% Bandwidth Power Limit (dBm)	IC 99% Bandwidth EIRP Limit (dBm)		
11a	6Mbps	1	36	5180	17.70	25.05	-	22.48		
11a	6Mbps	1	44	5220	17.55	24.40	-	22.44		
11a	6Mbps	1	48	5240	17.45	24.80	-	22.42		
HT20	MCS0	1	36	5180	18.70	25.40	-	22.72		
HT20	MCS0	1	44	5220	18.70	26.32	-	22.72		
HT20	MCS0	1	48	5240	18.80	26.23	-	22.74		
HT40	MCS0	1	38	5190	36.60	42.34	-	23.01		
HT40	MCS0	1	46	5230	36.60	42.52	-	23.01		
VHT80	MCS0	1	42	5210	75.84	84.15	-	23.01		

TEST RESULTS DATA
Average Power Table

FCC Band I										
Mod.	Data Rate	NTX	CH.	Freq. (MHz)	Duty Factor (dB)	Average Conducted Power (dBm)	FCC Conducted Power Limit (dBm)	DG (dBi)		Pass/Fail
11a	6Mbps	1	36	5180	0.29	19.99	24.00	-6.50		Pass
11a	6Mbps	1	44	5220	0.29	19.87	24.00	-6.50		Pass
11a	6Mbps	1	48	5240	0.29	19.97	24.00	-6.50		Pass
HT20	MCS0	1	36	5180	0.16	19.93	24.00	-6.50		Pass
HT20	MCS0	1	44	5220	0.16	19.72	24.00	-6.50		Pass
HT20	MCS0	1	48	5240	0.16	19.74	24.00	-6.50		Pass
HT40	MCS0	1	38	5190	0.27	18.95	24.00	-6.50		Pass
HT40	MCS0	1	46	5230	0.27	18.71	24.00	-6.50		Pass
VHT20	MCS0	1	36	5180	0.16	19.84	24.00	-6.50		Pass
VHT20	MCS0	1	44	5220	0.16	19.71	24.00	-6.50		Pass
VHT20	MCS0	1	48	5240	0.16	19.72	24.00	-6.50		Pass
VHT40	MCS0	1	38	5190	0.27	18.94	24.00	-6.50		Pass
VHT40	MCS0	1	46	5230	0.27	18.69	24.00	-6.50		Pass
VHT80	MCS0	1	42	5210	0.60	17.83	24.00	-6.50		Pass

TEST RESULTS DATA
Power Spectral Density

FCC Band I										
Mod.	Data Rate	NTX	CH.	Freq. (MHz)	Duty Factor (dB)	Average Power Density (dBm/MHz)	Average PSD Limit (dBm/MHz)	DG (dBi)	-	Pass/Fail
11a	6Mbps	1	36	5180	0.29	9.08	11.00	-6.50		Pass
11a	6Mbps	1	44	5220	0.29	8.47	11.00	-6.50		Pass
11a	6Mbps	1	48	5240	0.29	8.33	11.00	-6.50		Pass
HT20	MCS0	1	36	5180	0.16	8.46	11.00	-6.50		Pass
HT20	MCS0	1	44	5220	0.16	7.93	11.00	-6.50		Pass
HT20	MCS0	1	48	5240	0.16	7.82	11.00	-6.50		Pass
HT40	MCS0	1	38	5190	0.27	4.71	11.00	-6.50		Pass
HT40	MCS0	1	46	5230	0.27	3.94	11.00	-6.50		Pass
VHT80	MCS0	1	42	5210	0.60	0.42	11.00	-6.50		Pass

TEST RESULTS DATA
26dB and 99% OBW

Band II										
Mod.	Data Rate	NTX	CH.	Freq. (MHz)	99% Bandwidth (MHz)	26 dB Bandwidth (MHz)	IC 99% Bandwidth Power Limit (dBm)	IC 99% Bandwidth EIRP Limit (dBm)	FCC 26dB Bandwidth Power Limit (dBm)	Note
11a	6M bps	1	52	5260	17.50	24.98	23.43	29.43	23.98	
11a	6M bps	1	60	5300	17.80	24.05	23.50	29.50	23.98	
11a	6M bps	1	64	5320	17.55	24.93	23.44	29.44	23.98	
HT20	MCS 0	1	52	5260	18.80	26.25	23.74	29.74	23.98	
HT20	MCS 0	1	60	5300	18.75	25.55	23.73	29.73	23.98	
HT20	MCS 0	1	64	5320	18.75	25.85	23.73	29.73	23.98	
HT40	MCS 0	1	54	5270	36.60	42.54	23.98	30.00	23.98	
HT40	MCS 0	1	62	5310	36.50	42.15	23.98	30.00	23.98	
VHT80	MCS 0	1	58	5290	75.84	84.00	23.98	30.00	23.98	

TEST RESULTS DATA
Average Power Table

FCC Band II										
Mod.	Data Rate	NTX	CH.	Freq. (MHz)	Duty Factor (dB)	Average Conducted Power (dBm)	FCC Conducted Power Limit (dBm)	DG (dBi)	EIRP Power Limit (dBm)	Pass/Fail
11a	6M bps	1	52	5260	0.29	19.95	23.98	-6.50	26.99	Pass
11a	6M bps	1	60	5300	0.29	19.97	23.98	-6.50	26.99	Pass
11a	6M bps	1	64	5320	0.29	19.98	23.98	-6.50	26.99	Pass
HT20	MCS 0	1	52	5260	0.16	19.74	23.98	-6.50	26.99	Pass
HT20	MCS 0	1	60	5300	0.16	19.68	23.98	-6.50	26.99	Pass
HT20	MCS 0	1	64	5320	0.16	19.80	23.98	-6.50	26.99	Pass
HT40	MCS 0	1	54	5270	0.27	18.82	23.98	-6.50	26.99	Pass
HT40	MCS 0	1	62	5310	0.27	18.84	23.98	-6.50	26.99	Pass
VHT20	MCS 0	1	52	5260	0.16	19.73	23.98	-6.50	26.99	Pass
VHT20	MCS 0	1	60	5300	0.16	19.66	23.98	-6.50	26.99	Pass
VHT20	MCS 0	1	64	5320	0.16	19.79	23.98	-6.50	26.99	Pass
VHT40	MCS 0	1	54	5270	0.27	18.81	23.98	-6.50	26.99	Pass
VHT40	MCS 0	1	62	5310	0.27	18.82	23.98	-6.50	26.99	Pass
VHT80	MCS 0	1	58	5290	0.60	17.93	23.98	-6.50	26.99	Pass

TEST RESULTS DATA
Power Spectral Density

Band II										
Mod.	Data Rate	NTX	CH.	Freq. (MHz)	Duty Factor (dB)	Average Power Density (dBm/MHz)	Average PSD Limit (dBm/MHz)	DG (dBi)		Pass/Fail
11a	6M bps	1	52	5260	0.29	8.21	11.00	-6.50		Pass
11a	6M bps	1	60	5300	0.29	8.05	11.00	-6.50		Pass
11a	6M bps	1	64	5320	0.29	8.22	11.00	-6.50		Pass
HT20	MCS 0	1	52	5260	0.16	7.71	11.00	-6.50		Pass
HT20	MCS 0	1	60	5300	0.16	7.53	11.00	-6.50		Pass
HT20	MCS 0	1	64	5320	0.16	7.63	11.00	-6.50		Pass
HT40	MCS 0	1	54	5270	0.27	3.75	11.00	-6.50		Pass
HT40	MCS 0	1	62	5310	0.27	3.90	11.00	-6.50		Pass
VHT80	MCS 0	1	58	5290	0.60	-0.15	11.00	-6.50		Pass

TEST RESULTS DATA
26dB and 99% OBW

Band III										
Mod.	Data Rate	NTX	CH.	Freq. (MHz)	99% Bandwidth In UNII-2C (MHz)	26 dB Bandwidth In UNII-2C (MHz)	IC 99% Bandwidth Power Limit (dBm)	IC 99% Bandwidth EIRP Limit (dBm)	FCC 26dB Bandwidth Power Limit (dBm)	6dB Bandwidth for Straddle Channel (MHz)
11a	6M bps	1	100	5500	17.55	24.67	23.44	29.44	23.98	----
11a	6M bps	1	116	5580	17.60	24.92	23.46	29.46	23.98	----
11a	6M bps	1	140	5700	17.50	24.46	23.43	29.43	23.98	----
HT20	MCS 0	1	100	5500	18.75	25.62	23.73	29.73	23.98	----
HT20	MCS 0	1	116	5580	18.70	26.40	23.72	29.72	23.98	----
HT20	MCS 0	1	140	5700	18.85	26.87	23.75	29.75	23.98	----
HT40	MCS 0	1	102	5510	36.60	42.24	23.98	30.00	23.98	----
HT40	MCS 0	1	110	5550	36.50	41.98	23.98	30.00	23.98	----
HT40	MCS 0	1	134	5670	36.60	42.24	23.98	30.00	23.98	----
VHT80	MCS 0	1	106	5530	75.84	83.76	23.98	30.00	23.98	----

TEST RESULTS DATA
Average Power Table

FCC Band III										
Mod.	Data Rate	N _{TX}	CH.	Freq. (MHz)	Duty Factor (dB)	Average Conducted Power (dBm)	FCC Conducted Power Limit (dBm)	DG (dBi)	EIRP Power Limit (dBm)	Pass/Fail
11a	6M bps	1	100	5500	0.29	19.96	23.98	-7.00	26.99	Pass
11a	6M bps	1	116	5580	0.29	19.75	23.98	-7.00	26.99	Pass
11a	6M bps	1	140	5700	0.29	19.85	23.98	-7.00	26.99	Pass
HT20	MCS 0	1	100	5500	0.16	19.77	23.98	-7.00	26.99	Pass
HT20	MCS 0	1	116	5580	0.16	19.97	23.98	-7.00	26.99	Pass
HT20	MCS 0	1	140	5700	0.16	19.99	23.98	-7.00	26.99	Pass
HT40	MCS 0	1	102	5510	0.27	18.97	23.98	-7.00	26.99	Pass
HT40	MCS 0	1	110	5550	0.27	18.99	23.98	-7.00	26.99	Pass
HT40	MCS 0	1	134	5670	0.27	18.99	23.98	-7.00	26.99	Pass
VHT20	MCS 0	1	100	5500	0.16	19.73	23.98	-7.00	26.99	Pass
VHT20	MCS 0	1	116	5580	0.16	19.91	23.98	-7.00	26.99	Pass
VHT20	MCS 0	1	140	5700	0.16	19.94	23.98	-7.00	26.99	Pass
VHT40	MCS 0	1	102	5510	0.27	18.96	23.98	-7.00	26.99	Pass
VHT40	MCS 0	1	110	5550	0.27	18.93	23.98	-7.00	26.99	Pass
VHT40	MCS 0	1	134	5670	0.27	18.71	23.98	-7.00	26.99	Pass
VHT80	MCS 0	1	106	5530	0.60	17.72	23.98	-7.00	26.99	Pass

TEST RESULTS DATA
Power Spectral Density

Band III										
Mod.	Data Rate	NTX	CH.	Freq. (MHz)	Duty Factor (dB)	Average Power Density (dBm/MHz)	Average PSD Limit (dBm/MHz)	DG (dBi)		Pass/Fail
11a	6M bps	1	100	5500	0.29	8.85	11.00	-7.00		Pass
11a	6M bps	1	116	5580	0.29	8.78	11.00	-7.00		Pass
11a	6M bps	1	140	5700	0.29	8.00	11.00	-7.00		Pass
HT20	MCS 0	1	100	5500	0.16	8.30	11.00	-7.00		Pass
HT20	MCS 0	1	116	5580	0.16	8.72	11.00	-7.00		Pass
HT20	MCS 0	1	140	5700	0.16	7.89	11.00	-7.00		Pass
HT40	MCS 0	1	102	5510	0.27	4.57	11.00	-7.00		Pass
HT40	MCS 0	1	110	5550	0.27	4.86	11.00	-7.00		Pass
HT40	MCS 0	1	134	5670	0.27	4.35	11.00	-7.00		Pass
VHT80	MCS 0	1	106	5530	0.60	0.27	11.00	-7.00		Pass



Appendix B. AC Conducted Emission Test Results

Test Engineer :	Blue Lan	Temperature :	26~27°C
		Relative Humidity :	53~55%

EUT Information

Report NO : 811821
 Test Mode : Mode 1
 Test Voltage : 120Vac/60Hz
 Phase : Line

Full Spectrum

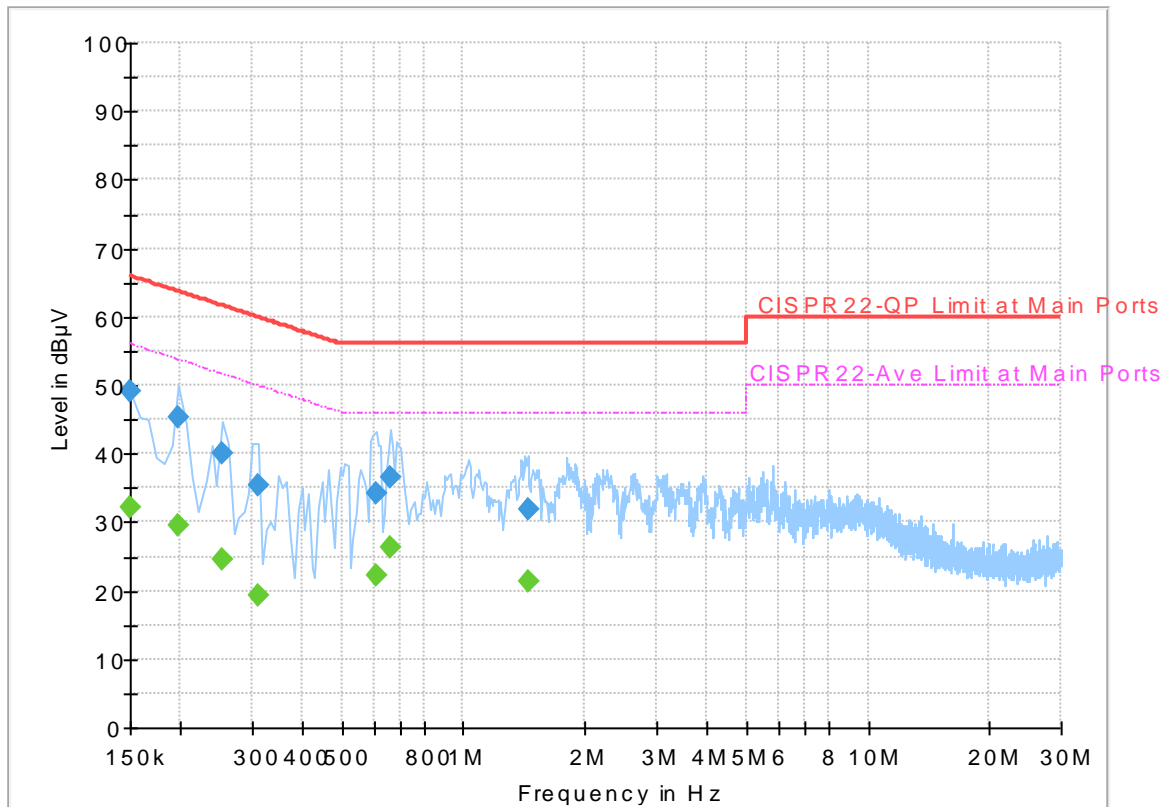

Final_Result

Frequency (MHz)	QuasiPeak (dBµV)	Average (dBµV)	Limit (dBµV)	Margin (dB)	Line	Filter	Corr. (dB)
0.150000	---	32.08	56.00	23.92	L1	OFF	19.5
0.150000	49.25	---	66.00	16.75	L1	OFF	19.5
0.198000	---	29.66	53.69	24.03	L1	OFF	19.5
0.198000	45.34	---	63.69	18.35	L1	OFF	19.5
0.254000	---	24.69	51.63	26.94	L1	OFF	19.5
0.254000	39.94	---	61.63	21.69	L1	OFF	19.5
0.310000	---	19.27	49.97	30.70	L1	OFF	19.5
0.310000	35.37	---	59.97	24.60	L1	OFF	19.5
0.606000	---	22.32	46.00	23.68	L1	OFF	19.5
0.606000	34.19	---	56.00	21.81	L1	OFF	19.5
0.662000	---	26.35	46.00	19.65	L1	OFF	19.5
0.662000	36.53	---	56.00	19.47	L1	OFF	19.5
1.446000	---	21.44	46.00	24.56	L1	OFF	19.6
1.446000	31.94	---	56.00	24.06	L1	OFF	19.6

EUT Information

Report NO : 811821
 Test Mode : Mode 1
 Test Voltage : 120Vac/60Hz
 Phase : Neutral

Full Spectrum

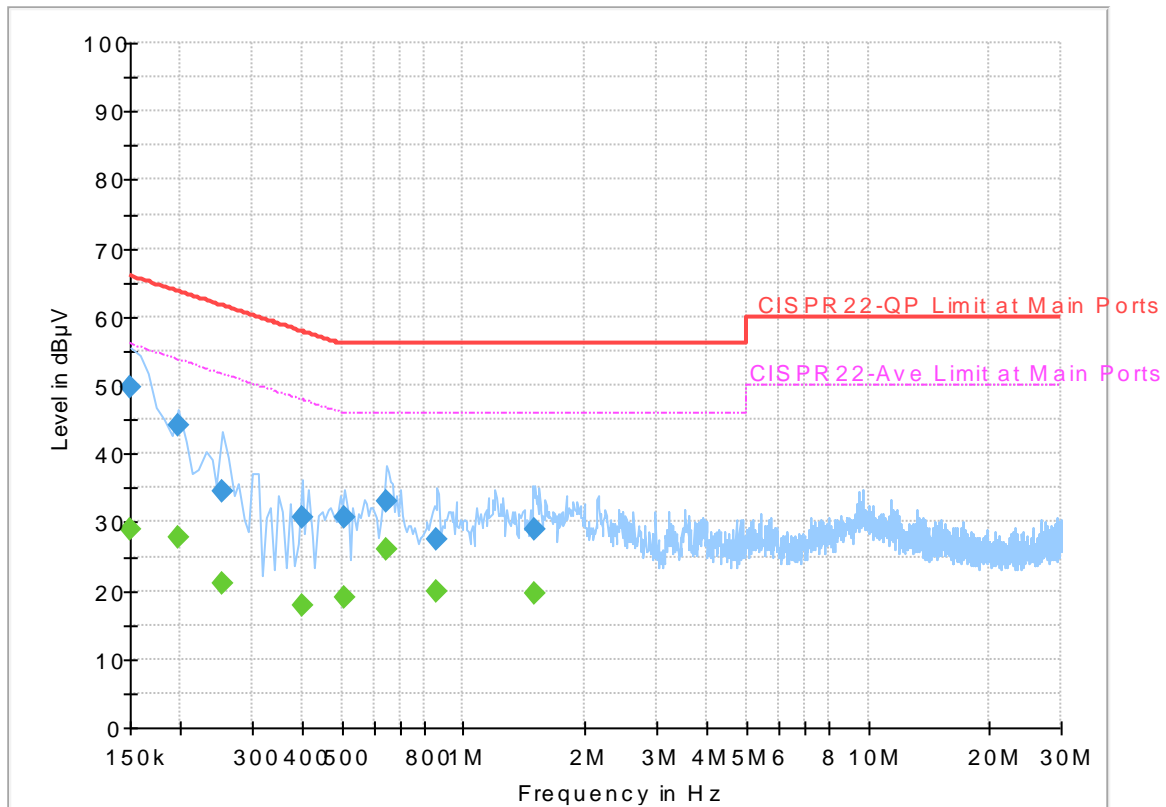

Final_Result

Frequency (MHz)	QuasiPeak (dBµV)	Average (dBµV)	Limit (dBµV)	Margin (dB)	Line	Filter	Corr. (dB)
0.150000	---	28.96	56.00	27.04	N	OFF	19.5
0.150000	49.59	---	66.00	16.41	N	OFF	19.5
0.198000	---	27.84	53.69	25.85	N	OFF	19.5
0.198000	44.06	---	63.69	19.63	N	OFF	19.5
0.254000	---	20.91	51.63	30.72	N	OFF	19.5
0.254000	34.47	---	61.63	27.16	N	OFF	19.5
0.398000	---	17.87	47.90	30.03	N	OFF	19.5
0.398000	30.79	---	57.90	27.11	N	OFF	19.5
0.510000	---	19.05	46.00	26.95	N	OFF	19.5
0.510000	30.75	---	56.00	25.25	N	OFF	19.5
0.646000	---	25.99	46.00	20.01	N	OFF	19.5
0.646000	33.10	---	56.00	22.90	N	OFF	19.5
0.862000	---	19.97	46.00	26.03	N	OFF	19.5
0.862000	27.50	---	56.00	28.50	N	OFF	19.5
1.502000	---	19.45	46.00	26.55	N	OFF	19.5
1.502000	28.81	---	56.00	27.19	N	OFF	19.5