



FCC Test Report

APPLICANT : Motorola Mobility LLC
EQUIPMENT : Mobile Cellular Phone
BRAND NAME : Motorola
MODEL NAME : XT1925-2, XT1925-1
FCC ID : IHDT56XD5
STANDARD : FCC 47 CFR FCC Part 15 Subpart B
CLASSIFICATION : Certification

The product was received on Dec. 25, 2017 and testing was completed on Dec. 21, 2017. We, Sporton International (Kunshan) Inc., would like to declare that the tested sample has been evaluated in accordance with the test procedures given in ANSI C63.4-2014 and has been in compliance with the applicable technical standards.

The test results in this report apply exclusively to the tested model / sample. Without written approval of Sporton International (Kunshan) Inc., the test report shall not be reproduced except in full.



Approved by: James Huang / Manager

Sporton International (Kunshan) Inc.

**No.3-2 Ping-Xiang Rd, Kunshan Development Zone Kunshan City Jiangsu Province 215335
China**



TABLE OF CONTENTS

REVISION HISTORY..... 3

SUMMARY OF TEST RESULT 4

1. GENERAL DESCRIPTION 5

 1.1. Applicant..... 5

 1.2. Manufacturer 5

 1.3. Product Feature of Equipment Under Test 5

 1.4. Product Specification of Equipment Under Test 6

 1.5. Specification of Accessory 7

 1.6. Modification of EUT 8

 1.7. Test Location 8

 1.8. Applicable Standards 8

2. TEST CONFIGURATION OF EQUIPMENT UNDER TEST 9

 2.1. Test Mode 9

 2.2. Connection Diagram of Test System 12

 2.3. Support Unit used in test configuration and system 14

 2.4. EUT Operation Test Setup 14

3. TEST RESULT 15

 3.1. Test of AC Conducted Emission Measurement 15

 3.2. Test of Radiated Emission Measurement 21

4. LIST OF MEASURING EQUIPMENT 27

5. UNCERTAINTY OF EVALUATION 28

APPENDIX A. SETUP PHOTOGRAPHS



SUMMARY OF TEST RESULT

Report Section	FCC Rule	Description	Limit	Result	Remark
3	15.107	AC Conducted Emission	< 15.107 limits	PASS	Under limit 7.06 dB at 0.169 MHz
3.2	15.109	Radiated Emission	< 15.109 limits	PASS	Under limit 3.07 dB at 43.77 MHz for Quasi-Peak



1. General Description

1.1. Applicant

Motorola Mobility LLC
222 W, Merchandise Mart Plaza, Chicago IL 60654 USA

1.2. Manufacturer

Motorola Mobility LLC
222 W, Merchandise Mart Plaza, Chicago IL 60654 USA

1.3. Product Feature of Equipment Under Test

Product Feature	
Equipment	Mobile Cellular Phone
Brand Name	Motorola
Model Name	XT1925-2, XT1925-1
FCC ID	IHDT56XD5
EUT supports Radios application	GSM/GPRS/EGPRS/WCDMA/HSPA/DC-HSDPA/ HSPA+(Uplink is not supported)/LTE/ WLAN 2.4GHz 802.11b/g/n HT20/ WLAN 5GHz 802.11a/n HT20/HT40/ Bluetooth v3.0 + EDR/Bluetooth v4.0 LE/ Bluetooth v4.1 LE/Bluetooth v4.2 LE
IMEI Code	Conduction: 351847090011676/351847090011684 for Sample 1 Radiation: 351847090011676/351847090011684 for Sample 1 351872090005833 for Sample 2
HW Version	DVT1-B
SW Version	ali_n-userdebug 8.0.0 OPS27.55 1276 intcfg,test-keys
EUT Stage	Identical Prototype

Remark:

1. The above EUT's information was declared by manufacturer. Please refer to the specifications or user's manual for more detailed description.
2. There are two types of EUT: sample 1 (XT1925-2) is dual SIM card, sample 2 (XT1925-1) is single SIM card. According to the difference, choose sample 1 to perform full test, sample 2 to verify worst cases.



1.4. Product Specification of Equipment Under Test

Standards-related Product Specification	
Tx Frequency	GSM850: 824.2 MHz ~ 848.8 MHz GSM1900: 1850.2 MHz ~ 1909.8MHz WCDMA Band V: 826.4 MHz ~ 846.6 MHz WCDMA Band IV : 1712.4 MHz ~ 1752.6 MHz WCDMA Band II: 1852.4 MHz ~ 1907.6 MHz LTE Band 2 : 1850.7 MHz ~ 1909.3 MHz LTE Band 4 : 1710.7 MHz ~ 1754.3 MHz LTE Band 5 : 824.7 MHz ~ 848.3 MHz LTE Band 7 : 2502.5 MHz ~ 2567.5 MHz LTE Band 12 : 699.7 MHz ~ 715.3 MHz LTE Band 17 : 706.5 MHz ~ 713.5 MHz 802.11b/g/n: 2412 MHz ~ 2462 MHz 802.11a/n: 5180 MHz ~ 5240 MHz; 5260 MHz ~ 5320 MHz; 5500 MHz ~ 5700 MHz; 5745 MHz ~ 5825 MHz Bluetooth: 2402 MHz ~ 2480 MHz
Rx Frequency	GSM850: 869.2 MHz ~ 893.8 MHz GSM1900: 1930.2 MHz ~ 1989.8 MHz WCDMA Band V: 871.4 MHz ~ 891.6 MHz WCDMA Band IV : 2112.4 MHz ~ 2152.6 MHz WCDMA Band II: 1932.4 MHz ~ 1987.6 MHz LTE Band 2 : 1930.7 MHz ~ 1989.3 MHz LTE Band 4 : 2110.7 MHz ~ 2154.3 MHz LTE Band 5 : 869.7 MHz ~ 893.3 MHz LTE Band 7: 2622.5 MHz ~ 2687.5 MHz LTE Band 12 : 729.7 MHz ~ 745.3 MHz LTE Band 17 : 736.5 MHz ~ 743.5 MHz 802.11b/g/n: 2412 MHz ~ 2462 MHz 802.11a/n: 5180 MHz ~ 5240 MHz; 5260 MHz ~ 5320 MHz; 5500 MHz ~ 5700 MHz; 5745 MHz ~ 5825 MHz Bluetooth: 2402 MHz ~ 2480 MHz GNSS : 1559 MHz ~ 1610 MHz FM : 88 MHz ~ 108 MHz
Antenna Type	WWAN : PIFA Antenna WLAN : PIFA Antenna Bluetooth : PIFA Antenna GNSS: PIFA Antenna FM: External headset Antenna
Type of Modulation	GSM: GMSK GPRS: GMSK EDGE(MCS 0-4): GMSK / (MCS 5-9): 8PSK WCDMA : BPSK (Uplink) HSDPA/DC-HSDPA : QPSK (Uplink) HSUPA : QPSK (Uplink) HSPA+ : 16QAM(Uplink is not supported) DC-HSDPA : 64QAM LTE: QPSK / 16QAM / 64QAM 802.11b : DSSS (DBPSK / DQPSK / CCK) 802.11a/g/n : OFDM (BPSK / QPSK / 16QAM / 64QAM) Bluetooth LE : GFSK Bluetooth (1Mbps) : GFSK



	Bluetooth (2Mbps) : $\pi/4$ -DQPSK Bluetooth (3Mbps) : 8-DPSK GNSS : BPSK FM
--	---

Note: GNSS=BDS+GLONASS+GPS

1.5. Specification of Accessory

Specification of Accessory			
AC Adapter 1(US)	Brand Name	Motorola (Salom)	Model Name SC-22
	Power Rating	I/P: 100-240 Vac, 500mA, O/P: 5Vdc,3000mA or 9Vdc,1600mA or 12Vdc,1200mA	
AC Adapter 1(EU)	Brand Name	Motorola (Salom)	Model Name SC-23
	Power Rating	I/P: 100-240 Vac, 500mA, O/P: 5Vdc,3000mA or 9Vdc,1600mA or 12Vdc,1200mA	
AC Adapter 1(UK)	Brand Name	Motorola (Salom)	Model Name SC-24
	Power Rating	I/P: 100-240 Vac, 500mA, O/P: 5Vdc,3000mA or 9Vdc,1600mA or 12Vdc,1200mA	
AC Adapter 1(IN)	Brand Name	Motorola (Salom)	Model Name SC-25
	Power Rating	I/P: 100-240 Vac, 500mA, O/P: 5Vdc,3000mA or 9Vdc,1600mA or 12Vdc,1200mA	
AC Adapter 1(AU)	Brand Name	Motorola (Salom)	Model Name SC-26
	Power Rating	I/P: 100-240 Vac, 500mA, O/P: 5Vdc,3000mA or 9Vdc,1600mA or 12Vdc,1200mA	
AC Adapter 1(AR)	Brand Name	Motorola (Salom)	Model Name SC-27
	Power Rating	I/P: 100-240 Vac, 500mA, O/P: 5Vdc,3000mA or 9Vdc,1600mA or 12Vdc,1200mA	
AC Adapter 2(US)	Brand Name	Motorola (Chenyang)	Model Name SC-22
	Power Rating	I/P: 100-240 Vac, 500mA, O/P: 5Vdc,3000mA or 9Vdc,1600mA or 12Vdc,1200mA	
AC Adapter 2(EU)	Brand Name	Motorola (Chenyang)	Model Name SC-23
	Power Rating	I/P: 100-240 Vac, 500mA, O/P: 5Vdc,3000mA or 9Vdc,1600mA or 12Vdc,1200mA	
AC Adapter 2(UK)	Brand Name	Motorola (Chenyang)	Model Name SC-24
	Power Rating	I/P: 100-240 Vac, 500mA, O/P: 5Vdc,3000mA or 9Vdc,1600mA or 12Vdc,1200mA	
AC Adapter 2(IN)	Brand Name	Motorola (Chenyang)	Model Name SC-25
	Power Rating	I/P: 100-240 Vac, 500mA, O/P: 5Vdc,3000mA or 9Vdc,1600mA or 12Vdc,1200mA	
AC Adapter 2(AU)	Brand Name	Motorola (Chenyang)	Model Name SC-26
	Power Rating	I/P: 100-240 Vac, 500mA, O/P: 5Vdc,3000mA or 9Vdc,1600mA or 12Vdc,1200mA	
AC Adapter 2(AR)	Brand Name	Motorola (Chenyang)	Model Name SC-27
	Power Rating	I/P: 100-240 Vac, 500mA, O/P: 5Vdc,3000mA or 9Vdc,1600mA or 12Vdc,1200mA	
Battery	Brand Name	Motorola (ATL)	Model Name HG30
	Power Rating	3.8Vdc,3000mAh	Type Li-ion
Earphone 1	Brand Name	Motorola (Jiahe)	Model Name LS-118M-12
	Signal Line Type	1.2 meter, non-shielded cable, without ferrite core	
Earphone 2	Brand Name	Motorola (Lianyun)	Model Name TS910A-38AMS01WHR-M
	Signal Line Type	1.2 meter, non-shielded cable, without ferrite core	
USB Cable	Brand Name	Motorola (Liqi)	Model Name L32B-053000100-ALL
	Signal Line Type	1.0 meter, shielded cable, without ferrite core	



1.6. Modification of EUT

No modifications are made to the EUT during all test items.

1.7. Test Location

Sporton International (Kunshan) Inc. is accredited to ISO 17025 by National Voluntary Laboratory Accreditation Program (NVLAP code: 600155-0) and the FCC designation No. is CN5013.

Test Site	Sporton International (Kunshan) Inc.		
Test Site Location	No.3-2 Ping-Xiang Rd, Kunshan Development Zone Kunshan City Jiangsu Province 215335 China TEL : +86-512-57900158 FAX : +86-512-57900958		
Test Site No.	Sporton Site No.		FCC Test Firm Registration No.
	CO01-KS	03CH02-KS	630927

Note: The test site complies with ANSI C63.4 2014 requirement.

1.8. Applicable Standards

According to the specifications of the manufacturer, the EUT must comply with the requirements of the following standards:

- ♦ FCC 47 CFR FCC Part 15 Subpart B
- ♦ ANSI C63.4-2014

Remark: All test items were verified and recorded according to the standards and without any deviation during the test.



2. Test Configuration of Equipment Under Test

2.1. Test Mode

The EUT has been associated with peripherals pursuant to ANSI C63.4-2014 and configuration operated in a manner tended to maximize its emission characteristics in a typical application.

Frequency range investigated: conduction (150 kHz to 30 MHz), radiation (30MHz to the 5th harmonic of the highest fundamental frequency or to 40 GHz, whichever is lower).

Test Items	Function Type
AC Conducted Emission	Mode 1: GSM850 Idle + Bluetooth Idle + WLAN (2.4G) Idle + USB Cable 1 (Charging from Adapter 1) + Earphone 1 + Battery + Camera (Rear) for Sample 1 <Fig.1>
	Mode 2: GSM1900 Idle + Bluetooth Idle + WLAN (5G) Idle + USB Cable 1 (Charging from Adapter 1) + Earphone 1 + Battery + Camera (Front) for Sample 1 <Fig.1>
	Mode 3: WCDMA Band V Idle + Bluetooth Idle + WLAN (2.4G) Idle + USB Cable 1 (Charging from Adapter 1) + Earphone 1 + Battery + MPEG4 for Sample 1 <Fig.1>
	Mode 4: LTE Band 7 Idle + Bluetooth Idle + WLAN (5G) Idle + USB Cable 1 (Charging from Adapter 1) + Earphone 1 + Battery + GNSS Rx for Sample 1 <Fig.2>
	Mode 5: GSM850 Idle + Bluetooth Idle + WLAN (2.4G) Idle + USB Cable 1 (Charging from Adapter 1) + Earphone 1 + Battery + Camera (Rear) for Sample 1 <Fig.1>
	Mode 6: LTE Band 7 Idle + Bluetooth Idle + WLAN (2.4G) Idle + USB Cable 1 (Data Link with Notebook) + Earphone + Battery + GNSS Rx + SIM 1 for Sample 1 <Fig.3>
	Mode 7: USB Cable 1 (Charging from Adapter 1) + FM Rx (88MHz) + Earphone 1 + Battery for Sample 1 <Fig.4>
	Mode 8: USB Cable 1 (Charging from Adapter 1) + FM Rx (98MHz) + Earphone 1 + Battery for Sample 1 <Fig.4>
	Mode 9: USB Cable 1 (Charging from Adapter 1) + FM Rx (108MHz) + Earphone 1 + Battery for Sample 1 <Fig.4>
	Mode 10 : USB Cable 1 (Charging from Adapter 2) + FM Rx (88MHz) + Earphone 2 + Battery for Sample 2 <Fig.4>



Radiated Emissions < 1GHz	<p>Mode 1: GSM850 Idle + Bluetooth Idle + WLAN (2.4G) Idle + USB Cable 1 (Charging from Adapter 1) + Earphone 1 + Battery + Camera (Rear) for Sample 1 <Fig.1></p> <p>Mode 2: GSM1900 Idle + Bluetooth Idle + WLAN (5G) Idle + USB Cable 1 (Charging from Adapter 1) + Earphone 1 + Battery + Camera (Front) for Sample 1 <Fig.1></p> <p>Mode 3: WCDMA Band V Idle + Bluetooth Idle + WLAN (2.4G) Idle + USB Cable 1 (Charging from Adapter 1) + Earphone 1 + Battery + MPEG4 for Sample 1 <Fig.1></p> <p>Mode 4: LTE Band 7 Idle + Bluetooth Idle + WLAN (5G) Idle + USB Cable 1 (Charging from Adapter 1) + Earphone 1 + Battery + GNSS Rx for Sample 1 <Fig.2></p> <p>Mode 5: LTE Band 7 Idle + Bluetooth Idle + WLAN (5G) Idle + USB Cable 1 (Charging from Adapter 2) + Earphone 2 + Battery + GNSS Rx for Sample 1 <Fig.2></p> <p>Mode 6: LTE Band 7 Idle + Bluetooth Idle + WLAN (5G) Idle + USB Cable 1 (Charging from Adapter 1) + Earphone 1 + Battery + GNSS Rx for Sample 2 <Fig.2></p> <p>Mode 7: LTE Band 7 Idle + Bluetooth Idle + WLAN (2.4G) Idle + USB Cable 1 (Data Link with Notebook) + Earphone + Battery + GNSS Rx + SIM 1 for Sample 1 <Fig.3></p> <p>Mode 8: LTE Band 7 Idle + Bluetooth Idle + WLAN (2.4G) Idle + USB Cable 1 (Data Link with Notebook) + Earphone + Battery + GNSS Rx + Sample 2 <Fig.3></p> <p>Mode 9: USB Cable 1 (Charging from Adapter 1) + FM Rx (88MHz) + Earphone 1 + Battery for Sample 1 <Fig.4></p> <p>Mode 10 : USB Cable 1 (Charging from Adapter 1) + FM Rx (98MHz) + Earphone 1 + Battery for Sample 1 <Fig.4></p> <p>Mode 11 : USB Cable 1 (Charging from Adapter 1) + FM Rx (108MHz) + Earphone 1 + Battery for Sample 1 <Fig.4></p> <p>Mode 12 : USB Cable 1 (Charging from Adapter 2) + FM Rx (108MHz) + Earphone 2 + Battery for Sample 2 <Fig.4></p>
Radiated Emissions ≥ 1GHz	<p>Mode 1: LTE Band 7 Idle + Bluetooth Idle + WLAN (2.4G) Idle + USB Cable 1 (Data Link with Notebook) + Earphone + Battery + GNSS Rx + SIM 1 for Sample 1 <Fig.3></p> <p>Mode 2: USB Cable 1 (Charging from Adapter 1) + FM Rx (108MHz) + Earphone 1 + Battery for Sample 1 <Fig.4></p>



Remark:

1. The worst case of AC is mode 7; and the USB data link mode is mode 6, the test data of these modes are reported.
2. The worst case of RE < 1G is mode 11; and the USB data link mode is mode 7, the test data of these modes are reported.
3. Data Link with Notebook means data application transferred mode between EUT and Notebook.

2.2. Connection Diagram of Test System

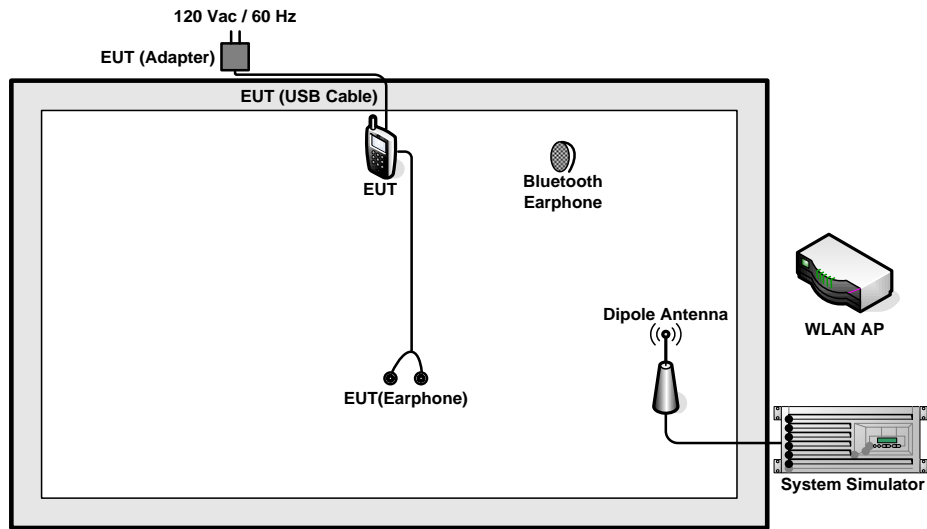

<Fig.1>

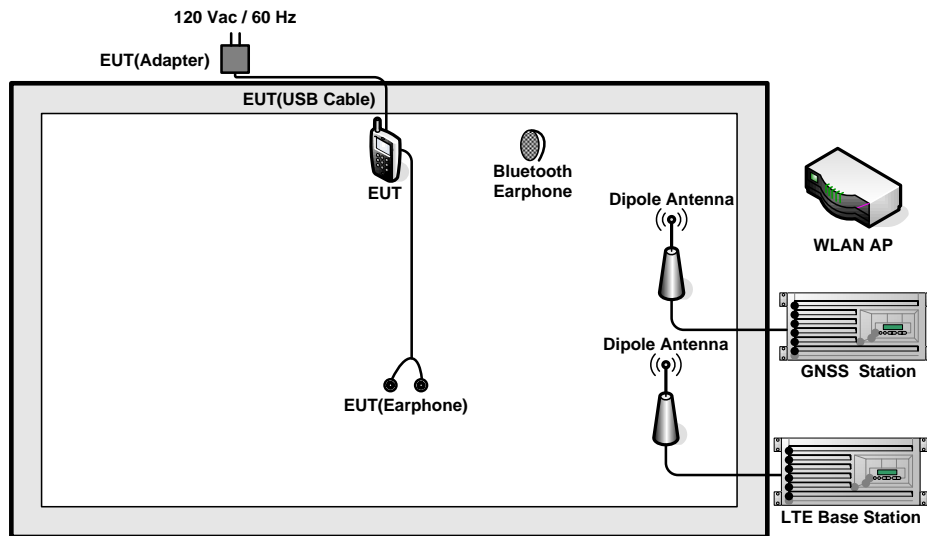

<Fig.2>

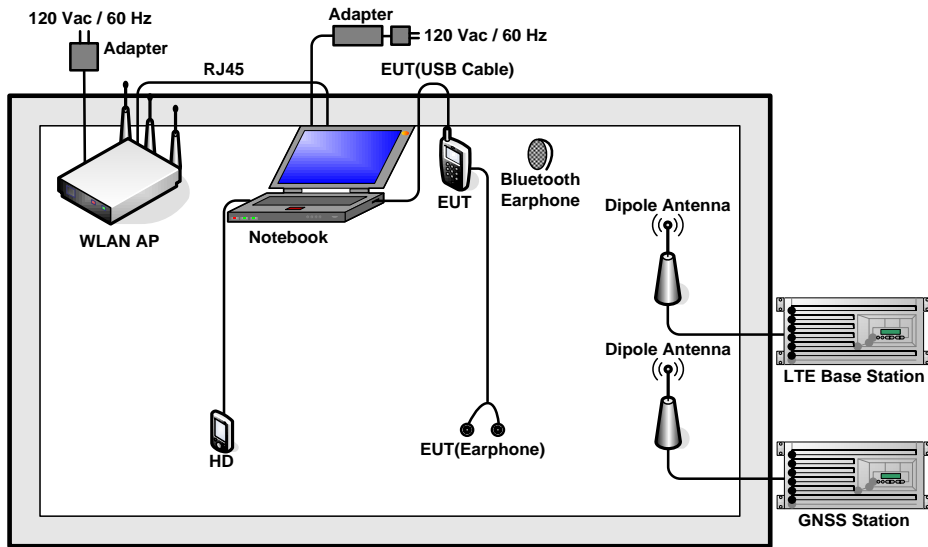

<Fig.3>

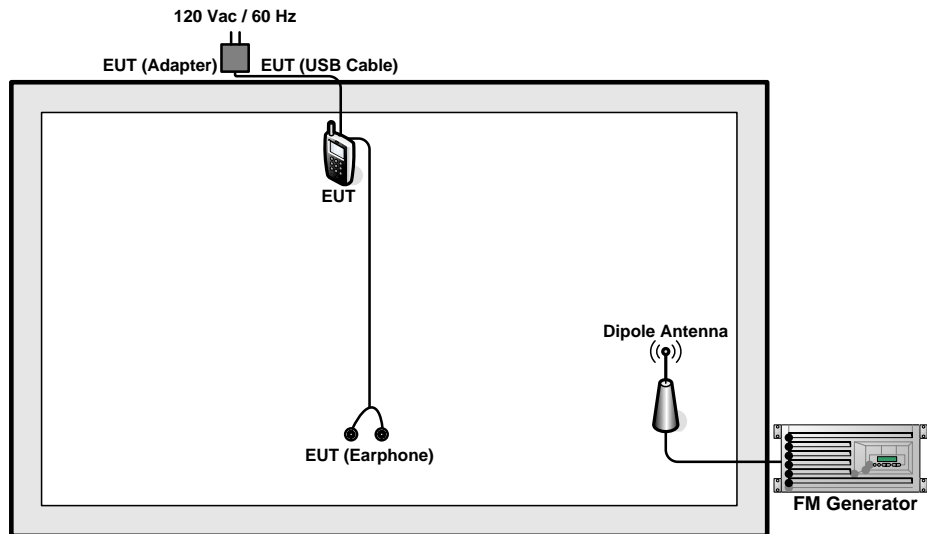

<Fig.4>

2.3. Support Unit used in test configuration and system

Item	Equipment	Trade Name	Model Name	FCC ID	Data Cable	Power Cord
1.	System Simulator	R&S	CMU 200	N/A	N/A	Unshielded, 1.8 m
2.	LTE Base Station	Anritsu	MT8820C	N/A	N/A	Unshielded, 1.8 m
3.	FM Generator	R&S	SMBV100A	N/A	N/A	Unshielded, 1.8 m
4.	GNSS Station	ADIVIC	MP9000	N/A	N/A	Unshielded, 1.8 m
5.	GNSS Station	RACELOGIC	RLLS03-2RP	N/A	N/A	Unshielded, 1.8 m
6.	WLAN AP	D-Link	DIR-855	KA2DIR855A2	N/A	Unshielded, 1.8 m
7.	WLAN AP	TP-Link	TL-WDR5600	N/A	N/A	Unshielded, 1.8 m
8.	Notebook	Lenovo	G480	N/A	N/A	AC I/P: Unshielded, 1.8 m DC O/P: Shielded, 1.8 m
9.	Notebook	Lenovo	Y510P	N/A	N/A	AC I/P: Unshielded, 1.8 m DC O/P: Shielded, 1.8 m
10.	Bluetooth Earphone	Lenovo	LBH308	N/A	N/A	N/A
11.	Hard Disk	Lenovo	F310	FCC DoC	Shielded, 0.5 m	N/A
12.	SD Card	SanDisk	Uitra	N/A	N/A	N/A
13.	SD Card	Kingston	8GB	N/A	N/A	N/A

2.4. EUT Operation Test Setup

The EUT was in GSM or WCDMA or LTE idle mode during the testing. The EUT was synchronized to the BCCH, and is in continuous receiving mode by setting system simulator’s paging reorganization.

At the same time, the EUT was attached to the Bluetooth earphone or WLAN AP, and the following programs installed in the EUT were programmed during the test.

1. Data application is transferred between Notebook and EUT via USB cable.
2. Turn on GNSS function to make the EUT receive continuous signals from GNSS station.
3. Execute “Video Player” to play MPEG4 files.
4. Turn on camera to capture images.
5. The EUT was turned to Radio frequency channels, FM88 MHz, FM98 MHz and FM108 MHz, from FM Generator.

3. Test Result

3.1. Test of AC Conducted Emission Measurement

3.1.1 Limits of AC Conducted Emission

For equipment that is designed to be connected to the public utility (AC) power line, the radio frequency voltage that is conducted back onto the AC power line on any frequency or frequencies within the band 150 kHz to 30 MHz shall not exceed the limits in the following table.

Frequency of emission (MHz)	Conducted limit (dBuV)	
	Quasi-peak	Average
0.15-0.5	66 to 56*	56 to 46*
0.5-5	56	46
5-30	60	50

*Decreases with the logarithm of the frequency.

3.1.2 Measuring Instruments

The measuring equipment is listed in the section 4 of this test report.

3.1.3 Test Procedure

1. The EUT was placed 0.4 meter from the conducting wall of the shielding room was kept at least 80 centimeters from any other grounded conducting surface.
2. Connect EUT to the power mains through a line impedance stabilization network (LISN).
3. All the support units are connecting to the other LISN.
4. The LISN provides 50 ohm coupling impedance for the measuring instrument.
5. The FCC states that a 50 ohm, 50 microhenry LISN should be used.
6. Both sides of AC line were checked for maximum conducted interference.
7. The frequency range from 150 kHz to 30 MHz was searched.
8. Set the test-receiver system to Peak Detect Function and specified bandwidth (IF Bandwidth = 9kHz) with Maximum Hold Mode. Then measurement is also conducted by Average Detector and Quasi-Peak Detector Function respectively.

3.1.4 Test Setup

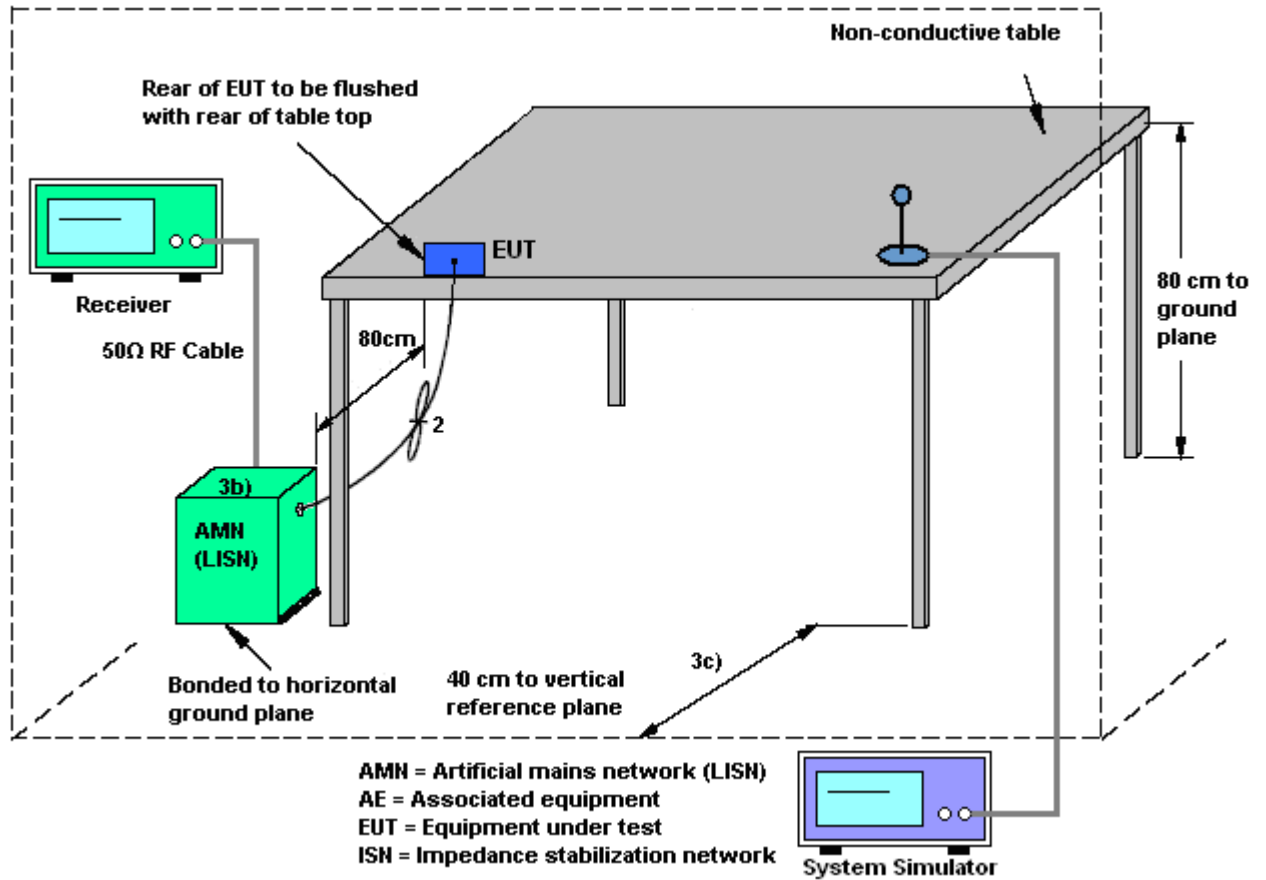



3.1.5 Test Result of AC Conducted Emission

Test Mode :	Mode 6	Temperature :	22~24°C
Test Engineer :	Eko Guan	Relative Humidity :	40~42%
Test Voltage :	120Vac / 60Hz	Phase :	Line
Function Type :	LTE Band 7 Idle + Bluetooth Idle + WLAN (2.4G) Idle + USB Cable 1 (Data Link with Notebook) + Earphone + Battery + GNSS Rx + SIM 1 for Sample 1		

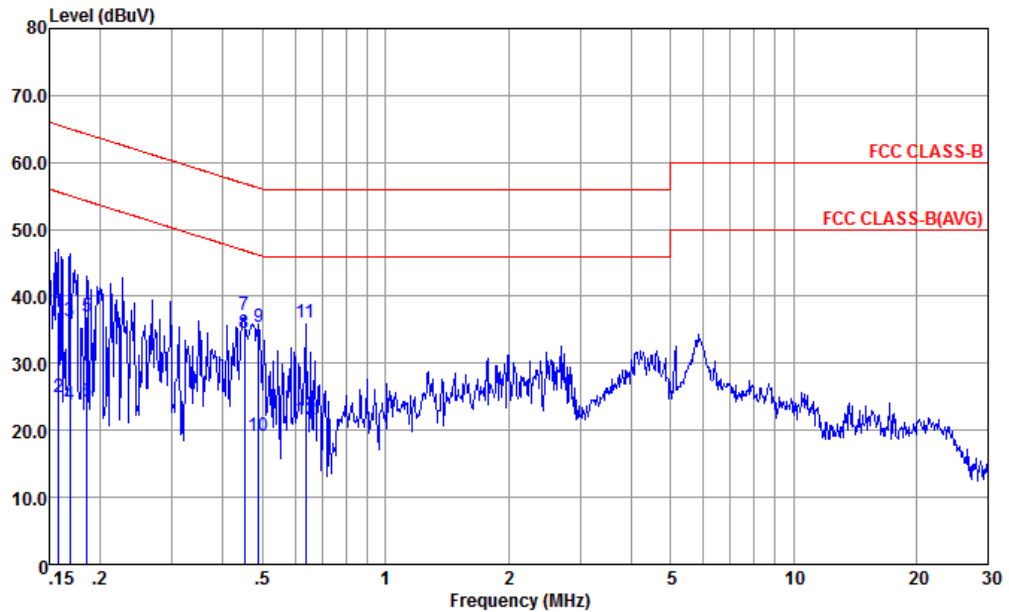

Site : CO01-KS
 Condition : FCC CLASS-B LISN-L-171013-060103 LINE
 Project : (FC) 7D2507-03

: 351847090011676/84 #4

	Freq	Level	Over Limit	Limit Line	Read Level	LISN Factor	Cable Loss	Remark
	MHz	dBuV	dB	dBuV	dBuV	dB	dB	
1	0.158	37.56	-28.00	65.56	26.80	0.17	10.59	QP
2	0.158	24.96	-30.60	55.56	14.20	0.17	10.59	Average
3	0.169	36.23	-28.80	65.03	25.50	0.18	10.55	QP
4	0.169	23.93	-31.10	55.03	13.20	0.18	10.55	Average
5	0.185	36.99	-27.25	64.24	26.30	0.19	10.50	QP
6	0.185	24.19	-30.05	54.24	13.50	0.19	10.50	Average
7	0.452	37.21	-19.64	56.85	26.61	0.25	10.35	QP
8 *	0.452	34.51	-12.34	46.85	23.91	0.25	10.35	Average
9	0.489	35.48	-20.71	56.19	24.90	0.26	10.32	QP
10	0.489	19.08	-27.11	46.19	8.50	0.26	10.32	Average
11	0.637	36.06	-19.94	56.00	25.60	0.26	10.20	QP
12	0.637	21.66	-24.34	46.00	11.20	0.26	10.20	Average



Test Mode :	Mode 6	Temperature :	22~24°C
Test Engineer :	Eko Guan	Relative Humidity :	40~42%
Test Voltage :	120Vac / 60Hz	Phase :	Neutral
Function Type :	LTE Band 7 Idle + Bluetooth Idle + WLAN (2.4G) Idle + USB Cable 1 (Data Link with Notebook) + Earphone + Battery + GNSS Rx + SIM 1 for Sample 1		

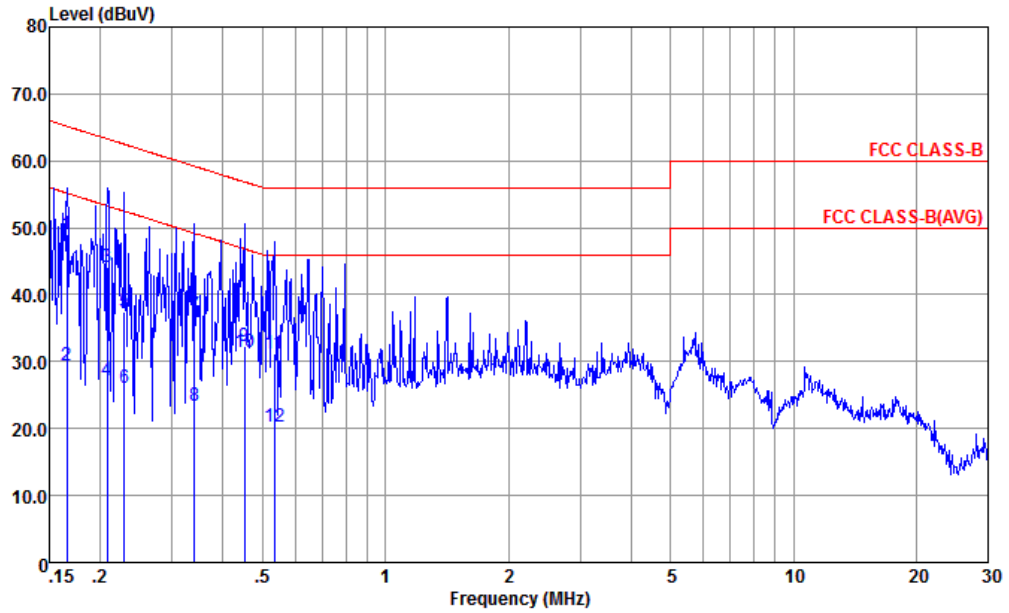

Site : CO01-KS
 Condition : FCC CLASS-B LISN-N-171013-060103 NEUTRAL
 Project : (FC) 7D2507-03

: 351847090011676/84 #4

	Freq	Level	Over Limit	Limit	Read	LISN	Cable	Remark
	MHz	dBuV		dB	Level	Factor	Loss	
				dBuV	dBuV	dB	dB	
1	0.166	49.04	-16.12	65.16	38.20	0.28	10.56	QP
2	0.166	29.34	-25.82	55.16	18.50	0.28	10.56	Average
3	0.208	44.03	-19.24	63.27	33.30	0.28	10.45	QP
4	0.208	27.23	-26.04	53.27	16.50	0.28	10.45	Average
5	0.229	37.53	-24.95	62.48	26.80	0.28	10.45	QP
6	0.229	26.03	-26.45	52.48	15.30	0.28	10.45	Average
7	0.341	36.90	-22.28	59.18	26.19	0.29	10.42	QP
8	0.341	23.50	-25.68	49.18	12.79	0.29	10.42	Average
9	0.452	32.24	-24.61	56.85	21.60	0.29	10.35	QP
10 *	0.452	31.34	-15.51	46.85	20.70	0.29	10.35	Average
11	0.535	31.17	-24.83	56.00	20.60	0.29	10.28	QP
12	0.535	20.17	-25.83	46.00	9.60	0.29	10.28	Average



Test Mode :	Mode 7	Temperature :	22~24°C
Test Engineer :	Eko Guan	Relative Humidity :	40~42%
Test Voltage :	120Vac / 60Hz	Phase :	Line
Function Type :	USB Cable 1 (Charging from Adapter 1) + FM Rx (88MHz) + Earphone 1 + Battery for Sample 1		

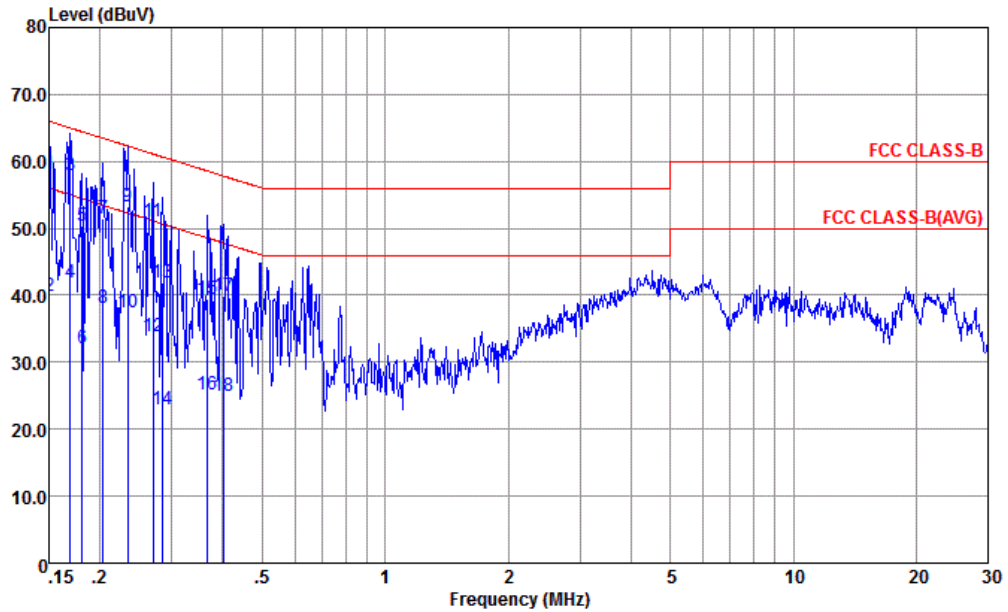

Site : CO01-KS
 Condition : FCC CLASS-B LISN-L-171013-060103 LINE
 Project : (FC) 7D2507-03

: 351847090011676/84 #4

	Freq	Level	Over Limit	Limit Line	Read Level	LISN Factor	Cable Loss	Remark
	MHz	dBuV	dB	dBuV	dBuV	dB	dB	
1	0.150	58.08	-7.92	66.00	47.30	0.16	10.62	QP
2	0.150	39.98	-16.02	56.00	29.20	0.16	10.62	Average
3 *	0.169	57.93	-7.06	64.99	47.20	0.18	10.55	QP
4	0.169	41.93	-13.06	54.99	31.20	0.18	10.55	Average
5	0.181	50.30	-14.16	64.46	39.60	0.19	10.51	QP
6	0.181	32.20	-22.26	54.46	21.50	0.19	10.51	Average
7	0.204	51.56	-11.89	63.45	40.91	0.20	10.45	QP
8	0.204	38.16	-15.29	53.45	27.51	0.20	10.45	Average
9	0.234	53.15	-9.15	62.30	42.50	0.21	10.44	QP
10	0.234	37.45	-14.85	52.30	26.80	0.21	10.44	Average
11	0.270	50.95	-10.17	61.12	40.30	0.22	10.43	QP
12	0.270	33.85	-17.27	51.12	23.20	0.22	10.43	Average
13	0.285	41.95	-18.73	60.68	31.30	0.22	10.43	QP
14	0.285	22.95	-27.73	50.68	12.30	0.22	10.43	Average
15	0.367	39.45	-19.11	58.56	28.80	0.24	10.41	QP
16	0.367	25.25	-23.31	48.56	14.60	0.24	10.41	Average
17	0.402	39.85	-17.96	57.81	29.20	0.25	10.40	QP
18	0.402	24.85	-22.96	47.81	14.20	0.25	10.40	Average



Test Mode :	Mode 7	Temperature :	22~24°C
Test Engineer :	Eko Guan	Relative Humidity :	40~42%
Test Voltage :	120Vac / 60Hz	Phase :	Neutral
Function Type :	USB Cable 1 (Charging from Adapter 1) + FM Rx (88MHz) + Earphone 1 + Battery for Sample 1		

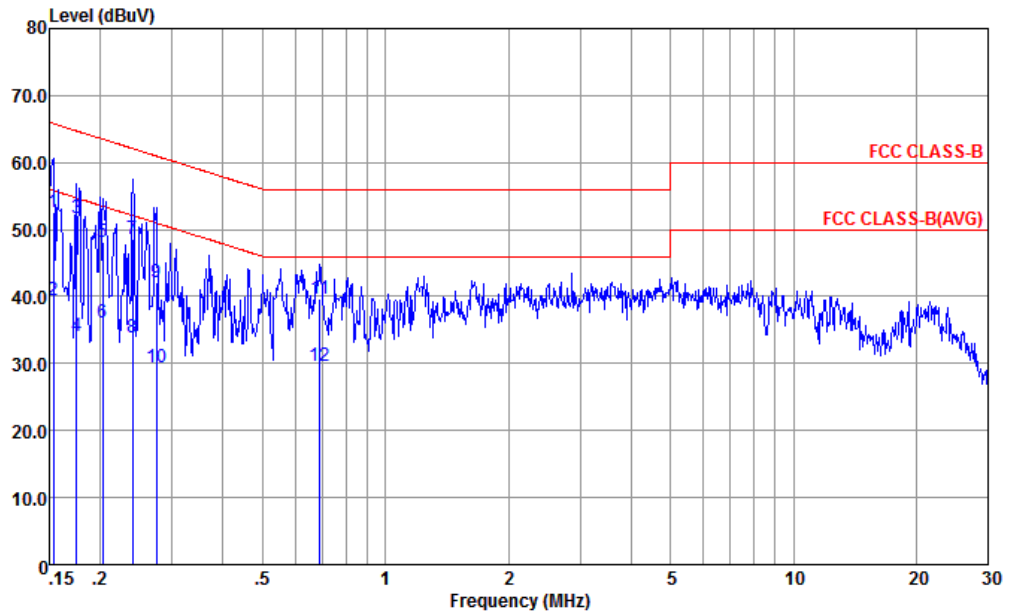

Site : CO01-KS
 Condition : FCC CLASS-B LISN-N-171013-060103 NEUTRAL
 Project : (FC) 7D2507-03

: 351847090011676/84 #4

	Freq	Level	Over Limit	Limit	Read	LISN	Cable	Remark
	MHz	dBuV		dB	dBuV	dB	dB	
1	0.153	52.49	-13.33	65.82	41.60	0.28	10.61	QP
2	0.153	39.39	-16.43	55.82	28.50	0.28	10.61	Average
3 *	0.175	51.61	-13.11	64.72	40.80	0.28	10.53	QP
4	0.175	34.11	-20.61	54.72	23.30	0.28	10.53	Average
5	0.203	48.23	-15.26	63.49	37.50	0.28	10.45	QP
6	0.203	36.03	-17.46	53.49	25.30	0.28	10.45	Average
7	0.240	48.62	-13.46	62.08	37.90	0.28	10.44	QP
8	0.240	33.92	-18.16	52.08	23.20	0.28	10.44	Average
9	0.274	42.22	-18.76	60.98	31.51	0.28	10.43	QP
10	0.274	29.52	-21.46	50.98	18.81	0.28	10.43	Average
11	0.690	39.77	-16.23	56.00	29.30	0.30	10.17	QP
12	0.690	29.67	-16.33	46.00	19.20	0.30	10.17	Average



3.2. Test of Radiated Emission Measurement

3.2.1. Limit of Radiated Emission

The emissions from an unintentional radiator shall not exceed the field strength levels specified in the following table:

Frequency (MHz)	Field Strength (microvolts/meter)	Measurement Distance (meters)
30 – 88	100	3
88 – 216	150	3
216 - 960	200	3
Above 960	500	3

3.2.2. Measuring Instruments

The measuring equipment is listed in the section 4 of this test report.

3.2.3. Test Procedures

1. The EUT was placed on a turntable with 0.8 meter above ground.
2. The EUT was set 3 meters from the interference receiving antenna, which was mounted on the top of a variable height antenna tower.
3. The table was rotated 360 degrees to determine the position of the highest radiation.
4. The antenna is a Bi-Log antenna and its height is adjusted between one to four meters above ground to find the maximum value of the field strength for both horizontal polarization and vertical polarization of the antenna.
5. For each suspected emission, the EUT was arranged to its worst case and then tune the antenna tower (from 1 m to 4 m) and turntable (from 0 degree to 360 degrees) to find the maximum reading.
6. Set the test-receiver system to Peak Detect Function and specified bandwidth with Maximum Hold Mode (RBW=120kHz/VBW=300kHz for frequency below 1GHz; RBW=1MHz VBW=3MHz (Peak), RBW=1MHz/VBW=10Hz (Average) for frequency above 1GHz).
7. If the emission level of the EUT in peak mode was 3 dB lower than the limit specified, peak values of EUT will be reported. Otherwise, the emission will be repeated by using the quasi-peak method and reported.
8. Emission level (dBµV/m) = 20 log Emission level (µV/m)
9. Corrected Reading: Antenna Factor + Cable Loss + Read Level - Preamp Factor = Level

3.2.4. Test Setup of Radiated Emission

For radiated emissions from 30MHz to 1GHz

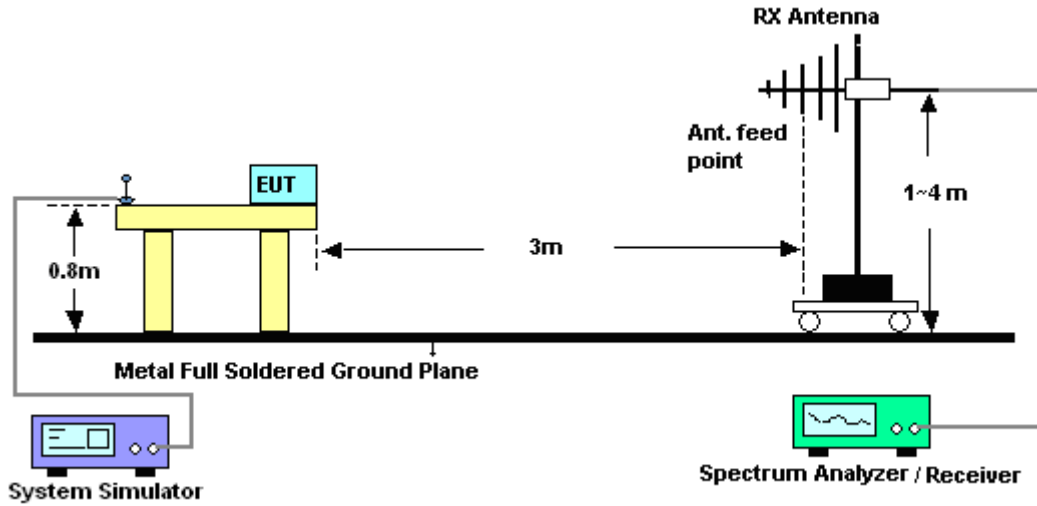

For radiated emissions above 1GHz

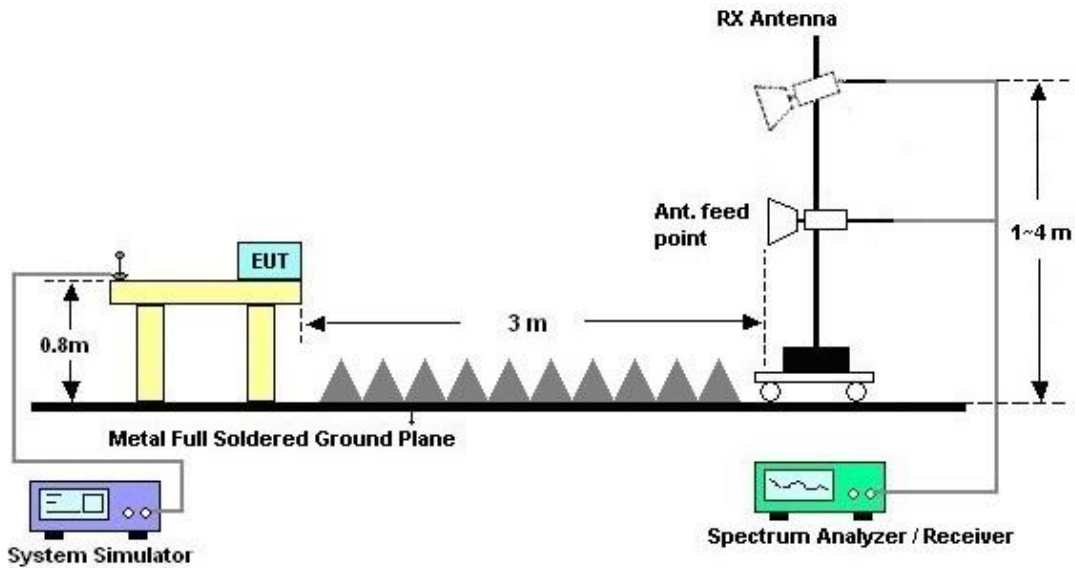



3.2.5. Test Result of Radiated Emission

Test Mode :	Mode 7	Temperature :	21~22°C
Test Engineer :	Carl Ni	Relative Humidity :	41~42%
Test Distance :	3m	Polarization :	Horizontal
Function Type :	LTE Band 7 Idle + Bluetooth Idle + WLAN (2.4G) Idle + USB Cable 1 (Data Link with Notebook) + Earphone + Battery + GNSS Rx + SIM 1 for Sample 1		

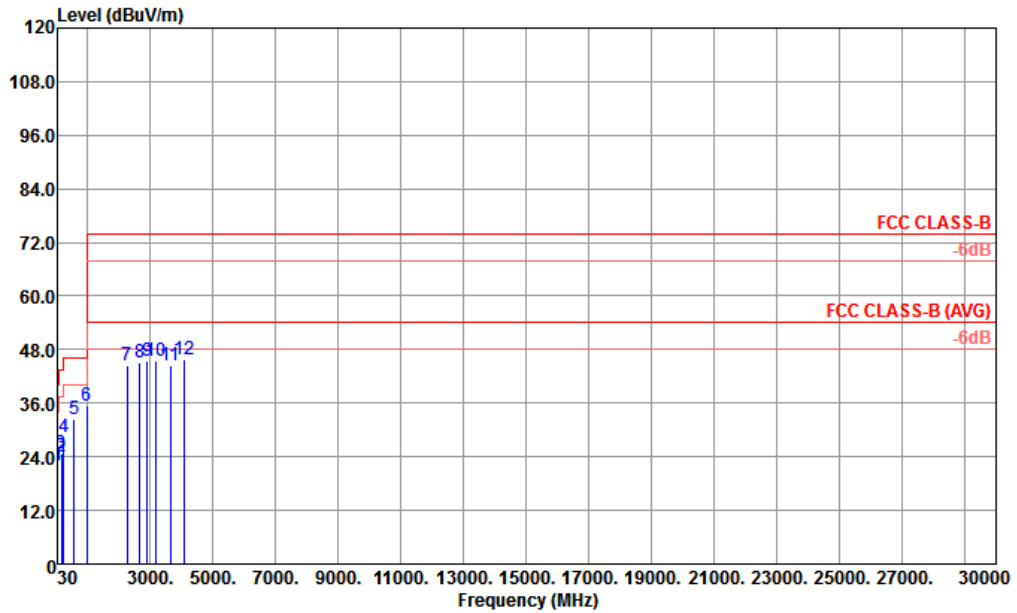

Site : 03CH02-KS
 Condition : FCC CLASS-B 3m 02 LF ANT HORIZONTAL
 Project : (FC)7D2507-03

IMEI : 351847090011676 351847090011684 #4

	Freq	Level	Over Limit	Limit Line	ReadAntenna Level	Antenna Factor	Cable Loss	Preamp Factor	A/Pos	T/Pos	Remark
	MHz	dBuV/m	dB	dBuV/m	dBuV	dB/m	dB	dB	cm	deg	
1	30.81	22.19	-17.81	40.00	28.03	25.60	0.59	32.03	---	---	Peak
2	153.12	24.18	-19.32	43.50	37.31	17.43	1.27	31.83	---	---	Peak
3	165.54	24.66	-18.84	43.50	38.17	16.96	1.32	31.79	---	---	Peak
4	229.80	28.57	-17.43	46.00	42.11	16.43	1.63	31.60	---	---	Peak
5	575.80	32.36	-13.64	46.00	35.03	24.55	2.59	29.81	---	---	Peak
6	959.90	35.29	-10.71	46.00	30.46	28.70	3.21	27.08	100	0	Peak
7	2248.00	44.39	-29.61	74.00	40.17	31.05	4.99	31.82	---	---	Peak
8	2658.00	44.98	-29.02	74.00	38.16	31.76	5.48	30.42	---	---	Peak
9	2906.00	45.46	-28.54	74.00	37.23	32.30	5.90	29.97	---	---	Peak
10	3162.00	45.52	-28.48	74.00	35.94	33.01	6.15	29.58	---	---	Peak
11	3639.00	44.60	-29.40	74.00	33.85	33.92	6.49	29.66	---	---	Peak
12	4059.00	45.65	-28.35	74.00	33.70	35.20	6.86	30.11	---	---	Peak



Test Mode :	Mode 7	Temperature :	21~22°C
Test Engineer :	Carl Ni	Relative Humidity :	41~42%
Test Distance :	3m	Polarization :	Vertical
Function Type :	LTE Band 7 Idle + Bluetooth Idle + WLAN (2.4G) Idle + USB Cable 1 (Data Link with Notebook) + Earphone + Battery + GNSS Rx + SIM 1 for Sample 1		

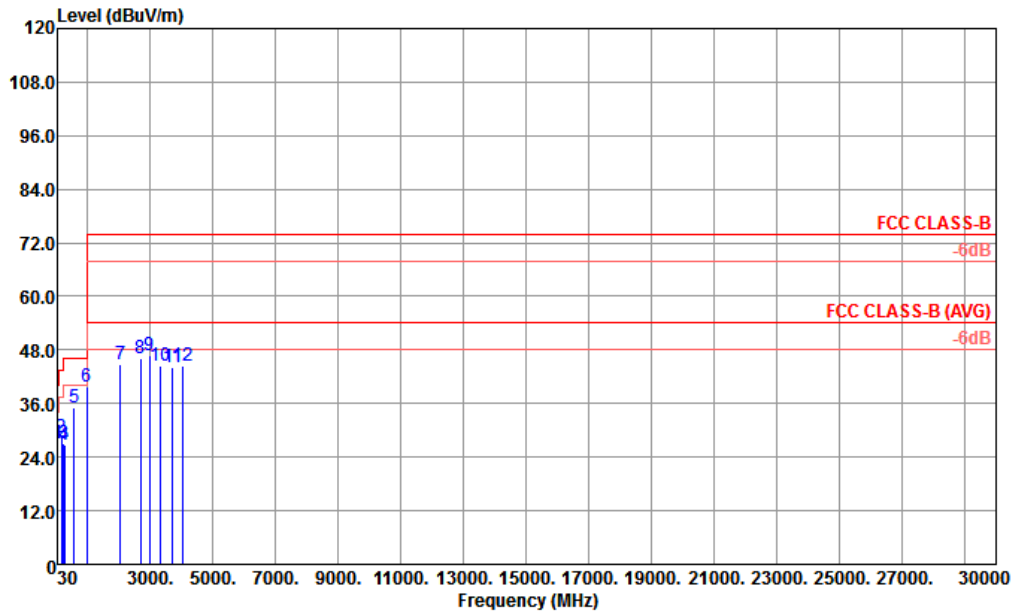

Site : 03CH02-KS
 Condition : FCC CLASS-B 3m 02 LF ANT VERTICAL
 Project : (FC)7D2507-03
 IMEI : 351847090011676 351847090011684 #4

	Freq	Level	Over Limit	Limit Line	ReadAntenna Level	Antenna Factor	Cable Loss	Preamp Factor	A/Pos	T/Pos	Remark
	MHz	dBuV/m	dB	dBuV/m	dBuV	dB/m	dB	dB	cm	deg	
1	42.15	27.01	-12.99	40.00	37.11	21.33	0.65	32.08	---	---	Peak
2	153.12	28.44	-15.06	43.50	41.57	17.43	1.27	31.83	---	---	Peak
3	229.80	26.92	-19.08	46.00	40.46	16.43	1.63	31.60	---	---	Peak
4	254.91	26.58	-19.42	46.00	39.33	17.00	1.76	31.51	---	---	Peak
5	575.80	35.16	-10.84	46.00	37.83	24.55	2.59	29.81	---	---	Peak
6	959.90	39.82	-6.18	46.00	34.99	28.70	3.21	27.08	100	0	Peak
7	2034.00	44.74	-29.26	74.00	42.68	30.42	4.67	33.03	---	---	Peak
8	2680.00	46.08	-27.92	74.00	39.09	31.79	5.54	30.34	---	---	Peak
9	2962.00	46.88	-27.12	74.00	38.46	32.45	5.94	29.97	---	---	Peak
10	3294.00	44.55	-29.45	74.00	34.94	33.23	6.25	29.87	---	---	Peak
11	3714.00	44.14	-29.86	74.00	33.04	34.48	6.55	29.93	---	---	Peak
12	4038.00	44.46	-29.54	74.00	32.53	35.18	6.86	30.11	---	---	Peak



Test Mode :	Mode 11	Temperature :	21~22°C
Test Engineer :	Carl Ni	Relative Humidity :	41~42%
Test Distance :	3m	Polarization :	Horizontal
Function Type :	USB Cable 1 (Charging from Adapter 1) + FM Rx (108MHz) + Earphone 1 + Battery for Sample 1		
Remark	#3 is RF signal from FM station and can be ignored.		

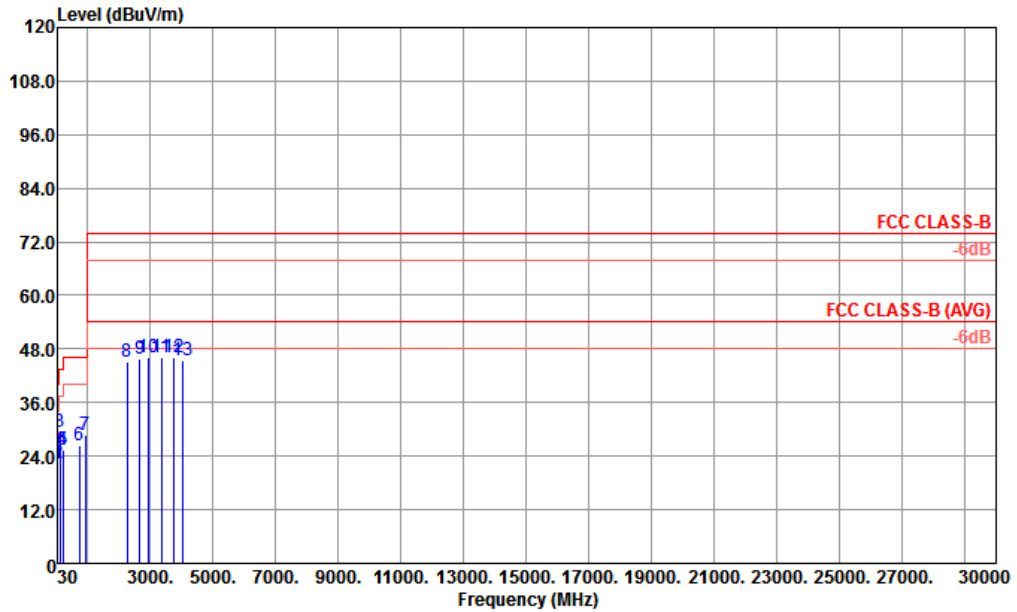

Site : 03CH02-KS
 Condition : FCC CLASS-B 3m 02 LF ANT HORIZONTAL
 Project : (FC)7D2507-03

IMEI : 351847090011676 351847090011684 #4

	Freq	Level	Over Limit	Limit Line	ReadAntenna Level	Cable Factor	Preamp Loss	A/Pos	T/Pos	Remark	
	MHz	dBuV/m	dB	dBuV/m	dBuV	dB/m	dB	dB	cm	deg	
1	31.35	22.49	-17.51	40.00	28.69	25.23	0.60	32.03	---	---	Peak
2	44.85	22.28	-17.72	40.00	33.93	19.80	0.66	32.11	---	---	Peak
3	108.03	29.49			42.52	17.84	1.05	31.92	---	---	Peak
4	201.99	25.49	-18.01	43.50	39.86	15.84	1.46	31.67	---	---	Peak
5	215.49	25.35	-18.15	43.50	39.30	16.14	1.54	31.63	---	---	Peak
6	736.10	26.34	-19.66	46.00	25.64	26.62	2.80	28.72	---	---	Peak
7	925.80	28.64	-17.36	46.00	24.78	28.02	3.15	27.31	100	0	Peak
8	2260.00	45.02	-28.98	74.00	40.77	31.08	4.99	31.82	---	---	Peak
9	2674.00	45.91	-28.09	74.00	38.95	31.76	5.54	30.34	---	---	Peak
10	2940.00	46.18	-27.82	74.00	37.83	32.40	5.92	29.97	---	---	Peak
11	3360.00	46.03	-27.97	74.00	36.44	33.33	6.26	30.00	---	---	Peak
12	3732.00	46.28	-27.72	74.00	35.14	34.59	6.57	30.02	---	---	Peak
13	4032.00	45.46	-28.54	74.00	33.63	35.15	6.79	30.11	---	---	Peak



Test Mode :	Mode 11	Temperature :	21~22°C
Test Engineer :	Carl Ni	Relative Humidity :	41~42%
Test Distance :	3m	Polarization :	Vertical
Function Type :	USB Cable 1 (Charging from Adapter 1) + FM Rx (108MHz) + Earphone 1 + Battery for Sample 1		
Remark	#3 is RF signal from FM station and can be ignored.		

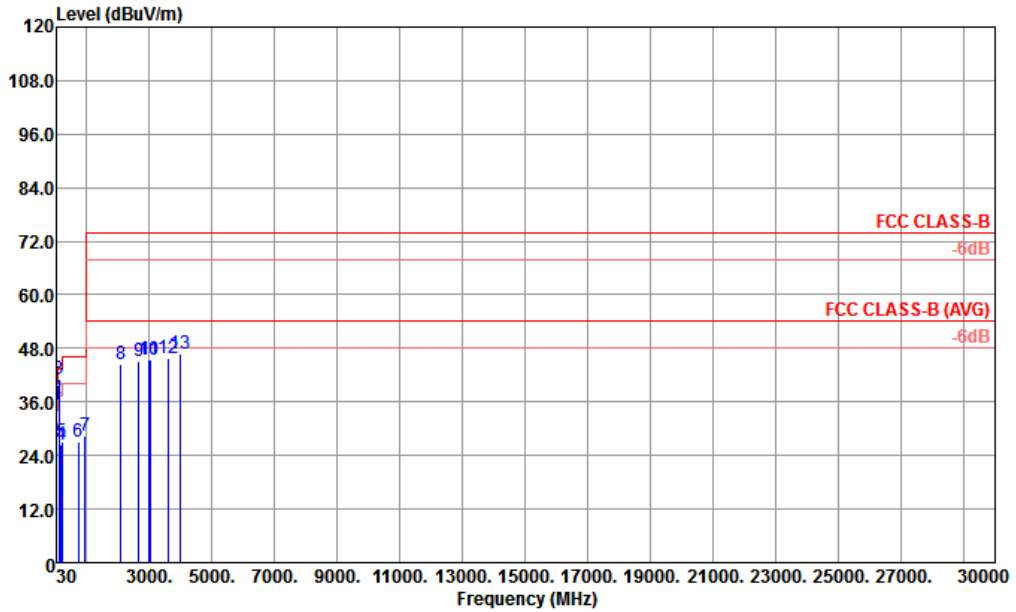

Site : 03CH02-KS
 Condition : FCC CLASS-B 3m 02 LF ANT VERTICAL
 Project : (FC)7D2507-03
 IMEI : 351847090011676 351847090011684 #4
 Battery : 10%

	Freq	Level	Over	Limit	ReadAntenna	Cable	Preamp	A/Pos	T/Pos	Remark	
	MHz	dBUV/m	dB	dBUV/m	dBuV	dB/m	dB	dB	cm	deg	
1 !	32.97	35.36	-4.64	40.00	41.92	24.87	0.61	32.04	---	---	Peak
2 !	43.77	36.93	-3.07	40.00	47.80	20.57	0.66	32.10	100	240	QP
3 !	108.03	41.20			54.23	17.84	1.05	31.92	---	---	Peak
4	195.24	26.29	-17.21	43.50	40.61	15.94	1.43	31.69	---	---	Peak
5	200.64	27.12	-16.38	43.50	41.50	15.84	1.45	31.67	---	---	Peak
6	743.10	26.92	-19.08	46.00	26.14	26.66	2.81	28.69	---	---	Peak
7	944.70	28.46	-17.54	46.00	24.07	28.38	3.19	27.18	---	---	Peak
8	2098.00	44.43	-29.57	74.00	41.66	30.65	4.79	32.67	---	---	Peak
9	2656.00	45.17	-28.83	74.00	38.37	31.74	5.48	30.42	---	---	Peak
10	2992.00	45.47	-28.53	74.00	36.94	32.55	5.95	29.97	---	---	Peak
11	3027.00	45.39	-28.61	74.00	36.67	32.65	5.98	29.91	---	---	Peak
12	3624.00	45.86	-28.14	74.00	35.24	33.81	6.47	29.66	---	---	Peak
13	3975.00	46.72	-27.28	74.00	35.07	35.06	6.70	30.11	---	---	Peak



4. List of Measuring Equipment

Instrument	Manufacturer	Model No.	Serial No.	Characteristics	Calibration Date	Test Date	Due Date	Remark
EMI Receiver	R&S	ESCI7	100768	9kHz~7GHz;	Apr. 20, 2017	Jan. 14, 2018~ Jan. 21, 2018	Apr. 19, 2018	Conduction (CO01-KS)
AC LISN	MessTec	AN3016	060103	9kHz~30MHz	Oct. 13, 2017	Jan. 14, 2018~ Jan. 21, 2018	Oct. 12, 2018	Conduction (CO01-KS)
AC LISN (for auxiliary equipment)	MessTec	AN3016	060105	9kHz~30MHz	Oct. 13, 2017	Jan. 14, 2018~ Jan. 21, 2018	Oct. 12, 2018	Conduction (CO01-KS)
AC Power Source	Chroma	61602	ABP0000008 11	AC 0V~300V, 45Hz~1000Hz	Oct. 12, 2017	Jan. 14, 2018~ Jan. 21, 2018	Oct. 11, 2018	Conduction (CO01-KS)
EMI Test Receiver	R&S	ESR7	101403	9kHz~7GHz; Max 30dBm	Aug. 08, 2017	Jan. 13, 2018~ Jan. 21, 2018	Aug. 07, 2018	Radiation (03CH02-KS)
EXA Spectrum Analyzer	Keysight	N9010A	MY55150208	10Hz~44GHz, MAX 30dB	Apr. 18, 2017	Jan. 13, 2018~ Jan. 21, 2018	Apr. 17, 2018	Radiation (03CH02-KS)
Bilog Antenna	TeseQ	CBL6112D	23182	30MHz~2GHz	Jan. 22, 2017	Jan. 13, 2018~ Jan. 21, 2018	Jan. 21, 2018	Radiation (03CH02-KS)
Double Ridge Horn Antenna	ETS-Lindgren	3117	75957	1GHz~18GHz	Oct. 21, 2017	Jan. 13, 2018~ Jan. 21, 2018	Oct. 20, 2018	Radiation (03CH02-KS)
SHF-EHF Horn	Schwarzbeck	BBHA 9170	BBHA170249	15GHz~40GHz	Feb. 15, 2017	Jan. 13, 2018~ Jan. 21, 2018	Feb. 14, 2018	Radiation (03CH02-KS)
Amplifier	MITEQ	TTA1840-35-H G	1887435	18GHz~40GHz	Oct. 12, 2017	Jan. 13, 2018~ Jan. 21, 2018	Oct. 11, 2018	Radiation (03CH02-KS)
Amplifier	SONOMA	310N	187289	9kHz~1GHz	Aug. 07, 2017	Jan. 13, 2018~ Jan. 21, 2018	Aug. 06, 2018	Radiation (03CH02-KS)
Amplifier	Agilent	8449B	3008A02384	1-26.5GHz Gain 30dB	Oct. 12, 2017	Jan. 13, 2018~ Jan. 21, 2018	Oct. 11, 2018	Radiation (03CH02-KS)
AC Power Source	Chroma	61601	61601000247 3	N/A	NCR	Jan. 13, 2018~ Jan. 21, 2018	NCR	Radiation (03CH02-KS)
Turn Table	MF	MF7802	N/A	0~360 degree	NCR	Jan. 13, 2018~ Jan. 21, 2018	NCR	Radiation (03CH02-KS)
Antenna Mast	MF	MF7802	N/A	1 m~4 m	NCR	Jan. 13, 2018~ Jan. 21, 2018	NCR	Radiation (03CH02-KS)

NCR: No Calibration Required



5. Uncertainty of Evaluation

Uncertainty of Conducted Emission Measurement (150 kHz ~ 30 MHz)

Measuring Uncertainty for a Level of Confidence of 95% ($U = 2Uc(y)$)	2.3dB
---	-------

Uncertainty of Radiated Emission Measurement (30 MHz ~ 1000 MHz)

Measuring Uncertainty for a Level of Confidence of 95% ($U = 2Uc(y)$)	4.5dB
---	-------

Uncertainty of Radiated Emission Measurement (1GHz ~ 18GHz)

Measuring Uncertainty for a Level of Confidence of 95% ($U = 2Uc(y)$)	4.2dB
---	-------

Uncertainty of Radiated Emission Measurement (18GHz ~ 40GHz)

Measuring Uncertainty for a Level of Confidence of 95% ($U = 2Uc(y)$)	4.7dB
---	-------