



FCC RF Test Report

APPLICANT : Motorola Mobility LLC
EQUIPMENT : Mobile Cellular Phone
BRAND NAME : Motorola
MODEL NAME : XT1925-7
FCC ID : IHDT56XD7
STANDARD : FCC Part 15 Subpart C §15.225
CLASSIFICATION : (DXX) Low Power Communication Device Transmitter

The product was received on Dec. 25, 2017 and testing was completed on Feb. 13, 2018. We, Sporton International (Kunshan) Inc., would like to declare that the tested sample has been evaluated in accordance with the test procedures and has been in compliance with the applicable technical standards.

The test results in this report apply exclusively to the tested model / sample. Without written approval of Sporton International (Kunshan) Inc., the test report shall not be reproduced except in full.



Approved by: James Huang / Manager

Sporton International (Kunshan) Inc.
No.3-2 Ping-Xiang Rd, Kunshan Development Zone Kunshan City Jiangsu Province 215335
China



TABLE OF CONTENTS

TABLE OF CONTENTS2

REVISION HISTORY.....3

SUMMARY OF THE TEST RESULT4

1. GENERAL INFORMATION.....5

 1.1 Applicant..... 5

 1.2 Manufacturer 5

 1.3 Product Feature of Equipment Under Test 5

 1.4 Product Specification of Equipment Under Test 6

 1.5 Specification of Accessory..... 7

 1.6 Modification of EUT 8

 1.7 Testing Location 8

 1.8 Applicable Standards..... 8

2. TEST CONFIGURATION OF EQUIPMENT UNDER TEST9

 2.1 Descriptions of Test Mode..... 9

 2.2 Connection Diagram of Test System 9

 2.3 Table for Supporting Units 10

 2.4 EUT Operation Test Setup 10

3. TEST RESULTS.....11

 3.1 AC Power Line Conducted Emissions Measurement 11

 3.2 20dB and 99% OBW Spectrum Bandwidth Measurement..... 13

 3.3 Frequency Stability Measurement 14

 3.4 Field Strength of Fundamental Emissions and Mask Measurement..... 15

 3.5 Radiated Emissions Measurement 17

 3.6 Antenna Requirements..... 20

4. LIST OF MEASURING EQUIPMENT21

APPENDIX A. TEST RESULTS OF CONDUCTED EMISSION TEST

APPENDIX B. TEST RESULTS OF CONDUCTED TEST ITEMS

 B1. Test Result of 20dB Spectrum Bandwidth

 B2. Test Result of Frequency Stability

APPENDIX C. TEST RESULTS OF RADIATED TEST ITEMS

 C1. Test Result of Field Strength of Fundamental Emissions

 C2. Results of Radiated Emissions (9 kHz~30MHz)

 C3. Results of Radiated Emissions (30MHz~1GHz)

APPENDIX D. SETUP PHOTOGRAPHS



SUMMARY OF THE TEST RESULT

Applied Standard: 47 CFR FCC Part 15 Subpart C				
Part	FCC Rule	Description of Test	Result	Remark
3.1	15.207	AC Power Line Conducted Emissions	Complies	Under limit 7.77 dB at 13.560MHz
3.2	15.215(c)	20dB Spectrum Bandwidth	Complies	-
	-	99% OBW Spectrum Bandwidth	Complies	-
3.3	15.225(e)	Frequency Stability	Complies	-
3.4	15.225(a)(b)(c)	Field Strength of Fundamental Emissions	Complies	Max Level 56.95 dBuV/m at 13.560 MHz
3.5	15.225(d) 15.209	Radiated Emissions	Complies	Under limit 13.80 dB at 0.981 MHz for Quasi-Peak
3.6	15.203	Antenna Requirements	Complies	-

Test Items	Uncertainty	Remark
AC Power Line Conducted Emissions	±2.3dB	Confidence levels of 95%
Radiated Emissions (30MHz~1000MHz)	±4.5dB	Confidence levels of 95%



1. GENERAL INFORMATION

1.1 Applicant

Motorola Mobility LLC
222 W, Merchandise Mart Plaza, Chicago IL 60654 USA

1.2 Manufacturer

Motorola Mobility LLC
222 W, Merchandise Mart Plaza, Chicago IL 60654 USA

1.3 Product Feature of Equipment Under Test

Product Feature	
Equipment	Mobile Cellular Phone
Brand Name	Motorola
Model Name	XT1925-7
FCC ID	IHDT56XD7
EUT supports Radios application	GSM/GPRS/EGPRS/WCDMA/HSPA/DC-HSDPA/ HSPA+(Uplink is not supported)/LTE/NFC WLAN 2.4GHz 802.11b/g/n HT20/ WLAN 5GHz 802.11a/n HT20/HT40/ Bluetooth v3.0 + EDR/Bluetooth v4.0 LE/ Bluetooth v4.1 LE/Bluetooth v4.2 LE
IMEI Code	Conducted: 351848090015550/351848090015568 Conduction: 351848090015253/351848090015261 Radiation: 351848090014033/351848090014041
HW Version	DVT1-B
SW Version	ali_n-userdebug 8.0.0 OPS27.55 1276 intcfg,test-keys
EUT Stage	Identical Prototype

Remark: The above EUT's information was declared by manufacturer. Please refer to the specifications or user's manual for more detailed description.



1.4 Product Specification of Equipment Under Test

Standards-related Product Specification	
Tx/Rx Frequency Range	13.553 ~ 13.567MHz
Channel Number	1
20dBW	2.49 KHz
99%OBW	2.11 KHz
Antenna Type	Loop Antenna
Type of Modulation	ASK

Remark: The above EUT's information was declared by manufacturer. Please refer to the specifications or user's manual for more detailed description.



1.5 Specification of Accessory

Specification of Accessory			
AC Adapter 1(US)	Brand Name	Motorola (Salom)	Model Name SC-22
	Power Rating	I/P: 100-240 Vac, 500mA, O/P: 5Vdc,3000mA or 9Vdc,1600mA or 12Vdc,1200mA	
AC Adapter 1(EU)	Brand Name	Motorola (Salom)	Model Name SC-23
	Power Rating	I/P: 100-240 Vac, 500mA, O/P: 5Vdc,3000mA or 9Vdc,1600mA or 12Vdc,1200mA	
AC Adapter 1(UK)	Brand Name	Motorola (Salom)	Model Name SC-24
	Power Rating	I/P: 100-240 Vac, 500mA, O/P: 5Vdc,3000mA or 9Vdc,1600mA or 12Vdc,1200mA	
AC Adapter 1(IN)	Brand Name	Motorola (Salom)	Model Name SC-25
	Power Rating	I/P: 100-240 Vac, 500mA, O/P: 5Vdc,3000mA or 9Vdc,1600mA or 12Vdc,1200mA	
AC Adapter 1(AU)	Brand Name	Motorola (Salom)	Model Name SC-26
	Power Rating	I/P: 100-240 Vac, 500mA, O/P: 5Vdc,3000mA or 9Vdc,1600mA or 12Vdc,1200mA	
AC Adapter 1 (Indonesia)	Brand Name	Motorola (Salom)	Model Name SC-23
	Power Rating	I/P: 100-240 Vac, 500mA, O/P: 5Vdc,3000mA or 9Vdc,1600mA or 12Vdc,1200mA	
AC Adapter 2(US)	Brand Name	Motorola (Chenyang)	Model Name SC-22
	Power Rating	I/P: 100-240 Vac, 500mA, O/P: 5Vdc,3000mA or 9Vdc,1600mA or 12Vdc,1200mA	
AC Adapter 2(EU)	Brand Name	Motorola (Chenyang)	Model Name SC-23
	Power Rating	I/P: 100-240 Vac, 500mA, O/P: 5Vdc,3000mA or 9Vdc,1600mA or 12Vdc,1200mA	
AC Adapter 2(UK)	Brand Name	Motorola (Chenyang)	Model Name SC-24
	Power Rating	I/P: 100-240 Vac, 500mA, O/P: 5Vdc,3000mA or 9Vdc,1600mA or 12Vdc,1200mA	
AC Adapter 2(IN)	Brand Name	Motorola (Chenyang)	Model Name SC-25
	Power Rating	I/P: 100-240 Vac, 500mA, O/P: 5Vdc,3000mA or 9Vdc,1600mA or 12Vdc,1200mA	
AC Adapter 2(AU)	Brand Name	Motorola (Chenyang)	Model Name SC-26
	Power Rating	I/P: 100-240 Vac, 500mA, O/P: 5Vdc,3000mA or 9Vdc,1600mA or 12Vdc,1200mA	
Battery	Brand Name	Motorola (ATL)	Model Name HG30
	Power Rating	3.8Vdc,3000mAh	Type Li-ion
Earphone 1	Brand Name	Motorola (Jiahe)	Model Name LS-118M-12
	Signal Line Type	1.2 meter, non-shielded cable, without ferrite core	
Earphone 2	Brand Name	Motorola (Lianyun)	Model Name TS910A-38AMS01WHR-M
	Signal Line Type	1.2 meter, non-shielded cable, without ferrite core	
USB Cable	Brand Name	Motorola (Liqi)	Model Name L32B-053000100-ALL
	Signal Line Type	1.0 meter, shielded cable, without ferrite core	



1.6 Modification of EUT

No modifications are made to the EUT during all test items.

1.7 Testing Location

Sporton International (Kunshan) Inc. is accredited to ISO 17025 by National Voluntary Laboratory Accreditation Program (NVLAP code: 600155-0) and the FCC designation No. is CN5013.

Test Site	Sporton International (Kunshan) Inc.			
Test Site Location	No.3-2 Ping-Xiang Rd, Kunshan Development Zone Kunshan City Jiangsu Province 215335 China TEL : +86-512-57900158 FAX : +86-512-57900958			
Test Site No.	Sporton Site No.			FCC Registration No. 630927
	TH01-KS	03CH02-KS	CO01-KS	
Test Engineer	Silent Hai	Leo Li	Eko Guan	
Temperature	21~25°C	21~22°C	22~24°C	
Relative Humidity	51~55%	41~42%	42~44%	

1.8 Applicable Standards

According to the specifications of the manufacturer, the EUT must comply with the requirements of the following standards:

- FCC Part 15 Subpart C §15.225
- ANSI C63.10-2013

2. TEST CONFIGURATION OF EQUIPMENT UNDER TEST

2.1 Descriptions of Test Mode

Investigation has been done on all the possible configurations for searching the worst cases.

The following table is a list of the test modes shown in this test report.

Test Items	
AC Power Line Conducted Emissions	Field Strength of Fundamental Emissions
20dB Spectrum Bandwidth	Frequency Stability
Radiated Emissions 9kHz~30MHz	Radiated Emissions 30MHz~1GHz

The EUT pre-scanned in four NFC type, A, B, F, V. The worst type (type F) was recorded in this report. Pre-scanned tests, X, Y, Z in three orthogonal panels to determine the final configuration (Z plane as worst plane) from all possible combinations.

2.2 Connection Diagram of Test System

<AC Conducted Emissions>

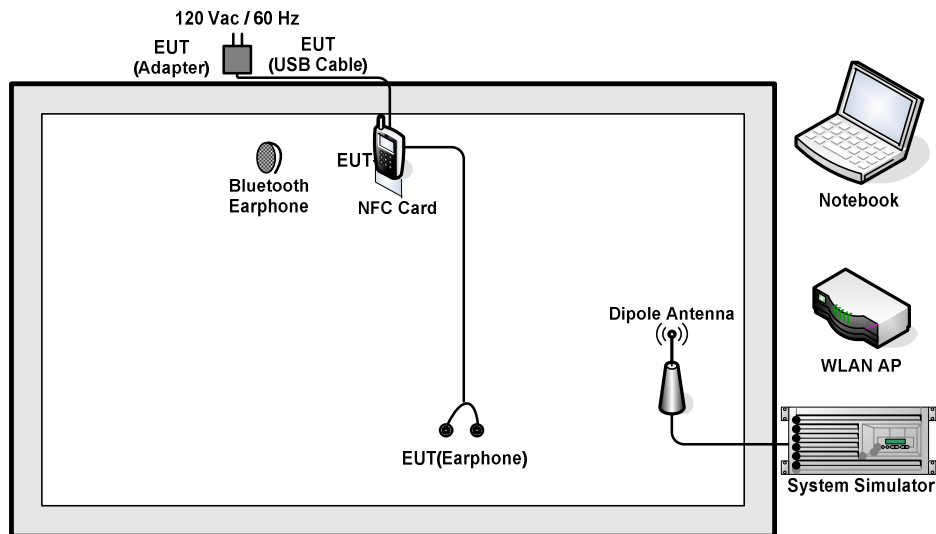

< For Fundamental Emissions and Mask and Radiated Emissions Measurement >

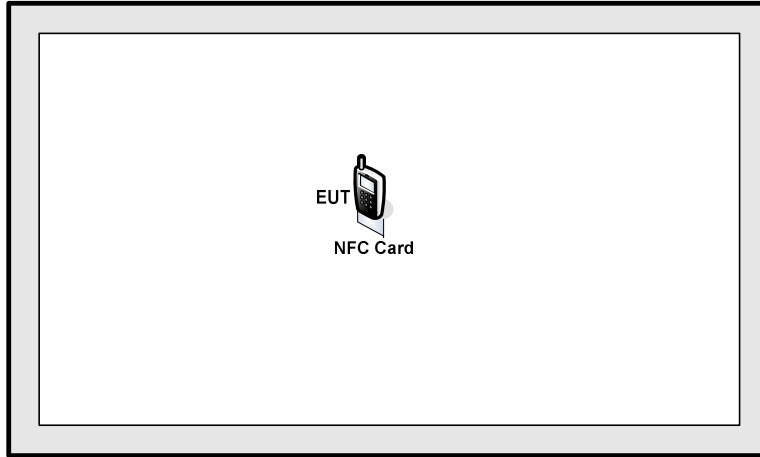

2.3 Table for Supporting Units

Support Unit	Manufacturer	Model	FCC ID
System Simulator	R&S	CMU 200	N/A
Router	D-Link	DIR-855	KA2DIR855A2
Bluetooth Earphone	Lenovo	LBH308	N/A
Notebook	Lenovo	G480	N/A
NFC Card	N/A	N/A	N/A
SD Card	Kingston	8GB	N/A

2.4 EUT Operation Test Setup

The EUT was programmed to be in continuously transmitting mode.

The ancillary equipment, NFC card, is used to make the EUT (NFC) continuously transmit at 13.56MHz and is placed around 3 cm gap to the EUT.



3. TEST RESULTS

3.1 AC Power Line Conducted Emissions Measurement

3.1.1 Limit of AC Conducted Emission

For equipment that is designed to be connected to the public utility (AC) power line, the radio frequency voltage that is conducted back onto the AC power line on any frequency or frequencies within the band 150 kHz to 30 MHz shall not exceed the limits in the following table.

Frequency of Emission (MHz)	Conducted Limit (dBµV)	
	Quasi-Peak	Average
0.15-0.5	66 to 56*	56 to 46*
0.5-5	56	46
5-30	60	50

*Decreases with the logarithm of the frequency.

For terminal test result, the testing follows FCC KDB 174176.

3.1.2 Measuring Instruments

See list of measuring instruments of this test report.

3.1.3 Test Procedures

1. The EUT was placed 0.4 meter from the conducting wall of the shielding room, and it was kept at least 80 centimeters from any other grounded conducting surface.
2. Connect EUT to the power mains through a line impedance stabilization network (LISN).
3. All the support units are connecting to the other LISN.
4. The LISN provides 50 ohm coupling impedance for the measuring instrument.
5. The FCC states that a 50 ohm, 50 microhenry LISN should be used.
6. Both sides of AC line were checked for maximum conducted interference.
7. The frequency range from 150 kHz to 30 MHz was searched.
8. Set the test-receiver system to Peak Detect Function and specified bandwidth (IF Bandwidth = 9kHz) with Maximum Hold Mode. Then measurement is also conducted by Average Detector and Quasi-Peak Detector Function respectively.

3.1.4 Test setup

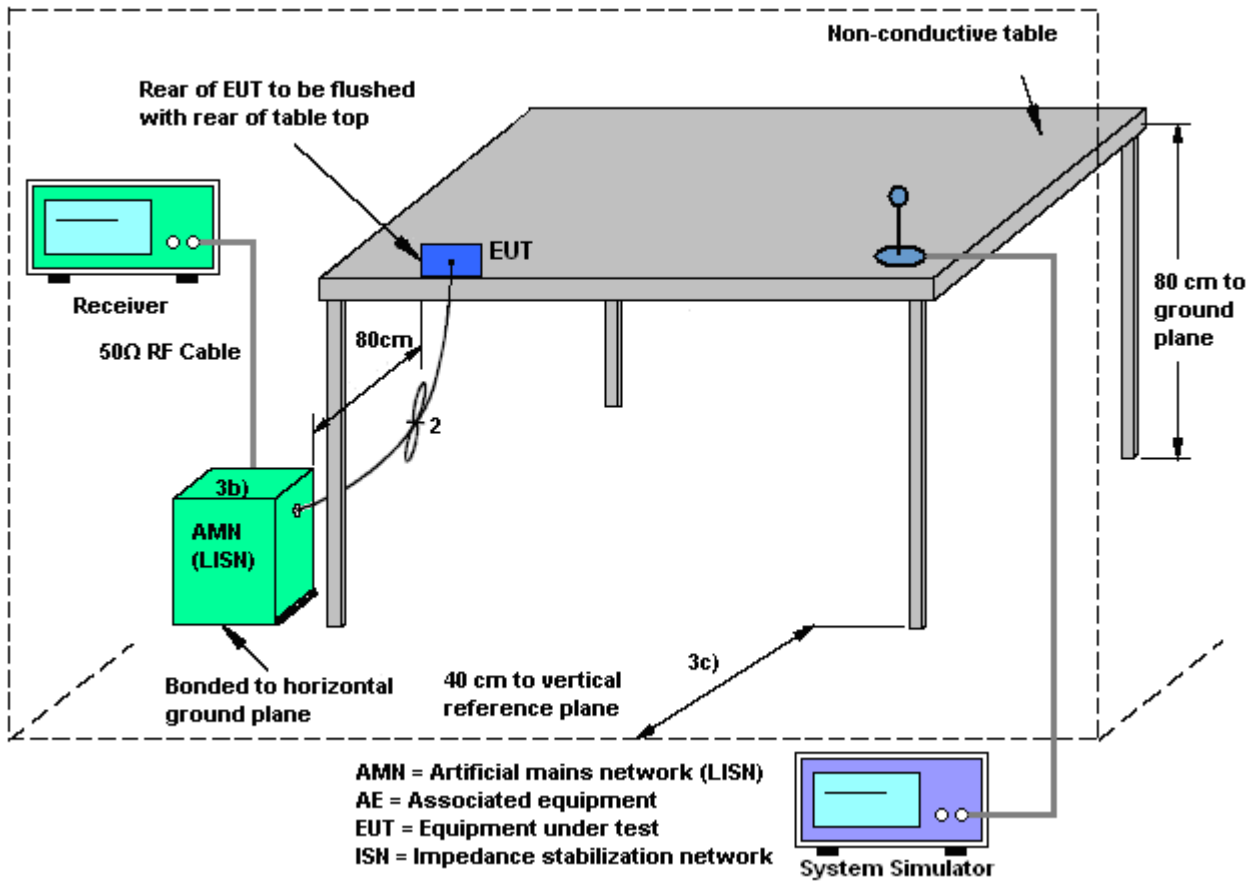

3.1.5 Test Result of AC Conducted Emission

Please refer to Appendix A.

3.2 20dB and 99% OBW Spectrum Bandwidth Measurement

3.2.1 Limit

Intentional radiators must be designed to ensure that the 20dB and 99% emission bandwidth in the specific band 13.553~13.567MHz.

3.2.2 Measuring Instruments

See list of measuring instruments of this test report.

3.2.3 Test Procedures

1. The spectrum analyzer connected via a receive antenna placed near the EUT in peak Max hold mode.
2. The resolution bandwidth of 1 kHz and the video bandwidth of 3 kHz were used.
3. Measured the spectrum width with power higher than 20dB below carrier.
4. Measured the 99% OBW.

3.2.4 Test Setup

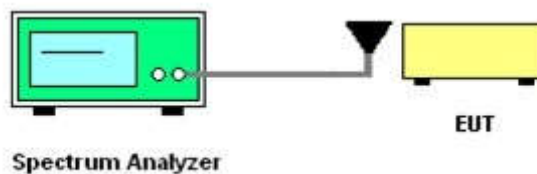

3.2.5 Test Result of Conducted Test Items

Please refer to Appendix B.

3.3 Frequency Stability Measurement

3.3.1 Limit

The frequency tolerance of the carrier signal shall be maintained within +/- 0.01% (100ppm) of the operating frequency over a temperature variation of -20 degrees to +50 degrees C at normal supply voltage, and for a variation in the primary supply voltage from 85% to 115% of the rated supply voltage at a temperature of 20 degrees C. For battery operated equipment, the equipment tests shall be performed using a new battery.

3.3.2 Measuring Instruments

See list of measuring instruments of this test report.

3.3.3 Test Procedures

1. The spectrum analyzer connected via a receive antenna placed near the EUT.
2. EUT have transmitted signal and fixed channelize.
3. Set the spectrum analyzer span to view the entire emissions bandwidth.
4. Set RBW = 1 kHz, VBW = 3 kHz with peak detector and maxhold settings.
5. The f_c is declaring of channel frequency. Then the frequency error formula is $(f_c - f) / f_c \times 10^6$ ppm and the limit is less than ± 100 ppm.
6. Extreme temperature rule is -20°C~50°C.

3.3.4 Test Setup

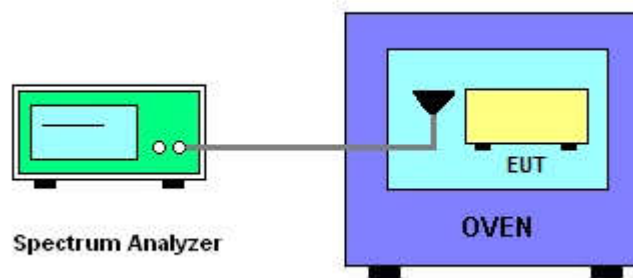

3.3.5 Test Result of Conducted Test Items

Please refer to Appendix B.

3.4 Field Strength of Fundamental Emissions and Mask Measurement

3.4.1 Limit

Rules and specifications	FCC CFR 47 Part 15 section 15.225			
Description	Compliance with the spectrum mask is tested with RBW set to 9kHz.			
Freq. of Emission (MHz)	Field Strength ($\mu\text{V/m}$) at 30m	Field Strength ($\text{dB}\mu\text{V/m}$) at 30m	Field Strength ($\text{dB}\mu\text{V/m}$) at 10m	Field Strength ($\text{dB}\mu\text{V/m}$) at 3m
1.705~13.110	30	29.5	48.58	69.5
13.110~13.410	106	40.5	59.58	80.5
13.410~13.553	334	50.5	69.58	90.5
13.553~13.567	15848	84.0	103.08	124.0
13.567~13.710	334	50.5	69.58	90.5
13.710~14.010	106	40.5	59.58	80.5
14.010~30.000	30	29.5	48.58	69.5

3.4.2 Measuring Instruments

See list of measuring instruments of this test report.

3.4.3 Test Procedures

1. Configure the EUT according to ANSI C63.10. The EUT was placed on the top of the turntable 0.8 meter above ground. The phase center of the loop receiving antenna mounted antenna tower was placed 3 meters far away from the turntable.
2. Power on the EUT and all the supporting units. The turntable was rotated by 360 degrees to determine the position of the highest radiation.
3. The height of the receiving antenna was fixed at one meter above ground to find the maximum emissions field strength.
4. For Fundamental emissions, use the receiver to measure QP reading.

5. When the radiated emissions limits are expressed in terms of the average value of the emissions, and pulsed operation is employed, the measurement field strength shall be determined by averaging over one complete pulse train, including blanking intervals, as long as the pulse train does not exceed 0.1 seconds. As an alternative (provided the transmitter operates for longer than 0.1 seconds) or in cases where the pulse train exceeds 0.1 seconds, the measured field strength shall be determined from the average absolute voltage during a 0.1 second interval during which the field strength is at its maximum value.
6. Compliance with the spectrum mask is tested with RBW set to 9kHz.
Note: Emission level (dB μ V/m) = 20 log Emission level (μ V/m).

3.4.4 Test Setup

For radiated emissions below 30MHz

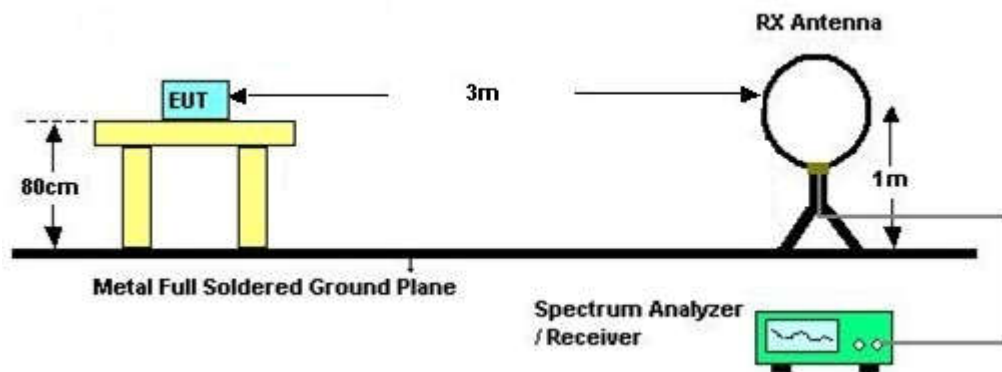

3.4.5 Test Result of Field Strength of Fundamental Emissions and Mask

Please refer to Appendix C.

3.5 Radiated Emissions Measurement

3.5.1 Limit

The field strength of any emissions which appear outside of 13.110 ~14.010MHz band shall not exceed the general radiated emissions limits.

Frequencies (MHz)	Field Strength ($\mu\text{V/m}$)	Measurement Distance (meters)
0.009~0.490	2400/F(kHz)	300
0.490~1.705	24000/F(kHz)	30
1.705~30.0	30	30
30~88	100	3
88~216	150	3
216~960	200	3
Above 960	500	3

3.5.2 Measuring Instruments

See list of measuring instruments of this test report.

3.5.3 Measuring Instrument Setting

The following table is the setting of receiver.

Receiver Parameter	Setting
Attenuation	Auto
Frequency Range: 9kHz~150kHz	RBW 200Hz for QP
Frequency Range: 150kHz~30MHz	RBW 9kHz for QP
Frequency Range: 30MHz~1000MHz	RBW 120kHz for Peak

Note: The emission limits shown in the above table are based on measurements employing a CISPR quasi-peak detector except for the frequency bands 9-90 kHz, 110-490 kHz. Radiated emission limits in these two bands are based on measurements employing an average detector.



3.5.4 Test Procedures

1. Configure the EUT according to ANSI C63.10. The EUT was placed on the top of the turntable 0.8 meter above ground. The phase center of the receiving antenna mounted on the top of a height-variable antenna tower was placed 3 meters far away from the turntable.
2. Power on the EUT and all the supporting units. The turntable was rotated by 360 degrees to determine the position of the highest radiation.
3. The height of the broadband receiving antenna was varied between one meter and four meters above ground to find the maximum emissions field strength of both horizontal and vertical polarization.
4. For each suspected emissions, the antenna tower was scan (from 1 M to 4 M) and then the turntable was rotated (from 0 degree to 360 degrees) to find the maximum reading.
5. Set the test-receiver system to Peak or CISPR quasi-peak Detect Function with specified bandwidth under Maximum Hold Mode.
6. When the radiated emissions limits are expressed in terms of the average value of the emissions, and pulsed operation is employed, the measurement field strength shall be determined by averaging over one complete pulse train, including blanking intervals, as long as the pulse train does not exceed 0.1 seconds. As an alternative (provided the transmitter operates for longer than 0.1 seconds) or in cases where the pulse train exceeds 0.1 seconds, the measured field strength shall be determined from the average absolute voltage during a 0.1 second interval during which the field strength is at its maximum value.
7. In case the emission is lower than 30MHz, loop antenna has to be used for measurement and the recorded data should be QP measured by receiver. Antenna Requirements

3.5.5 Test Setup

For radiated emissions above 30MHz

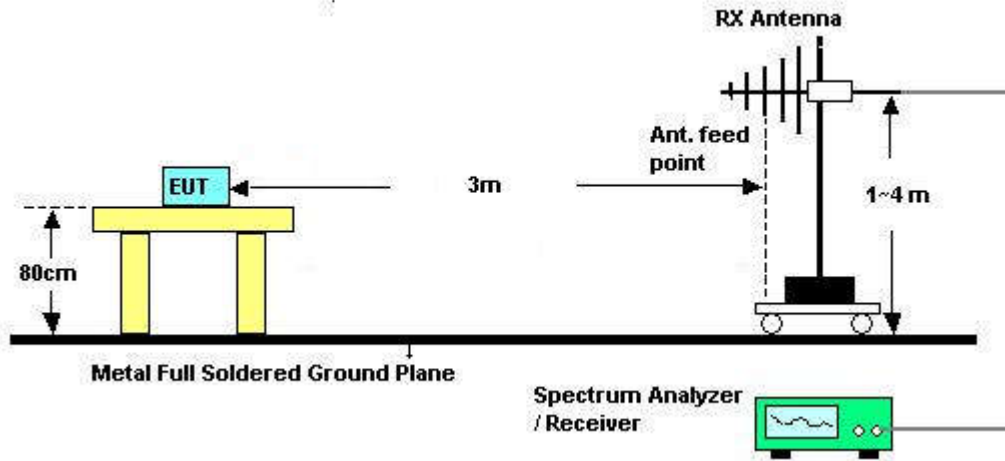

3.5.6 Test Result of Radiated Emissions Measurement

Please refer to Appendix C.



3.6 Antenna Requirements

3.6.1 Standard Applicable

Except for special regulations, the Low-power Radio-frequency Devices must not be equipped with any jacket for installing an antenna with extension cable. An intentional radiator shall be designed to ensure that no antenna other than that furnished by the responsible party shall be used with the device. The use of a permanently attached antenna or of an antenna that uses a unique coupling to the intentional radiator shall be considered sufficient to comply with the provisions of this Section. The manufacturer may design the unit so that the user can replace a broken antenna, but the use of a standard antenna jack or electrical connector is prohibited.

The use of a permanently attached antenna or of an antenna that uses a unique coupling to the intentional radiator shall be considered sufficient to comply with the FCC rule.

3.6.2 Antenna Anti-Replacement Construction

An embedded-in antenna design is used.



4. LIST OF MEASURING EQUIPMENT

Instrument	Manufacturer	Model No.	Serial No.	Characteristics	Calibration Date	Test Date	Due Date	Remark
Spectrum Analyzer	R&S	FSV40	101040	10Hz~40GHz	Aug. 08, 2017	Jan. 05, 2018	Aug. 07, 2018	Conducted (TH01-KS)
Thermal Chamber	Ten Billion	TTC-B3S	TBN-960502	-40~+150°C	Oct. 12, 2017	Jan. 05, 2018	Oct. 11, 2018	Conducted (TH01-KS)
AC Power Source	Chroma	61602	ABP000000 811	AC 0V~300V, 45Hz~1000Hz	Oct. 12, 2017	Jan. 05, 2018	Oct. 11, 2018	Conducted (TH01-KS)
EMI Test Receiver	R&S	ESR7	101403	9kHz~7GHz;Max 30dBm	Aug. 08, 2017	Feb. 13, 2018	Aug. 07, 2018	Radiation (03CH02-KS)
Loop Antenna	R&S	HFH2-Z2	100321	9kHz~30MHz	Oct. 22, 2017	Feb. 13, 2018	Oct. 21, 2018	Radiation (03CH02-KS)
Bilog Antenna	TeseQ	CBL6112D	23182	30MHz~2GHz	Jan. 21, 2018	Feb. 13, 2018	Jan. 20, 2019	Radiation (03CH02-KS)
Amplifier	SONOMA	310N	187289	9KHz-1GHz	Aug. 07, 2017	Feb. 13, 2018	Aug. 06, 2018	Radiation (03CH02-KS)
AC Power Source	Chroma	61601	6160100024 73	N/A	NCR	Feb. 13, 2018	NCR	Radiation (03CH02-KS)
Turn Table	MF	MF7802	N/A	0~360 degree	NCR	Feb. 13, 2018	NCR	Radiation (03CH02-KS)
Antenna Mast	MF	MF7802	N/A	1 m~4 m	NCR	Feb. 13, 2018	NCR	Radiation (03CH02-KS)
EMI Receiver	R&S	ESC17	100768	9kHz~7GHz;	Apr. 20, 2017	Jan. 16, 2018	Apr. 19, 2018	Conduction (CO01-KS)
AC LISN	MessTec	AN3016	060103	9kHz~30MHz	Oct. 13, 2017	Jan. 16, 2018	Oct. 12, 2018	Conduction (CO01-KS)
AC LISN (for auxiliary equipment)	MessTec	AN3016	060105	9kHz~30MHz	Oct. 13, 2017	Jan. 16, 2018	Oct. 12, 2018	Conduction (CO01-KS)
AC Power Source	Chroma	61602	ABP000000 811	AC 0V~300V, 45Hz~1000Hz	Oct. 12, 2017	Jan. 16, 2018	Oct. 11, 2018	Conduction (CO01-KS)

NCR: No Calibration Required



Appendix A. Test Results of Conducted Emission Test

Test Mode :	NFC Tx	Test Voltage :	120Vac / 60Hz
Function Type :	GSM850 Idle + Bluetooth Link + WLAN Link(2.4G) + USB Cable (Charging from Adapter 1) + Earphone 1+ NFC Tx		

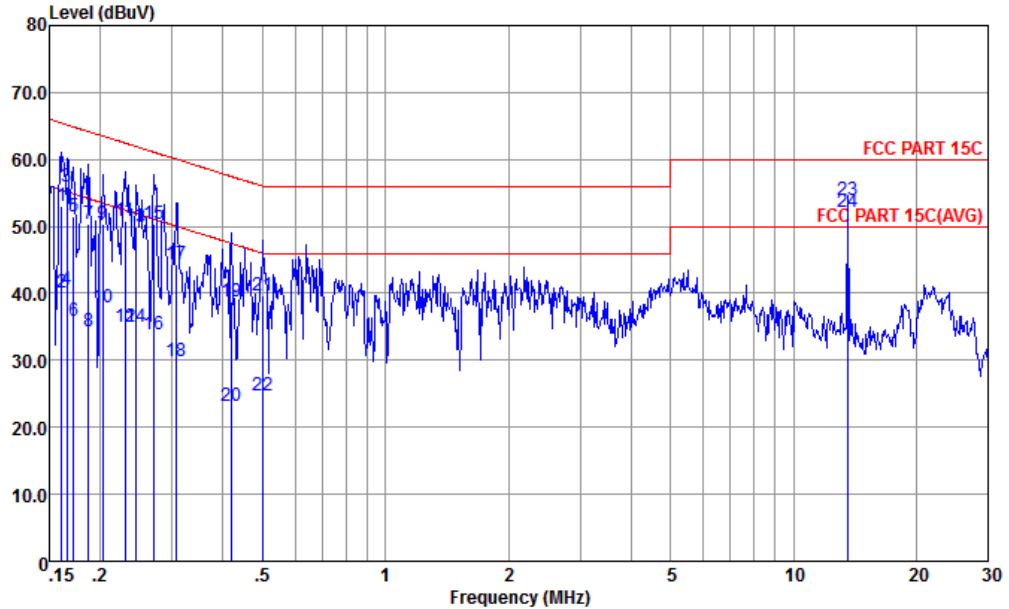

Site : CO01-KS
 Condition : FCC PART 15C LISN-L-171013-060103 LINE
 mode : Mode 1
 : 351848090015253/351848090015261 #9

	Freq	Level	Over Limit	Limit	Read	LISN	Cable	Loss	Remark
	MHz	dBuV		dB	dBuV	dB	dB	dB	
1	0.161	52.95	-12.48	65.43	42.20	0.17	10.58	QP	
2	0.161	40.05	-15.38	55.43	29.30	0.17	10.58	Average	
3	0.166	55.83	-9.33	65.16	45.10	0.17	10.56	QP	
4	0.166	40.63	-14.53	55.16	29.90	0.17	10.56	Average	
5	0.172	51.52	-13.34	64.86	40.80	0.18	10.54	QP	
6	0.172	35.82	-19.04	54.86	25.10	0.18	10.54	Average	
7	0.187	50.28	-13.87	64.15	39.60	0.19	10.49	QP	
8	0.187	34.28	-19.87	54.15	23.60	0.19	10.49	Average	
9	0.203	50.26	-13.23	63.49	39.61	0.20	10.45	QP	
10	0.203	37.86	-15.63	53.49	27.21	0.20	10.45	Average	
11	0.230	50.86	-11.58	62.44	40.20	0.21	10.45	QP	
12	0.230	34.96	-17.48	52.44	24.30	0.21	10.45	Average	
13	0.246	49.95	-11.96	61.91	39.30	0.21	10.44	QP	
14	0.246	34.95	-16.96	51.91	24.30	0.21	10.44	Average	
15	0.270	50.45	-10.67	61.12	39.80	0.22	10.43	QP	
16	0.270	33.95	-17.17	51.12	23.30	0.22	10.43	Average	
17	0.307	44.25	-15.81	60.06	33.59	0.23	10.43	QP	

(1) with antenna

Remark: 13.560MHz is the NFC RF fundamental signal.



Test Mode :	NFC Tx	Test Voltage :	120Vac / 60Hz
Function Type :	GSM850 Idle + Bluetooth Link + WLAN Link(2.4G) + USB Cable (Charging from Adapter 1) + Earphone 1+ NFC Tx		

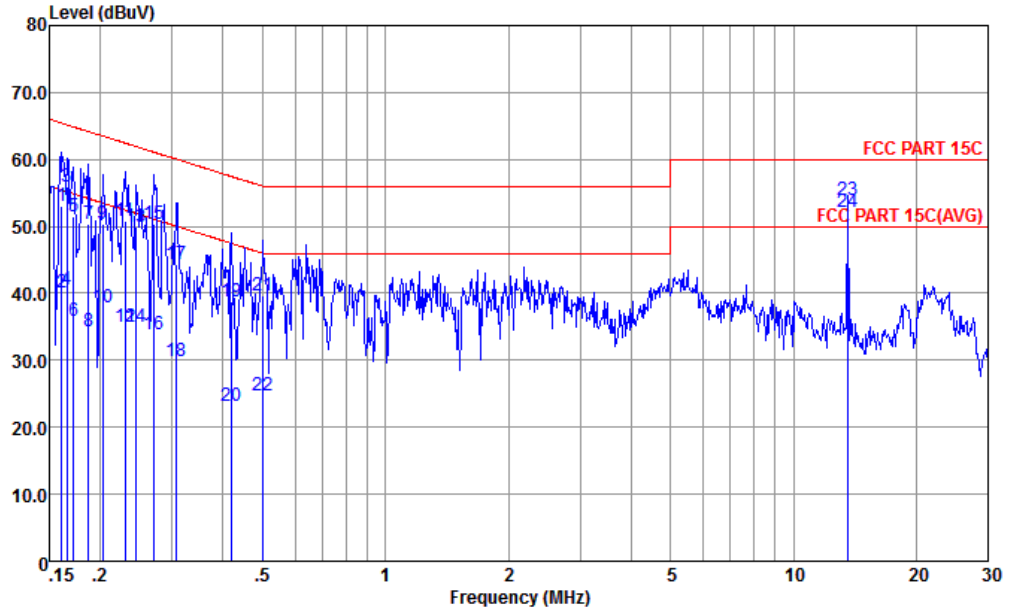

Site : CO01-KS
 Condition : FCC PART 15C LISN-L-171013-060103 LINE

mode : Mode 1
 : 351848090015253/351848090015261 #9

Freq	Level	Over Limit	Read Line	LISN Level	Cable Factor	Cable Loss	Remark
MHz	dBuV	dB	dBuV	dBuV	dB	dB	
18	0.307	29.95	-20.11	50.06	19.29	0.23	10.43 Average
19	0.419	38.84	-18.62	57.46	28.20	0.25	10.39 QP
20	0.419	23.24	-24.22	47.46	12.60	0.25	10.39 Average
21	0.502	39.76	-16.24	56.00	29.20	0.26	10.30 QP
22	0.502	24.76	-21.24	46.00	14.20	0.26	10.30 Average
23	13.560	53.88	-6.12	60.00	43.21	0.28	10.39 QP
24 *	13.560	52.18	2.18	50.00	41.51	0.28	10.39 Average

(1) with antenna

Remark: 13.560MHz is the NFC RF fundamental signal.



Test Mode :	NFC Tx	Test Voltage :	120Vac / 60Hz
Function Type :	GSM850 Idle + Bluetooth Link + WLAN Link(2.4G) + USB Cable (Charging from Adapter 1) + Earphone 1+ NFC Tx		

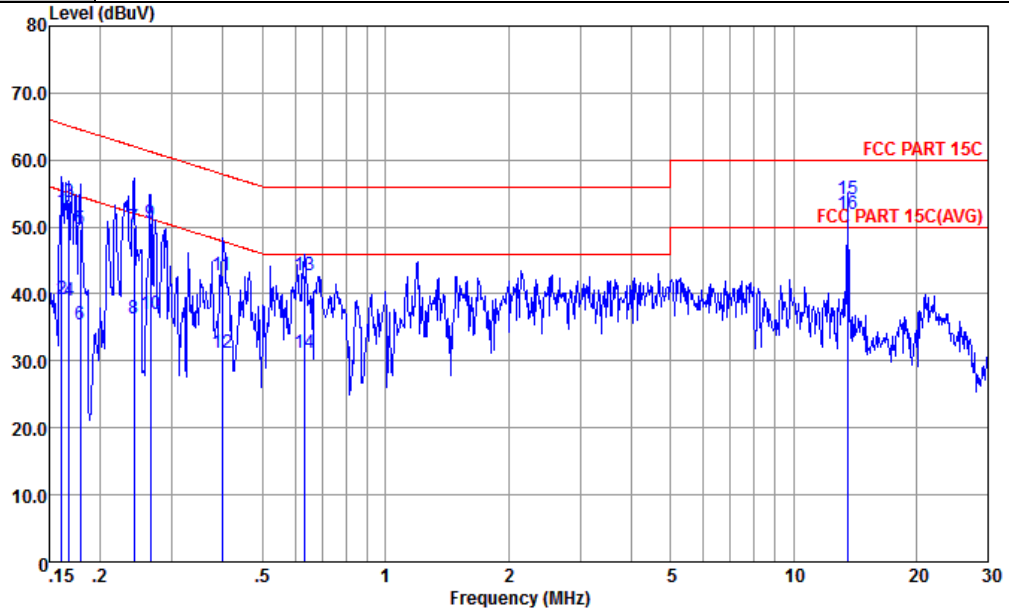

Site : CO01-KS
 Condition : FCC PART 15C LISN-N-171013-060103 NEUTRAL

: 351848090015253/351848090015261 #9

	Freq	Level	Over Limit	Limit	Read Line	LISN Level	Cable Factor	Cable Loss	Remark
	MHz	dBuV	dB	dBuV	dBuV	dB	dB	dB	
1	0.161	52.36	-13.07	65.43	41.50	0.28	10.58	QP	
2	0.161	39.16	-16.27	55.43	28.30	0.28	10.58	Average	
3	0.168	53.63	-11.45	65.08	42.80	0.28	10.55	QP	
4	0.168	39.03	-16.05	55.08	28.20	0.28	10.55	Average	
5	0.179	49.70	-14.85	64.55	38.90	0.28	10.52	QP	
6	0.179	35.40	-19.15	54.55	24.60	0.28	10.52	Average	
7	0.242	50.02	-12.02	62.04	39.30	0.28	10.44	QP	
8	0.242	36.22	-15.82	52.04	25.50	0.28	10.44	Average	
9	0.266	50.62	-10.63	61.25	39.90	0.28	10.44	QP	
10	0.266	37.02	-14.23	51.25	26.30	0.28	10.44	Average	
11	0.398	42.89	-15.01	57.90	32.19	0.29	10.41	QP	
12	0.398	31.29	-16.61	47.90	20.59	0.29	10.41	Average	
13	0.634	42.80	-13.20	56.00	32.30	0.30	10.20	QP	
14	0.634	31.10	-14.90	46.00	20.60	0.30	10.20	Average	
15	13.560	54.23	-5.77	60.00	43.61	0.23	10.39	QP	
16 *	13.560	51.83	1.83	50.00	41.21	0.23	10.39	Average	

(1) with antenna

Remark: 13.560MHz is the NFC RF fundamental signal.



Test Mode :	NFC Tx	Test Voltage :	120Vac / 60Hz
Function Type :	GSM850 Idle + Bluetooth Link + WLAN Link(2.4G) + USB Cable (Charging from Adapter 1) + Earphone 1+ NFC Tx		

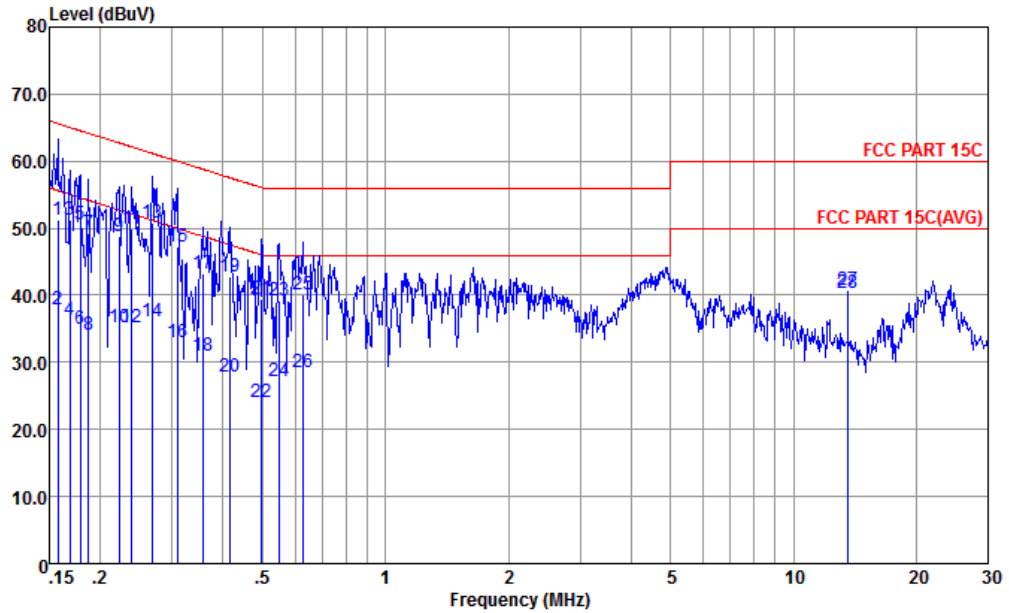

Site : CO01-KS
 Condition : FCC PART 15C LISN-L-171013-060103 LINE

: 351848090015253/351848090015261 #9

	Freq	Level	Over Limit	Limit	Read	LISN	Cable	Remark
	MHz	dBuV	dB	dBuV	dBuV	dB	dB	
1	0.157	51.36	-14.24	65.60	40.60	0.17	10.59	QP
2	0.157	37.96	-17.64	55.60	27.20	0.17	10.59	Average
3	0.169	51.33	-13.70	65.03	40.60	0.18	10.55	QP
4	0.169	36.23	-18.80	55.03	25.50	0.18	10.55	Average
5	0.179	50.50	-14.05	64.55	39.80	0.18	10.52	QP
6	0.179	34.90	-19.65	54.55	24.20	0.18	10.52	Average
7	0.187	49.28	-14.87	64.15	38.60	0.19	10.49	QP
8	0.187	33.98	-20.17	54.15	23.30	0.19	10.49	Average
9	0.222	48.85	-13.89	62.74	38.19	0.21	10.45	QP
10	0.222	35.25	-17.49	52.74	24.59	0.21	10.45	Average
11	0.239	49.85	-12.28	62.13	39.20	0.21	10.44	QP
12	0.239	35.15	-16.98	52.13	24.50	0.21	10.44	Average
13	0.269	50.85	-10.31	61.16	40.20	0.22	10.43	QP
14	0.269	36.15	-15.01	51.16	25.50	0.22	10.43	Average
15	0.308	47.25	-12.77	60.02	36.59	0.23	10.43	QP
16	0.308	32.95	-17.07	50.02	22.29	0.23	10.43	Average
17	0.356	43.15	-15.68	58.83	32.49	0.24	10.42	QP

(2) With dummy load

Remark: Only the fundamental NFC signal needs to be retested per C63.4.



Test Mode :	NFC Tx	Test Voltage :	120Vac / 60Hz
Function Type :	GSM850 Idle + Bluetooth Link + WLAN Link(2.4G) + USB Cable (Charging from Adapter 1) + Earphone 1+ NFC Tx		

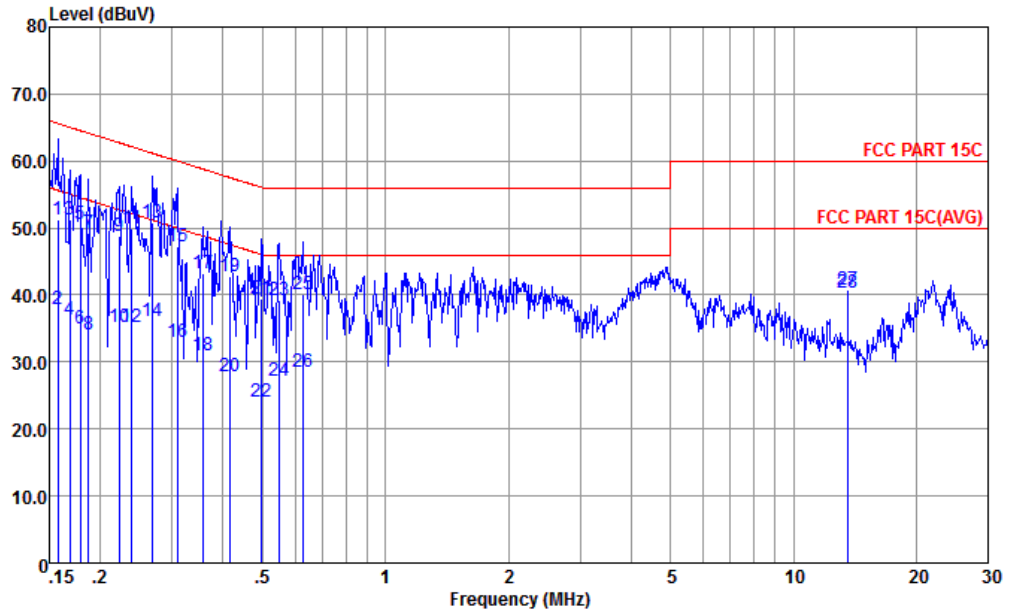

Site : CO01-KS
 Condition : FCC PART 15C LISN-L-171013-060103 LINE

: 351848090015253/351848090015261 #9

Freq	Level	Over Limit	Limit Line	Read Level	LISN Factor	Cable Loss	Remark
MHz	dBuV	dB	dBuV	dBuV	dB	dB	
18	0.356	30.95	-17.88	48.83	20.29	0.24	10.42 Average
19	0.415	42.84	-14.71	57.55	32.20	0.25	10.39 QP
20	0.415	27.84	-19.71	47.55	17.20	0.25	10.39 Average
21	0.497	39.47	-16.58	56.05	28.90	0.26	10.31 QP
22	0.497	24.17	-21.88	46.05	13.60	0.26	10.31 Average
23	0.549	39.13	-16.87	56.00	28.60	0.26	10.27 QP
24	0.549	27.13	-18.87	46.00	16.60	0.26	10.27 Average
25	0.627	40.07	-15.93	56.00	29.60	0.26	10.21 QP
26	0.627	28.57	-17.43	46.00	18.10	0.26	10.21 Average
27	13.560	40.88	-19.12	60.00	30.21	0.28	10.39 QP
28 *	13.560	40.38	-9.62	50.00	29.71	0.28	10.39 Average

(2) With dummy load

Remark: Only the fundamental NFC signal needs to be retested per C63.4.



Test Mode :	NFC Tx	Test Voltage :	120Vac / 60Hz
Function Type :	GSM850 Idle + Bluetooth Link + WLAN Link(2.4G) + USB Cable (Charging from Adapter 1) + Earphone 1+ NFC Tx		

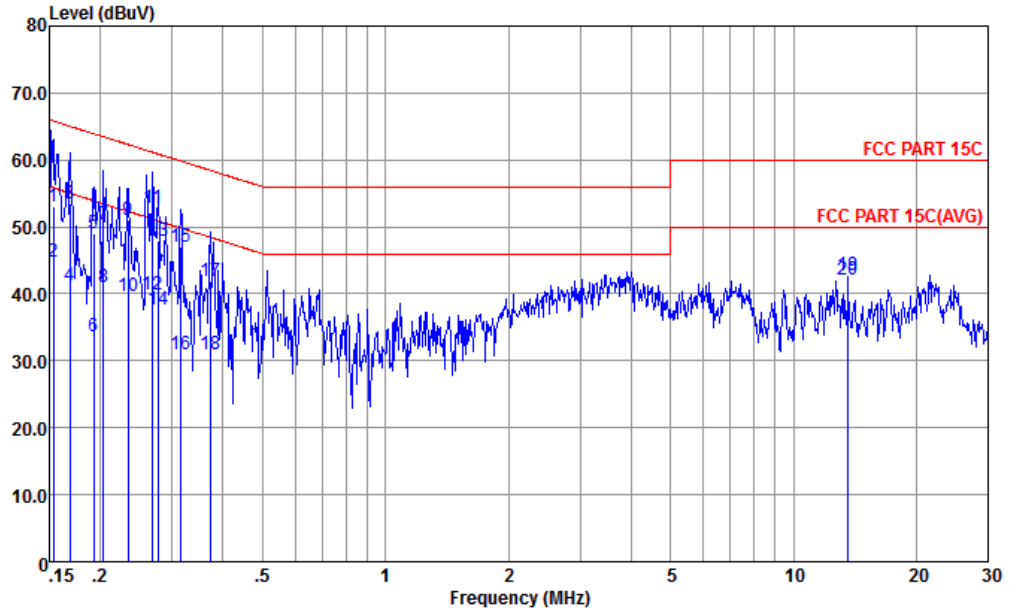

Site : CO01-KS
 Condition : FCC PART 15C LISN-N-171013-060103 NEUTRAL

: 351848090015253/351848090015261 #9

	Over	Limit	Read	LISN	Cable		
Freq	Level	Limit	Line	Level	Factor	Loss	Remark
MHz	dBuV	dB	dBuV	dBuV	dB	dB	
1	0.153	53.09	-12.73	65.82	42.20	0.28	10.61 QP
2	0.153	44.79	-11.03	55.82	33.90	0.28	10.61 Average
3	0.169	53.43	-11.60	65.03	42.60	0.28	10.55 QP
4	0.169	41.13	-13.90	55.03	30.30	0.28	10.55 Average
5	0.192	48.96	-14.97	63.93	38.20	0.28	10.48 QP
6	0.192	33.66	-20.27	53.93	22.90	0.28	10.48 Average
7	0.204	50.33	-13.12	63.45	39.60	0.28	10.45 QP
8	0.204	40.93	-12.52	53.45	30.20	0.28	10.45 Average
9	0.234	50.93	-11.37	62.30	40.21	0.28	10.44 QP
10	0.234	39.63	-12.67	52.30	28.91	0.28	10.44 Average
11	0.269	52.92	-8.24	61.16	42.21	0.28	10.43 QP
12	0.269	39.92	-11.24	51.16	29.21	0.28	10.43 Average
13	0.277	47.92	-12.98	60.90	37.21	0.28	10.43 QP
14	0.277	37.62	-13.28	50.90	26.91	0.28	10.43 Average
15	0.315	46.91	-12.93	59.84	36.21	0.28	10.42 QP
16	0.315	31.01	-18.83	49.84	20.31	0.28	10.42 Average
17	0.371	41.90	-16.57	58.47	31.20	0.29	10.41 QP

(2) With dummy load

Remark: Only the fundamental NFC signal needs to be retested per C63.4.



Test Mode :	NFC Tx	Test Voltage :	120Vac / 60Hz
Function Type :	GSM850 Idle + Bluetooth Link + WLAN Link(2.4G) + USB Cable (Charging from Adapter 1) + Earphone 1+ NFC Tx		

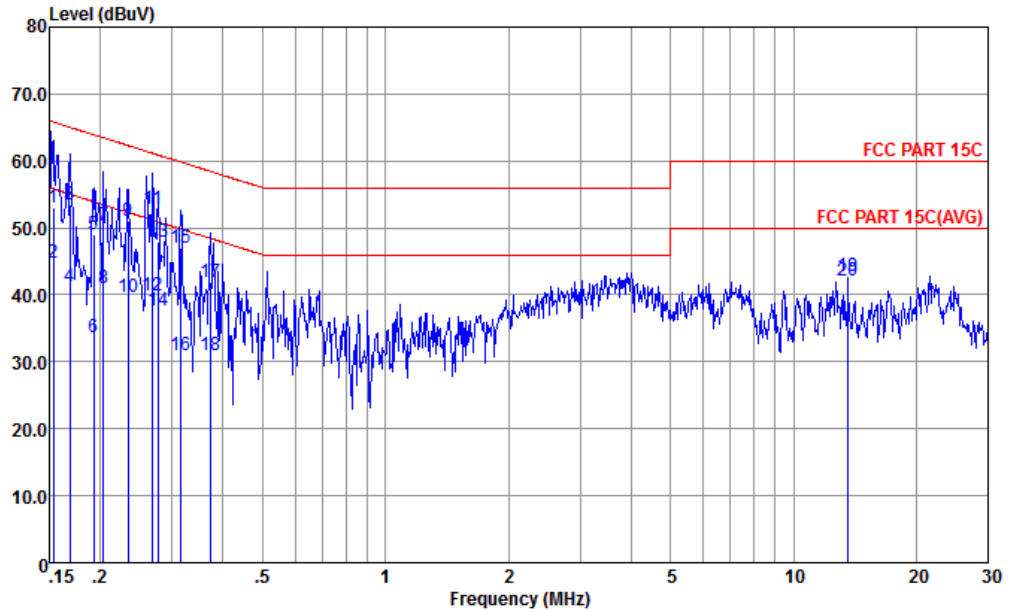

Site : CO01-KS
Condition : FCC PART 15C LISN-N-171013-060103 NEUTRAL

: 351848090015253/351848090015261 #9

Freq	Level	Over Limit	Limit	Read	LISN	Cable	Loss	Remark
MHz	dBuV		dB	dBuV	dBuV	dB	dB	
18	0.371	31.00	-17.47	48.47	20.30	0.29	10.41	Average
19	13.560	42.73	-17.27	60.00	32.11	0.23	10.39	QP
20 *	13.560	42.23	-7.77	50.00	31.61	0.23	10.39	Average

(2) With dummy load

Remark: Only the fundamental NFC signal needs to be retested per C63.4.



Appendix B. Test Results of Conducted Test Items

B1. Test Result of 20dB Spectrum Bandwidth

Test mode	NFC Tx	Test Frequency (MHz)	13.56																																																								
<table border="1"> <thead> <tr> <th>Type</th> <th>Ref</th> <th>Trc</th> <th>X-value</th> <th>Y-value</th> <th>Function</th> <th>Function Result</th> </tr> </thead> <tbody> <tr> <td>M1</td> <td>1</td> <td></td> <td>13.560507 MHz</td> <td>-18.03 dBm</td> <td>ndB down</td> <td>2.489 kHz</td> </tr> <tr> <td>T1</td> <td>1</td> <td></td> <td>13.559262 MHz</td> <td>-38.07 dBm</td> <td>ndB</td> <td>20.00 dB</td> </tr> <tr> <td>T2</td> <td>1</td> <td></td> <td>13.561751 MHz</td> <td>-38.22 dBm</td> <td>Q factor</td> <td>5447.9</td> </tr> </tbody> </table>		Type	Ref	Trc	X-value	Y-value	Function	Function Result	M1	1		13.560507 MHz	-18.03 dBm	ndB down	2.489 kHz	T1	1		13.559262 MHz	-38.07 dBm	ndB	20.00 dB	T2	1		13.561751 MHz	-38.22 dBm	Q factor	5447.9	<table border="1"> <thead> <tr> <th>Type</th> <th>Ref</th> <th>Trc</th> <th>X-value</th> <th>Y-value</th> <th>Function</th> <th>Function Result</th> </tr> </thead> <tbody> <tr> <td>M1</td> <td>1</td> <td></td> <td>13.560507 MHz</td> <td>-16.43 dBm</td> <td></td> <td></td> </tr> <tr> <td>T1</td> <td>1</td> <td></td> <td>13.5594501 MHz</td> <td>-30.41 dBm</td> <td>Occ Bw</td> <td>2.112879884 kHz</td> </tr> <tr> <td>T2</td> <td>1</td> <td></td> <td>13.561563 MHz</td> <td>-30.51 dBm</td> <td></td> <td></td> </tr> </tbody> </table>		Type	Ref	Trc	X-value	Y-value	Function	Function Result	M1	1		13.560507 MHz	-16.43 dBm			T1	1		13.5594501 MHz	-30.41 dBm	Occ Bw	2.112879884 kHz	T2	1		13.561563 MHz	-30.51 dBm		
Type	Ref	Trc	X-value	Y-value	Function	Function Result																																																					
M1	1		13.560507 MHz	-18.03 dBm	ndB down	2.489 kHz																																																					
T1	1		13.559262 MHz	-38.07 dBm	ndB	20.00 dB																																																					
T2	1		13.561751 MHz	-38.22 dBm	Q factor	5447.9																																																					
Type	Ref	Trc	X-value	Y-value	Function	Function Result																																																					
M1	1		13.560507 MHz	-16.43 dBm																																																							
T1	1		13.5594501 MHz	-30.41 dBm	Occ Bw	2.112879884 kHz																																																					
T2	1		13.561563 MHz	-30.51 dBm																																																							
20dB Bandwidth (kHz)	2.49	99% OccupiedBW(kHz)	2.11																																																								
Frequency range (MHz)	$f_L > 13.553$		13.559262																																																								
	$f_H < 13.567$		13.561751																																																								
			Test Result																																																								
			Complies																																																								



B2. Test Result of Frequency Stability

Voltage vs. Frequency Stability		Temperature vs. Frequency Stability	
Voltage (Vac)	Measurement Frequency (MHz)	Temperature (°C)	Measurement Frequency (MHz)
120	13.560514	-20	13.560579
102	13.560514	-10	13.560579
138	13.560514	0	13.560579
		10	13.560500
		20	13.560500
		30	13.560500
		40	13.560500
		50	13.560500
Max.Deviation (MHz)	0.000514	Max.Deviation (MHz)	0.000579
Max.Deviation (ppm)	37.9056	Max.Deviation (ppm)	42.6991
Limit	FS < ±100 ppm	Limit	FS < ±100 ppm
Test Result	PASS	Test Result	PASS



Appendix C. Test Results of Radiated Test Items

C1. Test Result of Field Strength of Fundamental Emissions

Test Mode :	NFC Tx	Test Frequency (MHz)	13.56
-------------	--------	----------------------	-------

Site : 03CH02-KS
Condition : NFC 15.225 3m NFC ANT HORIZONTAL

Freq	Level	Over Limit	Limit Line	ReadAntenna Level	Cable Loss	A/Pos	T/Pos	Remark		
MHz	dBuV/m	dB	dBuV/m	dBuV	dB/m	dB	cm	deg		
1	13.56	56.95	-67.05	124.00	35.98	20.81	0.16	---	---	QP

Site : 03CH02-KS
Condition : NFC 15.225 3m NFC ANT VERTICAL

Freq	Level	Over Limit	Limit Line	ReadAntenna Level	Cable Loss	A/Pos	T/Pos	Remark		
MHz	dBuV/m	dB	dBuV/m	dBuV	dB/m	dB	cm	deg		
1	13.56	54.03	-69.97	124.00	33.06	20.81	0.16	---	---	QP



C2. Results of Radiated Spurious Emissions (9 kHz~30MHz)

Test Mode :	NFC Tx	Polarization :	Horizontal
-------------	--------	----------------	------------

Frequency (MHz)	Level (dBμV/m)	Over Limit (dB)	Limit Line (dBμV/m)	Read Level (dBμV)	Antenna Factor (dB)	Cable Loss (dB)	Ant Pos (cm)	Table Pos (deg)	Remark
0.01887	24.77	-97.32	122.09	4.66	20.1	0.01	-	-	Average
0.06568	23.9	-87.35	111.25	4.09	19.8	0.01	-	-	Average
0.9788	48.53	-19.25	67.78	27.62	20.89	0.02	-	-	QP
2.3	41.02	-28.52	69.54	20.85	20.13	0.04	-	-	QP
6.122	37.41	-32.13	69.54	16.92	20.41	0.08	-	-	QP
25.71	37.38	-32.16	69.54	15.82	21.27	0.29	-	-	QP

Test Mode :	NFC Tx	Polarization :	Vertical
-------------	--------	----------------	----------

Frequency (MHz)	Level (dBμV/m)	Over Limit (dB)	Limit Line (dBμV/m)	Read Level (dBμV)	Antenna Factor (dB)	Cable Loss (dB)	Ant Pos (cm)	Table Pos (deg)	Remark
0.01901	23.44	-98.58	122.02	3.33	20.1	0.01	-	-	Average
0.03142	23.68	-93.97	117.65	4.27	19.4	0.01	-	-	Average
0.98065	53.96	-13.8	67.76	33.05	20.89	0.02	-	-	QP
2.312	44.28	-25.26	69.54	24.11	20.13	0.04	-	-	QP
5.84	38.06	-31.48	69.54	17.56	20.43	0.07	-	-	QP
17.108	36.19	-33.35	69.54	15.02	20.97	0.2	-	-	QP

Note:

1. The amplitude of spurious emissions which are attenuated by more than 20dB below the permissible value has no need to be reported.
2. Distance extrapolation factor = 40 log (specific distance / test distance) (dB);
3. Limit line = specific limits (dBμV) + distance extrapolation factor.



C3. Results of Radiated Spurious Emissions (30MHz~1GHz)

Test Mode :	NFC Tx	Polarization :	Horizontal
-------------	--------	----------------	------------

Frequency (MHz)	Level (dBμV/m)	Over Limit (dB)	Limit Line (dBμV/m)	Read Level (dBμV)	Antenna Factor (dB)	Cable Loss (dB)	Preamp Factor (dB)	Ant Pos (cm)	Table Pos (deg)	Remark
32.91	21.16	-18.84	40	29.27	23.32	0.61	32.04	-	-	Peak
107.6	16.57	-26.93	43.5	29.76	17.68	1.05	31.92	-	-	Peak
267.65	18.96	-27.04	46	29.39	19.16	1.81	31.4	-	-	Peak
581.93	23.84	-22.16	46	26.31	24.71	2.6	29.78	-	-	Peak
832.19	26.37	-19.63	46	25.37	26.16	2.9	28.06	-	-	Peak
904.94	27.18	-18.82	46	24.92	26.63	3.1	27.47	100	0	Peak

Test Mode :	NFC Tx	Polarization :	Vertical
-------------	--------	----------------	----------

Frequency (MHz)	Level (dBμV/m)	Over Limit (dB)	Limit Line (dBμV/m)	Read Level (dBμV)	Antenna Factor (dB)	Cable Loss (dB)	Preamp Factor (dB)	Ant Pos (cm)	Table Pos (deg)	Remark
30	21.29	-18.71	40	27.75	25	0.57	32.03	-	-	Peak
116.33	19.51	-23.99	43.5	32.28	18.03	1.1	31.9	-	-	Peak
267.65	18.4	-27.6	46	28.83	19.16	1.81	31.4	-	-	Peak
552.83	24.05	-21.95	46	26.57	24.88	2.56	29.96	-	-	Peak
762.35	26.25	-19.75	46	26.31	25.75	2.77	28.58	-	-	Peak
884.57	27.81	-18.19	46	25.86	26.51	3.08	27.64	100	0	Peak

Note:

1. The amplitude of spurious emissions which are attenuated by more than 20dB below the permissible value has no need to be reported.
2. Emission level (dBμV/m) = 20 log Emission level (μV/m).
3. Corrected Reading: Antenna Factor + Cable Loss + Read Level - Preamp Factor= Level.