



FCC RF Test Report

APPLICANT : Motorola Mobility LLC
EQUIPMENT : Mobile Cellular Phone
BRAND NAME : Motorola
MODEL NAME : XT1925-2, XT1925-1
FCC ID : IHDT56XD5
STANDARD : FCC Part 15 Subpart E §15.407
CLASSIFICATION : (NII) Unlicensed National Information Infrastructure

The product was received on Dec. 25, 2017 and testing was completed on Feb. 02, 2018. We, Sporton International (Kunshan) Inc., would like to declare that the tested sample has been evaluated in accordance with the test procedures and has been in compliance with the applicable technical standards.

The test results in this report apply exclusively to the tested model / sample. Without written approval of Sporton International (Kunshan) Inc., the test report shall not be reproduced except in full.



Approved by: James Huang / Manager

Sporton International (Kunshan) Inc.

**No.3-2 Ping-Xiang Rd, Kunshan Development Zone Kunshan City Jiangsu Province 215335
China**



TABLE OF CONTENTS

- 1 GENERAL DESCRIPTION 5**
 - 1.1 Applicant5
 - 1.2 Manufacturer.....5
 - 1.3 Product Feature of Equipment Under Test.....5
 - 1.4 Product Specification of Equipment Under Test.....6
 - 1.5 Specification of Accessory.....7
 - 1.6 Modification of EUT7
 - 1.7 Testing Location8
 - 1.8 Applicable Standards.....8
- 2 TEST CONFIGURATION OF EQUIPMENT UNDER TEST 9**
 - 2.1 Carrier Frequency and Channel9
 - 2.2 Test Mode.....10
 - 2.3 Connection Diagram of Test System.....11
 - 2.4 Support Unit used in test configuration and system12
 - 2.5 EUT Operation Test Setup12
 - 2.6 Measurement Results Explanation Example.....12
- 3 TEST RESULT 13**
 - 3.1 6dB and 26dB and 99% Occupied Bandwidth Measurement13
 - 3.2 Maximum Conducted Output Power Measurement16
 - 3.3 Power Spectral Density Measurement17
 - 3.4 Unwanted Emissions Measurement.....20
 - 3.5 AC Conducted Emission Measurement.....26
 - 3.6 Automatically Discontinue Transmission30
 - 3.7 Antenna Requirements31
- 4 LIST OF MEASURING EQUIPMENT 32**
- 5 UNCERTAINTY OF EVALUATION 33**
- APPENDIX A. CONDUCTED TEST RESULTS**
- APPENDIX B. RADIATED SPURIOUS EMISSION**
- APPENDIX C. DUTY CYCLE PLOTS**
- APPENDIX D. SETUP PHOTOGRAPHS**



SUMMARY OF TEST RESULT

Report Section	FCC Rule	Description	Limit	Result	Remark
3.1	15.403(i)	6dB, 26dB and 99% Occupied Bandwidth	> 500kHz	Pass	-
3.2	15.407(a)	Maximum Conducted Output Power	≤ 30 dBm	Pass	-
3.3	15.407(a)	Power Spectral Density	≤ 30 dBm/500kHz	Pass	-
3.4	15.407(b)	Unwanted Emissions	15.407(b)(4)(i) & 15.209(a)	Pass	Under limit 6.28 dB at 58.130 MHz
3.5	15.207	AC Conducted Emission	15.207(a)	Pass	Under limit 11.26 dB at 0.163 MHz
3.6	15.407(c)	Automatically Discontinue Transmission	Discontinue Transmission	Pass	-
3.7	15.203 & 15.407(a)	Antenna Requirement	N/A	Pass	-



1 General Description

1.1 Applicant

Motorola Mobility LLC
222 W, Merchandise Mart Plaza, Chicago IL 60654 USA

1.2 Manufacturer

Motorola Mobility LLC
222 W, Merchandise Mart Plaza, Chicago IL 60654 USA

1.3 Product Feature of Equipment Under Test

Product Feature	
Equipment	Mobile Cellular Phone
Brand Name	Motorola
Model Name	XT1925-2, XT1925-1
FCC ID	IHDT56XD5
EUT supports Radios application	GSM/GPRS/EGPRS/WCDMA/HSPA/DC-HSDPA/ HSPA+(16QAM uplink is not supported)/LTE WLAN 2.4GHz 802.11b/g/n HT20 WLAN 5GHz 802.11a/n HT20/HT40 Bluetooth v3.0+EDR/ Bluetooth v4.0 LE/ Bluetooth v4.1 LE/Bluetooth v4.2 LE
IMEI Code	Conducted: 351848090017317/351848090017325 Conduction/Radiation: 351848090015253/351848090015261
HW Version	DVT1-B
SW Version	ali_n-userdebug 8.0.0 OPS27.55 1276 intcfg,test-keys
EUT Stage	Identical Prototype

Remark:

1. The above EUT's information was declared by manufacturer. Please refer to the specifications or user's manual for more detailed description.
2. There are two types of EUT: sample 1 (XT1925-2) is dual SIM card, sample 2 (XT1925-1) is single SIM card. According to the difference, only choose sample 1 to perform full test.



1.4 Product Specification of Equipment Under Test

Standards-related Product Specification	
Tx/Rx Channel Frequency Range	5745 MHz ~ 5825 MHz
Maximum Output Power	802.11a : 15.31 dBm / 0.0340 W 802.11n HT20 : 15.28 dBm / 0.0337 W 802.11n HT40 : 13.94 dBm / 0.0248 W
99% Occupied Bandwidth	802.11a : 21.78 MHz 802.11n HT20 : 22.48 MHz 802.11n HT40 : 37.86 MHz
Type of Modulation	802.11a/n : OFDM (BPSK / QPSK / 16QAM / 64QAM)
Antenna Type / Gain	PIFA Antenna with gain -1.80 dBi



1.5 Specification of Accessory

Specification of Accessory			
AC Adapter 1(US)	Brand Name	Motorola (Salom)	Model Name SC-22
	Power Rating	I/P: 100-240 Vac, 500mA, O/P: 5Vdc,3000mA or 9Vdc,1600mA or 12Vdc,1200mA	
AC Adapter 1(EU)	Brand Name	Motorola (Salom)	Model Name SC-23
	Power Rating	I/P: 100-240 Vac, 500mA, O/P: 5Vdc,3000mA or 9Vdc,1600mA or 12Vdc,1200mA	
AC Adapter 1(UK)	Brand Name	Motorola (Salom)	Model Name SC-24
	Power Rating	I/P: 100-240 Vac, 500mA, O/P: 5Vdc,3000mA or 9Vdc,1600mA or 12Vdc,1200mA	
AC Adapter 1(IN)	Brand Name	Motorola (Salom)	Model Name SC-25
	Power Rating	I/P: 100-240 Vac, 500mA, O/P: 5Vdc,3000mA or 9Vdc,1600mA or 12Vdc,1200mA	
AC Adapter 1(AU)	Brand Name	Motorola (Salom)	Model Name SC-26
	Power Rating	I/P: 100-240 Vac, 500mA, O/P: 5Vdc,3000mA or 9Vdc,1600mA or 12Vdc,1200mA	
AC Adapter 1(AR)	Brand Name	Motorola (Salom)	Model Name SC-27
	Power Rating	I/P: 100-240 Vac, 500mA, O/P: 5Vdc,3000mA or 9Vdc,1600mA or 12Vdc,1200mA	
AC Adapter 2(US)	Brand Name	Motorola (Chenyang)	Model Name SC-22
	Power Rating	I/P: 100-240 Vac, 500mA, O/P: 5Vdc,3000mA or 9Vdc,1600mA or 12Vdc,1200mA	
AC Adapter 2(EU)	Brand Name	Motorola (Chenyang)	Model Name SC-23
	Power Rating	I/P: 100-240 Vac, 500mA, O/P: 5Vdc,3000mA or 9Vdc,1600mA or 12Vdc,1200mA	
AC Adapter 2(UK)	Brand Name	Motorola (Chenyang)	Model Name SC-24
	Power Rating	I/P: 100-240 Vac, 500mA, O/P: 5Vdc,3000mA or 9Vdc,1600mA or 12Vdc,1200mA	
AC Adapter 2(IN)	Brand Name	Motorola (Chenyang)	Model Name SC-25
	Power Rating	I/P: 100-240 Vac, 500mA, O/P: 5Vdc,3000mA or 9Vdc,1600mA or 12Vdc,1200mA	
AC Adapter 2(AU)	Brand Name	Motorola (Chenyang)	Model Name SC-26
	Power Rating	I/P: 100-240 Vac, 500mA, O/P: 5Vdc,3000mA or 9Vdc,1600mA or 12Vdc,1200mA	
AC Adapter 2(AR)	Brand Name	Motorola (Chenyang)	Model Name SC-27
	Power Rating	I/P: 100-240 Vac, 500mA, O/P: 5Vdc,3000mA or 9Vdc,1600mA or 12Vdc,1200mA	
Battery	Brand Name	Motorola (ATL)	Model Name HG30
	Power Rating	3.8Vdc,3000mAh	Type Li-ion
Earphone 1	Brand Name	Motorola (Jiahe)	Model Name LS-118M-12
	Signal Line Type	1.2 meter, non-shielded cable, without ferrite core	
Earphone 2	Brand Name	Motorola (Lianyun)	Model Name TS910A-38AMS01WHR-M
	Signal Line Type	1.2 meter, non-shielded cable, without ferrite core	
USB Cable	Brand Name	Motorola (Liqi)	Model Name L32B-053000100-ALL
	Signal Line Type	1.0 meter, shielded cable, without ferrite core	

1.6 Modification of EUT

No modifications are made to the EUT during all test items.



1.7 Testing Location

Sporton International (Kunshan) Inc. is accredited to ISO 17025 by National Voluntary Laboratory Accreditation Program (NVLAP code: 600155-0) and the FCC designation No. is CN5013.

Test Site	Sporton International (Kunshan) Inc.			
Test Site Location	No.3-2 Ping-Xiang Rd, Kunshan Development Zone Kunshan City Jiangsu Province 215335 China TEL : +86-512-57900158 FAX : +86-512-57900958			
Test Site No.	Sporton Site No.			FCC Test Firm Registration No.
	TH01-KS	03CH03-KS	CO01-KS	630927

Note: The test site complies with ANSI C63.4 2014 requirement.

1.8 Applicable Standards

According to the specifications of the manufacturer, the EUT must comply with the requirements of the following standards:

- ♦ FCC Part 15 Subpart E
- ♦ FCC KDB 789033 D02 General UNII Test Procedures New Rules v02r01
- ♦ ANSI C63.10-2013

Remark:

1. All test items were verified and recorded according to the standards and without any deviation during the test.
2. This EUT has also been tested and complied with the requirements of FCC Part 15, Subpart B, recorded in a separate test report.



2 Test Configuration of Equipment Under Test

The EUT has been associated with peripherals and configuration operated in a manner tended to maximize its emission characteristics in a typical application. Frequency range investigated: conducted emission (150 kHz to 30 MHz) and radiated emission (9 kHz to the 10th harmonic of the highest fundamental frequency or to 40 GHz, whichever is lower). For radiated measurement, pre-scanned in three orthogonal panels, X, Y, Z. The worst cases were recorded in this report.

2.1 Carrier Frequency and Channel

Frequency Band	Channel	Freq. (MHz)	Channel	Freq. (MHz)
5745-5825 MHz Band 4 (U-NII-3)	149	5745	157	5785
	151*	5755	159*	5795
	153	5765	161	5805
	-	-	165	5825

Note: The above Frequency and Channel in "*" were 802.11n HT40.



2.2 Test Mode

Final test mode of conducted test items and radiated spurious emissions are considering the modulation and worse data rates as below table.

Modulation	Data Rate
802.11a	6 Mbps
802.11n HT20	MCS0
802.11n HT40	MCS0

AC Conducted Emission	Mode 1 : GSM850 Idle + Bluetooth Link + WLAN Link (5G) + USB Cable (Charging from Adapter 1) + Earphone 1
Remark: For Radiated Test Cases, The tests were performed with Earphone 1, Adapter 1 and USB Cable.	

Ch. #		Band IV : 5745-5825 MHz		
		802.11a	802.11n HT20	802.11n HT40
L	Low	149	149	151
M	Middle	157	157	-
H	High	165	165	159

2.3 Connection Diagram of Test System

<WLAN Tx Mode>

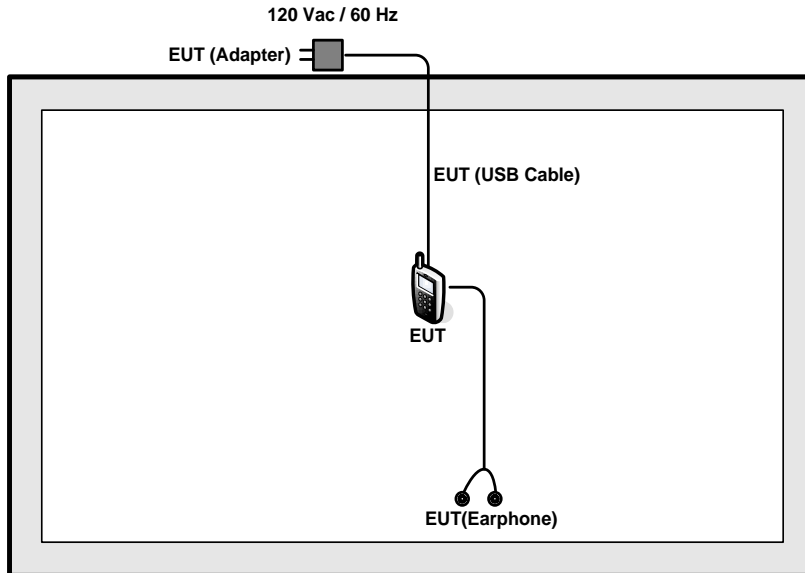

<AC Conducted Emission Mode>

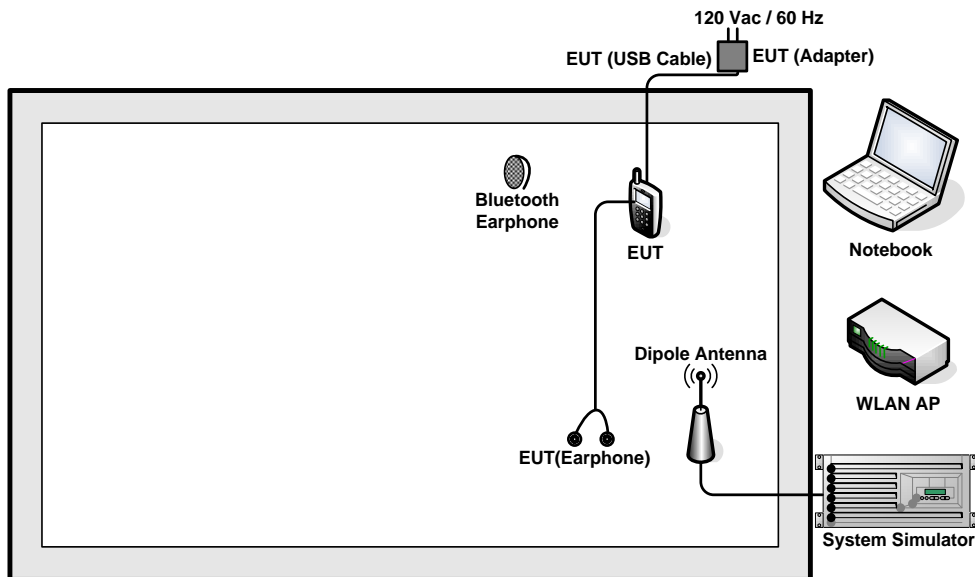



2.4 Support Unit used in test configuration and system

Item	Equipment	Trade Name	Model Name	FCC ID	Data Cable	Power Cord
1.	System Simulator	R&S	CMU 200	N/A	N/A	Unshielded, 1.8 m
2.	WLAN AP	D-Link	DIR-855	KA2DIR855A2	N/A	Unshielded, 1.8 m
3.	Notebook	Lenovo	G480	N/A	N/A	AC I/P: Unshielded, 1.8 m DC O/P: Shielded, 1.8 m
4.	Bluetooth Earphone	Lenovo	LBH308	N/A	N/A	N/A

2.5 EUT Operation Test Setup

For WLAN RF test items, an engineering test program was provided and enabled to make EUT continuously transmit/receive.

For AC power line conducted emissions, the EUT was set to connect with the WLAN AP under large package sizes transmission.

2.6 Measurement Results Explanation Example

For all conducted test items:

The offset level is set in the spectrum analyzer to compensate the RF cable loss between EUT conducted output port and spectrum analyzer. With the offset compensation, the spectrum analyzer reading level is exactly the EUT RF output level.

Example :

The spectrum analyzer offset is derived from RF cable loss.

$$\text{Offset} = \text{RF cable loss.}$$

Following shows an offset computation example with cable loss 6.5 dB.

$$\begin{aligned} \text{Offset(dB)} &= \text{RF cable loss(dB)}. \\ &= 6.5 \text{ (dB)} \end{aligned}$$

3 Test Result

3.1 6dB and 26dB and 99% Occupied Bandwidth Measurement

3.1.1 Description of 6dB and 26dB and 99% Occupied Bandwidth

The minimum 6 dB bandwidth shall be at least 500 kHz.

26dB and 99% Occupied bandwidth are reporting only.

3.1.2 Measuring Instruments

The measuring equipment is listed in the section 4 of this test report.

3.1.3 Test Procedures

1. The testing follows FCC KDB 789033 D02 General UNII Test Procedures New Rules v02r01. Section C) Emission bandwidth for the band 5.725-5.85GHz
2. Set RBW = 100kHz.
3. Set the VBW $\geq 3 \times$ RBW.
4. Detector = Peak.
5. Trace mode = max hold
6. Measure the maximum width of the emission that is 6 dB down from the peak of the emission.
7. Measure and record the results in the test report.

3.1.4 Test Setup

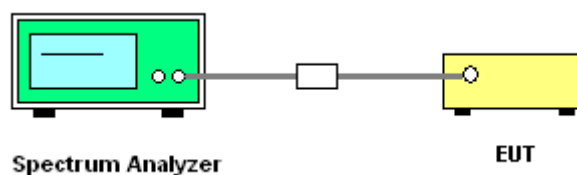



3.1.5 Test Result of 6dB Bandwidth

Please refer to Appendix A.

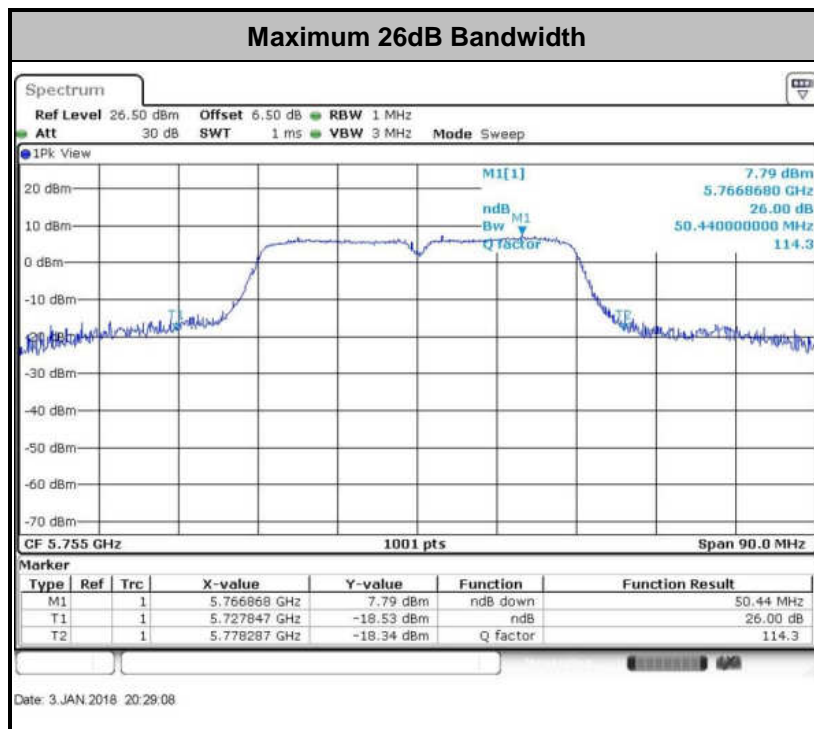
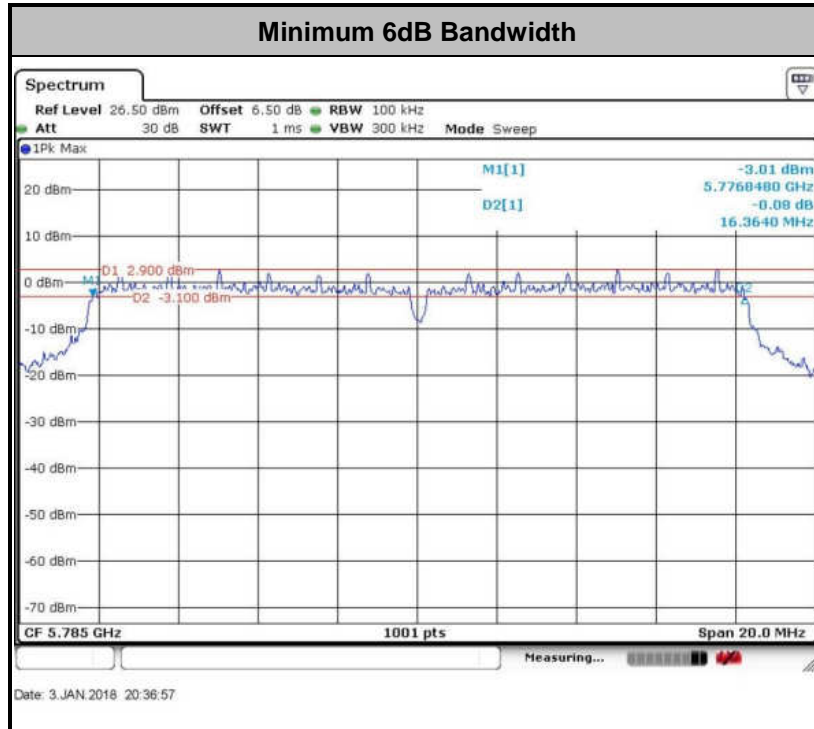

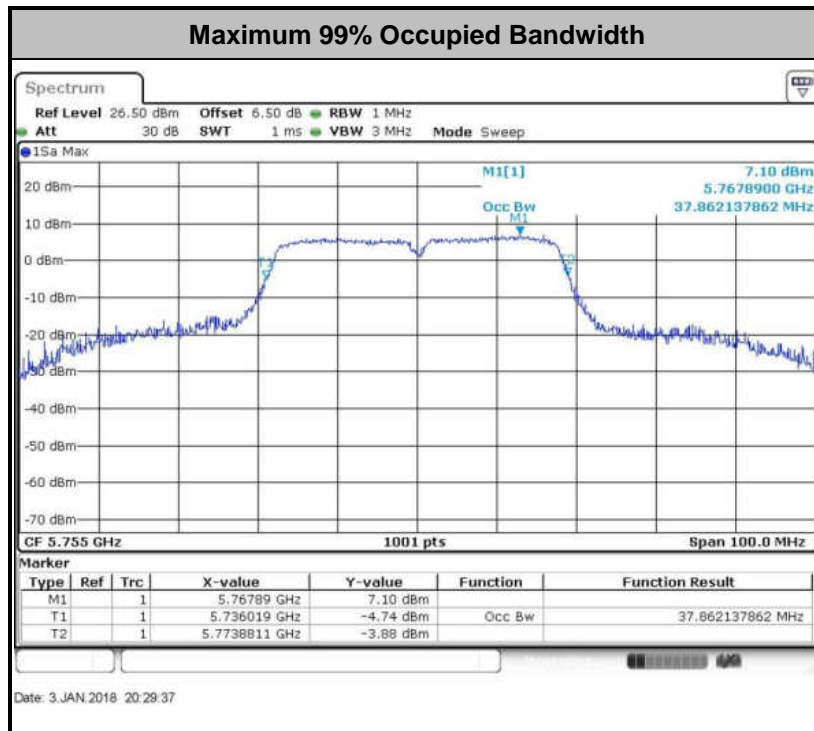

Note: The occupied channel bandwidth is maintained within the band of operation for all of the modulations.

3.2 Maximum Conducted Output Power Measurement

3.2.1 Limit of Maximum Conducted Output Power

For the band 5.725–5.85 GHz, the maximum conducted output power over the frequency band of operation shall not exceed 1 W.

If transmitting antennas of directional gain greater than 6 dBi are used, the peak output power shall be reduced by the amount in dB that the directional gain of the antenna exceeds 6 dBi.

3.2.2 Measuring Instruments

The measuring equipment is listed in the section 4 of this test report.

3.2.3 Test Procedures

The testing follows Method PM of FCC KDB 789033 D02 General UNII Test Procedures New Rules v02r01.

Method PM (Measurement using an RF average power meter):

1. Measurement is performed using a wideband RF power meter.
2. The EUT is configured to transmit continuously with a consistent duty cycle at its maximum power control level.
3. Measure the average power of the transmitter, and the average power is corrected with duty factor, $10 \log(1/x)$, where x is the duty cycle.

3.2.4 Test Setup

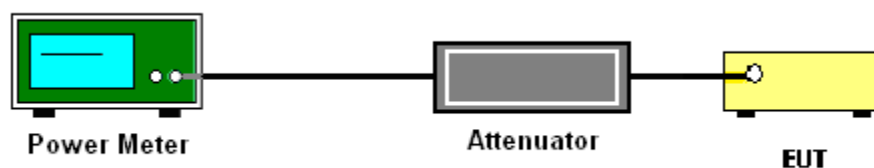

3.2.5 Test Result of Maximum Conducted Output Power

Please refer to Appendix A.



3.3 Power Spectral Density Measurement

3.3.1 Limit of Power Spectral Density

For the band 5.725–5.85 GHz, the maximum power spectral density shall not exceed 30 dBm in any 500-kHz band.

If transmitting antennas of directional gain greater than 6 dBi are used, the peak output power shall be reduced by the amount in dB that the directional gain of the antenna exceeds 6 dBi.

3.3.2 Measuring Instruments

The measuring equipment is listed in the section 4 of this test report.

3.3.3 Test Procedures

The testing follows FCC KDB 789033 D02 General UNII Test Procedures New Rules v02r01. Section F) Maximum power spectral density.

Method SA-2

(trace averaging across on and off times of the EUT transmissions, followed by duty cycle correction).

- Measure the duty cycle.
- Set span to encompass the entire emission bandwidth (EBW) of the signal.
- Set RBW = 300 kHz.
- Set VBW \geq 1 MHz.
- Number of points in sweep \geq 2 Span / RBW.
- Sweep time = auto.
- Detector = RMS
- Trace average at least 100 traces in power averaging mode.
- Add $10 \log(500\text{kHz}/\text{RBW})$ to the test result.
- Add $10 \log(1/x)$, where x is the duty cycle, to the measured power in order to compute the average power during the actual transmission times. For example, add $10 \log(1/0.25) = 6$ dB if the duty cycle is 25 percent.

1. The RF output of EUT was connected to the spectrum analyzer by a low loss cable.
2. Each plot has already offset with cable loss, and attenuator loss. Measure the PPSD and record it.

3.3.4 Test Setup

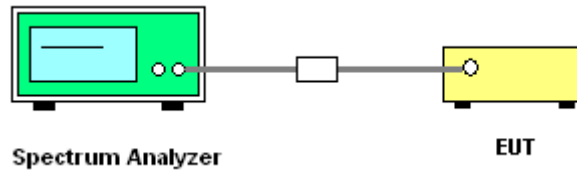



3.3.5 Test Result of Power Spectral Density

Please refer to Appendix A.

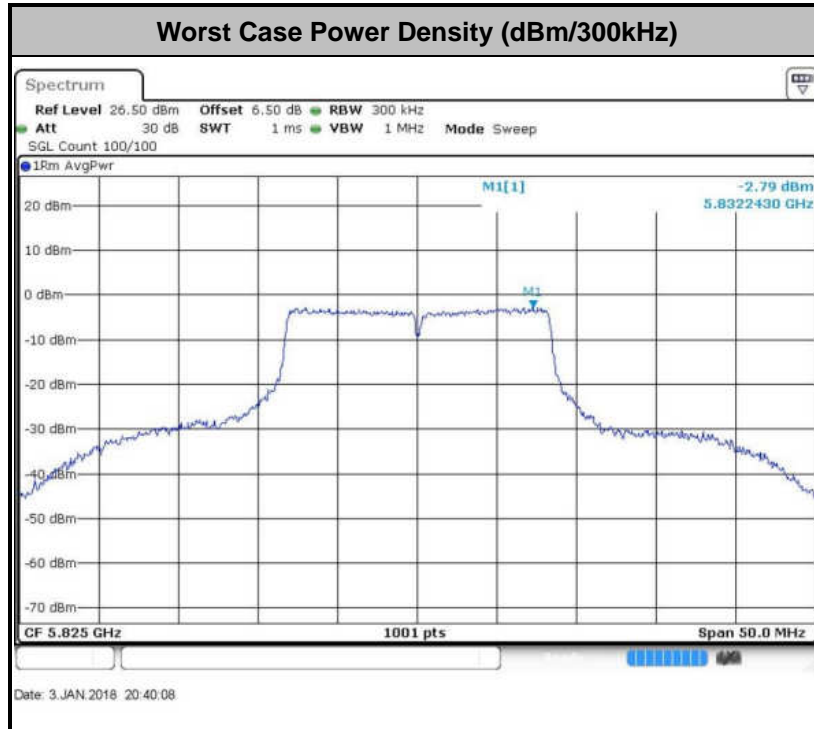



3.4 Unwanted Emissions Measurement

This section as specified in FCC Part 15.407(b) is to measure unwanted emissions through radiated measurement for band edge spurious emissions and out of band emissions measurement. The unwanted emissions shall comply with 15.407(b)(1) to (6), and restricted bands per FCC Part15.205.

3.4.1 Limit of Unwanted Emissions

- (1) For transmitters operating in the 5.725-5.85 GHz band:
15.407(b)(4)(i) All emissions shall be limited to a level of -27 dBm/MHz at 75 MHz or more above or below the band edge increasing linearly to 10 dBm/MHz at 25 MHz above or below the band edge, and from 25 MHz above or below the band edge increasing linearly to a level of 15.6 dBm/MHz at 5 MHz above or below the band edge, and from 5 MHz above or below the band edge increasing linearly to a level of 27 dBm/MHz at the band edge.
- (2) Unwanted spurious emissions fallen in restricted bands per FCC Part15.205 shall comply with the general field strength limits set forth in § 15.209 as below table,

Frequency (MHz)	Field Strength (microvolts/meter)	Measurement Distance (meters)
0.009 – 0.490	2400/F(kHz)	300
0.490 – 1.705	24000/F(kHz)	30
1.705 – 30.0	30	30
30 – 88	100	3
88 – 216	150	3
216 - 960	200	3
Above 960	500	3

Note: The following formula is used to convert the EIRP to field strength.

$$E = \frac{1000000\sqrt{30P}}{3} \mu\text{V/m, where P is the eirp (Watts)}$$



EIRP (dBm)	Field Strength at 3m (dBμV/m)
-17	78.3

(3) KDB789033 D02 v02r01 G)2)c)

- (i) Section 15.407(b)(1) to (b)(3) specify the unwanted emission limits for the U-NII-1 and U-NII-2 bands. As specified, emissions above 1000 MHz that are outside of the restricted bands are subject to a peak emission limit of -27 dBm/MHz.³
- (ii) Section 15.407(b)(4) specifies the unwanted emission limit for the U-NII-3 band. A band emissions mask is specified in Section 15.407(b)(4)(i). The emission limits are in terms of a Peak detector. An alternative to the band emissions mask is specified in Section 15.407(b)(4)(ii). The alternative limits are based on the highest antenna gain specified in the filing. There are also marketing and importation restrictions for the devices using the alternative limit.⁴

Note 3: An out-of-band emission that complies with both the average and peak limits of Section 15.209 is not required to satisfy the -27 dBm/MHz peak emission limit.

Note 4: Only devices with antenna gains of 10 dBi or less may be approved using the emission limits specified in Section 15.247(d) till March 2, 2018; all other devices operating in this band must use the mask specified in Section 15.407(b)(4)(i).



3.4.2 Measuring Instruments

The measuring equipment is listed in the section 4 of this test report.

3.4.3 Test Procedures

1. The testing follows FCC KDB 789033 D02 General UNII Test Procedures New Rules v02r01. Section G) Unwanted emissions measurement.

(1) Procedure for Unwanted Emissions Measurements Below 1000MHz

- RBW = 120 kHz
- VBW = 300 kHz
- Detector = Peak
- Trace mode = max hold

(2) Procedure for Peak Unwanted Emissions Measurements Above 1000 MHz

- RBW = 1 MHz
- VBW \geq 3 MHz
- Detector = Peak
- Sweep time = auto
- Trace mode = max hold

(3) Procedures for Average Unwanted Emissions Measurements Above 1000MHz

- RBW = 1 MHz
- VBW = 10 Hz, when duty cycle is no less than 98 percent.
- VBW \geq 1/T, when duty cycle is less than 98 percent where T is the minimum transmission duration over which the transmitter is on and is transmitting at its maximum power control level for the tested mode of operation.

2. The EUT was placed on a turntable with 0.8 meter for frequency below 1GHz and 1.5 meter for frequency above 1GHz respectively above ground.
3. The EUT was set 3 meters from the interference receiving antenna which was mounted on the top of a variable height antenna tower.
4. The antenna is a broadband antenna and its height is adjusted between one meter and four meters above ground to find the maximum value of the field strength for both horizontal polarization and vertical polarization of the antenna.
5. For each suspected emission, the EUT was arranged to its worst case and then adjust the antenna tower (from 1 m to 4 m) and turntable (from 0 degree to 360 degrees) to find the maximum reading.
6. For testing below 1GHz, if the emission level of the EUT in peak mode was 3 dB lower than the limit specified, then peak values of EUT will be reported, otherwise, the emissions will be repeated one by one using the CISPR quasi-peak method and reported.
7. For testing above 1GHz, the emission level of the EUT in peak mode was 20dB lower than average limit (that means the emission level in average mode also complies with the limit in average mode), then peak values of EUT will be reported, otherwise, the emissions will be measured in average mode again and reported.

3.4.4 Test Setup

For radiated emissions below 30MHz

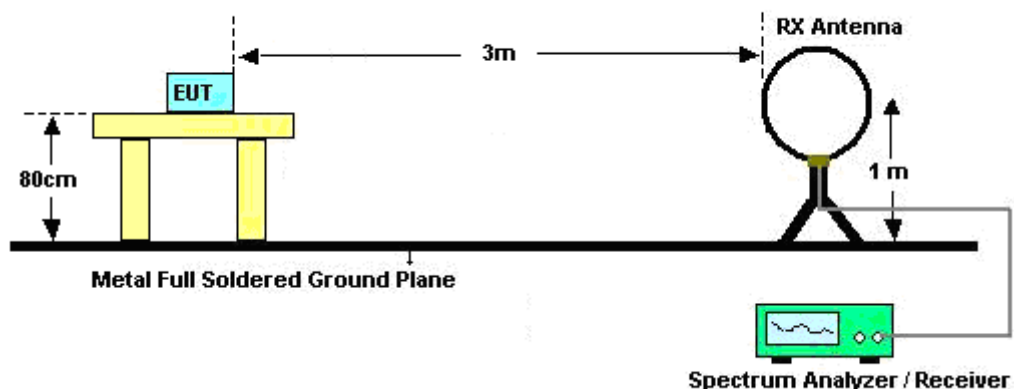

For radiated emissions from 30MHz to 1GHz

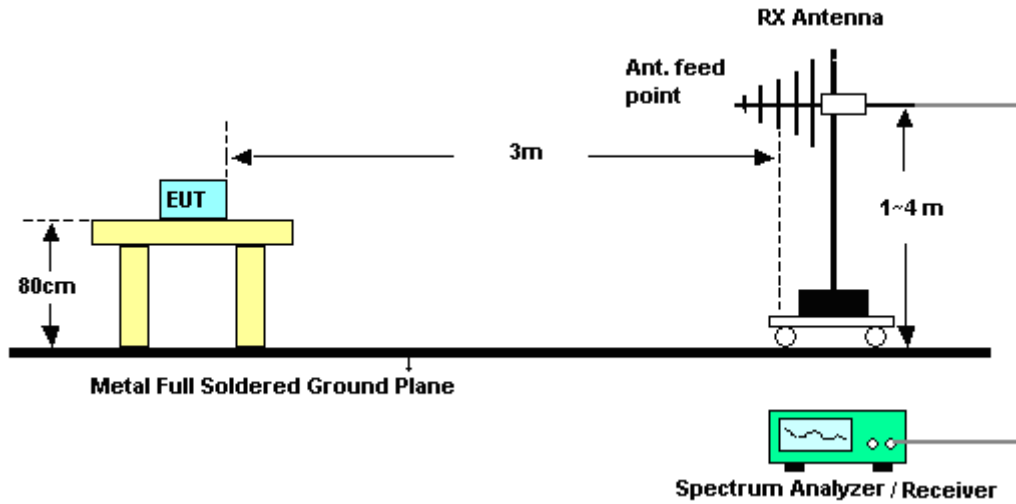

For radiated emissions above 1GHz

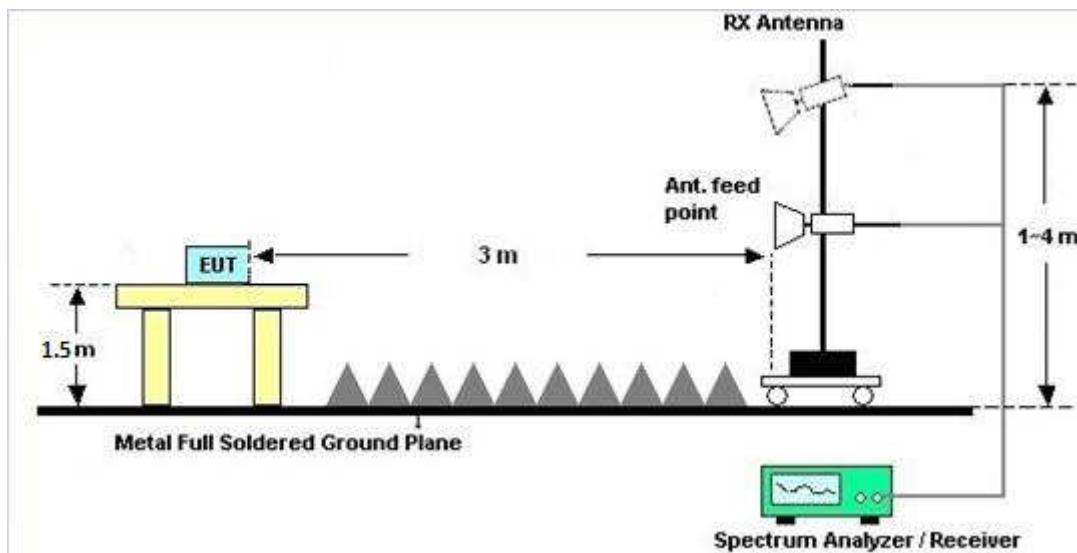



3.4.5 Test Results of Radiated Spurious Emissions (9 kHz ~ 30 MHz)

The low frequency, which started from 9 kHz to 30MHz, was pre-scanned and the result which was 20dB lower than the limit line per 15.31(o) was not reported.

3.4.6 Test Result of Radiated Spurious at Band Edges

Please refer to Appendix B.

3.4.7 Duty Cycle

Please refer to Appendix C.

3.4.8 Test Result of Radiated Spurious Emissions (30MHz ~ 10th Harmonic)

Please refer to Appendix B.



3.5 AC Conducted Emission Measurement

3.5.1 Limit of AC Conducted Emission

For equipment that is designed to be connected to the public utility (AC) power line, the radio frequency voltage that is conducted back onto the AC power line on any frequency or frequencies within the band 150 kHz to 30 MHz shall not exceed the limits in the following table.

Frequency of emission (MHz)	Conducted limit (dBµV)	
	Quasi-peak	Average
0.15-0.5	66 to 56*	56 to 46*
0.5-5	56	46
5-30	60	50

*Decreases with the logarithm of the frequency.

3.5.2 Measuring Instruments

The measuring equipment is listed in the section 4 of this test report.

3.5.3 Test Procedures

1. The EUT was placed 0.4 meter from the conducting wall of the shielding room was kept at least 80 centimeters from any other grounded conducting surface.
2. Connect EUT to the power mains through a line impedance stabilization network (LISN).
3. All the support units are connecting to the other LISN.
4. The LISN provides 50 ohm coupling impedance for the measuring instrument.
5. The FCC states that a 50 ohm, 50 microhenry LISN should be used.
6. Both sides of AC line were checked for maximum conducted interference.
7. The frequency range from 150 kHz to 30 MHz was searched.
8. Set the test-receiver system to Peak Detect Function and specified bandwidth with Maximum Hold Mode.

3.5.4 Test Setup

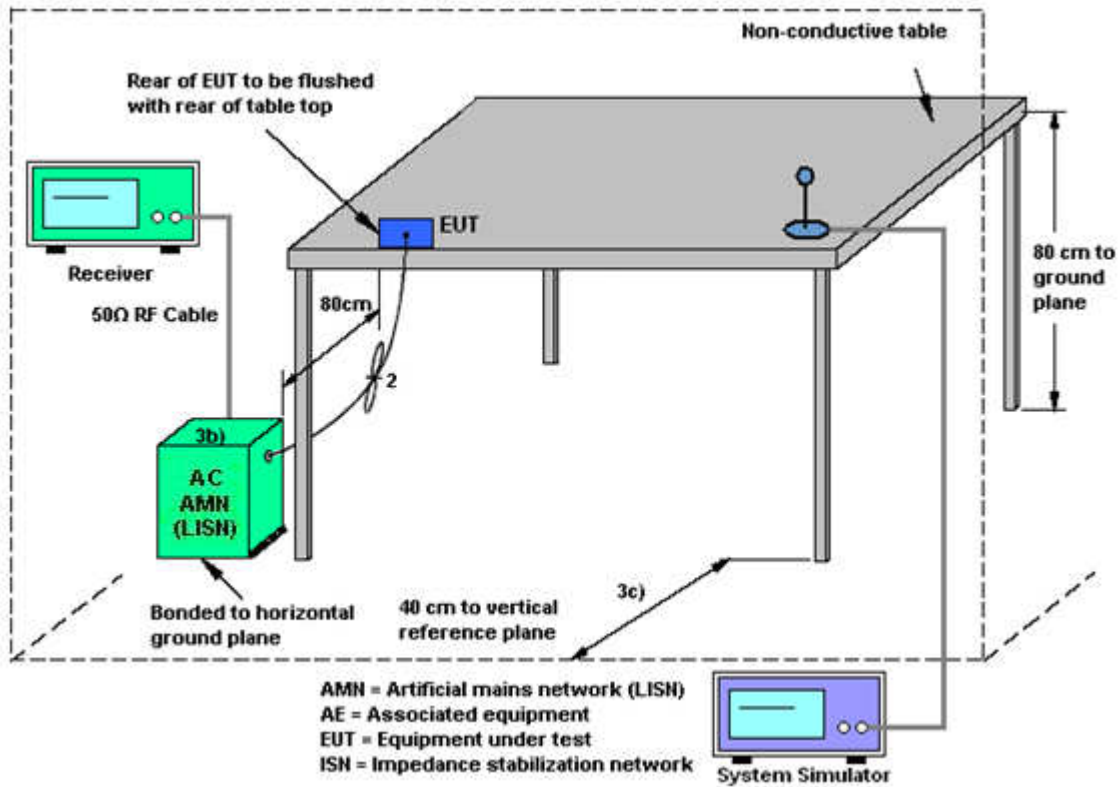



3.5.5 Test Result of AC Conducted Emission

Test Mode :	Mode 1	Temperature :	22~24°C
Test Engineer :	Amos Zhang	Relative Humidity :	42~45%
Test Voltage :	120Vac / 60Hz	Phase :	Line
Function Type :	GSM850 Idle + Bluetooth Link + WLAN Link (5G) + USB Cable (Charging from Adapter 1) + Earphone 1		

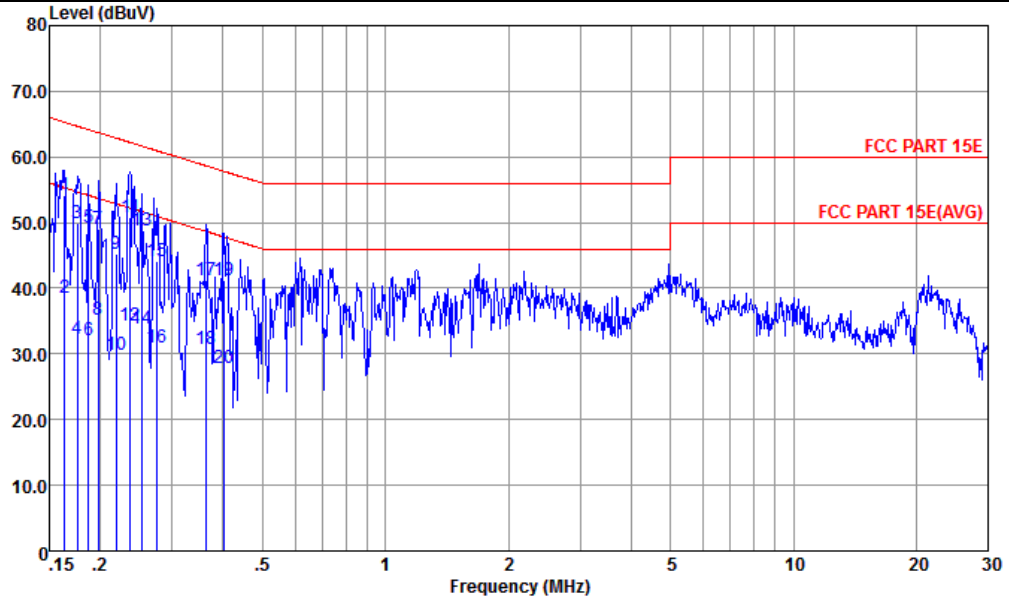

Site : CO01-KS
 Condition : FCC PART 15E LISN-L-171013-060103 LINE

mode : Mode 1
 : 351848090015253/351848090015261 #9

	Freq	Level	Over Limit	Limit Line	Read Level	LISN Factor	Cable Loss	Remark
	MHz	dBuV	dB	dBuV	dBuV	dB	dB	
1 *	0.163	54.04	-11.26	65.30	43.30	0.17	10.57	QP
2	0.163	38.54	-16.76	55.30	27.80	0.17	10.57	Average
3	0.176	49.91	-14.77	64.68	39.20	0.18	10.53	QP
4	0.176	32.31	-22.37	54.68	21.60	0.18	10.53	Average
5	0.187	49.28	-14.87	64.15	38.60	0.19	10.49	QP
6	0.187	31.98	-22.17	54.15	21.30	0.19	10.49	Average
7	0.198	48.96	-14.75	63.71	38.30	0.20	10.46	QP
8	0.198	35.16	-18.55	53.71	24.50	0.20	10.46	Average
9	0.219	45.15	-17.73	62.88	34.49	0.21	10.45	QP
10	0.219	29.95	-22.93	52.88	19.29	0.21	10.45	Average
11	0.237	50.85	-11.37	62.22	40.20	0.21	10.44	QP
12	0.237	34.25	-17.97	52.22	23.60	0.21	10.44	Average
13	0.252	48.85	-12.84	61.69	38.19	0.22	10.44	QP
14	0.252	33.95	-17.74	51.69	23.29	0.22	10.44	Average
15	0.276	44.15	-16.79	60.94	33.50	0.22	10.43	QP
16	0.276	30.95	-19.99	50.94	20.30	0.22	10.43	Average
17	0.363	41.25	-17.40	58.65	30.60	0.24	10.41	QP
18	0.363	30.85	-17.80	48.65	20.20	0.24	10.41	Average
19	0.402	41.15	-16.66	57.81	30.50	0.25	10.40	QP
20	0.402	27.95	-19.86	47.81	17.30	0.25	10.40	Average



Test Mode :	Mode 1	Temperature :	22~24°C
Test Engineer :	Amos Zhang	Relative Humidity :	42~45%
Test Voltage :	120Vac / 60Hz	Phase :	Neutral
Function Type :	GSM850 Idle + Bluetooth Link + WLAN Link (5G) + USB Cable (Charging from Adapter 1) + Earphone 1		

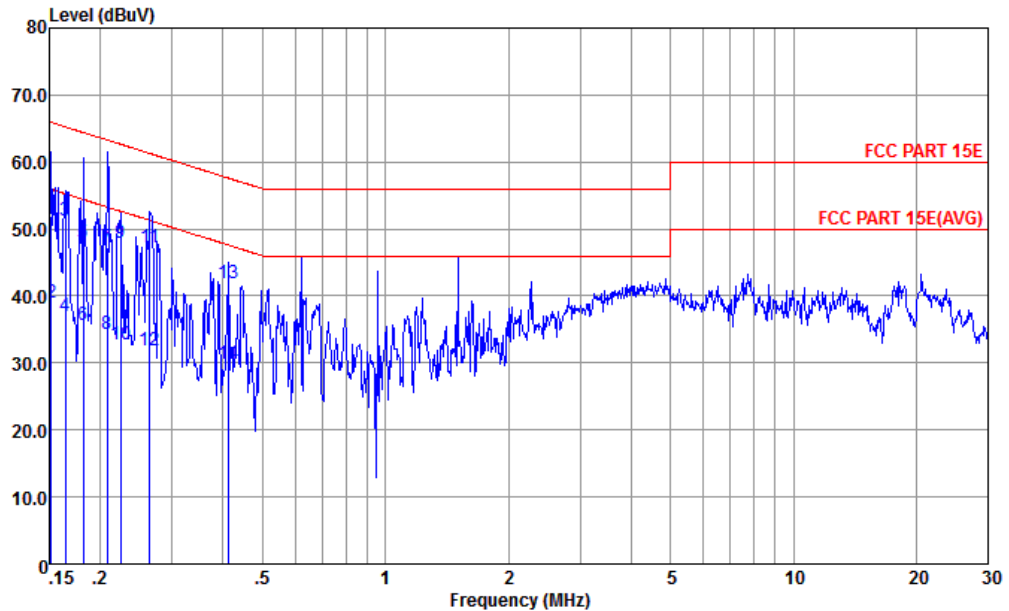

Site : CO01-KS
 Condition : FCC PART 15E LISN-N-171013-060103 NEUTRAL
 mode : Mode 1
 : 351848090015253/351848090015261 #9

	Freq	Level	Over Limit	Limit	Read	LISN	Cable	Loss	Remark
	MHz	dBuV	dB	dBuV	dBuV	dB	dB	dB	
1 *	0.152	51.99	-13.92	65.91	41.10	0.28	10.61	QP	
2	0.152	38.99	-16.92	55.91	28.10	0.28	10.61	Average	
3	0.164	51.15	-14.10	65.25	40.30	0.28	10.57	QP	
4	0.164	37.05	-18.20	55.25	26.20	0.28	10.57	Average	
5	0.182	47.99	-16.43	64.42	37.20	0.28	10.51	QP	
6	0.182	35.59	-18.83	54.42	24.80	0.28	10.51	Average	
7	0.208	47.33	-15.94	63.27	36.60	0.28	10.45	QP	
8	0.208	34.33	-18.94	53.27	23.60	0.28	10.45	Average	
9	0.224	47.93	-14.73	62.66	37.20	0.28	10.45	QP	
10	0.224	32.83	-19.83	52.66	22.10	0.28	10.45	Average	
11	0.264	47.32	-13.97	61.29	36.60	0.28	10.44	QP	
12	0.264	31.82	-19.47	51.29	21.10	0.28	10.44	Average	
13	0.413	41.88	-15.71	57.59	31.20	0.29	10.39	QP	
14	0.413	29.88	-17.71	47.59	19.20	0.29	10.39	Average	



3.6 Automatically Discontinue Transmission

3.6.1 Limit of Automatically Discontinue Transmission

The device shall automatically discontinue transmission in case of either absence of information to transmit or operational failure. These provisions are not intended to preclude the transmission of control or signaling information or the use of repetitive codes used by certain digital technologies to complete frame or burst intervals. Applicants shall include in their application for equipment authorization to describe how this requirement is met.

3.6.2 Measuring Instruments

The measuring equipment is listed in the section 4 of this test report.

3.6.3 Test Result of Automatically Discontinue Transmission

While the EUT is not transmitting any information, the EUT can automatically discontinue transmission and become standby mode for power saving. The EUT can detect the controlling signal of ACK message transmitting from remote device and verify whether it shall resend or discontinue transmission.



3.7 Antenna Requirements

3.7.1 Standard Applicable

According to FCC 47 CFR Section 15.407(a)(1)(2) ,if transmitting antenna directional gain is greater than 6 dBi, both the peak transmit power and the peak power spectral density shall be reduced by the amount in dB that the directional gain of the antenna exceeds 6 dBi.

3.7.2 Antenna Anti-Replacement Construction

An embedded-in antenna design is used.

3.7.3 Antenna Gain

The antenna gain is less than 6 dBi. Therefore, it is not necessary to reduce maximum peak output power limit.



4 List of Measuring Equipment

Instrument	Manufacturer	Model No.	Serial No.	Characteristics	Calibration Date	Test Date	Due Date	Remark
Spectrum Analyzer	R&S	FSV40	101040	10Hz~40GHz	Aug. 08, 2017	Jan. 03, 2018	Aug. 07, 2018	Conducted (TH01-KS)
Pulse Power Sensor	Anritsu	MA2411B	0917070	300MHz~40GHz	Jan. 19, 2017	Jan. 03, 2018	Jan. 18, 2018	Conducted (TH01-KS)
Power Meter	Anritsu	ML2495A	1005002	50MHz Bandwidth	Jan. 19, 2017	Jan. 03, 2018	Jan. 18, 2018	Conducted (TH01-KS)
EMI Test Receiver	Keysight	N9038A	MY56400004	3Hz~8.5GHz; Max 30dBm	Oct. 19, 2017	Feb. 02, 2018	Oct. 18, 2018	Radiation (03CH03-KS)
EXA Spectrum Analyzer	Keysight	N9010A	MY55150244	10Hz~44GHz	Apr. 18, 2017	Feb. 02, 2018	Apr. 17, 2018	Radiation (03CH03-KS)
Loop Antenna	R&S	HFH2-Z2	100321	9kHz~30MHz	Oct. 22, 2017	Feb. 02, 2018	Oct. 21, 2018	Radiation (03CH03-KS)
Bilog Antenna	TeseQ	CBL6112D	35406	25MHz~2GHz	Apr. 22, 2017	Feb. 02, 2018	Apr. 21, 2018	Radiation (03CH03-KS)
Double Ridge Horn Antenna	ETS-Lindgren	3117	75957	1GHz~18GHz	Oct. 21, 2017	Feb. 02, 2018	Oct. 20, 2018	Radiation (03CH03-KS)
SHF-EHF Horn	Schwarzbeck	BBHA 9170	BBHA170249	15GHz~40GHz	Feb. 15, 2017	Feb. 02, 2018	Feb. 14, 2018	Radiation (03CH03-KS)
Amplifier	com-power	PA-103A	161069	1MHz~1000MHz / 32 dB	Apr. 18, 2017	Feb. 02, 2018	Apr. 17, 2018	Radiation (03CH03-KS)
Amplifier	MITEQ	TTA1840-35-HG	1887435	18GHz~40GHz	Oct. 12, 2017	Feb. 02, 2018	Oct. 11, 2018	Radiation (03CH03-KS)
high gain Amplifier	MITEQ	AMF-7D-0010 1800-30-10P	2025788	1GHz~18GHz	Apr. 18, 2017	Feb. 02, 2018	Apr. 17, 2018	Radiation (03CH03-KS)
Amplifier	Agilent	8449B	3008A02370	1GHz~26.5GHz	Oct. 12, 2017	Feb. 02, 2018	Oct. 11, 2018	Radiation (03CH03-KS)
AC Power Source	Chroma	61601	F104090004	N/A	NCR	Feb. 02, 2018	NCR	Radiation (03CH03-KS)
Turn Table	ChamPro	EM 1000-T	060762-T	0~360 degree	NCR	Feb. 02, 2018	NCR	Radiation (03CH03-KS)
Antenna Mast	ChamPro	EM 1000-A	060762-A	1 m~4 m	NCR	Feb. 02, 2018	NCR	Radiation (03CH03-KS)
EMI Receiver	R&S	ESC17	100768	9kHz~7GHz;	Apr. 20, 2017	Feb. 01, 2018	Apr. 19, 2018	Conduction (CO01-KS)
AC LISN	MessTec	AN3016	060103	9kHz~30MHz	Oct. 13, 2017	Feb. 01, 2018	Oct. 12, 2018	Conduction (CO01-KS)
AC LISN (for auxiliary equipment)	MessTec	AN3016	060105	9kHz~30MHz	Oct. 13, 2017	Feb. 01, 2018	Oct. 12, 2018	Conduction (CO01-KS)
AC Power Source	Chroma	61602	ABP0000008 11	AC 0V~300V, 45Hz~1000Hz	Oct. 12, 2017	Feb. 01, 2018	Oct. 11, 2018	Conduction (CO01-KS)

NCR: No Calibration Required



5 Uncertainty of Evaluation

Uncertainty of Conducted Emission Measurement (150kHz ~ 30MHz)

Measuring Uncertainty for a Level of Confidence of 95% ($U = 2Uc(y)$)	2.3dB
---	-------

Uncertainty of Radiated Emission Measurement (30 MHz ~ 1000 MHz)

Measuring Uncertainty for a Level of Confidence of 95% ($U = 2Uc(y)$)	4.6dB
---	-------

Uncertainty of Radiated Emission Measurement (1000 MHz ~ 18000 MHz)

Measuring Uncertainty for a Level of Confidence of 95% ($U = 2Uc(y)$)	4.5dB
---	-------

Uncertainty of Radiated Emission Measurement (18000 MHz ~ 40000 MHz)

Measuring Uncertainty for a Level of Confidence of 95% ($U = 2Uc(y)$)	4.5dB
---	-------



Appendix A. Conducted Test Results

Test Engineer:	Start Xu	Temperature:	21~25	°C
Test Date:	2018/1/3	Relative Humidity:	51~54	%

TEST RESULTS DATA
6dB and 26dB EBW and 99% OBW

Band IV									
Mod.	Data Rate	N _{TX}	CH.	Freq. (MHz)	99% Bandwidth (MHz)	26 dB Bandwidth (MHz)	6 dB Bandwidth (MHz)	6dB Bandwidth min. Limit (MHz)	Pass/Fail
11a	6M bps	1	149	5745	19.98	37.21	16.38	0.5	Pass
11a	6Mbps	1	157	5785	21.53	36.71	16.36	0.5	Pass
11a	6Mbps	1	165	5825	21.78	36.96	16.36	0.5	Pass
HT20	MCS 0	1	149	5745	22.48	40.91	17.58	0.5	Pass
HT20	MCS 0	1	157	5785	21.28	39.71	17.58	0.5	Pass
HT20	MCS 0	1	165	5825	21.68	39.01	17.60	0.5	Pass
HT40	MCS 0	1	151	5755	37.86	50.44	35.12	0.5	Pass
HT40	MCS 0	1	159	5795	37.56	50.08	35.16	0.5	Pass

TEST RESULTS DATA
Average Power Table

Band IV										
Mod.	Data Rate	N _{TX}	CH.	Freq. (MHz)	Duty Factor (dB)	Average Conducted Power (dBm)	FCC Conducted Power Limit (dBm)	DG (dBi)		Pass/Fail
11a	6M bps	1	149	5745	0.58	14.54	30.00	-1.80		Pass
11a	6Mbps	1	157	5785	0.58	15.31	30.00	-1.80		Pass
11a	6Mbps	1	165	5825	0.58	14.82	30.00	-1.80		Pass
HT20	MCS 0	1	149	5745	0.63	14.52	30.00	-1.80		Pass
HT20	MCS 0	1	157	5785	0.63	15.28	30.00	-1.80		Pass
HT20	MCS 0	1	165	5825	0.63	14.78	30.00	-1.80		Pass
HT40	MCS 0	1	151	5755	0.65	13.43	30.00	-1.80		Pass
HT40	MCS 0	1	159	5795	0.65	13.94	30.00	-1.80		Pass

TEST RESULTS DATA
Power Spectral Density

Band IV										
Mod.	Data Rate	NTX	CH.	Freq. (MHz)	Duty Factor (dB)	10log (500kHz /RBW) Factor (dB)	Average Power Density (dBm/500kHz)	Average PSD Limit (dBm/500kHz)	DG (dBi)	Pass/Fail
11a	6M bps	1	149	5745	0.58	2.22	-0.77	30.00	-1.80	Pass
11a	6Mbps	1	157	5785	0.58	2.22	-0.05	30.00	-1.80	Pass
11a	6Mbps	1	165	5825	0.58	2.22	0.01	30.00	-1.80	Pass
HT20	MCS 0	1	149	5745	0.63	2.22	-0.85	30.00	-1.80	Pass
HT20	MCS 0	1	157	5785	0.63	2.22	-0.09	30.00	-1.80	Pass
HT20	MCS 0	1	165	5825	0.63	2.22	-0.14	30.00	-1.80	Pass
HT40	MCS 0	1	151	5755	0.65	2.22	-3.81	30.00	-1.80	Pass
HT40	MCS 0	1	159	5795	0.65	2.22	-4.32	30.00	-1.80	Pass



Appendix B. Radiated Spurious Emission

Band 4 - 5725~5850MHz WIFI 802.11a (Band Edge @ 3m)

WIFI	Note	Frequency	Level	Over Limit	Limit Line	Read Level	Antenna Factor	Cable Loss	Preamp Factor	Ant Pos	Table Pos	Peak Avg.	Pol.
		(MHz)	(dBμV/m)	(dB)	(dBμV/m)	(dBμV)	(dB/m)	(dB)	(dB)	(cm)	(deg)	(P/A)	(H/V)
802.11a CH 149 5745MHz		5641.2	52.76	-15.54	68.3	41.56	35.4	12.48	36.68	100	354	P	H
		5674.4	54.18	-32.22	86.4	42.93	35.45	12.52	36.72	100	354	P	H
		5719.6	65.16	-45.63	110.79	53.88	35.52	12.57	36.81	100	354	P	H
		5723.2	73.18	-45.02	118.2	61.9	35.52	12.57	36.81	100	354	P	H
		5750	103.24	-	-	91.96	35.54	12.59	36.85	100	354	P	H
		5750	95.78	-	-	84.5	35.54	12.59	36.85	100	354	A	H
		5614	52.09	-16.21	68.3	40.95	35.38	12.44	36.68	310	28	P	V
		5697.6	52.53	-51	103.53	41.3	35.47	12.53	36.77	310	28	P	V
		5719.99	57.88	-53.02	110.9	46.6	35.52	12.57	36.81	310	28	P	V
		5724	66.64	-53.38	120.02	55.36	35.52	12.57	36.81	310	28	P	V
		5740	97.85	-	-	86.57	35.54	12.59	36.85	310	28	P	V
		5740	90.91	-	-	79.63	35.54	12.59	36.85	310	28	A	V



WIFI	Note	Frequency (MHz)	Level (dBμV/m)	Over Limit (dB)	Limit Line (dBμV/m)	Read Level (dBμV)	Antenna Factor (dB/m)	Cable Loss (dB)	Preamp Factor (dB)	Ant Pos (cm)	Table Pos (deg)	Peak Avg. (P/A)	Pol. (H/V)
802.11a CH 157 5785MHz		5628.4	53.31	-14.99	68.3	42.14	35.39	12.46	36.68	100	337	P	H
		5652.4	52.68	-17.4	70.08	41.44	35.42	12.5	36.68	100	337	P	H
		5703.6	53.69	-52.62	106.31	42.42	35.49	12.55	36.77	100	337	P	H
		5724	51.16	-68.86	120.02	39.88	35.52	12.57	36.81	100	337	P	H
		5780	101.79	-	-	90.49	35.58	12.62	36.9	100	337	P	H
		5780	94.2	-	-	82.9	35.58	12.62	36.9	100	337	A	H
		5852.8	51.87	-64.05	115.92	40.53	35.68	12.69	37.03	100	337	P	H
		5869.6	53.12	-53.69	106.81	41.73	35.7	12.71	37.02	100	337	P	H
		5904.4	53.12	-30.39	83.51	41.66	35.71	12.75	37	100	337	P	H
		5961.6	53.37	-14.93	68.3	41.79	35.72	12.82	36.96	100	337	P	H
		5636.4	53.02	-15.28	68.3	41.82	35.4	12.48	36.68	280	32	P	V
		5657.2	52.98	-20.67	73.65	41.78	35.42	12.5	36.72	280	32	P	V
		5707.6	52.62	-54.81	107.43	41.39	35.49	12.55	36.81	280	32	P	V
		5722.8	51.79	-65.49	117.28	40.51	35.52	12.57	36.81	280	32	P	V
		5790	100.88	-	-	89.57	35.61	12.64	36.94	280	32	P	V
		5790	93.81	-	-	82.5	35.61	12.64	36.94	280	32	A	V
		5850.01	51.35	-70.93	122.28	40.01	35.68	12.69	37.03	280	32	P	V
		5861.6	51.92	-57.13	109.05	40.53	35.7	12.71	37.02	280	32	P	V
	5902.4	54.32	-30.67	84.99	42.86	35.71	12.75	37	280	32	P	V	
	5960	53.22	-15.08	68.3	41.64	35.72	12.82	36.96	280	32	P	V	



WIFI	Note	Frequency (MHz)	Level (dBμV/m)	Over Limit (dB)	Limit Line (dBμV/m)	Read Level (dBμV)	Antenna Factor (dB/m)	Cable Loss (dB)	Preamp Factor (dB)	Ant Pos (cm)	Table Pos (deg)	Peak Avg. (P/A)	Pol. (H/V)
802.11a CH 165 5825MHz		5830	101.25	-	-	89.92	35.65	12.67	36.99	390	326	P	H
		5830	93.81	-	-	82.48	35.65	12.67	36.99	390	326	A	H
		5850.8	62.33	-58.15	120.48	50.99	35.68	12.69	37.03	390	326	P	H
		5857.6	57.12	-53.05	110.17	45.74	35.7	12.71	37.03	390	326	P	H
		5900	52.33	-34.43	86.76	40.87	35.71	12.75	37	390	326	P	H
		5938.8	53.45	-14.85	68.3	41.9	35.72	12.8	36.97	390	326	P	H
		5832	98.77	-	-	87.44	35.65	12.67	36.99	275	26	P	V
		5832	91.21	-	-	79.88	35.65	12.67	36.99	275	26	A	V
		5851.2	60.3	-59.26	119.56	48.96	35.68	12.69	37.03	275	26	P	V
		5856.4	58.16	-52.35	110.51	46.78	35.7	12.71	37.03	275	26	P	V
		5917.2	53.72	-20.33	74.05	42.24	35.71	12.76	36.99	275	26	P	V
		5932.8	52.92	-15.38	68.3	41.41	35.72	12.78	36.99	275	26	P	V
Remark	<ol style="list-style-type: none"> No other spurious found. All results are PASS against Peak and Average limit line. 												



Band 4 5725~5850MHz

WIFI 802.11a (Harmonic @ 3m)

WIFI	Note	Frequency (MHz)	Level (dBμV/m)	Over Limit (dB)	Limit Line (dBμV/m)	Read Level (dBμV)	Antenna Factor (dB/m)	Cable Loss (dB)	Preamp Factor (dB)	Ant Pos (cm)	Table Pos (deg)	Peak Avg. (P/A)	Pol. (H/V)
802.11a CH 149 5745MHz		11490	47.26	-26.74	74	57.79	38.69	16.13	65.35	300	360	P	H
		11490	46.02	-27.98	74	56.55	38.69	16.13	65.35	300	360	P	V
802.11a CH 157 5785MHz		11570	47.33	-26.67	74	57.77	38.78	16.22	65.44	300	360	P	H
		11570	47.2	-26.8	74	57.64	38.78	16.22	65.44	300	360	P	V
802.11a CH 165 5825MHz		11650	45.15	-28.85	74	55.53	38.87	16.29	65.54	300	360	P	H
		11650	44.84	-29.16	74	55.22	38.87	16.29	65.54	300	360	P	V
Remark	1. No other spurious found. 2. All results are PASS against Peak and Average limit line.												



Band 4 5725~5850MHz
WIFI 802.11n HT20 (Band Edge @ 3m)

Table with 14 columns: WIFI, Note, Frequency (MHz), Level (dBµV/m), Over Limit (dB), Limit Line (dBµV/m), Read Level (dBµV), Antenna Factor (dB/m), Cable Loss (dB), Preamp Factor (dB), Ant Pos (cm), Table Pos (deg), Peak Avg. (P/A), Pol. (H/V). Rows include data for 802.11n HT20 and CH 149 5745MHz.



WIFI	Note	Frequency (MHz)	Level (dBμV/m)	Over Limit (dB)	Limit Line (dBμV/m)	Read Level (dBμV)	Antenna Factor (dB/m)	Cable Loss (dB)	Preamp Factor (dB)	Ant Pos (cm)	Table Pos (deg)	Peak Avg. (P/A)	Pol. (H/V)
802.11n HT20 CH 157 5785MHz		5641.2	53.71	-14.59	68.3	42.51	35.4	12.48	36.68	302	30	P	H
		5694.4	53.9	-47.27	101.17	42.67	35.47	12.53	36.77	302	30	P	H
		5712.4	53.76	-55.01	108.77	42.53	35.49	12.55	36.81	302	30	P	H
		5723.6	53.59	-65.52	119.11	42.31	35.52	12.57	36.81	302	30	P	H
		5790	104.73	-	-	93.42	35.61	12.64	36.94	302	30	P	H
		5790	97.57	-	-	86.26	35.61	12.64	36.94	302	30	A	H
		5852	52.66	-65.08	117.74	41.32	35.68	12.69	37.03	302	30	P	H
		5871.6	53.55	-52.7	106.25	42.14	35.7	12.73	37.02	302	30	P	H
		5883.6	53.94	-44.97	98.91	42.51	35.7	12.73	37	302	30	P	H
		5966.4	53.59	-14.71	68.3	42.01	35.72	12.82	36.96	302	30	P	H
		5630.8	54.26	-14.04	68.3	43.09	35.39	12.46	36.68	299	31	P	V
		5683.2	53.14	-39.76	92.9	41.94	35.45	12.52	36.77	299	31	P	V
		5716.4	52.63	-57.26	109.89	41.4	35.49	12.55	36.81	299	31	P	V
		5721.6	52.8	-61.75	114.55	41.52	35.52	12.57	36.81	299	31	P	V
		5790	102.54	-	-	91.23	35.61	12.64	36.94	299	31	P	V
		5790	95.15	-	-	83.84	35.61	12.64	36.94	299	31	A	V
		5851.2	54.27	-65.29	119.56	42.93	35.68	12.69	37.03	299	31	P	V
		5855.01	53.56	-57.34	110.9	42.18	35.7	12.71	37.03	299	31	P	V
	5914.4	53.23	-22.89	76.12	41.75	35.71	12.76	36.99	299	31	P	V	
	5942	54.22	-14.08	68.3	42.67	35.72	12.8	36.97	299	31	P	V	



WIFI	Note	Frequency (MHz)	Level (dBμV/m)	Over Limit (dB)	Limit Line (dBμV/m)	Read Level (dBμV)	Antenna Factor (dB/m)	Cable Loss (dB)	Preamp Factor (dB)	Ant Pos (cm)	Table Pos (deg)	Peak Avg. (P/A)	Pol. (H/V)
802.11n HT20 CH 165 5825MHz		5818	103.03	-	-	91.73	35.63	12.66	36.99	100	333	P	H
		5818	95.68	-	-	84.38	35.63	12.66	36.99	100	333	A	H
		5850.01	69.33	-52.95	122.28	57.99	35.68	12.69	37.03	100	333	P	H
		5859.2	62.23	-47.49	109.72	50.84	35.7	12.71	37.02	100	333	P	H
		5880.8	53.35	-47.64	100.99	41.94	35.7	12.73	37.02	100	333	P	H
		5950	53	-15.3	68.3	41.45	35.72	12.8	36.97	100	333	P	H
		5830	99.92	-	-	88.59	35.65	12.67	36.99	307	20	P	V
		5830	92.36	-	-	81.03	35.65	12.67	36.99	307	20	A	V
		5850.01	66.7	-55.58	122.28	55.36	35.68	12.69	37.03	307	20	P	V
		5855.2	58.91	-51.93	110.84	47.53	35.7	12.71	37.03	307	20	P	V
		5894	53.89	-37.31	91.2	42.43	35.71	12.75	37	307	20	P	V
	5948.4	53.83	-14.47	68.3	42.28	35.72	12.8	36.97	307	20	P	V	
Remark	<ol style="list-style-type: none"> No other spurious found. All results are PASS against Peak and Average limit line. 												



Band 4 5725~5850MHz
WIFI 802.11n HT20 (Harmonic @ 3m)

WIFI	Note	Frequency (MHz)	Level (dBμV/m)	Over Limit (dB)	Limit Line (dBμV/m)	Read Level (dBμV)	Antenna Factor (dB/m)	Cable Loss (dB)	Preamp Factor (dB)	Ant Pos (cm)	Table Pos (deg)	Peak Avg. (P/A)	Pol. (H/V)
802.11n HT20 CH 149 5745MHz		11490	44.59	-29.41	74	55.12	38.69	16.13	65.35	100	360	P	H
													V
802.11n HT20 CH 157 5785MHz		11570	43.86	-30.14	74	54.3	38.78	16.22	65.44	100	360	P	H
		11570	44.32	-29.68	74	54.76	38.78	16.22	65.44	100	360	P	V
802.11n HT20 CH 165 5825MHz		11650	44.35	-29.65	74	54.73	38.87	16.29	65.54	100	360	P	H
		11650	43.61	-30.39	74	53.99	38.87	16.29	65.54	100	360	P	V
Remark	1. No other spurious found. 2. All results are PASS against Peak and Average limit line.												



Band 4 5725~5850MHz

WIFI 802.11n HT40 (Band Edge @ 3m)

WIFI	Note	Frequency (MHz)	Level (dBμV/m)	Over Limit (dB)	Limit Line (dBμV/m)	Read Level (dBμV)	Antenna Factor (dB/m)	Cable Loss (dB)	Preamp Factor (dB)	Ant Pos (cm)	Table Pos (deg)	Peak Avg. (P/A)	Pol. (H/V)
802.11n HT40 CH 151 5755MHz		5635.6	52.87	-15.43	68.3	41.67	35.4	12.48	36.68	300	31	P	H
		5698	56.84	-46.99	103.83	45.61	35.47	12.53	36.77	300	31	P	H
		5717.2	71.98	-38.14	110.12	60.75	35.49	12.55	36.81	300	31	P	H
		5721.2	73.83	-39.81	113.64	62.55	35.52	12.57	36.81	300	31	P	H
		5766	98.95	-	-	87.69	35.56	12.6	36.9	300	31	P	H
		5766	91.88	-	-	80.62	35.56	12.6	36.9	300	31	A	H
		5854.8	52.23	-59.13	111.36	40.85	35.7	12.71	37.03	300	31	P	H
		5855.01	52.23	-58.67	110.9	40.85	35.7	12.71	37.03	300	31	P	H
		5882.4	52.76	-47.04	99.8	41.35	35.7	12.73	37.02	300	31	P	H
		5972.4	52.82	-15.48	68.3	41.24	35.72	12.82	36.96	300	31	P	H
		5610	52.25	-16.05	68.3	41.11	35.38	12.44	36.68	100	332	P	V
		5696.8	55.18	-47.76	102.94	43.95	35.47	12.53	36.77	100	332	P	V
		5717.6	65.48	-44.75	110.23	54.2	35.52	12.57	36.81	100	332	P	V
		5724.4	67.86	-53.07	120.93	56.58	35.52	12.57	36.81	100	332	P	V
		5766	94.94	-	-	83.68	35.56	12.6	36.9	100	332	P	V
		5766	86.88	-	-	75.62	35.56	12.6	36.9	100	332	A	V
		5851.6	51.91	-66.74	118.65	40.57	35.68	12.69	37.03	100	332	P	V
		5871.6	52.35	-53.9	106.25	40.94	35.7	12.73	37.02	100	332	P	V
	5888.4	51.98	-43.37	95.35	40.52	35.71	12.75	37	100	332	P	V	
	5951.6	52.51	-15.79	68.3	40.96	35.72	12.8	36.97	100	332	P	V	



WIFI	Note	Frequency (MHz)	Level (dBμV/m)	Over Limit (dB)	Limit Line (dBμV/m)	Read Level (dBμV)	Antenna Factor (dB/m)	Cable Loss (dB)	Preamp Factor (dB)	Ant Pos (cm)	Table Pos (deg)	Peak Avg. (P/A)	Pol. (H/V)
802.11n HT40 CH 159 5795MHz		5618	52.15	-16.15	68.3	40.98	35.39	12.46	36.68	300	27	P	H
		5668	53.27	-28.39	81.66	42.02	35.45	12.52	36.72	300	27	P	H
		5716	53.51	-56.27	109.78	42.28	35.49	12.55	36.81	300	27	P	H
		5722.8	53.96	-63.32	117.28	42.68	35.52	12.57	36.81	300	27	P	H
		5780	98.38	-	-	87.08	35.58	12.62	36.9	300	27	P	H
		5780	91.23	-	-	79.93	35.58	12.62	36.9	300	27	A	H
		5852	57.19	-60.55	117.74	45.85	35.68	12.69	37.03	300	27	P	H
		5858.4	57.67	-52.28	109.95	46.28	35.7	12.71	37.02	300	27	P	H
		5882.4	53.06	-46.74	99.8	41.65	35.7	12.73	37.02	300	27	P	H
		5928.4	53.28	-15.02	68.3	41.77	35.72	12.78	36.99	300	27	P	H
		5617.2	52.63	-15.67	68.3	41.46	35.39	12.46	36.68	300	23	P	V
		5696.8	53	-49.94	102.94	41.77	35.47	12.53	36.77	300	23	P	V
		5718.4	51.83	-58.62	110.45	40.55	35.52	12.57	36.81	300	23	P	V
		5724.8	51.81	-70.03	121.84	40.53	35.52	12.57	36.81	300	23	P	V
		5786	94.33	-	-	83.02	35.61	12.64	36.94	300	23	P	V
		5786	87.08	-	-	75.77	35.61	12.64	36.94	300	23	A	V
		5853.6	58.71	-55.38	114.09	47.33	35.7	12.71	37.03	300	23	P	V
		5863.6	58.58	-49.91	108.49	47.19	35.7	12.71	37.02	300	23	P	V
	5887.6	53.13	-42.82	95.95	41.67	35.71	12.75	37	300	23	P	V	
	5939.6	52.96	-15.34	68.3	41.41	35.72	12.8	36.97	300	23	P	V	
Remark	1. No other spurious found. 2. All results are PASS against Peak and Average limit line.												



Band 4 5725~5850MHz
WIFI 802.11n HT40 (Harmonic @ 3m)

Table with 14 columns: WIFI, Note, Frequency (MHz), Level (dBµV/m), Over Limit (dB), Limit Line (dBµV/m), Read Level (dBµV), Antenna Factor (dB/m), Cable Loss (dB), Preamp Factor (dB), Ant Pos (cm), Table Pos (deg), Peak Avg. (P/A), Pol. (H/V). Rows include data for 802.11n HT40 CH 151 and CH 159 at 5755MHz and 5795MHz, and a Remark section.



Band 4 5725~5850MHz

Emission below 1GHz

5GHz WIFI 802.11n HT20 (LF @ 3m)

WIFI	Note	Frequency	Level	Over Limit	Limit Line	Read Level	Antenna Factor	Cable Loss	Preamp Factor	Ant Pos	Table Pos	Peak Avg.	Pol.
		(MHz)	(dBμV/m)	(dB)	(dBμV/m)	(dBμV)	(dB/m)	(dB)	(dB)	(cm)	(deg)	(P/A)	(H/V)
5GHz 802.11n HT20 LF		34.85	31.2	-8.8	40	36.95	25.7	0.85	32.3	200	32	P	H
		81.41	26.02	-13.98	40	41.3	15.66	1.31	32.25	-	-	P	H
		180.35	29.33	-14.17	43.5	42.43	17.2	1.97	32.27	-	-	P	H
		185.2	28.75	-14.75	43.5	41.87	17.15	2	32.27	-	-	P	H
		200.72	29.63	-13.87	43.5	42.8	17	2.09	32.26	-	-	P	H
		212.36	30.98	-12.52	43.5	44.01	17.05	2.14	32.22	-	-	P	H
		35.82	32	-8	40	38.21	25.2	0.87	32.28	-	-	P	V
		53.28	32.53	-7.47	40	47.86	15.84	1.07	32.24	-	-	P	V
		58.13	33.72	-6.28	40	50.19	14.64	1.1	32.21	100	95	P	V
		64.92	29.85	-10.15	40	48.03	12.9	1.18	32.26	-	-	P	V
		80.44	27.32	-12.68	40	42.76	15.5	1.31	32.25	-	-	P	V
	699.3	27.07	-18.93	46	26.78	27.95	4.02	31.68	-	-	P	V	
Remark	1. No other spurious found. 2. All results are PASS against limit line.												



Note symbol

*	Fundamental Frequency which can be ignored. However, the level of any unwanted emissions shall not exceed the level of the fundamental frequency.
!	Test result is over limit line.
P/A	Peak or Average
H/V	Horizontal or Vertical



A calculation example for radiated spurious emission is shown as below:

WIFI	Note	Frequency	Level	Over	Limit	Read	Antenna	Cable	Preamp	Ant	Table	Peak	Pol.
Ant.				Limit	Line	Level	Factor	Loss	Factor	Pos	Pos	Avg.	
2		(MHz)	(dBμV/m)	(dB)	(dBμV/m)	(dBμV)	(dB/m)	(dB)	(dB)	(cm)	(deg)	(P/A)	(H/V)
802.11b		2390	55.45	-18.55	74	54.51	32.22	4.58	35.86	103	308	P	H
CH 01													
2412MHz		2390	43.54	-10.46	54	42.6	32.22	4.58	35.86	103	308	A	H

- Level(dBμV/m) =
Antenna Factor(dB/m) + Cable Loss(dB) + Read Level(dBμV) - Preamp Factor(dB)
- Over Limit(dB) = Level(dBμV/m) – Limit Line(dBμV/m)

For Peak Limit @ 2390MHz:

- Level(dBμV/m)
= Antenna Factor(dB/m) + Cable Loss(dB) + Read Level(dBμV) - Preamp Factor(dB)
= 32.22(dB/m) + 4.58(dB) + 54.51(dBμV) – 35.86 (dB)
= 55.45 (dBμV/m)
- Over Limit(dB)
= Level(dBμV/m) – Limit Line(dBμV/m)
= 55.45(dBμV/m) – 74(dBμV/m)
= -18.55(dB)

For Average Limit @ 2390MHz:

- Level(dBμV/m)
= Antenna Factor(dB/m) + Cable Loss(dB) + Read Level(dBμV) - Preamp Factor(dB)
= 32.22(dB/m) + 4.58(dB) + 42.6(dBμV) – 35.86 (dB)
= 43.54 (dBμV/m)
- Over Limit(dB)
= Level(dBμV/m) – Limit Line(dBμV/m)
= 43.54(dBμV/m) – 54(dBμV/m)
= -10.46(dB)

Both peak and average measured complies with the limit line, so test result is “PASS”.



Appendix C. Duty Cycle Plots

Band	Duty Cycle(%)	T(ms)	1/T(kHz)	VBW Setting
802.11a	87.43	1.361	0.735	1 kHz
802.11n HT20	86.42	1.272	0.786	1 kHz
802.11n HT40	86.05	1.225	0.816	1 kHz

802.11a

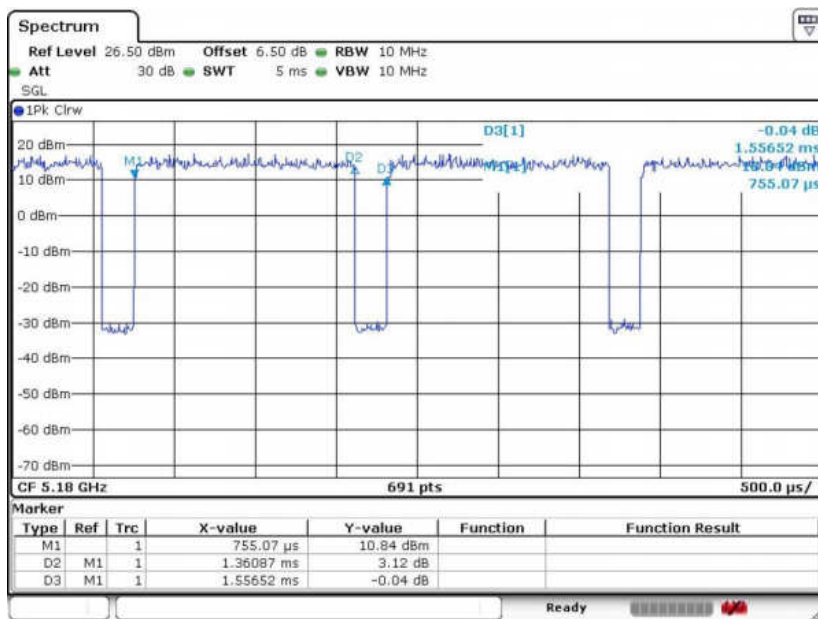



802.11n HT20

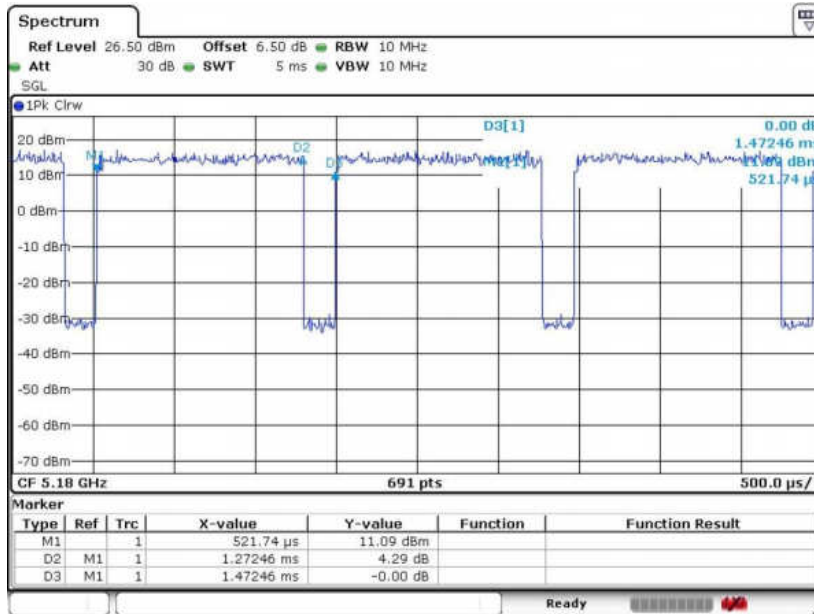

802.11n HT40

