

FCC RF Test Report

APPLICANT : Motorola Mobility LLC
EQUIPMENT : Mobile Cellular Phone
BRAND NAME : Motorola
MODEL NAME : XT1921-2
FCC ID : IHDT56XC4
STANDARD : FCC 47 CFR Part 2, 27
CLASSIFICATION : PCS Licensed Transmitter Held to Ear (PCE)

This is a variant report. The product was received on Dec. 20, 2017 and completely tested on Jan. 30, 2018. We, SPORTON INTERNATIONAL INC., would like to declare that the tested sample has been evaluated in accordance with the procedures given in ANSI / TIA-603-E and shown compliance with the applicable technical standards.

The test results in this report apply exclusively to the tested model / sample. Without written approval of SPORTON INTERNATIONAL INC., the test report shall not be reproduced except in full.



Reviewed by: Joseph Lin / Supervisor

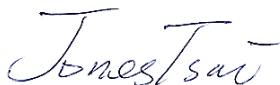

Approved by: Jones Tsai / Manager



SPORTON INTERNATIONAL INC.

No. 52, Hwa Ya 1st Rd., Hwa Ya Technology Park, Kwei-Shan District, Tao Yuan City, Taiwan, R.O.C.



TABLE OF CONTENTS

REVISION HISTORY..... 3
SUMMARY OF TEST RESULT 4
1 GENERAL DESCRIPTION 5
1.1 Applicant 5
1.2 Manufacturer 5
1.3 Product Feature of Equipment Under Test 5
1.4 Product Specification of Equipment Under Test 6
1.5 Modification of EUT 6
1.6 Emission Designator 6
1.7 Testing Site 7
1.8 Applied Standards 7
2 TEST CONFIGURATION OF EQUIPMENT UNDER TEST 8
2.1 Test Mode 8
2.2 Connection Diagram of Test System 9
2.3 Support Unit used in test configuration and system 9
2.4 Measurement Results Explanation Example 9
2.5 Frequency List of Low/Middle/High Channels 10
3 CONDUCTED TEST ITEMS 11
3.1 Measuring Instruments 11
3.2 Test Setup 11
3.3 Test Result of Conducted Test 11
3.4 Conducted Output Power Measurement 12
3.5 Peak-to-Average Ratio 13
3.6 EIRP Power Density 14
3.7 Occupied Bandwidth 15
3.8 Conducted Band Edge Measurement 16
3.9 Conducted Spurious Emission Measurement 17
3.10 Frequency Stability Measurement 18
4 RADIATED TEST ITEMS 19
4.1 Measuring Instruments 19
4.2 Test Setup 19
4.3 Test Result of Radiated Test 19
4.4 Radiated Spurious Emission Measurement 20
5 LIST OF MEASURING EQUIPMENT 21
6 UNCERTAINTY OF EVALUATION 22
APPENDIX A. TEST RESULTS OF CONDUCTED TEST
APPENDIX B. TEST RESULTS OF ERP/EIRP AND RADIATED TEST



SUMMARY OF TEST RESULT

Report Section	FCC Rule	Description	Limit	Result	Remark
3.4	§2.1046	Conducted Output Power	Reporting Only	PASS	-
3.5	-	Peak-to-Average Ratio	<13dB	N/A	Reporting only
3.6	§27.50 (a)(3)	EIRP Power Density	EIRP < 250mW/5MHz	PASS	-
3.7	§2.1049	Occupied Bandwidth	Reporting Only	PASS	-
3.8	§2.1051 §27.53 (a)(4)	Conducted Band Edge Measurement	Refer standard	PASS	-
3.9	§2.1051 §27.53 (a)(4)	Conducted Spurious Emission	< 70+10log ₁₀ (P[Watts])	PASS	-
3.10	§2.1055 §27.54	Frequency Stability Temperature & Voltage	Within the band	PASS	-
4.4	§2.1053 §27.53 (a)(4)	Radiated Spurious Emission	< 70+10log ₁₀ (P[Watts])	PASS	Under limit 9.55 dB at 9225.000 MHz

Note: This is a variant report which can be referred Product Equality Declaration. Based on the change, the test cases of LTE Band 30 were tested.



1 General Description

1.1 Applicant

Motorola Mobility LLC
222 W. Merchandise Mart Plaza, Chicago IL 60654, USA

1.2 Manufacturer

Motorola Mobility LLC
222 W. Merchandise Mart Plaza, Chicago IL 60654, USA

1.3 Product Feature of Equipment Under Test

Product Feature	
Equipment	Mobile Cellular Phone
Brand Name	Motorola
Model Name	XT1921-2
FCC ID	IHDT56XC4
IMEI Code	351840090009840 (for Radiation) 351840090015086 (for Conducted)
EUT supports Radios application	GSM/EGPRS/WCDMA/HSPA/LTE/FM/GNSS WLAN 11b/g/n HT20 WLAN 11a/n HT20/HT40 Bluetooth BR/EDR/LE
HW Version	DVT1B
EUT Stage	Identical Prototype

Remark: The above EUT's information was declared by manufacturer. Please refer to the specifications or user's manual for more detailed description.

Accessory List	
AC Adapter 1	Brand Name : Motorola
	Model Name : C-P56
AC Adapter 2	Brand Name : Motorola
	Model Name : C-P56
Battery	Brand Name : Motorola
	Model Name : GK40
USB Cable	Brand Name : Saibao
	Model Name : SWT-A083A



1.4 Product Specification of Equipment Under Test

Product Feature	
Tx Frequency	2307.5 MHz ~2312.5 MHz
Rx Frequency	2352.5 MHz ~ 2357.5 MHz
Bandwidth	5MHz / 10MHz
Maximum Output Power to Antenna	22.77 dBm
Antenna Gain	-3.56 dBi
Type of Modulation	QPSK / 16QAM

1.5 Modification of EUT

No modifications are made to the EUT during all test items.

1.6 Emission Designator

LTE Band 30		QPSK			16QAM		
BW (MHz)	Frequency Range (MHz)	Emission Designator (99%OBW)	Frequency Tolerance (ppm)	Maximum EIRP(W)	Emission Designator (99%OBW)	Frequency Tolerance (ppm)	Maximum EIRP(W)
5	2307.5 ~ 2312.5	4M50G7D	-	0.0832	4M49W7D	-	0.0723
10	2310.0	8M99G7D	0.0023	0.0834	8M97W7D	-	0.0718

1.7 Testing Site

Sporton Lab is accredited to ISO 17025 by Taiwan Accreditation Foundation (TAF code : 1190) and the FCC designation No. TW1190 and TW0007 under the FCC 2.948(e) by Mutual Recognition Agreement (MRA) in FCC Test.

Test Site	SPORTON INTERNATIONAL INC.
Test Site Location	No. 52, Hwa Ya 1 st Rd., Hwa Ya Technology Park, Kwei-Shan District, Tao Yuan City, Taiwan, R.O.C. TEL: +886-3-327-3456 FAX: +886-3-328-4978
Test Site No.	Sporton Site No.
	TH05-HY

Test Site	SPORTON INTERNATIONAL INC.
Test Site Location	No.58, Aly. 75, Ln. 564, Wenhua 3rd Rd. Guishan Dist, Taoyuan City, Taiwan (R.O.C.) TEL: +886-3-327-0868 FAX: +886-3-327-0855
Test Site No.	Sporton Site No.
	03CH12-HY

1.8 Applied Standards

According to the specifications of the manufacturer, the EUT must comply with the requirements of the following standards:

- ♦ 47 CFR Part 2, Part 27(D)
- ♦ ANSI / TIA-603-E
- ♦ FCC KDB 971168 D01 Power Meas. License Digital Systems v03
- ♦ FCC KDB 412172 D01 Determining ERP and EIRP v01r01

Remark:

1. All test items were verified and recorded according to the standards and without any deviation during the test.
2. This EUT has also been tested and complied with the requirements of FCC Part 15, Subpart B, recorded in a separate test report.



2 Test Configuration of Equipment Under Test

2.1 Test Mode

Antenna port conducted and radiated test items listed below are performed according to KDB 971168 D01 Power Meas. License Digital Systems v03 with maximum output power.

Radiated measurements are performed by rotating the EUT in three different orthogonal test planes to find the maximum emission.

Conducted Test Cases	Band	Bandwidth (MHz)						Modulation		RB #			Test Channel		
		1.4	3	5	10	15	20	QPSK	16QAM	1	Half	Full	L	M	H
Max. Output Power	30	-	-	v	v	-	-	v	v	v	v	v	v	v	v
Peak-to-Average Ratio	30	-	-		v	-	-	v	v	v		v		v	
E.I.R.P PSD	30	-	-	v	v	-	-	v	v	v			v	v	v
26dB and 99% Bandwidth	30	-	-	v	v	-	-	v	v			v	v	v	v
Conducted Band Edge	30	-	-	v	v	-	-	v	v	v		v	v		v
Conducted Spurious Emission	30	-	-	v	v	-	-	v	v	v			v	v	v
Frequency Stability	30	-	-		v	-	-	v				v		v	
Radiated Spurious Emission	30	Worst Case												v	
Note	<ol style="list-style-type: none"> The mark "v" means that this configuration is chosen for testing The mark "-" means that this bandwidth is not supported. The device is investigated from 30MHz to 10 times of fundamental signal for radiated spurious emission test under different RB size/offset and modulations in exploratory test. Subsequently, only the worst case emissions are reported. 														

2.2 Connection Diagram of Test System

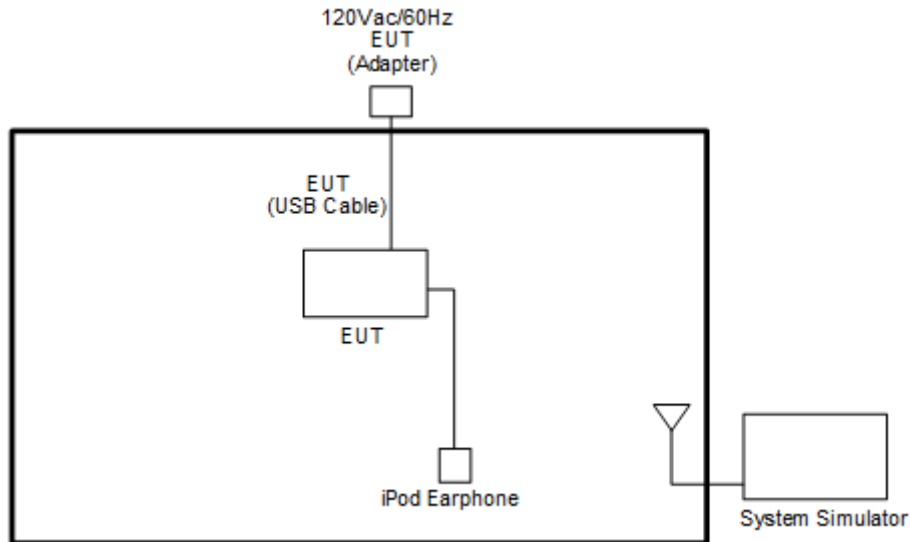

2.3 Support Unit used in test configuration and system

Item	Equipment	Trade Name	Model No.	FCC ID	Data Cable	Power Cord
1.	System Simulator	Anritsu	MT8820C	N/A	N/A	Unshielded, 1.8 m
2.	iPod Earphone	Apple	N/A	Verification	Unshielded, 1.0 m	N/A

2.4 Measurement Results Explanation Example

For all conducted test items:

The offset level is set in the spectrum analyzer to compensate the RF cable loss and attenuator factor between EUT conducted output port and spectrum analyzer. With the offset compensation, the spectrum analyzer reading level is exactly the EUT RF output level.

The spectrum analyzer offset is derived from RF cable loss and attenuator factor.

Offset = RF cable loss + attenuator factor.

Following shows an offset computation example with cable loss 4.2 dB and 10dB attenuator.

Example :

$$\begin{aligned} \text{Offset(dB)} &= \text{RF cable loss(dB)} + \text{attenuator factor(dB)}. \\ &= 4.2 + 10 = 14.2 \text{ (dB)} \end{aligned}$$



2.5 Frequency List of Low/Middle/High Channels

LTE Band 30 Channel and Frequency List				
BW [MHz]	Channel/Frequency(MHz)	Lowest	Middle	Highest
10	Channel	-	27710	-
	Frequency	-	2310	-
5	Channel	27685	27710	27735
	Frequency	2307.5	2310	2312.5

3 Conducted Test Items

3.1 Measuring Instruments

See list of measuring instruments of this test report.

3.2 Test Setup

3.2.1 Conducted Output Power

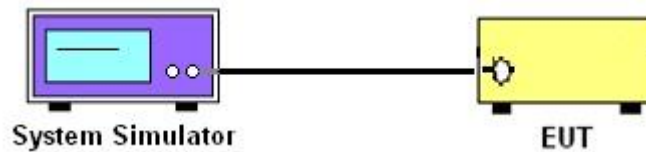

3.2.2 Peak-to-Average Ratio, Occupied / 26dB Bandwidth ,Band-Edge and Conducted Spurious Emission

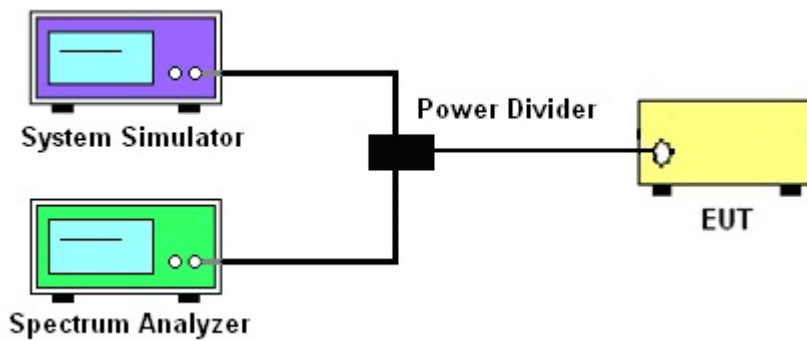

3.2.3 Frequency Stability

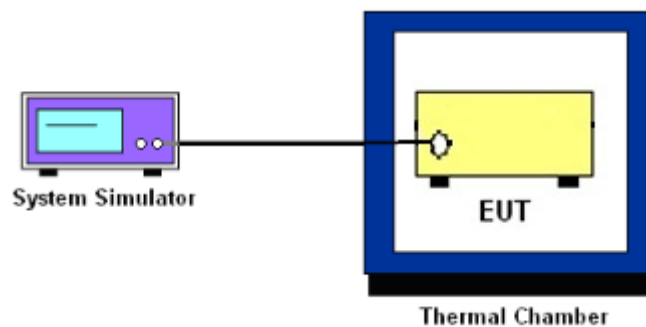

3.3 Test Result of Conducted Test

Please refer to Appendix A.



3.4 Conducted Output Power Measurement

3.4.1 Description of the Conducted Output Power Measurement

A base station simulator was used to establish communication with the EUT. Its parameters were set to transmit the maximum power on the EUT. The measured power in the radio frequency on the transmitter output terminals shall be reported.

3.4.2 Test Procedures

1. The transmitter output port was connected to the system simulator.
2. Set EUT at maximum power through the system simulator.
3. Select lowest, middle, and highest channels for each band and different modulation.
4. Measure and record the power level from the system simulator.



3.5 Peak-to-Average Ratio

3.5.1 Description of the PAR Measurement

Power Complementary Cumulative Distribution Function (CCDF) curves provide a means for characterizing the power peaks of a digitally modulated signal on a statistical basis. A CCDF curve depicts the probability of the peak signal amplitude exceeding the average power level. Most contemporary measurement instrumentation include the capability to produce CCDF curves for an input signal provided that the instrument's resolution bandwidth can be set wide enough to accommodate the entire input signal bandwidth. In measuring transmissions in this band using an average power technique, the peak-to-average ratio (PAR) of the transmission may not exceed 13 dB.

3.5.2 Test Procedures

1. The testing follows FCC KDB 971168 v03 Section 5.7.1.
2. The EUT was connected to spectrum and system simulator via a power divider.
3. Set the CCDF (Complementary Cumulative Distribution Function) option in spectrum analyzer.
4. The highest RF powers were measured and recorded the maximum PAPR level associated with a probability of 0.1 %.
5. Record the deviation as Peak to Average Ratio.



3.6 EIRP Power Density

3.6.1 Description of EIRP Power Density

For mobile and portable stations transmitting in the 2305-2315 MHz band or the 2350-2360 MHz band, the average EIRP must not exceed 50 milliwatts within any 1 megahertz of authorized bandwidth, *except that* for mobile and portable stations compliant with 3GPP LTE standards or another advanced mobile broadband protocol that avoids concentrating energy at the edge of the operating band the average EIRP must not exceed 250 milliwatts within any 5 megahertz of authorized bandwidth but may exceed 50 milliwatts within any 1 megahertz of authorized bandwidth. For mobile and portable stations using time division duplexing (TDD) technology, the duty cycle must not exceed 38 percent in the 2305-2315 MHz and 2350-2360 MHz bands. Mobile and portable stations using FDD technology are restricted to transmitting in the 2305-2315 MHz band. Power averaging shall not include intervals in which the transmitter is off.

3.6.2 Test Procedures

1. The testing follows FCC KDB 971168 v03 Section 5.7.1.
2. Set instrument center frequency to OBW center frequency.
3. Set span to at least 1.5 times the OBW.
4. Set the RBW to the specified reference bandwidth (5MHz).
5. Set VBW $\geq 3 \times$ RBW.
6. Detector = RMS (power averaging).
7. Ensure that the number of measurement points in the sweep $\geq 2 \times$ span/RBW.
8. Sweep time = auto couple.
9. Employ trace averaging (RMS) mode over a minimum of 100 traces.
10. Use the peak marker function to determine the maximum amplitude level within the reference bandwidth (PSD).

3.7 Occupied Bandwidth

3.7.1 Description of Occupied Bandwidth Measurement

The occupied bandwidth is the width of a frequency band such that, below the lower and above the upper frequency limits, the mean powers emitted are each equal to a specified percentage 0.5% of the total mean transmitted power.

The 26 dB emission bandwidth is defined as the frequency range between two points, one above and one below the carrier frequency, at which the spectral density of the emission is attenuated 26 dB below the maximum in-band spectral density of the modulated signal. Spectral density (power per unit bandwidth) is to be measured with a detector of resolution bandwidth equal to approximately 1.0% of the emission bandwidth.

3.7.2 Test Procedures

1. The testing follows FCC KDB 971168 v03 Section 4.2.
2. The EUT was connected to spectrum analyzer and system simulator via a power divider.
3. The spectrum analyzer center frequency is set to the nominal EUT channel center frequency. The span range for the spectrum analyzer shall be between two and five times the anticipated OBW.
4. The nominal resolution bandwidth (RBW) shall be in the range of 1 to 5 % of the anticipated OBW, and the VBW shall be at least 3 times the RBW.
5. Set the detection mode to peak, and the trace mode to max hold.
6. Determine the reference value: Set the EUT to transmit a modulated signal. Allow the trace to stabilize. Set the spectrum analyzer marker to the highest level of the displayed trace.
(this is the reference value)
7. Determine the “-26 dB down amplitude” as equal to (Reference Value – X).
8. Place two markers, one at the lowest and the other at the highest frequency of the envelope of the spectral display such that each marker is at or slightly below the “-X dB down amplitude” determined in step 6. If a marker is below this “-X dB down amplitude” value it shall be placed as close as possible to this value. The OBW is the positive frequency difference between the two markers.
9. Use the 99 % power bandwidth function of the spectrum analyzer and report the measured bandwidth.

3.8 Conducted Band Edge Measurement

3.8.1 Description of Conducted Band Edge Measurement

27.53 (a)(4)

For mobile and portable stations operating in the 2305-2315 MHz and 2350-2360 MHz bands:

- (i) By a factor of not less than: $43 + 10 \log (P)$ dB on all frequencies between 2305 and 2320 MHz and on all frequencies between 2345 and 2360 MHz that are outside the licensed band(s) of operation, not less than $55 + 10 \log (P)$ dB on all frequencies between 2320 and 2324 MHz and on all frequencies between 2341 and 2345 MHz, not less than $61 + 10 \log (P)$ dB on all frequencies between 2324 and 2328 MHz and on all frequencies between 2337 and 2341 MHz, and not less than $67 + 10 \log (P)$ dB on all frequencies between 2328 and 2337 MHz;
- (ii) By a factor of not less than $43 + 10 \log (P)$ dB on all frequencies between 2300 and 2305 MHz, $55 + 10 \log (P)$ dB on all frequencies between 2296 and 2300 MHz, $61 + 10 \log (P)$ dB on all frequencies between 2292 and 2296 MHz, $67 + 10 \log (P)$ dB on all frequencies between 2288 and 2292 MHz, and $70 + 10 \log (P)$ dB below 2288 MHz;
- (iii) By a factor of not less than $43 + 10 \log (P)$ dB on all frequencies between 2360 and 2365 MHz, and not less than $70 + 10 \log (P)$ dB above 2365 MHz.

3.8.2 Test Procedures

1. The testing follows FCC KDB 971168 v03 Section 6.0.
2. The EUT was connected to spectrum analyzer and system simulator via a power divider.
3. The band edges of low and high channels for the highest RF powers were measured.
4. Set RBW \geq 1% EBW in the 1MHz band immediately outside and adjacent to the band edge.
5. Beyond the 1 MHz band from the band edge, RBW=1MHz was used.
6. Set spectrum analyzer with RMS detector.
7. The RF fundamental frequency should be excluded against the limit line in the operating frequency band.
8. Checked that all the results comply with the emission limit line.

The limit line is derived from $43 + 10\log(P)$ dB below the transmitter power P(Watts)



3.9 Conducted Spurious Emission Measurement

3.9.1 Description of Conducted Spurious Emission Measurement

The power of any emission outside of the authorized operating frequency ranges must be lower than the transmitter power (P) by a factor of at least $70 + 10 \log (P)$ dB.

It is measured by means of a calibrated spectrum analyzer and scanned from 9 kHz up to a frequency including its 10th harmonic.

3.9.2 Test Procedures

1. The testing follows FCC KDB 971168 v03 Section 6.0.
2. The EUT was connected to spectrum analyzer and system simulator via a power divider.
3. The RF output of EUT was connected to the spectrum analyzer by RF cable and attenuator. The path loss was compensated to the results for each measurement.
4. The middle channel for the highest RF power within the transmitting frequency was measured.
5. The conducted spurious emission for the whole frequency range was taken.
6. Make the measurement with the spectrum analyzer's RBW = 1MHz, VBW = 3MHz.
7. Set spectrum analyzer with RMS detector.
8. Taking the record of maximum spurious emission.
9. The RF fundamental frequency should be excluded against the limit line in the operating frequency band.
10. The limit line is derived from $70 + 10\log(P)$ dB below the transmitter power P(Watts)



3.10 Frequency Stability Measurement

3.10.1 Description of Frequency Stability Measurement

The frequency stability shall be measured by variation of ambient temperature and variation of primary supply voltage to ensure that the fundamental emission stays within the authorized frequency block. The frequency stability of the transmitter shall be maintained within $\pm 0.00025\%$ ($\pm 2.5\text{ppm}$) of the center frequency.

3.10.2 Test Procedures for Temperature Variation

1. The testing follows FCC KDB 971168 v03 Section 9.0.
2. The EUT was set up in the thermal chamber and connected with the system simulator.
3. With power OFF, the temperature was decreased to -30°C and the EUT was stabilized before testing. Power was applied and the maximum change in frequency was recorded within one minute.
4. With power OFF, the temperature was raised in 10°C step up to 50°C . The EUT was stabilized at each step for at least half an hour. Power was applied and the maximum frequency change was recorded within one minute.

3.10.3 Test Procedures for Voltage Variation

1. The testing follows FCC KDB 971168 v03 Section 9.0.
2. The EUT was placed in a temperature chamber at $20\pm 5^{\circ}\text{C}$ and connected with the system simulator.
3. The power supply voltage to the EUT was varied from 85% to 115% of the nominal value measured at the input to the EUT.
4. The variation in frequency was measured for the worst case.

4 Radiated Test Items

4.1 Measuring Instruments

See list of measuring instruments of this test report.

4.2 Test Setup

4.2.1 For radiated test from 30MHz to 1GHz

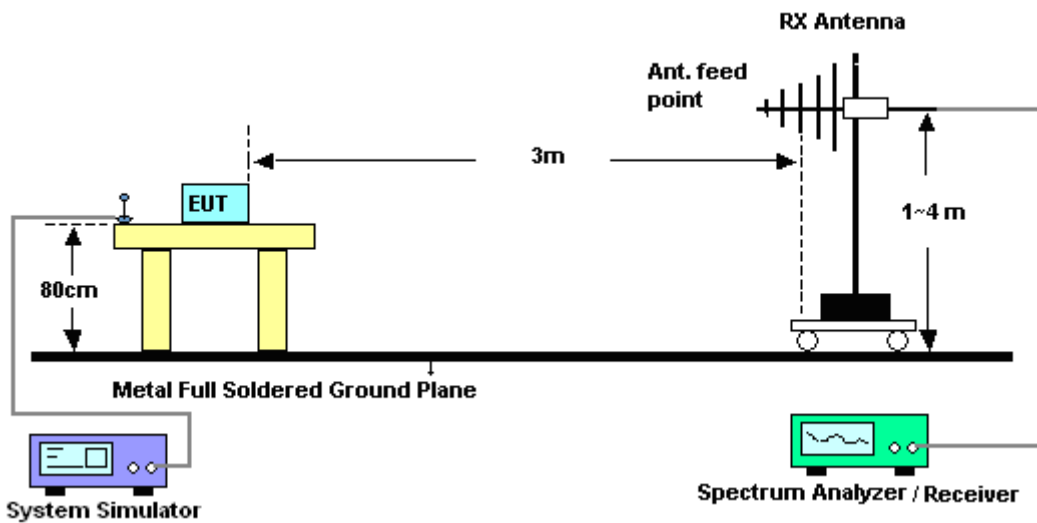

4.2.2 For radiated test above 1GHz

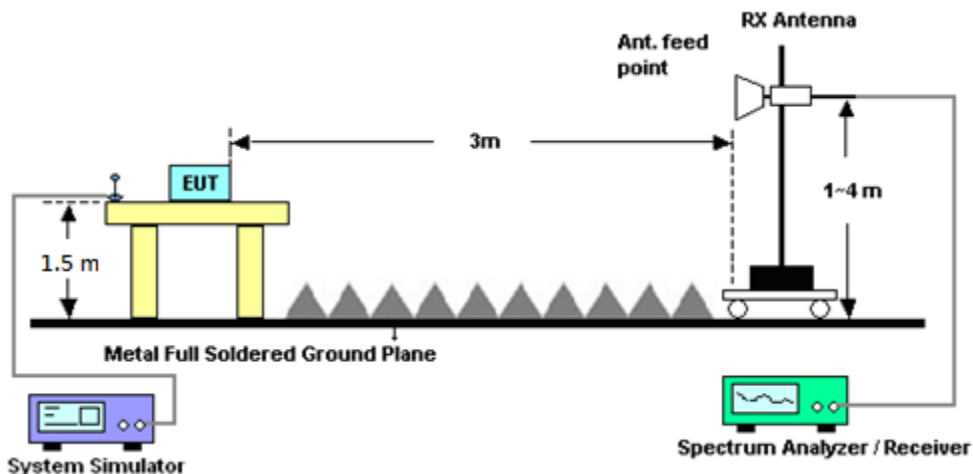

4.3 Test Result of Radiated Test

Please refer to Appendix B.



4.4 Radiated Spurious Emission Measurement

4.4.1 Description of Radiated Spurious Emission

The radiated spurious emission was measured by substitution method according to ANSI / TIA / EIA-603-E. The power of any emission outside of the authorized operating frequency ranges must be attenuated below the transmitter power (P) by a factor of at least $70 + 10 \log (P)$ dB.

The spectrum is scanned from 30 MHz up to a frequency including its 10th harmonic.

4.4.2 Test Procedures

1. The testing follows FCC KDB 971168 v03 Section 5.8 and ANSI / TIA-603-E Section 2.2.12.
2. The EUT was placed on a turntable with 0.8 meter height for frequency below 1GHz and 1.5 meter height for frequency above 1GHz respectively above ground.
3. The EUT was set 3 meters from the receiving antenna mounted on the antenna tower.
4. The table was rotated 360 degrees to determine the position of the highest spurious emission.
5. The height of the receiving antenna is varied between 1m to 4m to search the maximum spurious emission for both horizontal and vertical polarizations.
6. During the measurement, the system simulator parameters were set to force the EUT transmitting at maximum output power.
7. Make the measurement with the spectrum analyzer's RBW = 1MHz, VBW = 3MHz, taking the record of maximum spurious emission.
8. A horn antenna was substituted in place of the EUT and was driven by a signal generator.
9. Tune the output power of signal generator to the same emission level with EUT maximum spurious emission.
EIRP (dBm) = S.G. Power – Tx Cable Loss + Tx Antenna Gain
ERP (dBm) = EIRP - 2.15
10. The RF fundamental frequency should be excluded against the limit line in the operating frequency band.

The limit line is derived from $70 + 10\log(P)$ dB below the transmitter power P(Watts)



5 List of Measuring Equipment

Instrument	Manufacturer	Model No.	Serial No.	Characteristics	Calibration Date	Test Date	Due Date	Remark
LTE Base Station	Anritsu	MT8820C	6201432821	GSM/GPRS /WCDMA/LTE	Oct. 13, 2017	Jan. 23, 2018 ~ Jan. 30, 2018	Oct. 12, 2018	Conducted (TH05-HY)
Spectrum Analyzer	Rohde & Schwarz	FSV40	101397	10Hz~40GHz	Nov. 07, 2017	Jan. 23, 2018 ~ Jan. 30, 2018	Nov. 06, 2018	Conducted (TH05-HY)
Spectrum Analyzer	Rohde & Schwarz	FSV30	100895	9kHz~30GHz	Apr. 25, 2017	Jan. 23, 2018 ~ Jan. 30, 2018	Apr. 24, 2018	Conducted (TH05-HY)
Temperature Chamber	ESPEC	SH-641	92013720	-30℃~70℃	Aug. 28, 2017	Jan. 23, 2018 ~ Jan. 30, 2018	Aug. 27, 2018	Conducted (TH05-HY)
Programmable Power Supply	GW Instek	PSS-2005	EL890001	1V~20V 0.5A~5A	Oct. 06, 2017	Jan. 23, 2018 ~ Jan. 30, 2018	Oct. 05, 2018	Conducted (TH05-HY)
Coupler	Warison	1-18GHz 20dB 25WSMA Directional Coupler	#B	1G~18GHz	Feb. 20, 2017	Jan. 23, 2018 ~ Jan. 30, 2018	Feb. 19, 2018	Conducted (TH05-HY)
Amplifier	MITEQ	TTA1840-35-H G	1871923	18GHz~40GHz, VSWR : 2.5:1 max	Jul. 18, 2017	Jan. 15, 2017 ~ Jan. 16, 2018	Jul. 17, 2018	Radiation (03CH12-HY)
Bilog Antenna	TESEQ	CBL 6111D&00800 N1D01N-06	35413&02	30MHz~1GHz	Dec. 18, 2017	Jan. 15, 2017 ~ Jan. 16, 2018	Dec. 17, 2018	Radiation (03CH12-HY)
Horn Antenna	SCHWARZBE CK	BBHA 9120D	9120D-1328	1GHz ~ 18GHz	Oct. 20, 2017	Jan. 15, 2017 ~ Jan. 16, 2018	Oct. 19, 2018	Radiation (03CH12-HY)
Preamplifier	COM-POWER	PA-103	161075	10MHz~1GHz	Mar. 23, 2017	Jan. 15, 2017 ~ Jan. 16, 2018	Mar. 22, 2018	Radiation (03CH12-HY)
Preamplifier	Agilent	8449B	3008A02375	1GHz~26.5GHz	Dec. 19, 2017	Jan. 15, 2017 ~ Jan. 16, 2018	Dec. 18, 2018	Radiation (03CH12-HY)
Antenna Mast	EMEC	AM-BS-4500-B	N/A	1m~4m	N/A	Jan. 15, 2017 ~ Jan. 16, 2018	N/A	Radiation (03CH12-HY)
Turn Table	EMEC	TT2000	N/A	0~360 Degree	N/A	Jan. 15, 2017 ~ Jan. 16, 2018	N/A	Radiation (03CH12-HY)
SHF-EHF Horn Antenna	SCHWARZBE CK	BBHA 9170	BBHA917057 6	18GHz ~ 40GHz	Apr. 27, 2017	Jan. 15, 2017 ~ Jan. 16, 2018	Apr. 26, 2018	Radiation (03CH12-HY)
Spectrum Analyzer	Agilent	N9030A	MY52350276	3Hz~44GHz	Mar. 23, 2017	Jan. 15, 2017 ~ Jan. 16, 2018	Mar. 22, 2018	Radiation (03CH12-HY)
Horn Antenna	SCHWARZBE CK	BBHA 9120 D	BBHA 9120 D 1212	1GHz ~ 18GHz	Mar. 17, 2017	Jan. 15, 2017 ~ Jan. 16, 2018	Mar. 16, 2018	Radiation (03CH12-HY)
SHF-EHF Horn Antenna	SCHWARZBE CK	BBHA 9170	BBHA917058 4	18GHz- 40GHz	Nov. 27, 2017	Jan. 15, 2017 ~ Jan. 16, 2018	Nov. 26, 2018	Radiation (03CH12-HY)
Signal Generator	Rohde & Schwarz	SMF100A	101107	100kHz~40GHz	May 22, 2017	Jan. 15, 2017 ~ Jan. 16, 2018	May 21, 2018	Radiation (03CH12-HY)



6 Uncertainty of Evaluation

Uncertainty of Radiated Emission Measurement (30 MHz ~ 1000 MHz)

Measuring Uncertainty for a Level of Confidence of 95% (U = 2Uc(y))	3.36
---	------

Uncertainty of Radiated Emission Measurement (1 GHz ~ 18 GHz)

Measuring Uncertainty for a Level of Confidence of 95% (U = 2Uc(y))	3.70
---	------

Uncertainty of Radiated Emission Measurement (18 GHz ~ 40 GHz)

Measuring Uncertainty for a Level of Confidence of 95% (U = 2Uc(y))	3.98
---	------



Appendix A. Test Results of Conducted Test

Conducted Output Power(Average power)

LTE Band 30 Maximum Average Power [dBm]						
BW [MHz]	RB Size	RB Offset	Mod	Lowest	Middle	Highest
10	1	0	QPSK		22.72	
10	1	25			22.72	
10	1	49			22.77	
10	25	0			21.73	
10	25	12			21.71	
10	25	25			21.67	
10	50	0			21.78	
10	1	0	16-QAM		22.12	
10	1	25			22.04	
10	1	49			22.06	
10	25	0			20.72	
10	25	12			20.67	
10	25	25			20.61	
10	50	0			20.79	
5	1	0	QPSK	22.65	22.60	22.64
5	1	12		22.70	22.76	22.64
5	1	24		22.63	22.58	22.54
5	12	0		21.82	21.76	21.82
5	12	7		21.69	21.72	21.72
5	12	13		21.68	21.67	21.56
5	25	0		21.78	21.67	21.79
5	1	0	16-QAM	22.15	22.12	22.06
5	1	12		21.97	22.05	21.94
5	1	24		21.97	22.03	21.87
5	12	0		20.85	20.81	20.82
5	12	7		20.74	20.73	20.73
5	12	13		20.70	20.63	20.59
5	25	0		20.80	20.67	20.78



LTE Band 30

Peak-to-Average Ratio

Mode	LTE Band 30 / 10MHz				
Mod.	QPSK		16QAM		Limit: 13dB
RB Size	1RB	Full RB	1RB	Full RB	Result
Lowest CH	-	-	-	-	PASS
Middle CH	4.38	4.87	4.99	5.83	
Highest CH	-	-	-	-	



LTE Band 30 / 10MHz / QPSK

Middle Channel / 1RB

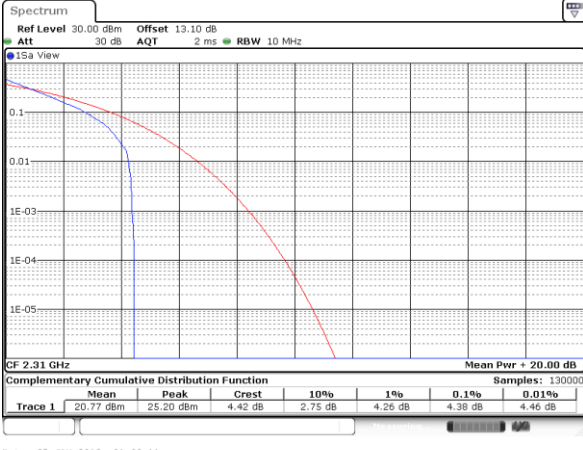

Date: 25_JAN_2018 21:03:11

Middle Channel / Full RB

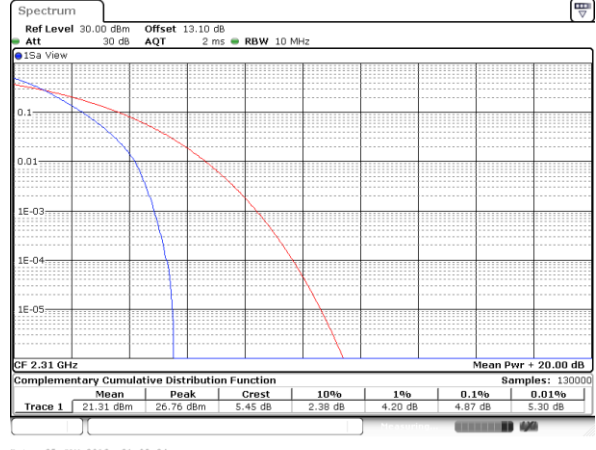

Date: 25_JAN_2018 21:03:24

LTE Band 30 / 10MHz / 16QAM

Middle Channel / 1RB

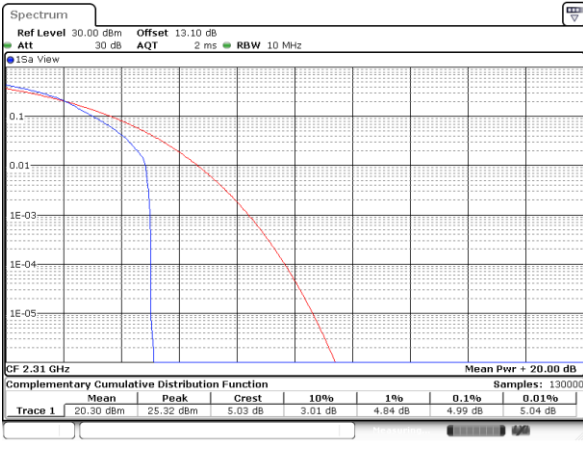

Date: 25_JAN_2018 21:02:38

Middle Channel / Full RB

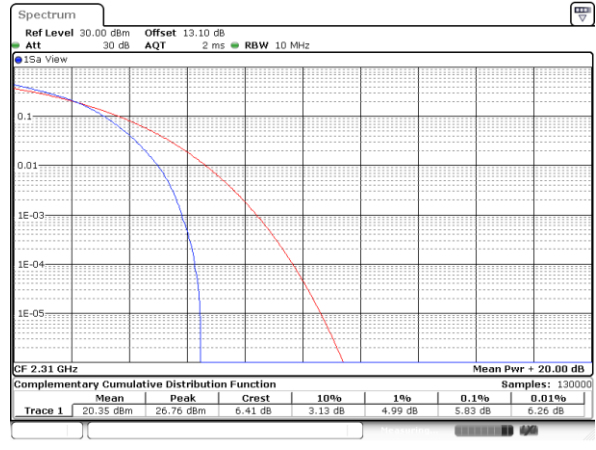

Date: 25_JAN_2018 21:02:48



EIRP Power Density

Mode	LTE Band 30 : Conducted Power Density (dBm/5MHz)											
	1.4MHz		3MHz		5MHz		10MHz		15MHz		20MHz	
Mod.	QPSK	16QAM	QPSK	16QAM	QPSK	16QAM	QPSK	16QAM	QPSK	16QAM	QPSK	16QAM
Lowest CH	-	-	-	-	23.77	23.25	-	-	-	-	-	-
Middle CH	-	-	-	-	23.74	23.25	23.92	23.45	-	-	-	-
Highest CH	-	-	-	-	23.67	23.10	-	-	-	-	-	-

Mode	LTE Band 30 : EIRP Power Density (dBm/5MHz)											
	1.4MHz		3MHz		5MHz		10MHz		15MHz		20MHz	
Mod.	QPSK	16QAM	QPSK	16QAM	QPSK	16QAM	QPSK	16QAM	QPSK	16QAM	QPSK	16QAM
Lowest CH	-	-	-	-	20.21	19.69	-	-	-	-	-	-
Middle CH	-	-	-	-	20.18	19.69	20.36	19.89	-	-	-	-
Highest CH	-	-	-	-	20.11	19.54	-	-	-	-	-	-
Antenna Gain	-3.56 dBi											
Limit	250mW / 5MHz = 24dBm / 5MHz											
Result	Pass											



LTE Band 30 / 5MHz

Lowest Channel / 5MHz / 1RB0 / QPSK



Date: 23_JAN_2018 23:48:20

Lowest Channel / 5MHz / 1RB0 / 16QAM



Date: 23_JAN_2018 23:48:33

Middle Channel / 5MHz / 1RB0 / QPSK



Date: 23_JAN_2018 23:46:39

Middle Channel / 5MHz / 1RBmax / 16QAM



Date: 23_JAN_2018 23:47:05

Highest Channel / 5MHz / Full RB / QPSK



Date: 23_JAN_2018 23:49:12

Highest Channel / 5MHz / Full RB / 16QAM



Date: 23_JAN_2018 23:49:20

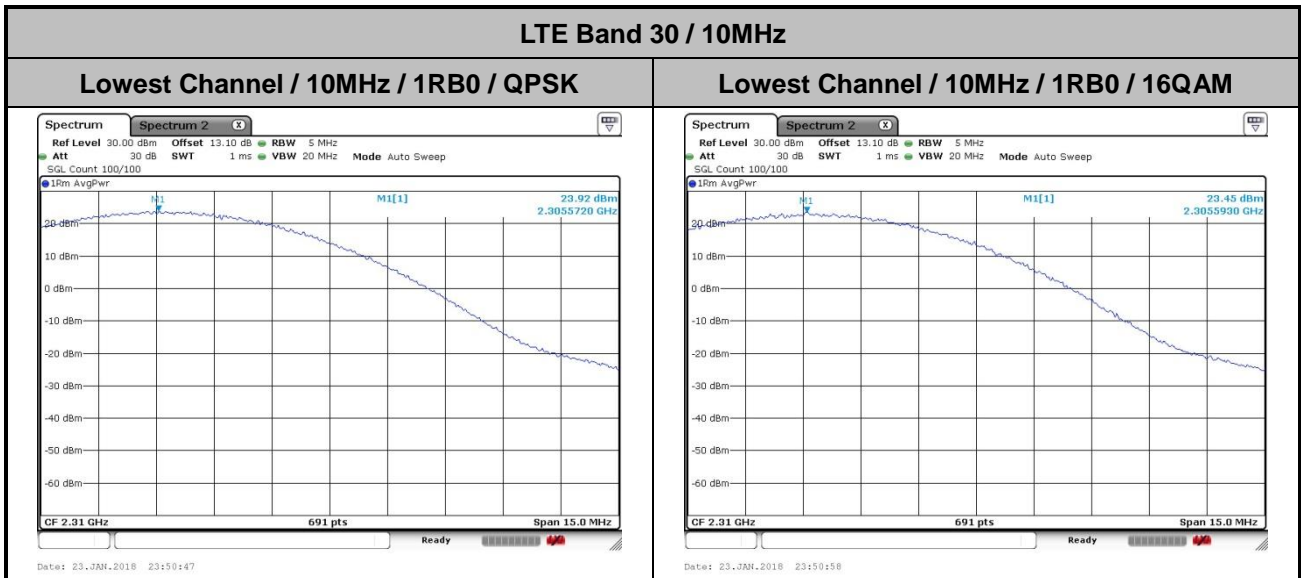



26dB Bandwidth

Mode	LTE Band 30 : 26dB BW(MHz)											
	1.4MHz		3MHz		5MHz		10MHz		15MHz		20MHz	
BW												
Mod.	QPSK	16QAM	QPSK	16QAM	QPSK	16QAM	QPSK	16QAM	QPSK	16QAM	QPSK	16QAM
Lowest CH	-	-	-	-	4.98	4.87	-	-	-	-	-	-
Middle CH	-	-	-	-	4.80	4.94	9.91	9.91	-	-	-	-
Highest CH	-	-	-	-	4.88	4.87	-	-	-	-	-	-



LTE Band 30

Lowest Channel / 5MHz / QPSK

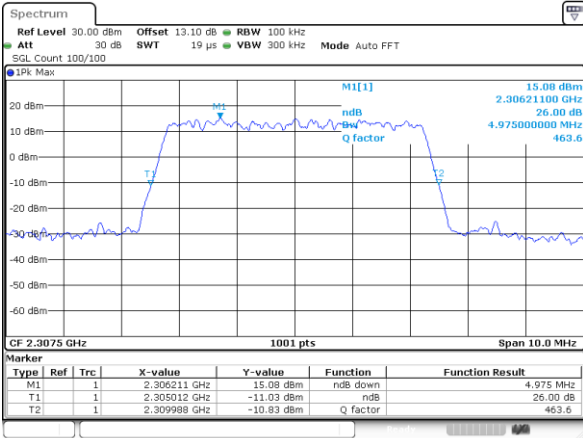

Date: 25_JAN_2018 20:38:57

Lowest Channel / 5MHz / 16QAM

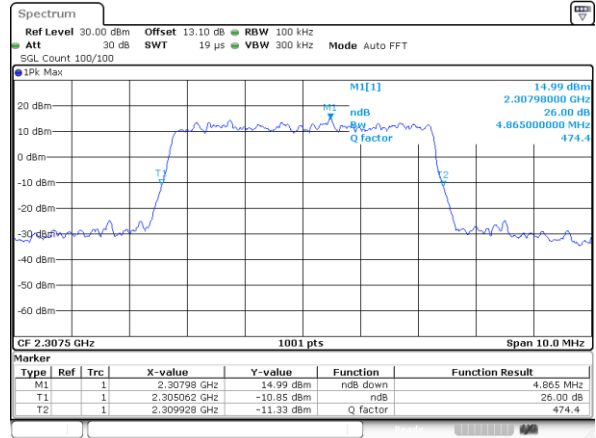

Date: 25_JAN_2018 20:39:08

Middle Channel / 5MHz / QPSK

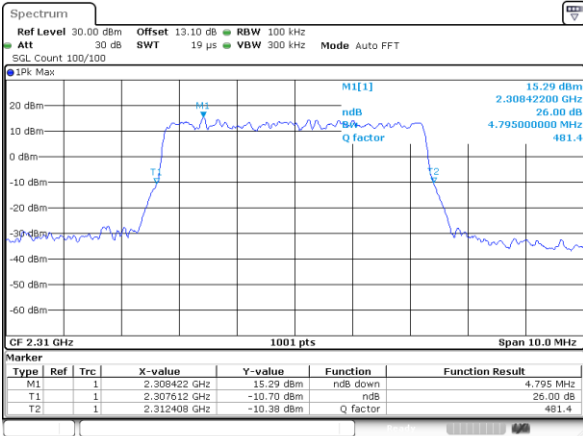

Date: 25_JAN_2018 20:44:28

Middle Channel / 5MHz / 16QAM

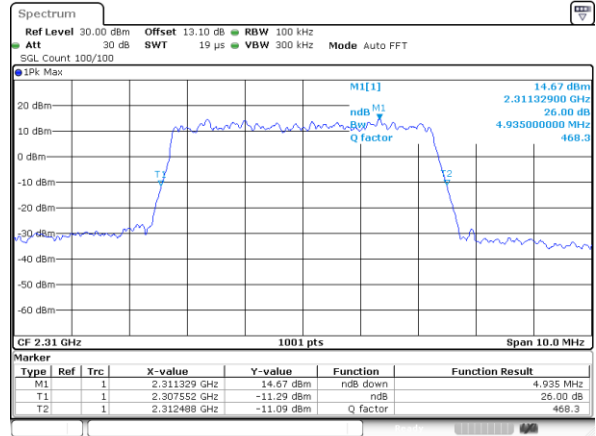

Date: 25_JAN_2018 20:44:40

Highest Channel / 5MHz / QPSK

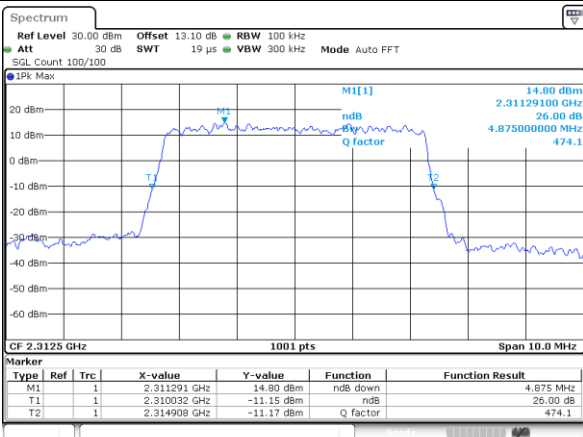

Date: 25_JAN_2018 20:45:14

Highest Channel / 5MHz / 16QAM

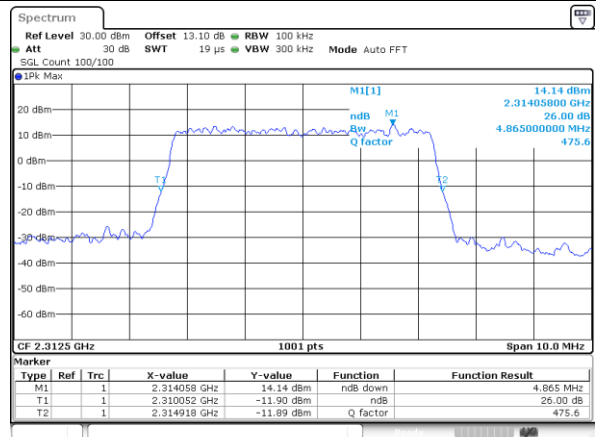

Date: 25_JAN_2018 20:45:25



LTE Band 30

Middle Channel / 10MHz / QPSK

Middle Channel / 10MHz / 16QAM

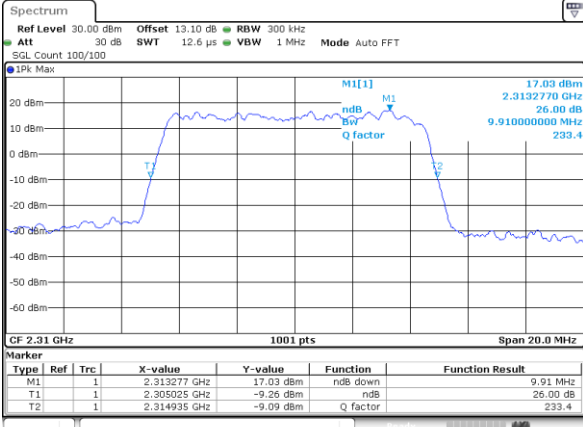

Date: 25_JAN_2018 20:50:45

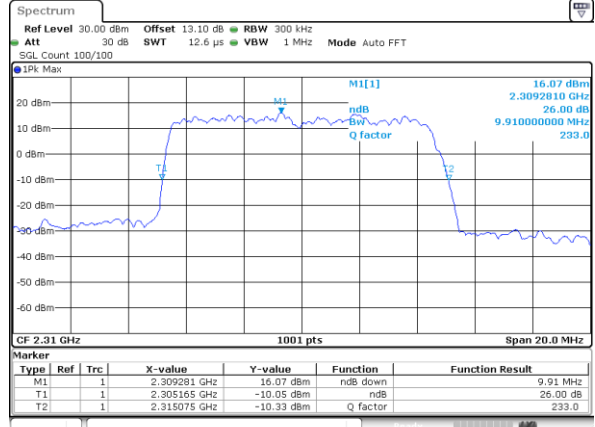

Date: 25_JAN_2018 20:50:57



Occupied Bandwidth

Mode	LTE Band 30 : 99%OBW(MHz)											
	1.4MHz		3MHz		5MHz		10MHz		15MHz		20MHz	
BW												
Mod.	QPSK	16QAM	QPSK	16QAM	QPSK	16QAM	QPSK	16QAM	QPSK	16QAM	QPSK	16QAM
Lowest CH	-	-	-	-	4.50	4.49	-	-	-	-	-	-
Middle CH	-	-	-	-	4.47	4.49	8.99	8.97	-	-	-	-
Highest CH	-	-	-	-	4.49	4.49	-	-	-	-	-	-



LTE Band 30

Lowest Channel / 5MHz / QPSK

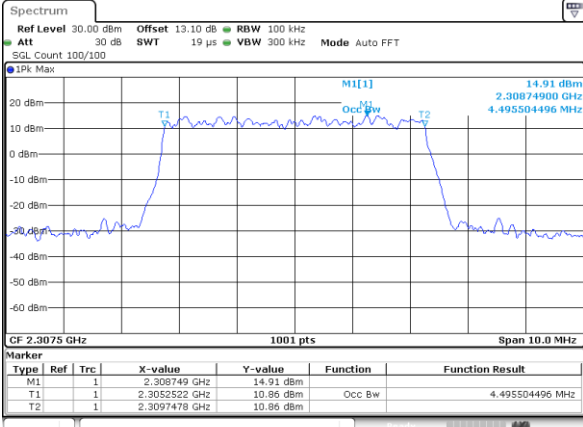

Date: 25_JAN_2018 20:38:34

Lowest Channel / 5MHz / 16QAM

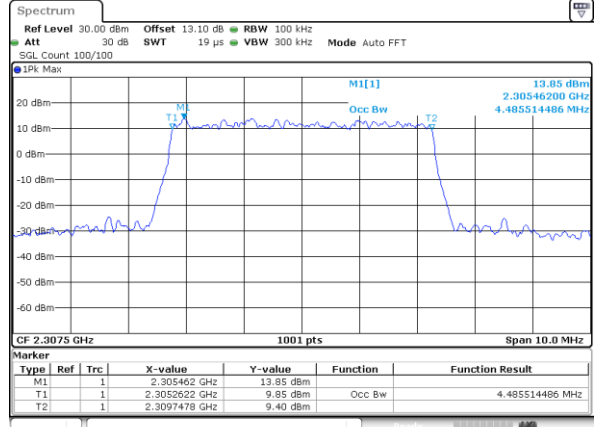

Date: 25_JAN_2018 20:38:46

Middle Channel / 5MHz / QPSK

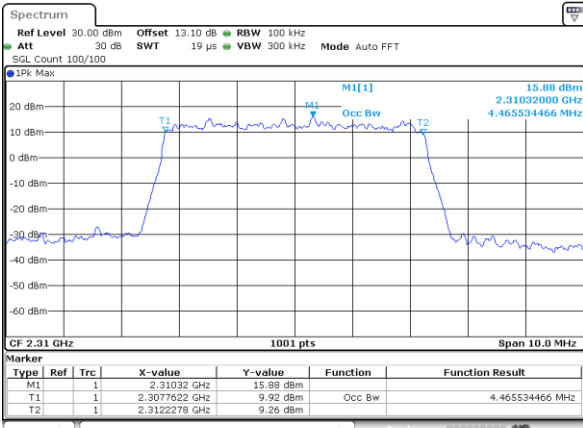

Date: 25_JAN_2018 20:44:06

Middle Channel / 5MHz / 16QAM

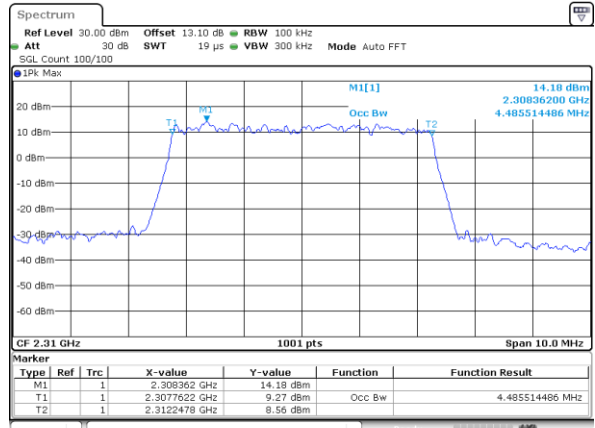

Date: 25_JAN_2018 20:44:17

Highest Channel / 5MHz / QPSK

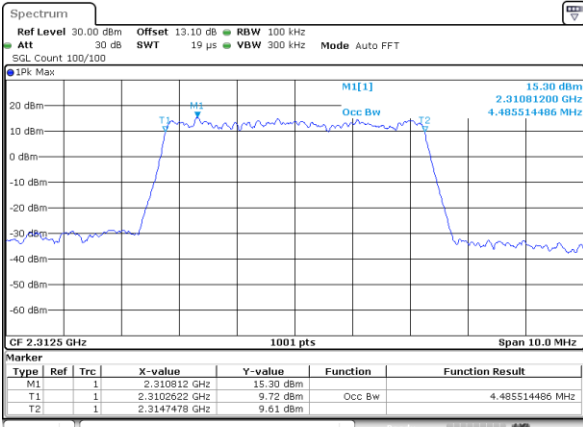

Date: 25_JAN_2018 20:44:51

Highest Channel / 5MHz / 16QAM

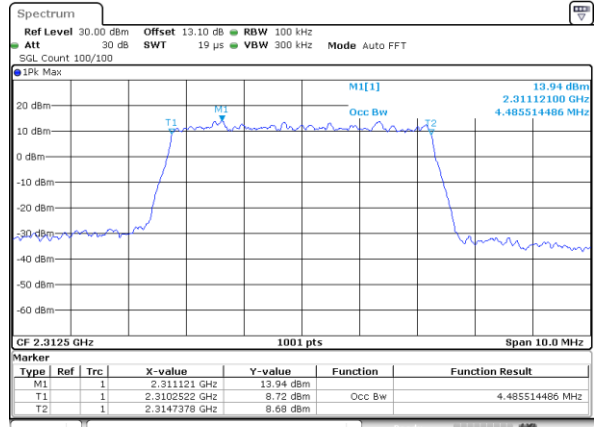

Date: 25_JAN_2018 20:45:02



LTE Band 30

Middle Channel / 10MHz / QPSK

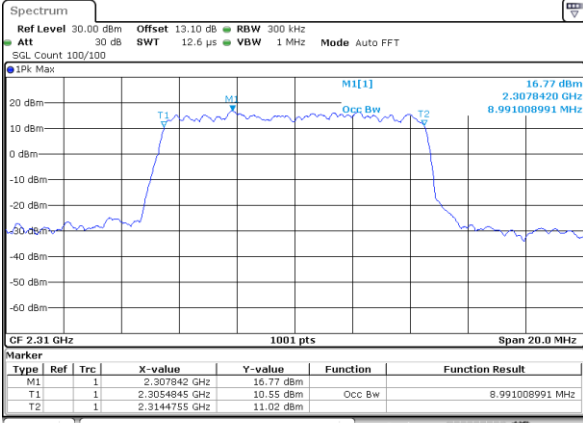

Date: 25_JAN_2018 20:50:23

Middle Channel / 10MHz / 16QAM

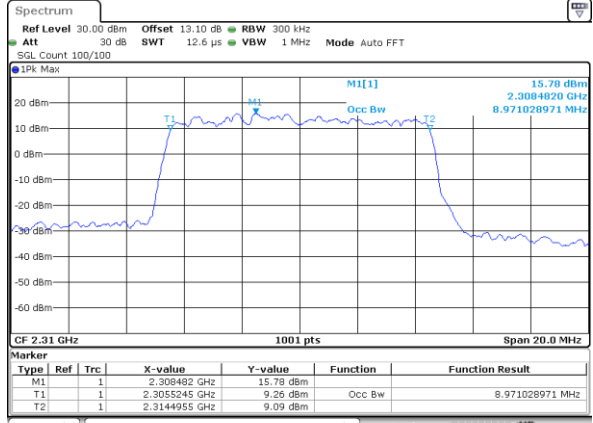

Date: 25_JAN_2018 20:50:34



Conducted Band Edge

LTE Band 30 / 5MHz / QPSK

Lowest Band Edge / 1 RB

Highest Band Edge / 1 RB

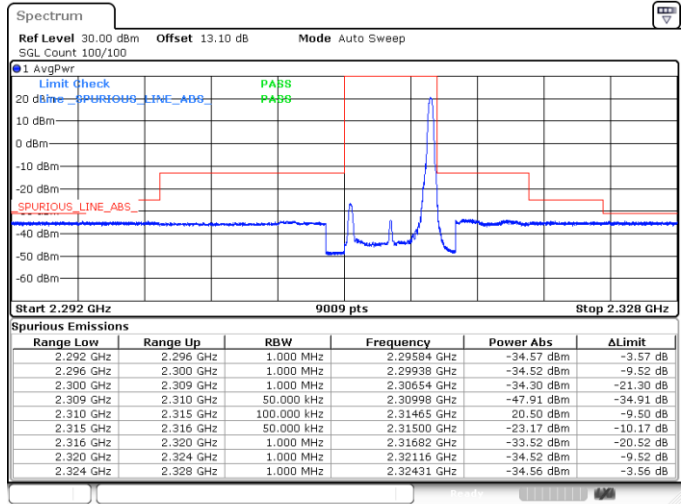
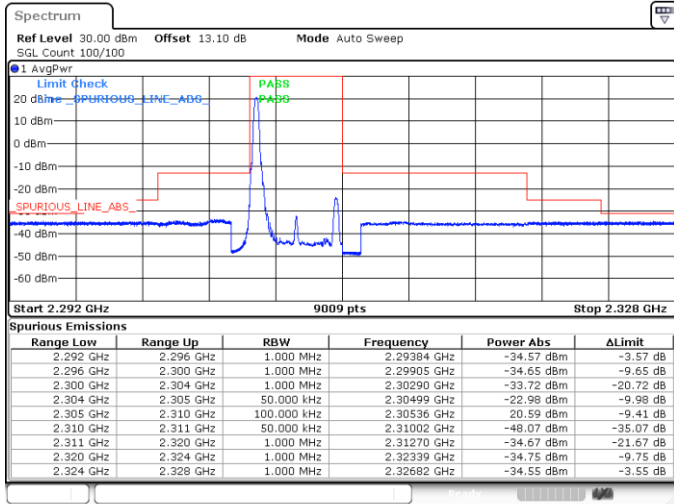

Date: 25.JAN.2018 20:40:20

Date: 25.JAN.2018 20:46:37

Lowest Band Edge / Full RB

Highest Band Edge / Full RB

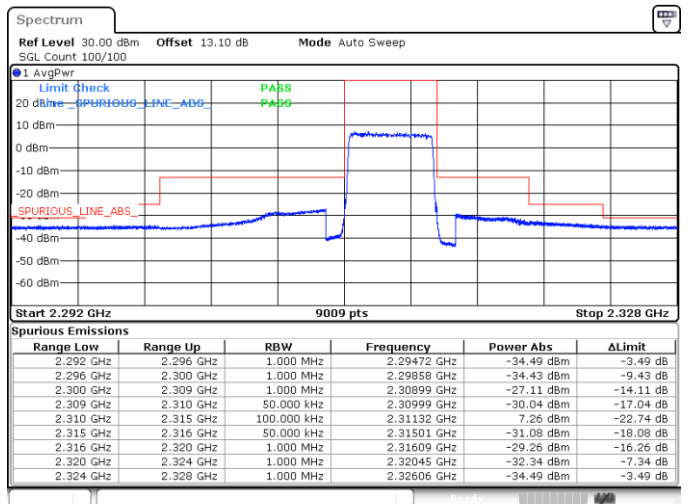
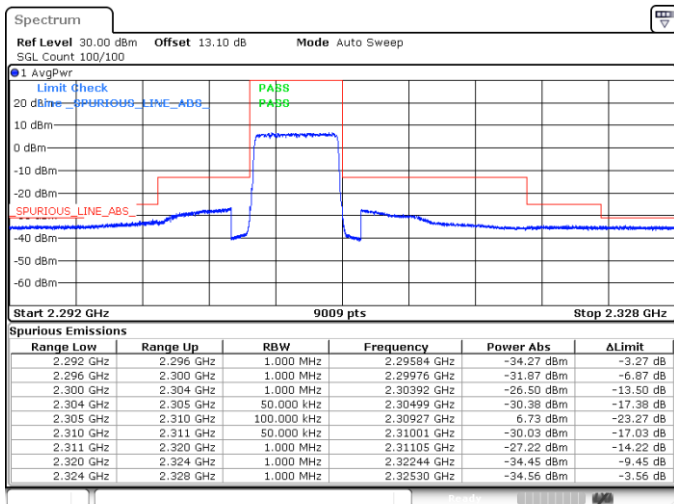

Date: 25.JAN.2018 20:42:43

Date: 25.JAN.2018 20:49:00



LTE Band 30 / 5MHz / 16QAM

Lowest Band Edge / 1RB

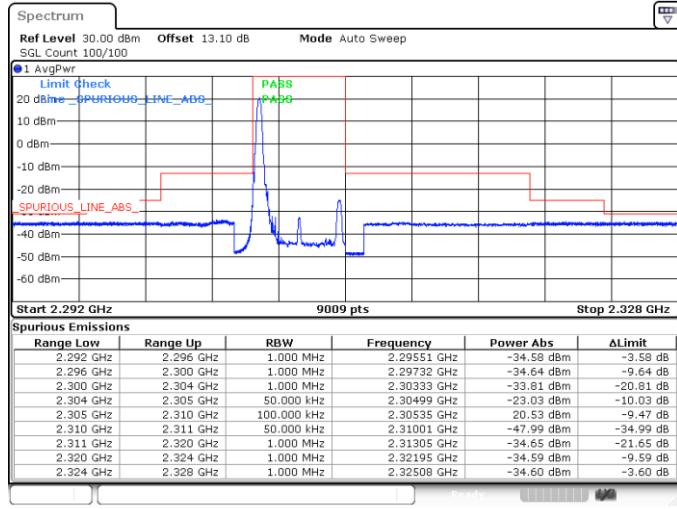

Date: 25.JAN.2018 20:41:32

Highest Band Edge / 1 RB

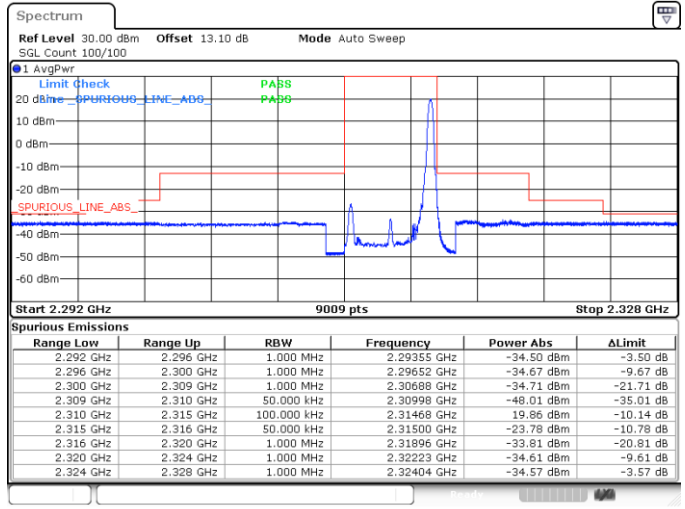

Date: 25.JAN.2018 20:47:48

Lowest Band Edge / Full RB

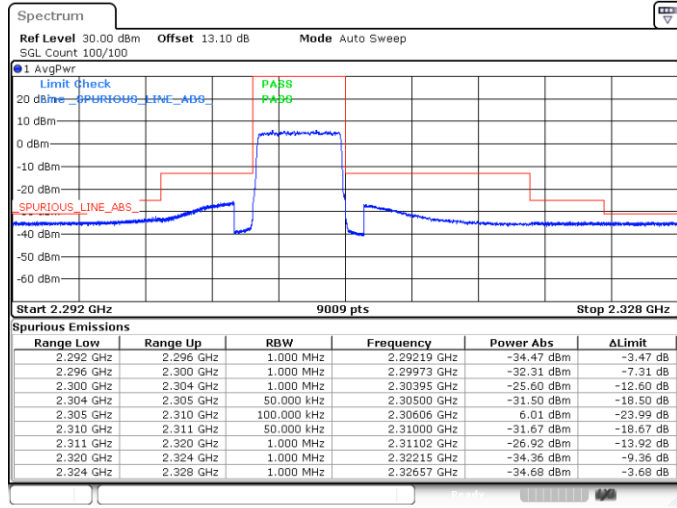

Date: 25.JAN.2018 20:43:54

Highest Band Edge / Full RB

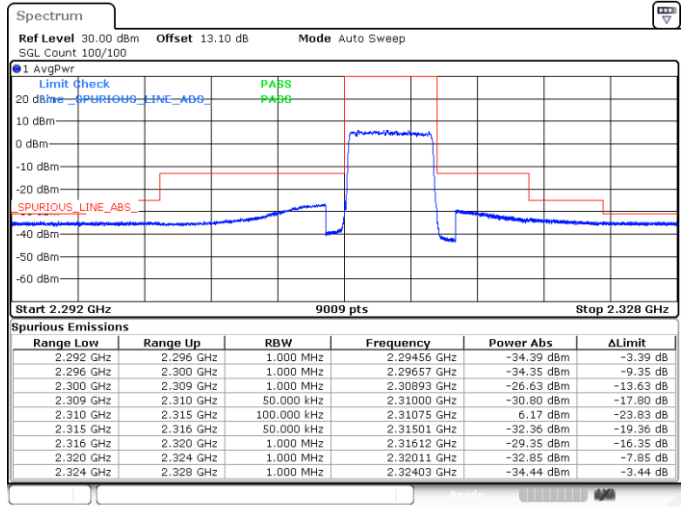

Date: 25.JAN.2018 20:50:11



LTE Band 30 / 10MHz / QPSK

Lowest Band Edge / 1 RB

Highest Band Edge / 1 RB

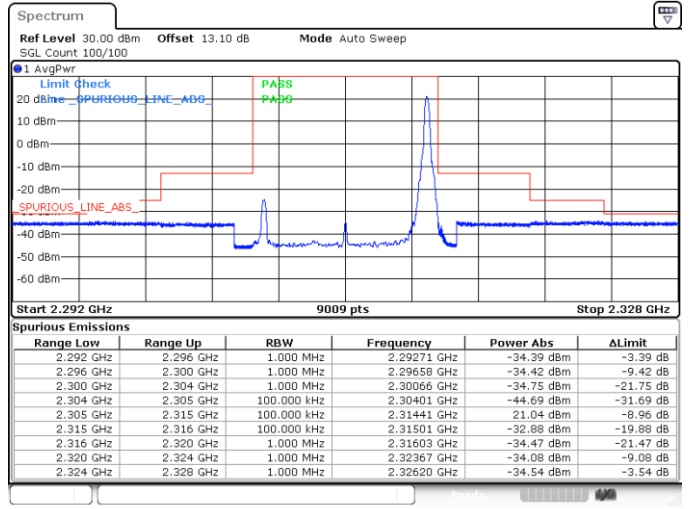
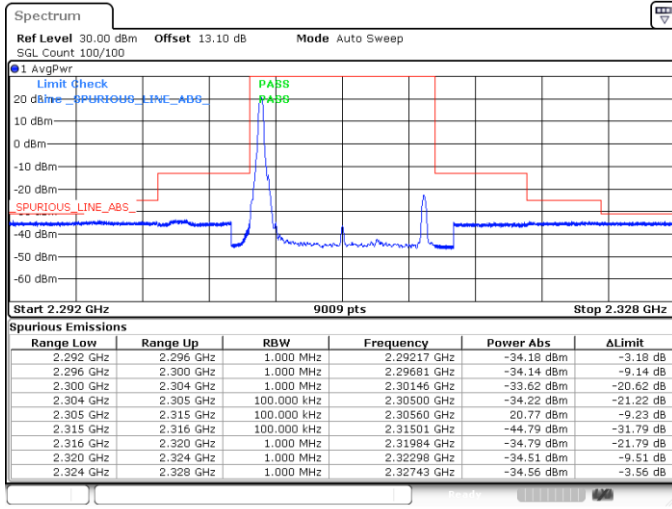

Date: 25.JAN.2018 20:52:08

Date: 25.JAN.2018 20:54:31

Band Edge / Full RB

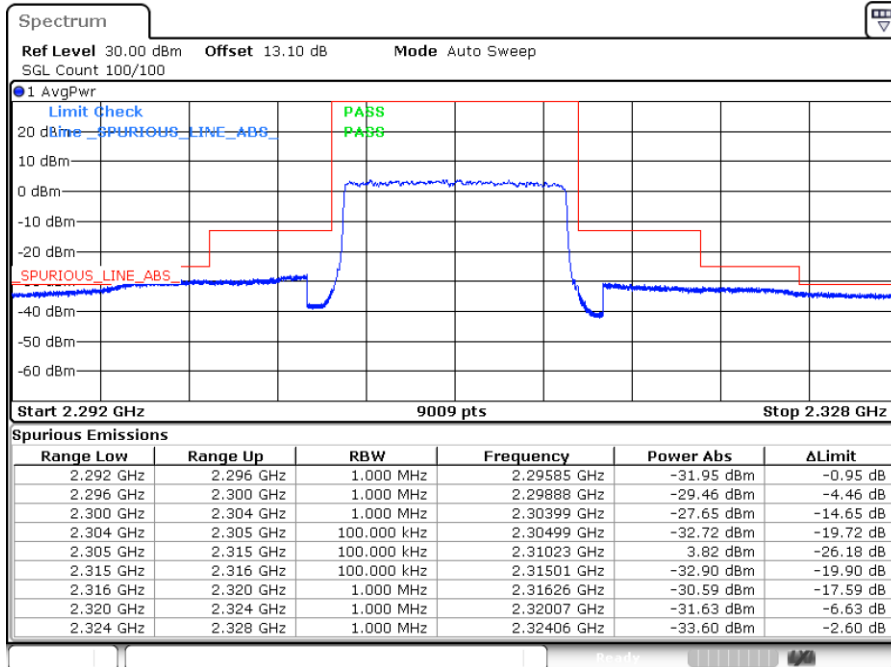

Date: 25.JAN.2018 20:56:53



LTE Band 30 / 10MHz / 16QAM

Lowest Band Edge / 1 RB

Highest Band Edge / 1 RB

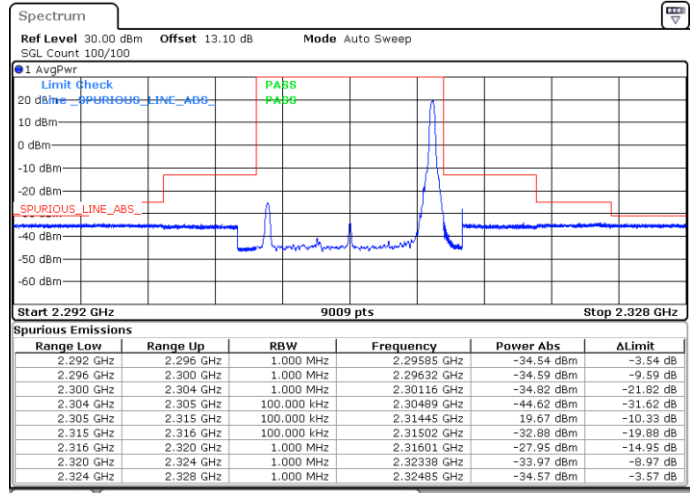
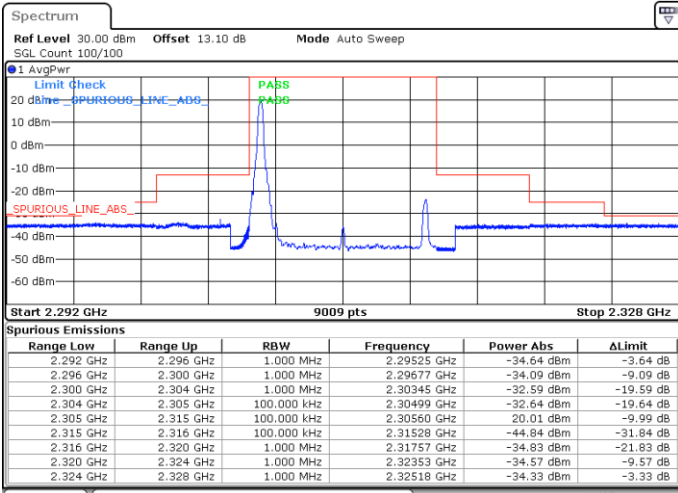

Date: 25.JAN.2018 20:53:20

Date: 25.JAN.2018 20:55:42

Band Edge / Full RB

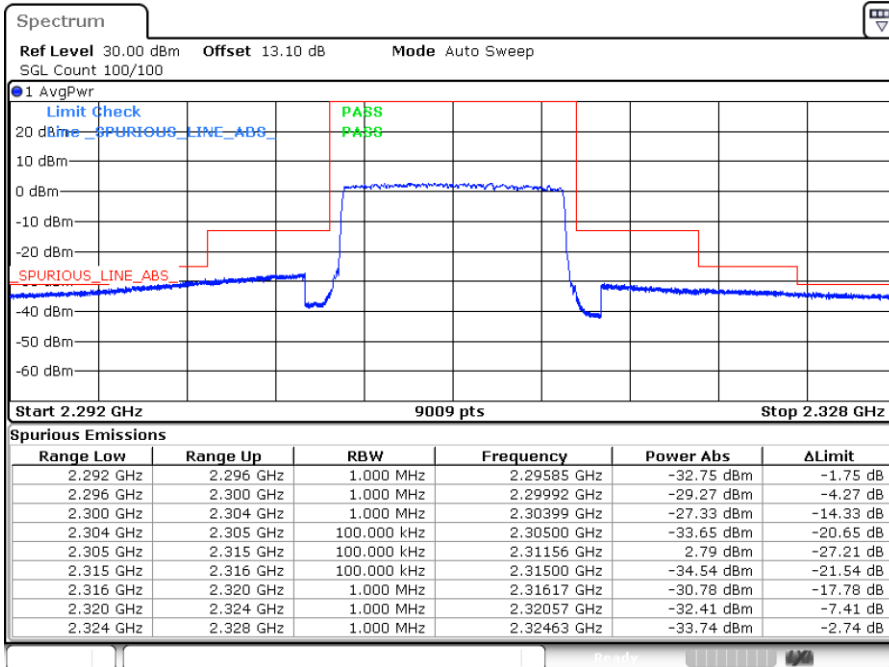

Date: 25.JAN.2018 20:58:04



Conducted Spurious Emission

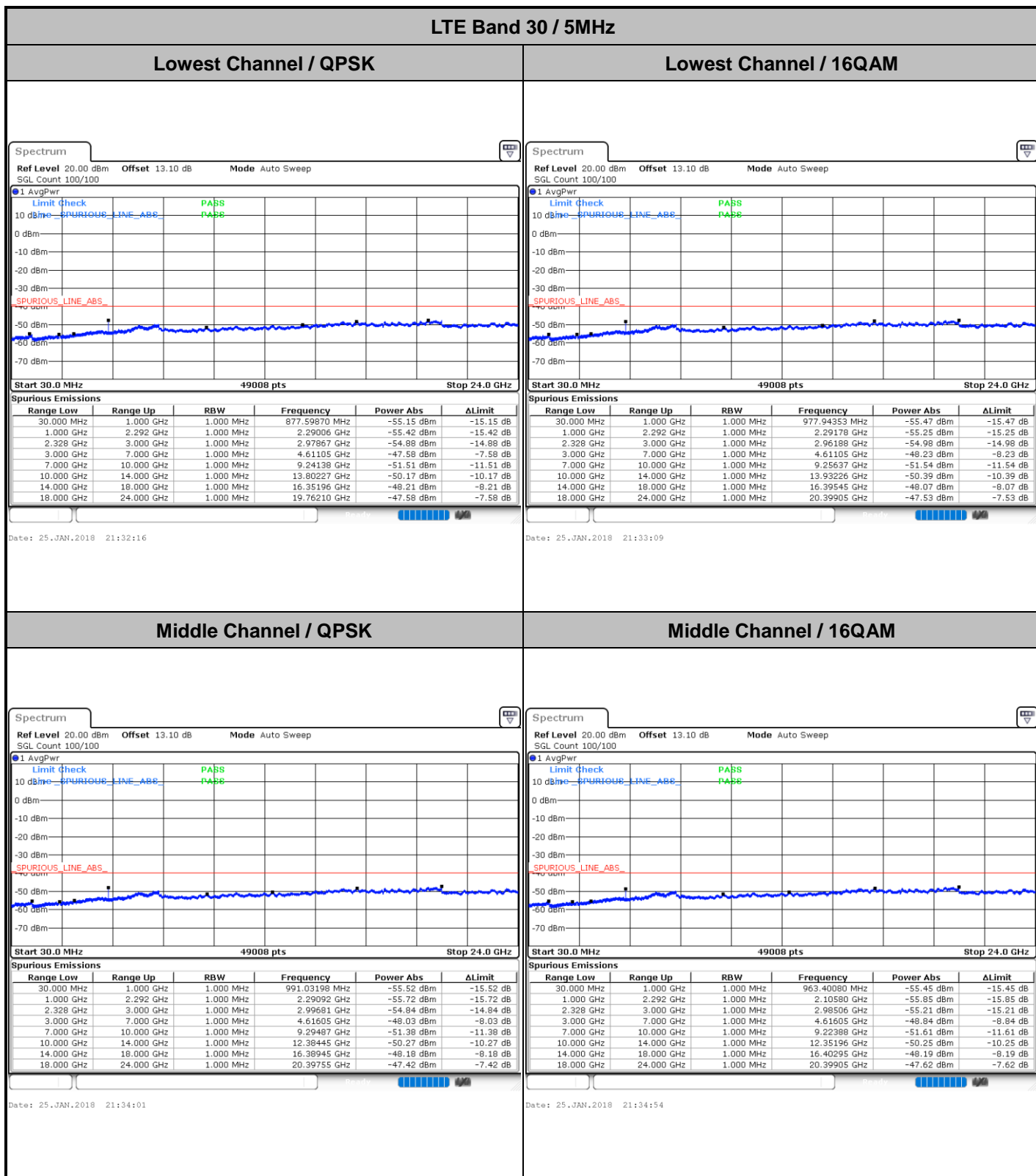



LTE Band 30 / 5MHz

Highest Channel / QPSK

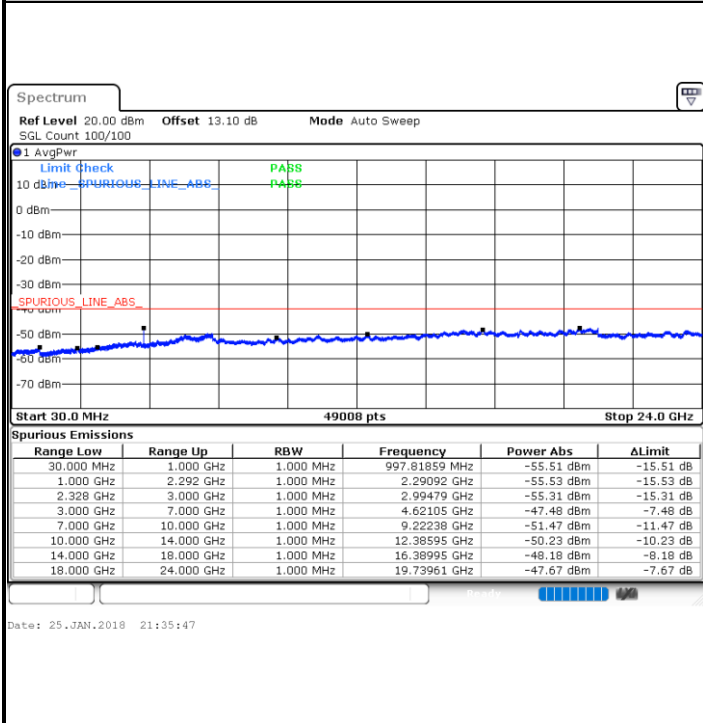

Highest Channel / 16QAM

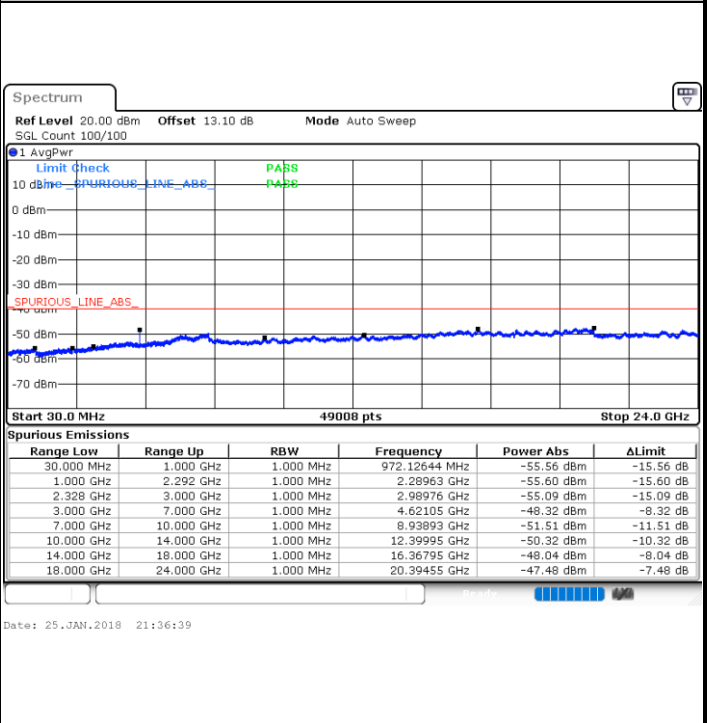

LTE Band 30 / 10MHz

Middle Channel / QPSK

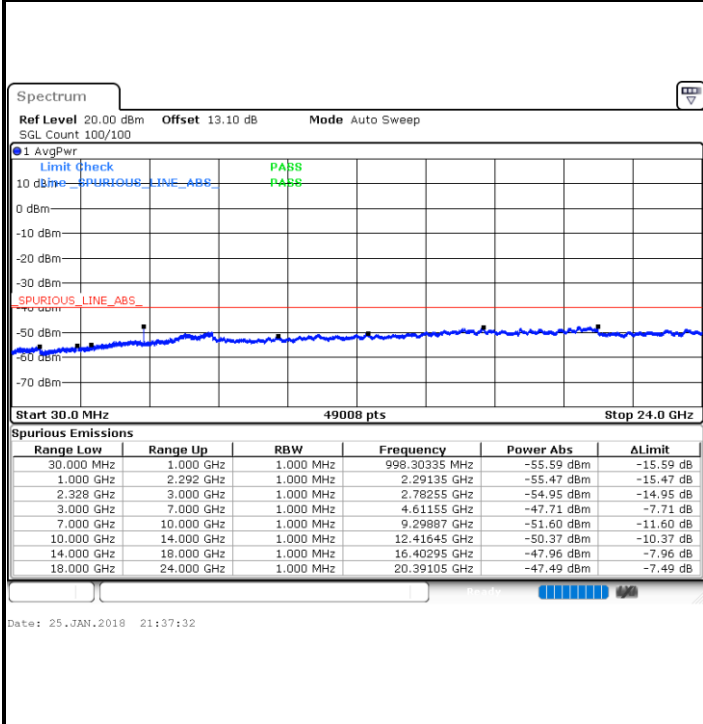

Middle Channel / 16QAM

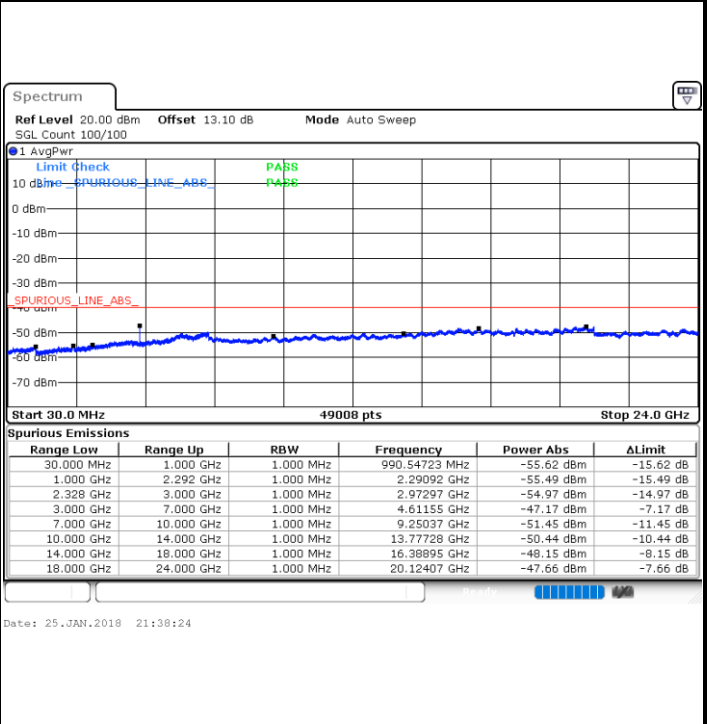



Frequency Stability

Test Conditions		LTE Band 30 (QPSK) / Middle Channel	Limit
Temperature (°C)	Voltage (Volt)	BW 10MHz	Note 2.
		Deviation (ppm)	Result
50	Normal Voltage	0.0002	PASS
40	Normal Voltage	0.0003	
30	Normal Voltage	0.0023	
20(Ref.)	Normal Voltage	0.0000	
10	Normal Voltage	0.0006	
0	Normal Voltage	0.0003	
-10	Normal Voltage	0.0001	
-20	Normal Voltage	0.0017	
-30	Normal Voltage	0.0004	
20	Maximum Voltage	0.0020	
20	Normal Voltage	0.0000	
20	Battery End Point	0.0023	

Note:

1. Normal Voltage =3.8 V. ; Battery End Point (BEP) =3.5 V. ; Maximum Voltage =4.4 V.
2. The frequency fundamental emissions stay within the authorized frequency block.



Appendix B. Test Results of ERP/EIRP and Radiated Test

ERP/EIRP

LTE Band 30 / 5MHz (Average) (GT - LC = -3.56 dB)							
Channel	Mode	RB		Conducted		EIRP	
		Size	Offset	Power (dBm)	Power (Watts)	EIRP(dBm)	EIRP(W)
Lowest	QPSK	1	12	22.70	0.1862	19.14	0.0820
Middle		1	12	22.76	0.1888	19.20	0.0832
Highest		1	12	22.64	0.1837	19.08	0.0809
Lowest	16QAM	1	0	22.15	0.1641	18.59	0.0723
Middle		1	0	22.12	0.1629	18.56	0.0718
Highest		1	0	22.06	0.1607	18.50	0.0708
Limit	EIRP < 0.25W			Result		PASS	

LTE Band 30 / 10MHz (Average) (GT - LC = -3.56 dB)							
Channel	Mode	RB		Conducted		EIRP	
		Size	Offset	Power (dBm)	Power (Watts)	EIRP(dBm)	EIRP(W)
Lowest	QPSK	-	-	-	-	-	-
Middle		1	49	22.77	0.1892	19.21	0.0834
Highest		-	-	-	-	-	-
Lowest	16QAM	-	-	-	-	-	-
Middle		1	0	22.12	0.1629	18.56	0.0718
Highest		-	-	-	-	-	-
Limit	EIRP < 0.25W			Result		PASS	



Radiated Spurious Emission

LTE Band 30

LTE Band 30 / 10MHz / QPSK									
Channel	Frequency (MHz)	EIRP (dBm)	Limit (dBm)	Over Limit (dB)	SPA Reading (dBm)	S.G. Power (dBm)	TX Cable loss (dB)	TX Antenna Gain (dBi)	Polarization (H/V)
Middle	4608	-59.72	-40	-19.72	-73.13	-69.77	2.05	12.10	H
	6918	-56.25	-40	-16.25	-72.83	-64.84	2.39	10.98	H
	9225	-49.55	-40	-9.55	-72.3	-59.45	2.23	12.13	H
									H
									H
									H
									H
	4608	-58.97	-40	-18.97	-73.08	-69.02	2.05	12.10	V
	6918	-55.20	-40	-15.20	-72.91	-63.79	2.39	10.98	V
	9225	-50.83	-40	-10.83	-72.58	-60.73	2.23	12.13	V
									V
									V
									V
									V

Remark: Spurious emissions within 30-1000MHz were found more than 20dB below limit line.