



FCC RF Test Report

APPLICANT : Motorola Mobility LLC
EQUIPMENT : Mobile Cellular Phone
BRAND NAME : Motorola
MODEL NAME : XT1921-2
FCC ID : IHDT56XC4
STANDARD : FCC Part 15 Subpart E §15.407
CLASSIFICATION : (NII) Unlicensed National Information Infrastructure

This is a variant report. The product was received on Dec. 20, 2017 and testing was completed on Jan. 19, 2018. We, SPORTON INTERNATIONAL INC., would like to declare that the tested sample has been evaluated in accordance with the test procedures and has been in compliance with the applicable technical standards.

The test results in this report apply exclusively to the tested model / sample. Without written approval of SPORTON INTERNATIONAL INC., the test report shall not be reproduced except in full.

Reviewed by: Joseph Lin / Supervisor

Approved by: Jones Tsai / Manager



SPORTON INTERNATIONAL INC.

No. 52, Hwa Ya 1st Rd., Hwa Ya Technology Park, Kwei-Shan District, Tao Yuan City, Taiwan, R.O.C.

SPORTON INTERNATIONAL INC.

TEL : 886-3-327-3456

FAX : 886-3-328-4978

FCC ID: IHDT56XC4

Page Number : 1 of 20

Report Issued Date : Feb. 23, 2018

Report Version : Rev. 01

Report Template No.: BU5-FR15EWLAC MA Version 2.0



TABLE OF CONTENTS

REVISION HISTORY..... 3

SUMMARY OF TEST RESULT 4

1 GENERAL DESCRIPTION 5

 1.1 Applicant 5

 1.2 Manufacturer 5

 1.3 Product Feature of Equipment Under Test 5

 1.4 Product Specification of Equipment Under Test 6

 1.5 Modification of EUT 6

 1.6 Testing Location 7

 1.7 Applicable Standards 7

2 TEST CONFIGURATION OF EQUIPMENT UNDER TEST 8

 2.1 Carrier Frequency and Channel 8

 2.2 Test Mode 9

 2.3 Connection Diagram of Test System 10

 2.4 Support Unit used in test configuration and system 10

 2.5 EUT Operation Test Setup 10

3 TEST RESULT 11

 3.1 Maximum Conducted Output Power Measurement 11

 3.2 Unwanted Emissions Measurement 13

 3.3 Antenna Requirements 18

4 LIST OF MEASURING EQUIPMENT 19

5 UNCERTAINTY OF EVALUATION 20

APPENDIX A. CONDUCTED TEST RESULTS

APPENDIX B. RADIATED SPURIOUS EMISSION

APPENDIX C. RADIATED SPURIOUS EMISSION PLOTS

APPENDIX D. DUTY CYCLE PLOTS

APPENDIX E. ORIGINAL REPORT



SUMMARY OF TEST RESULT

Report Section	FCC Rule	Description	Limit	Result	Remark
-	2.1049 & 15.403(i)	26dB & 99% Bandwidth	-	Not Required	-
3.1	15.407(a)	Maximum Conducted Output Power	≤ 30 dBm for Band 1, and 24 dBm for Band 2 / 3	Pass	-
-	15.407(a)	Power Spectral Density	≤ 17 dBm for Band 1, and 11 dBm for Band 2 / 3	Not Required	-
3.2	15.407(b)	Unwanted Emissions	15.407(b) & 15.209(a)	Pass	Under limit 6.59 dB at 5350.320 MHz
-	15.207	AC Conducted Emission	15.207(a)	Not Required	-
-	15.407(c)	Automatically Discontinue Transmission	Discontinue Transmission	Not Required	-
3.3	15.203 & 15.407(a)	Antenna Requirement	N/A	Pass	-

Remark:

1. This is a variant report which can be referred Product Equality Declaration. All the test cases were performed on original report which can be referred to Sporton Report Number FR7D2018D. Based on the original report, the test cases were verified.
2. Not required means after assessing, test items are not necessary to carry out.



1 General Description

1.1 Applicant

Motorola Mobility LLC
222 W. Merchandise Mart Plaza, Chicago IL 60654, USA

1.2 Manufacturer

Motorola Mobility LLC
222 W. Merchandise Mart Plaza, Chicago IL 60654, USA

1.3 Product Feature of Equipment Under Test

Product Feature	
Equipment	Mobile Cellular Phone
Brand Name	Motorola
Model Name	XT1921-2
FCC ID	IHDT56XC4
IMEI Code	351840090009741
EUT supports Radios application	GSM/EGPRS/WCDMA/HSPA/LTE/FM/GNSS WLAN 11b/g/n HT20 WLAN 11a/n HT20/HT40 Bluetooth BR/EDR/LE
HW Version	DVT1B
EUT Stage	Identical Prototype

Remark: The above EUT's information was declared by manufacturer. Please refer to the specifications or user's manual for more detailed description.

Accessory List	
AC Adapter 1	Brand Name : Motorola
	Model Name : C-P56
AC Adapter 2	Brand Name : Motorola
	Model Name : C-P56
Battery	Brand Name : Motorola
	Model Name : GK40
USB Cable	Brand Name : Saibao
	Model Name : SWT-A083A



1.4 Product Specification of Equipment Under Test

Standards-related Product Specification	
Tx/Rx Channel Frequency Range	5180 MHz ~ 5240 MHz 5260 MHz ~ 5320 MHz 5500 MHz ~ 5700 MHz
Maximum Output Power	<5180 MHz ~ 5240 MHz> 802.11a : 15.94 dBm / 0.0393 W 802.11n HT20 : 10.94 dBm / 0.0124 W 802.11n HT40 : 9.85 dBm / 0.0097 W <5260 MHz ~ 5320 MHz> 802.11a : 15.99 dBm / 0.0397 W 802.11n HT20 : 10.96 dBm / 0.0125 W 802.11n HT40 : 9.90 dBm / 0.0098 W <5500 MHz ~ 5700 MHz> 802.11a : 15.99 dBm / 0.0397 W 802.11n HT20 : 10.97 dBm / 0.0125 W 802.11n HT40 : 9.83 dBm / 0.0096 W
Antenna Type / Gain	<5150 MHz ~ 5250 MHz> PIFA Antenna with gain -3.78 dBi <5250 MHz ~ 5350 MHz> PIFA Antenna with gain -3.53 dBi <5470 MHz ~ 5725 MHz> PIFA Antenna with gain -3.97 dBi
Type of Modulation	802.11a/n : OFDM (BPSK / QPSK / 16QAM / 64QAM)

1.5 Modification of EUT

No modifications are made to the EUT during all test items.



1.6 Testing Location

Sporton Lab is accredited to ISO 17025 by Taiwan Accreditation Foundation (TAF code : 1190) and the FCC designation No. TW1190 and TW0007 under the FCC 2.948(e) by Mutual Recognition Agreement (MRA) in FCC Test.

Test Site	SPORTON INTERNATIONAL INC.
Test Site Location	No. 52, Hwa Ya 1 st Rd., Hwa Ya Technology Park, Kwei-Shan District, Tao Yuan City, Taiwan, R.O.C. TEL: +886-3-327-3456 FAX: +886-3-328-4978
Test Site No.	Sporton Site No. TH05-HY

Note: The test site complies with ANSI C63.4 2014 requirement.

Test Site	SPORTON INTERNATIONAL INC.
Test Site Location	No.58, Aly. 75, Ln. 564, Wenhua 3rd Rd. Guishan Dist, Taoyuan City, Taiwan (R.O.C.) TEL: +886-3-327-0868 FAX: +886-3-327-0855
Test Site No.	Sporton Site No. 03CH11-HY

Note: The test site complies with ANSI C63.4 2014 requirement.

1.7 Applicable Standards

According to the specifications of the manufacturer, the EUT must comply with the requirements of the following standards:

- ♦ FCC Part 15 Subpart E
- ♦ FCC KDB 789033 D02 General UNII Test Procedures New Rules v02r01.
- ♦ ANSI C63.10-2013

Remark:

1. All test items were verified and recorded according to the standards and without any deviation during the test.
2. This EUT has also been tested and complied with the requirements of FCC Part 15, Subpart B, recorded in a separate test report.



2 Test Configuration of Equipment Under Test

The EUT has been associated with peripherals and configuration operated in a manner tended to maximize its emission characteristics in a typical application. Frequency range investigated:, radiation emission (9 kHz to the 10th harmonic of the highest fundamental frequency or to 40 GHz, whichever is lower). For radiated measurement, pre-scanned in three orthogonal panels, X, Y, Z. The worst cases (X plane) were recorded in this report.

2.1 Carrier Frequency and Channel

Frequency Band	Channel	Freq. (MHz)	Channel	Freq. (MHz)
5150-5250 MHz Band 1 (U-NII-1)	36	5180	44	5220
	38*	5190	46*	5230
	40	5200	48	5240
	-	-		

Frequency Band	Channel	Freq. (MHz)	Channel	Freq. (MHz)
5250-5350 MHz Band 2 (U-NII-2A)	52	5260	60	5300
	54*	5270	62*	5310
	56	5280	64	5320
	-	-		

Frequency Band	Channel	Freq. (MHz)	Channel	Freq. (MHz)
5470-5725 MHz Band 3 (U-NII-2C)	100	5500	112	5560
	102*	5510	116	5580
	104	5520	132	5660
	-	-	134*	5670
	108	5540	136	5680
	110*	5550	140	5700

Frequency Band	Channel	Freq. (MHz)	Channel	Freq. (MHz)
TDWR Channel	118*	5590	124	5620
	120	5600	126*	5630
	-	-	128	5640

Note: The above Frequency and Channel in "*" were 802.11n HT40.



2.2 Test Mode

Final test modes are considering the modulation and worse data rates as below table.

Modulation	Data Rate
802.11n HT40	MCS0
Remark: For Radiated Test Cases, The tests were performance with Adapter 1.	

Ch. #		Band I : 5150-5250 MHz	Band II : 5250-5350 MHz	Band III : 5470-5725MHz
		802.11n HT40	802.11n HT40	802.11n HT40
L	Low	38	-	102
M	Middle	-	-	-
H	High	-	62	-

2.3 Connection Diagram of Test System

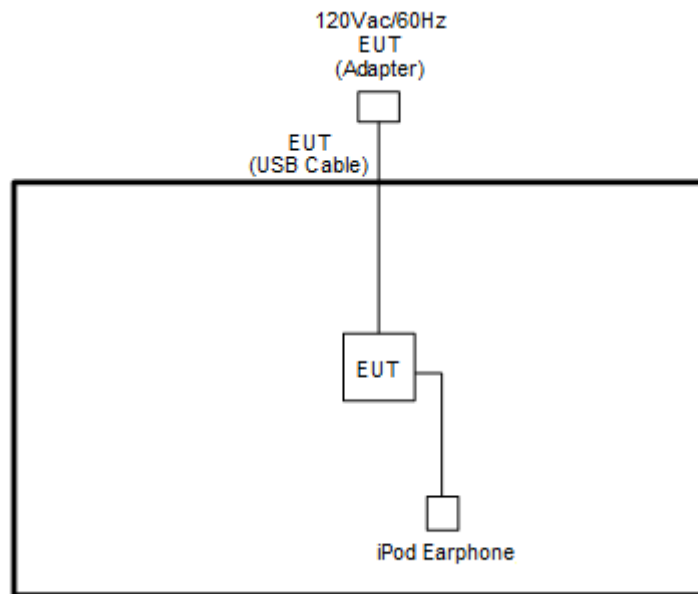

2.4 Support Unit used in test configuration and system

Equipment	Trade Name	Model Name	FCC ID	Data Cable	Power Cord
iPod Earphone	Apple	N/A	Verification	Unshielded, 1.0 m	N/A

2.5 EUT Operation Test Setup

The RF test items, utility “QRCT” was installed in Notebook which was programmed in order to make the EUT get into the engineering modes to provide channel selection, power level, data rate and the application type and for continuous transmitting signals.



3 Test Result

3.1 Maximum Conducted Output Power Measurement

3.1.1 Limit of Maximum Conducted Output Power

<FCC 14-30 CFR 15.407>

For mobile and portable client devices in the 5.15–5.25 GHz band, the maximum conducted output power over the frequency band of operation shall not exceed 250 mW.

For the 5.25–5.725 GHz bands, the maximum conducted output power over the frequency bands of operation shall not exceed the lesser of 250 mW or $11 \text{ dBm} + 10 \log B$, where B is the 26 dB emission bandwidth in megahertz.

If transmitting antennas of directional gain greater than 6 dBi are used, the peak output power shall be reduced by the amount in dB that the directional gain of the antenna exceeds 6 dBi.

Note that U-NII-2 band, devices with a maximum e.i.r.p. greater than 500 mW shall implement TPC in order to have the capability to operate at least 6 dB below the maximum permitted e.i.r.p. of 1 W.

3.1.2 Measuring Instruments

The measuring equipment is listed in the section 4 of this test report.

3.1.3 Test Procedures

The testing follows Method PM of FCC KDB 789033 D02 General UNII Test Procedures New Rules v02r01.

Method PM (Measurement using an RF average power meter):

1. Measurement is performed using a wideband RF power meter.
2. The EUT is configured to transmit continuously with a consistent duty cycle at its maximum power control level.
3. Measure the average power of the transmitter, and the average power is corrected with duty factor, $10 \log(1/x)$, where x is the duty cycle.

3.1.4 Test Setup

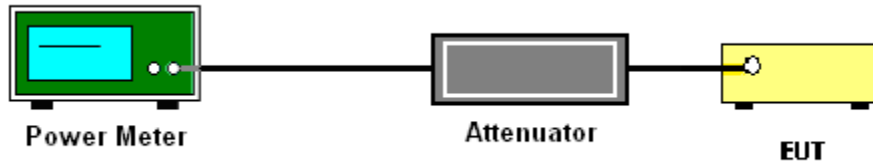

3.1.5 Test Result of Maximum Conducted Output Power

Please refer to Appendix A.



3.2 Unwanted Emissions Measurement

This section is to measure unwanted emissions through radiated measurement for band edge spurious emissions and out of band emissions measurement.

3.2.1 Limit of Unwanted Emissions

- (1) For transmitters operating in the 5150-5250 MHz band: all emissions outside of the 5150-5350 MHz band shall not exceed an EIRP of -27dBm/MHz.

For transmitters operating in the 5250-5350 MHz band: all emissions outside of the 5150-5350 MHz band shall not exceed an EIRP of -27 dBm/MHz. Devices operating in the 5250-5350 MHz band that generate emissions in the 5150-5250 MHz band must meet all applicable technical requirements for operation in the 5150-5250 MHz band (including indoor use) or alternatively meet an out-of-band emission EIRP limit of -27 dBm/MHz in the 5150-5250 MHz band.

For transmitters operating in the 5470-5600 MHz and 5650-5725MHz band: all emissions outside of the 5470-5600 MHz and 5650-5725MHz band shall not exceed an EIRP of -27 dBm/MHz.

- (2) Unwanted spurious emissions fallen in restricted bands shall comply with the general field strength limits as below table,

Frequency (MHz)	Field Strength (microvolts/meter)	Measurement Distance (meters)
0.009 – 0.490	2400/F(kHz)	300
0.490 – 1.705	24000/F(kHz)	30
1.705 – 30.0	30	30
30 – 88	100	3
88 – 216	150	3
216 - 960	200	3
Above 960	500	3

Note: The following formula is used to convert the EIRP to field strength.

$$E = \frac{1000000\sqrt{30P}}{3} \mu V/m, \text{ where } P \text{ is the eirp (Watts)}$$



EIRP (dBm)	Field Strength at 3m (dBµV/m)
-17	78.3
- 27	68.3

(3) KDB789033 D02 v02r01 G)2)c)

- (i) Section 15.407(b)(1) to (b)(3) specify the unwanted emission limits for the U-NII-1 and U-NII-2 bands. As specified, emissions above 1000 MHz that are outside of the restricted bands are subject to a peak emission limit of -27 dBm/MHz.³
- (ii) Section 15.407(b)(4) specifies the unwanted emission limit for the U-NII-3 band. A band emissions mask is specified in Section 15.407(b)(4)(i). The emission limits are in terms of a Peak detector. An alternative to the band emissions mask is specified in Section 15.407(b)(4)(ii). The alternative limits are based on the highest antenna gain specified in the filing. There are also marketing and importation restrictions for the devices using the alternative limit.⁴

Note 3: An out-of-band emission that complies with both the average and peak limits of Section 15.209 is not required to satisfy the -27 dBm/MHz peak emission limit.

Note 4: Only devices with antenna gains of 10 dBi or less may be approved using the emission limits specified in Section 15.247(d) till March 2, 2018; all other devices operating in this band must use the mask specified in Section 15.407(b)(4)(i).

3.2.2 Measuring Instruments

The measuring equipment is listed in the section 4 of this test report.



3.2.3 Test Procedures

1. The testing follows FCC KDB 789033 D02 General UNII Test Procedures New Rules v02r01. Section G) Unwanted emissions measurement.
 - (1) Procedure for Unwanted Emissions Measurements Below 1000MHz
 - RBW = 120 kHz
 - VBW = 300 kHz
 - Detector = Peak
 - Trace mode = max hold
 - (2) Procedure for Peak Unwanted Emissions Measurements Above 1000 MHz
 - RBW = 1 MHz
 - VBW \geq 3 MHz
 - Detector = Peak
 - Sweep time = auto
 - Trace mode = max hold
 - (3) Procedures for Average Unwanted Emissions Measurements Above 1000MHz
 - RBW = 1 MHz
 - VBW = 10 Hz, when duty cycle is no less than 98 percent.
 - VBW \geq 1/T, when duty cycle is less than 98 percent where T is the minimum transmission duration over which the transmitter is on and is transmitting at its maximum power control level for the tested mode of operation.
2. The EUT was placed on a turntable with 0.8 meter for frequency below 1GHz and 1.5 meter for frequency above 1GHz respectively above ground.
3. The EUT was set 3 meters from the interference receiving antenna which was mounted on the top of a variable height antenna tower.
4. The antenna is a broadband antenna and its height is adjusted between one meter and four meters above ground to find the maximum value of the field strength for both horizontal polarization and vertical polarization of the antenna.
5. For each suspected emission, the EUT was arranged to its worst case and then adjust the antenna tower (from 1 m to 4 m) and turntable (from 0 degree to 360 degrees) to find the maximum reading.
6. For testing below 1GHz, if the emission level of the EUT in peak mode was 3 dB lower than the limit specified, then peak values of EUT will be reported, otherwise, the emissions will be repeated one by one using the CISPR quasi-peak method and reported.

- For testing above 1GHz, the emission level of the EUT in peak mode was 20dB lower than average limit (that means the emission level in average mode also complies with the limit in average mode), then peak values of EUT will be reported, otherwise, the emissions will be measured in average mode again and reported.

3.2.4 Test Setup

For radiated emissions below 30MHz

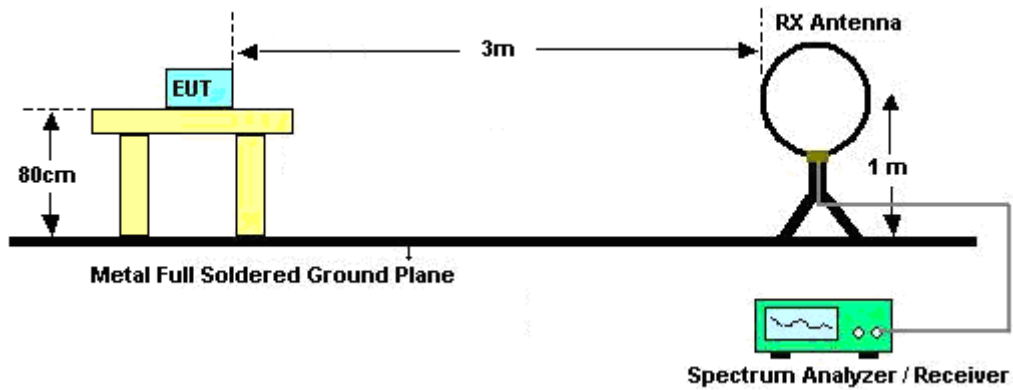

For radiated emissions from 30MHz to 1GHz

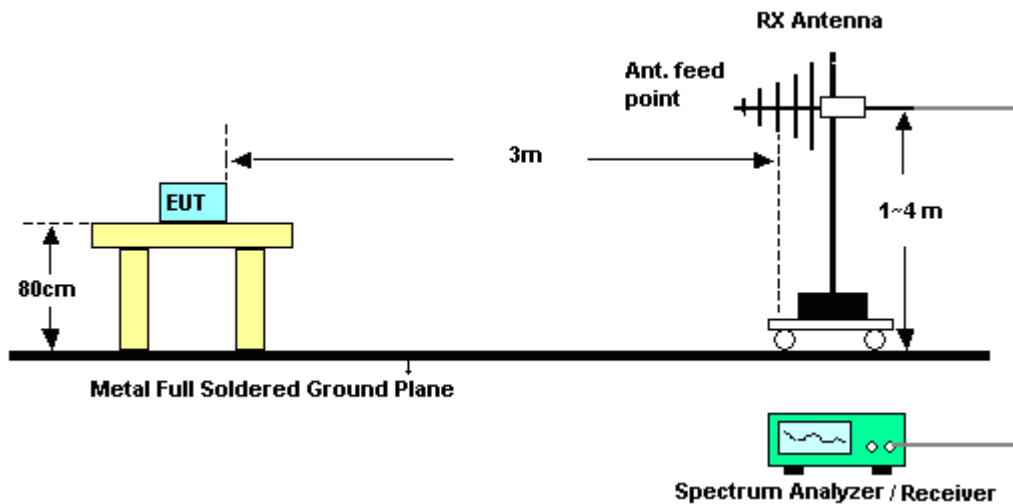

For radiated emissions above 1GHz

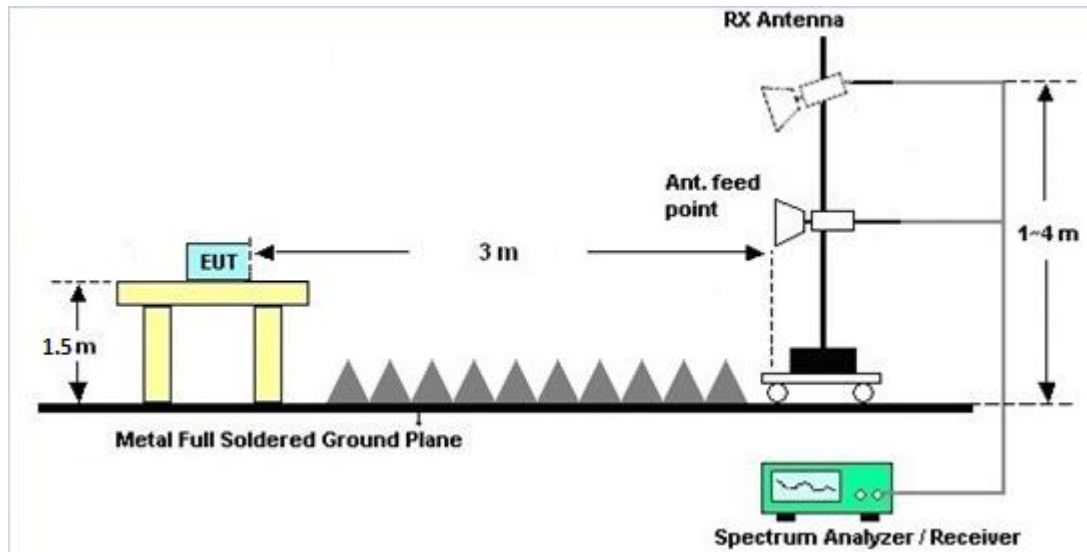

3.2.5 Test Results of Radiated Spurious Emissions (9 kHz ~ 30 MHz)

The low frequency, which started from 9 kHz to 30MHz, was pre-scanned and the result which was 20dB lower than the limit line was not reported.

There is a comparison data of both open-field test site and semi-Anechoic chamber, and the result came out very similar.

3.2.6 Test Result of Radiated Spurious at Band Edges

Please refer to Appendix B and C.

3.2.7 Duty Cycle

Please refer to Appendix D.

3.2.8 Test Result of Radiated Spurious Emissions (30MHz ~ 10th Harmonic)

Please refer to Appendix B and C.



3.3 Antenna Requirements

3.3.1 Standard Applicable

If transmitting antenna directional gain is greater than 6 dBi, both the peak transmit power and the peak power spectral density shall be reduced by the amount in dB that the directional gain of the antenna exceeds 6 dBi.

3.3.2 Antenna Anti-Replacement Construction

An embedded-in antenna design is used.

3.3.3 Antenna Gain

The antenna peak gain of EUT is less than 6 dBi. Therefore, it is not necessary to reduce maximum peak output power limit.



4 List of Measuring Equipment

Instrument	Manufacturer	Model No.	Serial No.	Characteristics	Calibration Date	Test Date	Due Date	Remark
Power Meter	Anritsu	ML2495A	1240001	N/A	Sep. 07, 2017	Jan. 05, 2018~ Jan. 17, 2018	Sep. 06, 2018	Conducted (TH05-HY)
Power Sensor	Anritsu	MA2411B	1207349	300MHz~40GHz	Sep. 07, 2017	Jan. 05, 2018~ Jan. 17, 2018	Sep. 06, 2018	Conducted (TH05-HY)
Spectrum Analyzer	Rohde & Schwarz	FSP40	100055	9kHz~40GHz	Jun. 20, 2017	Jan. 05, 2018~ Jan. 17, 2018	Jun. 19, 2018	Conducted (TH05-HY)
Temperature Chamber	ESPEC	SH-641	92013720	-40℃ ~90℃	Aug. 28, 2017	Jan. 05, 2018~ Jan. 17, 2018	Aug. 27, 2018	Conducted (TH05-HY)
Amplifier	MITEQ	TTA1840-3 5-HG	1871923	18GHz~40GHz,VS WR : 2.5:1 max	Jul. 18, 2017	Jan. 08, 2018 ~ Jan. 19, 2018	Jul. 17, 2018	Radiation (03CH11-HY)
Amplifier	SONOMA	310N	187312	9kHz~1GHz	Nov. 10, 2016	Jan. 08, 2018 ~ Jan. 19, 2018	Nov. 09, 2018	Radiation (03CH11-HY)
Bilog Antenna	TESEQ	CBL 6111D&N- 6-06	35414&AT- N0602	30MHz~1GHz	Oct. 14, 2017	Jan. 08, 2018 ~ Jan. 19, 2018	Oct. 13, 2018	Radiation (03CH11-HY)
Horn Antenna	SCHWARZBEC K	BBHA 9120 D	9120D-132 6	1GHz ~ 18GHz	Oct. 16, 2017	Jan. 08, 2018 ~ Jan. 19, 2018	Oct. 15, 2018	Radiation (03CH11-HY)
Loop Antenna	Rohde & Schwarz	HFH2-Z2	100488	9 kHz~30 MHz	Nov. 23, 2017	Jan. 08, 2018 ~ Jan. 19, 2018	Nov. 22, 2019	Radiation (03CH11-HY)
Preamplifier	Keysight	83017A	MY532700 80	1GHz~26.5GHz	Nov. 10, 2016	Jan. 08, 2018 ~ Jan. 19, 2018	Nov. 09, 2018	Radiation (03CH11-HY)
Spectrum Analyzer	Keysight	N9010A	MY542004 86	10Hz ~ 44GHz	Oct. 19, 2017	Jan. 08, 2018 ~ Jan. 19, 2018	Oct. 18, 2018	Radiation (03CH11-HY)
Antenna Mast	EMEC	AM-BS-45 00-B	N/A	1~4m	N/A	Jan. 08, 2018 ~ Jan. 19, 2018	N/A	Radiation (03CH11-HY)
Turn Table	EMEC	TT 2000	N/A	0~360 Degree	N/A	Jan. 08, 2018 ~ Jan. 19, 2018	N/A	Radiation (03CH11-HY)
SHF-EHF Horn Antenna	SCHWARZBEC K	BBHA 9170	BBHA9170 584	18GHz- 40GHz	Nov. 27, 2017	Jan. 08, 2018 ~ Jan. 19, 2018	Nov. 26, 2018	Radiation (03CH11-HY)
Preamplifier	MITEQ	AMF-7D-0 0101800	2025787	1GHz~18GHz	Feb. 13, 2017	Jan. 08, 2018 ~ Jan. 19, 2018	Feb. 12, 2018	Radiation (03CH11-HY)



5 Uncertainty of Evaluation

Uncertainty of Radiated Emission Measurement (30 MHz ~ 1000 MHz)

Measuring Uncertainty for a Level of Confidence of 95% ($U = 2Uc(y)$)	5.20
---	------

Uncertainty of Radiated Emission Measurement (1000 MHz ~ 18000 MHz)

Measuring Uncertainty for a Level of Confidence of 95% ($U = 2Uc(y)$)	5.50
---	------

Uncertainty of Radiated Emission Measurement (18000 MHz ~ 40000 MHz)

Measuring Uncertainty for a Level of Confidence of 95% ($U = 2Uc(y)$)	5.20
---	------

Appendix A. Test Result of Conducted Test Items

Test Engineer:	White Lin/Reece Lin	Temperature:	21~25	°C
Test Date:	2018/01/05~2018/01/17	Relative Humidity:	51~54	%

TEST RESULTS DATA
Average Power Table

FCC Band I										
Mod.	Data Rate	NTX	CH.	Freq. (MHz)	Duty Factor (dB)	Average Conducted Power (dBm)	FCC Conducted Power Limit (dBm)	DG (dBi)		Pass/Fail
11a	6Mbps	1	36	5180	0.59	15.89	24.00	-3.78		Pass
11a	6Mbps	1	44	5220	0.59	15.91	24.00	-3.78		Pass
11a	6Mbps	1	48	5240	0.59	15.94	24.00	-3.78		Pass
HT20	MCS0	1	36	5180	0.63	10.91	24.00	-3.78		Pass
HT20	MCS0	1	44	5220	0.63	10.94	24.00	-3.78		Pass
HT20	MCS0	1	48	5240	0.63	10.85	24.00	-3.78		Pass
HT40	MCS0	1	38	5190	0.59	9.81	24.00	-3.78		Pass
HT40	MCS0	1	46	5230	0.59	9.85	24.00	-3.78		Pass

TEST RESULTS DATA
Average Power Table

FCC Band II										
Mod.	Data Rate	NTX	CH.	Freq. (MHz)	Duty Factor (dB)	Average Conducted Power (dBm)	FCC Conducted Power Limit (dBm)	DG (dBi)	EIRP Power Limit (dBm)	Pass/Fail
11a	6M bps	1	52	5260	0.59	15.98	23.98	-3.53	26.99	Pass
11a	6M bps	1	60	5300	0.59	15.99	23.98	-3.53	26.99	Pass
11a	6M bps	1	64	5320	0.59	15.97	23.98	-3.53	26.99	Pass
HT20	MCS 0	1	52	5260	0.63	10.91	23.98	-3.53	26.99	Pass
HT20	MCS 0	1	60	5300	0.63	10.96	23.98	-3.53	26.99	Pass
HT20	MCS 0	1	64	5320	0.63	10.93	23.98	-3.53	26.99	Pass
HT40	MCS 0	1	54	5270	0.59	9.90	23.98	-3.53	26.99	Pass
HT40	MCS 0	1	62	5310	0.59	9.61	23.98	-3.53	26.99	Pass

TEST RESULTS DATA
Average Power Table

FCC Band III										
Mod.	Data Rate	NTX	CH.	Freq. (MHz)	Duty Factor (dB)	Average Conducted Power (dBm)	FCC Conducted Power Limit (dBm)	DG (dBi)	EIRP Power Limit (dBm)	Pass/Fail
11a	6M bps	1	100	5500	0.59	15.95	23.98	-3.97	26.99	Pass
11a	6M bps	1	116	5580	0.59	15.96	23.98	-3.97	26.99	Pass
11a	6M bps	1	140	5700	0.59	15.99	23.98	-3.97	26.99	Pass
HT20	MCS 0	1	100	5500	0.63	10.96	23.98	-3.97	26.99	Pass
HT20	MCS 0	1	116	5580	0.63	10.86	23.98	-3.97	26.99	Pass
HT20	MCS 0	1	140	5700	0.63	10.97	23.98	-3.97	26.99	Pass
HT40	MCS 0	1	102	5510	0.59	9.75	23.98	-3.97	26.99	Pass
HT40	MCS 0	1	110	5550	0.59	9.77	23.98	-3.97	26.99	Pass
HT40	MCS 0	1	134	5670	0.59	9.83	23.98	-3.97	26.99	Pass



Appendix B. Radiated Spurious Emission

Test Engineer :	Hao Hsu, Jacky Hung, and Ken Wu	Temperature :	23~26°C
		Relative Humidity :	50~55%

Band 1 - 5150~5250MHz

WIFI 802.11n HT40 (Band Edge @ 3m)

WIFI	Note	Frequency	Level	Over	Limit	Read	Antenna	Cable	Preamp	Ant	Table	Peak	Pol.
		(MHz)	(dBμV/m)	(dB)	(dBμV/m)	(dBμV)	(dB/m)	(dB)	(dB)	(cm)	(deg)	(P/A)	(H/V)
802.11n HT40 CH 38 5190MHz		5146.9	56.32	-17.68	74	48.55	31.75	9.05	33.03	100	299	P	H
		5148.98	47.38	-6.62	54	39.61	31.75	9.05	33.03	100	299	A	H
	*	5190	99.03	-	-	91.19	31.78	9.09	33.03	100	299	P	H
	*	5190	91.07	-	-	83.23	31.78	9.09	33.03	100	299	A	H
		5455.52	47.69	-26.31	74	39.37	32.05	9.29	33.02	100	299	P	H
		5452.72	39.2	-14.8	54	30.88	32.05	9.29	33.02	100	299	A	H
		5150	51.68	-22.32	74	43.91	31.75	9.05	33.03	397	150	P	V
		5149.5	43.66	-10.34	54	35.89	31.75	9.05	33.03	397	150	A	V
	*	5190	96.03	-	-	88.19	31.78	9.09	33.03	397	150	P	V
	*	5190	88.19	-	-	80.35	31.78	9.09	33.03	397	150	A	V
		5389.44	48.04	-25.96	74	39.88	31.98	9.2	33.02	397	150	P	V
		5454.68	39.26	-14.74	54	30.94	32.05	9.29	33.02	397	150	A	V
Remark	1. No other spurious found. 2. All results are PASS against Peak and Average limit line.												



Band 1 5150~5250MHz
WIFI 802.11n HT40 (Harmonic @ 3m)

WIFI	Note	Frequency (MHz)	Level (dBµV/m)	Over Limit (dB)	Limit Line (dBµV/m)	Read Level (dBµV)	Antenna Factor (dB/m)	Cable Loss (dB)	Preamp Factor (dB)	Ant Pos (cm)	Table Pos (deg)	Peak Avg. (P/A)	Pol. (H/V)
802.11n HT40 CH 38 5190MHz		10380	47.11	-26.89	74	57.82	39.54	14.64	65.2	100	0	P	H
		15570	44.75	-29.25	74	52.53	37.91	17.98	64.05	100	0	P	H
													H
													H
5190MHz		10380	46.5	-27.5	74	57.21	39.54	14.64	65.2	100	0	P	V
		15570	44.48	-29.52	74	52.26	37.91	17.98	64.05	100	0	P	V
													V
													V
Remark	1. No other spurious found. 2. All results are PASS against Peak and Average limit line.												



Band 2 - 5250~5350MHz

WIFI 802.11n HT40 (Band Edge @ 3m)

WIFI	Note	Frequency	Level	Over	Limit	Read	Antenna	Cable	Preamp	Ant	Table	Peak	Pol.
		(MHz)	(dBμV/m)	(dB)	(dBμV/m)	(dBμV)	(dB/m)	(dB)	(dB)	(cm)	(deg)	(P/A)	(H/V)
802.11n HT40 CH 62 5310MHz		5069.36	48.29	-25.71	74	40.67	31.67	8.99	33.04	100	298	P	H
		5075.82	39.8	-14.2	54	32.17	31.68	8.99	33.04	100	298	A	H
	*	5310	98.67	-	-	90.62	31.92	9.16	33.03	100	298	P	H
	*	5310	90.57	-	-	82.52	31.92	9.16	33.03	100	298	A	H
		5351.04	56.39	-17.61	74	48.28	31.95	9.19	33.03	100	298	P	H
		5350.32	47.41	-6.59	54	39.3	31.95	9.19	33.03	100	298	A	H
		5075.82	50.5	-23.5	74	42.87	31.68	8.99	33.04	400	165	P	V
		5050.66	40.05	-13.95	54	32.47	31.65	8.97	33.04	400	165	A	V
	*	5310	95.55	-	-	87.5	31.92	9.16	33.03	400	165	P	V
	*	5310	87.99	-	-	79.94	31.92	9.16	33.03	400	165	A	V
		5439.84	48.8	-25.2	74	40.53	32.03	9.26	33.02	400	165	P	V
		5350.08	42.84	-11.16	54	34.73	31.95	9.19	33.03	400	165	A	V
Remark	1. No other spurious found. 2. All results are PASS against Peak and Average limit line.												



Band 2 5250~5350MHz
WIFI 802.11n HT40 (Harmonic @ 3m)

Table with 14 columns: WIFI, Note, Frequency (MHz), Level (dBµV/m), Over Limit (dB), Limit Line (dBµV/m), Read Level (dBµV), Antenna Factor (dB/m), Cable Loss (dB), Preamp Factor (dB), Ant Pos (cm), Table Pos (deg), Peak Avg. (P/A), Pol. (H/V). Rows include data for 802.11n HT40 CH 62 at 10620 and 15930 MHz, and a Remark section.



Band 3 - 5470~5725MHz

WIFI 802.11n HT40 (Band Edge @ 3m)

WIFI	Note	Frequency	Level	Over	Limit	Read	Antenna	Cable	Preamp	Ant	Table	Peak	Pol.
		(MHz)	(dBμV/m)	(dB)	(dBμV/m)	(dBμV)	(dB/m)	(dB)	(dB)	(cm)	(deg)	(P/A)	(H/V)
802.11n HT40 CH 102 5510MHz		5470	52.32	-21.68	74	43.98	32.07	9.29	33.02	100	285	P	H
		5470	44.97	-9.03	54	36.63	32.07	9.29	33.02	100	285	A	H
	*	5510	97.05	-	-	88.61	32.1	9.37	33.03	100	285	P	H
	*	5510	89.1	-	-	80.66	32.1	9.37	33.03	100	285	A	H
		5740.745	48.41	-25.59	74	39.15	32.53	9.88	33.15	100	285	P	H
		5759.645	40.51	-13.49	54	31.15	32.57	9.95	33.16	100	285	A	H
		5468.32	49.81	-24.19	74	41.47	32.07	9.29	33.02	388	150	P	V
		5469.52	40.97	-13.03	54	32.63	32.07	9.29	33.02	388	150	A	V
	*	5510	95.86	-	-	87.42	32.1	9.37	33.03	388	150	P	V
	*	5510	87.84	-	-	79.4	32.1	9.37	33.03	388	150	A	V
		5725	50.62	-23.38	74	41.44	32.5	9.81	33.13	388	150	P	V
		5753.345	40.43	-13.57	54	31.13	32.57	9.88	33.15	388	150	A	V
Remark	1. No other spurious found. 2. All results are PASS against Peak and Average limit line.												



Band 3 - 5470~5725MHz
WIFI 802.11n HT40 (Harmonic @ 3m)

WIFI	Note	Frequency (MHz)	Level (dBµV/m)	Over Limit (dB)	Limit Line (dBµV/m)	Read Level (dBµV)	Antenna Factor (dB/m)	Cable Loss (dB)	Preamp Factor (dB)	Ant Pos (cm)	Table Pos (deg)	Peak Avg. (P/A)	Pol. (H/V)
802.11n HT40 CH 102 5510MHz		11020	46.33	-27.67	74	55.94	40.1	15.11	65.11	100	0	P	H
		16530	44.25	-29.75	74	51.68	38.58	18.76	65.07	100	0	P	H
													H
													H
5510MHz		11020	47.35	-26.65	74	56.96	40.1	15.11	65.11	100	0	P	V
		16530	43.29	-30.71	74	50.72	38.58	18.76	65.07	100	0	P	V
													V
													V
Remark	1. No other spurious found. 2. All results are PASS against Peak and Average limit line.												



Emission below 1GHz
WIFI 802.11n HT40 (LF @ 3m)

WIFI	Note	Frequency	Level	Over	Limit	Read	Antenna	Cable	Preamp	Ant	Table	Peak	Pol.	
		(MHz)	(dBμV/m)	(dB)	(dBμV/m)	(dBμV)	(dB/m)	(dB)	(dB)	(cm)	(deg)	(P/A)	(H/V)	
802.11n HT40 LF		40.8	23.68	-16.32	40	36.66	18.68	0.82	32.49	-	-	P	H	
		48.9	25.49	-14.51	40	42.05	14.9	1.02	32.49	-	-	P	H	
		53.49	21.33	-18.67	40	39.81	12.98	1.02	32.49	-	-	P	H	
		550.6	26.89	-19.11	46	31.09	25.15	2.98	32.42	-	-	P	H	
		776.7	30.4	-15.6	46	31.02	27.99	3.49	32.25	-	-	P	H	
		959.4	33.6	-12.4	46	29.57	31.07	3.9	31.12	100	0	P	H	
													H	
													H	
													H	
													H	
													H	
													H	
			40.8	31.65	-8.35	40	44.63	18.68	0.82	32.49	-	-	P	V
			49.17	32.21	-7.79	40	49.19	14.48	1.02	32.49	100	58	P	V
			63.48	22.99	-17.01	40	42.76	11.69	1.02	32.49	-	-	P	V
			479.9	24.67	-21.33	46	30.77	23.45	2.77	32.37	-	-	P	V
			633.2	27.6	-18.4	46	30.73	26.08	3.15	32.46	-	-	P	V
			955.2	33.56	-12.44	46	29.77	30.87	3.9	31.15	-	-	P	V
														V
														V
													V	
													V	
													V	
Remark	1. No other spurious found. 2. All results are PASS against limit line.													



Note symbol

*	Fundamental Frequency which can be ignored. However, the level of any unwanted emissions shall not exceed the level of the fundamental frequency.
!	Test result is over limit line.
P/A	Peak or Average
H/V	Horizontal or Vertical



A calculation example for radiated spurious emission is shown as below:

WIFI	Note	Frequency	Level	Over	Limit	Read	Antenna	Cable	Preamp	Ant	Table	Peak	Pol.
Ant.				Limit	Line	Level	Factor	Loss	Factor	Pos	Pos	Avg.	
1		(MHz)	(dBμV/m)	(dB)	(dBμV/m)	(dBμV)	(dB/m)	(dB)	(dB)	(cm)	(deg)	(P/A)	(H/V)
802.11b		2390	55.45	-18.55	74	54.51	32.22	4.58	35.86	103	308	P	H
CH 01													
2412MHz		2390	43.54	-10.46	54	42.6	32.22	4.58	35.86	103	308	A	H

- Level(dBμV/m) =
Antenna Factor(dB/m) + Cable Loss(dB) + Read Level(dBμV) - Preamp Factor(dB)
- Over Limit(dB) = Level(dBμV/m) – Limit Line(dBμV/m)

For Peak Limit @ 2390MHz:

- Level(dBμV/m)
= Antenna Factor(dB/m) + Cable Loss(dB) + Read Level(dBμV) - Preamp Factor(dB)
= 32.22(dB/m) + 4.58(dB) + 54.51(dBμV) – 35.86 (dB)
= 55.45 (dBμV/m)
- Over Limit(dB)
= Level(dBμV/m) – Limit Line(dBμV/m)
= 55.45(dBμV/m) – 74(dBμV/m)
= -18.55(dB)

For Average Limit @ 2390MHz:

- Level(dBμV/m)
= Antenna Factor(dB/m) + Cable Loss(dB) + Read Level(dBμV) - Preamp Factor(dB)
= 32.22(dB/m) + 4.58(dB) + 42.6(dBμV) – 35.86 (dB)
= 43.54 (dBμV/m)
- Over Limit(dB)
= Level(dBμV/m) – Limit Line(dBμV/m)
= 43.54(dBμV/m) – 54(dBμV/m)
= -10.46(dB)

Both peak and average measured complies with the limit line, so test result is “PASS”.



Appendix C. Radiated Spurious Emission Plots

Test Engineer :	Hao Hsu, Jacky Hung, and Ken Wu	Temperature :	23~26°C
		Relative Humidity :	50~55%

Note symbol

-L	Low channel location
-R	High channel location

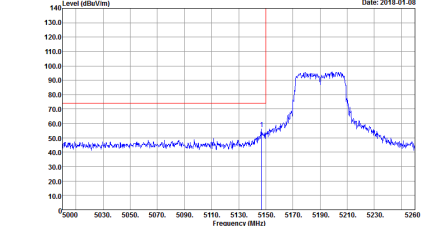
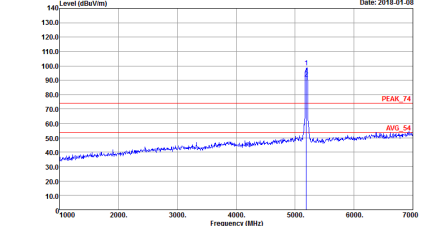
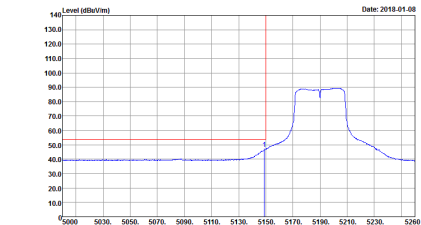

Band 1 - 5150~5250MHz
WIFI 802.11n HT40 (Band Edge @ 3m)

WIFI	Band 1 5150~5250MHz Band Edge @ 3m	
	802.11n HT40 CH38 5190MHz - L	
	Horizontal	Fundamental
Peak	 <p>Site : 03CH11-HY Condition : PEAK_BE_74 3m HORN 91200-HF HORIZONTAL Detector : Peak Project : 7D2018-02 Setting : 0/-2</p>	 <p>Site : 03CH11-HY Condition : PEAK_74 3m HORN 91200-HF HORIZONTAL Detector : Peak Project : 7D2018-02 Setting : 0/-2</p>
Avg.	 <p>Site : 03CH11-HY Condition : AVG_BE_54 3m HORN 91200-HF HORIZONTAL Detector : Peak Project : 7D2018-02 Setting : 0/-2</p>	Left blank

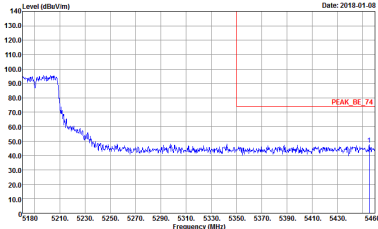
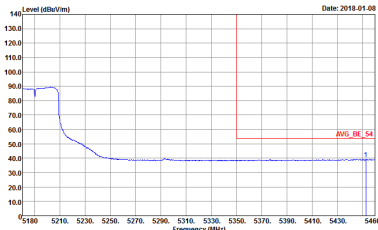

WIFI	Band 1 5150~5250MHz Band Edge @ 3m	
	802.11n HT40 CH38 5190MHz - R	
	Horizontal	Fundamental
<p>Peak</p>	 <p>Site : 03CH11-HY Condition : PEAK_BE_74 3m HORN 91200-HF HORIZONTAL RBW:1000.000KHz VBW:3000.000KHz SWF:Auto Detector : Peak Project : 7D2018-02 Setting : 0/-2</p>	<p>Left blank</p>
<p>Avg.</p>	 <p>Site : 03CH11-HY Condition : AVG_BE_54 3m HORN 91200-HF HORIZONTAL RBW:1000.000KHz VBW:1000KHz SWF:Auto Detector : Peak Project : 7D2018-02 Setting : 0/-2</p>	<p>Left blank</p>

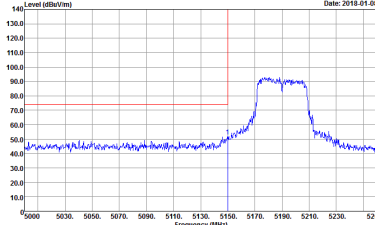
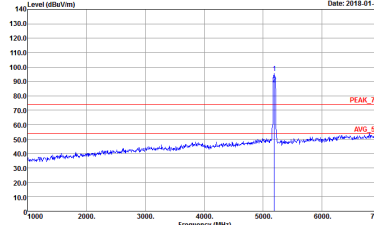
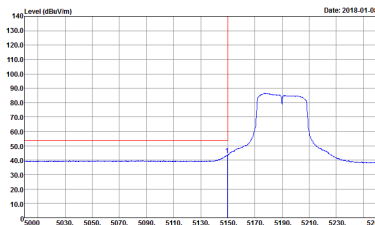

WIFI	Band 1 5150~5250MHz Band Edge @ 3m	
802.11n HT40 CH38 5190MHz - L		
Vertical		Fundamental
Peak	 <p> Site : 03CH11-HY Condition : PEAK_BE_74 3m HORN 91200-HF VERTICAL RBW:1000.000KHz VBW:3000.000KHz SWT:Auto Detector : Peak Project : 7D2018-02 Setting : 0/-2 </p>	 <p> Site : 03CH11-HY Condition : PEAK_74 3m HORN 91200-HF VERTICAL RBW:1000.000KHz VBW:3000.000KHz SWT:Auto Detector : Peak Project : 7D2018-02 Setting : 0/-2 </p>
Avg.	 <p> Site : 03CH11-HY Condition : AVG_BE_54 3m HORN 91200-HF VERTICAL RBW:1000.000KHz VBW:1000KHz SWT:Auto Detector : Peak Project : 7D2018-02 Setting : 0/-2 </p>	Left blank

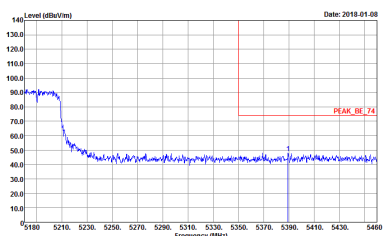
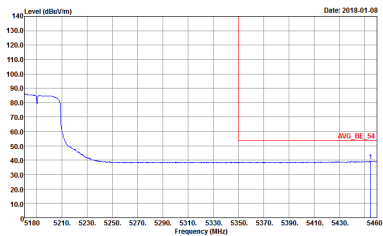

WIFI	Band 1 5150~5250MHz Band Edge @ 3m	
	802.11n HT40 CH38 5190MHz - R	
	Vertical	Fundamental
<p>Peak</p>	 <p>Site : 03CH11-HY Condition : PEAK_BE_74 3m HORN 91200-HF VERTICAL RBW:1000.000KHz VBW:3000.000KHz SWF:Auto Detector : Peak Project : 7D2018-02 Setting : 0/-2</p>	<p>Left blank</p>
<p>Avg.</p>	 <p>Site : 03CH11-HY Condition : AVG_BE_54 3m HORN 91200-HF VERTICAL RBW:1000.000KHz VBW:1000KHz SWF:Auto Detector : Peak Project : 7D2018-02 Setting : 0/-2</p>	<p>Left blank</p>



Band 1 - 5150~5250MHz
WIFI 802.11n HT40 (Harmonic @ 3m)

Table with 2 columns: Horizontal and Vertical. Each column contains a spectral plot showing Level (dBuV/m) vs Frequency (MHz) with Peak and Avg. values indicated. Includes metadata like Site, Condition, Project, and Setting.



Band 2 - 5250~5350MHz

WIFI 802.11n HT40 (Band Edge @ 3m)

WIFI	Band 2 5250~5350MHz Band Edge @ 3m	
	802.11n HT40 CH62 5310 MHz - L	
	Horizontal	Fundamental
Peak	<p>Site : 03CH11-HY Condition : PEAK_BE_74 3m HORN 91200-HF HORIZONTAL Detector : Peak Project : 7D2018-02 Setting : 0/-4</p>	<p>Site : 03CH11-HY Condition : PEAK_74 3m HORN 91200-HF HORIZONTAL Detector : Peak Project : 7D2018-02 Setting : 0/-4</p>
Avg.	<p>Site : 03CH11-HY Condition : AVG_BE_54 3m HORN 91200-HF HORIZONTAL Detector : Peak Project : 7D2018-02 Setting : 0/-4</p>	Left blank

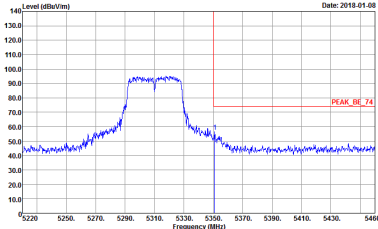
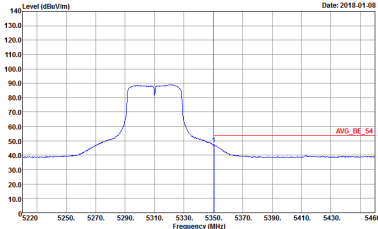

WIFI	Band 2 5250~5350MHz Band Edge @ 3m	
802.11n HT40 CH62 5310 MHz - R		
Horizontal		Fundamental
Peak	 <p> Site : 03CH11-HY Condition : PEAK_BE_74 3m HORN 91200-HF HORIZONTAL RBW:1000.000KHz VBW:3000.000KHz SWF:Auto Detector : Peak Project : 7D2018-02 Setting : 0/-4 </p>	Left blank
Avg.	 <p> Site : 03CH11-HY Condition : AVG_BE_54 3m HORN 91200-HF HORIZONTAL RBW:1000.000KHz VBW:1.000KHz SWF:Auto Detector : Peak Project : 7D2018-02 Setting : 0/-4 </p>	Left blank

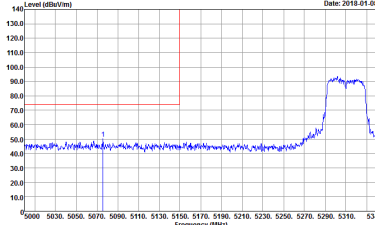
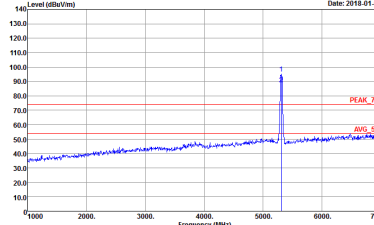
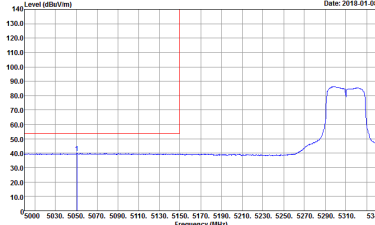

WIFI	Band 2 5250~5350MHz Band Edge @ 3m	
802.11n HT40 CH62 5310 MHz - L		
Vertical		Fundamental
Peak	 <p>Site : 03CH11-HY Condition : PEAK_BE_74 3m HORN 91200-HF VERTICAL RBW:1000.000kHz VBW:3000.000kHz SWT:Auto Detector : Peak Project : 7D2018-02 Setting : 0/-4</p>	 <p>Site : 03CH11-HY Condition : PEAK_74 3m HORN 91200-HF VERTICAL RBW:1000.000kHz VBW:3000.000kHz SWT:Auto Detector : Peak Project : 7D2018-02 Setting : 0/-4</p>
Avg.	 <p>Site : 03CH11-HY Condition : AVG_BE_54 3m HORN 91200-HF VERTICAL RBW:1000.000kHz VBW:1000kHz SWT:Auto Detector : Peak Project : 7D2018-02 Setting : 0/-4</p>	Left blank

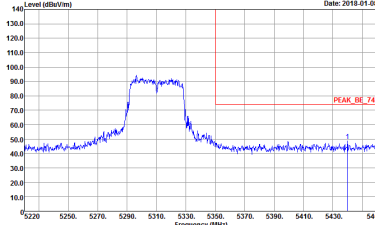
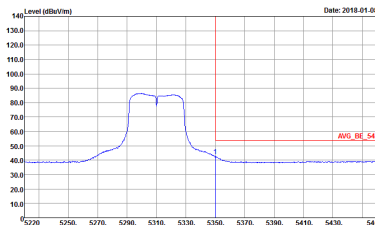

WIFI	Band 2 5250~5350MHz Band Edge @ 3m	
	802.11n HT40 CH62 5310 MHz - R	
	Vertical	Fundamental
Peak	 <p>Site : 03CH11-HY Condition : PEAK_BE_74 3m HORN 91200-HF VERTICAL RBW:1000.000kHz VBW:3000.000kHz SWF:Auto Detector : Peak Project : 7D2018-02 Setting : 0/-4</p>	Left blank
Avg.	 <p>Site : 03CH11-HY Condition : AVG_BE_54 3m HORN 91200-HF VERTICAL RBW:1000.000kHz VBW:1000kHz SWF:Auto Detector : Peak Project : 7D2018-02 Setting : 0/-4</p>	Left blank

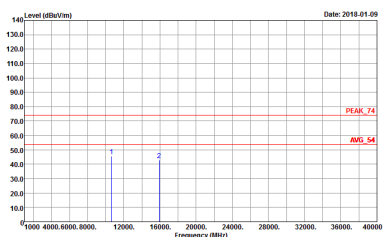
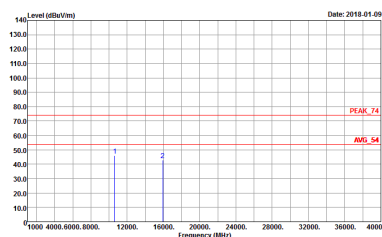

Band 2 - 5250~5350MHz
WIFI 802.11n HT40 (Harmonic @ 3m)

WIFI	Band 2 5250~5350MHz Harmonic @ 3m	
	802.11n HT40 CH62 5310 MHz	
	Horizontal	Vertical
<p>Peak</p> <p>Avg.</p>	 <p>Site : 03CH11-HY Condition : PEAK_74 3m HORN 9120D-HF HORIZONTAL Project : 7D2018-02 Setting : 0/-4</p>	 <p>Site : 03CH11-HY Condition : PEAK_74 3m HORN 9120D-HF VERTICAL Project : 7D2018-02 Setting : 0/-4</p>



Band 3 - 5470~5725MHz

WIFI 802.11n HT40 (Band Edge @ 3m)

WIFI	Band 3 5470~5725MHz Band Edge @ 3m	
	802.11n HT40 CH102 5510MHz - L	
	Horizontal	Fundamental
Peak	<p>Site : 03CH11-HY Condition : PEAK_BE_74 3m HORN 91200-HF HORIZONTAL : RBW:1000.000KHz VBW:3000.000KHz SWT:Auto Detector : Peak Project : 7D2018-02 Setting : 0/-5</p>	<p>Site : 03CH11-HY Condition : PEAK_74 3m HORN 91200-HF HORIZONTAL : RBW:1000.000KHz VBW:3000.000KHz SWT:Auto Detector : Peak Project : 7D2018-02 Setting : 0/-5</p>
Avg.	<p>Site : 03CH11-HY Condition : AVG_BE_54 3m HORN 91200-HF HORIZONTAL : RBW:1000.000KHz VBW:1000KHz SWT:Auto Detector : Peak Project : 7D2018-02 Setting : 0/-5</p>	Left blank

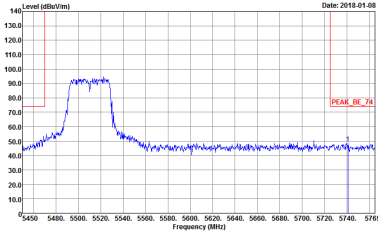
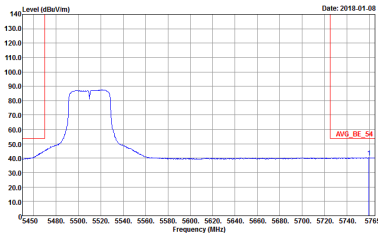

WIFI	Band 3 5470~5725MHz Band Edge @ 3m	
	802.11n HT40 CH102 5510MHz - R	
	Horizontal	Fundamental
Peak	 <p> Site : 03CH11-HY Condition : PEAK_BE_74 3m HORN 91200-HF HORIZONTAL RBW:1000.000KHz VBW:3000.000KHz SWF:Auto Detector : Peak Project : 7D2018-02 Setting : 0/-5 </p>	Left blank
Avg.	 <p> Site : 03CH11-HY Condition : AVG_BE_54 3m HORN 91200-HF HORIZONTAL RBW:1000.000KHz VBW:1.000KHz SWF:Auto Detector : Peak Project : 7D2018-02 Setting : 0/-5 </p>	Left blank

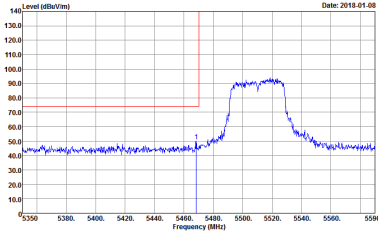
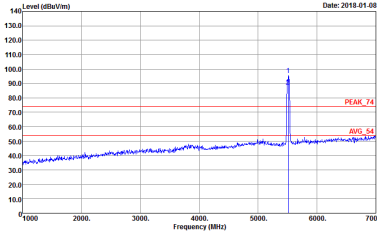
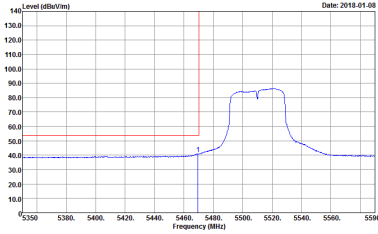

WIFI	Band 3 5470~5725MHz Band Edge @ 3m	
802.11n HT40 CH102 5510MHz - L		
Vertical		Fundamental
Peak	 <p>Date: 2018-01-08</p> <p>Site : 03CH11-HY Condition : PEAK_BE_74 3m HORN 91200-HF VERTICAL RBW:1000.000kHz VBW:3000.000kHz SWT:Auto Detector : Peak Project : 7D2018-02 Setting : 0/-5</p>	 <p>Date: 2018-01-08</p> <p>Site : 03CH11-HY Condition : PEAK_74 3m HORN 91200-HF VERTICAL RBW:1000.000kHz VBW:3000.000kHz SWT:Auto Detector : Peak Project : 7D2018-02 Setting : 0/-5</p>
Avg.	 <p>Date: 2018-01-08</p> <p>Site : 03CH11-HY Condition : AVG_BE_54 3m HORN 91200-HF VERTICAL RBW:1000.000kHz VBW:1000kHz SWT:Auto Detector : Peak Project : 7D2018-02 Setting : 0/-5</p>	Left blank

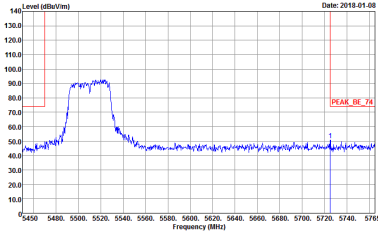
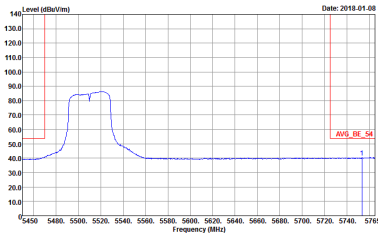

WIFI	Band 3 5470~5725MHz Band Edge @ 3m	
	802.11n HT40 CH102 5510MHz - R	
	Vertical	Fundamental
<p>Peak</p>	 <p>Site : 03CH11-HY Condition : PEAK_BE_74 3m HORN 91200-HF VERTICAL RBW:1000.000KHz VBW:3000.000KHz SWF:Auto Detector : Peak Project : 7D2018-02 Setting : 0/-5</p>	<p>Left blank</p>
<p>Avg.</p>	 <p>Site : 03CH11-HY Condition : AVG_BE_54 3m HORN 91200-HF VERTICAL RBW:1000.000KHz VBW:1000KHz SWF:Auto Detector : Peak Project : 7D2018-02 Setting : 0/-5</p>	<p>Left blank</p>

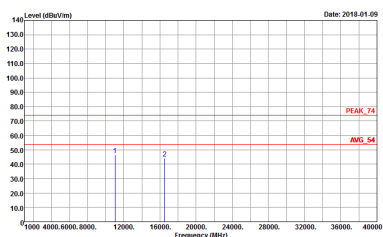
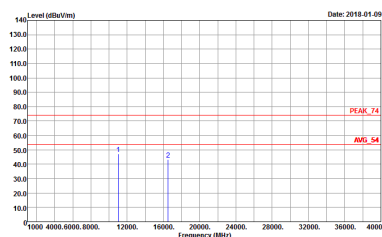

Band 3 - 5470~5725MHz
WIFI 802.11n HT40 (Harmonic @ 3m)

WIFI	Band 3 5470~5725MHz Harmonic @ 3m	
	802.11n HT40 CH102 5510MHz	
	Horizontal	Vertical
<p>Peak</p> <p>Avg.</p>	 <p>Site : 03CH11-HY Condition : PEAK_74 3m HORN 9120D-HF HORIZONTAL Project : 7D2018-02 Setting : 0/-5</p>	 <p>Site : 03CH11-HY Condition : PEAK_74 3m HORN 9120D-HF VERTICAL Project : 7D2018-02 Setting : 0/-5</p>



Emission below 1GHz
5GHz WIFI 802.11n HT40 (LF)

Table with 2 columns: Horizontal and Vertical. Each column contains a spectral plot of Level (dBuV/m) vs Frequency (MHz) from 50 to 1000 MHz. The plots show a blue signal line and a red limit line. A 'QP' peak is marked at approximately 950 MHz. Metadata includes Site: 03CH11-4#Y, Condition: QP 3m BT-LOG 6111D-LF_ETC HORIZONTAL, Detector: Peak, Project: 7D2018-02.

QP / Peak



Appendix D. Duty Cycle Plots

Band	Duty Cycle (%)	T(us)	1/T(kHz)	VBW Setting
5GHz 802.11n HT40	87.26	1780.00	0.56	1kHz

802.11n HT40

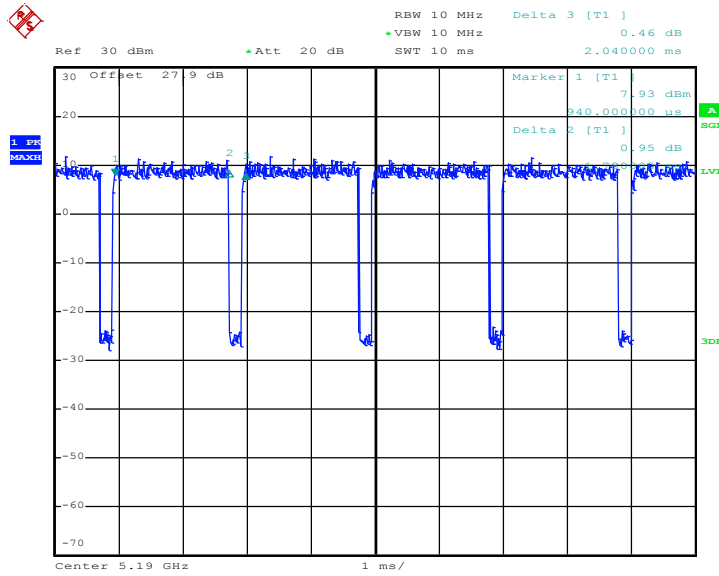

Date: 5.JAN.2018 17:06:56



Appendix E. Original Report

Please refer to Sporton report number FR7D2018D.