



FCC RF Test Report

APPLICANT : Motorola Mobility LLC
EQUIPMENT : Mobile Cellular Phone
BRAND NAME : Motorola
MODEL NAME : XT1921-6, XT1921-1
FCC ID : IHDT56XC1
STANDARD : FCC Part 15 Subpart C §15.247
CLASSIFICATION : (DTS) Digital Transmission System

The product was received on Dec. 20, 2017 and testing was completed on Jan. 23, 2018. We, SPORTON INTERNATIONAL INC., would like to declare that the tested sample has been evaluated in accordance with the test procedures and has been in compliance with the applicable technical standards.

The test results in this report apply exclusively to the tested model / sample. Without written approval of SPORTON INTERNATIONAL INC., the test report shall not be reproduced except in full.

Reviewed by: Joseph Lin / Supervisor

Approved by: Jones Tsai / Manager



SPORTON INTERNATIONAL INC.

No. 52, Hwa Ya 1st Rd., Hwa Ya Technology Park, Kwei-Shan District, Tao Yuan City, Taiwan, R.O.C.

SPORTON INTERNATIONAL INC.

TEL : 886-3-327-3456

FAX : 886-3-328-4978

FCC ID: IHDT56XC1

Page Number : 1 of 35

Report Issued Date : Feb. 13, 2018

Report Version : Rev. 01

Report Template No.: BU5-FR15CWLAC MA Version 2.0



TABLE OF CONTENTS

REVISION HISTORY..... 3

SUMMARY OF TEST RESULT 4

1 GENERAL DESCRIPTION 5

 1.1 Applicant 5

 1.2 Manufacturer 5

 1.3 Product Feature of Equipment Under Test..... 5

 1.4 Product Specification of Equipment Under Test..... 6

 1.5 Modification of EUT 6

 1.6 Testing Location 6

 1.7 Applicable Standards..... 7

2 TEST CONFIGURATION OF EQUIPMENT UNDER TEST 8

 2.1 Carrier Frequency and Channel 8

 2.2 Test Mode 9

 2.3 Connection Diagram of Test System 10

 2.4 Support Unit used in test configuration and system 11

 2.5 EUT Operation Test Setup 11

 2.6 Measurement Results Explanation Example..... 11

3 TEST RESULT 12

 3.1 6dB and 99% Bandwidth Measurement 12

 3.2 Output Power Measurement..... 14

 3.3 Power Spectral Density Measurement 15

 3.4 Conducted Band Edges and Spurious Emission Measurement 17

 3.5 Radiated Band Edges and Spurious Emission Measurement 27

 3.6 AC Conducted Emission Measurement..... 31

 3.7 Antenna Requirements 33

4 LIST OF MEASURING EQUIPMENT 34

5 UNCERTAINTY OF EVALUATION 35

APPENDIX A. CONDUCTED TEST RESULTS

APPENDIX B. AC CONDUCTED EMISSION TEST RESULT

APPENDIX C. RADIATED SPURIOUS EMISSION

APPENDIX D. RADIATED SPURIOUS EMISSION PLOTS

APPENDIX E. DUTY CYCLE PLOTS



SUMMARY OF TEST RESULT

Report Section	FCC Rule	Description	Limit	Result	Remark
3.1	15.247(a)(2)	6dB Bandwidth	$\geq 0.5\text{MHz}$	Pass	-
3.1	-	99% Bandwidth	-	Pass	-
3.2	15.247(b)	Power Output Measurement	$\leq 30\text{dBm}$	Pass	-
3.3	15.247(e)	Power Spectral Density	$\leq 8\text{dBm}/3\text{kHz}$	Pass	-
3.4	15.247(d)	Conducted Band Edges	$\leq 20\text{dBc}$	Pass	-
		Conducted Spurious Emission		Pass	-
3.5	15.247(d)	Radiated Band Edges and Radiated Spurious Emission	15.209(a) & 15.247(d)	Pass	Under limit 3.74 dB at 2483.520 MHz
3.6	15.207	AC Conducted Emission	15.207(a)	Pass	Under limit 17.80 dB at 0.150 MHz
3.7	15.203 & 15.247(b)	Antenna Requirement	N/A	Pass	-



1 General Description

1.1 Applicant

Motorola Mobility LLC
222 W. Merchandise Mart Plaza, Chicago IL 60654, USA

1.2 Manufacturer

Motorola Mobility LLC
222 W. Merchandise Mart Plaza, Chicago IL 60654, USA

1.3 Product Feature of Equipment Under Test

Product Feature	
Equipment	Mobile Cellular Phone
Brand Name	Motorola
Model Name	XT1921-6, XT1921-1
FCC ID	IHDT56XC1
IMEI Code	351838090014992 (for Radiation) 351838090015015 (for Conduction)
EUT supports Radios application	CDMA/EV-DO/GSM/EGPRS/WCDMA/HSPA/LTE/FM/GNSS WLAN 11b/g/n HT20 WLAN 11a/n HT20/HT40 Bluetooth BR/EDR/LE
HW Version	DVT1B
EUT Stage	Identical Prototype

Remark: The above EUT's information was declared by manufacturer. Please refer to the specifications or user's manual for more detailed description.

Accessory List	
AC Adapter 1	Brand Name : Motorola
	Model Name : C-P35
AC Adapter 2	Brand Name : Motorola
	Model Name : SSW-2919UMTJ C-P35 SPN5945A
AC Adapter 3	Brand Name : Motorola
	Model Name : C-P56
AC Adapter 4	Brand Name : Motorola
	Model Name : C-P56
Battery	Brand Name : Motorola
	Model Name : GK40
USB Cable	Brand Name : Saibao
	Model Name : SWT-A083A



1.4 Product Specification of Equipment Under Test

Standards-related Product Specification	
Tx/Rx Channel Frequency Range	2412 MHz ~ 2462 MHz
Maximum (Peak) Output Power to antenna	802.11b : 20.55 dBm (0.1135 W) 802.11g : 19.73 dBm (0.0940 W) 802.11n HT20 : 18.74 dBm (0.0748 W)
99% Occupied Bandwidth	802.11b : 13.75MHz 802.11g : 18.45MHz 802.11n HT20 : 19.20MHz
Antenna Type / Gain	PIFA Antenna with gain -3.2 dBi
Type of Modulation	802.11b : DSSS (DBPSK / DQPSK / CCK) 802.11g/n : OFDM (BPSK / QPSK / 16QAM / 64QAM)

1.5 Modification of EUT

No modifications are made to the EUT during all test items.

1.6 Testing Location

Sporton Lab is accredited to ISO 17025 by Taiwan Accreditation Foundation (TAF code : 1190) and the FCC designation No. TW1190 and TW0007 under the FCC 2.948(e) by Mutual Recognition Agreement (MRA) in FCC Test.

Test Site	SPORTON INTERNATIONAL INC.	
Test Site Location	No. 52, Hwa Ya 1 st Rd., Hwa Ya Technology Park, Kwei-Shan District, Tao Yuan City, Taiwan, R.O.C. TEL: +886-3-327-3456 FAX: +886-3-328-4978	
Test Site No.	Sporton Site No.	
	TH05-HY	CO05-HY

Note: The test site complies with ANSI C63.4 2014 requirement.

Test Site	SPORTON INTERNATIONAL INC.	
Test Site Location	No.58, Aly. 75, Ln. 564, Wenhua 3rd Rd. Guishan Dist, Taoyuan City, Taiwan (R.O.C.) TEL: +886-3-327-0868 FAX: +886-3-327-0855	
Test Site No.	Sporton Site No.	
	03CH13-HY	

Note: The test site complies with ANSI C63.4 2014 requirement.



1.7 Applicable Standards

According to the specifications of the manufacturer, the EUT must comply with the requirements of the following standards:

- ♦ FCC Part 15 Subpart C §15.247
- ♦ FCC KDB Publication No. 558074 D01 DTS Meas. Guidance v04
- ♦ ANSI C63.10-2013

Remark:

1. All test items were verified and recorded according to the standards and without any deviation during the test.
2. This EUT has also been tested and complied with the requirements of FCC Part 15, Subpart B, recorded in a separate test report.



2 Test Configuration of Equipment Under Test

- a. The EUT has been associated with peripherals and configuration operated in a manner tended to maximize its emission characteristics in a typical application. Frequency range investigated: conduction emission (150 kHz to 30 MHz), radiation emission (9 kHz to the 10th harmonic of the highest fundamental frequency or to 40 GHz, whichever is lower). For radiated measurement, pre-scanned in three orthogonal panels, X, Y, Z. The worst cases (X plane) were recorded in this report.

- b. AC power line Conducted Emission was tested under maximum output power.

2.1 Carrier Frequency and Channel

Frequency Band	Channel	Freq. (MHz)	Channel	Freq. (MHz)
2400-2483.5 MHz	1	2412	7	2442
	2	2417	8	2447
	3	2422	9	2452
	4	2427	10	2457
	5	2432	11	2462
	6	2437		



2.2 Test Mode

Final test modes are considering the modulation and worse data rates as below table.

Modulation	Data Rate
802.11b	1 Mbps
802.11g	6 Mbps
802.11n HT20	MCS0

Test Cases	
AC Conducted Emission	Mode 1 :GSM850 Idle + Bluetooth Link + WLAN (2.4GHz) Link + SD Card + MP3 + Earphone + USB Cable (Charging from Adapter 1)
Remark: For Radiated Test Cases, The tests were performance with Adapter 1.	

2.3 Connection Diagram of Test System

<WLAN Tx Mode>

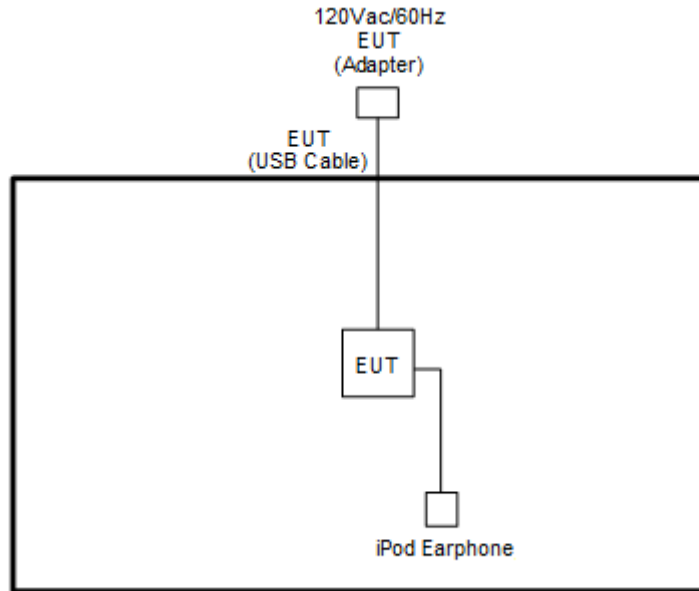

<AC Conducted Emission Mode>

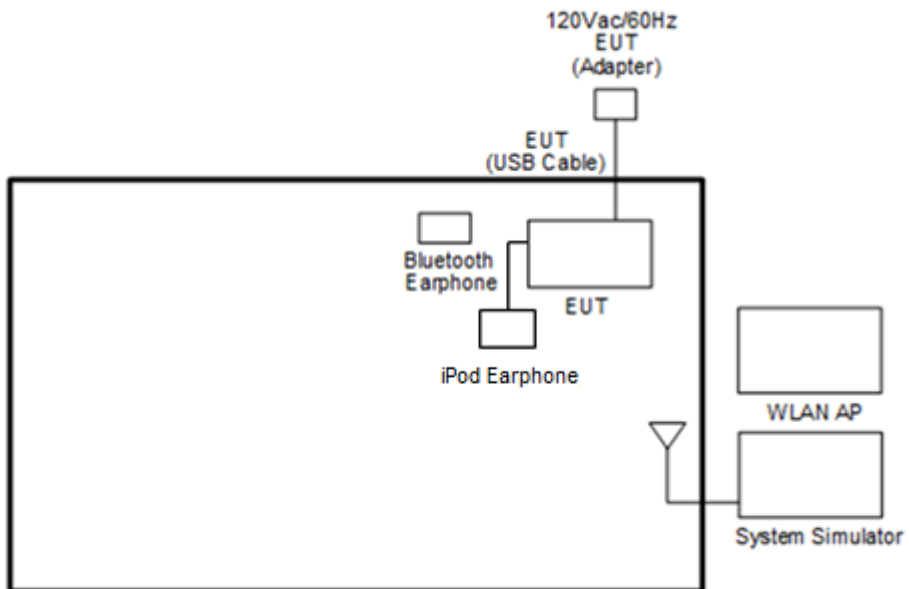



2.4 Support Unit used in test configuration and system

Item	Equipment	Trade Name	Model Name	FCC ID	Data Cable	Power Cord
1.	System Simulator	Anritsu	MT8820C	N/A	N/A	Unshielded, 1.8 m
2.	WLAN AP	ASUS	RT-AC66U	MSQ-RTAC66U	N/A	Unshielded, 1.8 m
3.	iPod Earphone	Apple	N/A	Verification	Unshielded, 1.0 m	N/A
4.	Bluetooth Earphone	lenovo	LBH 301	FCC DoC	N/A	N/A
5.	SD Card	SanDisk	MicroSD HC	FCC DoC	N/A	N/A

2.5 EUT Operation Test Setup

The RF test items, utility “QRCT” was installed in Notebook which was programmed in order to make the EUT get into the engineering modes to provide channel selection, power level, data rate and the application type and for continuous transmitting signals.

2.6 Measurement Results Explanation Example

For all conducted test items:

The offset level is set in the spectrum analyzer to compensate the RF cable loss and attenuator factor between EUT conducted output port and spectrum analyzer. With the offset compensation, the spectrum analyzer reading level is exactly the EUT RF output level.

Example:

The spectrum analyzer offset is derived from RF cable loss and attenuator factor.

Offset = RF cable loss + attenuator factor.

Following shows an offset computation example with cable loss 4.2 dB and 10dB attenuator.

$$\begin{aligned} \text{Offset(dB)} &= \text{RF cable loss(dB)} + \text{attenuator factor(dB)}. \\ &= 4.2 + 10 = 14.2 \text{ (dB)} \end{aligned}$$

3 Test Result

3.1 6dB and 99% Bandwidth Measurement

3.1.1 Limit of 6dB and 99% Bandwidth

The minimum 6 dB bandwidth shall be at least 500 kHz.

3.1.2 Measuring Instruments

The measuring equipment is listed in the section 4 of this test report.

3.1.3 Test Procedures

1. The testing follows FCC KDB Publication No. 558074 DTS D01 Meas. Guidance v04.
2. The RF output of EUT was connected to the spectrum analyzer by RF cable and attenuator. The path loss was compensated to the results for each measurement.
3. Set to the maximum power setting and enable the EUT transmit continuously.
4. Make the measurement with the spectrum analyzer's resolution bandwidth (RBW) = 100 kHz. Set the Video bandwidth (VBW) = 300 kHz. In order to make an accurate measurement. The 6 dB bandwidth must be greater than 500 kHz.
5. For 99% Bandwidth Measurement, the spectrum analyzer's resolution bandwidth (RBW) = 1MHz and set the Video bandwidth (VBW) = 3MHz.
6. Measure and record the results in the test report.

3.1.4 Test Setup

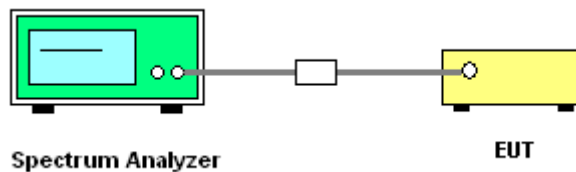



3.1.5 Test Result of 6dB and 99% Occupied Bandwidth

Please refer to Appendix A.

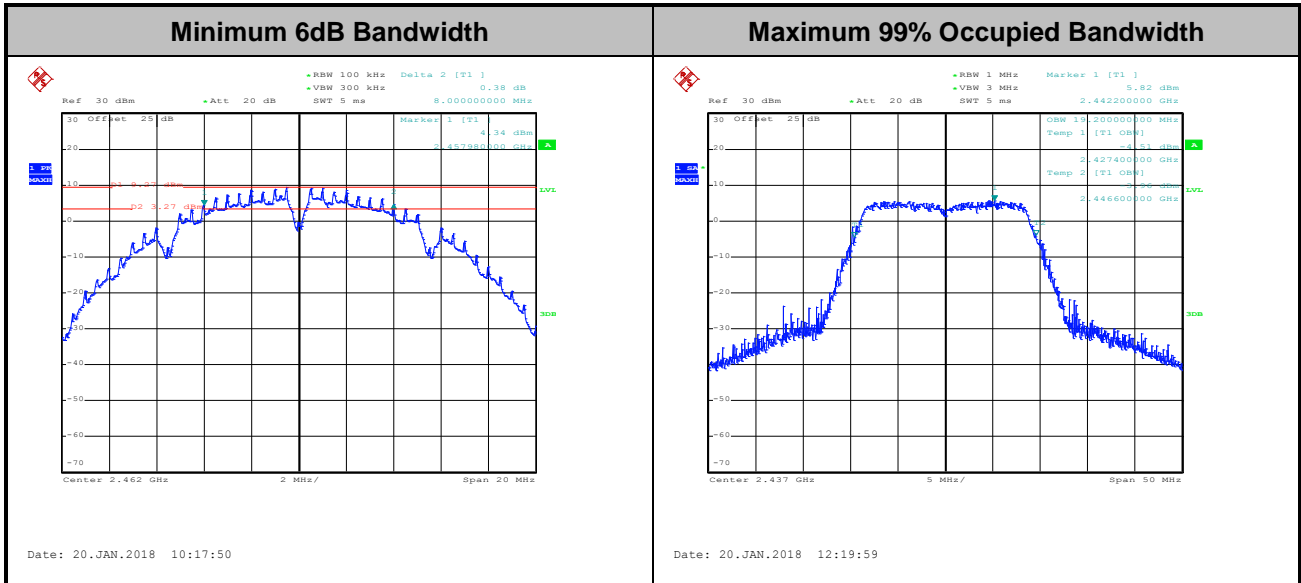

Note : The occupied channel bandwidth is maintained within the band of operation for all of the modulations.

3.2 Output Power Measurement

3.2.1 Limit of Output Power

For systems using digital modulation in the 2400-2483.5MHz, the limit for peak output power is 30dBm. If transmitting antenna with directional gain greater than 6dBi is used, the peak output power from the intentional radiator shall be reduced below the above stated value by the amount in dB that the directional gain of the antenna exceeds 6 dBi. In case of point-to-point operation, the limit has to be reduced by 1dB for every 3dB that the directional gain of the antenna exceeds 6dBi.

3.2.2 Measuring Instruments

The measuring equipment is listed in the section 4 of this test report.

3.2.3 Test Procedures

1. The testing follows the Measurement Procedure of FCC KDB No. 558074 DTS D01 Meas. Guidance v04 section 9.1.3 PKPM1 Peak power meter method.
2. The RF output of EUT was connected to the power meter by RF cable and attenuator. The path loss was compensated to the results for each measurement.
3. Set to the maximum power setting and enable the EUT transmit continuously.
4. Measure the conducted output power and record the results in the test report.

3.2.4 Test Setup

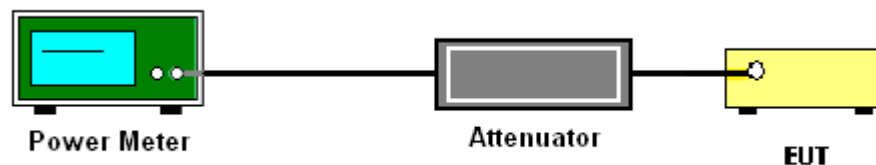

3.2.5 Test Result of Peak Output Power

Please refer to Appendix A.

3.2.6 Test Result of Average output Power (Reporting Only)

Please refer to Appendix A.

3.3 Power Spectral Density Measurement

3.3.1 Limit of Power Spectral Density

The peak power spectral density shall not be greater than 8dBm in any 3kHz band at any time interval of continuous transmission.

3.3.2 Measuring Instruments

The measuring equipment is listed in the section 4 of this test report.

3.3.3 Test Procedures

1. The testing follows Measurement Procedure 10.2 Method PKPSD of FCC KDB Publication No. 558074 D01 DTS Meas. Guidance v04
2. The RF output of EUT was connected to the spectrum analyzer by RF cable and attenuator. The path loss was compensated to the results for each measurement.
3. Set to the maximum power setting and enable the EUT transmit continuously.
4. Make the measurement with the spectrum analyzer's resolution bandwidth (RBW) = 3 kHz. Video bandwidth VBW = 10 kHz In order to make an accurate measurement, set the span to 1.5 times DTS Channel Bandwidth. (6dB BW)
5. Detector = peak, Sweep time = auto couple, Trace mode = max hold, Allow trace to fully stabilize. Use the peak marker function to determine the maximum power level.
6. Measure and record the results in the test report.

3.3.4 Test Setup

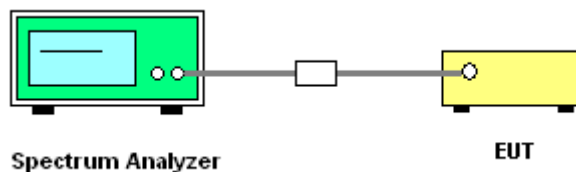

3.3.5 Test Result of Power Spectral Density

Please refer to Appendix A.

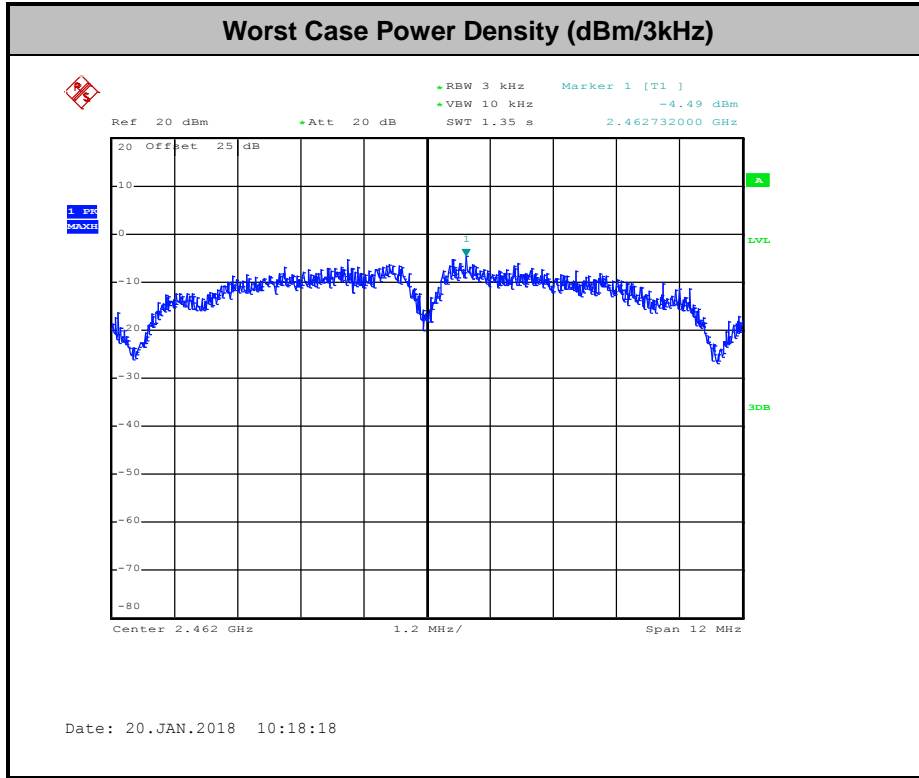

3.4 Conducted Band Edges and Spurious Emission Measurement

3.4.1 Limit of Conducted Band Edges and Spurious Emission Measurement

In any 100 kHz bandwidth outside of the authorized frequency band, the emissions which fall in the non-restricted bands shall be attenuated at least 20 dB / 30dB relative to the maximum PSD level in 100 kHz by RF conducted measurement.

3.4.2 Measuring Instruments

The measuring equipment is listed in the section 4 of this test report.

3.4.3 Test Procedures

1. The testing follows FCC KDB Publication No. 558074 D01 DTS Meas. Guidance v04.
2. The RF output of EUT was connected to the spectrum analyzer by RF cable and attenuator. The path loss was compensated to the results for each measurement.
3. Set to the maximum power setting and enable the EUT transmit continuously.
4. Set RBW = 100 kHz, VBW=300 kHz, Peak Detector. Unwanted Emissions measured in any 100 kHz bandwidth outside of the authorized frequency band shall be attenuated by at least 20 dB relative to the maximum in-band peak PSD level in 100 kHz when maximum peak conducted output power procedure is used. If the transmitter complies with the conducted power limits based on the use of RMS averaging over a time interval, the attenuation required under this paragraph shall be 30 dB instead of 20 dB per 15.247(d).
5. Measure and record the results in the test report.
6. The RF fundamental frequency should be excluded against the limit line in the operating frequency band.

3.4.4 Test Setup

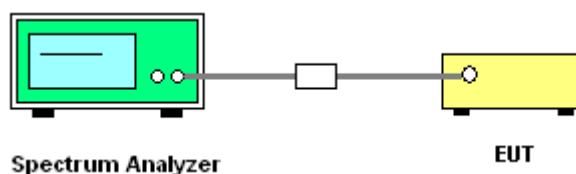



3.4.5 Test Result of Conducted Band Edges and Spurious Emission

Test Engineer : Reece Lin and Kai Liao	Temperature : 21~25°C
	Relative Humidity : 51~54%

Test Mode : 802.11b	Test Channel : 01
---------------------	-------------------

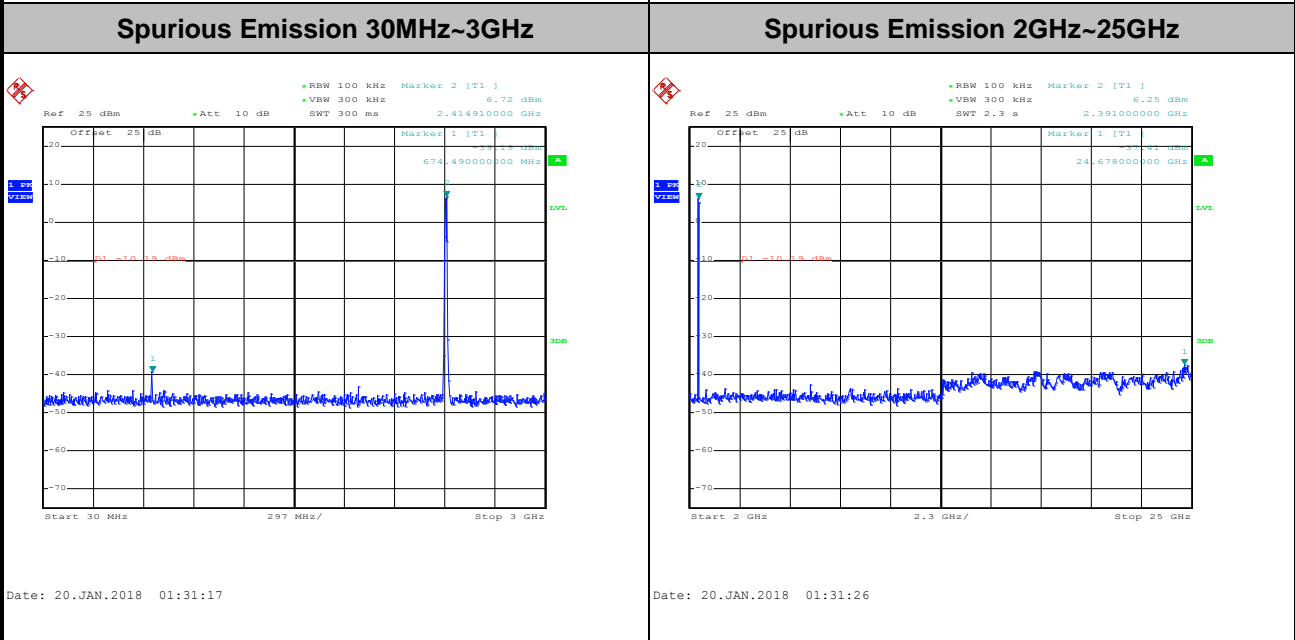
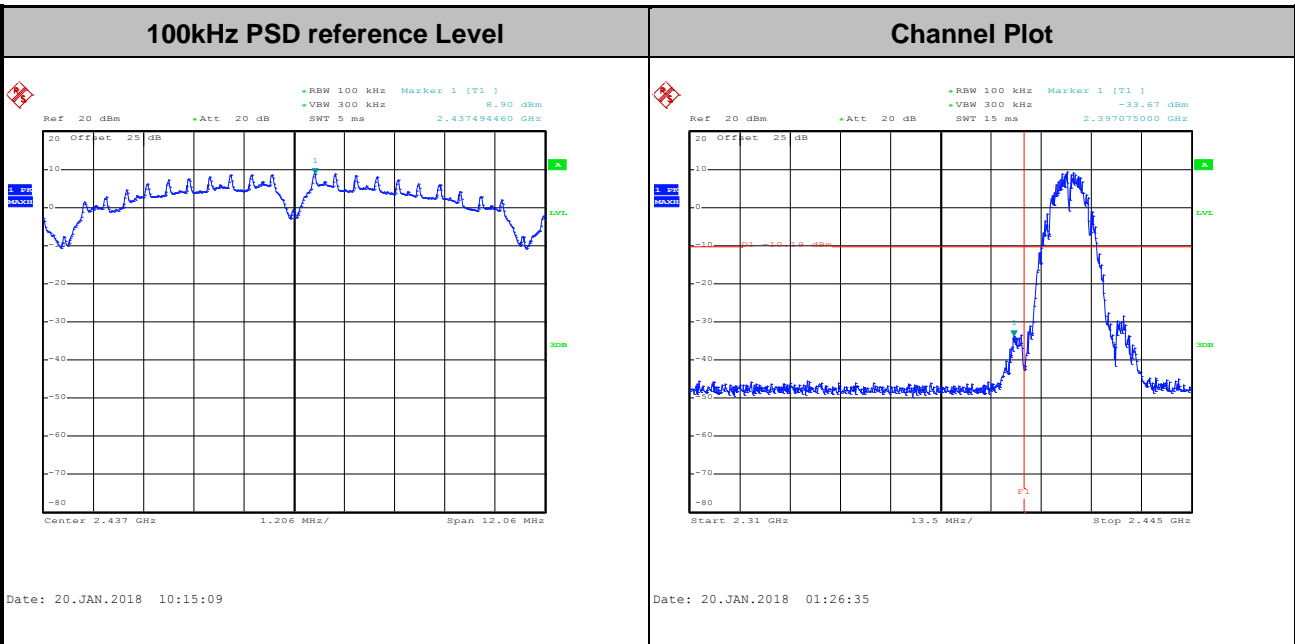



Test Mode :	802.11b	Test Channel :	06
-------------	---------	----------------	----

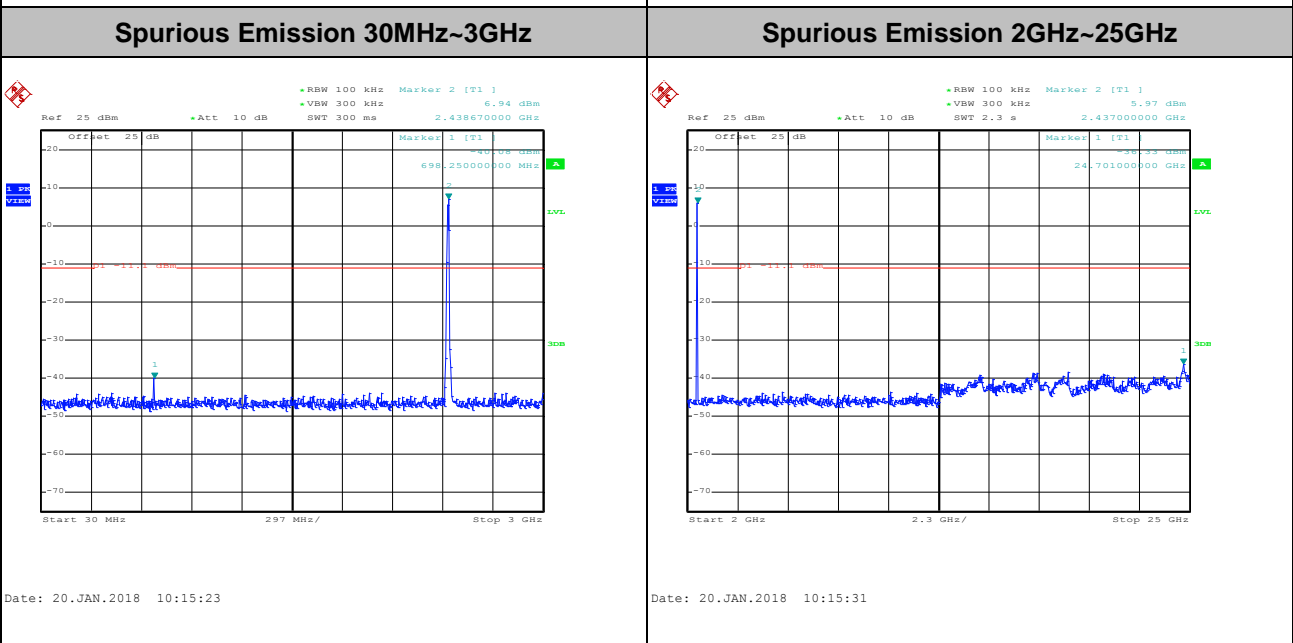
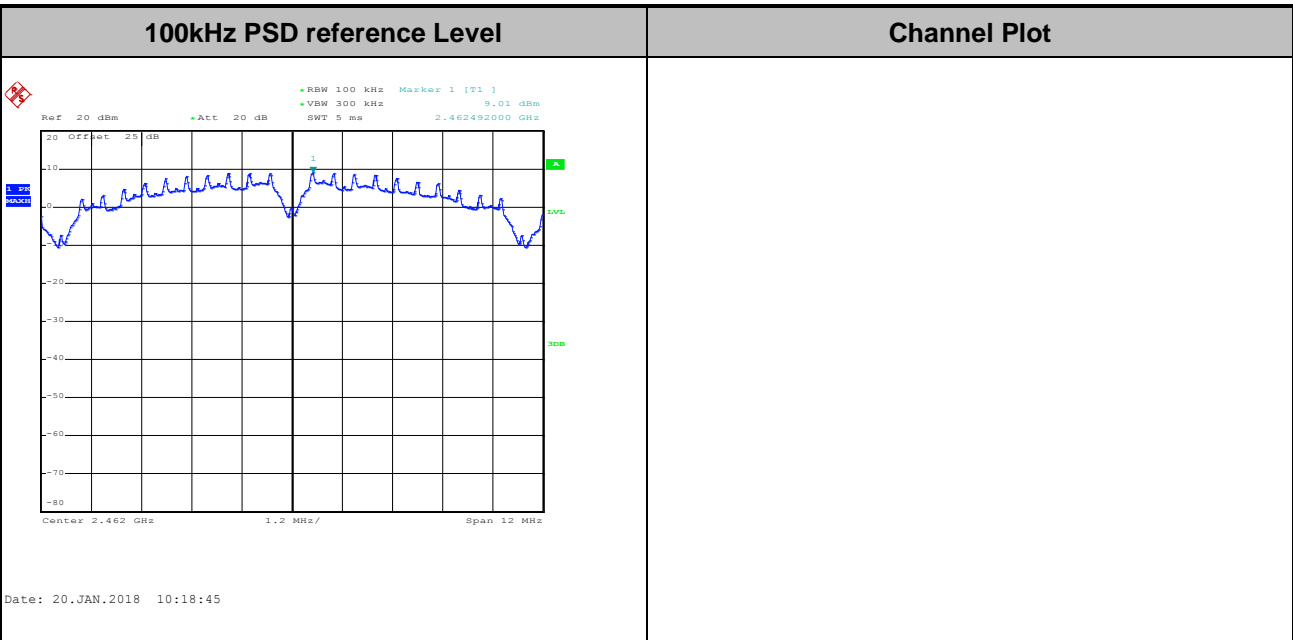



Test Mode :	802.11b	Test Channel :	11
-------------	---------	----------------	----

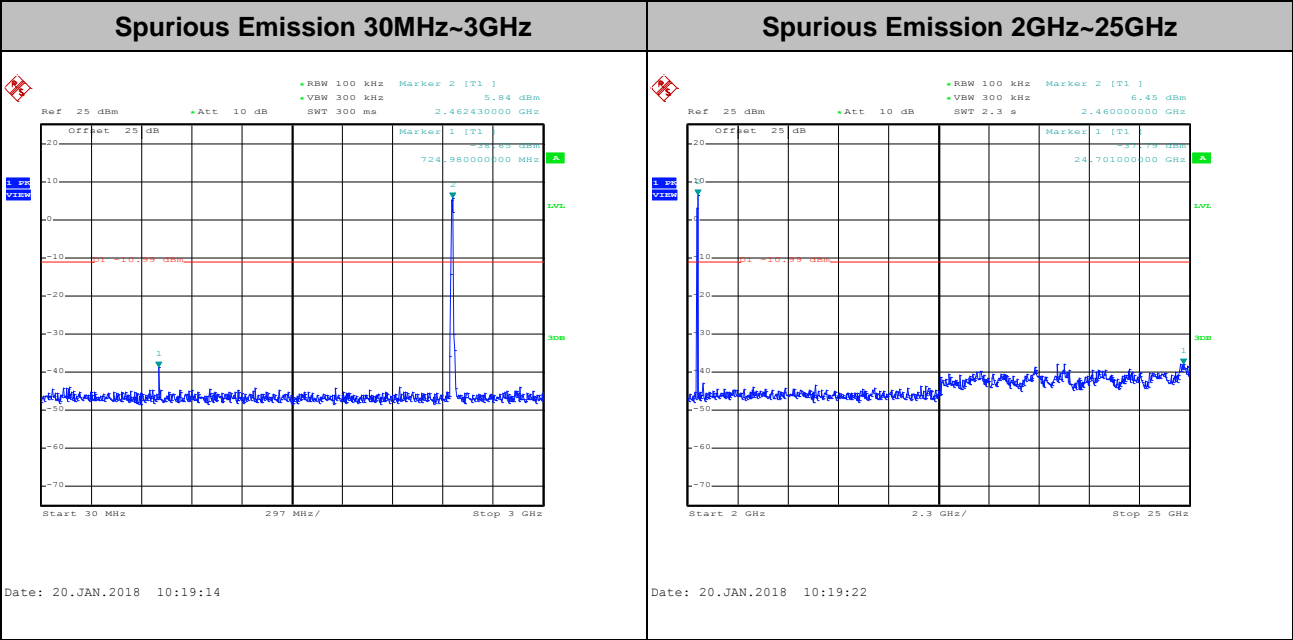
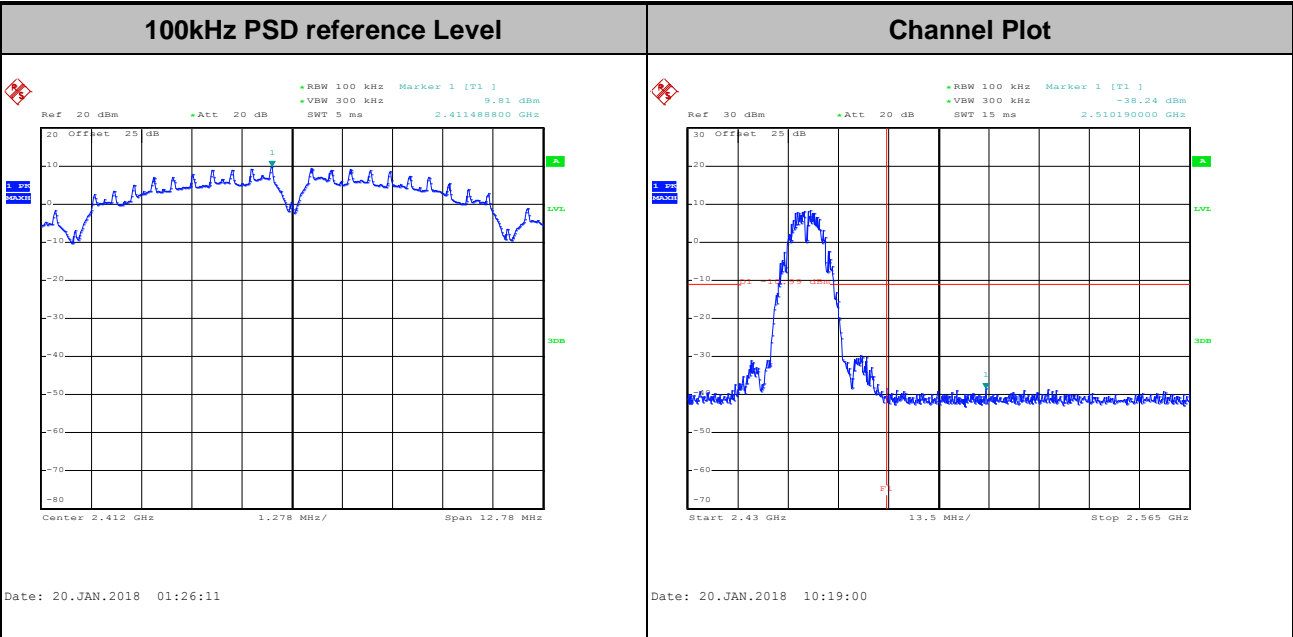



Test Mode :	802.11g	Test Channel :	01
-------------	---------	----------------	----

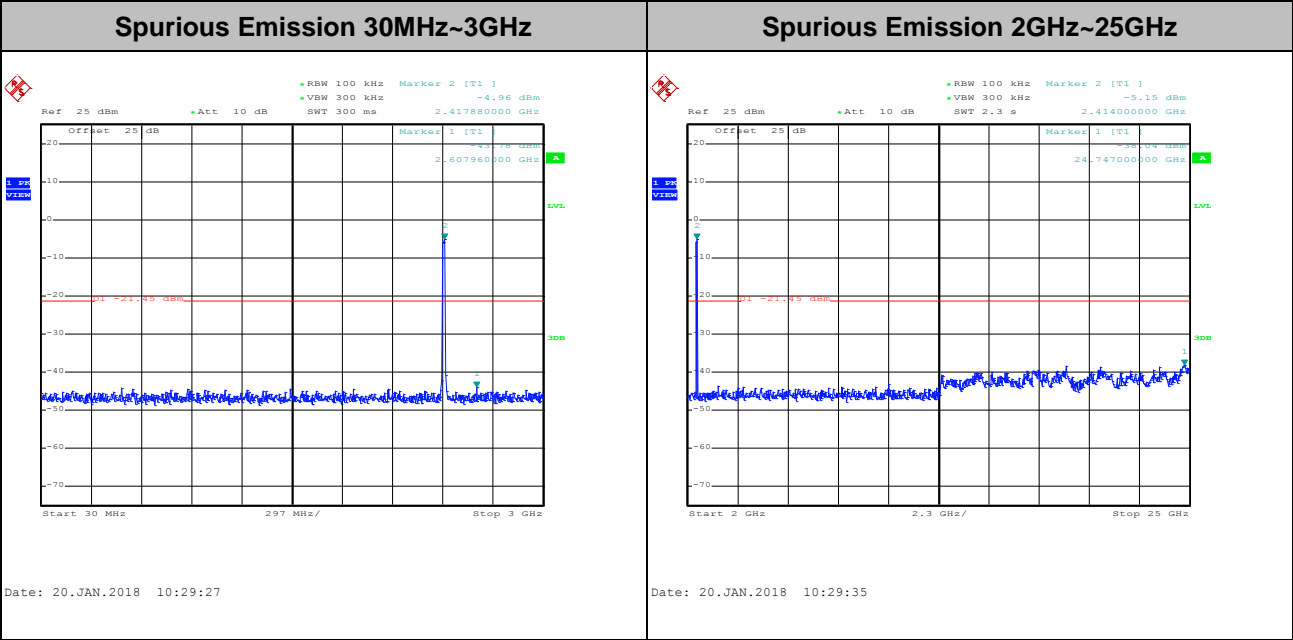
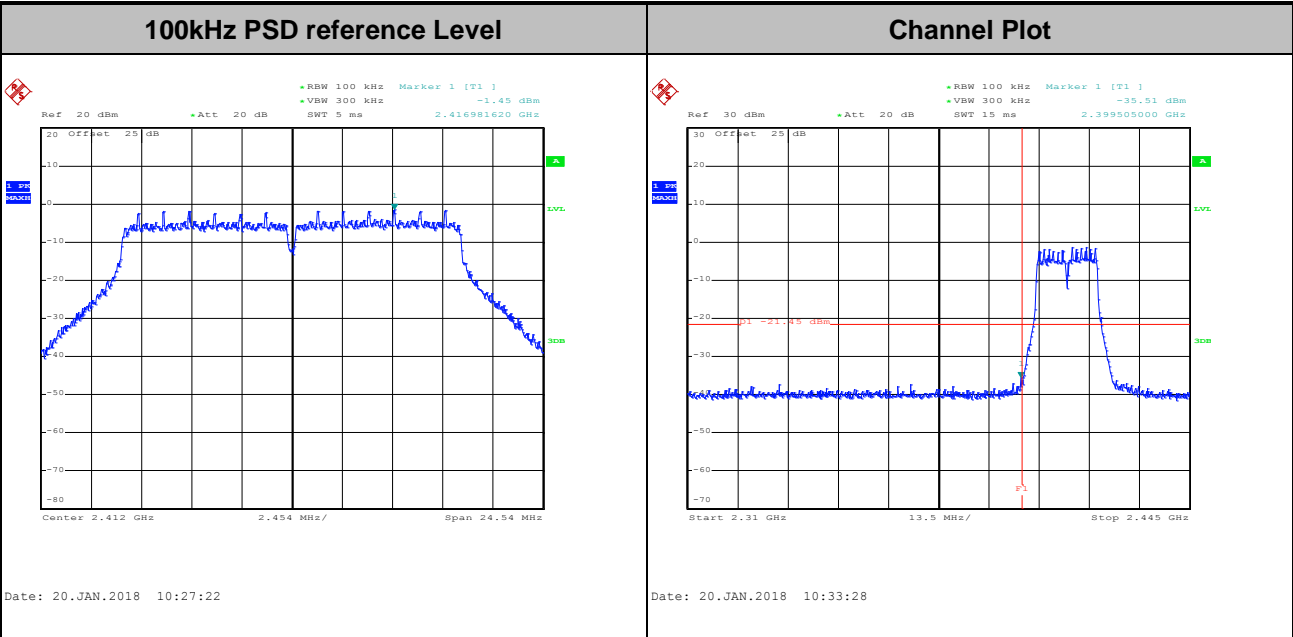



Test Mode :	802.11g	Test Channel :	06
-------------	---------	----------------	----

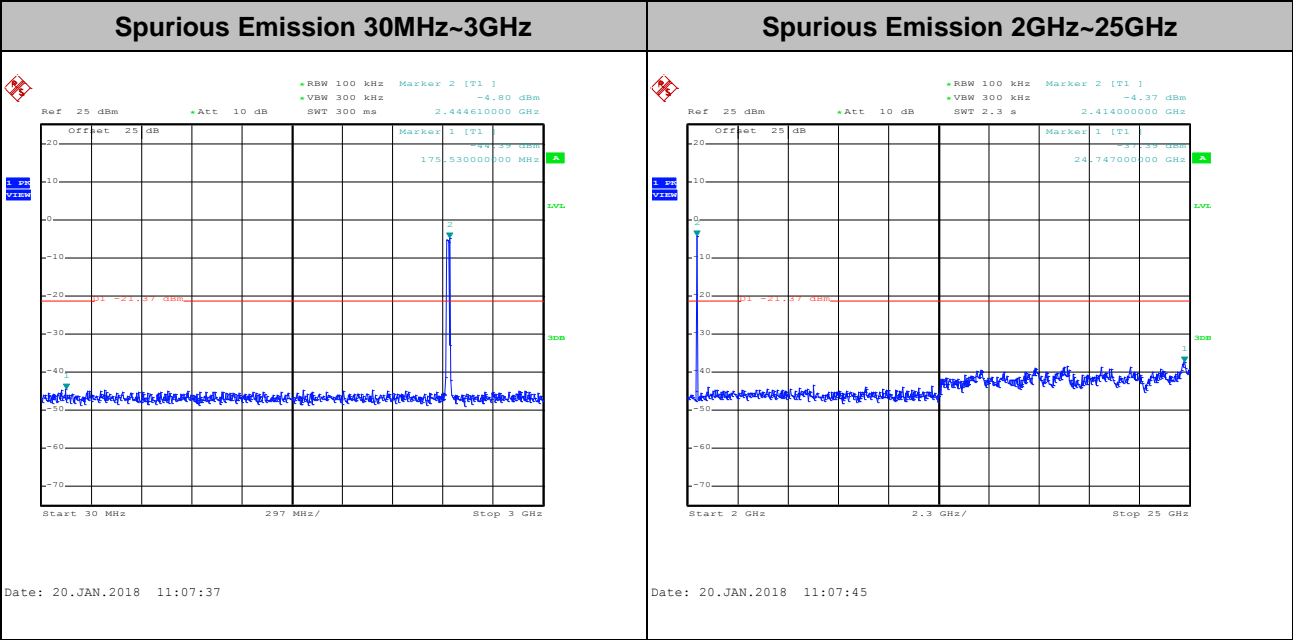
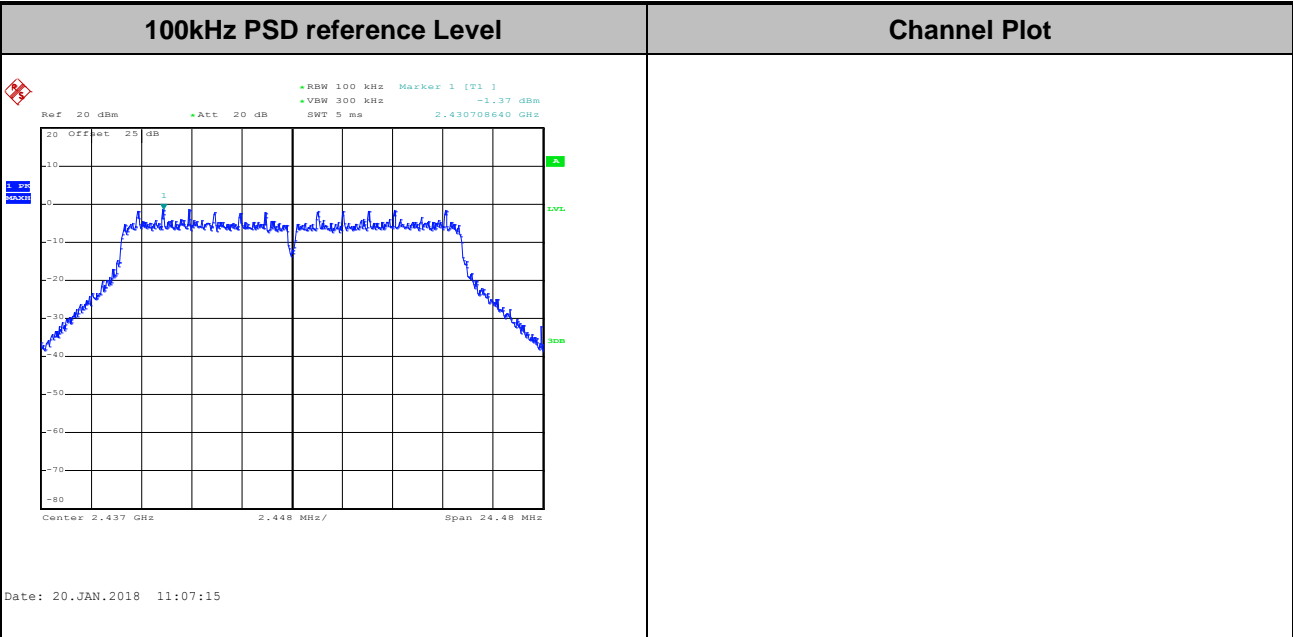



Test Mode :	802.11g	Test Channel :	11
-------------	---------	----------------	----

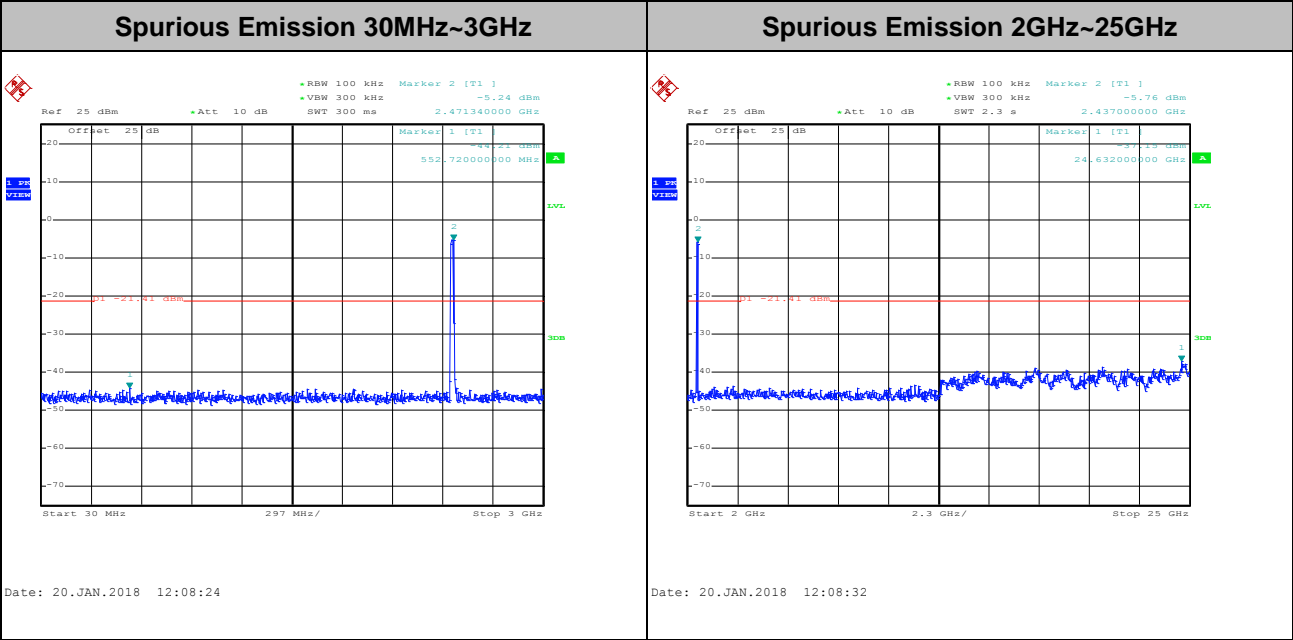
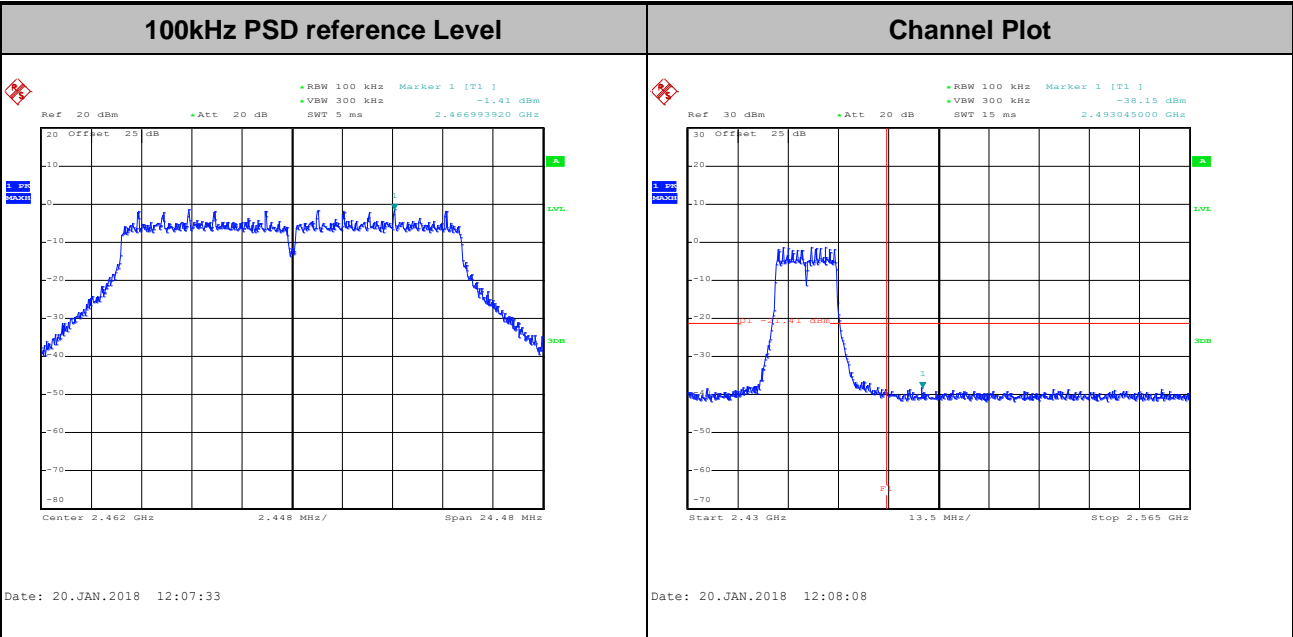



Test Mode :	802.11n HT20	Test Channel :	01
-------------	--------------	----------------	----

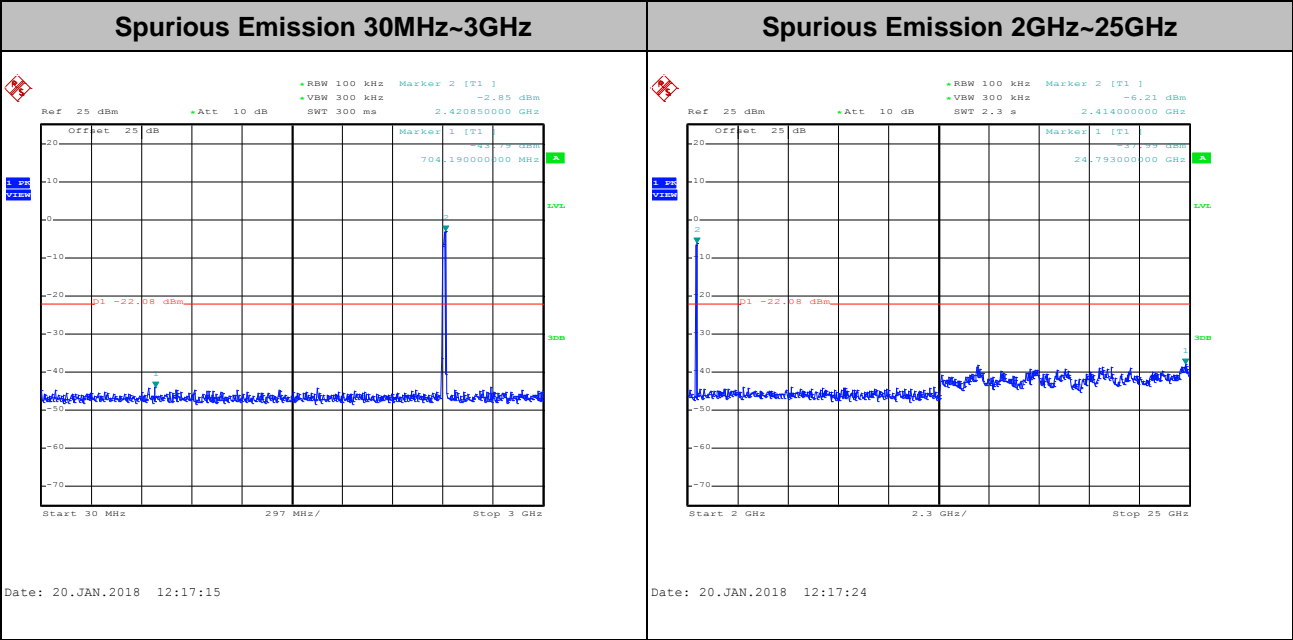
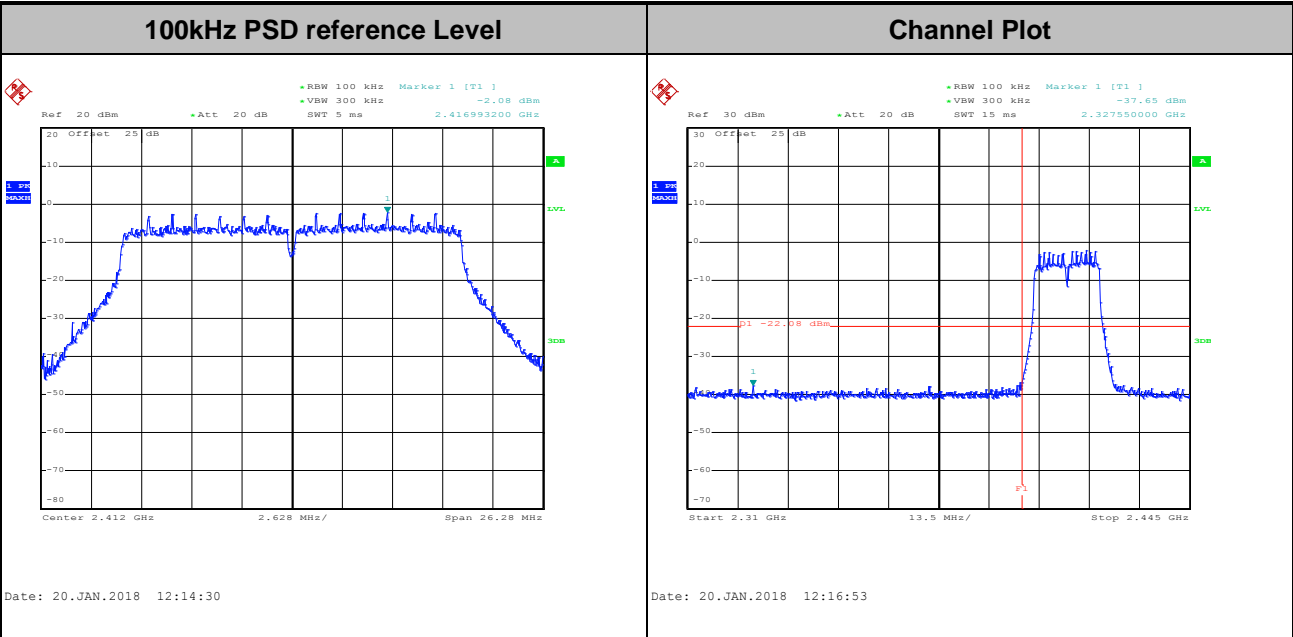



Test Mode :	802.11n HT20	Test Channel :	06
-------------	--------------	----------------	----

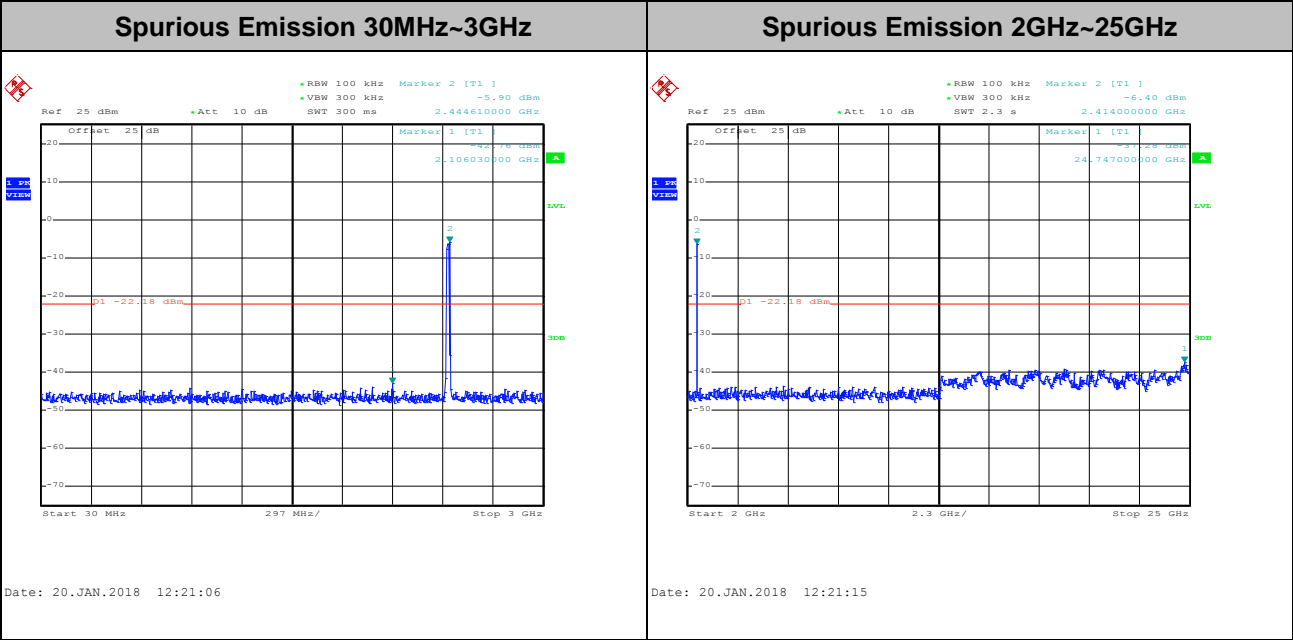
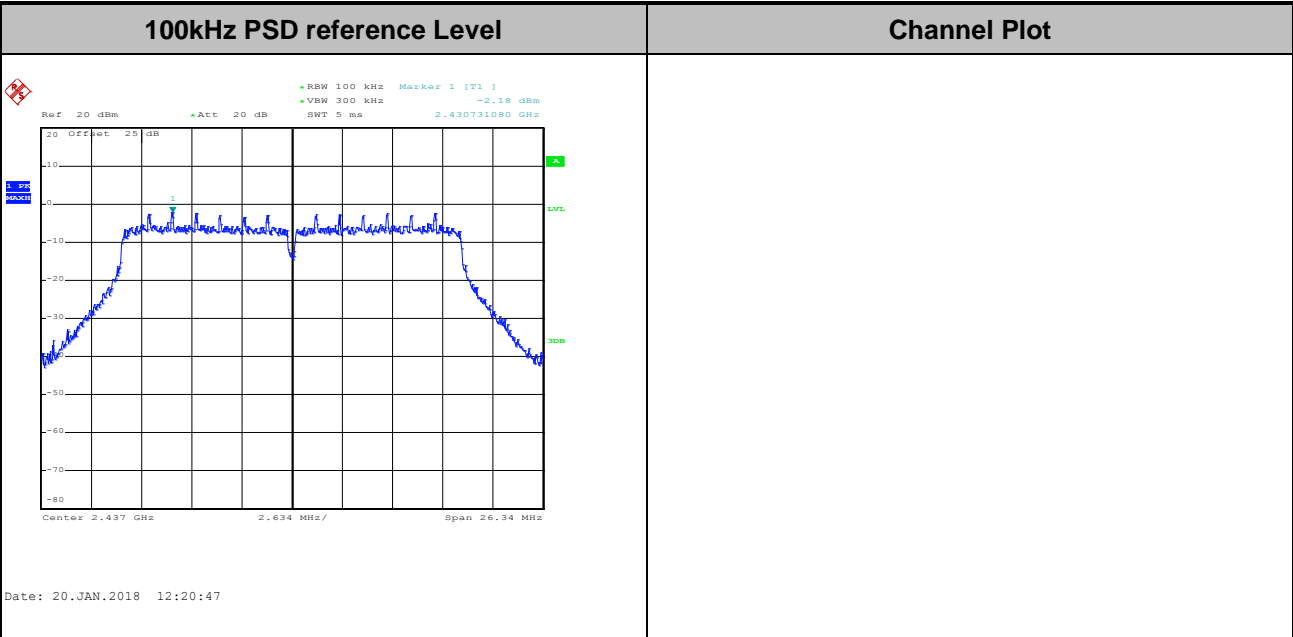



Test Mode :	802.11n HT20	Test Channel :	11
-------------	--------------	----------------	----

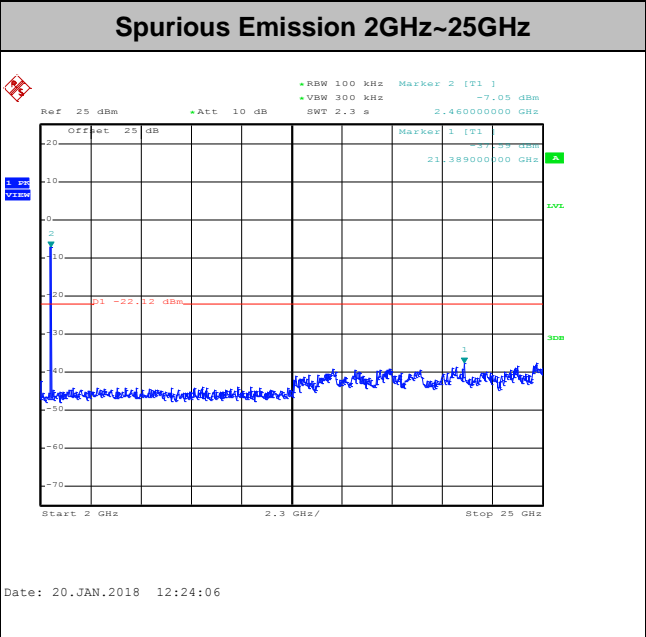
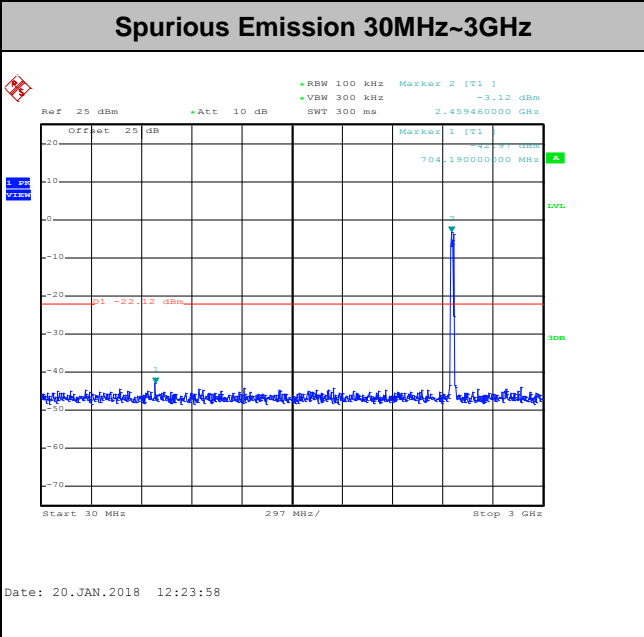
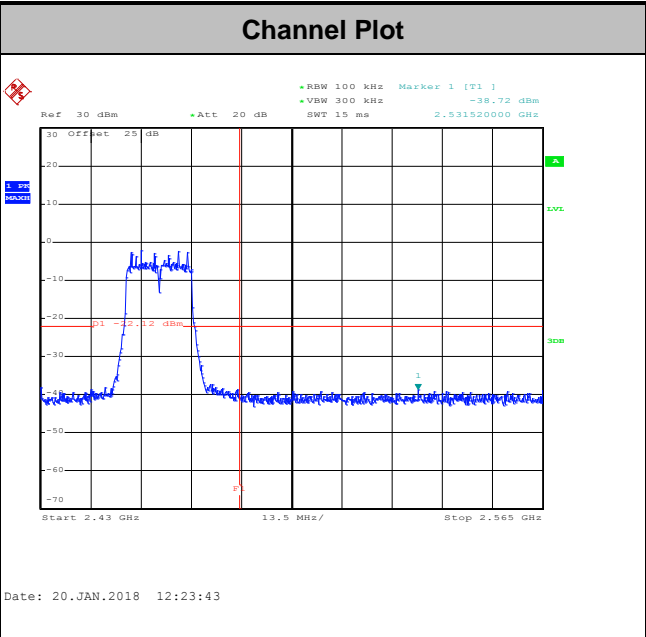
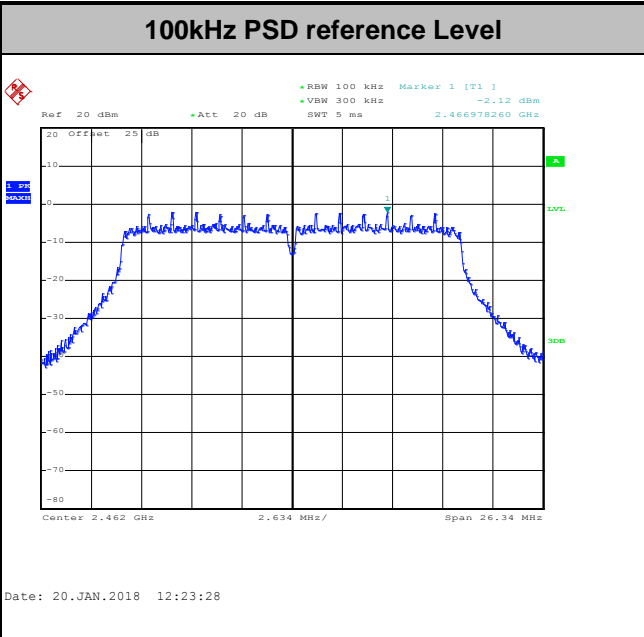



3.5 Radiated Band Edges and Spurious Emission Measurement

3.5.1 Limit of Radiated band edge and Spurious Emission Measurement

In any 100 kHz bandwidth outside the intentional radiator frequency band, all harmonics/spurious must be at least 20 dB below the highest emission level within the authorized band. If the output power of this device was measured by spectrum analyzer, the attenuation under this paragraph shall be 30 dB instead of 20 dB. In addition, radiated emissions which fall in the restricted bands must also comply with the limits as below.

Frequency (MHz)	Field Strength (microvolts/meter)	Measurement Distance (meters)
0.009 – 0.490	2400/F(kHz)	300
0.490 – 1.705	24000/F(kHz)	30
1.705 – 30.0	30	30
30 – 88	100	3
88 – 216	150	3
216 - 960	200	3
Above 960	500	3

3.5.2 Measuring Instruments

The measuring equipment is listed in the section 4 of this test report.



3.5.3 Test Procedures

1. The testing follows FCC KDB Publication No. 558074 D01 DTS Meas. Guidance v04.
2. The EUT was arranged to its worst case and then tune the antenna tower (from 1 m to 4 m) and turntable (from 0 degree to 360 degrees) to find the maximum reading. A pre-amp and a high pass filter are used for the test in order to get better signal level.
3. The EUT was placed on a turntable with 0.8 meter for frequency below 1GHz and 1.5 meter for frequency above 1GHz respectively above ground.
4. The EUT was set 3 meters from the interference receiving antenna, which was mounted on the top of a variable height antenna tower.
5. Corrected Reading: Antenna Factor + Cable Loss + Read Level - Preamp Factor = Level
6. For testing below 1GHz, if the emission level of the EUT in peak mode was 3 dB lower than the limit specified, then peak values of EUT will be reported, otherwise, the emissions will be repeated one by one using the CISPR quasi-peak method and reported.
7. For testing above 1GHz, the emission level of the EUT in peak mode was 20dB lower than average limit (that means the emission level in average mode also complies with the limit in average mode), then peak values of EUT will be reported, otherwise, the emissions will be measured in average mode again and reported.
8. Use the following spectrum analyzer settings:
 - (1) Span shall wide enough to fully capture the emission being measured;
 - (2) Set RBW=100 kHz for $f < 1$ GHz; VBW \geq RBW; Sweep = auto; Detector function = peak; Trace = max hold;
 - (3) Set RBW = 1 MHz, VBW= 3MHz for $f \geq 1$ GHz for peak measurement.
For average measurement:
 - VBW = 10 Hz, when duty cycle is no less than 98 percent.
 - VBW $\geq 1/T$, when duty cycle is less than 98 percent where T is the minimum transmission duration over which the transmitter is on and is transmitting at its maximum power control level for the tested mode of operation.

3.5.4 Test Setup

For radiated emissions below 30MHz

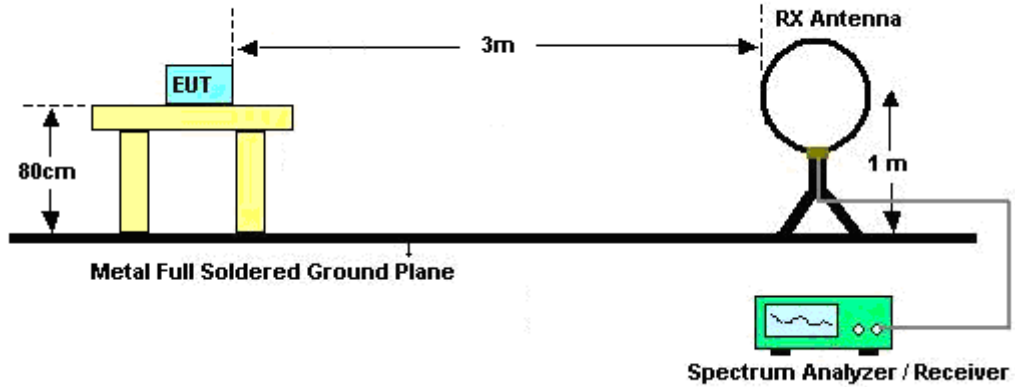

For radiated emissions from 30MHz to 1GHz

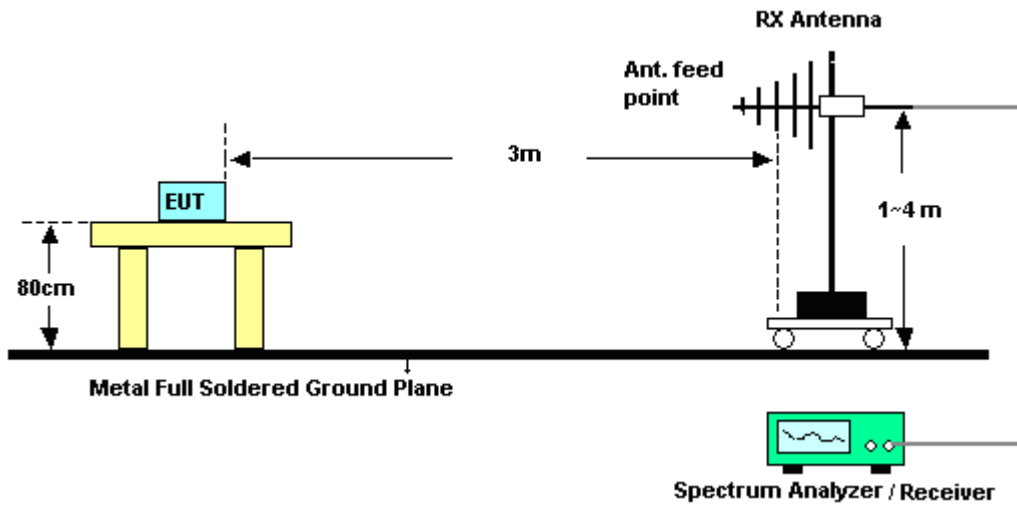

For radiated emissions above 1GHz

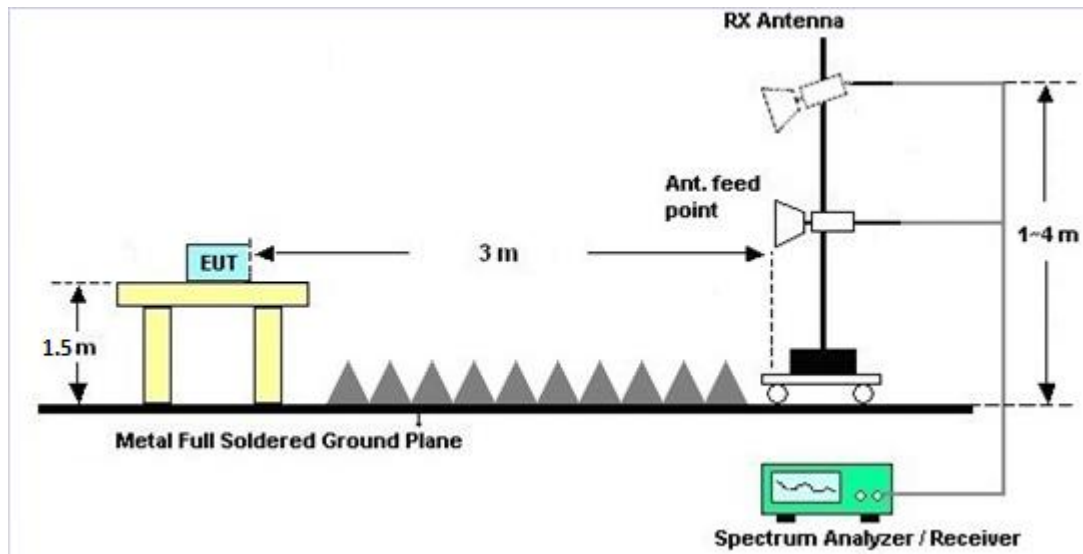

3.5.5 Test Results of Radiated Spurious Emissions (9kHz ~ 30MHz)

The low frequency, which started from 9 kHz to 30MHz, was pre-scanned and the result which was 20dB lower than the limit line was not reported.

There is a comparison data of both open-field test site and semi-Anechoic chamber, and the result came out very similar.

3.5.6 Test Result of Radiated Spurious at Band Edges

Please refer to Appendix C and D.

3.5.7 Duty Cycle

Please refer to Appendix E.

3.5.8 Test Result of Radiated Spurious Emission (30MHz ~ 10th Harmonic)

Please refer to Appendix C and D.



3.6 AC Conducted Emission Measurement

3.6.1 Limit of AC Conducted Emission

For equipment that is designed to be connected to the public utility (AC) power line, the radio frequency voltage that is conducted back onto the AC power line on any frequency or frequencies within the band 150 kHz to 30 MHz shall not exceed the limits in the following table.

Frequency of Emission (MHz)	Conducted Limit (dBµV)	
	Quasi-Peak	Average
0.15-0.5	66 to 56*	56 to 46*
0.5-5	56	46
5-30	60	50

*Decreases with the logarithm of the frequency.

3.6.2 Measuring Instruments

The measuring equipment is listed in the section 4 of this test report.

3.6.3 Test Procedures

1. The EUT was placed 0.4 meter from the conducting wall of the shielding room, and it was kept at least 80 centimeters from any other grounded conducting surface.
2. Connect EUT to the power mains through a line impedance stabilization network (LISN).
3. All the support units are connecting to the other LISN.
4. The LISN provides 50 ohm coupling impedance for the measuring instrument.
5. The FCC states that a 50 ohm, 50 microhenry LISN should be used.
6. Both sides of AC line were checked for maximum conducted interference.
7. The frequency range from 150 kHz to 30 MHz was searched.
8. Set the test-receiver system to Peak Detect Function and specified bandwidth (IF bandwidth = 9kHz) with Maximum Hold Mode.

3.6.4 Test Setup

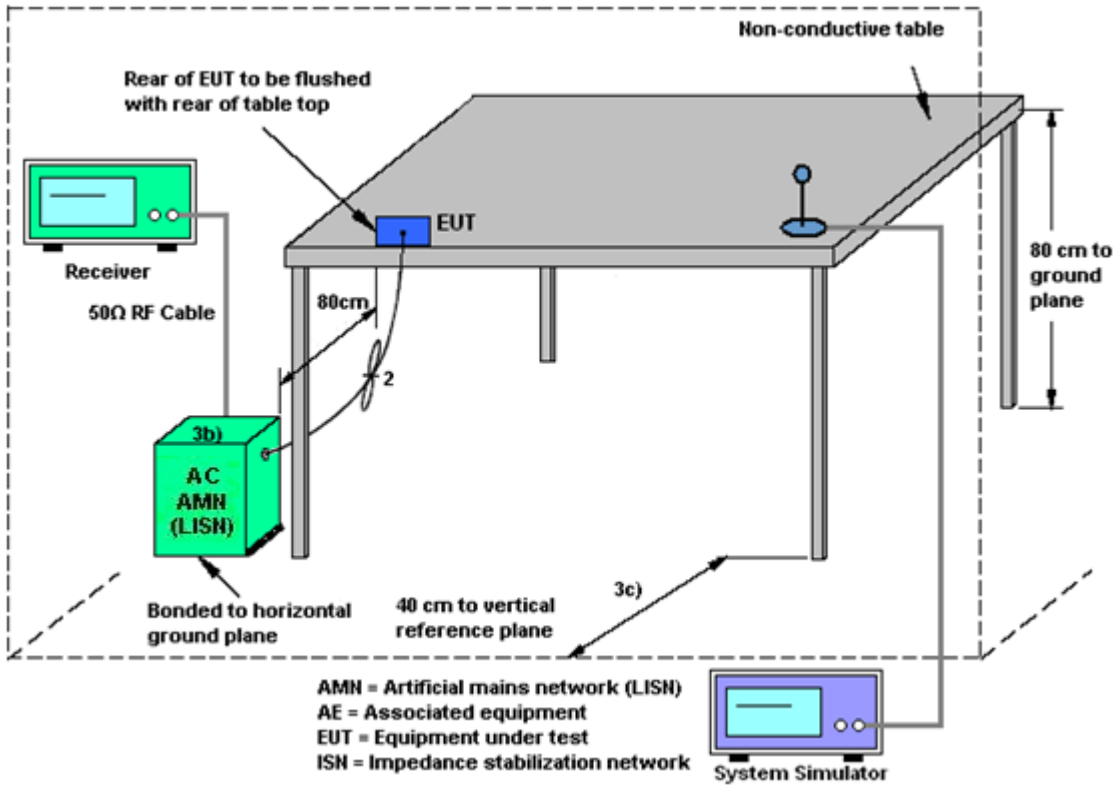

3.6.5 Test Result of AC Conducted Emission

Please refer to Appendix B.



3.7 Antenna Requirements

3.7.1 Standard Applicable

If directional gain of transmitting Antennas is greater than 6dBi, the power shall be reduced by the same level in dB comparing to gain minus 6dBi. The use of a permanently attached Antenna or of an Antenna that uses a unique coupling to the intentional radiator shall be considered sufficient to comply with the rule.

3.7.2 Antenna Anti-Replacement Construction

An embedded-in antenna design is used.

3.7.3 Antenna Gain

The antenna peak gain of EUT is less than 6 dBi. Therefore, it is not necessary to reduce maximum peak output power limit.



4 List of Measuring Equipment

Instrument	Manufacturer	Model No.	Serial No.	Characteristics	Calibration Date	Test Date	Due Date	Remark
Power Meter	Anritsu	ML2495A	1240001	N/A	Sep. 07, 2017	Jan. 02, 2018~ Jan. 20, 2018	Sep. 06, 2018	Conducted (TH05-HY)
Power Sensor	Anritsu	MA2411B	1207349	300MHz~40GHz	Sep. 07, 2017	Jan. 02, 2018~ Jan. 20, 2018	Sep. 06, 2018	Conducted (TH05-HY)
Spectrum Analyzer	Rohde & Schwarz	FSP40	100055	9kHz~40GHz	Jun. 20, 2017	Jan. 02, 2018~ Jan. 20, 2018	Jun. 19, 2018	Conducted (TH05-HY)
AC Power Source	ChainTek	APC-1000W	N/A	N/A	N/A	Jan. 09, 2018	N/A	Conduction (CO05-HY)
EMI Test Receiver	Rohde & Schwarz	ESCI 7	100724	9kHz~7GHz	Sep. 20, 2017	Jan. 09, 2018	Sep. 19, 2018	Conduction (CO05-HY)
LISN	Rohde & Schwarz	ENV216	100080	9kHz~30MHz	Nov. 30, 2017	Jan. 09, 2018	Nov. 29, 2018	Conduction (CO05-HY)
Loop Antenna	Rohde & Schwarz	HFH2-Z2	100315	9 kHz~30 MHz	Nov. 10, 2017	Jan. 03, 2018 ~ Jan. 23, 2018	Nov. 09, 2019	Radiation (03CH13-HY)
Amplifier	MITEQ	TTA1840-35-HG	1871923	18GHz~40GHz, VSWR : 2.5:1 max	Jul. 18, 2017	Jan. 03, 2018 ~ Jan. 23, 2018	Jul. 17, 2018	Radiation (03CH13-HY)
Bilog Antenna	TESEQ	CBL 6111D&N-6-06	35414&AT- N0602	30MHz~1GHz	Oct. 14, 2017	Jan. 03, 2018 ~ Jan. 23, 2018	Oct. 13, 2018	Radiation (03CH13-HY)
Amplifier	Sonoma-Instrument	310 N	187282	9KHz~1GHz	Dec. 21, 2016	Jan. 03, 2018 ~ Jan. 23, 2018	Dec. 20, 2018	Radiation (03CH13-HY)
Horn Antenna	SCHWARZBECK	BBHA 9120 D	9120D-124 1	1GHz ~ 18GHz	Jun. 15, 2017	Jan. 03, 2018 ~ Jan. 23, 2018	Jun. 14, 2018	Radiation (03CH13-HY)
Preamplifier	MITEQ	AMF-7D-001 01800-30-10 P	1590074	1GHz~18GHz	May 22, 2017	Jan. 03, 2018 ~ Jan. 23, 2018	May 21, 2018	Radiation (03CH13-HY)
Spectrum Analyzer	Keysight	N9010A	MY553705 26	10Hz~44GHz	Mar. 15, 2017	Jan. 03, 2018 ~ Jan. 23, 2018	Mar. 14, 2018	Radiation (03CH13-HY)
Antenna Mast	EMEC	AM-BS-4500 -B	N/A	1m~4m	N/A	Jan. 03, 2018 ~ Jan. 23, 2018	N/A	Radiation (03CH13-HY)
Turn Table	EMEC	TT2000	N/A	0~360 Degree	N/A	Jan. 03, 2018 ~ Jan. 23, 2018	N/A	Radiation (03CH13-HY)
SHF-EHF Horn Antenna	SCHWARZBECK	BBHA 9170	BBHA9170 584	18GHz- 40GHz	Nov. 27, 2017	Jan. 03, 2018 ~ Jan. 23, 2018	Nov. 26, 2018	Radiation (03CH13-HY)
Preamplifier	Keysight	83017A	MY532702 64	1GHz ~ 26.5GHz	Dec. 05, 2017	Jan. 03, 2018 ~ Jan. 23, 2018	Dec. 04, 2018	Radiation (03CH13-HY)
EMI Test Receiver	Keysight	N9038A (MXE)	MY572901 11	3Hz~26.5GHz	Nov. 02, 2017	Jan. 03, 2018 ~ Jan. 23, 2018	Nov. 01, 2018	Radiation (03CH13-HY)



5 Uncertainty of Evaluation

Uncertainty of Conducted Emission Measurement (150kHz ~ 30MHz)

Measuring Uncertainty for a Level of Confidence of 95% ($U = 2Uc(y)$)	2.70
---	------

Uncertainty of Radiated Emission Measurement (30 MHz ~ 1000 MHz)

Measuring Uncertainty for a Level of Confidence of 95% ($U = 2Uc(y)$)	4.90
---	------

Uncertainty of Radiated Emission Measurement (1000 MHz ~ 18000 MHz)

Measuring Uncertainty for a Level of Confidence of 95% ($U = 2Uc(y)$)	5.40
---	------

Uncertainty of Radiated Emission Measurement (18000 MHz ~ 40000 MHz)

Measuring Uncertainty for a Level of Confidence of 95% ($U = 2Uc(y)$)	4.30
---	------

Appendix A. Test Result of Conducted Test Items

Test Engineer:	Reece Lin / Kai Liao	Temperature:	21~25	°C
Test Date:	2018/1/2 ~ -2018-1/20	Relative Humidity:	51~54	%

TEST RESULTS DATA
6dB and 99% Occupied Bandwidth

2.4GHz Band								
Mod.	Data Rate	N _{TX}	CH.	Freq. (MHz)	99% Occupied BW (MHz)	6dB BW (MHz)	6dB BW Limit (MHz)	Pass/Fail
11b	1Mbps	1	1	2412	13.75	8.52	0.50	Pass
11b	1Mbps	1	6	2437	13.75	8.04	0.50	Pass
11b	1Mbps	1	11	2462	13.70	8.00	0.50	Pass
11g	6Mbps	1	1	2412	18.15	16.36	0.50	Pass
11g	6Mbps	1	6	2437	18.45	16.32	0.50	Pass
11g	6Mbps	1	11	2462	18.20	16.32	0.50	Pass
HT20	MCS0	1	1	2412	18.80	17.52	0.50	Pass
HT20	MCS0	1	6	2437	19.20	17.56	0.50	Pass
HT20	MCS0	1	11	2462	18.85	17.56	0.50	Pass

TEST RESULTS DATA
Peak Power Table

2.4GHz Band										
Mod.	Data Rate	N _{TX}	CH.	Freq. (MHz)	Peak Conducted Power (dBm)	Conducted Power Limit (dBm)	DG (dBi)	EIRP Power (dBm)	EIRP Power Limit (dBm)	Pass /Fail
11b	1Mbps	1	1	2412	20.48	30.00	-3.20	17.28	36.00	Pass
11b	1Mbps	1	6	2437	20.55	30.00	-3.20	17.35	36.00	Pass
11b	1Mbps	1	11	2462	20.45	30.00	-3.20	17.25	36.00	Pass
11g	6Mbps	1	1	2412	19.73	30.00	-3.20	16.53	36.00	Pass
11g	6Mbps	1	6	2437	19.65	30.00	-3.20	16.45	36.00	Pass
11g	6Mbps	1	11	2462	19.45	30.00	-3.20	16.25	36.00	Pass
HT20	MCS0	1	1	2412	18.74	30.00	-3.20	15.54	36.00	Pass
HT20	MCS0	1	6	2437	18.51	30.00	-3.20	15.31	36.00	Pass
HT20	MCS0	1	11	2462	18.60	30.00	-3.20	15.40	36.00	Pass

TEST RESULTS DATA
Average Power Table
(Reporting Only)

2.4GHz Band						
Mod.	Data Rate	N _{TX}	CH.	Freq. (MHz)	Duty Factor (dB)	Average Conducted Power (dBm)
11b	1Mbps	1	1	2412	0.10	17.99
11b	1Mbps	1	6	2437	0.10	17.98
11b	1Mbps	1	11	2462	0.10	17.90
11g	6Mbps	1	1	2412	0.62	10.49
11g	6Mbps	1	6	2437	0.62	10.47
11g	6Mbps	1	11	2462	0.62	10.40
HT20	MCS0	1	1	2412	0.63	9.47
HT20	MCS0	1	6	2437	0.63	9.35
HT20	MCS0	1	11	2462	0.63	9.49

TEST RESULTS DATA
Peak Power Density

2.4GHz Band								
Mod.	Data Rate	N _{TX}	CH.	Freq. (MHz)	Peak PSD (dBm /3kHz)	DG (dBi)	Peak PSD Limit (dBm /3kHz)	Pass/Fail
11b	1Mbps	1	1	2412	-4.73	-3.20	8.00	Pass
11b	1Mbps	1	6	2437	-5.32	-3.20	8.00	Pass
11b	1Mbps	1	11	2462	-4.49	-3.20	8.00	Pass
11g	6Mbps	1	1	2412	-15.55	-3.20	8.00	Pass
11g	6Mbps	1	6	2437	-15.08	-3.20	8.00	Pass
11g	6Mbps	1	11	2462	-15.40	-3.20	8.00	Pass
HT20	MCS0	1	1	2412	-16.59	-3.20	8.00	Pass
HT20	MCS0	1	6	2437	-16.60	-3.20	8.00	Pass
HT20	MCS0	1	11	2462	-16.03	-3.20	8.00	Pass



Appendix B. AC Conducted Emission Test Results

Test Engineer :	Blue Lan	Temperature :	24~25°C
		Relative Humidity :	46~48%

EUT Information

Report NO : 7D2018-03
 Test Mode : Mode 1
 Test Voltage : 120Vac/60Hz
 Phase : Line

ENV216 Auto Test FCC Power Bar - L

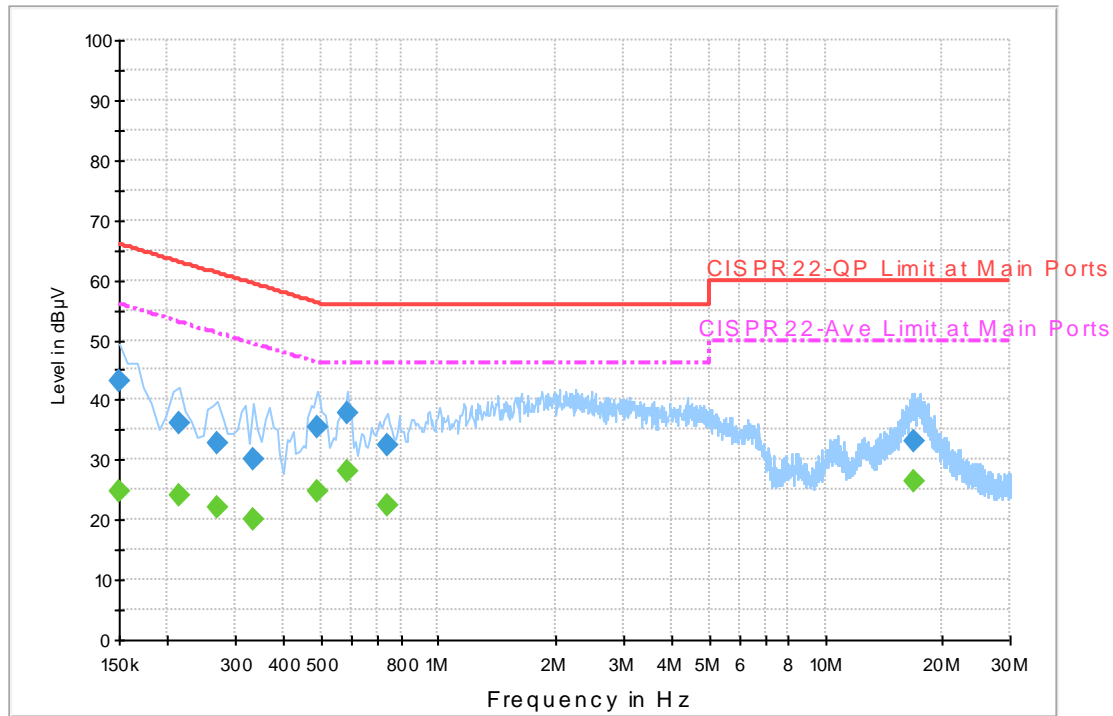

Final Result 1

Frequency (MHz)	QuasiPeak (dBµV)	Filter	Line	Corr. (dB)	Margin (dB)	Limit (dBµV)
0.150000	43.0	Off	L1	19.5	23.0	66.0
0.214000	36.1	Off	L1	19.5	26.9	63.0
0.270000	32.7	Off	L1	19.5	28.4	61.1
0.334000	30.2	Off	L1	19.5	29.2	59.4
0.486000	35.5	Off	L1	19.5	20.7	56.2
0.582000	37.8	Off	L1	19.5	18.2	56.0
0.742000	32.3	Off	L1	19.5	23.7	56.0
16.974000	33.2	Off	L1	19.8	26.8	60.0

Final Result 2

Frequency (MHz)	Average (dBµV)	Filter	Line	Corr. (dB)	Margin (dB)	Limit (dBµV)
0.150000	24.6	Off	L1	19.5	31.4	56.0
0.214000	24.2	Off	L1	19.5	28.8	53.0
0.270000	22.0	Off	L1	19.5	29.1	51.1
0.334000	20.0	Off	L1	19.5	29.4	49.4
0.486000	24.6	Off	L1	19.5	21.6	46.2
0.582000	28.0	Off	L1	19.5	18.0	46.0
0.742000	22.5	Off	L1	19.5	23.5	46.0
16.974000	26.5	Off	L1	19.8	23.5	50.0

EUT Information

Report NO : 7D2018-03
 Test Mode : Mode 1
 Test Voltage : 120Vac/60Hz
 Phase : Neutral

ENV216 Auto Test FCC Power Bar - N

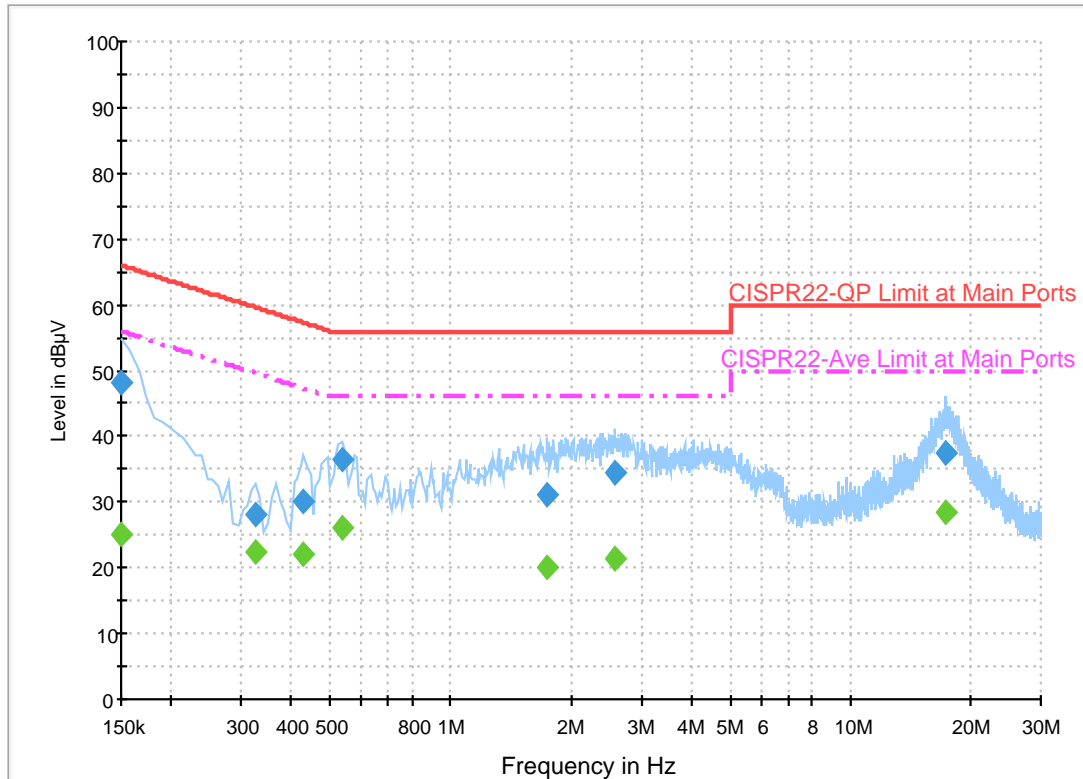

Final Result 1

Frequency (MHz)	QuasiPeak (dBµV)	Filter	Line	Corr. (dB)	Margin (dB)	Limit (dBµV)
0.150000	48.2	Off	N	19.5	17.8	66.0
0.326000	28.2	Off	N	19.5	31.4	59.6
0.430000	30.2	Off	N	19.5	27.1	57.3
0.534000	36.4	Off	N	19.5	19.6	56.0
1.742000	31.3	Off	N	19.6	24.7	56.0
2.582000	34.4	Off	N	19.5	21.6	56.0
17.406000	37.5	Off	N	19.8	22.5	60.0

Final Result 2

Frequency (MHz)	Average (dBµV)	Filter	Line	Corr. (dB)	Margin (dB)	Limit (dBµV)
0.150000	25.1	Off	N	19.5	30.9	56.0
0.326000	22.4	Off	N	19.5	27.2	49.6
0.430000	22.2	Off	N	19.5	25.1	47.3
0.534000	26.2	Off	N	19.5	19.8	46.0
1.742000	20.2	Off	N	19.6	25.8	46.0
2.582000	21.5	Off	N	19.5	24.5	46.0
17.406000	28.4	Off	N	19.8	21.6	50.0



Appendix C. Radiated Spurious Emission

Test Engineer :	Alex Jheng, Bill Chang, and Wilson Wu	Temperature :	24.9~25.1°C
		Relative Humidity :	48~51%

2.4GHz 2400~2483.5MHz

WIFI 802.11b (Band Edge @ 3m)

WIFI	Note	Frequency	Level	Over	Limit	Read	Antenna	Cable	Preamp	Ant	Table	Peak	Pol.	
Ant.		(MHz)	(dBµV/m)	(dB)	(dBµV/m)	(dBµV)	(dB/m)	(dB)	(dB)	(cm)	(deg)	(P/A)	(H/V)	
802.11b CH 01 2412MHz		2384.55	52.75	-21.25	74	41.14	26.84	4.83	29.99	127	94	P	H	
		2387.595	44.07	-9.93	54	32.41	26.89	4.83	29.99	127	94	A	H	
	*	2412	106.49	-	-	94.74	26.94	4.87	29.99	127	94	P	H	
	*	2412	103.25	-	-	91.5	26.94	4.87	29.99	127	94	A	H	
													H	
														H
			2387.49	52.87	-21.13	74	41.21	26.89	4.83	29.99	400	53	P	V
			2385.495	42.93	-11.07	54	31.32	26.84	4.83	29.99	400	53	A	V
	*		2412	104.52	-	-	92.77	26.94	4.87	29.99	400	53	P	V
	*		2412	101.02	-	-	89.27	26.94	4.87	29.99	400	53	A	V
														V
														V
802.11b CH 06 2437MHz		2361.38	52	-22	74	40.48	26.79	4.8	30	126	98	P	H	
		2383.64	42.44	-11.56	54	30.83	26.84	4.83	29.99	126	98	A	H	
	*	2437	106.18	-	-	94.31	27.04	4.88	29.98	126	98	P	H	
	*	2437	103.19	-	-	91.32	27.04	4.88	29.98	126	98	A	H	
			2487.68	54.01	-19.99	74	41.92	27.2	4.93	29.97	126	98	P	H
			2484.53	42.68	-11.32	54	30.64	27.15	4.93	29.97	126	98	A	H
			2380	52.59	-21.41	74	40.98	26.84	4.83	29.99	394	45	P	V
			2383.78	41.95	-12.05	54	30.34	26.84	4.83	29.99	394	45	A	V
	*		2437	104.21	-	-	92.34	27.04	4.88	29.98	394	45	P	V
	*		2437	101.06	-	-	89.19	27.04	4.88	29.98	394	45	A	V
			2485.93	52.73	-21.27	74	40.69	27.15	4.93	29.97	394	45	P	V
			2484.95	42.36	-11.64	54	30.32	27.15	4.93	29.97	394	45	A	V



802.11b CH 11 2462MHz	*	2462	110.54	-	-	98.58	27.1	4.9	29.97	115	152	P	H
	*	2462	107.05	-	-	95.09	27.1	4.9	29.97	115	152	A	H
		2483.76	57.22	-16.78	74	45.18	27.15	4.93	29.97	115	152	P	H
		2483.52	50.26	-3.74	54	38.22	27.15	4.93	29.97	115	152	A	H
													H
													H
	*	2462	105.71	-	-	93.75	27.1	4.9	29.97	385	38	P	V
	*	2462	102.45	-	-	90.49	27.1	4.9	29.97	385	38	A	V
		2483.52	54.71	-19.29	74	42.67	27.15	4.93	29.97	385	38	P	V
		2483.52	46.22	-7.78	54	34.18	27.15	4.93	29.97	385	38	A	V
													V
													V
Remark	<ol style="list-style-type: none"> 1. No other spurious found. 2. All results are PASS against Peak and Average limit line. 												



2.4GHz 2400~2483.5MHz

WIFI 802.11b (Harmonic @ 3m)

WIFI Ant. 1	Note	Frequency (MHz)	Level (dBμV/m)	Over Limit (dB)	Limit Line (dBμV/m)	Read Level (dBμV)	Antenna Factor (dB/m)	Cable Loss (dB)	Preamp Factor (dB)	Ant Pos (cm)	Table Pos (deg)	Peak Avg. (P/A)	Pol. (H/V)	
802.11b CH 01 2412MHz		4824	48.85	-25.15	74	66.69	31.56	7.33	57.24	100	0	P	H	
													H	
													H	
													H	
			4824	43.56	-30.44	74	61.4	31.56	7.33	57.24	100	0	P	V
														V
														V
802.11b CH 06 2437MHz		4874	44.69	-29.31	74	62.29	31.63	7.44	57.17	100	0	P	H	
		7311	44.15	-29.85	74	55.67	36.16	9.13	57.27	100	0	P	H	
													H	
													H	
			4874	42.51	-31.49	74	60.11	31.63	7.44	57.17	100	0	P	V
			7311	44.39	-29.61	74	55.91	36.16	9.13	57.27	100	0	P	V
														V
802.11b CH 11 2462MHz		4924	45.61	-28.39	74	62.99	31.7	7.52	57.1	100	0	P	H	
		7386	45.77	-28.23	74	57.22	36.31	9.18	57.38	100	0	P	H	
													H	
													H	
			4924	42.49	-31.51	74	59.87	31.7	7.52	57.1	100	0	P	V
			7386	45.96	-28.04	74	57.41	36.31	9.18	57.38	100	0	P	V
														V
Remark	1. No other spurious found.													
	2. All results are PASS against Peak and Average limit line.													



2.4GHz 2400~2483.5MHz
WIFI 802.11g (Band Edge @ 3m)

WIFI Ant. 1	Note	Frequency (MHz)	Level (dBμV/m)	Over Limit (dB)	Limit Line (dBμV/m)	Read Level (dBμV)	Antenna Factor (dB/m)	Cable Loss (dB)	Preamp Factor (dB)	Ant Pos (cm)	Table Pos (deg)	Peak Avg. (P/A)	Pol. (H/V)	
802.11g CH 01 2412MHz		2314.2	53.42	-20.58	74	42.13	26.63	4.74	30.01	100	106	P	H	
		2389.275	42.71	-11.29	54	31.05	26.89	4.83	29.99	100	106	A	H	
	*	2412	101.5	-	-	89.75	26.94	4.87	29.99	100	106	P	H	
	*	2412	92.98	-	-	81.23	26.94	4.87	29.99	100	106	A	H	
													H	
														H
			2374.68	52.96	-21.04	74	41.38	26.84	4.8	29.99	400	51	P	V
			2386.86	42.48	-11.52	54	30.82	26.89	4.83	29.99	400	51	A	V
	*		2412	100.45	-	-	88.7	26.94	4.87	29.99	400	51	P	V
	*		2412	92.34	-	-	80.59	26.94	4.87	29.99	400	51	A	V
														V
														V
802.11g CH 06 2437MHz		2340.24	53.44	-20.56	74	42	26.73	4.78	30	122	104	P	H	
		2384.9	43.13	-10.87	54	31.52	26.84	4.83	29.99	122	104	A	H	
	*	2437	101.9	-	-	90.03	27.04	4.88	29.98	122	104	P	H	
	*	2437	93.74	-	-	81.87	27.04	4.88	29.98	122	104	A	H	
			2496.78	54.14	-19.86	74	42.04	27.2	4.93	29.96	122	104	P	H
			2489.08	44.15	-9.85	54	32.06	27.2	4.93	29.97	122	104	A	H
			2325.96	53.04	-20.96	74	41.68	26.68	4.76	30.01	389	46	P	V
			2383.78	42.41	-11.59	54	30.8	26.84	4.83	29.99	389	46	A	V
	*		2437	100.29	-	-	88.42	27.04	4.88	29.98	389	46	P	V
	*		2437	92.07	-	-	80.2	27.04	4.88	29.98	389	46	A	V
			2486.35	53.09	-20.91	74	41.05	27.15	4.93	29.97	389	46	P	V
			2489.36	43.34	-10.66	54	31.25	27.2	4.93	29.97	389	46	A	V



802.11g CH 11 2462MHz	*	2462	104.88	-	-	92.92	27.1	4.9	29.97	122	105	P	H
	*	2462	95.54	-	-	83.58	27.1	4.9	29.97	122	105	A	H
		2483.52	63.02	-10.98	74	50.98	27.15	4.93	29.97	122	105	P	H
		2483.52	47.31	-6.69	54	35.27	27.15	4.93	29.97	122	105	A	H
													H
													H
	*	2462	100.83	-	-	88.87	27.1	4.9	29.97	385	46	P	V
	*	2462	91.75	-	-	79.79	27.1	4.9	29.97	385	46	A	V
		2483.64	59	-15	74	46.96	27.15	4.93	29.97	385	46	P	V
		2483.52	45.35	-8.65	54	33.31	27.15	4.93	29.97	385	46	A	V
													V
													V
Remark	1. No other spurious found. 2. All results are PASS against Peak and Average limit line.												



**2.4GHz 2400~2483.5MHz
WIFI 802.11g (Harmonic @ 3m)**

WIFI Ant. 1	Note	Frequency (MHz)	Level (dBµV/m)	Over Limit (dB)	Limit Line (dBµV/m)	Read Level (dBµV)	Antenna Factor (dB/m)	Cable Loss (dB)	Preamp Factor (dB)	Ant Pos (cm)	Table Pos (deg)	Peak Avg. (P/A)	Pol. (H/V)	
802.11g CH 01 2412MHz		4824	39.59	-34.41	74	57.43	31.56	7.33	57.24	100	0	P	H	
													H	
													H	
													H	
			4824	38.1	-35.9	74	55.94	31.56	7.33	57.24	100	0	P	V
														V
														V
802.11g CH 06 2437MHz		4874	38.86	-35.14	74	56.46	31.63	7.44	57.17	100	0	P	H	
		7311	44.12	-29.88	74	55.64	36.16	9.13	57.27	100	0	P	H	
													H	
													H	
			4874	37.63	-36.37	74	55.23	31.63	7.44	57.17	100	0	P	V
			7311	42.75	-31.25	74	54.27	36.16	9.13	57.27	100	0	P	V
														V
802.11g CH 11 2462MHz		4924	39.43	-34.57	74	56.81	31.7	7.52	57.1	100	0	P	H	
		7386	43.5	-30.5	74	54.95	36.31	9.18	57.38	100	0	P	H	
													H	
													H	
			4924	40.05	-33.95	74	57.43	31.7	7.52	57.1	100	0	P	V
			7386	44.66	-29.34	74	56.11	36.31	9.18	57.38	100	0	P	V
														V
Remark	1. No other spurious found.													
	2. All results are PASS against Peak and Average limit line.													



**2.4GHz 2400~2483.5MHz
WIFI 802.11n HT20 (Band Edge @ 3m)**

WIFI Ant. 1	Note	Frequency (MHz)	Level (dBμV/m)	Over Limit (dB)	Limit Line (dBμV/m)	Read Level (dBμV)	Antenna Factor (dB/m)	Cable Loss (dB)	Preamp Factor (dB)	Ant Pos (cm)	Table Pos (deg)	Peak Avg. (P/A)	Pol. (H/V)	
802.11n HT20 CH 01 2412MHz		2373.735	52.92	-21.08	74	41.34	26.84	4.8	29.99	137	102	P	H	
		2385.075	42.6	-11.4	54	30.99	26.84	4.83	29.99	137	102	A	H	
	*	2412	99.18	-	-	87.43	26.94	4.87	29.99	137	102	P	H	
	*	2412	90.47	-	-	78.72	26.94	4.87	29.99	137	102	A	H	
													H	
														H
			2310.63	52.96	-21.04	74	41.68	26.63	4.74	30.02	400	61	P	V
			2378.145	42.33	-11.67	54	30.72	26.84	4.83	29.99	400	61	A	V
		*	2412	96.6	-	-	84.85	26.94	4.87	29.99	400	61	P	V
		*	2412	88.33	-	-	76.58	26.94	4.87	29.99	400	61	A	V
													V	
													V	
802.11n HT20 CH 06 2437MHz		2381.68	52.51	-21.49	74	40.9	26.84	4.83	29.99	126	108	P	H	
		2385.18	42.99	-11.01	54	31.38	26.84	4.83	29.99	126	108	A	H	
	*	2437	99.11	-	-	87.24	27.04	4.88	29.98	126	108	P	H	
	*	2437	91.14	-	-	79.27	27.04	4.88	29.98	126	108	A	H	
			2489.29	53.56	-20.44	74	41.47	27.2	4.93	29.97	126	108	P	H
			2488.73	43.82	-10.18	54	31.73	27.2	4.93	29.97	126	108	A	H
			2376.92	52.84	-21.16	74	41.23	26.84	4.83	29.99	392	51	P	V
			2384.9	42.33	-11.67	54	30.72	26.84	4.83	29.99	392	51	A	V
		*	2437	98.88	-	-	87.01	27.04	4.88	29.98	392	51	P	V
		*	2437	90.46	-	-	78.59	27.04	4.88	29.98	392	51	A	V
		2489.5	54.2	-19.8	74	42.11	27.2	4.93	29.97	392	51	P	V	
		2488.66	43.14	-10.86	54	31.05	27.2	4.93	29.97	392	51	A	V	



802.11n HT20 CH 11 2462MHz	*	2462	100.3	-	-	88.34	27.1	4.9	29.97	125	100	P	H
	*	2462	92.51	-	-	80.55	27.1	4.9	29.97	125	100	A	H
		2483.72	60.93	-13.07	74	48.89	27.15	4.93	29.97	125	100	P	H
		2483.6	46.86	-7.14	54	34.82	27.15	4.93	29.97	125	100	A	H
													H
													H
	*	2462	99.11	-	-	87.15	27.1	4.9	29.97	395	36	P	V
	*	2462	90.59	-	-	78.63	27.1	4.9	29.97	395	36	A	V
		2483.56	57.49	-16.51	74	45.45	27.15	4.93	29.97	395	36	P	V
		2483.52	45.28	-8.72	54	33.24	27.15	4.93	29.97	395	36	A	V
													V
												V	
Remark	1. No other spurious found. 2. All results are PASS against Peak and Average limit line.												



**2.4GHz 2400~2483.5MHz
WIFI 802.11n HT20 (Harmonic @ 3m)**

WIFI Ant. 1	Note	Frequency (MHz)	Level (dBμV/m)	Over Limit (dB)	Limit Line (dBμV/m)	Read Level (dBμV)	Antenna Factor (dB/m)	Cable Loss (dB)	Preamp Factor (dB)	Ant Pos (cm)	Table Pos (deg)	Peak Avg. (P/A)	Pol. (H/V)	
802.11n HT20 CH 01 2412MHz		4824	39.77	-34.23	74	57.61	31.56	7.33	57.24	100	0	P	H	
													H	
													H	
													H	
			4824	38.98	-35.02	74	56.82	31.56	7.33	57.24	100	0	P	V
														V
														V
802.11n HT20 CH 06 2437MHz		4874	38	-36	74	55.6	31.63	7.44	57.17	100	0	P	H	
													H	
			7311	43.02	-30.98	74	54.54	36.16	9.13	57.27	100	0	P	H
														H
			4874	38.27	-35.73	74	55.87	31.63	7.44	57.17	100	0	P	V
			7311	42.98	-31.02	74	54.5	36.16	9.13	57.27	100	0	P	V
														V
802.11n HT20 CH 11 2462MHz		4924	39.83	-34.17	74	57.21	31.7	7.52	57.1	100	0	P	H	
													H	
			7386	44.44	-29.56	74	55.89	36.31	9.18	57.38	100	0	P	H
														H
			4924	40.35	-33.65	74	57.73	31.7	7.52	57.1	100	0	P	V
			7386	45.19	-28.81	74	56.64	36.31	9.18	57.38	100	0	P	V
														V
Remark	1. No other spurious found. 2. All results are PASS against Peak and Average limit line.													



Emission below 1GHz
2.4GHz WIFI 802.11b (LF)

WIFI Ant. 1	Note	Frequency (MHz)	Level (dBμV/m)	Over Limit (dB)	Limit Line (dBμV/m)	Read Level (dBμV)	Antenna Factor (dB/m)	Cable Loss (dB)	Preamp Factor (dB)	Ant Pos (cm)	Table Pos (deg)	Peak Avg. (P/A)	Pol. (H/V)
		30	21.53	-18.47	40	30.67	22.63	0.59	32.34	-	-	P	H
		133.41	24.2	-19.3	43.5	41.47	13.77	1.19	32.28	-	-	P	H
		285.96	27.26	-18.74	46	42.17	15.49	1.68	32.15	-	-	P	H
		432.3	27.83	-18.17	46	38.45	19.44	2.03	32.17	-	-	P	H
		731.2	37.08	-8.92	46	41.77	24.66	2.66	32.11	100	0	P	H
		825	29.91	-16.09	46	33.39	25.46	2.81	31.87	-	-	P	H
													H
													H
													H
													H
													H
													H
2.4GHz 802.11b LF		64.02	27.82	-12.18	40	51.02	8.2	0.84	32.31	-	-	P	V
		76.98	27.08	-12.92	40	48.15	10.19	0.95	32.3	-	-	P	V
		119.91	23.65	-19.85	43.5	41.28	13.51	1.09	32.29	-	-	P	V
		612.9	25.65	-20.35	46	32.54	22.78	2.42	32.2	-	-	P	V
		736.8	36.55	-9.45	46	41.08	24.81	2.66	32.1	100	0	P	V
		946.8	30.07	-15.93	46	30.24	27.71	3.06	31.08	-	-	P	V
													V
													V
													V
													V
													V
													V
													V
Remark	1. No other spurious found. 2. All results are PASS against limit line.												



Note symbol

*	Fundamental Frequency which can be ignored. However, the level of any unwanted emissions shall not exceed the level of the fundamental frequency.
!	Test result is over limit line.
P/A	Peak or Average
H/V	Horizontal or Vertical



A calculation example for radiated spurious emission is shown as below:

WIFI	Note	Frequency	Level	Over	Limit	Read	Antenna	Cable	Preamp	Ant	Table	Peak	Pol.
Ant.				Limit	Line	Level	Factor	Loss	Factor	Pos	Pos	Avg.	
1		(MHz)	(dBμV/m)	(dB)	(dBμV/m)	(dBμV)	(dB/m)	(dB)	(dB)	(cm)	(deg)	(P/A)	(H/V)
802.11b		2390	55.45	-18.55	74	54.51	32.22	4.58	35.86	103	308	P	H
CH 01													
2412MHz		2390	43.54	-10.46	54	42.6	32.22	4.58	35.86	103	308	A	H

- Level(dBμV/m) =
Antenna Factor(dB/m) + Cable Loss(dB) + Read Level(dBμV) - Preamp Factor(dB)
- Over Limit(dB) = Level(dBμV/m) – Limit Line(dBμV/m)

For Peak Limit @ 2390MHz:

- Level(dBμV/m)
= Antenna Factor(dB/m) + Cable Loss(dB) + Read Level(dBμV) - Preamp Factor(dB)
= 32.22(dB/m) + 4.58(dB) + 54.51(dBμV) – 35.86 (dB)
= 55.45 (dBμV/m)
- Over Limit(dB)
= Level(dBμV/m) – Limit Line(dBμV/m)
= 55.45(dBμV/m) – 74(dBμV/m)
= -18.55(dB)

For Average Limit @ 2390MHz:

- Level(dBμV/m)
= Antenna Factor(dB/m) + Cable Loss(dB) + Read Level(dBμV) - Preamp Factor(dB)
= 32.22(dB/m) + 4.58(dB) + 42.6(dBμV) – 35.86 (dB)
= 43.54 (dBμV/m)
- Over Limit(dB)
= Level(dBμV/m) – Limit Line(dBμV/m)
= 43.54(dBμV/m) – 54(dBμV/m)
= -10.46(dB)

Both peak and average measured complies with the limit line, so test result is “PASS”.



Appendix D. Radiated Spurious Emission Plots

Test Engineer :	Alex Jheng, Bill Chang, and Wilson Wu	Temperature :	24.9~25.1°C
		Relative Humidity :	48~51%

Note symbol

-L	Low channel location
-R	High channel location

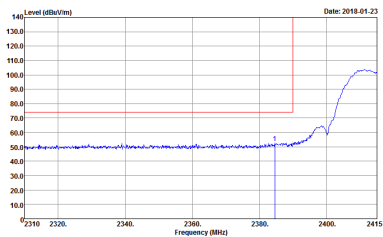
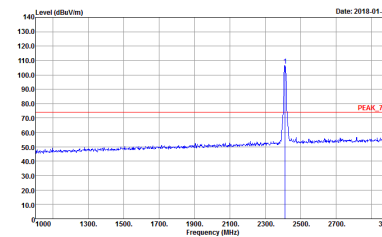
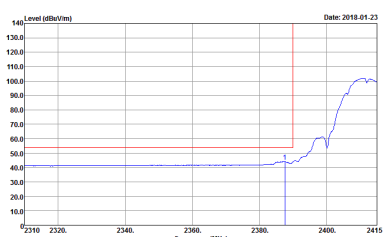
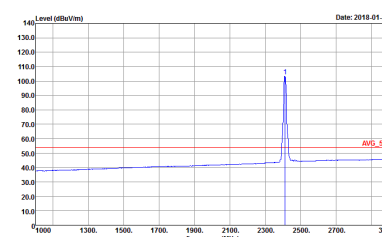

2.4GHz 2400~2483.5MHz
WIFI 802.11b (Band Edge @ 3m)

WIFI	2.4GHz 2400~2483.5MHz Band Edge @ 3m	
ANT	802.11b CH01 2412MHz	
1	Horizontal	Fundamental
Peak	 <p>Site : 03CH13-HY Condition : PEAK_BE_74 3m HORN_91200_1241 HORIZONTAL Detector : Peak Project : 7D2018-03 Mode : 9</p>	 <p>Site : 03CH13-HY Condition : PEAK_74 3m HORN_91200_1241 HORIZONTAL Detector : Peak Project : 7D2018-03 Mode : 9</p>
Avg.	 <p>Site : 03CH13-HY Condition : AV6_BE_54 3m HORN_91200_1241 HORIZONTAL Detector : Peak Project : 7D2018-03 Mode : 9</p>	 <p>Site : 03CH13-HY Condition : AV6_54 3m HORN_91200_1241 HORIZONTAL Detector : Peak Project : 7D2018-03 Mode : 9</p>



WIFI	2.4GHz 2400~2483.5MHz Band Edge @ 3m	
ANT	802.11b CH01 2412MHz	
1	Vertical	Fundamental
Peak	<p>Site : 03CH13-HY Condition : PEAK_BE_74 3m HORN_91200_1241 VERTICAL : RBW:1000.000KHz VBW:3000.000KHz SWT:Auto Detector : Peak Project : 7D2018-03 Mode : 9</p>	<p>Site : 03CH13-HY Condition : PEAK_74 3m HORN_91200_1241 VERTICAL : RBW:1000.000KHz VBW:3000.000KHz SWT:Auto Detector : Peak Project : 7D2018-03 Mode : 9</p>
	<p>Site : 03CH13-HY Condition : AVG_BE_54 3m HORN_91200_1241 VERTICAL : RBW:1000.000KHz VBW:0.300KHz SWT:Auto Detector : Peak Project : 7D2018-03 Mode : 9</p>	<p>Site : 03CH13-HY Condition : AVG_54 3m HORN_91200_1241 VERTICAL : RBW:1000.000KHz VBW:0.300KHz SWT:Auto Detector : Peak Project : 7D2018-03 Mode : 9</p>
Avg.		

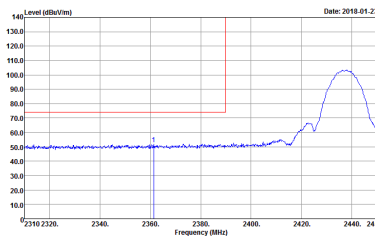
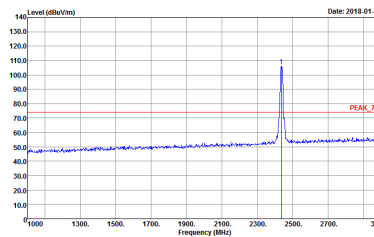
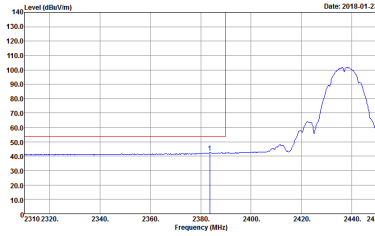
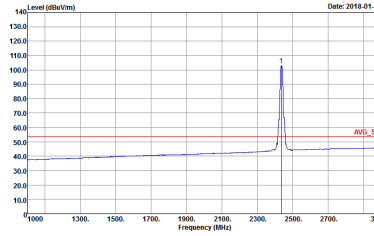

WIFI	2.4GHz 2400~2483.5MHz Band Edge @ 3m	
ANT	802.11b CH06 2437MHz - L	
1	Horizontal	Fundamental
Peak	 <p>Site : 03CH13-HY Condition : PEAK_BE_74 3m HORN_91200_1241 HORIZONTAL Detector : Peak Project : 7D2018-03 Mode : ID</p>	 <p>Site : 03CH13-HY Condition : PEAK_74 3m HORN_91200_1241 HORIZONTAL Detector : Peak Project : 7D2018-03 Mode : ID</p>
Avg.	 <p>Site : 03CH13-HY Condition : AVG_BE_54 3m HORN_91200_1241 HORIZONTAL Detector : Peak Project : 7D2018-03 Mode : ID</p>	 <p>Site : 03CH13-HY Condition : AVG_54 3m HORN_91200_1241 HORIZONTAL Detector : Peak Project : 7D2018-03 Mode : ID</p>

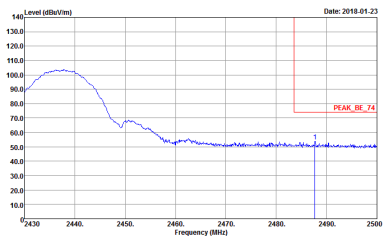
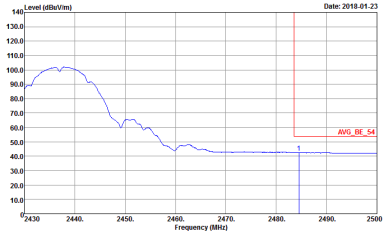

WIFI	2.4GHz 2400~2483.5MHz Band Edge @ 3m	
ANT	802.11b CH06 2437MHz - R	
1	Horizontal	Fundamental
<p>Peak</p>	 <p>Date: 2018.01.23</p> <p>Site : 03CH13-HY Condition : PEAK_BE_74 3m HORN_91200_1241 HORIZONTAL Detector : Peak Project : 7D2018-03 Mode : ID</p>	<p>Left blank</p>
<p>Avg.</p>	 <p>Date: 2018.01.23</p> <p>Site : 03CH13-HY Condition : AVG_BE_54 3m HORN_91200_1241 HORIZONTAL Detector : Peak Project : 7D2018-03 Mode : ID</p>	<p>Left blank</p>



WIFI	2.4GHz 2400~2483.5MHz Band Edge @ 3m	
ANT	802.11b CH06 2437MHz - L	
1	Vertical	Fundamental
Peak	<p>Site : 03CH13-HY Condition : PEAK_BE_74 3m HORN_91200_1241 VERTICAL : RBW:1000.000KHz VBW:3000.000KHz SWT:Auto Detector : Peak Project : 7D2018-03 Mode : ID</p>	<p>Site : 03CH13-HY Condition : PEAK_74 3m HORN_91200_1241 VERTICAL : RBW:1000.000KHz VBW:3000.000KHz SWT:Auto Detector : Peak Project : 7D2018-03 Mode : ID</p>
	<p>Site : 03CH13-HY Condition : AVG_BE_54 3m HORN_91200_1241 VERTICAL : RBW:1000.000KHz VBW:0.300KHz SWT:Auto Detector : Peak Project : 7D2018-03 Mode : ID</p>	<p>Site : 03CH13-HY Condition : AVG_54 3m HORN_91200_1241 VERTICAL : RBW:1000.000KHz VBW:0.300KHz SWT:Auto Detector : Peak Project : 7D2018-03 Mode : ID</p>
Avg.		

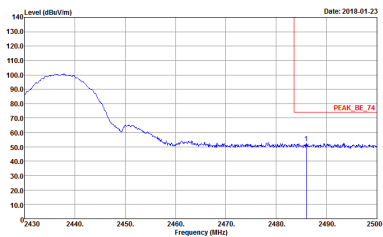
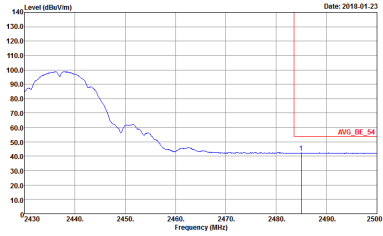

WIFI	2.4GHz 2400~2483.5MHz Band Edge @ 3m	
ANT	802.11b CH06 2437MHz - R	
1	Vertical	Fundamental
Peak	 <p>Site : 03CH13-HY Condition : PEAK_BE_74 3m HORN_91200_1241 VERTICAL Detector : Peak Project : 7D2018-03 Mode : ID</p>	Left blank
Avg.	 <p>Site : 03CH13-HY Condition : AVG_BE_54 3m HORN_91200_1241 VERTICAL Detector : Peak Project : 7D2018-03 Mode : ID</p>	Left blank

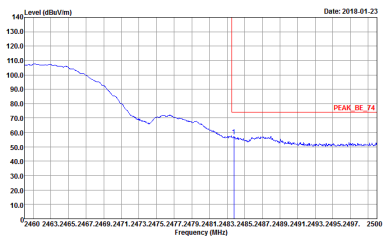
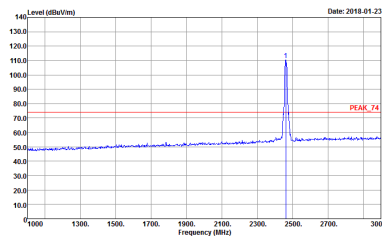
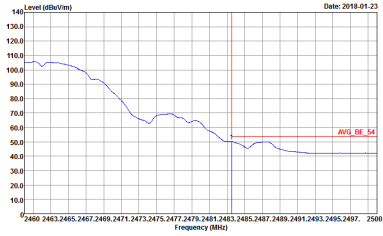
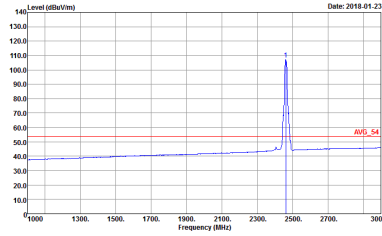

WIFI	2.4GHz 2400~2483.5MHz Band Edge @ 3m	
ANT	802.11b CH11 2462MHz	
1	Horizontal	Fundamental
Peak	 <p>Site : 03CH13-HY Condition : PEAK_BE_74 3m HORN_91200_1241 HORIZONTAL Detector : Peak Project : 7D2018-03 Mode : 11</p>	 <p>Site : 03CH13-HY Condition : PEAK_74 3m HORN_91200_1241 HORIZONTAL Detector : Peak Project : 7D2018-03 Mode : 11</p>
Avg.	 <p>Site : 03CH13-HY Condition : AVG_BE_54 3m HORN_91200_1241 HORIZONTAL Detector : Peak Project : 7D2018-03 Mode : 11</p>	 <p>Site : 03CH13-HY Condition : AVG_54 3m HORN_91200_1241 HORIZONTAL Detector : Peak Project : 7D2018-03 Mode : 11</p>



WIFI	2.4GHz 2400~2483.5MHz Band Edge @ 3m	
ANT	802.11b CH11 2462MHz	
1	Vertical	Fundamental
Peak	<p>Site : 03CH13-HY Condition : PEAK_BE_74 3m HORN_91200_1241 VERTICAL RBW:1000.000KHz VBW:3000.000KHz SWT:Auto Detector : Peak Project : 7D2018-03 Mode : 11</p>	<p>Site : 03CH13-HY Condition : PEAK_74 3m HORN_91200_1241 VERTICAL RBW:1000.000KHz VBW:3000.000KHz SWT:Auto Detector : Peak Project : 7D2018-03 Mode : 11</p>
	<p>Site : 03CH13-HY Condition : AVG_BE_54 3m HORN_91200_1241 VERTICAL RBW:1000.000KHz VBW:3.000KHz SWT:Auto Detector : Peak Project : 7D2018-03 Mode : 11</p>	<p>Site : 03CH13-HY Condition : AVG_54 3m HORN_91200_1241 VERTICAL RBW:1000.000KHz VBW:3.000KHz SWT:Auto Detector : Peak Project : 7D2018-03 Mode : 11</p>



2.4GHz 2400~2483.5MHz
WIFI 802.11g (Band Edge @ 3m)

WIFI	2.4GHz 2400~2483.5MHz Band Edge @ 3m	
ANT	802.11g CH01 2412MHz	
1	Horizontal	Fundamental
Peak	<p>Site : 03CH13-HY Condition : PEAK_BE_74 3m HORN_91200_1241 HORIZONTAL RBW:1000.000KHz VBW:3000.000KHz SWT:Auto Detector : Peak Project : 7D2018-03 Mode : 12</p>	<p>Site : 03CH13-HY Condition : PEAK_74 3m HORN_91200_1241 HORIZONTAL RBW:1000.000KHz VBW:3000.000KHz SWT:Auto Detector : Peak Project : 7D2018-03 Mode : 12</p>
Avg.	<p>Site : 03CH13-HY Condition : AVG_BE_54 3m HORN_91200_1241 HORIZONTAL RBW:1000.000KHz VBW:1000KHz SWT:Auto Detector : Peak Project : 7D2018-03 Mode : 12</p>	<p>Site : 03CH13-HY Condition : AVG_54 3m HORN_91200_1241 HORIZONTAL RBW:1000.000KHz VBW:1000KHz SWT:Auto Detector : Peak Project : 7D2018-03 Mode : 12</p>

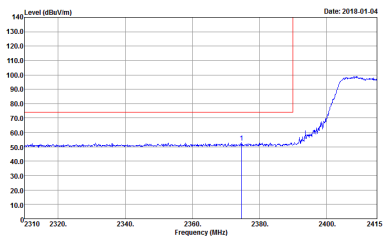
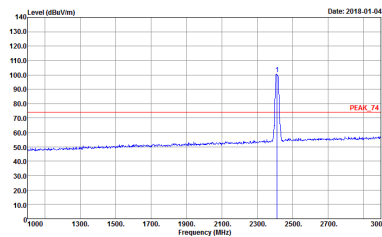
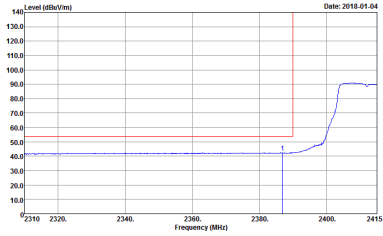
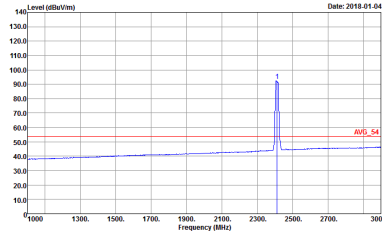

WIFI	2.4GHz 2400~2483.5MHz Band Edge @ 3m	
ANT	802.11g CH01 2412MHz	
1	Vertical	Fundamental
Peak	 <p>Site : 03CH13-HY Condition : PEAK_BE_74 3m HORN_91200_1241 VERTICAL : RBW:1000.000KHz VBW:3000.000KHz SWT:Auto Detector : Peak Project : 7D2018-03 Mode : 12</p>	 <p>Site : 03CH13-HY Condition : PEAK_74 3m HORN_91200_1241 VERTICAL : RBW:1000.000KHz VBW:3000.000KHz SWT:Auto Detector : Peak Project : 7D2018-03 Mode : 12</p>
Avg.	 <p>Site : 03CH13-HY Condition : AVG_BE_54 3m HORN_91200_1241 VERTICAL : RBW:1000.000KHz VBW:1000KHz SWT:Auto Detector : Peak Project : 7D2018-03 Mode : 12</p>	 <p>Site : 03CH13-HY Condition : AVG_54 3m HORN_91200_1241 VERTICAL : RBW:1000.000KHz VBW:1000KHz SWT:Auto Detector : Peak Project : 7D2018-03 Mode : 12</p>

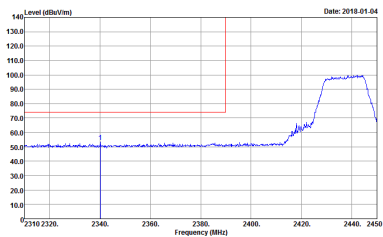
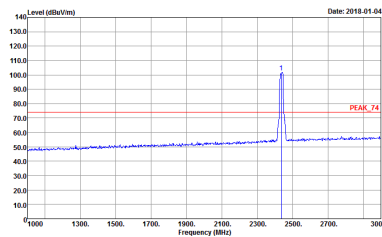
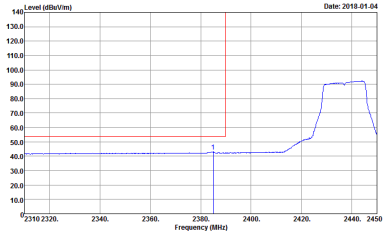
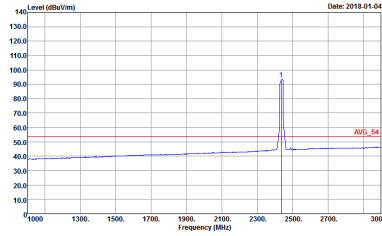

WIFI	2.4GHz 2400~2483.5MHz Band Edge @ 3m	
ANT	802.11g CH06 2437MHz - L	
1	Horizontal	Fundamental
Peak	 <p>Site : 03CH13-HY Condition : PEAK_BE_74 3m HORN_91200_1241 HORIZONTAL Detector : Peak Project : 7D2018-03 Mode : 13</p>	 <p>Site : 03CH13-HY Condition : PEAK_74 3m HORN_91200_1241 HORIZONTAL Detector : Peak Project : 7D2018-03 Mode : 13</p>
Avg.	 <p>Site : 03CH13-HY Condition : AVG_BE_54 3m HORN_91200_1241 HORIZONTAL Detector : Peak Project : 7D2018-03 Mode : 13</p>	 <p>Site : 03CH13-HY Condition : AVG_54 3m HORN_91200_1241 HORIZONTAL Detector : Peak Project : 7D2018-03 Mode : 13</p>

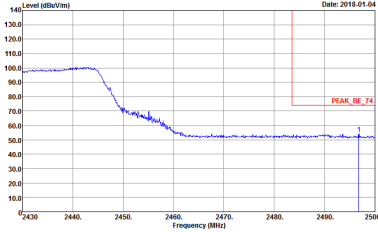
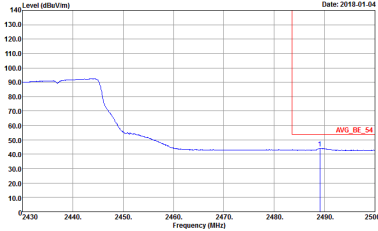

WIFI	2.4GHz 2400~2483.5MHz Band Edge @ 3m	
ANT	802.11g CH06 2437MHz - R	
1	Horizontal	Fundamental
Peak	 <p>Site : 03CH13-HY Condition : PEAK_BE_74 3m HORN_91200_1241 HORIZONTAL Detector : Peak Project : 7D2018-03 Mode : 13</p>	Left blank
Avg.	 <p>Site : 03CH13-HY Condition : AVG_BE_54 3m HORN_91200_1241 HORIZONTAL Detector : Peak Project : 7D2018-03 Mode : 13</p>	Left blank

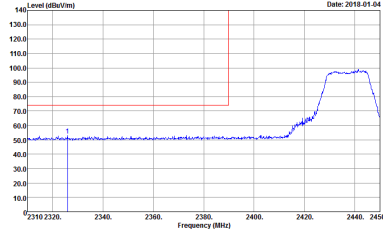
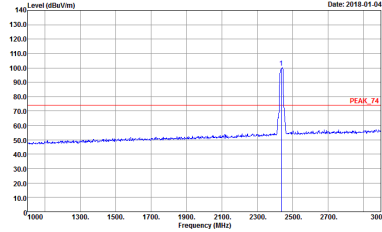
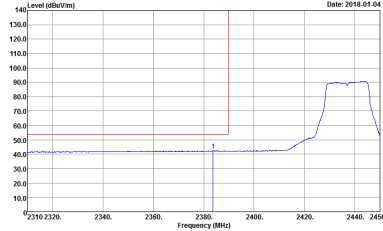
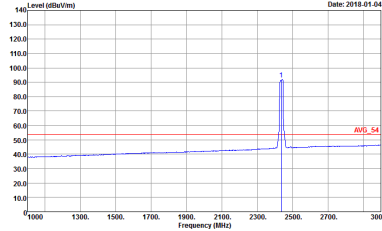

WIFI	2.4GHz 2400~2483.5MHz Band Edge @ 3m	
ANT	802.11g CH06 2437MHz - L	
1	Vertical	Fundamental
Peak	 <p>Site : 03CH13-HY Condition : PEAK_BE_74 3m HORN_91200_1241 VERTICAL : RBW:1000.000KHz VBW:3000.000KHz SWT:Auto Detector : Peak Project : 7D2018-03 Mode : 13</p>	 <p>Site : 03CH13-HY Condition : PEAK_74 3m HORN_91200_1241 VERTICAL : RBW:1000.000KHz VBW:3000.000KHz SWT:Auto Detector : Peak Project : 7D2018-03 Mode : 13</p>
Avg.	 <p>Site : 03CH13-HY Condition : AVG_BE_54 3m HORN_91200_1241 VERTICAL : RBW:1000.000KHz VBW:1000KHz SWT:Auto Detector : Peak Project : 7D2018-03 Mode : 13</p>	 <p>Site : 03CH13-HY Condition : AVG_54 3m HORN_91200_1241 VERTICAL : RBW:1000.000KHz VBW:1000KHz SWT:Auto Detector : Peak Project : 7D2018-03 Mode : 13</p>

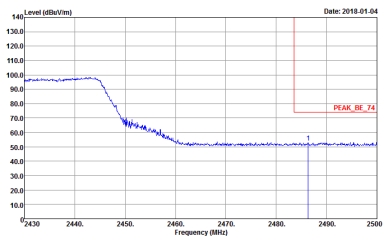
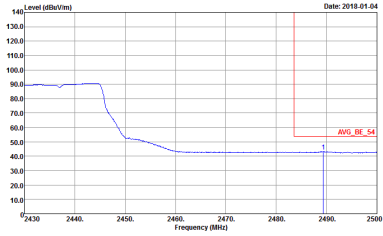

WIFI	2.4GHz 2400~2483.5MHz Band Edge @ 3m	
ANT	802.11g CH06 2437MHz - R	
1	Vertical	Fundamental
<p>Peak</p>	 <p>Site : 03CH13-HY Condition : PEAK_BE_74 3m HORN_91200_1241 VERTICAL Detector : Peak Project : 7D2018-03 Mode : 13</p>	<p>Left blank</p>
<p>Avg.</p>	 <p>Site : 03CH13-HY Condition : AVG_BE_54 3m HORN_91200_1241 VERTICAL Detector : Peak Project : 7D2018-03 Mode : 13</p>	<p>Left blank</p>

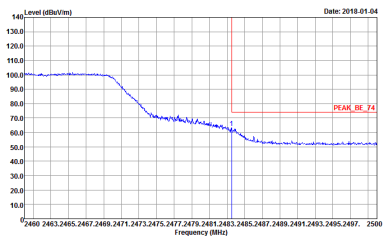
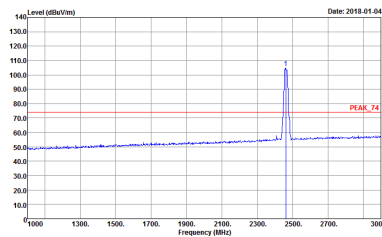
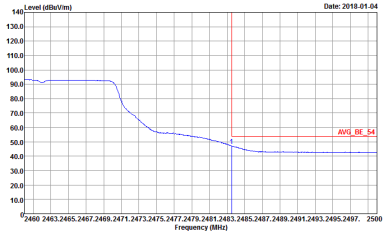
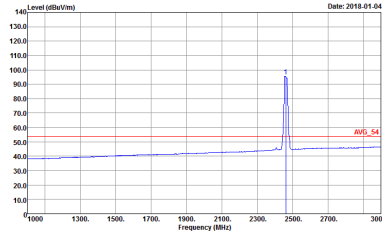

WIFI	2.4GHz 2400~2483.5MHz Band Edge @ 3m	
ANT	802.11g CH11 2462MHz	
1	Horizontal	Fundamental
Peak	 <p>Site : 03CH13-HY Condition : PEAK_BE_74 3m HORN_91200_1241 HORIZONTAL Detector : Peak Project : 7D2018-03 Mode : 14</p>	 <p>Site : 03CH13-HY Condition : PEAK_74 3m HORN_91200_1241 HORIZONTAL Detector : Peak Project : 7D2018-03 Mode : 14</p>
Avg.	 <p>Site : 03CH13-HY Condition : AVG_BE_54 3m HORN_91200_1241 HORIZONTAL Detector : Peak Project : 7D2018-03 Mode : 14</p>	 <p>Site : 03CH13-HY Condition : AVG_54 3m HORN_91200_1241 HORIZONTAL Detector : Peak Project : 7D2018-03 Mode : 14</p>



WIFI	2.4GHz 2400~2483.5MHz Band Edge @ 3m	
ANT	802.11g CH11 2462MHz	
1	Vertical	Fundamental
Peak	<p>Site : 03CH13-HY Condition : PEAK_BE_74 3m HORN_91200_1241 VERTICAL Detector : Peak Project : 7D2018-03 Mode : 14</p>	<p>Site : 03CH13-HY Condition : PEAK_74 3m HORN_91200_1241 VERTICAL Detector : Peak Project : 7D2018-03 Mode : 14</p>
Avg.	<p>Site : 03CH13-HY Condition : AVG_BE_54 3m HORN_91200_1241 VERTICAL Detector : Peak Project : 7D2018-03 Mode : 14</p>	<p>Site : 03CH13-HY Condition : AVG_54 3m HORN_91200_1241 VERTICAL Detector : Peak Project : 7D2018-03 Mode : 14</p>



2.4GHz 2400~2483.5MHz

WIFI 802.11n HT20 (Band Edge @ 3m)

WIFI	2.4GHz 2400~2483.5MHz Band Edge @ 3m	
ANT	802.11n HT20 CH01 2412MHz	
1	Horizontal	Fundamental
Peak	<p>Site : 03CH13-HY Condition : PEAK_BE_74 3m HORN_91200_1241 HORIZONTAL RBW:1000.000KHz VBW:3000.000KHz SWT:Auto Detector : Peak Project : 7D2018-03 Mode : 15</p>	<p>Site : 03CH13-HY Condition : PEAK_74 3m HORN_91200_1241 HORIZONTAL RBW:1000.000KHz VBW:3000.000KHz SWT:Auto Detector : Peak Project : 7D2018-03 Mode : 15</p>
Avg.	<p>Site : 03CH13-HY Condition : AVG_BE_54 3m HORN_91200_1241 HORIZONTAL RBW:1000.000KHz VBW:1.000KHz SWT:Auto Detector : Peak Project : 7D2018-03 Mode : 15</p>	<p>Site : 03CH13-HY Condition : AVG_54 3m HORN_91200_1241 HORIZONTAL RBW:1000.000KHz VBW:1.000KHz SWT:Auto Detector : Peak Project : 7D2018-03 Mode : 15</p>

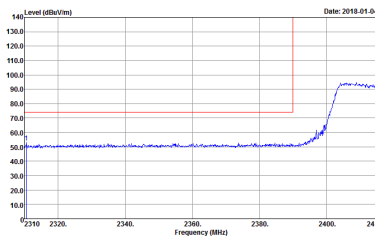
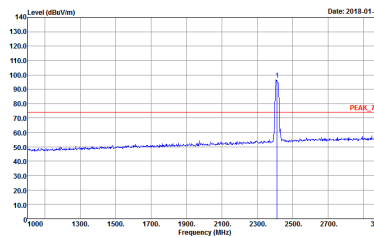
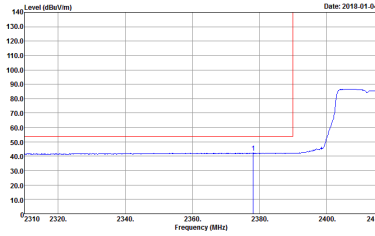
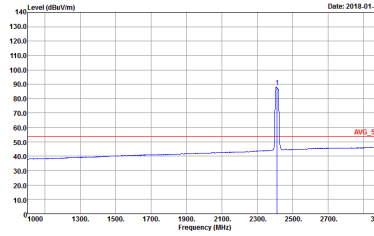

WIFI	2.4GHz 2400~2483.5MHz Band Edge @ 3m	
ANT	802.11n HT20 CH01 2412MHz	
1	Vertical	Fundamental
Peak	 <p>Site : 03CH13-HY Condition : PEAK_BE_74 3m HORN_91200_1241 VERTICAL : RBW:1000.000KHz VBW:3000.000KHz SWT:Auto Detector : Peak Project : 7D2018-03 Mode : 15</p>	 <p>Site : 03CH13-HY Condition : PEAK_74 3m HORN_91200_1241 VERTICAL : RBW:1000.000KHz VBW:3000.000KHz SWT:Auto Detector : Peak Project : 7D2018-03 Mode : 15</p>
Avg.	 <p>Site : 03CH13-HY Condition : AVG_BE_54 3m HORN_91200_1241 VERTICAL : RBW:1000.000KHz VBW:1000KHz SWT:Auto Detector : Peak Project : 7D2018-03 Mode : 15</p>	 <p>Site : 03CH13-HY Condition : AVG_54 3m HORN_91200_1241 VERTICAL : RBW:1000.000KHz VBW:1000KHz SWT:Auto Detector : Peak Project : 7D2018-03 Mode : 15</p>

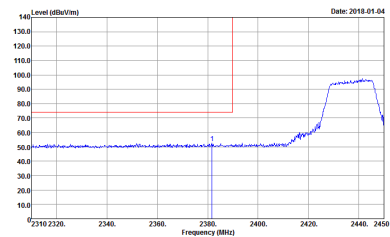
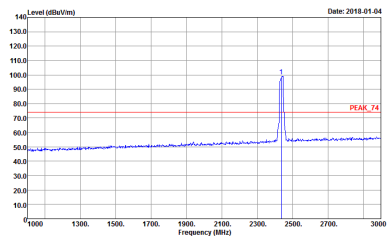
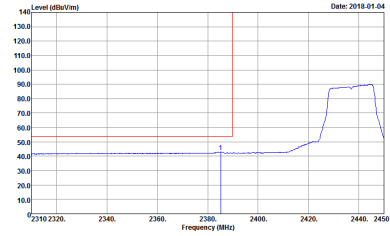
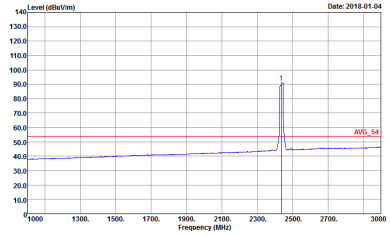

WIFI	2.4GHz 2400~2483.5MHz Band Edge @ 3m	
ANT	802.11n HT20 CH06 2437MHz - L	
1	Horizontal	Fundamental
Peak	 <p>Date: 2018-01-04</p> <p>Site : 03CH13-HY Condition : PEAK_BE_74 3m HORN_91200_1241 HORIZONTAL RBW:1000.000KHz VBW:3000.000KHz SWT:Auto Detector : Peak Project : 7D2018-03 Mode : 16</p>	 <p>Date: 2018-01-04</p> <p>Site : 03CH13-HY Condition : PEAK_74 3m HORN_91200_1241 HORIZONTAL RBW:1000.000KHz VBW:3000.000KHz SWT:Auto Detector : Peak Project : 7D2018-03 Mode : 16</p>
Avg.	 <p>Date: 2018-01-04</p> <p>Site : 03CH13-HY Condition : AVG_BE_54 3m HORN_91200_1241 HORIZONTAL RBW:1000.000KHz VBW:1000KHz SWT:Auto Detector : Peak Project : 7D2018-03 Mode : 16</p>	 <p>Date: 2018-01-04</p> <p>Site : 03CH13-HY Condition : AVG_54 3m HORN_91200_1241 HORIZONTAL RBW:1000.000KHz VBW:1000KHz SWT:Auto Detector : Peak Project : 7D2018-03 Mode : 16</p>

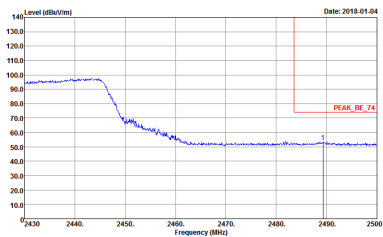
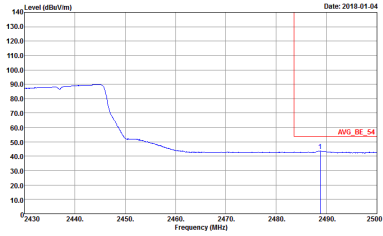

WIFI	2.4GHz 2400~2483.5MHz Band Edge @ 3m	
ANT	802.11n HT20 CH06 2437MHz - R	
1	Horizontal	Fundamental
Peak	 <p>Site : 03CH13-HY Condition : PEAK_BE_74 3m HORN_91200_1241 HORIZONTAL Detector : Peak Project : 7D2018-03 Mode : 16</p>	Left blank
Avg.	 <p>Site : 03CH13-HY Condition : AVG_BE_54 3m HORN_91200_1241 HORIZONTAL Detector : Peak Project : 7D2018-03 Mode : 16</p>	Left blank



WIFI	2.4GHz 2400~2483.5MHz Band Edge @ 3m	
ANT	802.11n HT20 CH06 2437MHz - L	
1	Vertical	Fundamental
Peak	<p>Site : 03CH13-HY Condition : PEAK_BE_74 3m HORN_91200_1241 VERTICAL RBW:1000.000KHz VBW:3000.000KHz SWT:Auto Detector : Peak Project : 7D2018-03 Mode : 16</p>	<p>Site : 03CH13-HY Condition : PEAK_74 3m HORN_91200_1241 VERTICAL RBW:1000.000KHz VBW:3000.000KHz SWT:Auto Detector : Peak Project : 7D2018-03 Mode : 16</p>
Avg.	<p>Site : 03CH13-HY Condition : AVG_BE_54 3m HORN_91200_1241 VERTICAL RBW:1000.000KHz VBW:1000KHz SWT:Auto Detector : Peak Project : 7D2018-03 Mode : 16</p>	<p>Site : 03CH13-HY Condition : AVG_54 3m HORN_91200_1241 VERTICAL RBW:1000.000KHz VBW:1000KHz SWT:Auto Detector : Peak Project : 7D2018-03 Mode : 16</p>

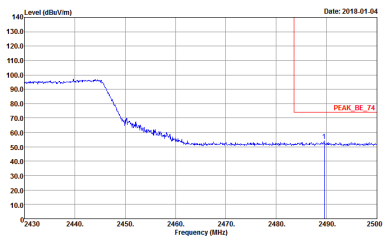
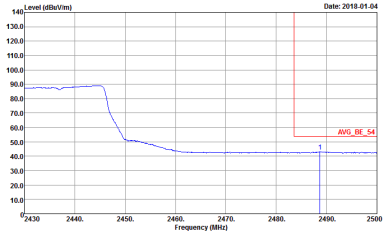

WIFI	2.4GHz 2400~2483.5MHz Band Edge @ 3m	
ANT	802.11n HT20 CH06 2437MHz - R	
1	Vertical	Fundamental
Peak	 <p>Site : 03CH13-HY Condition : PEAK_BE_74 3m HORN_91200_1241 VERTICAL Detector : Peak Project : 7D2018-03 Mode : 16</p>	Left blank
Avg.	 <p>Site : 03CH13-HY Condition : AVG_BE_54 3m HORN_91200_1241 VERTICAL Detector : Peak Project : 7D2018-03 Mode : 16</p>	Left blank

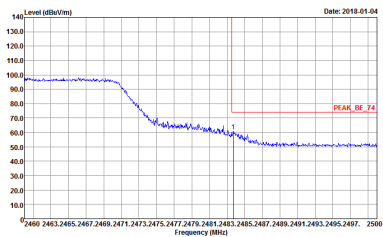
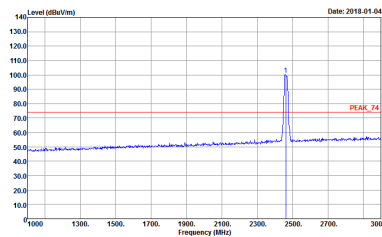
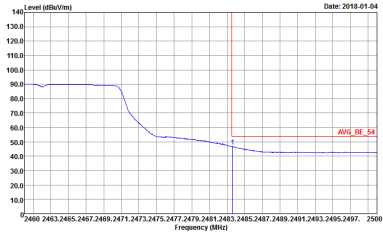
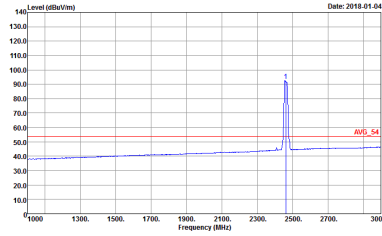

WIFI	2.4GHz 2400~2483.5MHz Band Edge @ 3m	
ANT	802.11n HT20 CH11 2462MHz	
1	Horizontal	Fundamental
Peak	 <p>Site : 03CH13-HY Condition : PEAK_BE_74 3m HORN_91200_1241 HORIZONTAL RBW:1000.000KHz VBW:3000.000KHz SWT:Auto Detector : Peak Project : 7D2018-03 Mode : 17</p>	 <p>Site : 03CH13-HY Condition : PEAK_74 3m HORN_91200_1241 HORIZONTAL RBW:1000.000KHz VBW:3000.000KHz SWT:Auto Detector : Peak Project : 7D2018-03 Mode : 17</p>
Avg.	 <p>Site : 03CH13-HY Condition : AVG_BE_54 3m HORN_91200_1241 HORIZONTAL RBW:1000.000KHz VBW:1000KHz SWT:Auto Detector : Peak Project : 7D2018-03 Mode : 17</p>	 <p>Site : 03CH13-HY Condition : AVG_54 3m HORN_91200_1241 HORIZONTAL RBW:1000.000KHz VBW:1000KHz SWT:Auto Detector : Peak Project : 7D2018-03 Mode : 17</p>

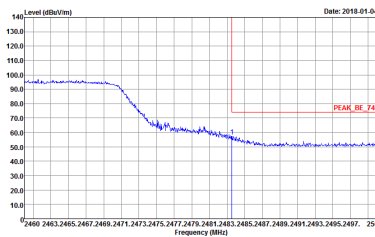
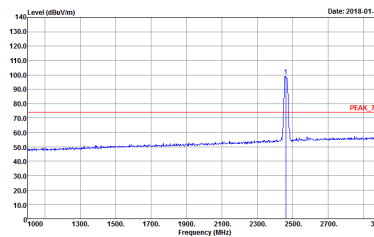
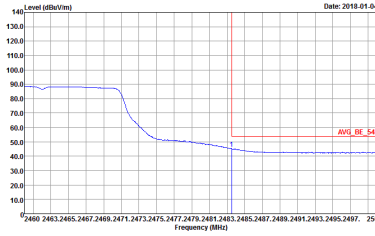
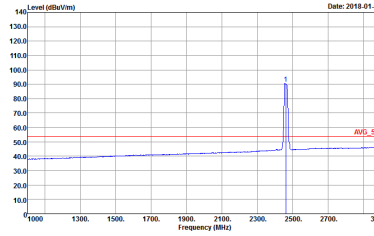

WIFI	2.4GHz 2400~2483.5MHz Fundamental @ 3m	
ANT	802.11n HT20 CH11 2462MHz	
1	Vertical	Fundamental
Peak	 <p>Date: 2018-01-04</p> <p>Site : 03CH13-HY Condition : PEAK_BE_74 3m HORN_91200_1241 VERTICAL Detector : Peak Project : 7D2018-03 Mode : 17</p>	 <p>Date: 2018-01-04</p> <p>Site : 03CH13-HY Condition : PEAK_74 3m HORN_91200_1241 VERTICAL Detector : Peak Project : 7D2018-03 Mode : 17</p>
Avg.	 <p>Date: 2018-01-04</p> <p>Site : 03CH13-HY Condition : AVG_BE_54 3m HORN_91200_1241 VERTICAL Detector : Peak Project : 7D2018-03 Mode : 17</p>	 <p>Date: 2018-01-04</p> <p>Site : 03CH13-HY Condition : AVG_54 3m HORN_91200_1241 VERTICAL Detector : Peak Project : 7D2018-03 Mode : 17</p>



2.4GHz 2400~2483.5MHz
WIFI 802.11b (Harmonic @ 3m)

WIFI	2.4GHz 2400~2483.5MHz Harmonic @ 3m	
ANT	802.11b CH01 2412MHz	
1	Horizontal	Vertical
<p>Peak</p> <p>Avg.</p>	<p>Site : 03CH13-HY Condition : PEAK_74 3m SHF_HORN_576 HORIZONTAL Detector : Peak Project : 7D2018-03 Mode : 9</p>	<p>Site : 03CH13-HY Condition : PEAK_74 3m SHF_HORN_576 VERTICAL Detector : Peak Project : 7D2018-03 Mode : 9</p>

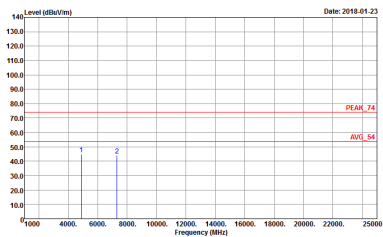
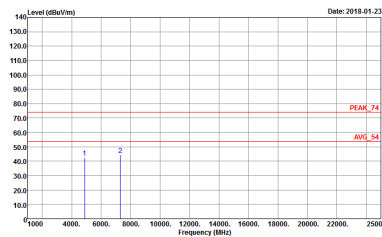

WIFI	2.4GHz 2400~2483.5MHz Harmonic @ 3m	
ANT	802.11b CH06 2437MHz	
1	Horizontal	Vertical
<p>Peak</p> <p>Avg.</p>	 <p>Site : 03CH13-11Y Condition : PEAK_74 3m SHF_HORN_576 HORIZONTAL Detector : Peak Project : 7D2018-03 Mode : 10</p>	 <p>Site : 03CH13-11Y Condition : PEAK_74 3m SHF_HORN_576 VERTICAL Detector : Peak Project : 7D2018-03 Mode : 10</p>

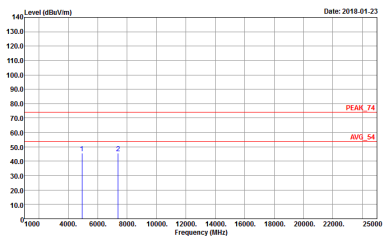
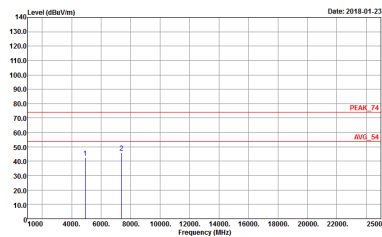

WIFI	2.4GHz 2400~2483.5MHz Harmonic @ 3m	
ANT	802.11b CH11 2462MHz	
1	Horizontal	Vertical
<p>Peak</p> <p>Avg.</p>	 <p>Site : 03CH13-11Y Condition : PEAK_74 3m SHF_HORN_576 HORIZONTAL Detector : Peak Project : 7D2018-03 Mode : 11</p>	 <p>Site : 03CH13-11Y Condition : PEAK_74 3m SHF_HORN_576 VERTICAL Detector : Peak Project : 7D2018-03 Mode : 11</p>



2.4GHz 2400~2483.5MHz
WIFI 802.11g (Harmonic @ 3m)

WIFI	2.4GHz 2400~2483.5MHz Harmonic @ 3m	
ANT	802.11g CH01 2412MHz	
1	Horizontal	Vertical
<p>Peak</p> <p>Avg.</p>	<p>Site : 03CH13-HY Condition : PEAK_74 3m SHF_HORN_576 HORIZONTAL Detector : Peak Project : 7D2018-03 Mode : 12</p>	<p>Site : 03CH13-HY Condition : PEAK_74 3m SHF_HORN_576 VERTICAL Detector : Peak Project : 7D2018-03 Mode : 12</p>

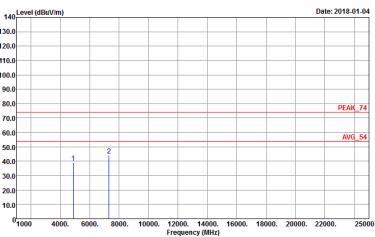
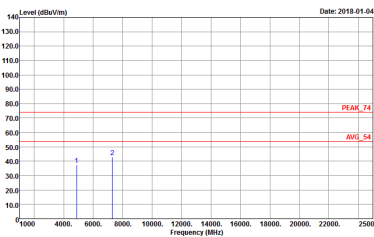

WIFI	2.4GHz 2400~2483.5MHz Harmonic @ 3m	
ANT	802.11g CH06 2437MHz	
1	Horizontal	Vertical
<p>Peak</p> <p>Avg.</p>	 <p>Site : 03CHE3-11Y Condition : PEAK_74 3m SHF_HORN_576 HORIZONTAL Detector : Peak Project : 7D2018-03 Mode : 13</p>	 <p>Site : 03CHE3-11Y Condition : PEAK_74 3m SHF_HORN_576 VERTICAL Detector : Peak Project : 7D2018-03 Mode : 13</p>

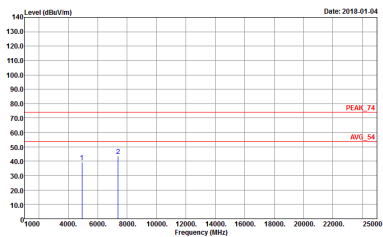
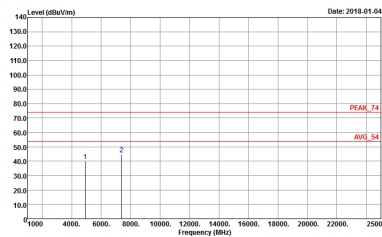

WIFI	2.4GHz 2400~2483.5MHz Harmonic @ 3m	
ANT	802.11g CH11 2462MHz	
1	Horizontal	Vertical
Peak Avg.	 <p>Site : 03CH13-11Y Condition : PEAK_74 3m SHF_HORN_576 HORIZONTAL Detector : Peak Project : 7D2018-03 Mode : 14</p>	 <p>Site : 03CH13-11Y Condition : PEAK_74 3m SHF_HORN_576 VERTICAL Detector : Peak Project : 7D2018-03 Mode : 14</p>



2.4GHz 2400~2483.5MHz
WIFI 802.11n HT20 (Harmonic @ 3m)

Table with 2 columns: Horizontal and Vertical. Each column contains a graph of Level (dBuV/m) vs Frequency (MHz) and a metadata block with fields like Site, Condition, Detector, Project, and Mode.



WIFI	2.4GHz 2400~2483.5MHz Harmonic @ 3m	
ANT	802.11n HT20 CH06 2437MHz	
1	Horizontal	Vertical
Peak Avg.	<p>Site : 03CHE3-11Y Condition : PEAK_74 3m SHF_HORN_576 HORIZONTAL Detector : Peak Project : 7D2018-03 Mode : 16</p>	<p>Site : 03CHE3-11Y Condition : PEAK_74 3m SHF_HORN_576 VERTICAL Detector : Peak Project : 7D2018-03 Mode : 16</p>



WIFI	2.4GHz 2400~2483.5MHz Harmonic @ 3m	
ANT	802.11n HT20 CH11 2462MHz	
1	Horizontal	Vertical
<p>Peak</p> <p>Avg.</p>	<p>Site : 03CH13-11Y Condition : PEAK_74 3m SHF_HORN_576 HORIZONTAL Detector : Peak Project : 7D2018-03 Mode : 17</p>	<p>Site : 03CH13-11Y Condition : PEAK_74 3m SHF_HORN_576 VERTICAL Detector : Peak Project : 7D2018-03 Mode : 17</p>



Emission below 1GHz
2.4GHz WIFI 802.11b (LF)

WIFI	2.4GHz 2400~2483.5MHz	
ANT	802.11b LF	
1	Horizontal	Vertical
QP / Peak	<p>Site : 03CH13-HY Condition : QP 3m BTL06_40103 HORIZONTAL Detector : Peak Project : 7D2018-03 Mode : 18</p>	<p>Site : 03CH13-HY Condition : QP 3m BTL06_40103 VERTICAL Detector : Peak Project : 7D2018-03 Mode : 18</p>

Appendix E. Duty Cycle Plots

Band	Duty Cycle(%)	T(us)	1/T(kHz)	VBW Setting	Duty Factor(dB)
802.11b	97.62	8200	0.12	300Hz	0.10
802.11g	86.74	1360	0.74	1kHz	0.62
2.4GHz 802.11n HT20	86.41	1272	0.79	1kHz	0.63

802.11b

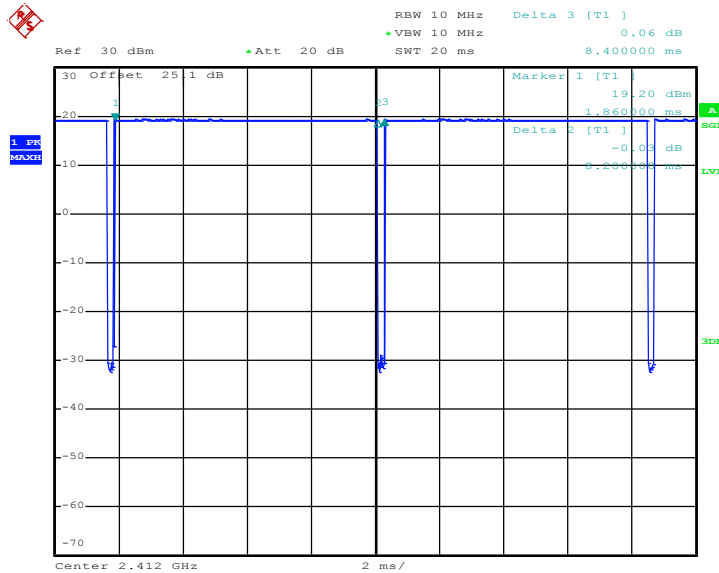

Date: 4.JAN.2018 13:55:21



802.11g

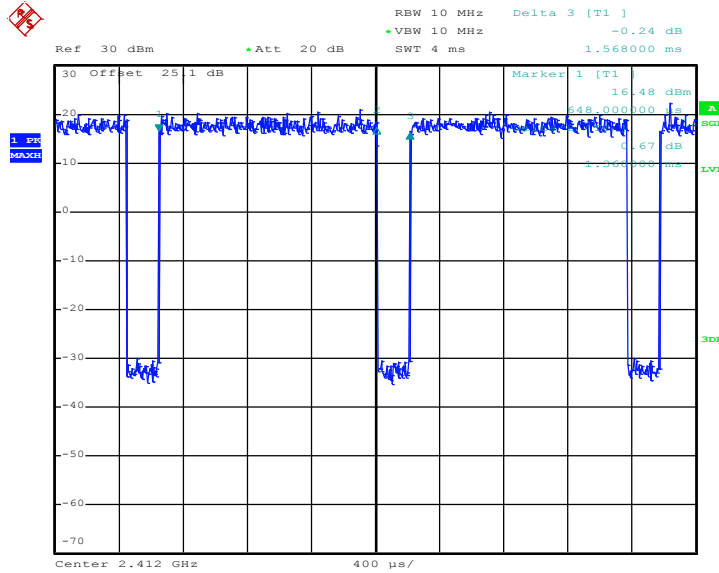

Date: 4.JAN.2018 14:10:52

802.11n HT20

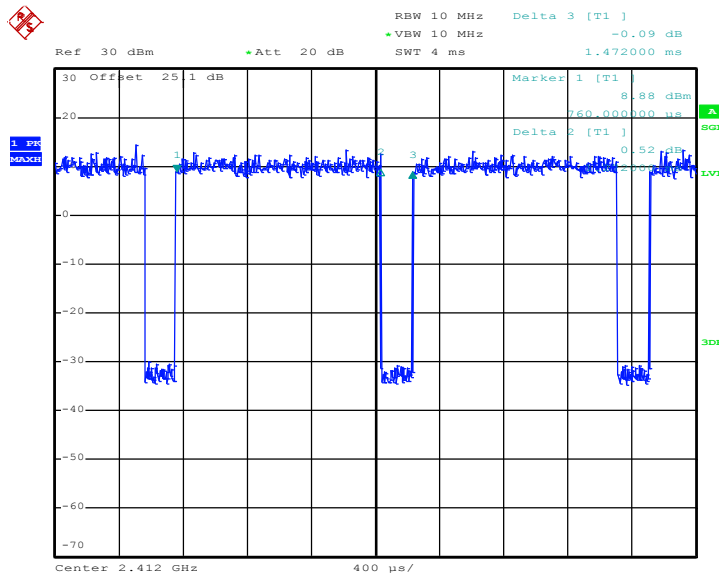

Date: 4.JAN.2018 14:22:05