



# FCC RF Test Report

**APPLICANT** : Motorola Mobility LLC  
**EQUIPMENT** : Mobile Cellular Phone  
**BRAND NAME** : Motorola  
**MODEL NAME** : XT1921-5, XT1921-3  
**FCC ID** : IHDT56XC2  
**STANDARD** : FCC Part 15 Subpart C §15.247  
**CLASSIFICATION** : (DSS) Spread Spectrum Transmitter

The product was received on Dec. 20, 2017 and testing was completed on Jan. 08, 2018. We, SPORTON INTERNATIONAL INC., would like to declare that the tested sample has been evaluated in accordance with the test procedures and has been in compliance with the applicable technical standards.

The test results in this report apply exclusively to the tested model / sample. Without written approval of SPORTON INTERNATIONAL INC., the test report shall not be reproduced except in full.

Reviewed by: Joseph Lin / Supervisor

Approved by: Jones Tsai / Manager



## SPORTON INTERNATIONAL INC.

No. 52, Hwa Ya 1<sup>st</sup> Rd., Hwa Ya Technology Park, Kwei-Shan District, Tao Yuan City, Taiwan, R.O.C.

SPORTON INTERNATIONAL INC.

TEL : 886-3-327-3456

FAX : 886-3-328-4978

FCC ID : IHDT56XC2

Page Number : 1 of 59

Report Issued Date : Feb. 13, 2018

Report Version : Rev. 01

Report Template No.: BU5-FR15CBT Version 2.0



# TABLE OF CONTENTS

**REVISION HISTORY..... 3**

**SUMMARY OF TEST RESULT ..... 4**

**1 GENERAL DESCRIPTION..... 5**

    1.1 Applicant ..... 5

    1.2 Manufacturer ..... 5

    1.3 Product Feature of Equipment Under Test..... 5

    1.4 Product Specification of Equipment Under Test..... 6

    1.5 Modification of EUT ..... 6

    1.6 Testing Location ..... 6

    1.7 Applicable Standards ..... 7

**2 TEST CONFIGURATION OF EQUIPMENT UNDER TEST..... 8**

    2.1 Carrier Frequency Channel ..... 8

    2.2 Test Mode ..... 9

    2.3 Connection Diagram of Test System ..... 10

    2.4 Support Unit used in test configuration and system ..... 11

    2.5 EUT Operation Test Setup ..... 11

    2.6 Measurement Results Explanation Example ..... 11

**3 TEST RESULT ..... 12**

    3.1 Number of Channel Measurement ..... 12

    3.2 Hopping Channel Separation Measurement ..... 14

    3.3 Dwell Time Measurement ..... 20

    3.4 20dB and 99% Bandwidth Measurement ..... 22

    3.5 Output Power Measurement..... 33

    3.6 Conducted Band Edges Measurement..... 34

    3.7 Conducted Spurious Emission Measurement ..... 41

    3.8 Radiated Band Edges and Spurious Emission Measurement ..... 51

    3.9 AC Conducted Emission Measurement..... 55

    3.10 Antenna Requirements ..... 57

**4 LIST OF MEASURING EQUIPMENT ..... 58**

**5 UNCERTAINTY OF EVALUATION..... 59**

**APPENDIX A. CONDUCTED TEST RESULTS**

**APPENDIX B. AC CONDUCTED EMISSION TEST RESULT**

**APPENDIX C. RADIATED SPURIOUS EMISSION**

**APPENDIX D. RADIATED SPURIOUS EMISSION PLOTS**

**APPENDIX E. DUTY CYCLE PLOTS**



### REVISION HISTORY

REPORT NO.	VERSION	DESCRIPTION	ISSUED DATE
FR7D2018A	Rev. 01	Initial issue of report	Feb. 13, 2018



### SUMMARY OF TEST RESULT

Report Section	FCC Rule	Description	Limit	Result	Remark
3.1	15.247(a)(1)	Number of Channels	≥ 15Chs	Pass	-
3.2	15.247(a)(1)	Hopping Channel Separation	≥ 2/3 of 20dB BW	Pass	-
3.3	15.247(a)(1)	Dwell Time of Each Channel	≤ 0.4sec in 31.6sec period	Pass	-
3.4	15.247(a)(1)	20dB Bandwidth	NA	Pass	-
3.4	-	99% Bandwidth	-	Pass	-
3.5	15.247(b)(1)	Peak Output Power	≤ 125 mW	Pass	-
3.6	15.247(d)	Conducted Band Edges	≤ 20dBc	Pass	-
3.7	15.247(d)	Conducted Spurious Emission	≤ 20dBc	Pass	-
3.8	15.247(d)	Radiated Band Edges and Radiated Spurious Emission	15.209(a) & 15.247(d)	Pass	Under limit 3.43 dB at 31.350 MHz
3.9	15.207	AC Conducted Emission	15.207(a)	Pass	Under limit 17.00 dB at 0.150 MHz
3.10	15.203 & 15.247(b)	Antenna Requirement	N/A	Pass	-



# 1 General Description

## 1.1 Applicant

**Motorola Mobility LLC**  
222 W. Merchandise Mart Plaza, Chicago IL 60654, USA

## 1.2 Manufacturer

**Motorola Mobility LLC**  
222 W. Merchandise Mart Plaza, Chicago IL 60654, USA

## 1.3 Product Feature of Equipment Under Test

Product Feature	
<b>Equipment</b>	Mobile Cellular Phone
<b>Brand Name</b>	Motorola
<b>Model Name</b>	XT1921-5, XT1921-3
<b>FCC ID</b>	IHDT56XC2
<b>IMEI Code</b>	990005440074244 (for Radiation) 990005440016179 (for Conduction)
<b>EUT supports Radios application</b>	CDMA/EV-DO/GSM/EGPRS/WCDMA/HSPA/LTE/FM/GNSS WLAN 11b/g/n HT20 WLAN 11a/n HT20/HT40 Bluetooth BR/EDR/LE
<b>HW Version</b>	DVT1B
<b>EUT Stage</b>	Identical Prototype

**Remark:** The above EUT's information was declared by manufacturer. Please refer to the specifications or user's manual for more detailed description.

Accessory List	
<b>AC Adapter 1</b>	Brand Name : Motorola
	Model Name : C-P35
<b>AC Adapter 2</b>	Brand Name : Motorola
	Model Name : SSW-2919UMTJ C-P35 SPN5945A
<b>AC Adapter 3</b>	Brand Name : Motorola
	Model Name : C-P56
<b>AC Adapter 4</b>	Brand Name : Motorola
	Model Name : C-P56
<b>Battery</b>	Brand Name : Motorola
	Model Name : GK40
<b>USB Cable</b>	Brand Name : Saibao
	Model Name : SWT-A083A



### 1.4 Product Specification of Equipment Under Test

Standards-related Product Specification	
Tx/Rx Frequency Range	2402 MHz ~ 2480 MHz
Number of Channels	79
Carrier Frequency of Each Channel	2402+n*1 MHz; n=0~78
Maximum Output Power to Antenna	Bluetooth BR(1Mbps) : 11.88 dBm (0.0154 W) Bluetooth EDR (2Mbps) : 11.93 dBm (0.0156 W) Bluetooth EDR (3Mbps) : 12.22 dBm (0.0167 W)
Antenna Type / Gain	PIFA Antenna with gain -3.2 dBi
Type of Modulation	Bluetooth BR (1Mbps) : GFSK Bluetooth EDR (2Mbps) : $\pi/4$ -DQPSK Bluetooth EDR (3Mbps) : 8-DPSK

### 1.5 Modification of EUT

No modifications are made to the EUT during all test items.

### 1.6 Testing Location

Sporton Lab is accredited to ISO 17025 by Taiwan Accreditation Foundation (TAF code : 1190) and the FCC designation No. TW1190 and TW0007 under the FCC 2.948(e) by Mutual Recognition Agreement (MRA) in FCC Test.

Test Site	SPORTON INTERNATIONAL INC.	
Test Site Location	No. 52, Hwa Ya 1 <sup>st</sup> Rd., Hwa Ya Technology Park, Kwei-Shan District, Tao Yuan City, Taiwan, R.O.C. TEL: +886-3-327-3456 FAX: +886-3-328-4978	
Test Site No.	<b>Sporton Site No.</b>	
	TH05-HY	CO05-HY

**Note:** The test site complies with ANSI C63.4 2014 requirement.

Test Site	SPORTON INTERNATIONAL INC.	
Test Site Location	No.58, Aly. 75, Ln. 564, Wenhua 3rd Rd., Kwei-Shan District, Tao Yuan City, Taiwan R.O.C. TEL: +886-3-327-0868 FAX: +886-3-327-0855	
Test Site No.	<b>Sporton Site No. :</b>	
	03CH13-HY	

**Note:** The test site complies with ANSI C63.4 2014 requirement.



## 1.7 Applicable Standards

According to the specifications of the manufacturer, the EUT must comply with the requirements of the following standards:

- ♦ FCC Part 15 Subpart C §15.247
- ♦ ANSI C63.10-2013

### **Remark:**

1. All test items were verified and recorded according to the standards and without any deviation during the test.
2. This EUT has also been tested and complied with the requirements of FCC Part 15, Subpart B, recorded in a separate test report.



## 2 Test Configuration of Equipment Under Test

### 2.1 Carrier Frequency Channel

Frequency Band	Channel	Freq. (MHz)	Channel	Freq. (MHz)	Channel	Freq. (MHz)
2400-2483.5 MHz	0	2402	27	2429	54	2456
	1	2403	28	2430	55	2457
	2	2404	29	2431	56	2458
	3	2405	30	2432	57	2459
	4	2406	31	2433	58	2460
	5	2407	32	2434	59	2461
	6	2408	33	2435	60	2462
	7	2409	34	2436	61	2463
	8	2410	35	2437	62	2464
	9	2411	36	2438	63	2465
	10	2412	37	2439	64	2466
	11	2413	38	2440	65	2467
	12	2414	39	2441	66	2468
	13	2415	40	2442	67	2469
	14	2416	41	2443	68	2470
	15	2417	42	2444	69	2471
	16	2418	43	2445	70	2472
	17	2419	44	2446	71	2473
	18	2420	45	2447	72	2474
	19	2421	46	2448	73	2475
	20	2422	47	2449	74	2476
	21	2423	48	2450	75	2477
	22	2424	49	2451	76	2478
	23	2425	50	2452	77	2479
	24	2426	51	2453	78	2480
	25	2427	52	2454	-	-
	26	2428	53	2455	-	-



## 2.2 Test Mode

- a. The EUT has been associated with peripherals and configuration operated in a manner tended to maximize its emission characteristics in a typical application. Frequency range investigated: conduction emission (150 kHz to 30 MHz), radiation emission (9 kHz to the 10th harmonic of the highest fundamental frequency or to 40 GHz, whichever is lower). For radiated measurement, pre-scanned in three orthogonal panels, X, Y, Z. The worst cases (Z plane) were recorded in this report, and the worst mode of radiated spurious emissions is Bluetooth 3Mbps mode, and recorded in this report.
- b. AC power line Conducted Emission was tested under maximum output power.

The following summary table is showing all test modes to demonstrate in compliance with the standard.

Summary table of Test Cases			
Test Item	Data Rate / Modulation		
	Bluetooth BR 1Mbps GFSK	Bluetooth EDR 2Mbps $\pi/4$ -DQPSK	Bluetooth EDR 3Mbps 8-DPSK
Conducted Test Cases	Mode 1: CH00_2402 MHz Mode 2: CH39_2441 MHz Mode 3: CH78_2480 MHz	Mode 4: CH00_2402 MHz Mode 5: CH39_2441 MHz Mode 6: CH78_2480 MHz	Mode 7: CH00_2402 MHz Mode 8: CH39_2441 MHz Mode 9: CH78_2480 MHz
Radiated Test Cases	Bluetooth EDR 3Mbps 8-DPSK		
	Mode 1: CH00_2402 MHz Mode 2: CH39_2441 MHz Mode 3: CH78_2480 MHz		
AC Conducted Emission	Mode 1: GSM850 Idle + Bluetooth Link + WLAN (2.4GHz) Link + MP3 + SD Card + USB Cable (Charging from Adapter 1) + Earphone		
<b>Remark:</b> <ol style="list-style-type: none"> <li>1. For radiated test cases, the worst mode data rate 3Mbps was reported only, because this data rate has the highest RF output power at preliminary tests, and the conducted spurious emissions and conducted band edge measurement for each data rate are no worse than 3Mbps, and no other significantly frequencies found in conducted spurious emission.</li> <li>2. All the radiated test cases were performance with Adapter 1..</li> </ol>			

## 2.3 Connection Diagram of Test System

<Bluetooth Tx Mode>

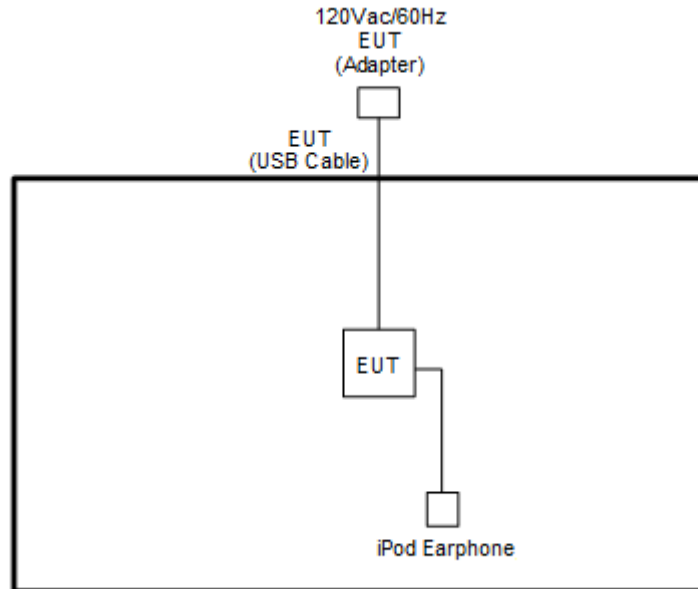

<AC Conducted Emission Mode>

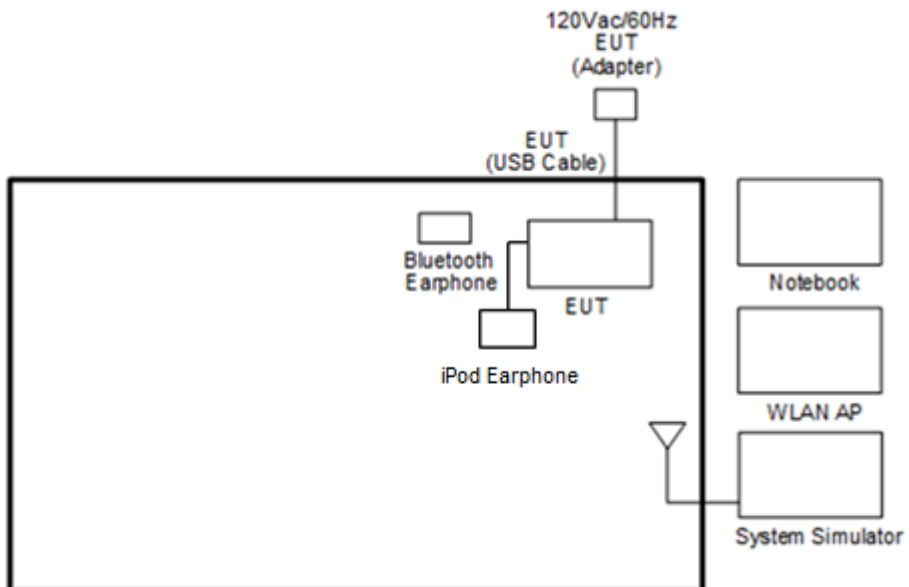



## 2.4 Support Unit used in test configuration and system

Item	Equipment	Trade Name	Model Name	FCC ID	Data Cable	Power Cord
1.	System Simulator	Anritsu	MT8820C	N/A	N/A	Unshielded, 1.8 m
2.	Bluetooth Earphone	Sony Ericsson	MW600	PY7DDA-2029	N/A	N/A
3.	WLAN AP	ASUS	RT-AC66U	MSQ-RTAC66U	N/A	Unshielded, 1.8 m
4.	iPod Earphone	Apple	A1285	FCC DoC	Shielded, 1.0 m	N/A
5.	Notebook	DELL	Latitude E6320	FCC DoC/ Contains FCC ID: QDS-BRCM1054	N/A	AC I/P: Unshielded, 1.2 m DC O/P: Shielded, 1.8 m
6.	SD Card	SanDisk	MicroSD HC	FCC DoC	N/A	N/A

## 2.5 EUT Operation Test Setup

The RF test items, utility “QRCT” was installed in Notebook which was programmed in order to make the EUT get into the engineering modes to provide channel selection, power level, data rate and the application type and for continuous transmitting signals.

## 2.6 Measurement Results Explanation Example

**For all conducted test items:**

The offset level is set in the spectrum analyzer to compensate the RF cable loss and attenuator factor between EUT conducted output port and spectrum analyzer. With the offset compensation, the spectrum analyzer reading level is exactly the EUT RF output level.

Example:

The spectrum analyzer offset is derived from RF cable loss and attenuator factor.

*Offset = RF cable loss + attenuator factor.*

Following shows an offset computation example with cable loss 4.2 dB and 10dB attenuator.

$$\begin{aligned} \text{Offset(dB)} &= \text{RF cable loss(dB)} + \text{attenuator factor(dB)}. \\ &= 4.2 + 10 = 14.2 \text{ (dB)} \end{aligned}$$

### 3 Test Result

#### 3.1 Number of Channel Measurement

##### 3.1.1 Limits of Number of Hopping Frequency

Frequency hopping systems in the 2400-2483.5 MHz band shall use at least 15 channels.

##### 3.1.2 Measuring Instruments

The measuring equipment is listed in the section 4 of this test report.

##### 3.1.3 Test Procedure

1. The testing follows ANSI C63.10-2013 clause 7.8.3.
2. The RF output of EUT was connected to the spectrum analyzer by RF cable and attenuator. The path loss was compensated to the results for each measurement.
3. Set to the maximum power setting and enable the EUT transmit continuously.
4. Enable the EUT hopping function.
5. Use the following spectrum analyzer settings: Span = the frequency band of operation; RBW = 300kHz; VBW  $\geq$  RBW; Sweep = auto; Detector function = peak; Trace = max hold.
6. The number of hopping frequency used is defined as the number of total channel.
7. Record the measurement data derived from spectrum analyzer.

##### 3.1.4 Test Setup

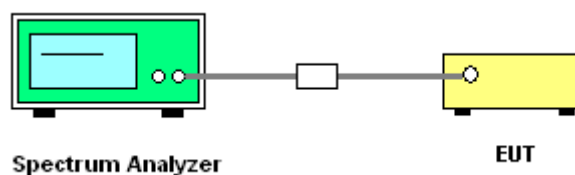



### 3.1.5 Test Result of Number of Hopping Frequency

Please refer to Appendix A.

Number of Hopping Channel Plot on Channel 00 - 78

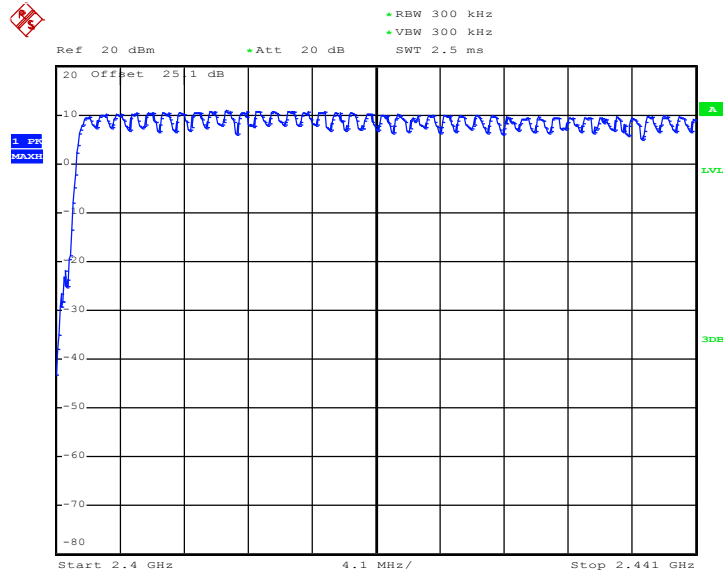

Date: 26.DEC.2017 14:10:45

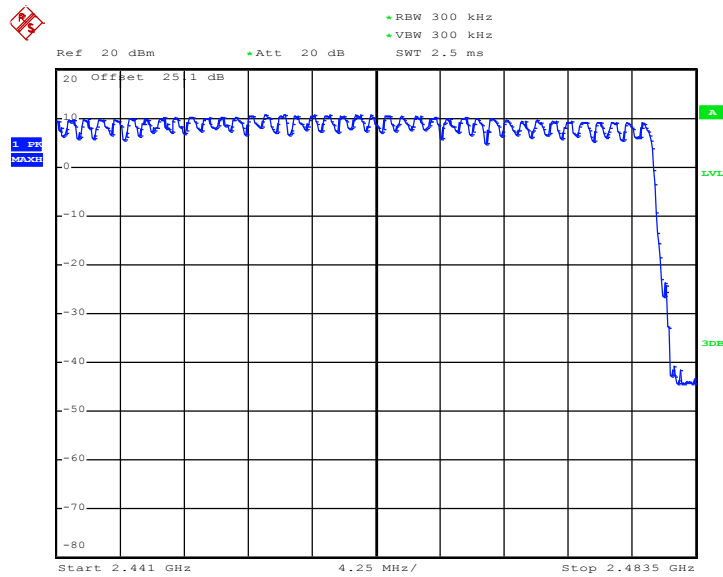

Date: 26.DEC.2017 14:12:02

## 3.2 Hopping Channel Separation Measurement

### 3.2.1 Limit of Hopping Channel Separation

Frequency hopping systems operating in the 2400-2483.5 MHz band may have hopping channel carrier frequencies that are separated by 25 kHz or two-thirds of the 20 dB bandwidth of the hopping channel, whichever is greater.

### 3.2.2 Measuring Instruments

The measuring equipment is listed in the section 4 of this test report.

### 3.2.3 Test Procedures

1. The testing follows ANSI C63.10-2013 clause 7.8.2.
2. The RF output of EUT was connected to the spectrum analyzer by RF cable and attenuator. The path loss was compensated to the results for each measurement.
3. Set to the maximum power setting and enable the EUT transmit continuously.
4. Enable the EUT hopping function.
5. Use the following spectrum analyzer settings:  
Span = wide enough to capture the peaks of two adjacent channels;  
RBW = 300kHz; VBW  $\geq$  RBW; Sweep = auto; Detector function = peak; Trace = max hold.
6. Measure and record the results in the test report.

### 3.2.4 Test Setup

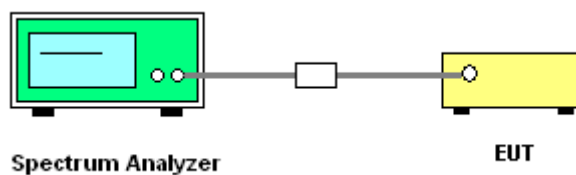

### 3.2.5 Test Result of Hopping Channel Separation

Please refer to Appendix A.



<1Mbps>

Channel Separation Plot on Channel 00 - 01

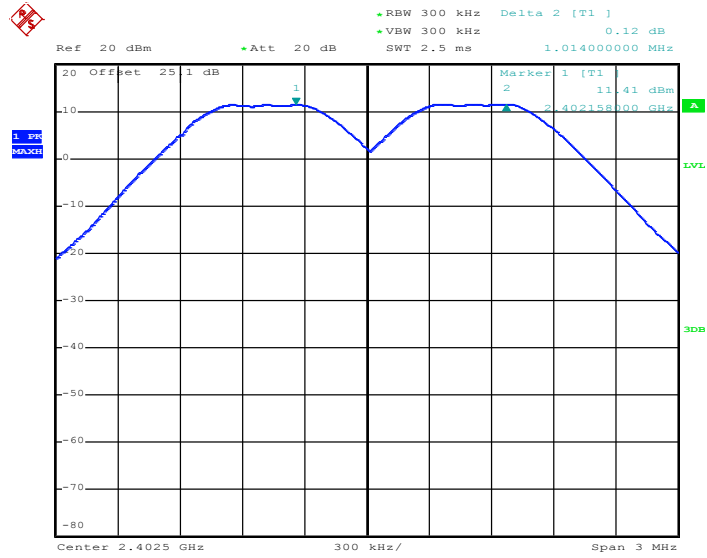

Date: 26.DEC.2017 11:30:31

Channel Separation Plot on Channel 39 - 40

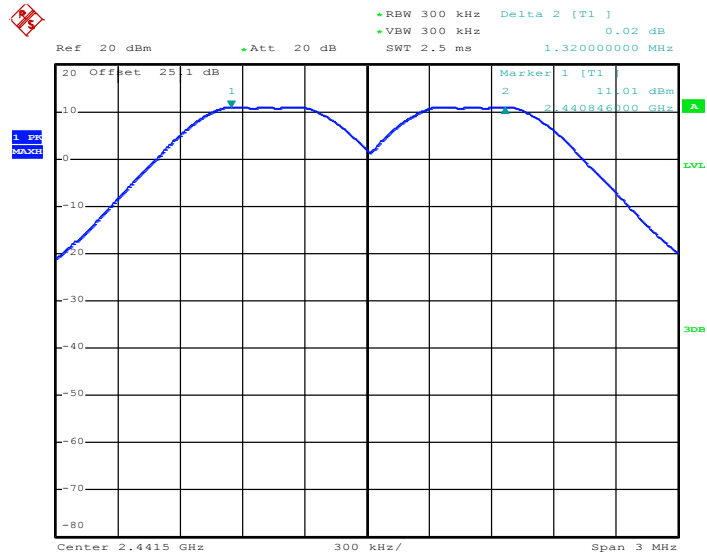

Date: 26.DEC.2017 11:36:06



Channel Separation Plot on Channel 77 - 78

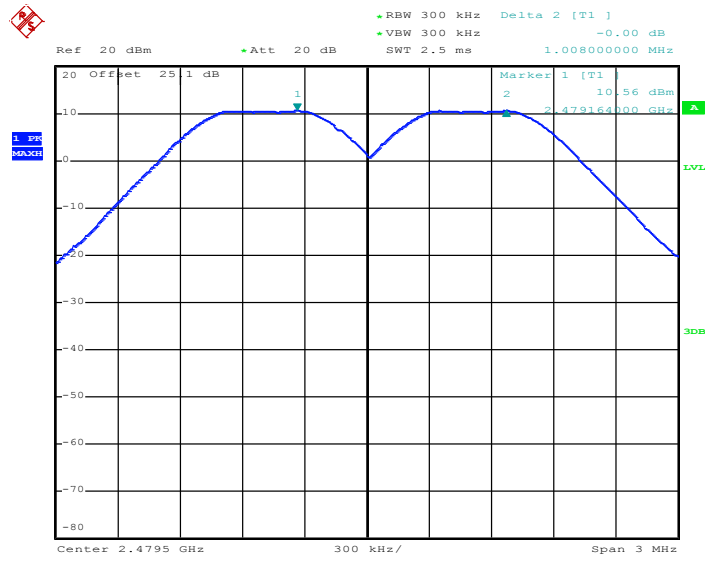

Date: 26.DEC.2017 11:40:55

<2Mbps>

Channel Separation Plot on Channel 00 - 01

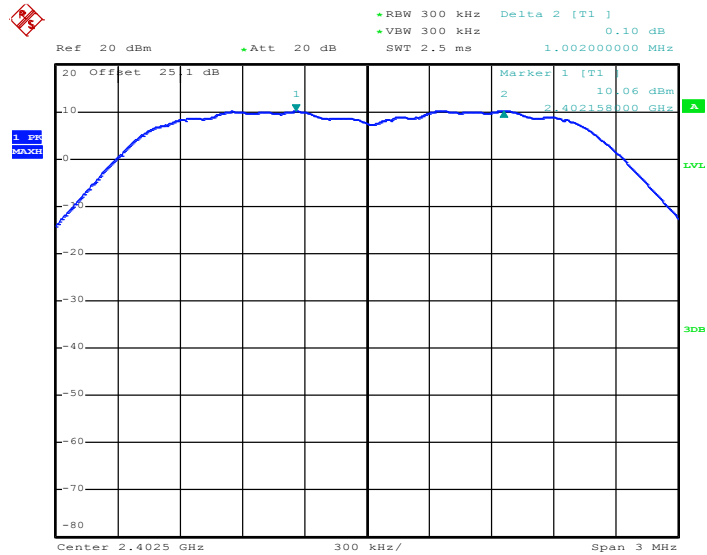

Date: 26.DEC.2017 11:53:58



### Channel Separation Plot on Channel 39 - 40

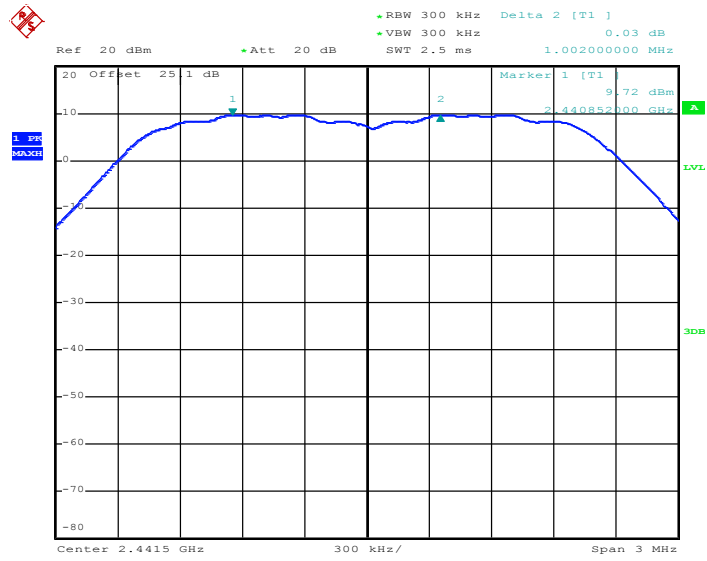

Date: 26.DEC.2017 13:55:56

### Channel Separation Plot on Channel 77 - 78

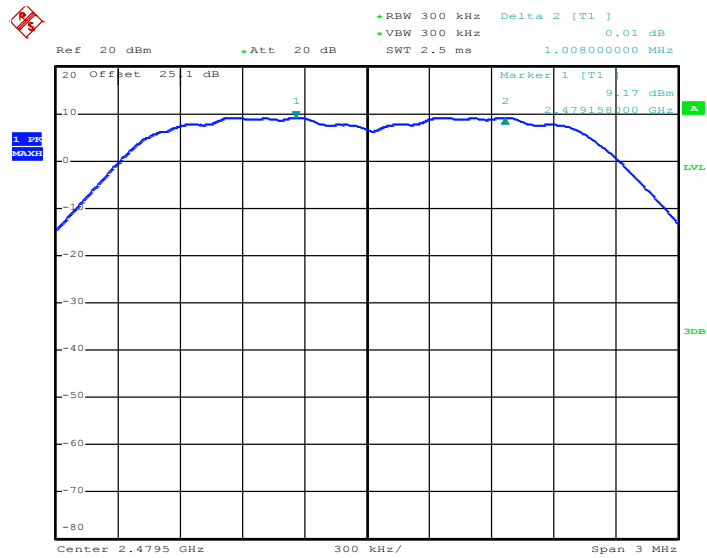

Date: 26.DEC.2017 14:03:36



<3Mbps>

Channel Separation Plot on Channel 00 - 01

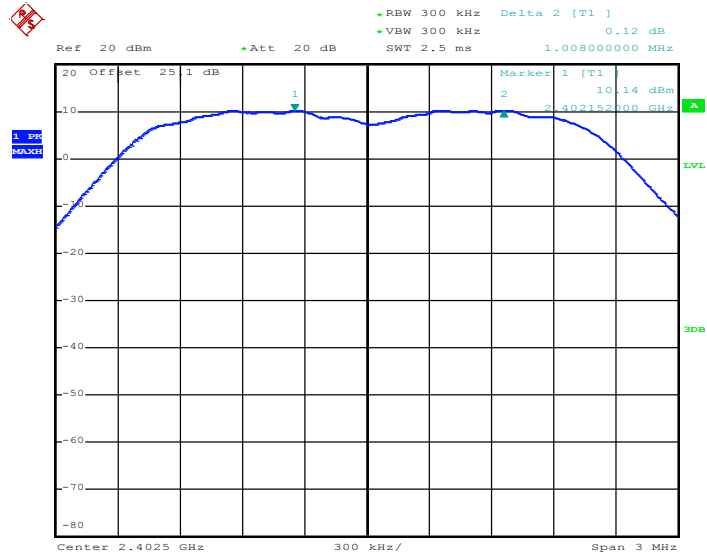

Date: 26.DEC.2017 14:20:54

Channel Separation Plot on Channel 39 - 40

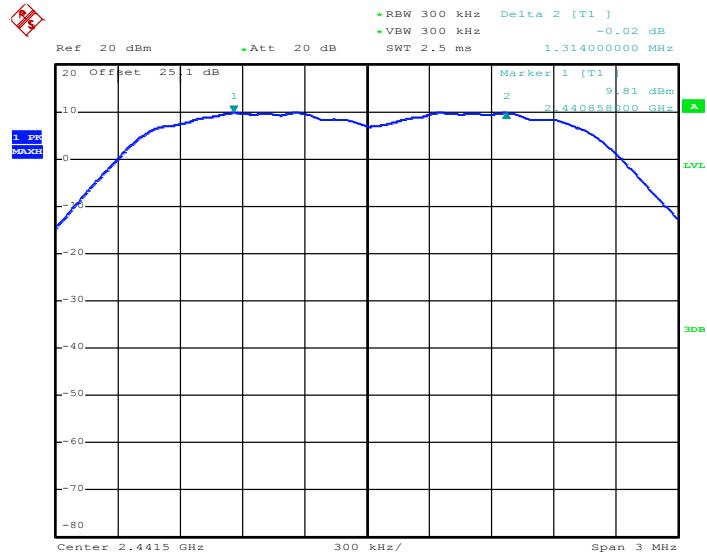

Date: 26.DEC.2017 14:29:23



Channel Separation Plot on Channel 77 - 78

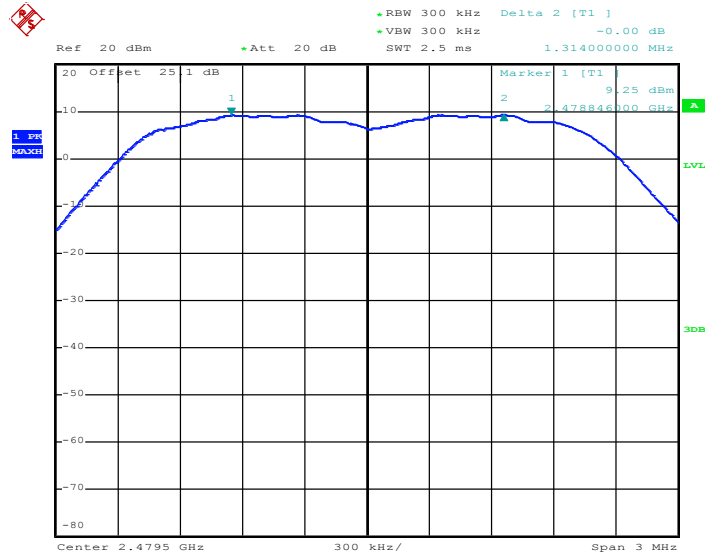

Date: 26.DEC.2017 14:34:00

### 3.3 Dwell Time Measurement

#### 3.3.1 Limit of Dwell Time

The average time of occupancy on any channel shall not be greater than 0.4 seconds within a period of 0.4 seconds multiplied by the number of hopping channels employed.

#### 3.3.2 Measuring Instruments

The measuring equipment is listed in the section 4 of this test report.

#### 3.3.3 Test Procedures

1. The testing follows ANSI C63.10-2013 clause 7.8.4.
2. The RF output of EUT was connected to the spectrum analyzer by RF cable and attenuator. The path loss was compensated to the results for each measurement.
3. Set to the maximum power setting and enable the EUT transmit continuously.
4. Enable the EUT hopping function.
5. Use the following spectrum analyzer settings: Span = zero span, centered on a hopping channel; RBW = 1 MHz; VBW  $\geq$  RBW; Sweep = as necessary to capture the entire dwell time per hopping channel; Detector function = peak; Trace = max hold.
6. Measure and record the results in the test report.

#### 3.3.4 Test Setup

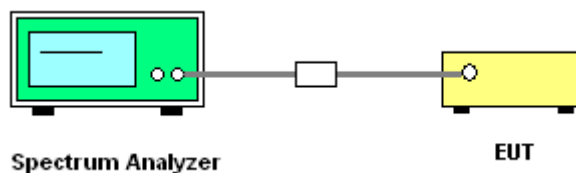

#### 3.3.5 Test Result of Dwell Time

Please refer to Appendix A.



Package Transfer Time Plot

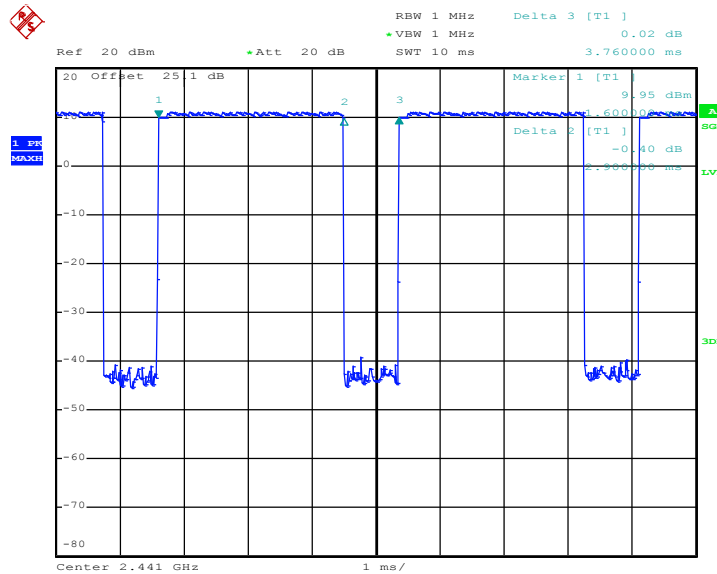

Date: 21.DEC.2017 21:11:24

Remark:

1. In normal mode, hopping rate is 1600 hops/s with 6 slots in 79 hopping channels. With channel hopping rate (1600 / 6 / 79) in Occupancy Time Limit (0.4 x 79) (s), Hops Over Occupancy Time comes to (1600 / 6 / 79) x (0.4 x 79) = 106.67 hops.
2. In AFH mode, hopping rate is 800 hops/s with 6 slots in 20 hopping channels. With channel hopping rate (800 / 6 / 20) in Occupancy Time Limit (0.4 x 20) (s), Hops Over Occupancy Time comes to (800 / 6 / 20) x (0.4 x 20) = 53.33 hops.
3. Dwell Time(s) = Hops Over Occupancy Time (hops) x Package Transfer Time

### 3.4 20dB and 99% Bandwidth Measurement

#### 3.4.1 Limit of 20dB and 99% Bandwidth

Reporting only

#### 3.4.2 Measuring Instruments

The measuring equipment is listed in the section 4 of this test report.

#### 3.4.3 Test Procedures

1. The testing follows ANSI C63.10-2013 clause 6.9.2 and 6.9.3.
2. The RF output of EUT was connected to the spectrum analyzer by RF cable and attenuator. The path loss was compensated to the results for each measurement.
3. Set to the maximum power setting and enable the EUT transmit continuously.
4. Use the following spectrum analyzer settings for 20dB Bandwidth measurement.  
Span = approximately 2 to 5 times the 20 dB bandwidth, centered on a hopping channel;  
RBW  $\geq$  1% of the 20 dB bandwidth; VBW  $\geq$  RBW; Sweep = auto; Detector function = peak;  
Trace = max hold.
5. Use the following spectrum analyzer settings for 99 % Bandwidth measurement.  
Span = approximately 1.5 to 5 times the 99% bandwidth, centered on a hopping channel;  
RBW  $\geq$  1% of the 99% bandwidth; VBW  $\geq$  RBW; Sweep = auto; Detector function = peak;  
Trace = max hold.
6. Measure and record the results in the test report.

#### 3.4.4 Test Setup

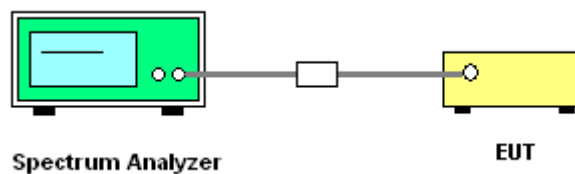

#### 3.4.5 Test Result of 20dB Bandwidth

Please refer to Appendix A.



<1Mbps>

20 dB Bandwidth Plot on Channel 00

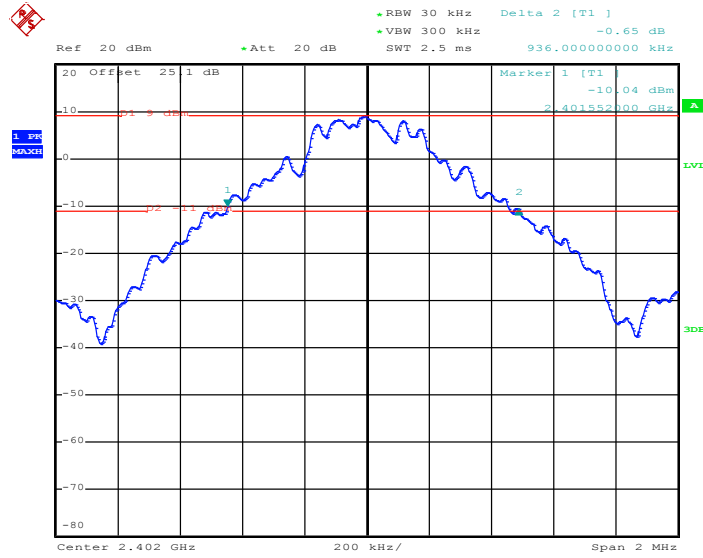

Date: 26.DEC.2017 14:46:19

20 dB Bandwidth Plot on Channel 39

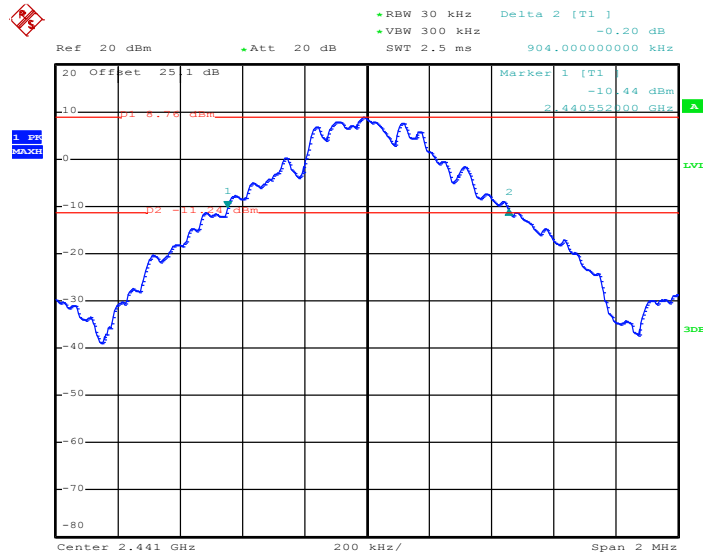

Date: 26.DEC.2017 14:47:39



20 dB Bandwidth Plot on Channel 78

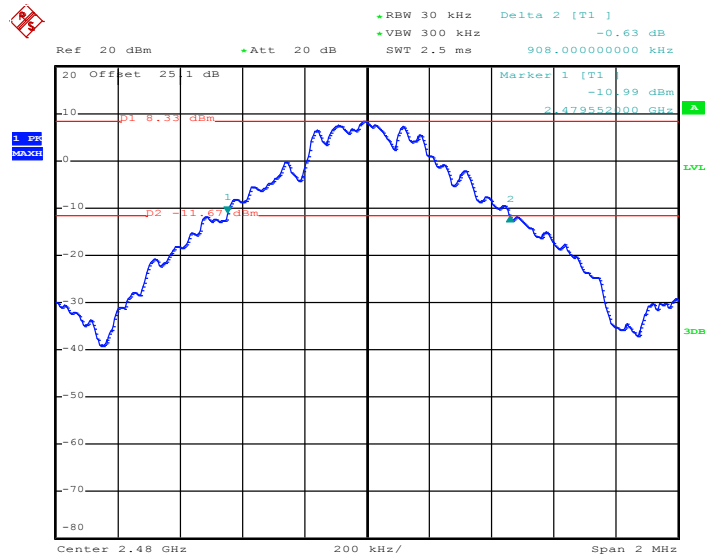

Date: 26.DEC.2017 14:48:36

<2Mbps>

20 dB Bandwidth Plot on Channel 00

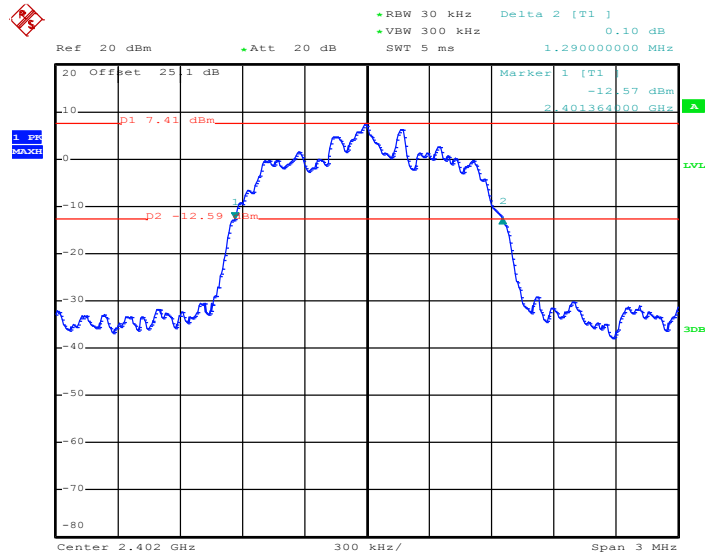

Date: 26.DEC.2017 11:46:53



### 20 dB Bandwidth Plot on Channel 39

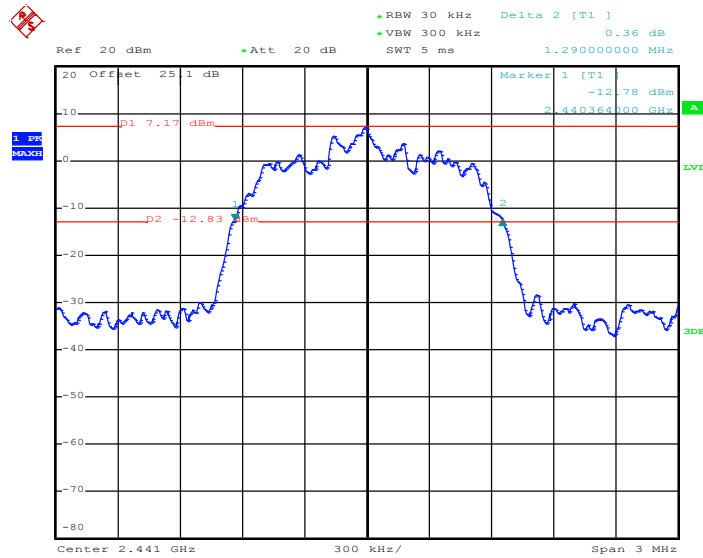

Date: 26.DEC.2017 11:56:00

### 20 dB Bandwidth Plot on Channel 78

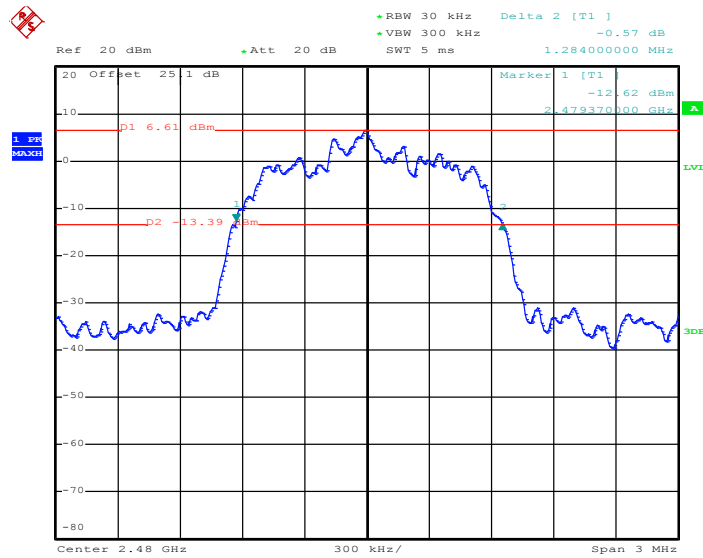

Date: 26.DEC.2017 13:57:58



<3Mbps>

20 dB Bandwidth Plot on Channel 00

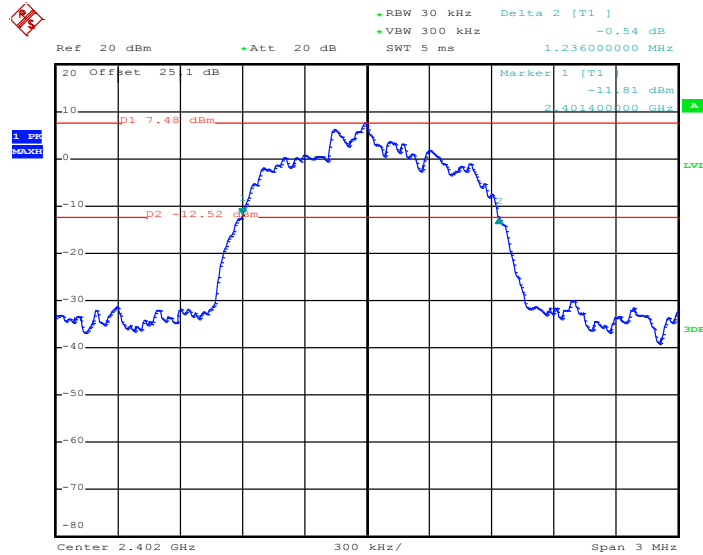

Date: 26.DEC.2017 14:13:18

20 dB Bandwidth Plot on Channel 39

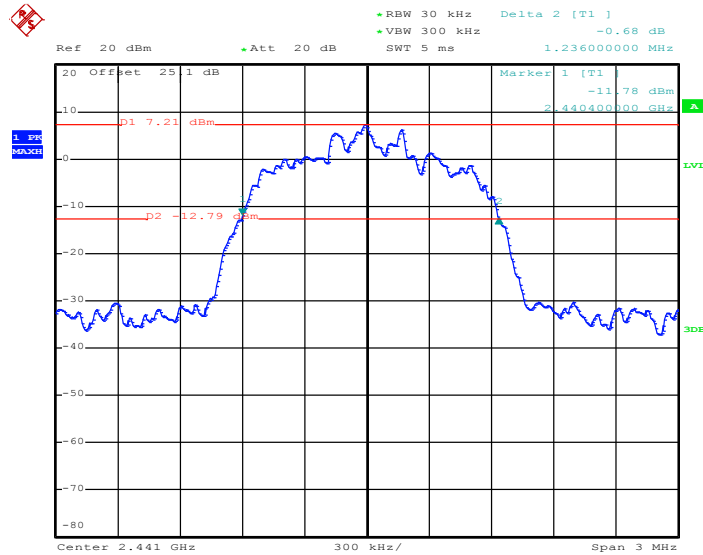

Date: 26.DEC.2017 14:22:41



20 dB Bandwidth Plot on Channel 78

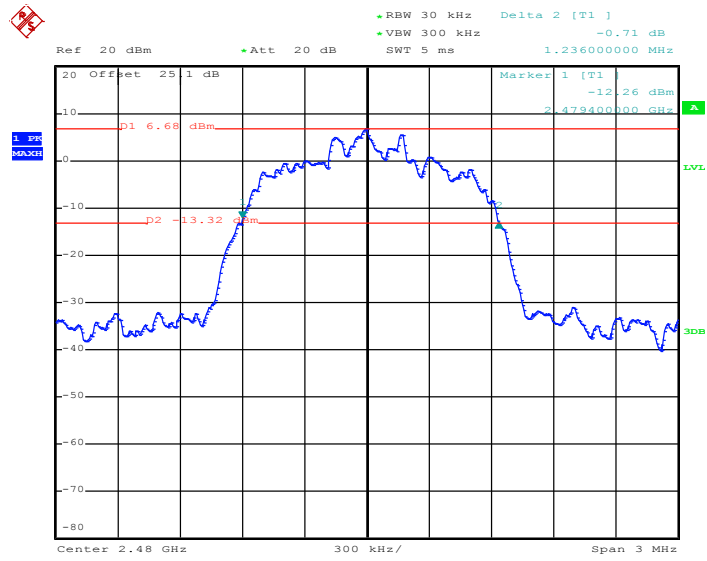

Date: 26.DEC.2017 14:30:42



### 3.4.6 Test Result of 99% Occupied Bandwidth

Please refer to Appendix A.

<1Mbps>

#### 99% Occupied Bandwidth Plot on Channel 00

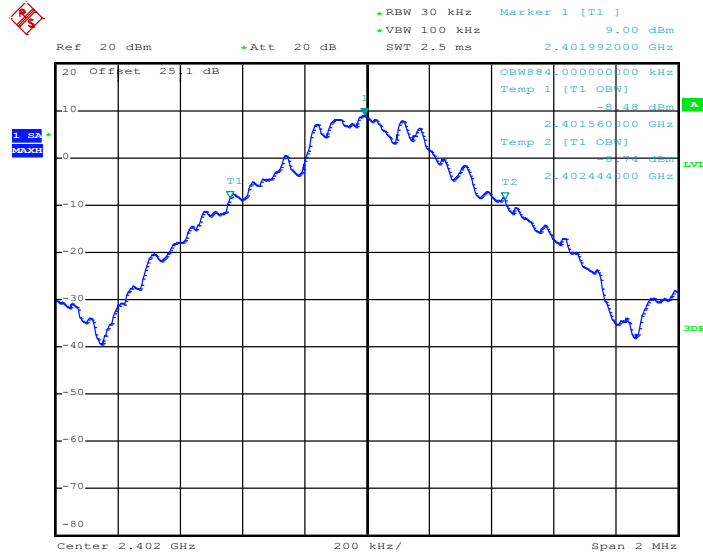

Date: 26.DEC.2017 10:48:00

#### 99% Occupied Bandwidth Plot on Channel 39

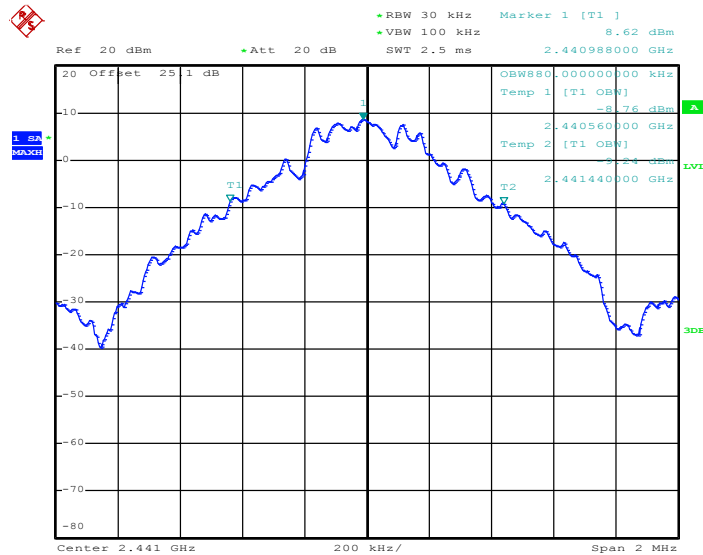

Date: 26.DEC.2017 11:33:15



99% Occupied Bandwidth Plot on Channel 78

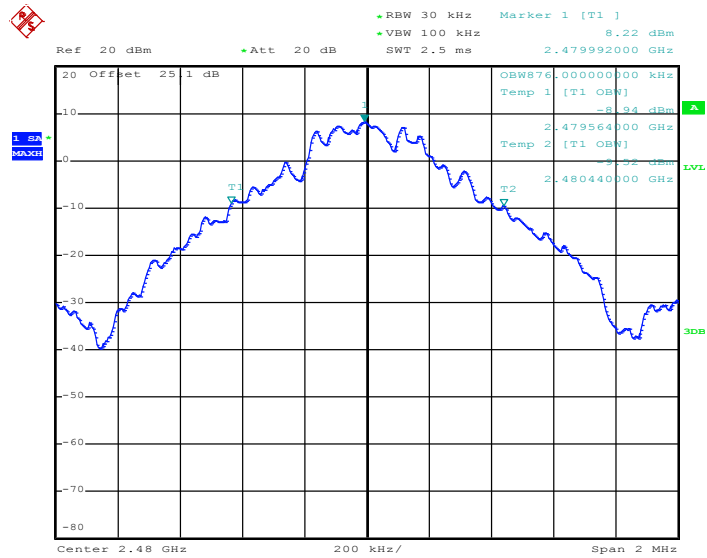

Date: 26.DEC.2017 11:38:53

<2Mbps>

99% Occupied Bandwidth Plot on Channel 00

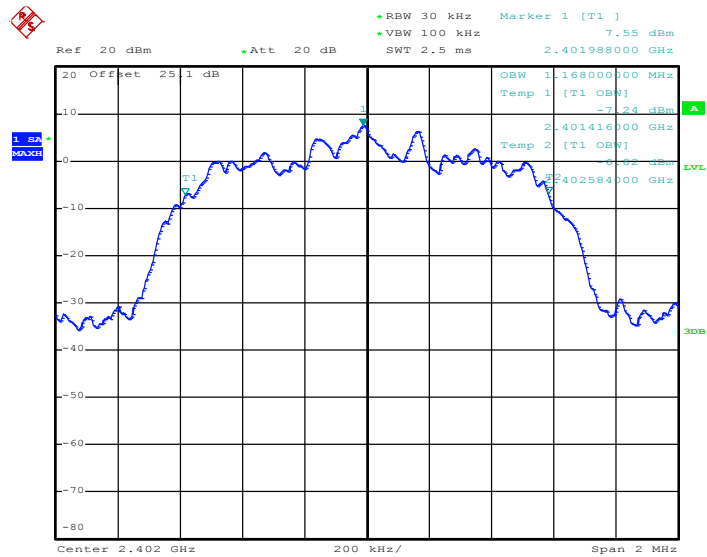

Date: 26.DEC.2017 11:48:11



99% Occupied Bandwidth Plot on Channel 39

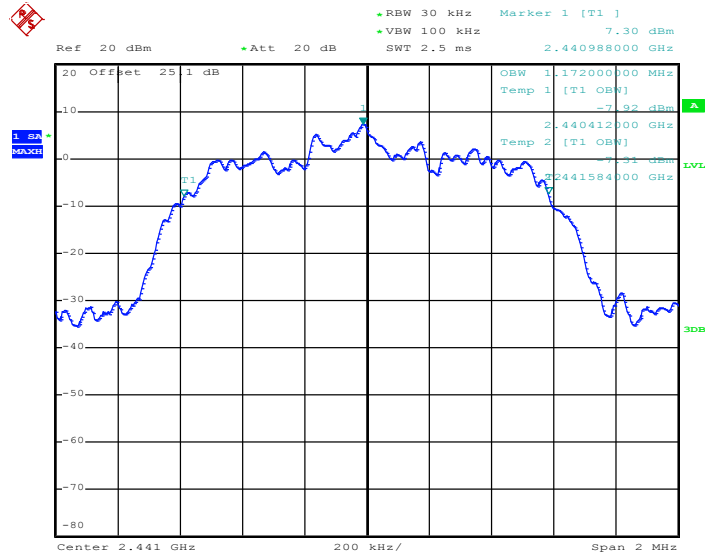

Date: 26.DEC.2017 11:56:51

99% Occupied Bandwidth Plot on Channel 78

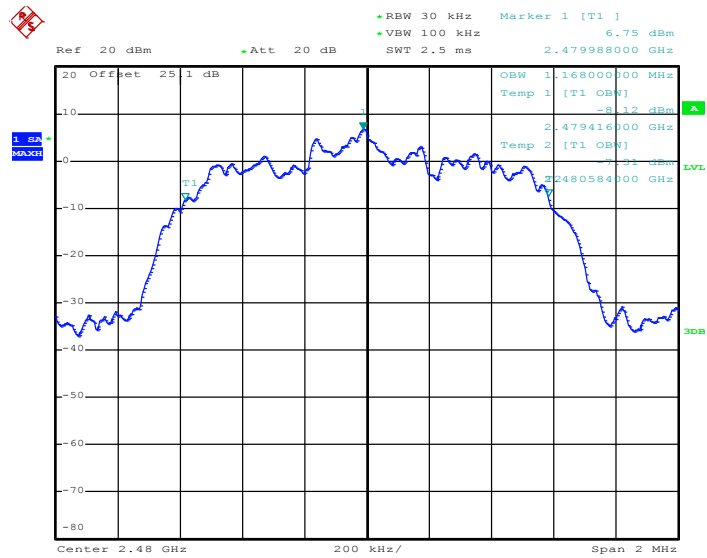

Date: 26.DEC.2017 13:59:08



<3Mbps>

99% Occupied Bandwidth Plot on Channel 00

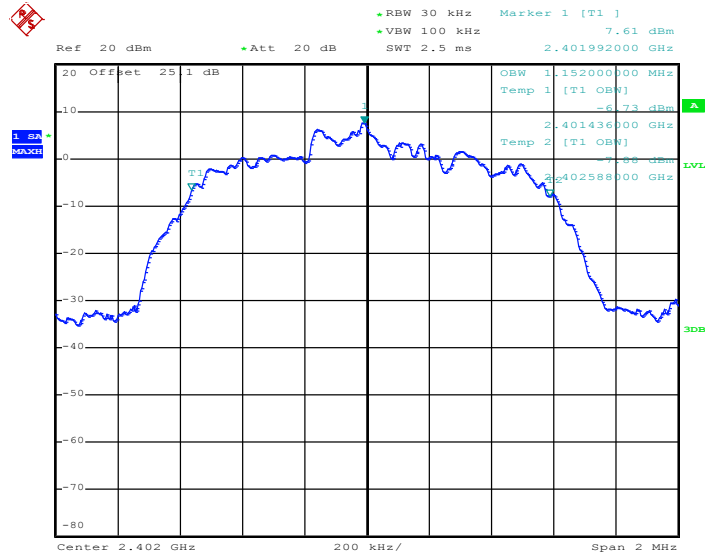

Date: 26.DEC.2017 14:14:43

99% Occupied Bandwidth Plot on Channel 39

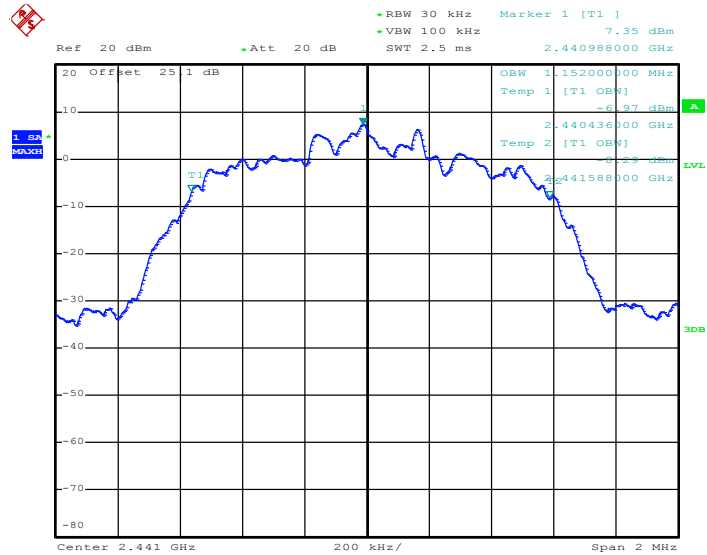

Date: 26.DEC.2017 14:23:22



99% Occupied Bandwidth Plot on Channel 78

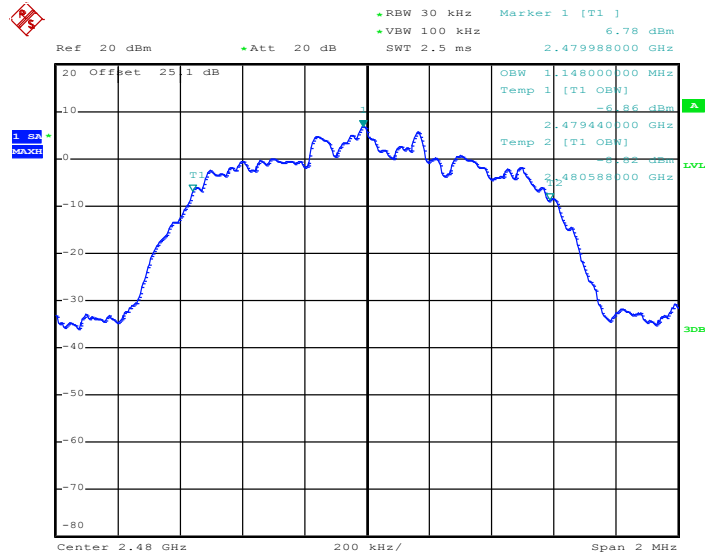

Date: 26.DEC.2017 14:31:37

Note : The occupied channel bandwidth is maintained within the band of operation for all of the modulations.

### **3.5 Output Power Measurement**

#### **3.5.1 Limit of Output Power**

The maximum peak conducted output power of the intentional radiator shall not exceed the following:  
(1) For frequency hopping systems operating in the 2400-2483.5 MHz band employing at least 75 non-overlapping hopping channels, and all frequency hopping systems in the 5725-5850 MHz band: 1 watt. For all other frequency hopping systems in the 2400-2483.5 MHz band 0.125 watts. The power limit for 1Mbps, 2Mbps, 3Mbps and AFH modes are 0.125 watts.

#### **3.5.2 Measuring Instruments**

The measuring equipment is listed in the section 4 of this test report.

#### **3.5.3 Test Procedures**

1. The testing follows ANSI C63.10-2013 clause 7.8.5.
2. The RF output of EUT was connected to the power meter by RF cable and attenuator. The path loss was compensated to the results for each measurement.
3. Set to the maximum power setting and enable the EUT transmit continuously.
4. Measure the conducted output power with cable loss and record the results in the test report.
5. Measure and record the results in the test report.

#### **3.5.4 Test Setup**

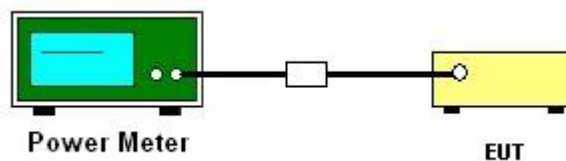

#### **3.5.5 Test Result of Peak Output Power**

Please refer to Appendix A.

#### **3.5.6 Test Result of Average Output Power (Reporting Only)**

Please refer to Appendix A.

## 3.6 Conducted Band Edges Measurement

### 3.6.1 Limit of Band Edges

In any 100 kHz bandwidth outside the intentional radiation frequency band, the radio frequency power shall be at least 20 dB below the highest level of the radiated power. In addition, radiated emissions which fall in the restricted bands must also comply with the radiated emission limits.

### 3.6.2 Measuring Instruments

The measuring equipment is listed in the section 4 of this test report.

### 3.6.3 Test Procedures

1. The testing follows ANSI C63.10-2013 clause 7.8.6.
2. Set to the maximum power setting and enable the EUT transmit continuously.
3. Set RBW = 100kHz, VBW = 300kHz. Band edge emissions must be at least 20 dB down from the highest emission level within the authorized band as measured with a 100kHz RBW. The attenuation shall be 30 dB instead of 20 dB when RMS conducted output power procedure is used.
4. Enable hopping function of the EUT and then repeat step 2. and 3.
5. Measure and record the results in the test report.

### 3.6.4 Test Setup

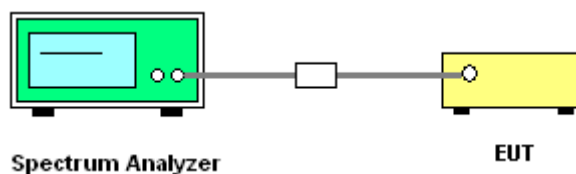

### 3.6.5 Test Result of Conducted Band Edges

Please refer to Appendix A.



<1Mbps>

Low Band Edge Plot on Channel 00

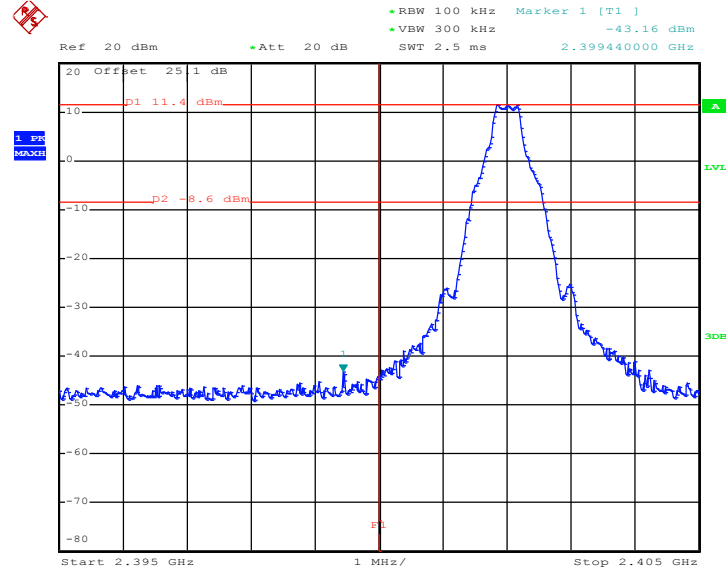

Date: 26.DEC.2017 10:47:02

High Band Edge Plot on Channel 78

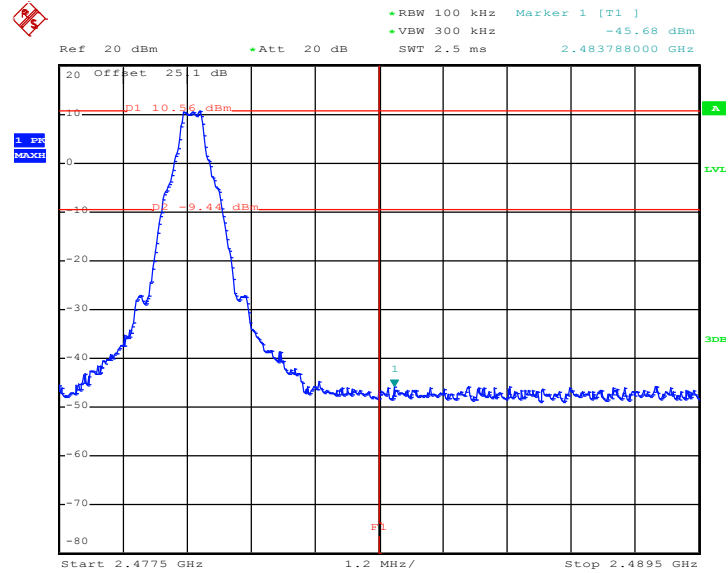

Date: 26.DEC.2017 11:38:05



<2Mbps>

Low Band Edge Plot on Channel 00

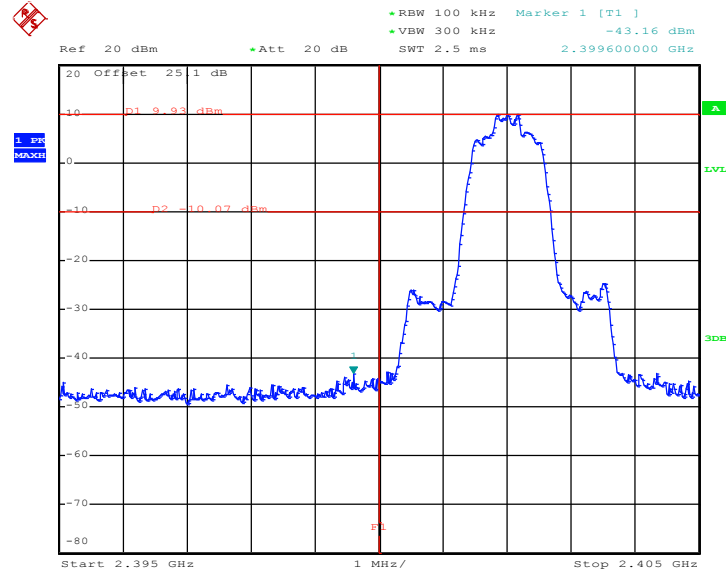

Date: 26.DEC.2017 11:47:30

High Band Edge Plot on Channel 78

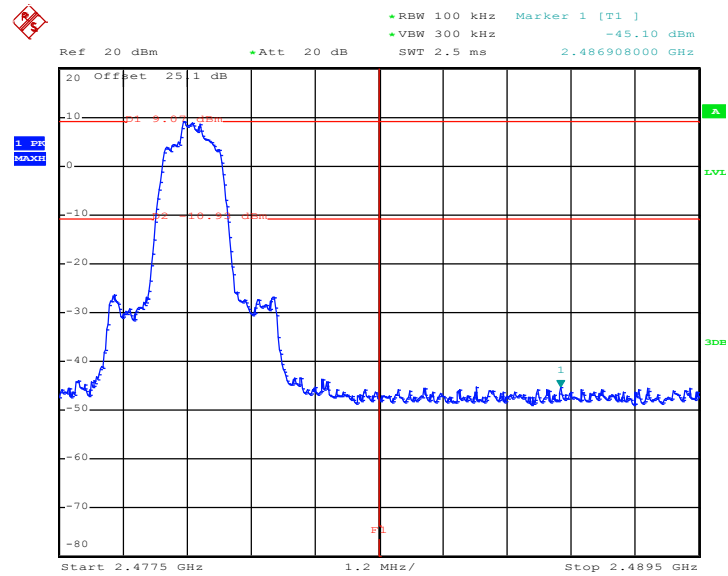

Date: 26.DEC.2017 13:58:32



<3Mbps>

Low Band Edge Plot on Channel 00

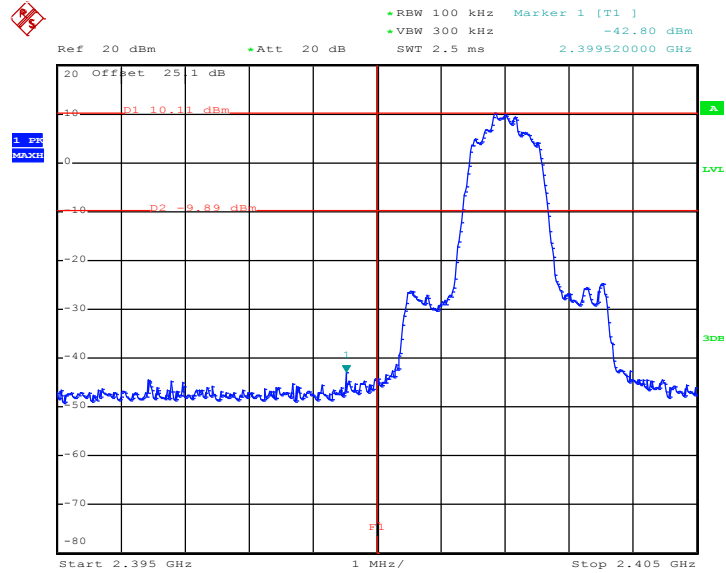

Date: 26.DEC.2017 14:14:04

High Band Edge Plot on Channel 78

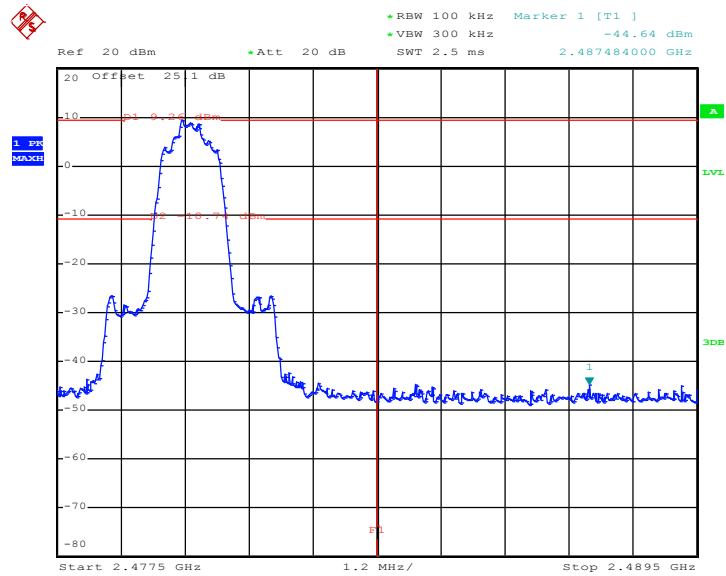

Date: 26.DEC.2017 14:31:01



### 3.6.6 Test Result of Conducted Hopping Mode Band Edges

Please refer to Appendix A.

<1Mbps>

#### Hopping Mode Low Band Edge Plot

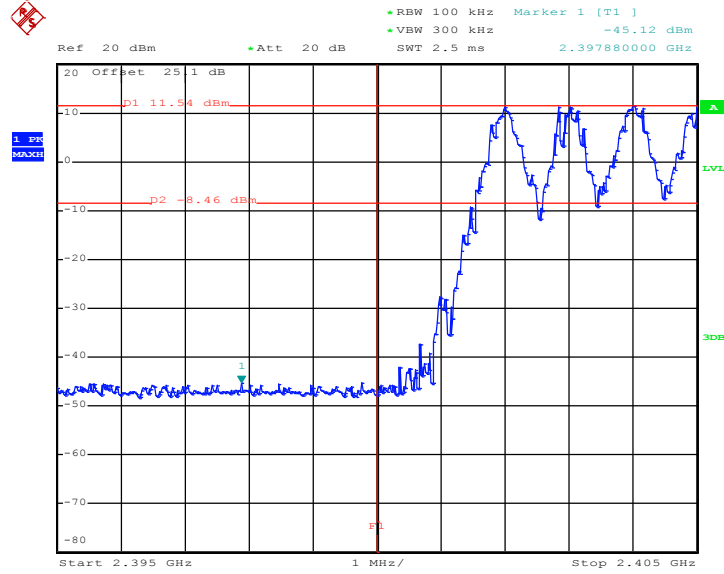

Date: 26.DEC.2017 11:42:43

#### Hopping Mode High Band Edge Plot

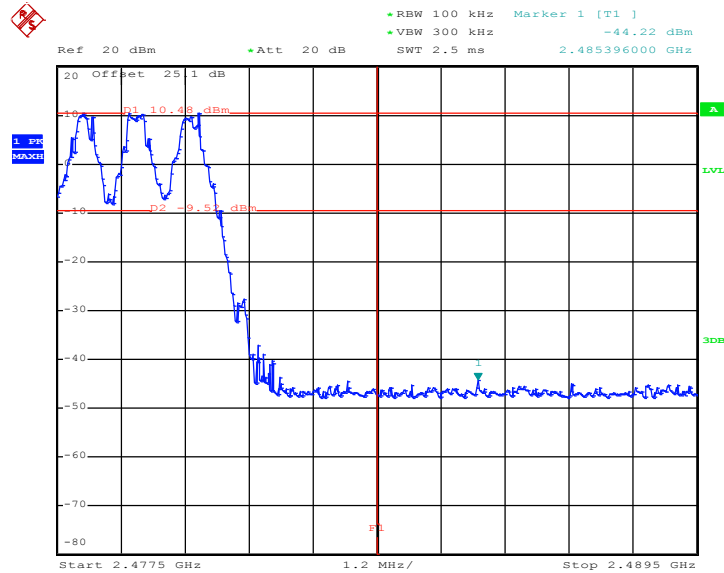

Date: 26.DEC.2017 11:43:35



<2Mbps>

Hopping Mode Low Band Edge Plot

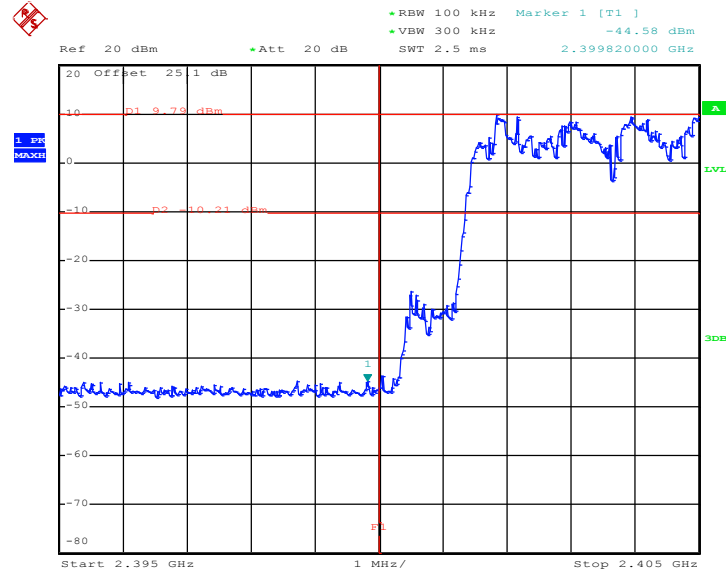

Date: 26.DEC.2017 14:05:14

Hopping Mode High Band Edge Plot

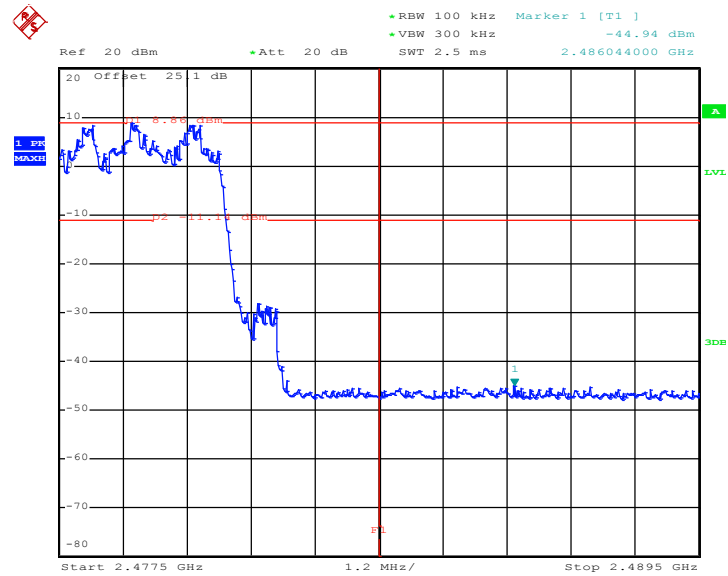

Date: 26.DEC.2017 14:06:20



<3Mbps>

Hopping Mode Low Band Edge Plot

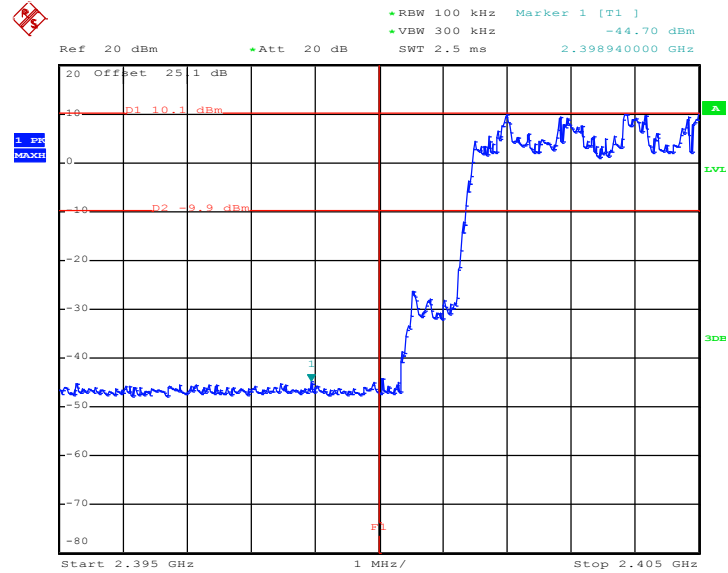

Date: 26.DEC.2017 14:08:22

Hopping Mode High Band Edge Plot

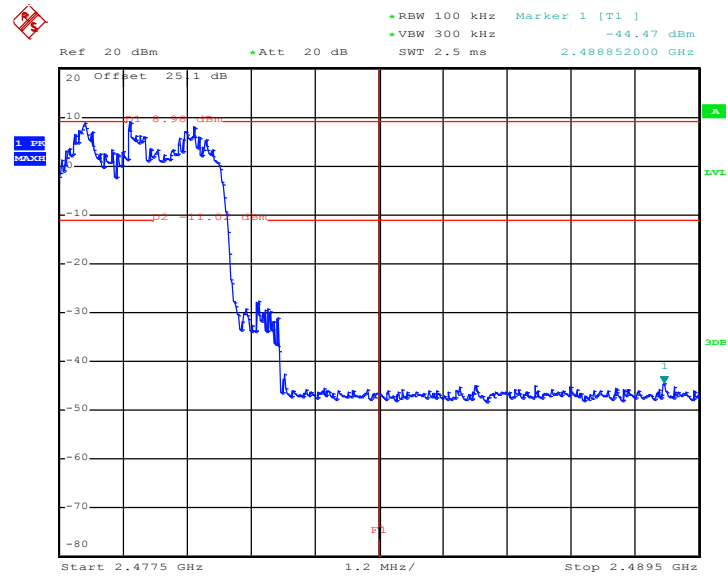

Date: 26.DEC.2017 14:09:11

## 3.7 Conducted Spurious Emission Measurement

### 3.7.1 Limit of Spurious Emission Measurement

In any 100 kHz bandwidth outside the intentional radiation frequency band, the radio frequency power shall be at least 20 dB below the highest level of the radiated power. In addition, radiated emissions which fall in the restricted bands must also comply with the radiated emission limits.

### 3.7.2 Measuring Instruments

The measuring equipment is listed in the section 4 of this test report.

### 3.7.3 Test Procedure

1. The testing follows ANSI C63.10-2013 clause 7.8.8.
2. The RF output of EUT was connected to the spectrum analyzer by RF cable and attenuator. The path loss was compensated to the results for each measurement.
3. Set to the maximum power setting and enable the EUT transmit continuously.
4. Set RBW = 100 kHz, VBW = 300kHz, scan up through 10th harmonic. All harmonics / spurs must be at least 20 dB down from the highest emission level within the authorized band as measured with a 100 kHz RBW.
5. Measure and record the results in the test report.
6. The RF fundamental frequency should be excluded against the limit line in the operating frequency band.

### 3.7.4 Test Setup

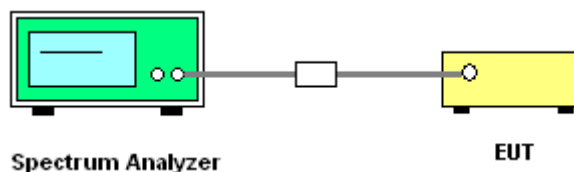



### 3.7.5 Test Result of Conducted Spurious Emission

Please refer to Appendix A.

<1Mbps>

#### CSE Plot on Ch 00 between 30MHz ~ 3 GHz

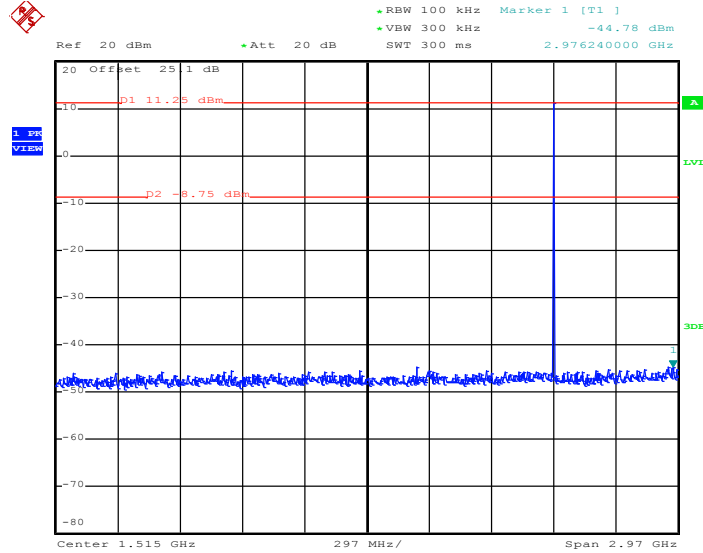

Date: 26.DEC.2017 11:02:25

#### 1Mbps CSE Plot on Ch 00 between 2 GHz ~ 25 GHz

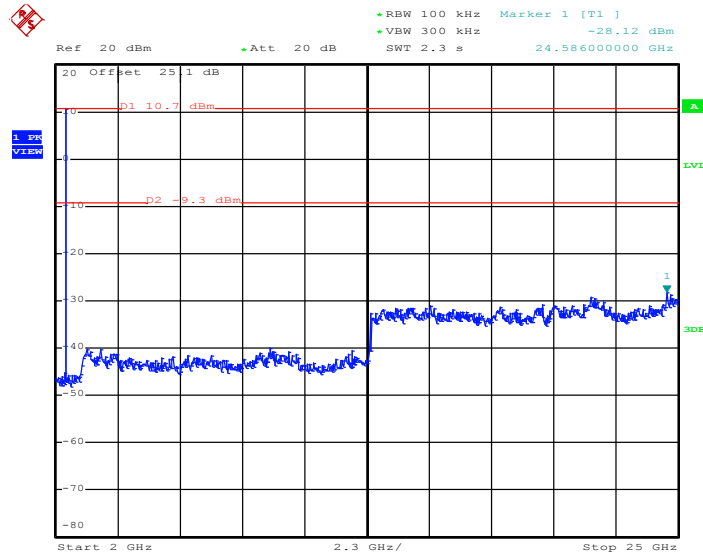

Date: 26.DEC.2017 11:02:47



CSE Plot on Ch 39 between 30MHz ~ 3 GHz

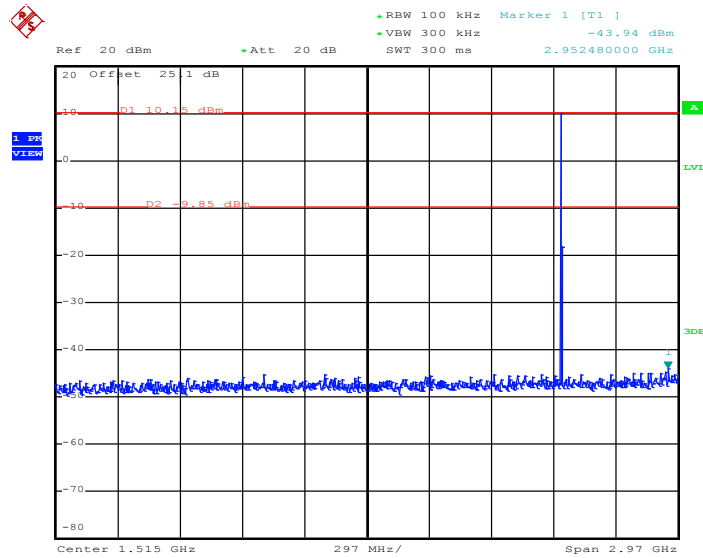

Date: 26.DEC.2017 11:34:44

CSE Plot on Ch 39 between 2 GHz ~ 25 GHz

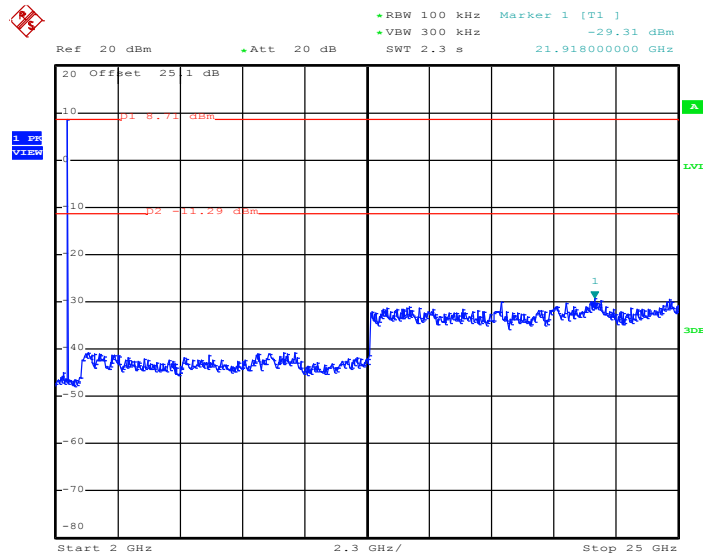

Date: 26.DEC.2017 11:35:06



CSE Plot on Ch 78 between 30MHz ~ 3 GHz

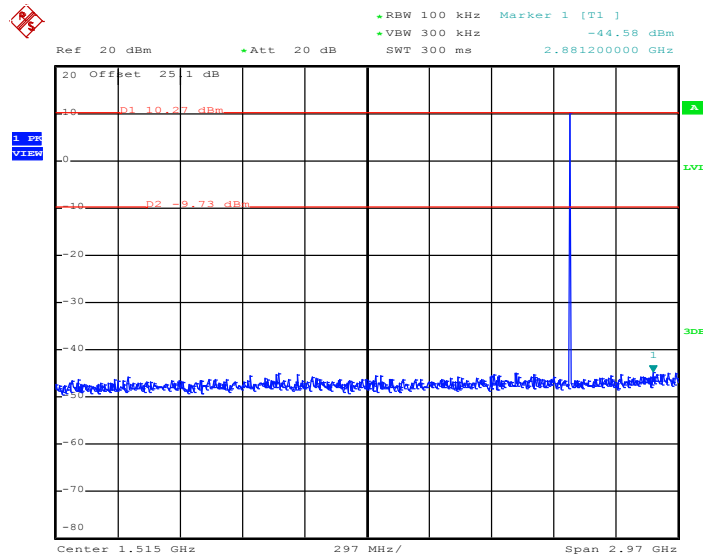

Date: 26.DEC.2017 11:39:21

CSE Plot on Ch 78 between 2 GHz ~ 25 GHz

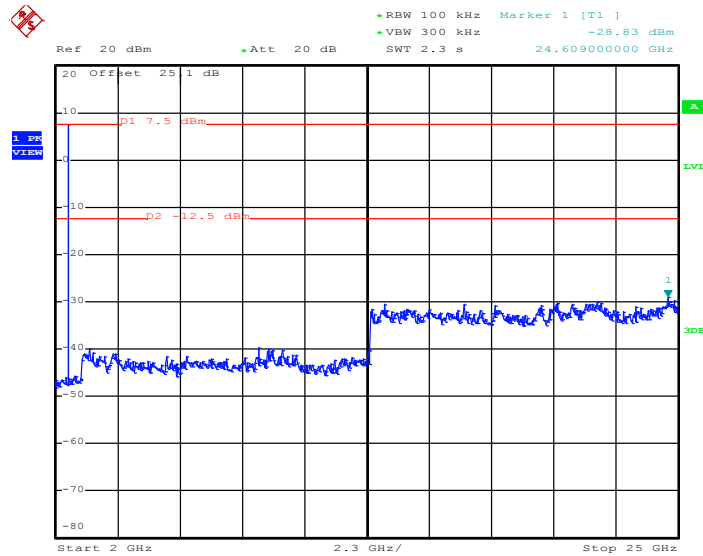

Date: 26.DEC.2017 11:39:43



<2Mbps>

CSE Plot on Ch 00 between 30MHz ~ 3 GHz

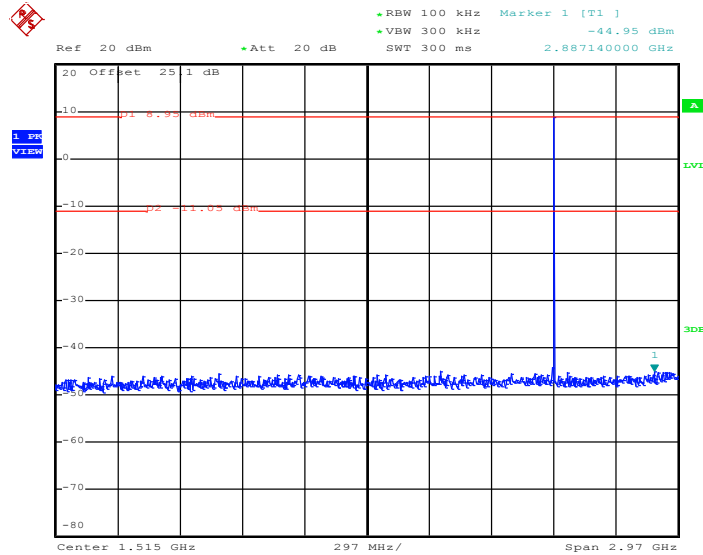

Date: 26.DEC.2017 11:51:31

CSE Plot on Ch 00 between 2 GHz ~ 25 GHz

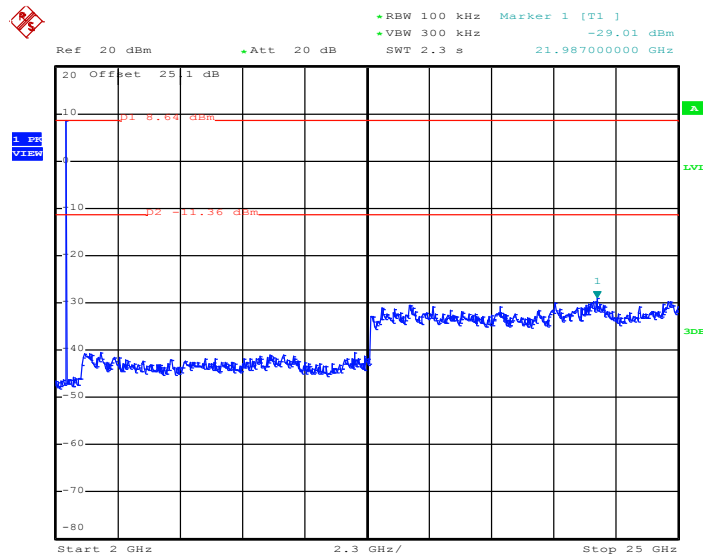

Date: 26.DEC.2017 11:51:53



CSE Plot on Ch 39 between 30MHz ~ 3 GHz

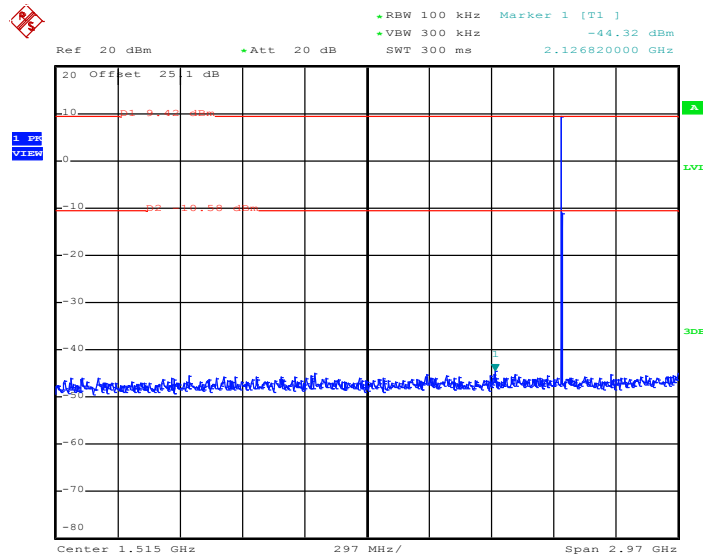

Date: 26.DEC.2017 13:50:57

CSE Plot on Ch 39 between 2 GHz ~ 25 GHz

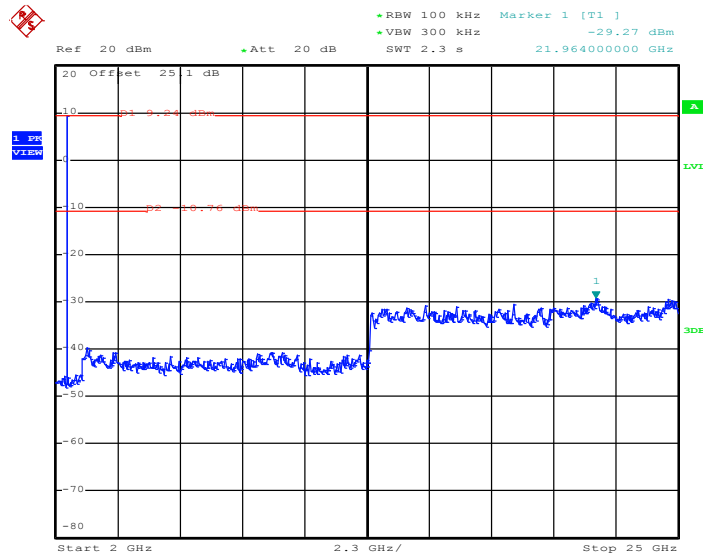

Date: 26.DEC.2017 13:51:19



CSE Plot on Ch 78 between 30MHz ~ 3 GHz

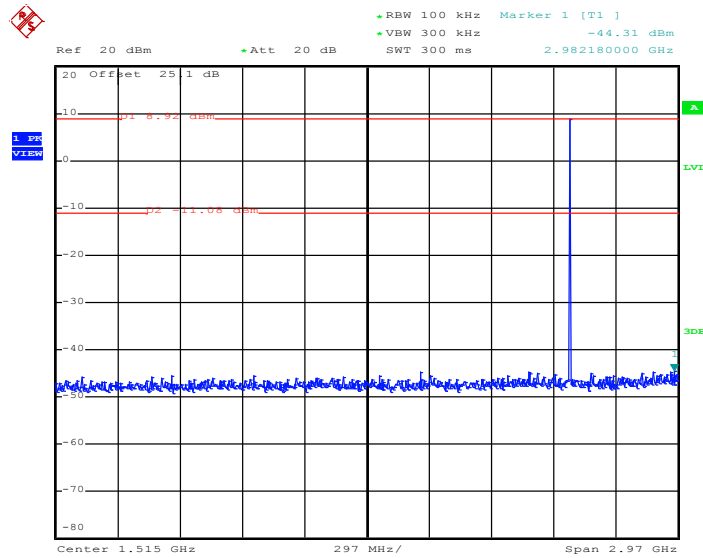

Date: 26.DEC.2017 14:02:11

CSE Plot on Ch 78 between 2 GHz ~ 25 GHz

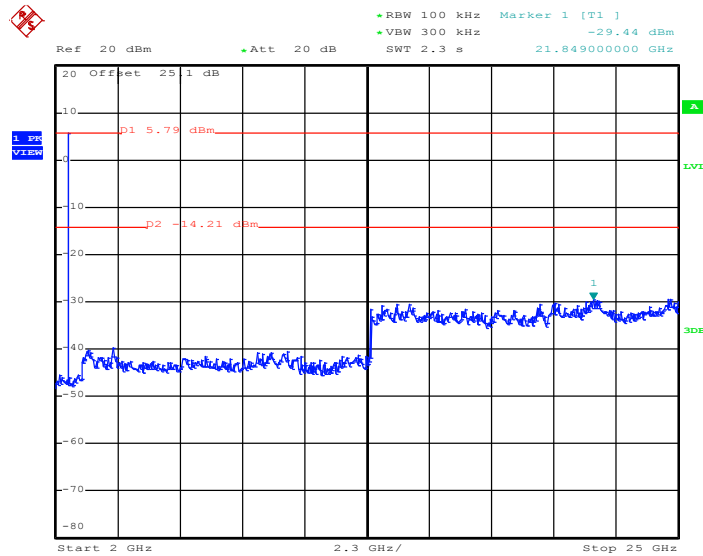

Date: 26.DEC.2017 14:02:33



<3Mbps>

CSE Plot on Ch 00 between 30MHz ~ 3 GHz

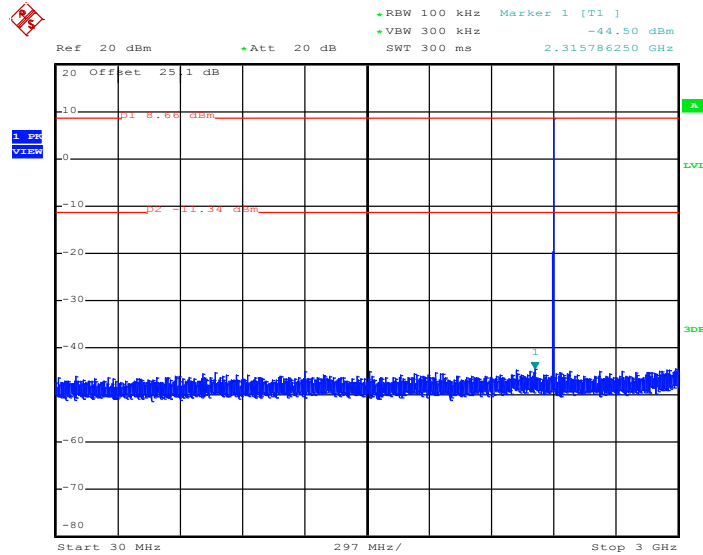

Date: 8.JAN.2018 17:03:54

CSE Plot on Ch 00 between 2 GHz ~ 25 GHz

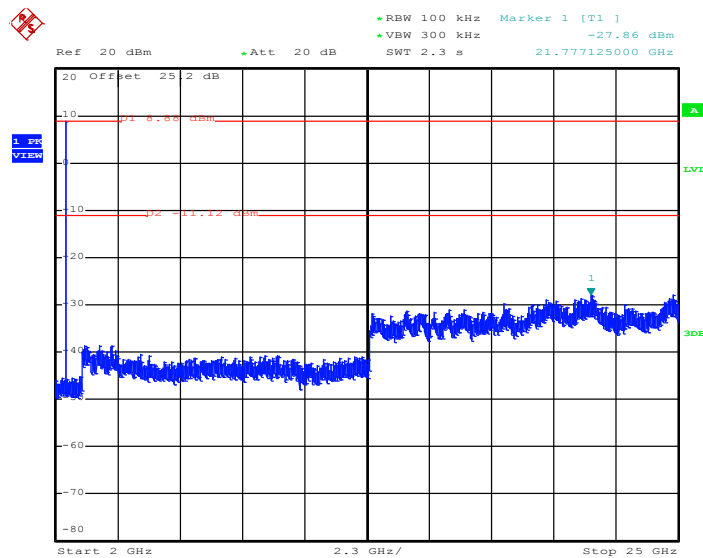

Date: 8.JAN.2018 17:04:17



CSE Plot on Ch 39 between 30MHz ~ 3 GHz

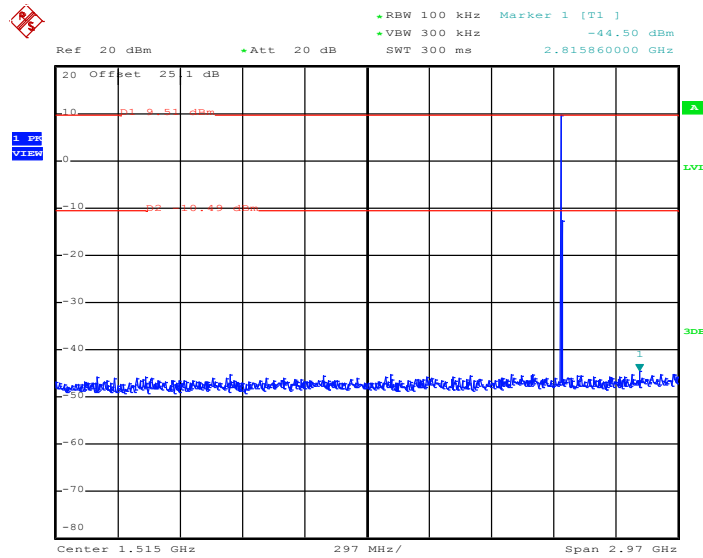

Date: 26.DEC.2017 14:23:56

CSE Plot on Ch 39 between 2 GHz ~ 25 GHz

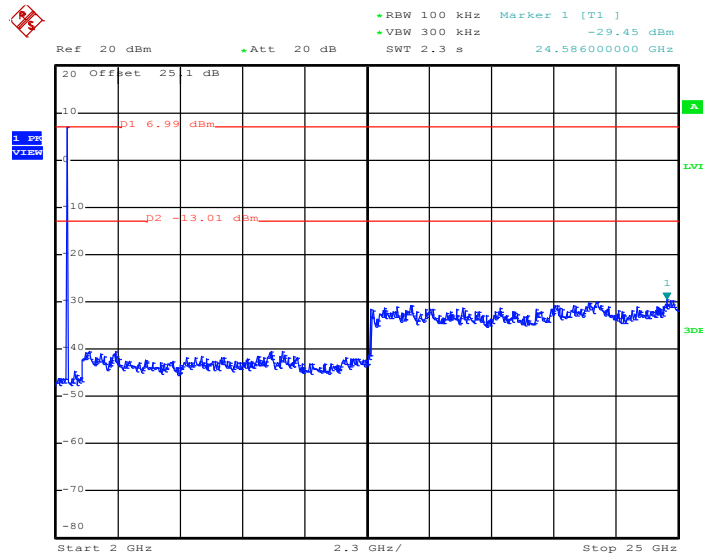

Date: 26.DEC.2017 14:24:18



CSE Plot on Ch 78 between 30MHz ~ 3 GHz

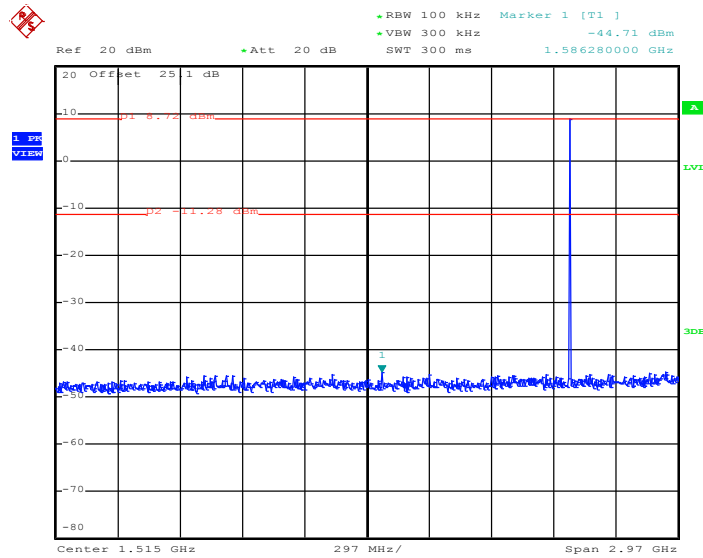

Date: 26.DEC.2017 14:32:22

CSE Plot on Ch 78 between 2 GHz ~ 25 GHz

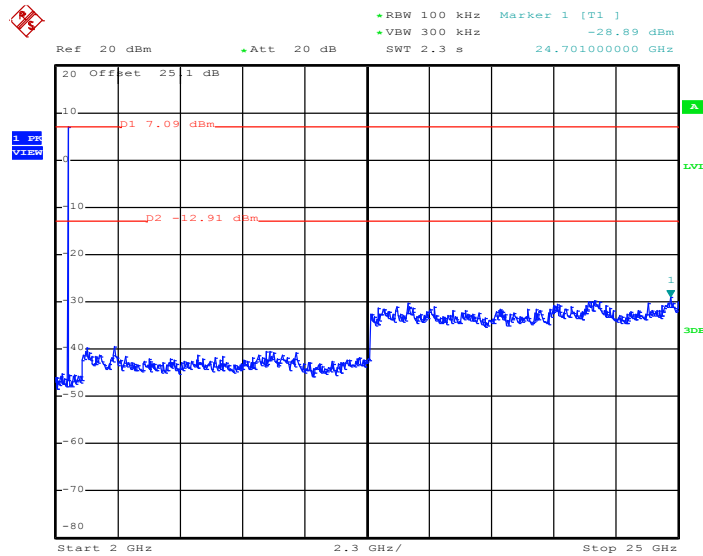

Date: 26.DEC.2017 14:32:44



### 3.8 Radiated Band Edges and Spurious Emission Measurement

#### 3.8.1 Limit of Radiated Band Edges and Spurious Emission

In any 100 kHz bandwidth outside the intentional radiator frequency band, all harmonics/spurious must be at least 20 dB below the highest emission level within the authorized band. In addition, radiated emissions which fall in the restricted bands must also comply with the limits as below.

Frequency (MHz)	Field Strength (microvolts/meter)	Measurement Distance (meters)
0.009 – 0.490	2400/F(kHz)	300
0.490 – 1.705	24000/F(kHz)	30
1.705 – 30.0	30	30
30 – 88	100	3
88 – 216	150	3
216 - 960	200	3
Above 960	500	3

#### 3.8.2 Measuring Instruments

The measuring equipment is listed in the section 4 of this test report.



### 3.8.3 Test Procedures

1. The EUT was placed on a turntable with 0.8 meter for frequency below 1GHz and 1.5 meter for frequency above 1GHz respectively above ground.
2. The EUT was set 3 meters from the interference receiving antenna, which was mounted on the top of a variable height antenna tower.
3. For each suspected emission, the EUT was arranged to its worst case and then tune the Antenna tower (from 1 m to 4 m) and turntable (from 0 degree to 360 degrees) to find the maximum reading. A pre-amp and a high pass filter are used for the test in order to get better signal level to comply with the guidelines.
4. Set to the maximum power setting and enable the EUT transmit continuously.
5. Use the following spectrum analyzer settings:
  - (1) Span shall wide enough to fully capture the emission being measured;
  - (2) Set RBW=100 kHz for  $f < 1 \text{ GHz}$ , RBW=1MHz for  $f > 1\text{GHz}$  ; VBW  $\geq$  RBW; Sweep = auto; Detector function = peak; Trace = max hold for peak
  - (3) For average measurement: use duty cycle correction factor method per 15.35(c).  
Duty cycle = On time/100 milliseconds  
On time =  $N_1 * L_1 + N_2 * L_2 + \dots + N_{n-1} * L_{n-1} + N_n * L_n$   
Where  $N_1$  is number of type 1 pulses,  $L_1$  is length of type 1 pulses, etc.  
Average Emission Level = Peak Emission Level +  $20 * \log(\text{Duty cycle})$
6. Corrected Reading: Antenna Factor + Cable Loss + Read Level - Preamp Factor = Level
7. For testing below 1GHz, if the emission level of the EUT in peak mode was 3 dB lower than the limit specified, then peak values of EUT will be reported, otherwise, the emissions will be repeated one by one using the CISPR quasi-peak method and reported.
8. For testing above 1GHz, the emission level of the EUT in peak mode was 20dB lower than average limit (that means the emission level in average mode also complies with the limit in average mode), then peak values of EUT will be reported, otherwise, the emissions will be measured in average mode again and reported.

Note: The average levels were calculated from the peak level corrected with duty cycle correction factor (-24.76dB) derived from  $20 \log(\text{dwell time}/100\text{ms})$ . This correction is only for signals that hop with the fundamental signal, such as band-edge and harmonic. Other spurious signals that are independent of the hopping signal would not use this correction.

### 3.8.4 Test Setup

For radiated emissions below 30MHz

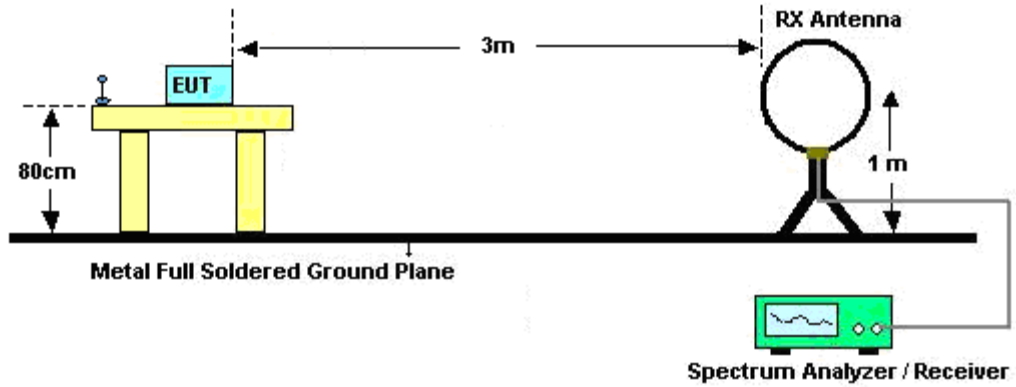

For radiated emissions from 30MHz to 1GHz

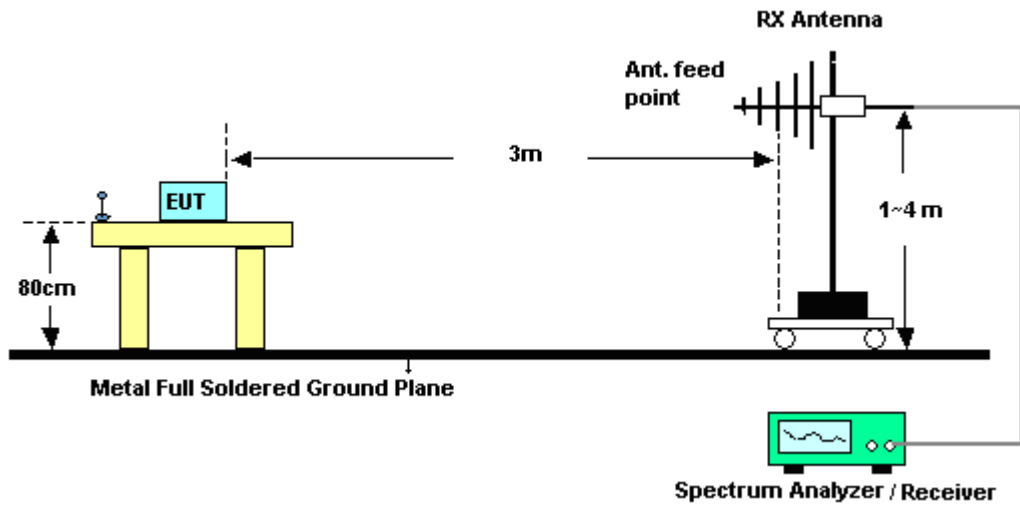

For radiated emissions above 1GHz

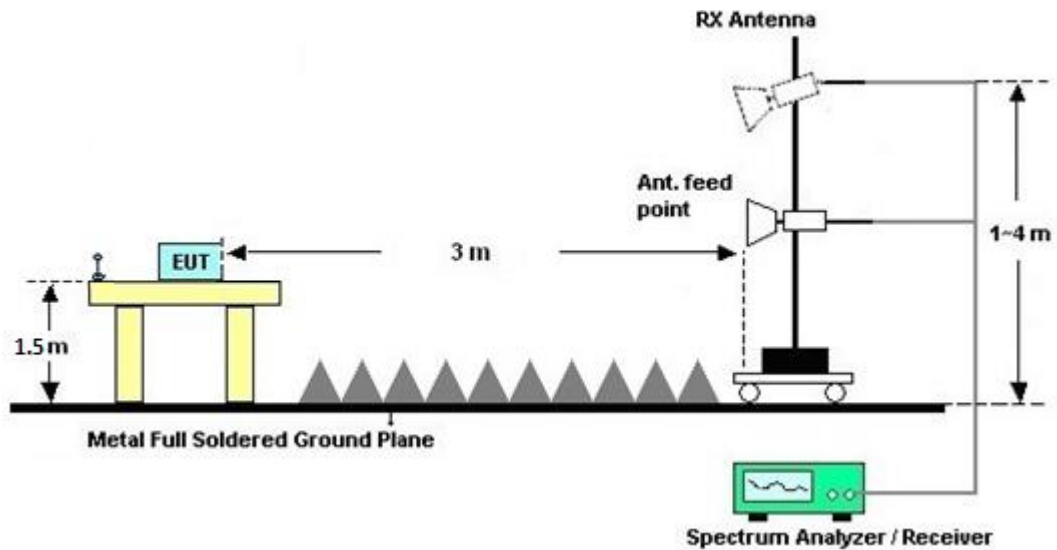

### 3.8.5 Test Results of Radiated Spurious Emissions (9 kHz ~ 30 MHz)

The low frequency, which started from 9 kHz to 30MHz, was pre-scanned and the result which was 20dB lower than the limit line was not reported.

There is a comparison data of both open-field test site and semi-Anechoic chamber, and the result came out very similar.

### 3.8.6 Test Result of Radiated Spurious at Band Edges

Please refer to Appendix C and D.

### 3.8.7 Duty Cycle

Please refer to Appendix E.

### 3.8.8 Test Result of Radiated Spurious Emission (30MHz ~ 10<sup>th</sup> Harmonic)

Please refer to Appendix C and D.



### 3.9 AC Conducted Emission Measurement

#### 3.9.1 Limit of AC Conducted Emission

For equipment that is designed to be connected to the public utility (AC) power line, the radio frequency voltage that is conducted back onto the AC power line on any frequency or frequencies within the band 150 kHz to 30 MHz shall not exceed the limits in the following table.

Frequency of emission (MHz)	Conducted limit (dBµV)	
	Quasi-peak	Average
0.15-0.5	66 to 56*	56 to 46*
0.5-5	56	46
5-30	60	50

\*Decreases with the logarithm of the frequency.

#### 3.9.2 Measuring Instruments

The measuring equipment is listed in the section 4 of this test report.

#### 3.9.3 Test Procedures

1. The EUT was placed 0.4 meter from the conducting wall of the shielding room was kept at least 80 centimeters from any other grounded conducting surface.
2. Connect EUT to the power mains through a line impedance stabilization network (LISN).
3. All the support units are connecting to the other LISN.
4. The LISN provides 50 ohm coupling impedance for the measuring instrument.
5. The FCC states that a 50 ohm, 50 microhenry LISN should be used.
6. Both sides of AC line were checked for maximum conducted interference.
7. The frequency range from 150 kHz to 30 MHz was searched.
8. Set the test-receiver system to Peak Detect Function and specified bandwidth (IF Bandwidth = 9kHz) with Maximum Hold Mode. Then measurement is also conducted by Average Detector and Quasi-Peak Detector Function respectively.

### 3.9.4 Test Setup

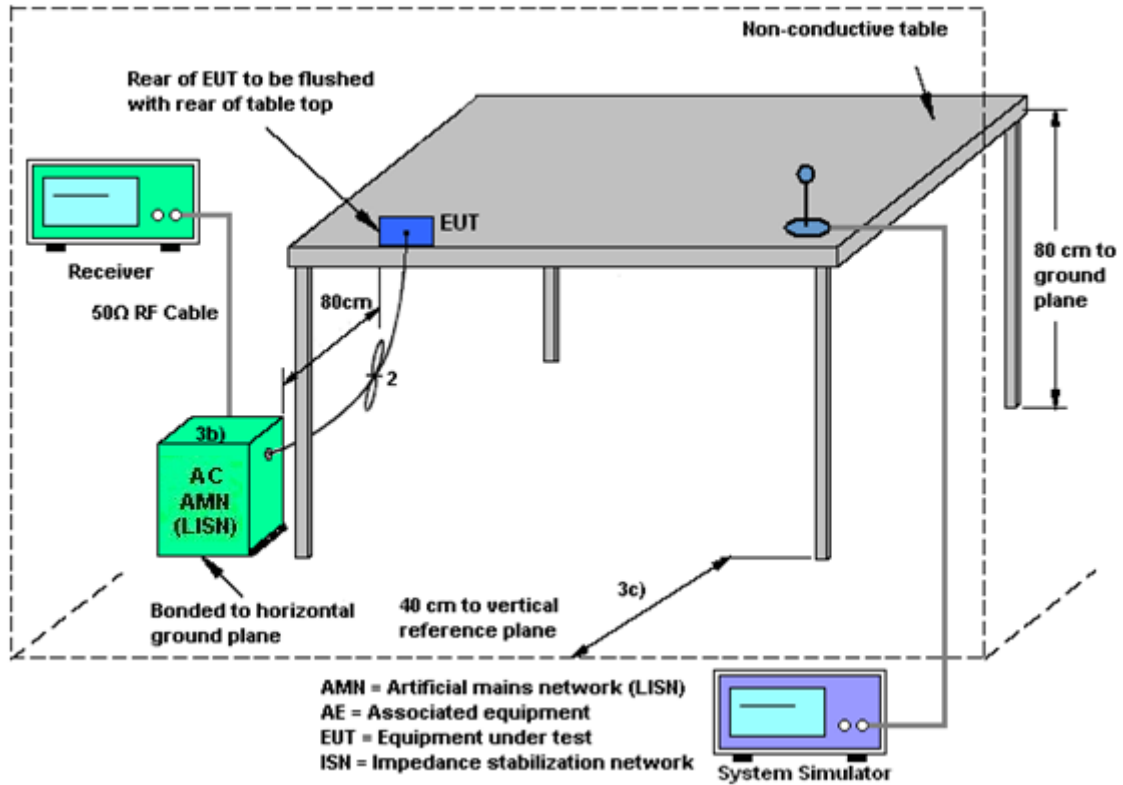

### 3.9.5 Test Result of AC Conducted Emission

Please refer to Appendix B.



## **3.10 Antenna Requirements**

### **3.10.1 Standard Applicable**

If directional gain of transmitting antennas is greater than 6dBi, the power shall be reduced by the same level in dB comparing to gain minus 6dBi. The use of a permanently attached antenna or of an antenna that uses a unique coupling to the intentional radiator shall be considered sufficient to comply with the rule.

### **3.10.2 Antenna Anti-Replacement Construction**

An embedded-in antenna design is used.

### **3.10.3 Antenna Gain**

The antenna peak gain of EUT is less than 6 dBi. Therefore, it is not necessary to reduce maximum peak output power limit.



## 4 List of Measuring Equipment

Instrument	Manufacturer	Model No.	Serial No.	Characteristics	Calibration Date	Test Date	Due Date	Remark
Power Meter	Agilent	E4416A	GB412923 44	N/A	Dec. 26, 2016	Dec. 21, 2017 ~ Dec. 24, 2017	Dec. 25, 2017	Conducted (TH05-HY)
Power Meter	Agilent	E4416A	GB412923 44	N/A	Dec. 25, 2017	Dec. 25, 2017 ~ Jan. 08, 2018	Dec. 24, 2018	Conducted (TH05-HY)
Power Sensor	Agilent	E9327A	US404415 48	50MHz~18GHz	Dec. 26, 2016	Dec. 21, 2017 ~ Dec. 24, 2017	Dec. 25, 2017	Conducted (TH05-HY)
Power Sensor	Agilent	E9327A	US404415 48	50MHz~18GHz	Dec. 25, 2017	Dec. 25, 2017 ~ Jan. 08, 2018	Dec. 24, 2018	Conducted (TH05-HY)
Spectrum Analyzer	Rohde & Schwarz	FSP40	100055	9kHz~40GHz	Jun. 20, 2017	Dec. 21, 2017 ~ Jan. 08, 2018	Jun. 19, 2018	Conducted (TH05-HY)
AC Power Source	ChainTek	APC-1000W	N/A	N/A	N/A	Dec. 29, 2017	N/A	Conduction (CO05-HY)
EMI Test Receiver	Rohde & Schwarz	ESCI 7	100724	9kHz~7GHz	Sep. 20, 2017	Dec. 29, 2017	Sep. 19, 2018	Conduction (CO05-HY)
LISN	Rohde & Schwarz	ENV216	100080	9kHz~30MHz	Nov. 30, 2017	Dec. 29, 2017	Nov. 29, 2018	Conduction (CO05-HY)
Loop Antenna	Rohde & Schwarz	HFH2-Z2	100315	9 kHz~30 MHz	May 15, 2017	Dec. 30, 2017~ Jan. 03, 2018	May 14, 2019	Radiation (03CH13-HY)
Amplifier	MITEQ	TTA1840-35- HG	1871923	18GHz~40GHz, VSWR : 2.5:1 max	Jul. 18, 2017	Dec. 30, 2017~ Jan. 03, 2018	Jul. 17, 2018	Radiation (03CH13-HY)
Amplifier	Sonoma-Instrument	310 N	187282	9KHz~1GHz	Dec. 21, 2016	Dec. 30, 2017~ Jan. 03, 2018	Dec. 20, 2018	Radiation (03CH13-HY)
Bilog Antenna	TESEQ	CBL 6111D&0080 0N1D01N-06	40103&04	30MHz to 1GHz	Jan. 07, 2017	Dec. 30, 2017~ Jan. 03, 2018	Jan. 06, 2018	Radiation (03CH13-HY)
Horn Antenna	SCHWARZBE CK	BBHA 9120 D	9120D-124 1	1GHz ~ 18GHz	Jun. 15, 2017	Dec. 30, 2017~ Jan. 03, 2018	Jun. 14, 2018	Radiation (03CH13-HY)
Preamplifier	MITEQ	AMF-7D-001 01800-30-10 P	1590074	1GHz~18GHz	May 22, 2017	Dec. 30, 2017~ Jan. 03, 2018	May 21, 2018	Radiation (03CH13-HY)
Preamplifier	Keysight	83017A	MY532701 47	1GHz~26.5GHz	Jan. 09, 2017	Dec. 30, 2017~ Jan. 03, 2018	Jan. 08, 2018	Radiation (03CH13-HY)
Spectrum Analyzer	Keysight	N9010A	MY553705 26	N/A	Mar. 15, 2017	Dec. 30, 2017~ Jan. 03, 2018	Mar. 14, 2018	Radiation (03CH13-HY)
Antenna Mast	EMEC	AM-BS-4500 -B	N/A	1m~4m	N/A	Dec. 30, 2017~ Jan. 03, 2018	N/A	Radiation (03CH13-HY)
Turn Table	EMEC	TT2000	N/A	0~360 Degree	N/A	Dec. 30, 2017~ Jan. 03, 2018	N/A	Radiation (03CH13-HY)
SHF-EHF Horn Antenna	SCHWARZBE CK	BBHA 9170	BBHA9170 576	18GHz ~ 40GHz	Apr. 27, 2017	Dec. 30, 2017~ Jan. 03, 2018	Apr. 26, 2018	Radiation (03CH13-HY)
EMI Test Receiver	Agilent	N9038A (MXE)	MY532900 53	20Hz to 26.5GHz	Jan. 12, 2017	Dec. 30, 2017~ Jan. 03, 2018	Jan. 11, 2018	Radiation (03CH13-HY)



## 5 Uncertainty of Evaluation

### Uncertainty of Conducted Emission Measurement (150 kHz ~ 30 MHz)

Measuring Uncertainty for a Level of Confidence of 95% ( $U = 2Uc(y)$ )	2.70
---	------

### Uncertainty of Radiated Emission Measurement (30 MHz ~ 1000 MHz)

Measuring Uncertainty for a Level of Confidence of 95% ( $U = 2Uc(y)$ )	4.90
---	------

### Uncertainty of Radiated Emission Measurement (1000 MHz ~ 18000 MHz)

Measuring Uncertainty for a Level of Confidence of 95% ( $U = 2Uc(y)$ )	5.40
---	------

### Uncertainty of Radiated Emission Measurement (18000 MHz ~ 40000 MHz)

Measuring Uncertainty for a Level of Confidence of 95% ( $U = 2Uc(y)$ )	4.30
---	------

## Appendix A. Test Result of Conducted Test Items

Test Engineer:	Allen Lin	Temperature:	21~25	°C
Test Date:	2017/12/21~2017/01/08	Relative Humidity:	51~54	%

**TEST RESULTS DATA****20dB and 99% Occupied Bandwidth and Hopping Channel Separation**

Mod.	Data Rate	NTX	CH.	Freq. (MHz)	20db BW (MHz)	99% Bandwidth (MHz)	Hopping Channel Separation Measurement (MHz)	Hopping Channel Separation Measurement Limit (MHz)	Pass/Fail
DH	1Mbps	1	0	2402	0.936	0.884	1.014	0.6240	Pass
DH	1Mbps	1	39	2441	0.904	0.880	1.320	0.6027	Pass
DH	1Mbps	1	78	2480	0.908	0.876	1.008	0.6053	Pass
2DH	2Mbps	1	0	2402	1.290	1.168	1.002	0.8600	Pass
2DH	2Mbps	1	39	2441	1.290	1.172	1.002	0.8600	Pass
2DH	2Mbps	1	78	2480	1.284	1.168	1.008	0.8560	Pass
3DH	3Mbps	1	0	2402	1.236	1.152	1.008	0.8240	Pass
3DH	3Mbps	1	39	2441	1.236	1.152	1.314	0.8240	Pass
3DH	3Mbps	1	78	2480	1.236	1.148	1.314	0.8240	Pass

**TEST RESULTS DATA****Dwell Time**

Mod.	Hopping Channel Number Rate	Hops Over Occupancy Time(hops)	Package Transfer Time (msec)	Dwell Time (sec)	Limits (sec)	Pass/Fail
Nomal	79	106.67	2.90	0.31	0.4	Pass
AFH	20	53.33	2.90	0.15	0.4	Pass

**TEST RESULTS DATA****Peak Power Table**

DH	CH.	NTX	Peak Power (dBm)	Power Limit (dBm)	Test Result
DH1	0	1	11.88	20.97	Pass
	39	1	11.41	20.97	Pass
	78	1	11.10	20.97	Pass
2DH1	0	1	11.93	20.97	Pass
	39	1	11.45	20.97	Pass
	78	1	11.15	20.97	Pass
3DH1	0	1	12.22	20.97	Pass
	39	1	11.73	20.97	Pass
	78	1	11.43	20.97	Pass

**TEST RESULTS DATA****Average Power Table  
(Reporting Only)**

DH	CH.	NTX	Average Power (dBm)	Duty Factor (dB)
DH1	0	1	11.82	5.16
	39	1	11.36	5.16
	78	1	11.01	5.16
2DH1	0	1	9.95	5.12
	39	1	9.52	5.12
	78	1	9.12	5.12
3DH1	0	1	9.96	5.12
	39	1	9.53	5.12
	78	1	9.14	5.12

**TEST RESULTS DATA****Number of Hopping Frequency**

Number of Hopping (Channel)	Adaptive Frequency Hopping (Channel)	Limits (Channel)	Pass/Fail
79	20	> 15	Pass



## Appendix B. AC Conducted Emission Test Results

Test Engineer :	Blue Lan	Temperature :	24~26°C
		Relative Humidity :	63~65%

# EUT Information

Report NO : 7D2018  
 Test Mode : Mode 1  
 Test Voltage : 120Vac/60Hz  
 Phase : Line

ENV216 Auto Test FCC Power Bar - L

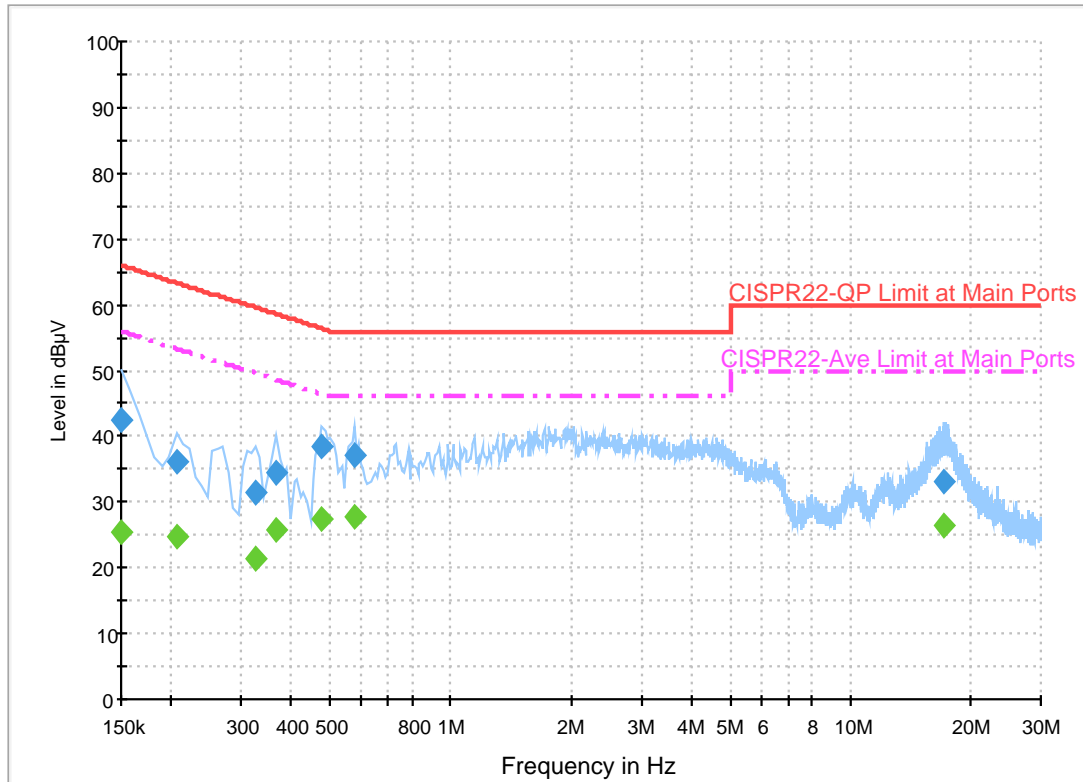

## Final Result 1

Frequency (MHz)	QuasiPeak (dBµV)	Filter	Line	Corr. (dB)	Margin (dB)	Limit (dBµV)
0.150000	42.6	Off	L1	19.5	23.4	66.0
0.206000	36.1	Off	L1	19.5	27.3	63.4
0.326000	31.5	Off	L1	19.5	28.1	59.6
0.366000	34.4	Off	L1	19.5	24.2	58.6
0.478000	38.3	Off	L1	19.5	18.1	56.4
0.574000	37.0	Off	L1	19.5	19.0	56.0
17.086000	33.2	Off	L1	19.7	26.8	60.0

## Final Result 2

Frequency (MHz)	Average (dBµV)	Filter	Line	Corr. (dB)	Margin (dB)	Limit (dBµV)
0.150000	25.5	Off	L1	19.5	30.5	56.0
0.206000	24.8	Off	L1	19.5	28.6	53.4
0.326000	21.6	Off	L1	19.5	28.0	49.6
0.366000	25.7	Off	L1	19.5	22.9	48.6
0.478000	27.6	Off	L1	19.5	18.8	46.4
0.574000	27.7	Off	L1	19.5	18.3	46.0
17.086000	26.6	Off	L1	19.7	23.4	50.0

# EUT Information

Report NO : 7D2018  
 Test Mode : Mode 1  
 Test Voltage : 120Vac/60Hz  
 Phase : Neutral

ENV216 Auto Test FCC Power Bar - N

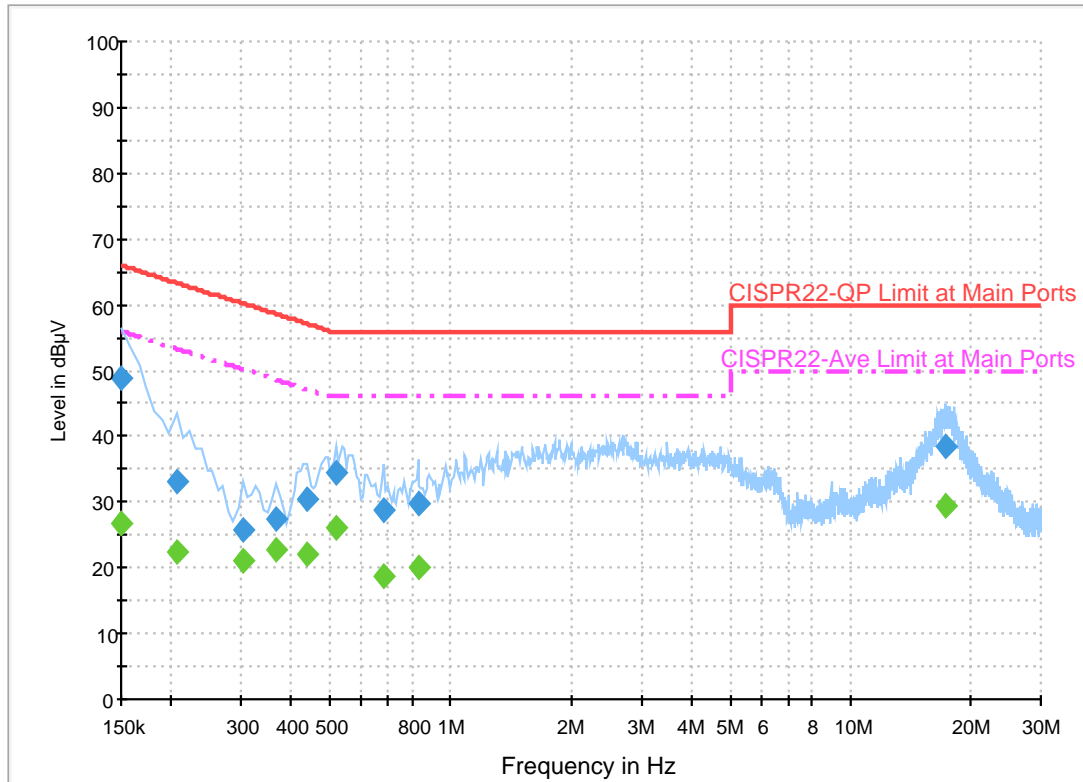

## Final Result 1

Frequency (MHz)	QuasiPeak (dBµV)	Filter	Line	Corr. (dB)	Margin (dB)	Limit (dBµV)
0.150000	49.0	Off	N	19.5	17.0	66.0
0.206000	33.0	Off	N	19.5	30.4	63.4
0.302000	25.6	Off	N	19.5	34.6	60.2
0.366000	27.5	Off	N	19.5	31.1	58.6
0.438000	30.5	Off	N	19.5	26.6	57.1
0.518000	34.4	Off	N	19.5	21.6	56.0
0.678000	28.8	Off	N	19.5	27.2	56.0
0.830000	29.9	Off	N	19.5	26.1	56.0
17.302000	38.3	Off	N	19.8	21.7	60.0

## Final Result 2

Frequency (MHz)	Average (dBµV)	Filter	Line	Corr. (dB)	Margin (dB)	Limit (dBµV)
0.150000	26.7	Off	N	19.5	29.3	56.0
0.206000	22.6	Off	N	19.5	30.8	53.4
0.302000	20.9	Off	N	19.5	29.3	50.2
0.366000	22.6	Off	N	19.5	26.0	48.6
0.438000	22.2	Off	N	19.5	24.9	47.1
0.518000	26.0	Off	N	19.5	20.0	46.0
0.678000	18.7	Off	N	19.5	27.3	46.0
0.830000	20.1	Off	N	19.5	25.9	46.0
17.302000	29.5	Off	N	19.8	20.5	50.0



## Appendix D. Radiated Spurious Emission Plots

Test Engineer :	Alex Jheng, Bill Chang, and Wilson Wu	Temperature :	24.9~25.3°C
		Relative Humidity :	46~50%

### Note symbol

-L	Low channel location
-R	High channel location



2.4GHz 2400~2483.5MHz

BT (Band Edge @ 3m)

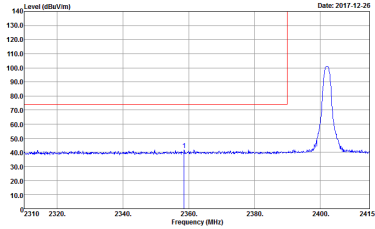
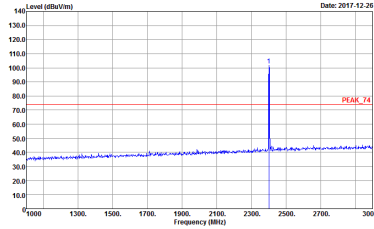
BT	2.4GHz 2400~2483.5MHz Band Edge @ 3m	
ANT	BT CH00 2402MHz	
1	Horizontal	Fundamental
Peak	 <p>Date: 2017-12-26</p> <p>Site : 03CH13-HY  Condition : PEAK_BE_74 3m HORN_9120D_1241 HORIZONTAL  : RBW:1000.000KHz VBW:3000.000KHz SWT:Auto  Detector : Peak  Project : 7D2018  Mode : 1</p>	 <p>Date: 2017-12-26</p> <p>Site : 03CH13-HY  Condition : PEAK_74 3m HORN_9120D_1241 HORIZONTAL  : RBW:1000.000KHz VBW:3000.000KHz SWT:Auto  Detector : Peak  Project : 7D2018  Mode : 1</p>

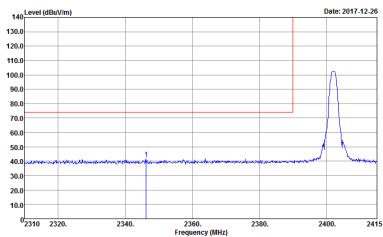
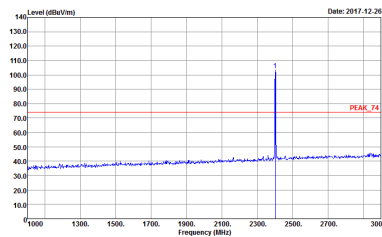

BT	2.4GHz 2400~2483.5MHz Band Edge @ 3m	
ANT	BT CH00 2402MHz	
1	Vertical	Fundamental
Peak	 <p>Site : 03CH13-11Y          Condition : PEAK_BE_74 3m HORN_91200_1241 VERTICAL          Detector : Peak          Project : 7D2018          Mode : 1</p>	 <p>Site : 03CH13-11Y          Condition : PEAK_74 3m HORN_91200_1241 VERTICAL          Detector : Peak          Project : 7D2018          Mode : 1</p>



BT	2.4GHz 2400~2483.5MHz Band Edge @ 3m	
ANT	BT CH39 2441MHz	
1	Horizontal	Fundamental
<p><b>Peak</b></p>	<p>Site : 03CH13-HY            Condition : PEAK_BE_74 3m HORN_91200_1241 HORIZONTAL            : RBW:1000.000KHz VBW:3000.000KHz SWT:Auto            Detector : Peak            Project : 7D2018            Mode : Z</p>	<p>Site : 03CH13-HY            Condition : PEAK_74 3m HORN_91200_1241 HORIZONTAL            : RBW:1000.000KHz VBW:3000.000KHz SWT:Auto            Detector : Peak            Project : 7D2018            Mode : Z</p>
<p><b>Peak</b></p>	<p>Site : 03CH13-HY            Condition : PEAK_BE_74 3m HORN_91200_1241 HORIZONTAL            : RBW:1000.000KHz VBW:3000.000KHz SWT:Auto            Detector : Peak            Project : 7D2018            Mode : Z</p>	<p>Left blank</p>



BT	2.4GHz 2400~2483.5MHz Band Edge @ 3m	
ANT	BT CH39 2441MHz	
1	Vertical	Fundamental
Peak	<p>Site : 03CH13-HY            Condition : PEAK_BE_74 3m HORN_91200_1241 VERTICAL            : RBW:1000.000KHz VBW:3000.000KHz SWT:Auto            Detector : Peak            Project : 7D2018            Mode : Z</p>	<p>Site : 03CH13-HY            Condition : PEAK_74 3m HORN_91200_1241 VERTICAL            : RBW:1000.000KHz VBW:3000.000KHz SWT:Auto            Detector : Peak            Project : 7D2018            Mode : Z</p>
Peak	<p>Site : 03CH13-HY            Condition : PEAK_BE_74 3m HORN_91200_1241 VERTICAL            : RBW:1000.000KHz VBW:3000.000KHz SWT:Auto            Detector : Peak            Project : 7D2018            Mode : Z</p>	Left blank

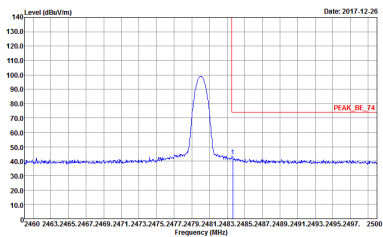
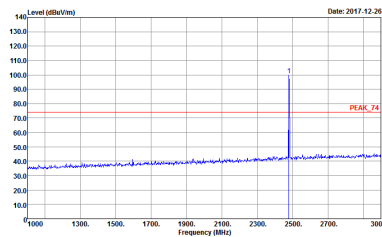

BT	2.4GHz 2400~2483.5MHz Band Edge @ 3m	
ANT	BT CH78 2480MHz	
1	Horizontal	Fundamental
Peak	 <p>Site : 03CH13-11Y  Condition : PEAK_BE_74 3m HORN_9120D_1241 HORIZONTAL  : RBW:1000.000KHz VBW:3000.000KHz SWT:Auto  Detector : Peak  Project : 7D2018  Mode : 3</p>	 <p>Site : 03CH13-11Y  Condition : PEAK_74 3m HORN_9120D_1241 HORIZONTAL  : RBW:1000.000KHz VBW:3000.000KHz SWT:Auto  Detector : Peak  Project : 7D2018  Mode : 3</p>

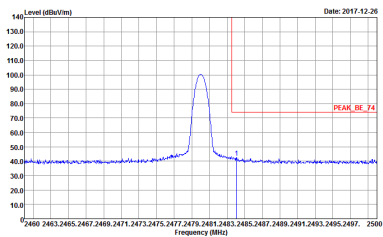
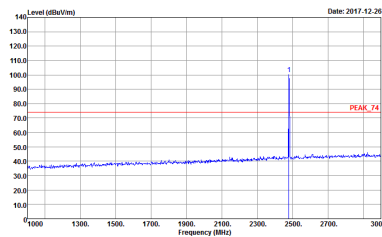

BT	2.4GHz 2400~2483.5MHz Band Edge @ 3m	
ANT	BT CH78 2480MHz	
1	Vertical	Fundamental
Peak	 <p>Site : 03CH13-11Y          Condition : PEAK_BE_74 3m HORN_9120D_1241 VERTICAL          : RBW:1000.000KHz VBW:3000.000KHz SWT:Auto          Detector : Peak          Project : 7D2018          Mode : 3</p>	 <p>Site : 03CH13-11Y          Condition : PEAK_74 3m HORN_9120D_1241 VERTICAL          : RBW:1000.000KHz VBW:3000.000KHz SWT:Auto          Detector : Peak          Project : 7D2018          Mode : 3</p>



2.4GHz 2400~2483.5MHz

BT (Harmonic @ 3m)

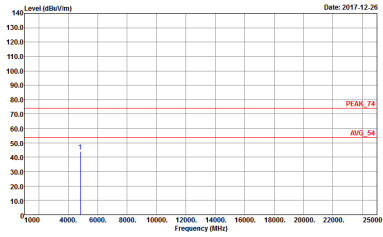
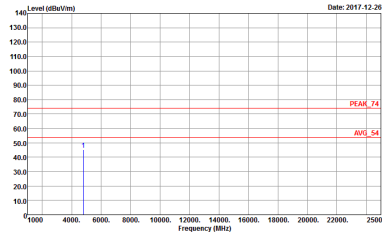
BT	2.4GHz 2400~2483.5MHz Harmonic @ 3m	
ANT	BT CH00 2402MHz	
1	Horizontal	Vertical
<p>Peak</p> <p>Avg.</p>	 <p>Site : 03CH13-HY          Condition : PEAK_74 3m SHF_HORN_576 HORIZONTAL          Detector : Peak          Project : 7D2018          Mode : 1</p>	 <p>Site : 03CH13-HY          Condition : PEAK_74 3m SHF_HORN_576 VERTICAL          Detector : Peak          Project : 7D2018          Mode : 1</p>



BT	2.4GHz 2400~2483.5MHz Harmonic @ 3m	
ANT	BT CH39 2441MHz	
1	Horizontal	Vertical
<p>Peak</p> <p>Avg.</p>	<p>Site : 03CH13-11Y          Condition : PEAK_74 3m SHF_HORN_576 HORIZONTAL          Detector : Peak          Project : 7D2018          Mode : -2</p>	<p>Site : 03CH13-11Y          Condition : PEAK_74 3m SHF_HORN_576 VERTICAL          Detector : Peak          Project : 7D2018          Mode : -2</p>



<b>BT</b>	<b>2.4GHz 2400~2483.5MHz Harmonic @ 3m</b>	
<b>ANT</b>	<b>BT CH78 2480MHz</b>	
<b>1</b>	<b>Horizontal</b>	<b>Vertical</b>
<b>Peak</b> <b>Avg.</b>	<p>Site : 03CHE3-11Y Condition : PEAK_74 3m SHF_HORN_576 HORIZONTAL Detector : Peak Project : 7D2018 Mode : 3</p>	<p>Site : 03CHE3-11Y Condition : PEAK_74 3m SHF_HORN_576 VERTICAL Detector : Peak Project : 7D2018 Mode : 3</p>



Emission below 1GHz

2.4GHz BT (LF)

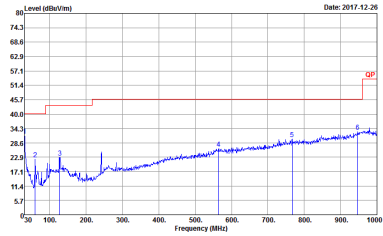
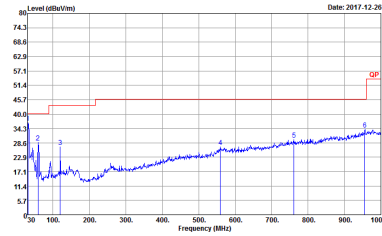
<b>BT</b>	<b>2.4GHz 2400~2483.5MHz</b>	
<b>ANT</b>	<b>BT LF</b>	
<b>1</b>	<b>Horizontal</b>	<b>Vertical</b>
<b>QP / Peak</b>	 <p>Site : 03CH13-HY  Condition : QP 3m BIL06_35414 HORIZONTAL  Detector : Peak  Project : 7D2018  Mode : 4</p>	 <p>Site : 03CH13-HY  Condition : QP 3m BIL06_35414 VERTICAL  Detector : Peak  Project : 7D2018  Mode : 4</p>



## Appendix C. Radiated Spurious Emission

Test Engineer :	Alex Jheng, Bill Chang, and Wilson Wu	Temperature :	24.9~25.3°C
		Relative Humidity :	46~50%

### 2.4GHz 2400~2483.5MHz

#### BT (Band Edge @ 3m)

BT	Note	Frequency	Level	Over	Limit	Read	Antenna	Cable	Preamp	Ant	Table	Peak	Pol.	
		( MHz )	( dBμV/m )	( dB )	( dBμV/m )	( dBμV )	( dB/m )	( dB )	( dB )	( cm )	( deg )	( P/A )	( H/V )	
BT CH00 2402MHz		2358.615	41.73	-32.27	74	41.14	26.79	4.8	31	107	228	P	H	
		2358.615	16.97	-37.03	54	-	-	-	-	-	-	A	H	
	*	2402	101.75	-	-	101	26.89	4.85	30.99	107	228	P	H	
	*	2402	76.99	-	-	-	-	-	-	-	-	A	H	
													H	
														H
			2346.225	41.67	-32.33	74	41.16	26.73	4.78	31	123	236	P	V
			2346.225	16.91	-37.09	54	-	-	-	-	-	-	A	V
	*		2402	103.15	-	-	102.4	26.89	4.85	30.99	123	236	P	V
	*		2402	78.39	-	-	-	-	-	-	-	-	A	V
														V
														V
BT CH 39 2441MHz		2322.46	41.05	-32.95	74	40.62	26.68	4.76	31.01	101	229	P	H	
		2322.46	16.29	-37.71	54	-	-	-	-	-	-	A	H	
	*	2441	101.76	-	-	100.81	27.04	4.88	30.97	101	229	P	H	
	*	2441	77	-	-	-	-	-	-	-	-	A	H	
			2488.52	42.22	-31.78	74	41.05	27.2	4.93	30.96	101	229	P	H
			2488.52	17.46	-36.54	54	-	-	-	-	-	-	A	H
			2335.06	41.29	-32.71	74	40.81	26.73	4.76	31.01	125	239	P	V
			2335.06	16.53	-37.47	54	-	-	-	-	-	-	A	V
	*		2441	103.14	-	-	102.19	27.04	4.88	30.97	125	239	P	V
	*		2441	78.38	-	-	-	-	-	-	-	-	A	V
			2486.28	42.5	-31.5	74	41.39	27.15	4.93	30.97	125	239	P	V
			2486.28	17.74	-36.26	54	-	-	-	-	-	-	A	V



<b>BT CH 78 2480MHz</b>	*	2480	99.95	-	-	98.85	27.15	4.92	30.97	105	224	P	H
	*	2480	75.19	-	-	-	-	-	-	-	-	A	H
		2483.64	43.3	-30.7	74	42.19	27.15	4.93	30.97	105	224	P	H
		2483.64	18.54	-35.46	54	-	-	-	-	-	-	A	H
													H
													H
	*	2480	100.75	-	-	99.65	27.15	4.92	30.97	122	238	P	V
	*	2480	75.99	-	-	-	-	-	-	-	-	A	V
		2484.04	42.65	-31.35	74	41.54	27.15	4.93	30.97	122	238	P	V
		2484.04	17.89	-36.11	54	-	-	-	-	-	-	A	V
													V
													V
<b>Remark</b>	1. No other spurious found. 2. All results are PASS against Peak and Average limit line.												



**2.4GHz 2400~2483.5MHz  
BT (Harmonic @ 3m)**

BT	Note	Frequency ( MHz )	Level ( dBμV/m )	Over Limit ( dB )	Limit Line ( dBμV/m )	Read Level ( dBμV )	Antenna Factor ( dB/m )	Cable Loss ( dB )	Preamp Factor ( dB )	Ant Pos ( cm )	Table Pos ( deg )	Peak Avg. (P/A)	Pol. (H/V)	
BT CH 00 2402MHz		4804	44.03	-29.97	74	61.95	31.53	7.3	57.27	100	0	P	H	
		4804	19.27	-34.73	54	-	-	-	-	-	-	A	H	
													H	
													H	
		4804	45.27	-28.73	74	63.19	31.53	7.3	57.27	100	0	P	V	
		4804	20.51	-33.49	54	-	-	-	-	-	-	-	A	V
														V
														V
BT CH 39 2441MHz		4882	42.88	-31.12	74	60.48	31.63	7.44	57.17	100	0	P	H	
		4882	18.12	-35.88	54	-	-	-	-	-	-	A	H	
		7323	43.65	-30.35	74	55.15	36.19	9.14	57.29	100	0	P	H	
		7323	18.89	-35.11	54	-	-	-	-	-	-	A	H	
		4882	43.99	-30.01	74	61.59	31.63	7.44	57.17	100	0	P	V	
		4882	19.23	-34.77	54	-	-	-	-	-	-	A	V	
		7323	43.07	-30.93	74	54.57	36.19	9.14	57.29	100	0	P	V	
		7323	18.31	-35.69	54	-	-	-	-	-	-	A	V	
BT CH 78 2480MHz		4960	42.18	-31.82	74	59.4	31.75	7.59	57.05	100	0	P	H	
		4960	17.42	-36.58	54	-	-	-	-	-	-	A	H	
		7440	43.29	-30.71	74	54.65	36.41	9.21	57.44	100	0	P	H	
		7440	18.53	-35.47	54	-	-	-	-	-	-	A	H	
		4960	43.1	-30.9	74	60.32	31.75	7.59	57.05	100	0	P	V	
		4960	18.34	-35.66	54	-	-	-	-	-	-	A	V	
		7440	42.69	-31.31	74	54.05	36.41	9.21	57.44	100	0	P	V	
		7440	17.93	-36.07	54	-	-	-	-	-	-	A	V	
Remark	1. No other spurious found. 2. All results are PASS against Peak and Average limit line.													



Emission below 1GHz

2.4GHz BT (LF)

BT	Note	Frequency	Level	Over	Limit	Read	Antenna	Cable	Preamp	Ant	Table	Peak	Pol.	
		( MHz )	( dBμV/m )	( dB )	( dBμV/m )	( dBμV )	( dB/m )	( dB )	( dB )	( cm )	( deg )	( P/A )	( H/V )	
2.4GHz BT LF		30	31.49	-8.51	40	39.09	24.17	0.59	32.34	100	0	P	H	
		59.97	21.98	-18.02	40	41.97	11.5	0.84	32.31	-	-	P	H	
		127.47	22.66	-20.84	43.5	36.53	17.27	1.09	32.28	-	-	P	H	
		563.9	26.21	-19.79	46	30.01	25.95	2.36	32.21	-	-	P	H	
		766.9	29.98	-16.02	46	31.27	27.94	2.71	32.05	-	-	P	H	
		946.1	32.96	-13.04	46	30.49	30.36	3.06	31.09	-	-	P	H	
													H	
													H	
													H	
													H	
													H	
													H	
			31.35	36.57	-3.43	40	44.64	23.7	0.59	32.34	100	0	P	V
			59.16	28.69	-11.31	40	48.51	11.65	0.84	32.31	-	-	P	V
			119.91	26.85	-16.65	43.5	40.66	17.33	1.09	32.29	-	-	P	V
			559.7	26.92	-19.08	46	30.63	26.07	2.33	32.21	-	-	P	V
			761.3	29.79	-16.21	46	31.13	27.91	2.71	32.06	-	-	P	V
			955.9	33.88	-12.12	46	30.75	30.92	3.07	31	-	-	P	V
														V
														V
													V	
													V	
													V	
													V	
Remark	1. No other spurious found. 2. All results are PASS against limit line.													



Note symbol

*	<b>Fundamental Frequency</b> which can be ignored. However, the level of any unwanted emissions shall not exceed the level of the fundamental frequency.
!	Test result is <b>over limit</b> line.
P/A	<b>Peak</b> or <b>Average</b>
H/V	<b>Horizontal</b> or <b>Vertical</b>



A calculation example for radiated spurious emission is shown as below:

WIFI	Note	Frequency	Level	Over	Limit	Read	Antenna	Cable	Preamp	Ant	Table	Peak	Pol.
Ant.				Limit	Line	Level	Factor	Loss	Factor	Pos	Pos	Avg.	
1+2		( MHz )	( dBμV/m )	( dB )	( dBμV/m )	( dBμV )	( dB/m )	( dB )	( dB )	( cm )	( deg )	( P/A )	( H/V )
802.11b		2390	55.45	-18.55	74	54.51	32.22	4.58	35.86	103	308	P	H
CH 01													
2412MHz		2390	43.54	-10.46	54	42.6	32.22	4.58	35.86	103	308	A	H

- Level(dBμV/m) =  
Antenna Factor(dB/m) + Cable Loss(dB) + Read Level(dBμV) - Preamp Factor(dB)
- Over Limit(dB) = Level(dBμV/m) – Limit Line(dBμV/m)

**For Peak Limit @ 2390MHz:**

- Level(dBμV/m)  
= Antenna Factor(dB/m) + Cable Loss(dB) + Read Level(dBμV) - Preamp Factor(dB)  
= 32.22(dB/m) + 4.58(dB) + 54.51(dBμV) – 35.86 (dB)  
= 55.45 (dBμV/m)
- Over Limit(dB)  
= Level(dBμV/m) – Limit Line(dBμV/m)  
= 55.45(dBμV/m) – 74(dBμV/m)  
= -18.55(dB)

**For Average Limit @ 2390MHz:**

- Level(dBμV/m)  
= Antenna Factor(dB/m) + Cable Loss(dB) + Read Level(dBμV) - Preamp Factor(dB)  
= 32.22(dB/m) + 4.58(dB) + 42.6(dBμV) – 35.86 (dB)  
= 43.54 (dBμV/m)
- Over Limit(dB)  
= Level(dBμV/m) – Limit Line(dBμV/m)  
= 43.54(dBμV/m) – 54(dBμV/m)  
= -10.46(dB)

Both peak and average measured complies with the limit line, so test result is “PASS”.



## Appendix D. Radiated Spurious Emission Plots

Test Engineer :	Alex Jheng, Bill Chang, and Wilson Wu	Temperature :	24.9~25.3°C
		Relative Humidity :	46~50%

### Note symbol

-L	Low channel location
-R	High channel location



2.4GHz 2400~2483.5MHz

BT (Band Edge @ 3m)

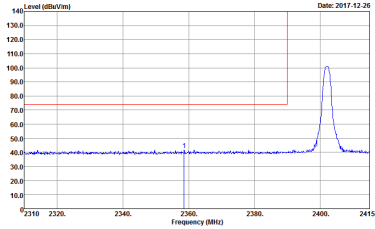
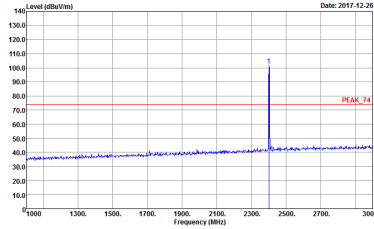
BT	2.4GHz 2400~2483.5MHz Band Edge @ 3m	
ANT	BT CH00 2402MHz	
1	Horizontal	Fundamental
Peak	 <p>Site : 03CH13-HY  Condition : PEAK_BE_74 3m HORN_9120D_1241 HORIZONTAL  : RBW:1000.000kHz VBW:3000.000kHz SWT:Auto  Detector : Peak  Project : 7D2018  Mode : 1</p>	 <p>Site : 03CH13-HY  Condition : PEAK_74 3m HORN_9120D_1241 HORIZONTAL  : RBW:1000.000kHz VBW:3000.000kHz SWT:Auto  Detector : Peak  Project : 7D2018  Mode : 1</p>

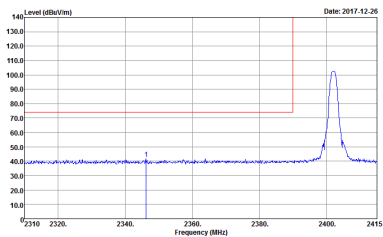
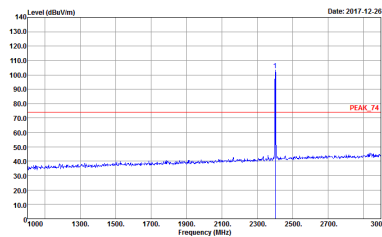

BT	2.4GHz 2400~2483.5MHz Band Edge @ 3m	
ANT	BT CH00 2402MHz	
1	Vertical	Fundamental
Peak	 <p>Site : 03CH13-11Y          Condition : PEAK_BE_74 3m HORN_91200_1241 VERTICAL          Detector : Peak          Project : 7D2018          Mode : 1</p>	 <p>Site : 03CH13-11Y          Condition : PEAK_74 3m HORN_91200_1241 VERTICAL          Detector : Peak          Project : 7D2018          Mode : 1</p>

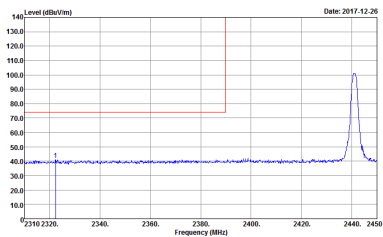
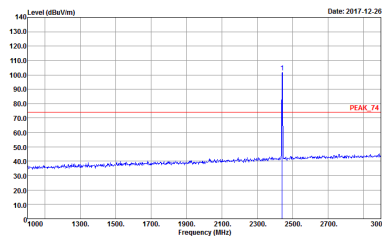
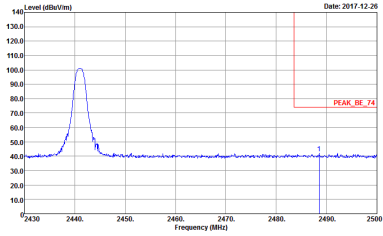

BT	2.4GHz 2400~2483.5MHz Band Edge @ 3m	
ANT	BT CH39 2441MHz	
1	Horizontal	Fundamental
<p><b>Peak</b></p>	 <p>Site : 03CH13-HY            Condition : PEAK_BE_74 3m HORN_91200_1241 HORIZONTAL            : RBW:1000.000KHz VBW:3000.000KHz SWT:Auto            Detector : Peak            Project : 7D2018            Mode : Z</p>	 <p>Site : 03CH13-HY            Condition : PEAK_74 3m HORN_91200_1241 HORIZONTAL            : RBW:1000.000KHz VBW:3000.000KHz SWT:Auto            Detector : Peak            Project : 7D2018            Mode : Z</p>
<p><b>Peak</b></p>	 <p>Site : 03CH13-HY            Condition : PEAK_BE_74 3m HORN_91200_1241 HORIZONTAL            : RBW:1000.000KHz VBW:3000.000KHz SWT:Auto            Detector : Peak            Project : 7D2018            Mode : Z</p>	<p>Left blank</p>



BT	2.4GHz 2400~2483.5MHz Band Edge @ 3m	
ANT	BT CH39 2441MHz	
1	Vertical	Fundamental
<p><b>Peak</b></p>	<p>Site : 03CH13-HY            Condition : PEAK_BE_74 3m HORN_91200_1241 VERTICAL            : RBW:1000.000KHz VBW:3000.000KHz SWT:Auto            Detector : Peak            Project : 7D2018            Mode : Z</p>	<p>Site : 03CH13-HY            Condition : PEAK_74 3m HORN_91200_1241 VERTICAL            : RBW:1000.000KHz VBW:3000.000KHz SWT:Auto            Detector : Peak            Project : 7D2018            Mode : Z</p>
<p><b>Peak</b></p>	<p>Site : 03CH13-HY            Condition : PEAK_BE_74 3m HORN_91200_1241 VERTICAL            : RBW:1000.000KHz VBW:3000.000KHz SWT:Auto            Detector : Peak            Project : 7D2018            Mode : Z</p>	<p><b>Left blank</b></p>

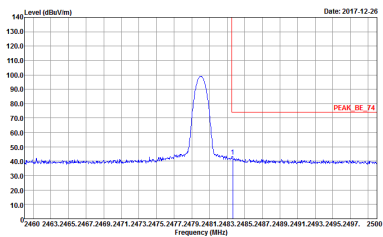
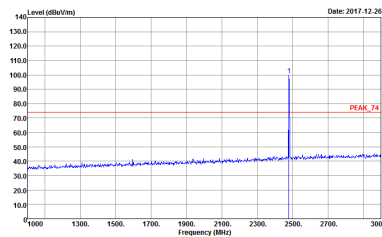

BT	2.4GHz 2400~2483.5MHz Band Edge @ 3m	
ANT	BT CH78 2480MHz	
1	Horizontal	Fundamental
Peak	 <p>Site : 03CH13-11Y          Condition : PEAK_BE_74 3m HORN_9120D_1241 HORIZONTAL          : RBW:1000.000KHz VBW:3000.000KHz SWT:Auto          Detector : Peak          Project : 7D2018          Mode : 3</p>	 <p>Site : 03CH13-11Y          Condition : PEAK_74 3m HORN_9120D_1241 HORIZONTAL          : RBW:1000.000KHz VBW:3000.000KHz SWT:Auto          Detector : Peak          Project : 7D2018          Mode : 3</p>



BT	2.4GHz 2400~2483.5MHz Band Edge @ 3m	
ANT	BT CH78 2480MHz	
1	Vertical	Fundamental
Peak	<p>Site : 03CH13-11Y Condition : PEAK_BE_74 3m HORN_9120D_1241 VERTICAL Detector : Peak Project : 7D2018 Mode : 3</p>	<p>Site : 03CH13-11Y Condition : PEAK_74 3m HORN_9120D_1241 VERTICAL Detector : Peak Project : 7D2018 Mode : 3</p>



2.4GHz 2400~2483.5MHz

BT (Harmonic @ 3m)

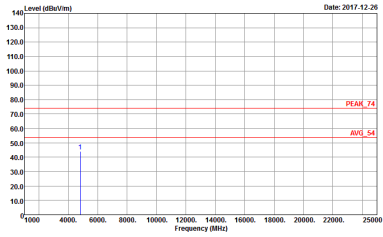
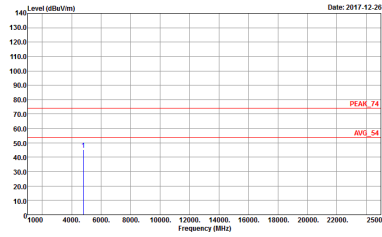
BT	2.4GHz 2400~2483.5MHz Harmonic @ 3m	
ANT	BT CH00 2402MHz	
1	Horizontal	Vertical
<p><b>Peak</b></p> <p><b>Avg.</b></p>	 <p>Site : 03CH13-HY            Condition : PEAK_74 3m SHF_HORN_576 HORIZONTAL            Detector : Peak            Project : 7D2018            Mode : 1</p>	 <p>Site : 03CH13-HY            Condition : PEAK_74 3m SHF_HORN_576 VERTICAL            Detector : Peak            Project : 7D2018            Mode : 1</p>



BT	2.4GHz 2400~2483.5MHz Harmonic @ 3m	
ANT	BT CH39 2441MHz	
1	Horizontal	Vertical
<p>Peak</p> <p>Avg.</p>	<p>Site : 03CH13-11Y          Condition : PEAK_74 3m SHF_HORN_576 HORIZONTAL          Detector : Peak          Project : 7D2018          Mode : -2</p>	<p>Site : 03CH13-11Y          Condition : PEAK_74 3m SHF_HORN_576 VERTICAL          Detector : Peak          Project : 7D2018          Mode : -2</p>



<b>BT</b>	<b>2.4GHz 2400~2483.5MHz Harmonic @ 3m</b>	
<b>ANT</b>	<b>BT CH78 2480MHz</b>	
<b>1</b>	<b>Horizontal</b>	<b>Vertical</b>
<b>Peak</b> <b>Avg.</b>	<p>Site : 03CHE3-11Y Condition : PEAK_74 3m SHF_HORN_576 HORIZONTAL Detector : Peak Project : 7D2018 Mode : 3</p>	<p>Site : 03CHE3-11Y Condition : PEAK_74 3m SHF_HORN_576 VERTICAL Detector : Peak Project : 7D2018 Mode : 3</p>



Emission below 1GHz

2.4GHz BT (LF)

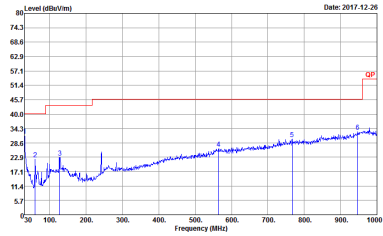
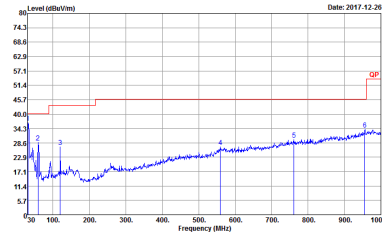
BT	2.4GHz 2400~2483.5MHz	
ANT	BT LF	
1	Horizontal	Vertical
QP / Peak	 <p>Site : 03CH13-HY  Condition : QP 3m BIL06_35414 HORIZONTAL  Detector : Peak  Project : 7D2018  Mode : 4</p>	 <p>Site : 03CH13-HY  Condition : QP 3m BIL06_35414 VERTICAL  Detector : Peak  Project : 7D2018  Mode : 4</p>



# Appendix E. Duty Cycle Plots

### 3DH5 on time (One Pulse) Plot on Channel 39

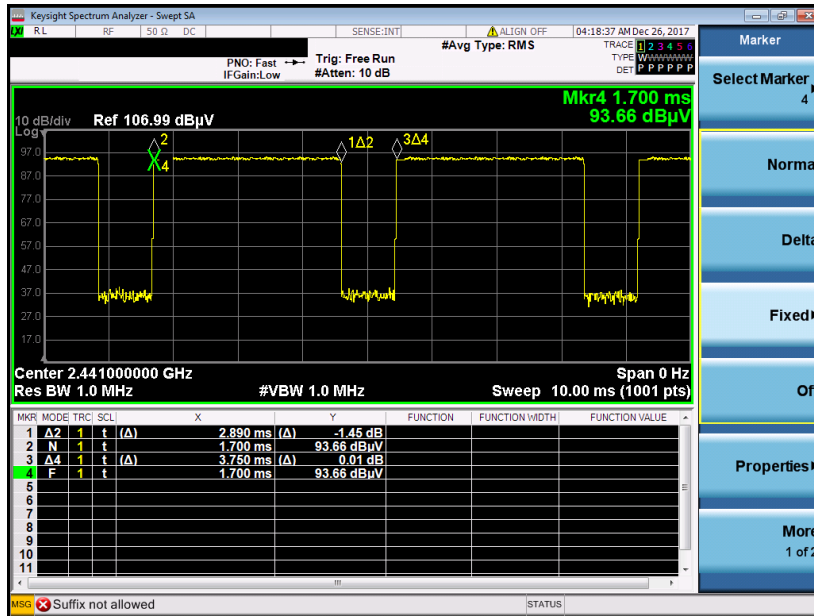

### on time (Count Pulses) Plot on Channel 39

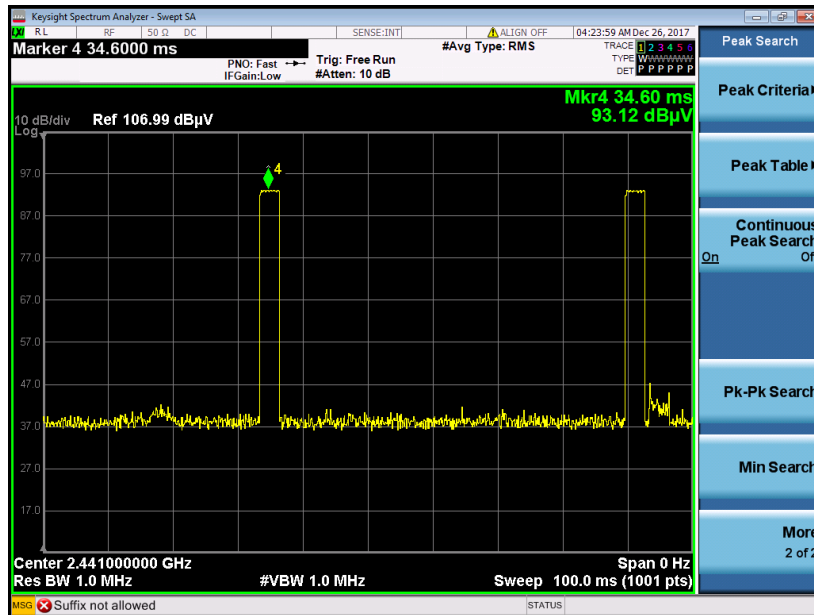

#### Note:

1. Worst case Duty cycle = on time/100 milliseconds =  $2 * 2.89 / 100 = 5.788 \%$
2. Worst case Duty cycle correction factor =  $20 * \log(\text{Duty cycle}) = -24.76 \text{ dB}$
3. 3DH5 has the highest duty cycle worst case and is reported.



**Duty Cycle Correction Factor Consideration for AFH mode:**

Bluetooth normal hopping rate is 1600Hz and reduced to 800Hz in AFH mode; due to the reduced number of hopping frequencies, with the same packet configuration the dwell time in each channel frequency within 100msec period is longer in AFH mode than normal mode.

In AFH mode, the minimum hopping frequencies are 20, to get the longest dwell time DH5 packet is observed; the period to have DH5 packet completing one hopping sequence is

$$2.899 \text{ ms} \times 20 \text{ channels} = 57.88 \text{ ms}$$

There cannot be 2 complete hopping sequences within 100ms period, considering the random hopping behavior, maximum 2 hops can be possibly observed within the period.  $[100\text{ms} / 57.6\text{ms}] = 2$  hops

Thus, the maximum possible ON time:

$$2.899 \text{ ms} \times 2 = 5.788 \text{ ms}$$

Worst case Duty Cycle Correction factor, which is derived from the maximum possible ON time,

$$20 \times \log(5.788 \text{ ms}/100\text{ms}) = -24.766 \text{ dB}$$