



FCC RF Test Report

APPLICANT : Motorola Mobility LLC
EQUIPMENT : Mobile Cellular Phone
BRAND NAME : Motorola
MODEL NAME : XT1924-6, XT1924-8
FCC ID : IHDT56XA1
STANDARD : FCC Part 15 Subpart C §15.247
CLASSIFICATION : (DTS) Digital Transmission System

The product was received on Dec. 29, 2017 and testing was completed on Jan. 28, 2018. We, Sporton International (Kunshan) Inc., would like to declare that the tested sample has been evaluated in accordance with the test procedures and has been in compliance with the applicable technical standards.

This report contains data that were produced under subcontract by Laboratory SPORTON INTERNATIONAL INC.

The test results in this report apply exclusively to the tested model / sample. Without written approval of Sporton International (Kunshan) Inc., the test report shall not be reproduced except in full.



Approved by: James Huang / Manager

Sporton International (Kunshan) Inc.

**No.3-2 Ping-Xiang Rd, Kunshan Development Zone Kunshan City Jiangsu Province 215335
China**



TABLE OF CONTENTS

REVISION HISTORY..... 3

SUMMARY OF TEST RESULT 4

1 GENERAL DESCRIPTION 5

 1.1 Applicant 5

 1.2 Manufacturer 5

 1.3 Product Feature of Equipment Under Test..... 5

 1.4 Product Specification of Equipment Under Test..... 6

 1.5 Modification of EUT 6

 1.6 Specification of Accessory..... 6

 1.7 Testing Location 7

 1.8 Applicable Standards..... 8

2 TEST CONFIGURATION OF EQUIPMENT UNDER TEST 9

 2.1 Carrier Frequency and Channel 9

 2.2 Test Mode..... 10

 2.3 Connection Diagram of Test System..... 11

 2.4 Support Unit used in test configuration and system 12

 2.5 EUT Operation Test Setup 12

 2.6 Measurement Results Explanation Example..... 12

3 TEST RESULT 13

 3.1 6dB Bandwidth Measurement 13

 3.2 Output Power Measurement..... 15

 3.3 Power Spectral Density Measurement 17

 3.4 Conducted Band Edges and Spurious Emission Measurement 19

 3.5 Radiated Band Edges and Spurious Emission Measurement 29

 3.6 AC Conducted Emission Measurement..... 33

 3.7 Antenna Requirements 38

4 LIST OF MEASURING EQUIPMENT 39

5 UNCERTAINTY OF EVALUATION 40

APPENDIX A. CONDUCTED TEST RESULTS

APPENDIX B. RADIATED SPURIOUS EMISSION

APPENDIX C. DUTY CYCLE PLOTS

APPENDIX D. SETUP PHOTOGRAPHS



SUMMARY OF TEST RESULT

Report Section	FCC Rule	Description	Limit	Result	Remark
3.1	15.247(a)(2)	6dB Bandwidth	$\geq 0.5\text{MHz}$	Pass	-
3.2	15.247(b)	Power Output Measurement	$\leq 30\text{dBm}$	Pass	-
3.3	15.247(e)	Power Spectral Density	$\leq 8\text{dBm}/3\text{kHz}$	Pass	-
3.4	15.247(d)	Conducted Band Edges	$\leq 20\text{dBc}$	Pass	-
		Conducted Spurious Emission		Pass	-
3.5	15.247(d)	Radiated Band Edges and Radiated Spurious Emission	15.209(a) & 15.247(d)	Pass	Under limit 3.07 dB at 2390.000 MHz
3.6	15.207	AC Conducted Emission	15.207(a)	Pass	Under limit 3.66 dB at 0.151 MHz
3.7	15.203 & 15.247(b)	Antenna Requirement	N/A	Pass	-



1 General Description

1.1 Applicant

Motorola Mobility LLC
222 W,Merchandise Mart Plaza, Chicago IL 60654 USA

1.2 Manufacturer

Motorola Mobility LLC
222 W,Merchandise Mart Plaza, Chicago IL 60654 USA

1.3 Product Feature of Equipment Under Test

Product Feature	
Equipment	Mobile Cellular Phone
Brand Name	Motorola
Model Name	XT1924-6, XT1924-8
FCC ID	IHDT56XA1
EUT supports Radios application	CDMA/EV-DO/GSM/GPRS/EGPRS/WCDMA/HSPA/ DC-HSDPA/HSPA+(16QAM uplink is not supported)/LTE WLAN 2.4GHz 802.11b/g/n HT20 WLAN 5GHz 802.11a/n HT20/HT40 Bluetooth v3.0+EDR/ Bluetooth v4.0 LE/ Bluetooth v4.1 LE/ Bluetooth v4.2 LE
IMEI Code	Conducted: 351892090018859 Conduction: 351892090020962 Radiation: 351892090021226
HW Version	DVT1-B
SW Version	hannah-userdebug 8.0.0 OPP27.66 1466 intcfg,test-keys
EUT Stage	Identical Prototype

Remark: The above EUT's information was declared by manufacturer. Please refer to the specifications or user's manual for more detailed description.



1.4 Product Specification of Equipment Under Test

Standards-related Product Specification	
Tx/Rx Channel Frequency Range	2412 MHz ~ 2462 MHz
Maximum (Peak) Output Power to antenna	802.11b : 20.56 dBm (0.1138 W) 802.11g : 22.76 dBm (0.1888 W) 802.11n HT20 : 21.36 dBm (0.1368 W)
Antenna Type / Gain	IFA Antenna with gain -0.65 dBi
Type of Modulation	802.11b : DSSS (DBPSK / DQPSK / CCK) 802.11g/n : OFDM (BPSK / QPSK / 16QAM / 64QAM)

1.5 Modification of EUT

No modifications are made to the EUT during all test items.

1.6 Specification of Accessory

Specification of Accessory			
AC Adapter 1	Brand Name	Motorola (Salom)	Model Name SPN5970A SC-22
	Power Rating	I/P: 100-240 Vac, 500mA, O/P: 5 Vdc,3000mA or 9Vdc,1600mA or 12Vdc,1200mA	
AC Adapter 2	Brand Name	Motorola (Chenyang)	Model Name SPN5993A SC-22
	Power Rating	I/P: 100-240 Vac, 500mA, O/P: 5 Vdc,3000mA or 9Vdc,1600mA or 12Vdc,1200mA	
Earphone	Brand Name	Motorola (NEW Leaders)	Model Name NLD-EM300V-01SF
	Signal Line	1.25 meter, non-shielded cable, without ferrite core	
Battery	Brand Name	Motorola (Amperex)	Model Name HE50
	Power Rating	3.8Vdc,4850/5000mAh	Type Li-ion
USB Cable (Black/White)	Brand Name	Motorola (SaiBao)	Model Name SLQ-A081A
	Signal Line	1.02 meter, shielded cable, without ferrite core	



1.7 Testing Location

Sporton International (Kunshan) Inc. is accredited to ISO 17025 by National Voluntary Laboratory Accreditation Program (NVLAP code: 600155-0) and the FCC designation No. is CN5013.

Test Site	Sporton International (Kunshan) Inc.		
Test Site Location	No.3-2 Ping-Xiang Rd, Kunshan Development Zone Kunshan City Jiangsu Province 215335 China TEL : +86-512-57900158 FAX : +86-512-57900958		
Test Site No.	Sporton Site No.		FCC Test Firm Registration No.
	TH01-KS	CO01-KS	630927

Note: The test site complies with ANSI C63.4 2014 requirement.

Sporton Lab is accredited to ISO 17025 by Taiwan Accreditation Foundation (TAF code : 1190) and the FCC designation No. TW1022 under the FCC 2.948(e) by Mutual Recognition Agreement (MRA) in FCC Test.

Test Site	SPORTON INTERNATIONAL INC.		
Test Site Location	No. 52, Hwa Ya 1 st Rd., Hwa Ya Technology Park, Kwei-Shan District, Tao Yuan City, Taiwan, R.O.C. TEL: +886-3-327-3456 FAX: +886-3-328-4978		
Test Site No.	Sporton Site No.		
	03CH10-HY		

Note:

1. The test site complies with ANSI C63.4 2014 requirement.
2. Test data subcontracted: radiated spurious emissions for section 3.5 of this report.



1.8 Applicable Standards

According to the specifications of the manufacturer, the EUT must comply with the requirements of the following standards:

- ♦ FCC Part 15 Subpart C §15.247
- ♦ FCC KDB Publication No. 558074 D01 DTS Meas. Guidance v04
- ♦ ANSI C63.10-2013

Remark:

1. All test items were verified and recorded according to the standards and without any deviation during the test.
2. This EUT has also been tested and complied with the requirements of FCC Part 15, Subpart B, recorded in a separate test report.



2 Test Configuration of Equipment Under Test

The EUT has been associated with peripherals and configuration operated in a manner tended to maximize its emission characteristics in a typical application. Frequency range investigated: conducted emission (150 kHz to 30 MHz) and radiated emission (9 kHz to the 10th harmonic of the highest fundamental frequency or to 40 GHz, whichever is lower). For radiated measurement, pre-scanned in three orthogonal panels, X, Y, Z. The worst cases were recorded in this report.

2.1 Carrier Frequency and Channel

Frequency Band	Channel	Freq. (MHz)	Channel	Freq. (MHz)
2400-2483.5 MHz	1	2412	7	2442
	2	2417	8	2447
	3	2422	9	2452
	4	2427	10	2457
	5	2432	11	2462
	6	2437	-	-



2.2 Test Mode

Final test mode of conducted test items and radiated spurious emissions are considering the modulation and worse data rates as below table.

Modulation	Data Rate
802.11b	1 Mbps
802.11g	6 Mbps
802.11n HT20	MCS0

Test Cases	
AC Conducted Emission	Mode 1 : GSM 850 Idle + Bluetooth Link + WLAN Link (2.4G) + USB Cable (Charging from Adapter1) + Earphone Mode 2: GSM 850 Idle + Bluetooth Link + WLAN Link (2.4G) + USB Cable (Charging from Adapter2) + Earphone
Remark: 1. The worst case of conducted emission is mode 2; only the test data of it was reported. 2. For Radiated Test Cases, The tests were performed with Adapter 1, Earphone and USB Cable .	

2.3 Connection Diagram of Test System

<WLAN Tx Mode>

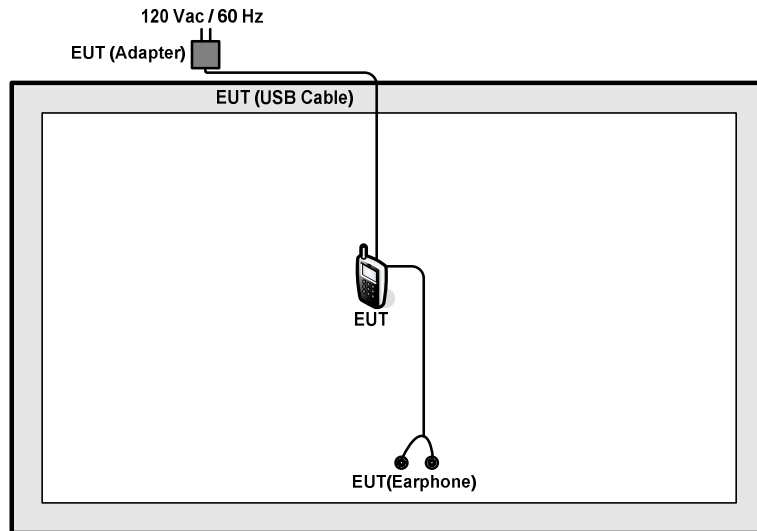

<AC Conducted Emission Mode>

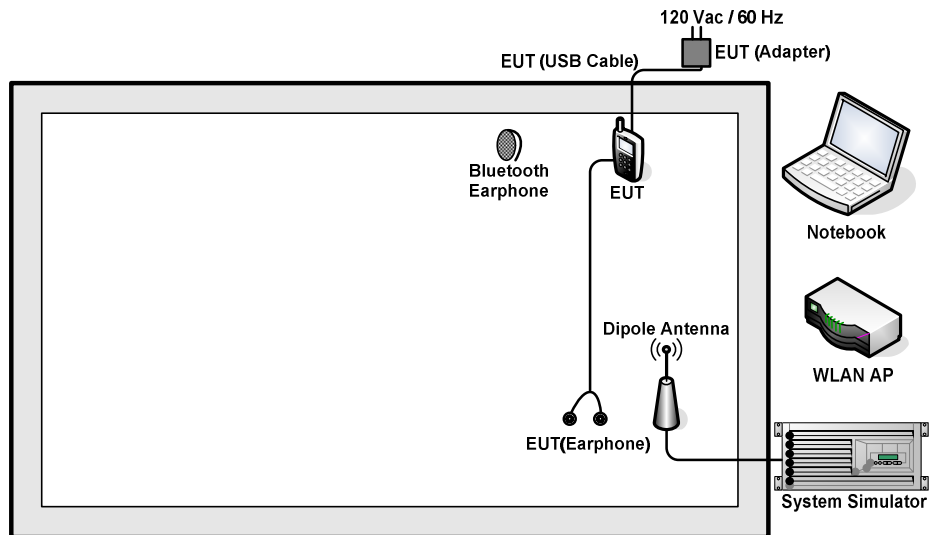



2.4 Support Unit used in test configuration and system

Item	Equipment	Trade Name	Model Name	FCC ID	Data Cable	Power Cord
1.	System Simulator	Anritsu	MT8820C	N/A	N/A	Unshielded, 1.8 m
2.	WLAN AP	D-Link	DIR-855	KA2DIR855A2	N/A	Unshielded,1.8m
3.	Notebook	Lenovo	G480	N/A	N/A	Shielded cable DC O/P 1.8m , Unshielded AC I/P cable 1.8m
4.	Bluetooth Earphone	Lenovo	LBH308	NA	N/A	N/A
5.	SD Card	Kingston	8GB	N/A	N/A	N/A

2.5 EUT Operation Test Setup

For WLAN function, the engineering test program was provided and enabled to make EUT continuous transmit/receive.

For AC power line conducted emissions, the EUT was set to WLAN link with the WLAN AP under large package sizes transmission.

2.6 Measurement Results Explanation Example

For all conducted test items:

The offset level is set in the spectrum analyzer to compensate the RF cable loss between EUT conducted output port and spectrum analyzer. With the offset compensation, the spectrum analyzer reading level is exactly the EUT RF output level.

Example :

The spectrum analyzer offset is derived from RF cable loss.

Offset = RF cable loss.

Following shows an offset computation example with cable loss 5.4 dB.

$$\begin{aligned}
 \text{Offset(dB)} &= \text{RF cable loss(dB)}. \\
 &= 5.4 \text{ (dB)}
 \end{aligned}$$

3 Test Result

3.1 6dB Bandwidth Measurement

3.1.1 Limit of 6dB Bandwidth

The minimum 6 dB bandwidth shall be at least 500 kHz.

3.1.2 Measuring Instruments

The measuring equipment is listed in the section 4 of this test report.

3.1.3 Test Procedures

1. The testing follows FCC KDB Publication No. 558074 DTS D01 Meas. Guidance v04.
2. The RF output of EUT was connected to the spectrum analyzer by RF cable and attenuator. The path loss was compensated to the results for each measurement.
3. Set to the maximum power setting and enable the EUT transmit continuously.
4. Make the measurement with the spectrum analyzer's resolution bandwidth (RBW) = 100 kHz. Set the Video bandwidth (VBW) = 300 kHz. In order to make an accurate measurement. The 6 dB bandwidth must be greater than 500 kHz.
5. Measure and record the results in the test report.

3.1.4 Test Setup

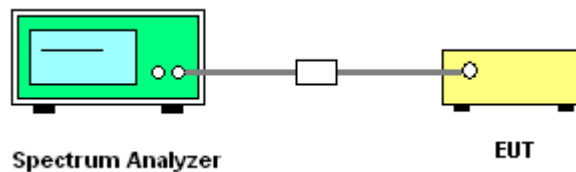



3.1.5 Test Result of 6dB Occupied Bandwidth

Please refer to Appendix A.

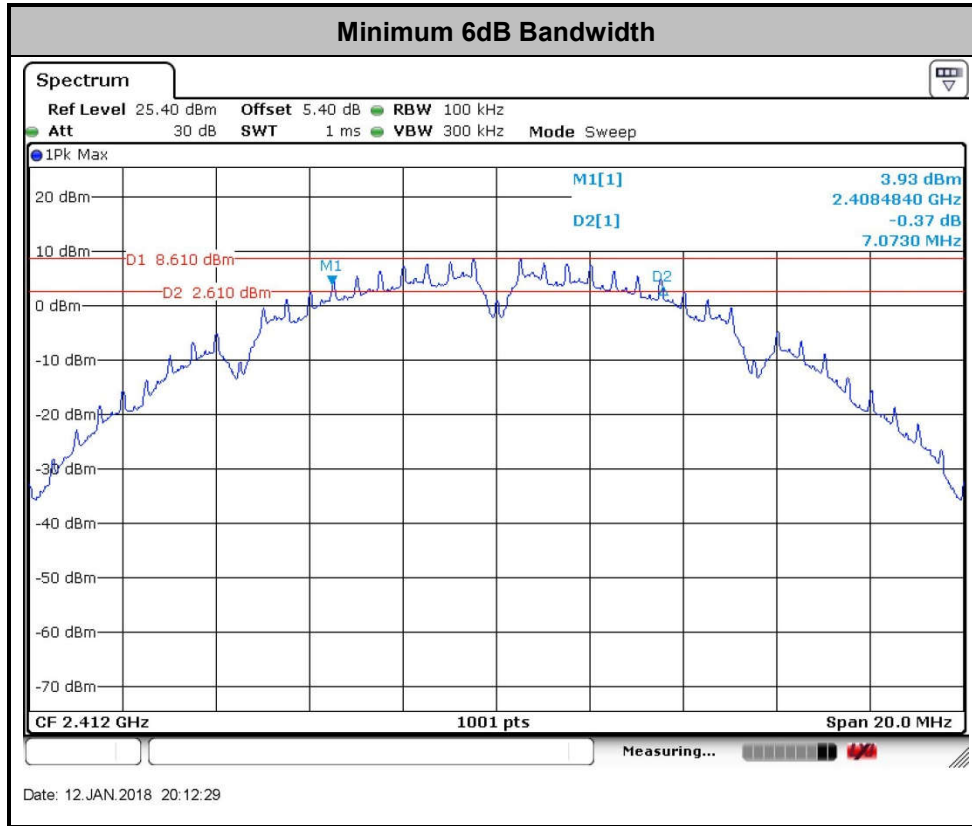

3.2 Output Power Measurement

3.2.1 Limit of Output Power

For systems using digital modulation in the 2400-2483.5MHz, the limit for peak output power is 30dBm. If transmitting antenna of directional gain greater than 6dBi are used the peak output power from the intentional radiator shall be reduced below the above stated value by the amount in dB that the directional gain of the antenna exceeds 6 dBi. In case of point-to-point operation, the limit has to be reduced by 1dB for every 3dB that the directional gain of the antenna exceeds 6dBi.

3.2.2 Measuring Instruments

The measuring equipment is listed in the section 4 of this test report.

3.2.3 Test Procedures

1. The testing follows the Measurement Procedure of FCC KDB No. 558074 DTS D01 Meas. Guidance v04 section 9.1.2 PKPM1 Peak power meter method.
2. The RF output of EUT was connected to the power meter by RF cable and attenuator. The path loss was compensated to the results for each measurement.
3. Set to the maximum power setting and enable the EUT transmit continuously.
4. Measure the conducted output power and record the results in the test report.

3.2.4 Test Setup

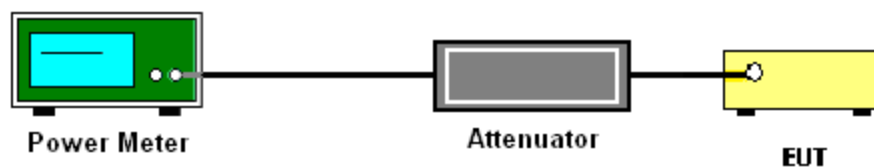



3.2.5 Test Result of Peak Output Power

Please refer to Appendix A.

3.2.6 Test Result of Average output Power (Reporting Only)

Please refer to Appendix A.

3.3 Power Spectral Density Measurement

3.3.1 Limit of Power Spectral Density

The peak power spectral density shall not be greater than 8dBm in any 3kHz band at any time interval of continuous transmission.

3.3.2 Measuring Instruments

The measuring equipment is listed in the section 4 of this test report.

3.3.3 Test Procedures

1. The testing follows Measurement Procedure 10.2 Method PKPSD of FCC KDB Publication No. 558074 D01 DTS Meas. Guidance v04
2. The RF output of EUT was connected to the spectrum analyzer by RF cable and attenuator. The path loss was compensated to the results for each measurement.
3. Set to the maximum power setting and enable the EUT transmit continuously.
4. Make the measurement with the spectrum analyzer's resolution bandwidth (RBW) = 3 kHz. Video bandwidth VBW = 10 kHz In order to make an accurate measurement, set the span to 1.5 times DTS Channel Bandwidth. (6dB BW)
5. Detector = peak, Sweep time = auto couple, Trace mode = max hold, Allow trace to fully stabilize. Use the peak marker function to determine the maximum power level.
6. Measure and record the results in the test report.

3.3.4 Test Setup

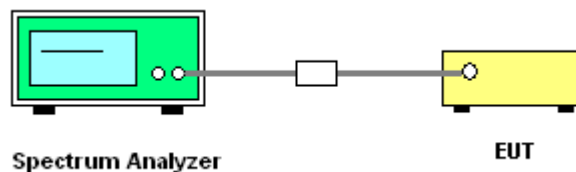



3.3.5 Test Result of Power Spectral Density

Please refer to Appendix A.

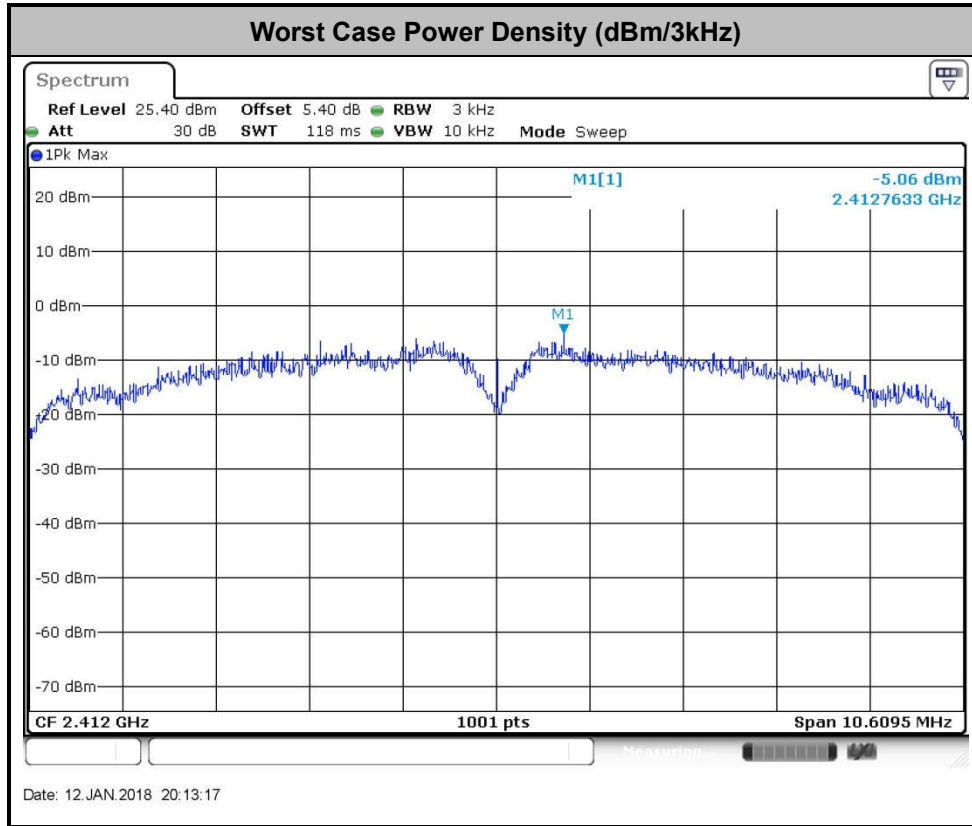

3.4 Conducted Band Edges and Spurious Emission Measurement

3.4.1 Limit of Conducted Band Edges and Spurious Emission Measurement

In any 100 kHz bandwidth outside of the authorized frequency band, the emissions which fall in the non-restricted bands shall be attenuated at least 20 dB / 30dB relative to the maximum PSD level in 100 kHz by RF conducted measurement.

3.4.2 Measuring Instruments

The measuring equipment is listed in the section 4 of this test report.

3.4.3 Test Procedures

1. The testing follows FCC KDB Publication No. 558074 D01 DTS Meas. Guidance v04.
2. The RF output of EUT was connected to the spectrum analyzer by RF cable and attenuator. The path loss was compensated to the results for each measurement.
3. Set to the maximum power setting and enable the EUT transmit continuously.
4. Set RBW = 100 kHz, VBW=300 kHz, Peak Detector. Unwanted Emissions measured in any 100 kHz bandwidth outside of the authorized frequency band shall be attenuated by at least 20 dB relative to the maximum in-band peak PSD level in 100 kHz when maximum peak conducted output power procedure is used. If the transmitter complies with the conducted power limits based on the use of RMS averaging over a time interval, the attenuation required under this paragraph shall be 30 dB instead of 20 dB.
5. Measure and record the results in the test report.
6. The RF fundamental frequency should be excluded against the limit line in the operating frequency band.

3.4.4 Test Setup

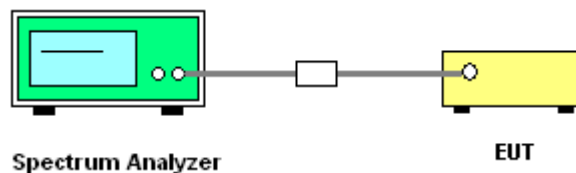



3.4.5 Test Result of Conducted Band Edges and Spurious Emission

Test Mode :	802.11b	Temperature :	21~25°C
Test Band :	2.4GHz Low	Relative Humidity :	51~55%
Test Channel :	01	Test Engineer :	Silent Hai

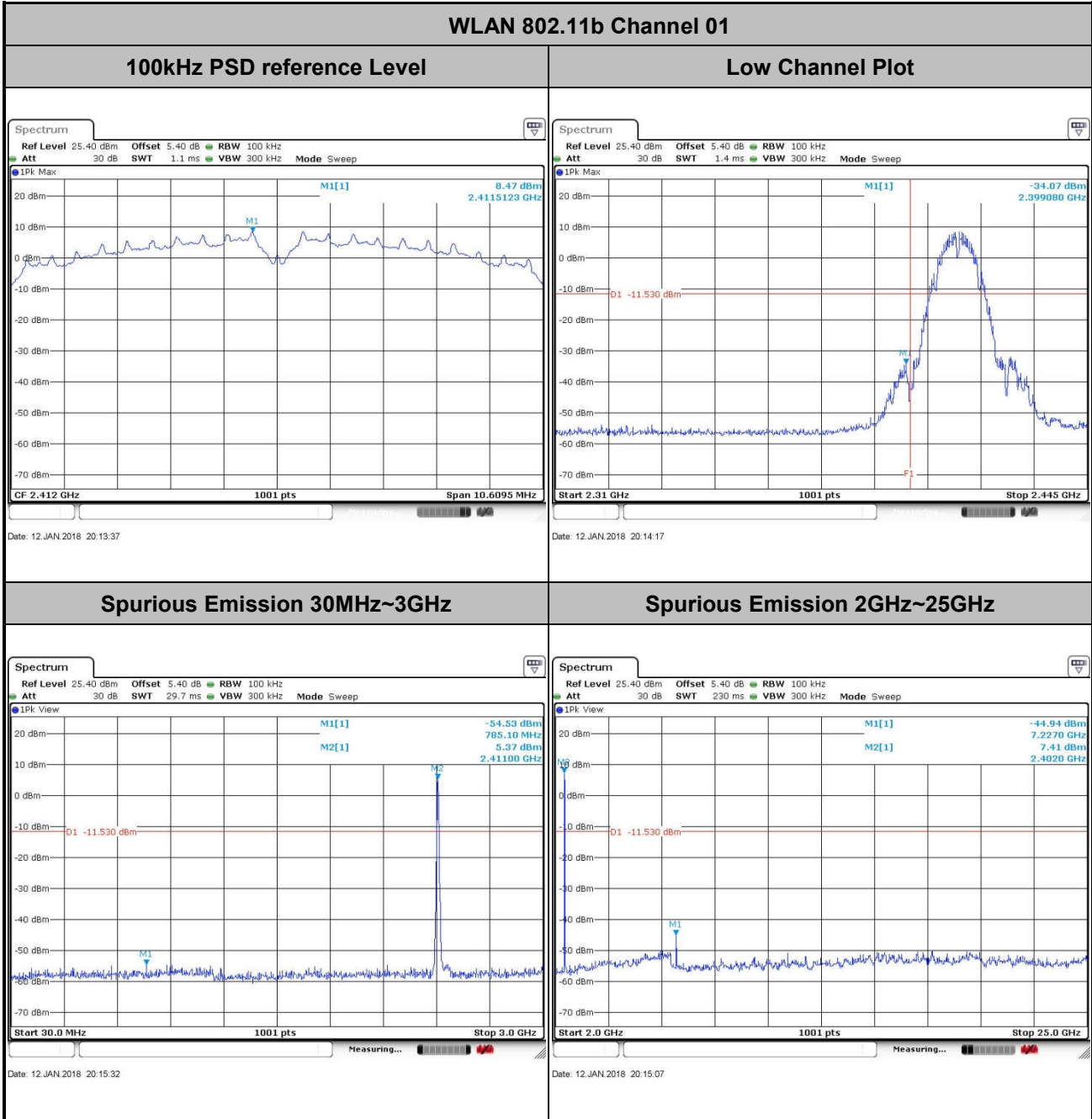



Test Mode :	802.11b	Temperature :	21~25°C
Test Band :	2.4GHz Mid	Relative Humidity :	51~55%
Test Channel :	06	Test Engineer :	Silent Hai

WLAN 802.11b Channel 06

100kHz PSD reference Level

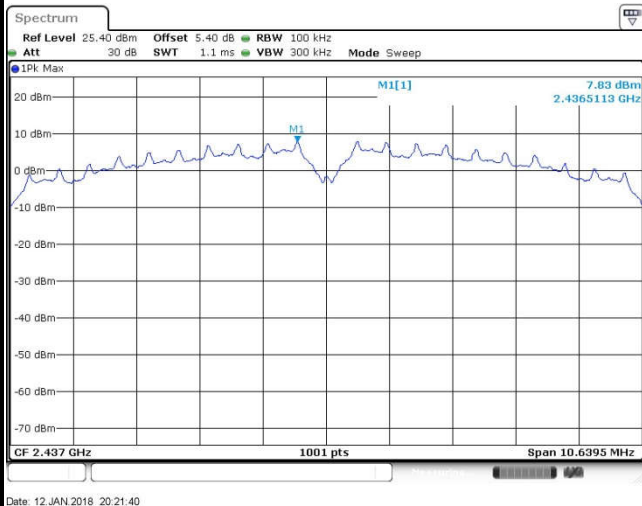

Spurious Emission 30MHz~3GHz

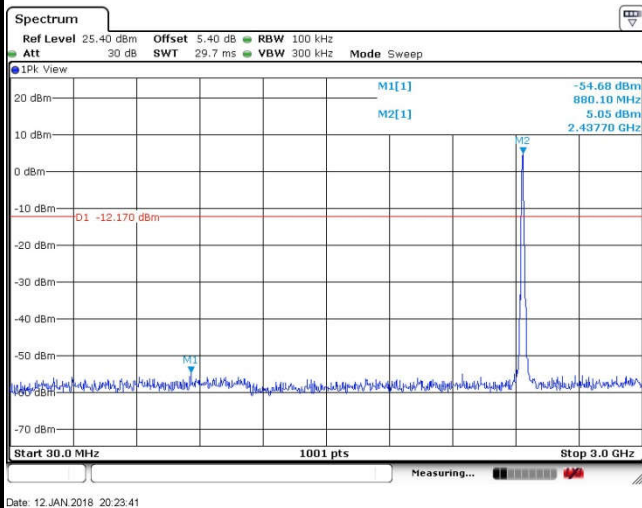

Spurious Emission 2GHz~25GHz

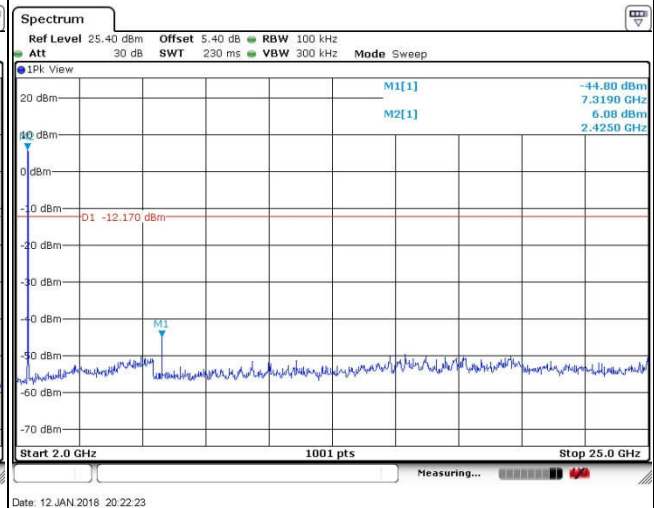



Test Mode :	802.11b	Temperature :	21~25°C
Test Band :	2.4GHz High	Relative Humidity :	51~55%
Test Channel :	11	Test Engineer :	Silent Hai

WLAN 802.11b Channel 11

100kHz PSD reference Level

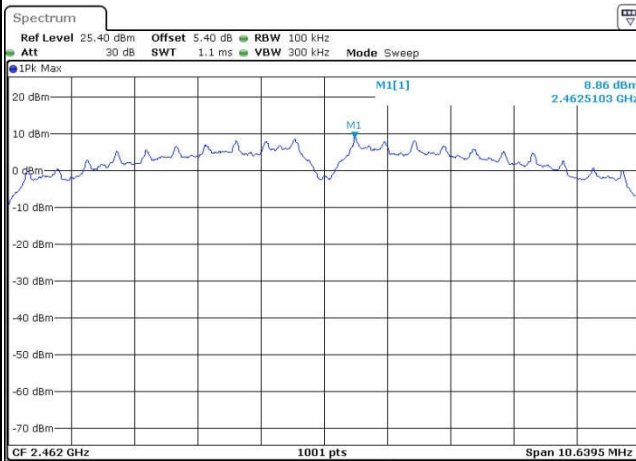

Date: 12 JAN 2018 20:29:00

High Channel Plot

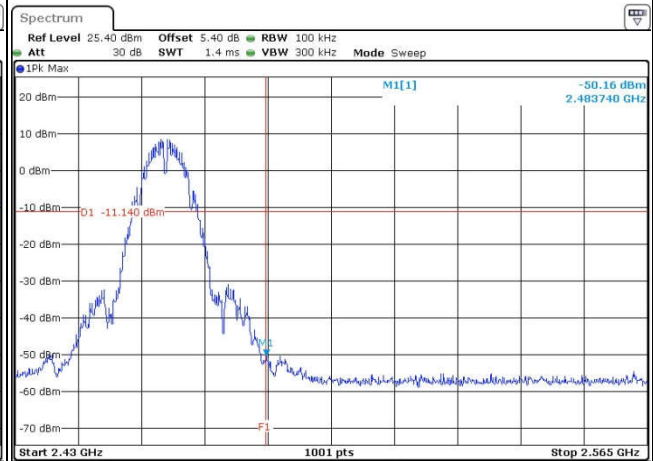

Date: 12 JAN 2018 20:29:44

Spurious Emission 30MHz~3GHz

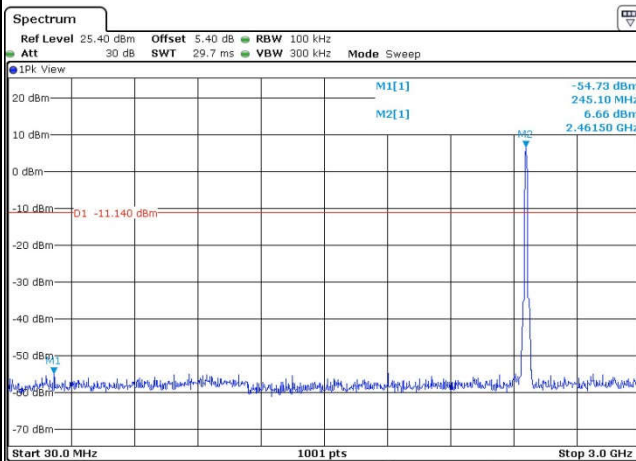

Date: 12 JAN 2018 20:31:24

Spurious Emission 2GHz~25GHz

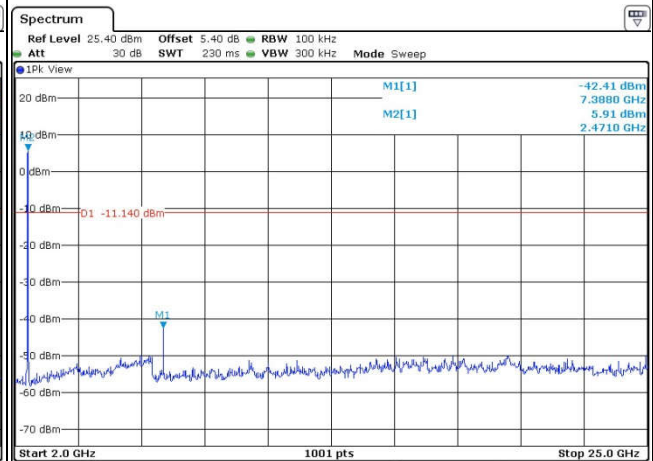

Date: 12 JAN 2018 20:30:57



Test Mode :	802.11g	Temperature :	21~25°C
Test Band :	2.4GHz Low	Relative Humidity :	51~55%
Test Channel :	01	Test Engineer :	Silent Hai

WLAN 802.11g Channel 01

100kHz PSD reference Level

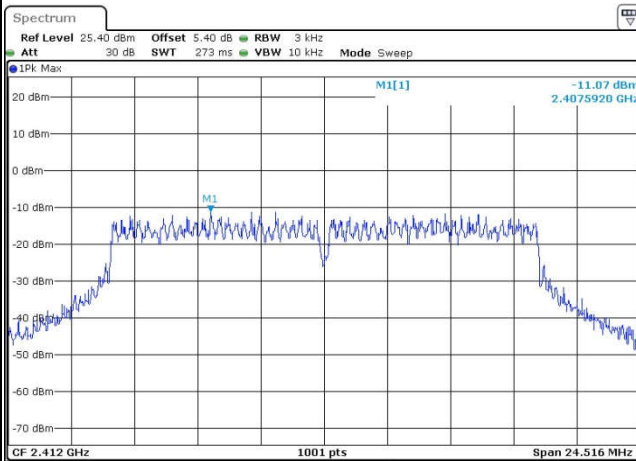

Date: 12.JAN.2018 20:36:42

Low Channel Plot

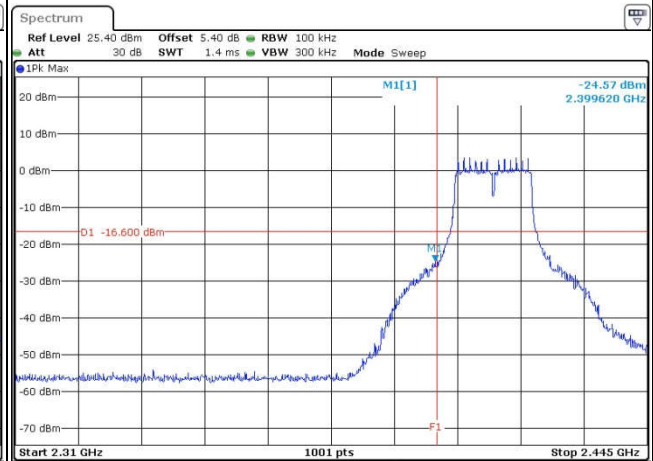

Date: 12.JAN.2018 20:37:45

Spurious Emission 30MHz~3GHz

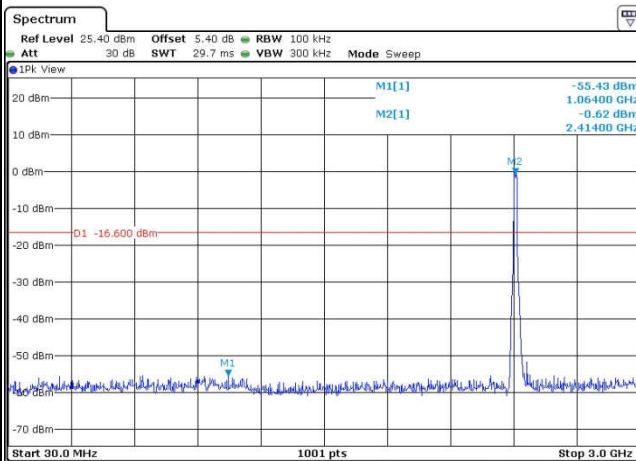

Date: 12.JAN.2018 20:40:21

Spurious Emission 2GHz~25GHz

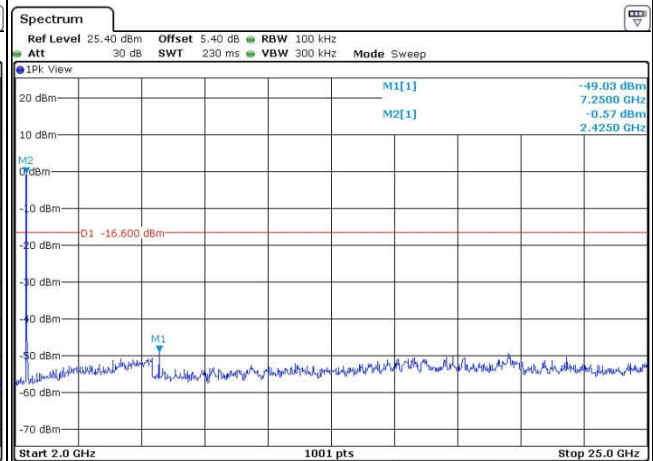

Date: 12.JAN.2018 20:38:52



Test Mode :	802.11g	Temperature :	21~25°C
Test Band :	2.4GHz Mid	Relative Humidity :	51~55%
Test Channel :	06	Test Engineer :	Silent Hai

WLAN 802.11g Channel 06

100kHz PSD reference Level

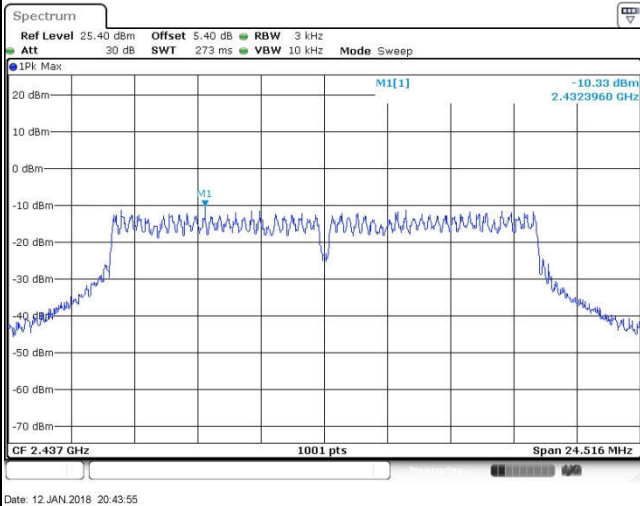

Spurious Emission 30MHz~3GHz

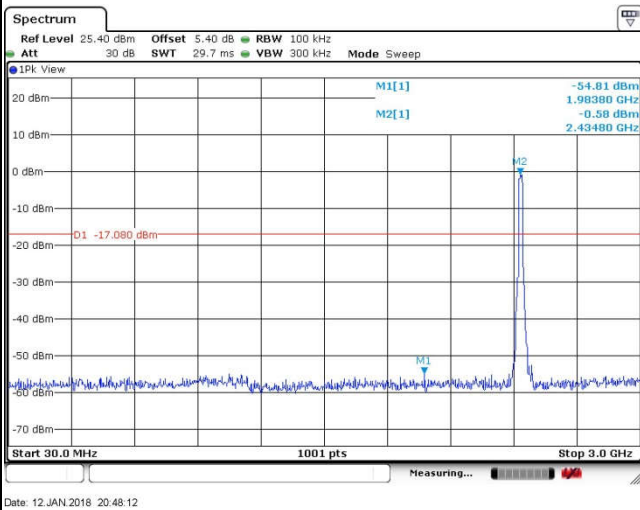

Spurious Emission 2GHz~25GHz

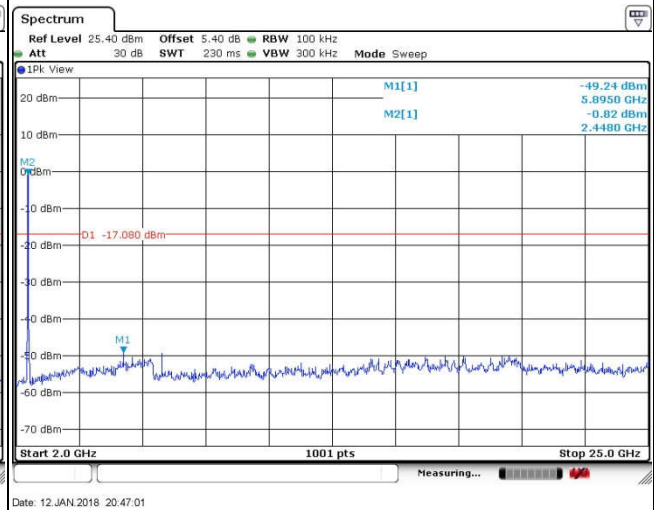



Test Mode :	802.11g	Temperature :	21~25°C
Test Band :	2.4GHz High	Relative Humidity :	51~55%
Test Channel :	11	Test Engineer :	Silent Hai

WLAN 802.11g Channel 11

100kHz PSD reference Level

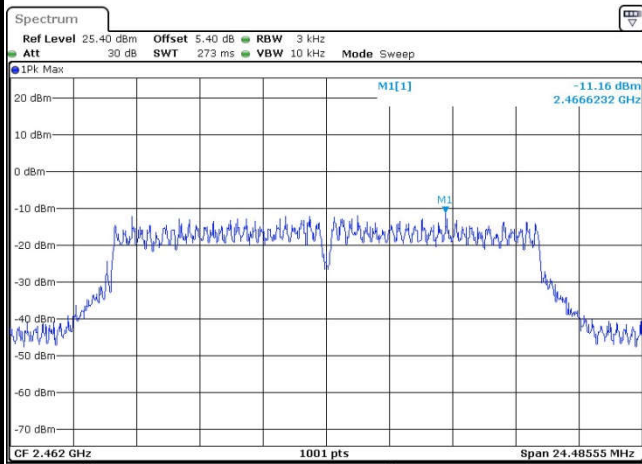

High Channel Plot

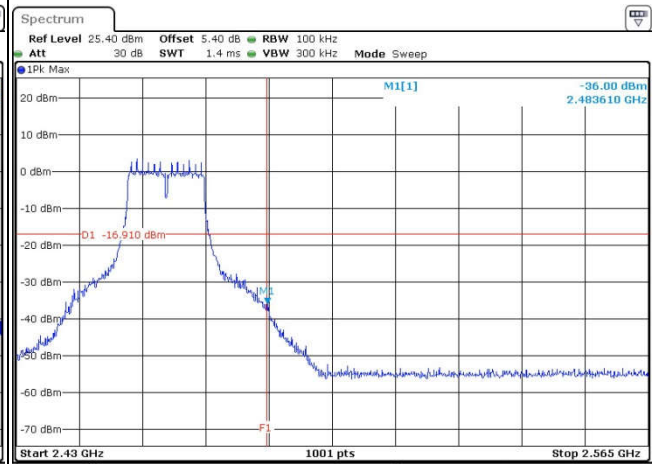

Spurious Emission 30MHz~3GHz

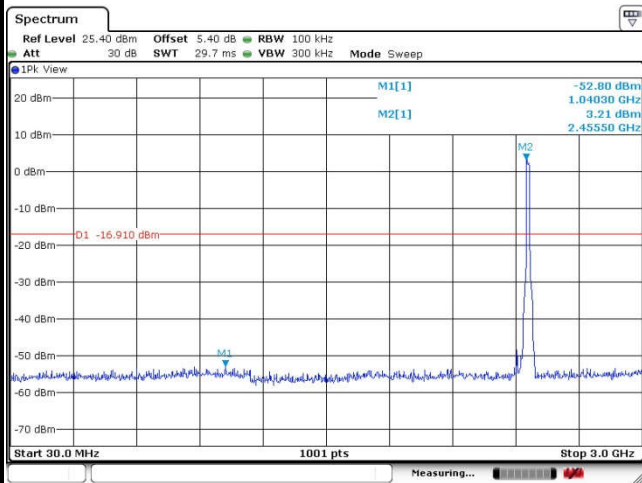

Spurious Emission 2GHz~25GHz

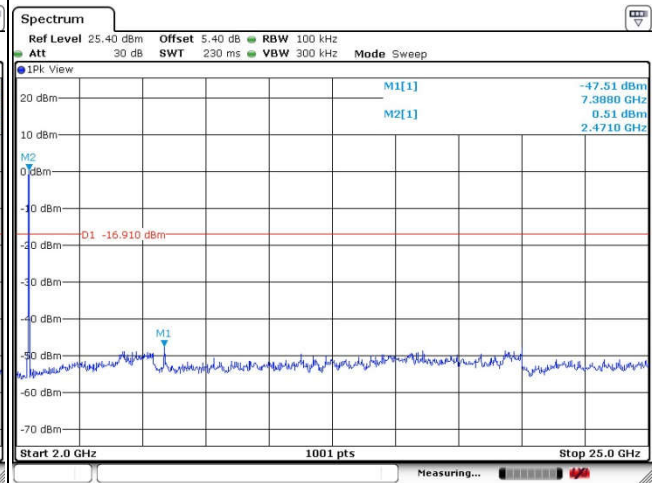



Test Mode :	802.11n HT20	Temperature :	21~25°C
Test Band :	2.4GHz Low	Relative Humidity :	51~55%
Test Channel :	01	Test Engineer :	Silent Hai

WLAN 802.11n HT20 Channel 01

100kHz PSD reference Level

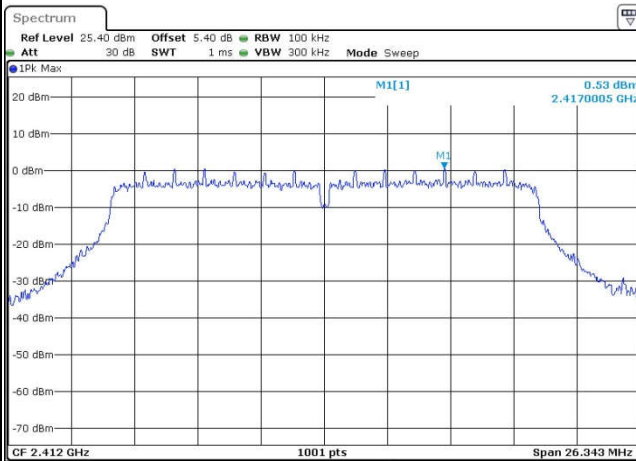

Date: 12.JAN.2018 21:01:49

Low Channel Plot

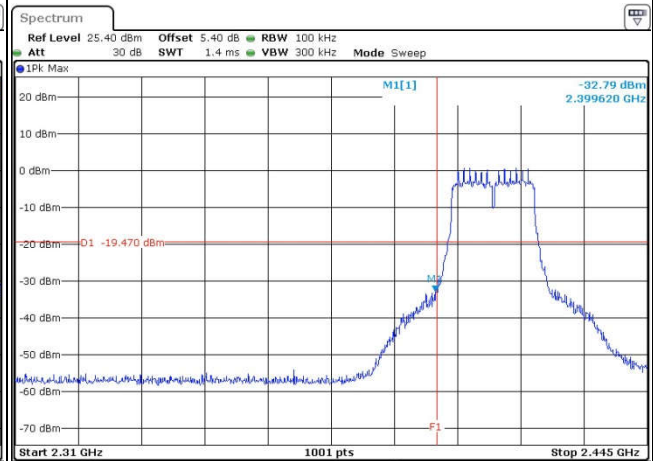

Date: 12.JAN.2018 21:02:14

Spurious Emission 30MHz~3GHz

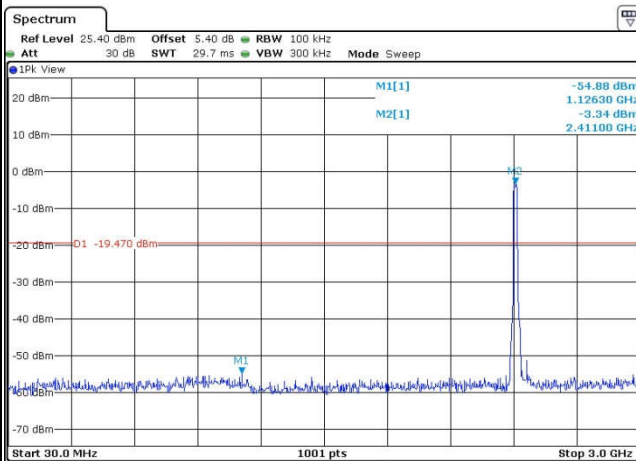

Date: 12.JAN.2018 21:05:31

Spurious Emission 2GHz~25GHz

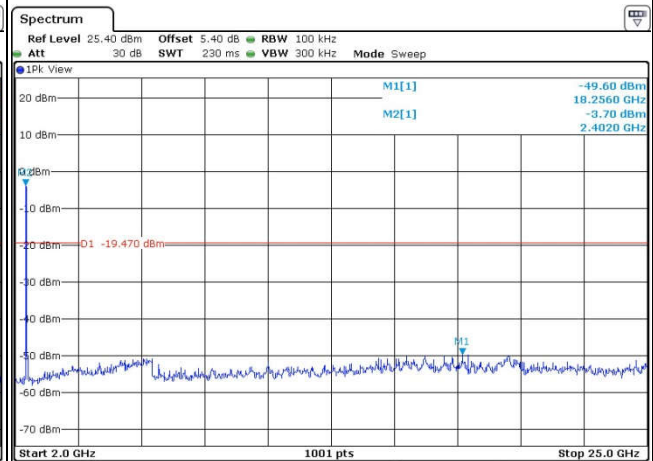

Date: 12.JAN.2018 21:03:17



Test Mode :	802.11n HT20	Temperature :	21~25°C
Test Band :	2.4GHz Mid	Relative Humidity :	51~55%
Test Channel :	06	Test Engineer :	Silent Hai

WLAN 802.11n HT20 Channel 06

100kHz PSD reference Level

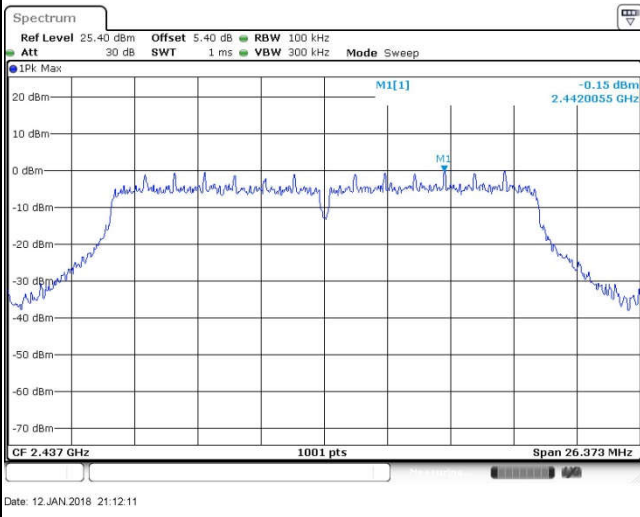

Spurious Emission 30MHz~3GHz

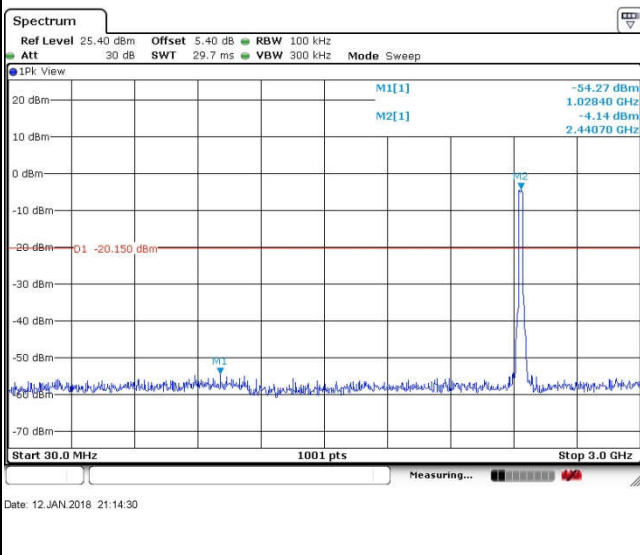

Spurious Emission 2GHz~25GHz

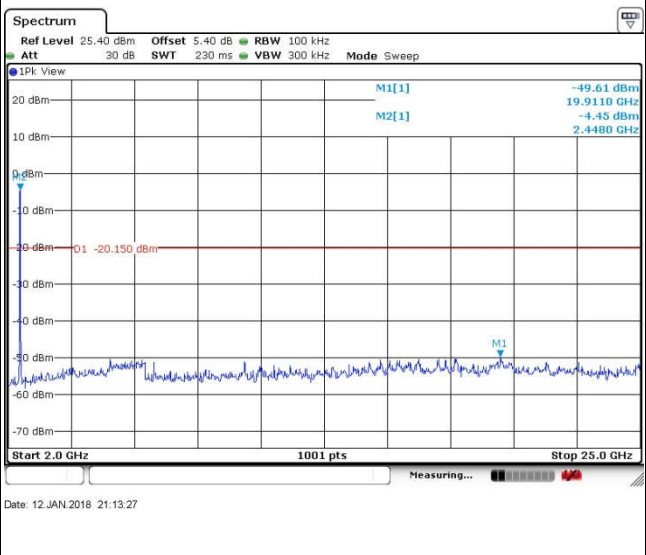



Test Mode :	802.11n HT20	Temperature :	21~25°C
Test Band :	2.4GHz High	Relative Humidity :	51~55%
Test Channel :	11	Test Engineer :	Silent Hai

WLAN 802.11n HT20 Channel 11

100kHz PSD reference Level

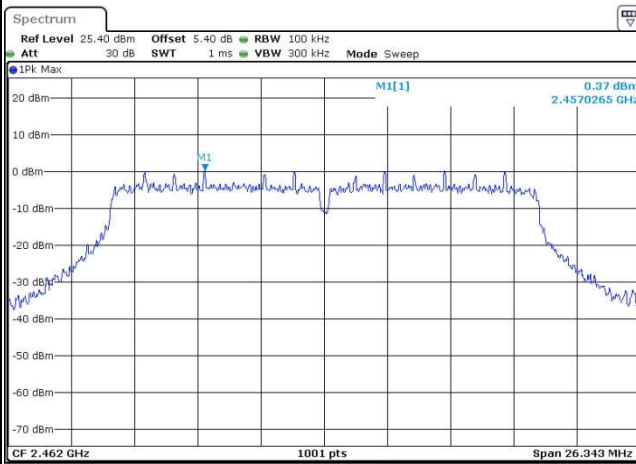

Date: 12.JAN.2018 21:24:12

High Channel Plot

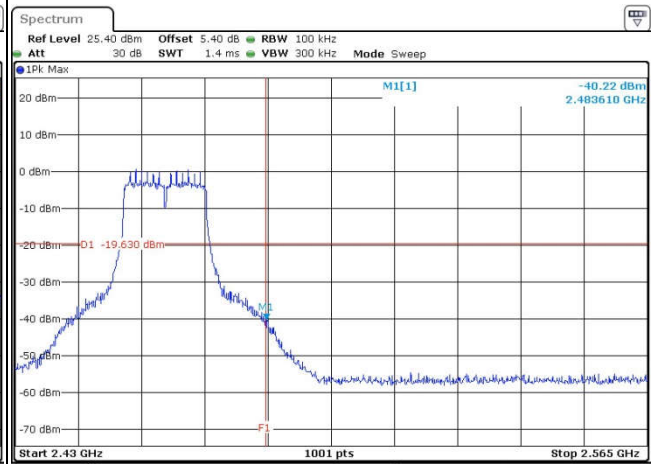

Date: 12.JAN.2018 21:24:40

Spurious Emission 30MHz~3GHz

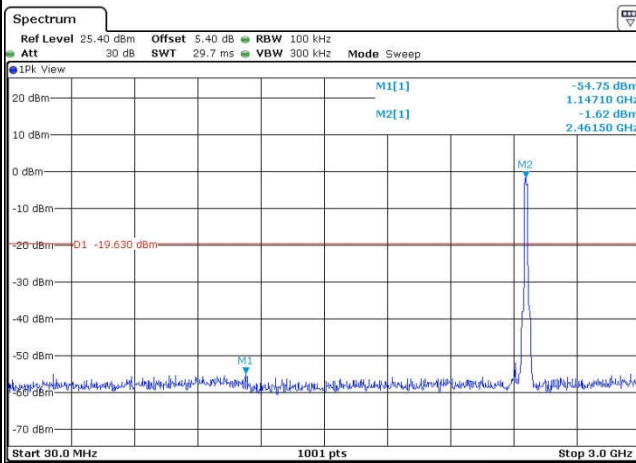

Date: 12.JAN.2018 21:26:29

Spurious Emission 2GHz~25GHz

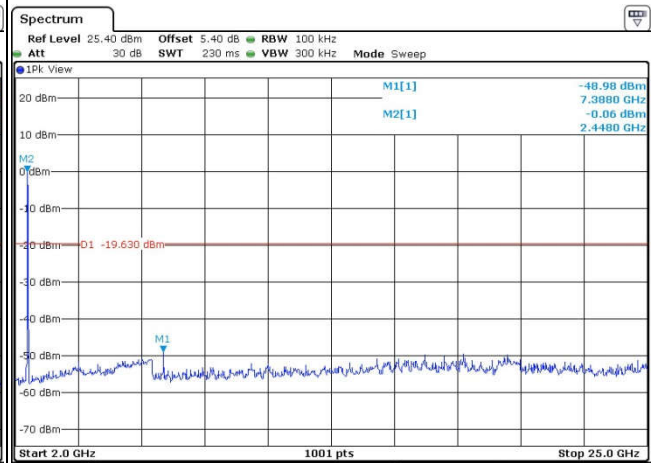

Date: 12.JAN.2018 21:25:24



3.5 Radiated Band Edges and Spurious Emission Measurement

3.5.1 Limit of Radiated band edge and Spurious Emission Measurement

In any 100 kHz bandwidth outside the intentional radiator frequency band, all harmonics/spurious must be at least 20 dB below the highest emission level within the authorized band. If the output power of this device was measured by spectrum analyzer, the attenuation under this paragraph shall be 30 dB instead of 20 dB. In addition, radiated emissions which fall in the restricted bands must also comply with the limits as below.

Frequency (MHz)	Field Strength (microvolts/meter)	Measurement Distance (meters)
0.009 – 0.490	2400/F(kHz)	300
0.490 – 1.705	24000/F(kHz)	30
1.705 – 30.0	30	30
30 – 88	100	3
88 – 216	150	3
216 - 960	200	3
Above 960	500	3

3.5.2 Measuring Instruments

The measuring equipment is listed in the section 4 of this test report.



3.5.3 Test Procedures

1. The testing follows FCC KDB Publication No. 558074 D01 DTS Meas. Guidance v04.
2. The EUT was arranged to its worst case and then tune the antenna tower (from 1 m to 4 m) and turntable (from 0 degree to 360 degrees) to find the maximum reading. A pre-amp and a high pass filter are used for the test in order to get better signal level.
3. The EUT was placed on a turntable with 0.8 meter for frequency below 1GHz and 1.5 meter for frequency above 1GHz respectively above ground.
4. The EUT was set 3 meters from the interference receiving antenna, which was mounted on the top of a variable height antenna tower.
5. Corrected Reading: Antenna Factor + Cable Loss + Read Level - Preamp Factor = Level
6. For measurement below 1GHz, If the emission level of the EUT measured by the peak detector is 3 dB lower than the applicable limit, the peak emission level will be reported. Otherwise, the emission measurement will be repeated using the quasi-peak detector and reported.
7. Use the following spectrum analyzer settings:
 - (1) Span shall wide enough to fully capture the emission being measured;
 - (2) Set RBW=100 kHz for $f < 1$ GHz; VBW \geq RBW; Sweep = auto; Detector function = peak; Trace = max hold;
 - (3) Set RBW = 1 MHz, VBW= 3MHz for $f \geq 1$ GHz for peak measurement.

For average measurement:

 - VBW = 10 Hz, when duty cycle is no less than 98 percent.
 - VBW $\geq 1/T$, when duty cycle is less than 98 percent where T is the minimum transmission duration over which the transmitter is on and is transmitting at its maximum power control level for the tested mode of operation.

3.5.4 Test Setup

For radiated emissions below 30MHz

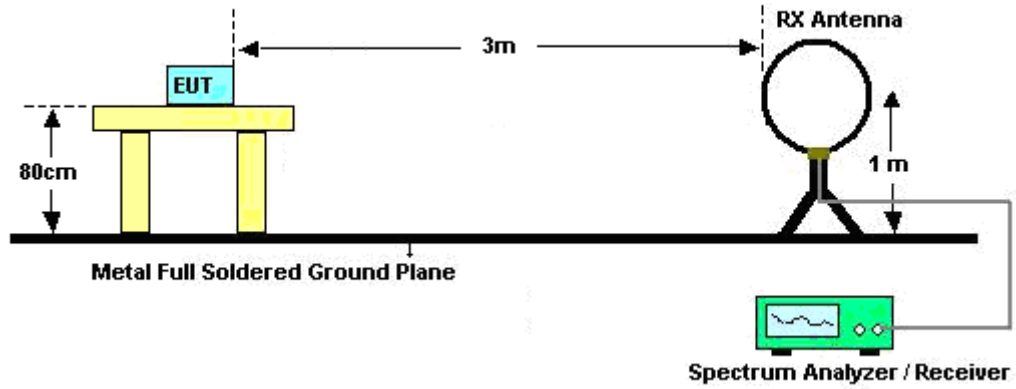

For radiated emissions from 30MHz to 1GHz

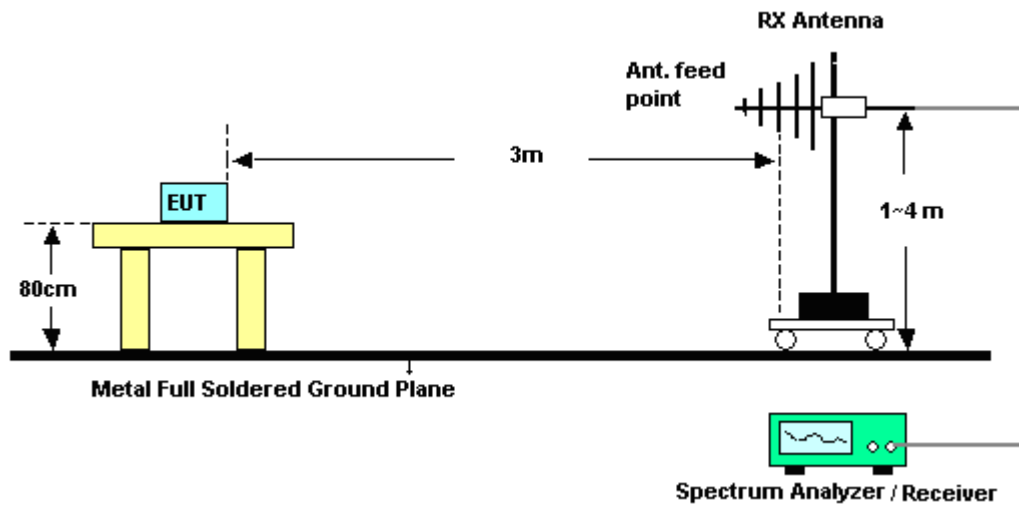

For radiated emissions above 1GHz

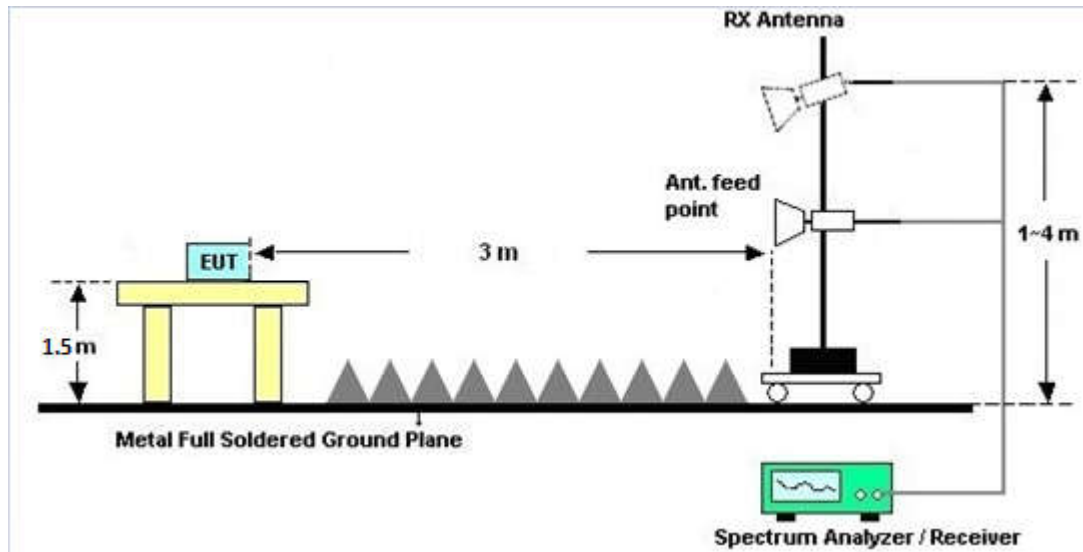

3.5.5 Test Results of Radiated Spurious Emissions (9kHz ~ 30MHz)

The low frequency, which started from 9 kHz to 30MHz, was pre-scanned and the result which was 20dB lower than the limit line was not reported.

3.5.6 Test Result of Radiated Spurious at Band Edges

Please refer to Appendix B.

3.5.7 Duty Cycle

Please refer to Appendix C.

3.5.8 Test Result of Radiated Spurious Emission (30MHz ~ 10th Harmonic)

Please refer to Appendix B.



3.6 AC Conducted Emission Measurement

3.6.1 Limit of AC Conducted Emission

For equipment that is designed to be connected to the public utility (AC) power line, the radio frequency voltage that is conducted back onto the AC power line on any frequency or frequencies within the band 150 kHz to 30 MHz shall not exceed the limits in the following table.

Frequency of Emission (MHz)	Conducted Limit (dBµV)	
	Quasi-Peak	Average
0.15-0.5	66 to 56*	56 to 46*
0.5-5	56	46
5-30	60	50

*Decreases with the logarithm of the frequency.

3.6.2 Measuring Instruments

The measuring equipment is listed in the section 4 of this test report.

3.6.3 Test Procedures

1. The EUT was placed 0.4 meter from the conducting wall of the shielding room, and it was kept at least 80 centimeters from any other grounded conducting surface.
2. Connect EUT to the power mains through a line impedance stabilization network (LISN).
3. All the support units are connecting to the other LISN.
4. The LISN provides 50 ohm coupling impedance for the measuring instrument.
5. The FCC states that a 50 ohm, 50 microhenry LISN should be used.
6. Both sides of AC line were checked for maximum conducted interference.
7. The frequency range from 150 kHz to 30 MHz was searched.
8. Set the test-receiver system to Peak Detect Function and specified bandwidth (IF bandwidth = 9kHz) with Maximum Hold Mode.

3.6.4 Test Setup

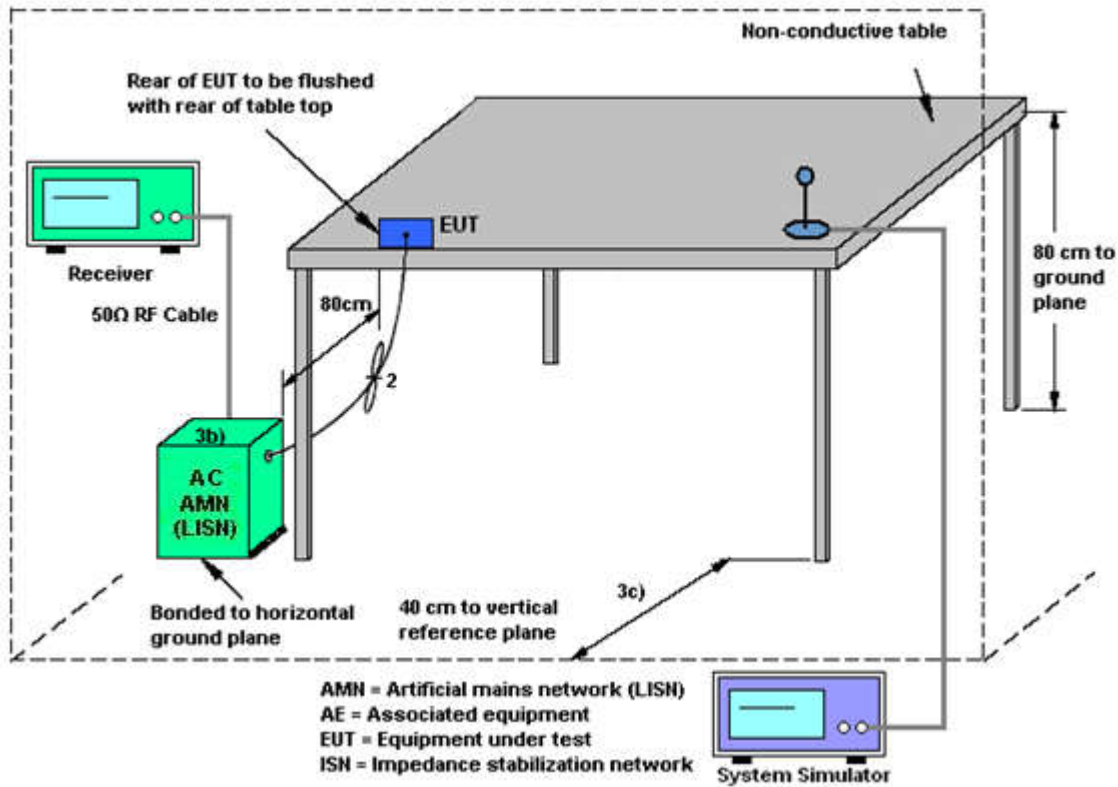



3.6.5 Test Result of AC Conducted Emission

Test Mode :	Mode 2	Temperature :	22~24°C
Test Engineer :	Amos Zhang	Relative Humidity :	42~46%
Test Voltage :	120Vac / 60Hz	Phase :	Line
Function Type :	GSM 850 Idle + Bluetooth Link + WLAN Link (2.4G) + USB Cable (Charging from Adapter2) + Earphone		

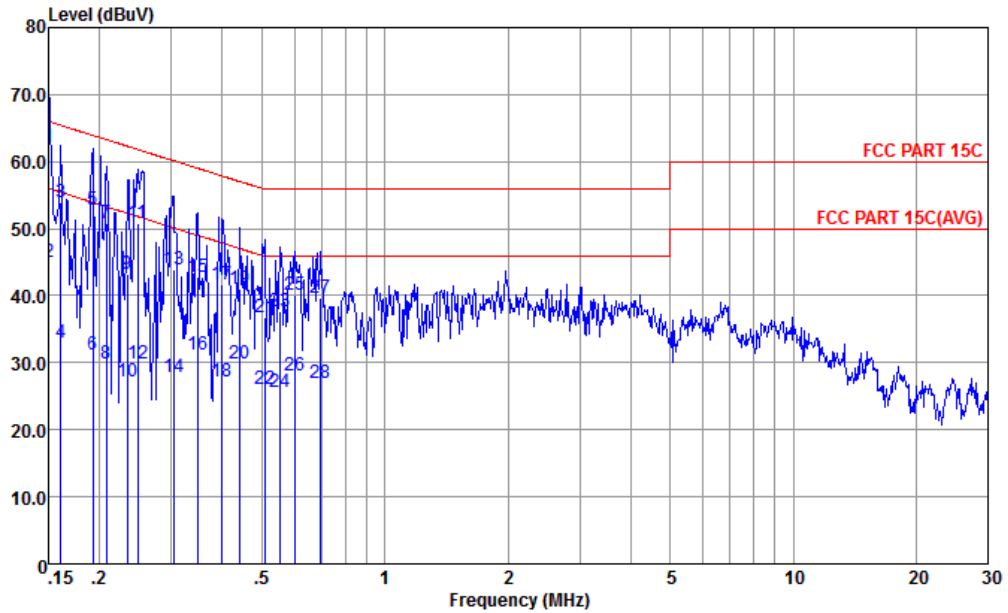

Site : CO01-KS
 Condition : FCC PART 15C LISN-L-171013-060103 LINE
 mode : Mode 2
 : 351892090020962 #8

	Freq	Level	Over Limit	Limit Line	Read Level	LISN Factor	Cable Loss	Remark
	MHz	dBuV	dB	dBuV	dBuV	dB	dB	
1 *	0.150	62.28	-3.72	66.00	51.50	0.16	10.62	QP
2	0.150	45.08	-10.92	56.00	34.30	0.16	10.62	Average
3	0.161	53.95	-11.48	65.43	43.20	0.17	10.58	QP
4	0.161	33.05	-22.38	55.43	22.30	0.17	10.58	Average
5	0.192	52.77	-11.16	63.93	42.09	0.20	10.48	QP
6	0.192	31.27	-22.66	53.93	20.59	0.20	10.48	Average
7	0.208	50.85	-12.42	63.27	40.20	0.20	10.45	QP
8	0.208	29.85	-23.42	53.27	19.20	0.20	10.45	Average
9	0.234	43.25	-19.05	62.30	32.60	0.21	10.44	QP
10	0.234	27.15	-25.15	52.30	16.50	0.21	10.44	Average
11	0.248	50.85	-10.97	61.82	40.20	0.21	10.44	QP
12	0.248	29.95	-21.87	51.82	19.30	0.21	10.44	Average
13	0.303	43.95	-16.20	60.15	33.29	0.23	10.43	QP
14	0.303	27.85	-22.30	50.15	17.19	0.23	10.43	Average
15	0.348	42.85	-16.15	59.00	32.19	0.24	10.42	QP
16	0.348	31.25	-17.75	49.00	20.59	0.24	10.42	Average
17	0.400	41.75	-16.11	57.86	31.09	0.25	10.41	QP



Test Mode :	Mode 2	Temperature :	22~24°C
Test Engineer :	Amos Zhang	Relative Humidity :	42~46%
Test Voltage :	120Vac / 60Hz	Phase :	Line
Function Type :	GSM 850 Idle + Bluetooth Link + WLAN Link (2.4G) + USB Cable (Charging from Adapter2) + Earphone		

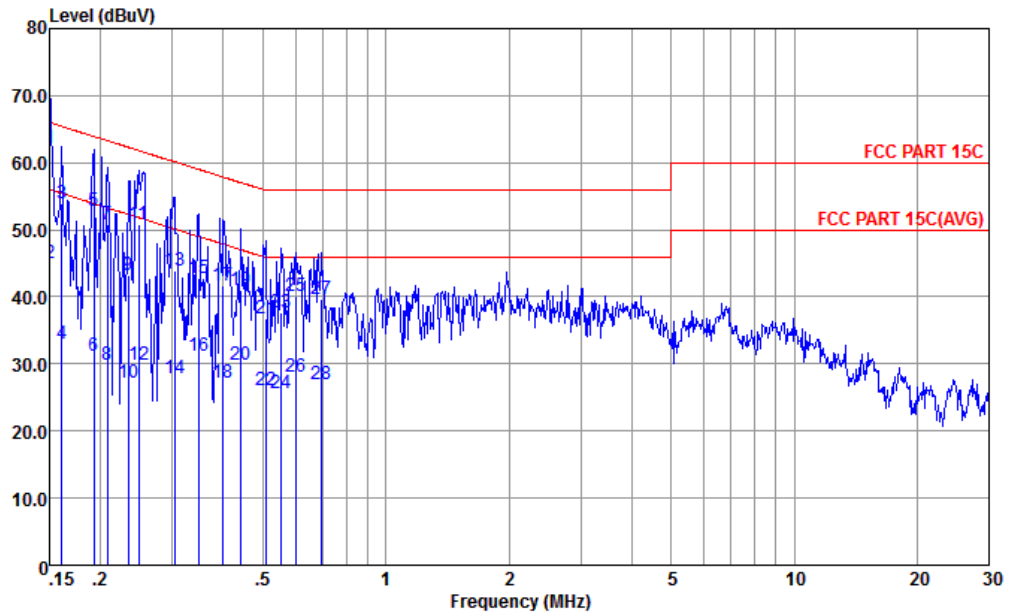

Site : CO01-KS
 Condition : FCC PART 15C LISN-L-171013-060103 LINE

mode : Mode 2
 : 351892090020962 #8

	Freq	Level	Over Limit	Limit Line	Read Level	LISN Factor	Cable Loss	Remark
	MHz	dBuV	dB	dBuV	dBuV	dB	dB	
18	0.400	27.15	-20.71	47.86	16.49	0.25	10.41	Average
19	0.442	40.91	-16.11	57.02	30.30	0.25	10.36	QP
20	0.442	29.81	-17.21	47.02	19.20	0.25	10.36	Average
21	0.507	36.76	-19.24	56.00	26.20	0.26	10.30	QP
22	0.507	26.06	-19.94	46.00	15.50	0.26	10.30	Average
23	0.552	37.72	-18.28	56.00	27.20	0.26	10.26	QP
24	0.552	25.72	-20.28	46.00	15.20	0.26	10.26	Average
25	0.604	40.09	-15.91	56.00	29.60	0.26	10.23	QP
26	0.604	27.99	-18.01	46.00	17.50	0.26	10.23	Average
27	0.697	39.62	-16.38	56.00	29.20	0.26	10.16	QP
28	0.697	27.02	-18.98	46.00	16.60	0.26	10.16	Average



Test Mode :	Mode 2	Temperature :	22~24°C
Test Engineer :	Amos Zhang	Relative Humidity :	42~46%
Test Voltage :	120Vac / 60Hz	Phase :	Neutral
Function Type :	GSM 850 Idle + Bluetooth Link + WLAN Link (2.4G) + USB Cable (Charging from Adapter2) + Earphone		

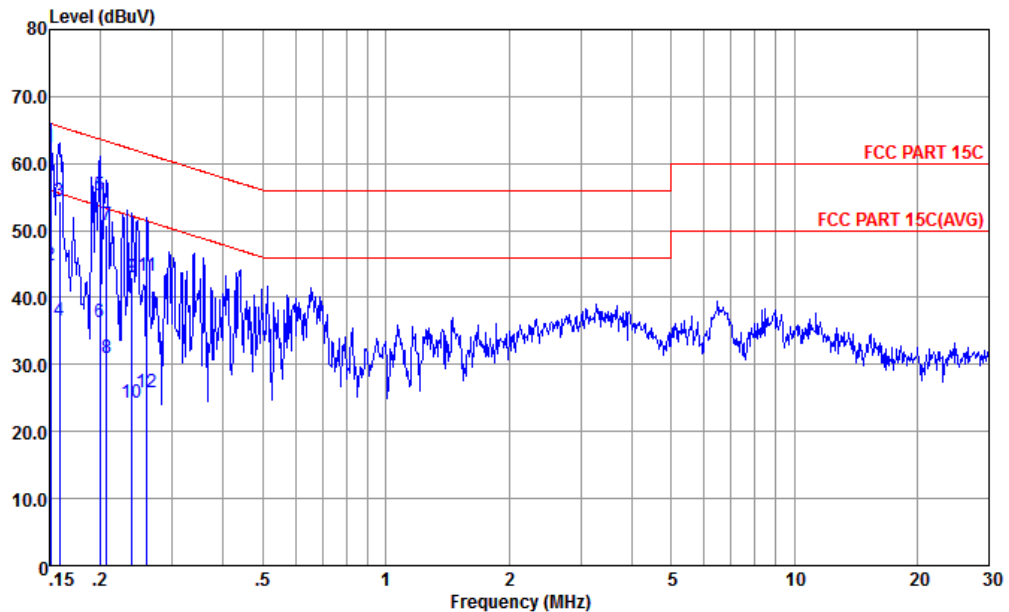

Site : CO01-KS
 Condition : FCC PART 15C LISN-N-171013-060103 NEUTRAL

mode : Mode 2
 : 351892090020962 #8

	Freq	Level	Over Limit	Limit Line	Read Level	LISN Factor	Cable Loss	Remark
	MHz	dBuV	dB	dBuV	dBuV	dB	dB	
1 *	0.151	62.30	-3.66	65.96	51.40	0.28	10.62	QP
2	0.151	44.70	-11.26	55.96	33.80	0.28	10.62	Average
3	0.159	54.47	-11.05	65.52	43.60	0.28	10.59	QP
4	0.159	36.47	-19.05	55.52	25.60	0.28	10.59	Average
5	0.200	55.24	-8.38	63.62	44.50	0.28	10.46	QP
6	0.200	36.34	-17.28	53.62	25.60	0.28	10.46	Average
7	0.207	50.83	-12.49	63.32	40.10	0.28	10.45	QP
8	0.207	30.93	-22.39	53.32	20.20	0.28	10.45	Average
9	0.239	42.92	-19.21	62.13	32.20	0.28	10.44	QP
10	0.239	24.32	-27.81	52.13	13.60	0.28	10.44	Average
11	0.260	43.22	-18.20	61.42	32.50	0.28	10.44	QP
12	0.260	25.92	-25.50	51.42	15.20	0.28	10.44	Average



3.7 Antenna Requirements

3.7.1 Standard Applicable

If directional gain of transmitting antennas is greater than 6dBi, the power shall be reduced by the same level in dB comparing to gain minus 6dBi. For the fixed point-to-point operation, the power shall be reduced by one dB for every 3 dB that the directional gain of the antenna exceeds 6 dBi. The use of a permanently attached antenna or of an antenna that uses a unique coupling to the intentional radiator shall be considered sufficient to comply with the rule.

3.7.2 Antenna Anti-Replacement Construction

An embedded-in antenna design is used.

3.7.3 Antenna Gain

The antenna peak gain of EUT is less than 6 dBi. Therefore, it is not necessary to reduce maximum peak output power limit.



4 List of Measuring Equipment

Instrument	Manufacturer	Model No.	Serial No.	Characteristics	Calibration Date	Test Date	Due Date	Remark
Spectrum Analyzer	R&S	FSV40	101040	10Hz~40GHz	Aug. 08, 2017	Jan. 12, 2018	Aug. 07, 2018	Conducted (TH01-KS)
Pulse Power Sensor	Anritsu	MA2411B	0917070	300MHz~40GHz	Jan. 19, 2017	Jan. 12, 2018	Jan. 18, 2018	Conducted (TH01-KS)
Power Meter	Anritsu	ML2495A	1005002	50MHz Bandwidth	Jan. 19, 2017	Jan. 12, 2018	Jan. 18, 2018	Conducted (TH01-KS)
Amplifier	SONOMA	310N	187311	9kHz~1GHz	Oct. 19, 2017	Jan. 18, 2018~Jan. 28, 2018	Oct. 18, 2018	Radiation (03CH10-HY)
Amplifier	MITEQ	TTA1840-35-HG	1871923	18GHz~40GHz, VSWR : 2.5:1 max	Jul. 18, 2017	Jan. 18, 2018~Jan. 28, 2018	Jul. 17, 2018	Radiation (03CH10-HY)
Bilog Antenna	TESEQ	CBL 6111D&00800 N1D01N-06	35413&02	30MHz~1GHz	Dec. 18, 2017	Jan. 18, 2018~Jan. 28, 2018	Dec. 17, 2018	Radiation (03CH10-HY)
Horn Antenna	SCHWARZBECK	BBHA 9120 D	9120D-1325	1GHz ~ 18GHz	Sep. 27, 2017	Jan. 18, 2018~Jan. 28, 2018	Sep. 26, 2018	Radiation (03CH10-HY)
Preamplifier	Keysight	83017A	MY53270078	1GHz~26.5GHz	Oct. 25, 2017	Jan. 18, 2018~Jan. 28, 2018	Oct. 24, 2018	Radiation (03CH10-HY)
Preamplifier	Jet-Power	JAP00101800-30-10P	160118550004	1GHz~18GHz	Apr. 13, 2017	Jan. 18, 2018~Jan. 28, 2018	Apr. 12, 2018	Radiation (03CH10-HY)
Spectrum Analyzer	Keysight	N9010A	MY54200485	10Hz ~ 44GHz	Oct. 31, 2017	Jan. 18, 2018~Jan. 28, 2018	Oct. 30, 2018	Radiation (03CH10-HY)
Controller	EMEC	EM 1000	N/A	Control Turn table & Ant Mast	N/A	Jan. 18, 2018~Jan. 28, 2018	N/A	Radiation (03CH10-HY)
Antenna Mast	EMEC	AM-BS-4500-B	N/A	1~4m	N/A	Jan. 18, 2018~Jan. 28, 2018	N/A	Radiation (03CH10-HY)
Turn Table	EMEC	TT 2200	N/A	0~360 Degree	N/A	Jan. 18, 2018~Jan. 28, 2018	N/A	Radiation (03CH10-HY)
Loop Antenna	Rohde & Schwarz	HFH2-Z2	100488	9 kHz~30 MHz	Nov. 23, 2017	Jan. 18, 2018~Jan. 28, 2018	Nov. 22, 2019	Radiation (03CH10-HY)
EMI Test Receiver	Agilent	N9038A(MXE)	MY53290053	20Hz to 26.5GHz	Jan. 16, 2018	Jan. 18, 2018~Jan. 28, 2018	Jan. 15, 2019	Radiation (03CH10-HY)
SHF-EHF Horn Antenna	SCHWARZBECK	BBHA 9170	BBHA9170584	18GHz- 40GHz	Nov. 27, 2017	Jan. 18, 2018~Jan. 28, 2018	Nov. 26, 2018	Radiation (03CH10-HY)
EMI Receiver	R&S	ESC17	100768	9kHz~7GHz;	Apr. 20, 2017	Jan. 08, 2018	Apr. 19, 2018	Conduction (CO01-KS)
AC LISN	MessTec	AN3016	060103	9kHz~30MHz	Oct. 13, 2017	Jan. 08, 2018	Oct. 12, 2018	Conduction (CO01-KS)
AC LISN (for auxiliary equipment)	MessTec	AN3016	060105	9kHz~30MHz	Oct. 13, 2017	Jan. 08, 2018	Oct. 12, 2018	Conduction (CO01-KS)
AC Power Source	Chroma	61602	ABP00000811	AC 0V~300V, 45Hz~1000Hz	Oct. 12, 2017	Jan. 08, 2018	Oct. 11, 2018	Conduction (CO01-KS)

NCR: No Calibration Required



5 Uncertainty of Evaluation

Uncertainty of Conducted Emission Measurement (150kHz ~ 30MHz)

Measuring Uncertainty for a Level of Confidence of 95% ($U = 2Uc(y)$)	2.3dB
---	-------

Uncertainty of Radiated Emission Measurement (30 MHz ~ 1000 MHz)

Measuring Uncertainty for a Level of Confidence of 95% ($U = 2Uc(y)$)	5.6dB
---	-------

Uncertainty of Radiated Emission Measurement (1000 MHz ~ 18000 MHz)

Measuring Uncertainty for a Level of Confidence of 95% ($U = 2Uc(y)$)	5.9dB
---	-------

Uncertainty of Radiated Emission Measurement (18000 MHz ~ 40000 MHz)

Measuring Uncertainty for a Level of Confidence of 95% ($U = 2Uc(y)$)	5.2dB
---	-------



Appendix A. Conducted Test Results

A1 - DTS Part

Test Engineer:	Silent Hai	Temperature:	21~25	°C
Test Date:	2017/1/12	Relative Humidity:	51~55	%

TEST RESULTS DATA
6dB and 99% Occupied Bandwidth

2.4GHz Band								
Mod.	Data Rate	NTX	CH.	Freq. (MHz)	99% Occupied BW (MHz)	6dB BW (MHz)	6dB BW Limit (MHz)	Pass/Fail
11b	1Mbps	1	1	2412	12.69	7.07	0.50	Pass
11b	1Mbps	1	6	2437	12.84	7.09	0.50	Pass
11b	1Mbps	1	11	2462	12.79	7.09	0.50	Pass
11g	6Mbps	1	1	2412	18.78	16.34	0.50	Pass
11g	6Mbps	1	6	2437	18.88	16.34	0.50	Pass
11g	6Mbps	1	11	2462	18.83	16.32	0.50	Pass
HT20	MCS0	1	1	2412	19.43	17.56	0.50	Pass
HT20	MCS0	1	6	2437	19.73	17.58	0.50	Pass
HT20	MCS0	1	11	2462	19.28	17.56	0.50	Pass

TEST RESULTS DATA
Peak Power Table

2.4GHz Band										
Mod.	Data Rate	NTX	CH.	Freq. (MHz)	Peak Conducted Power (dBm)	Conducted Power Limit (dBm)	DG (dBi)	EIRP Power (dBm)	EIRP Power Limit (dBm)	Pass /Fail
11b	1Mbps	1	1	2412	20.37	30.00	-0.65	19.72	36.00	Pass
11b	1Mbps	1	6	2437	19.59	30.00	-0.65	18.94	36.00	Pass
11b	1Mbps	1	11	2462	20.56	30.00	-0.65	19.91	36.00	Pass
11g	6Mbps	1	1	2412	22.76	30.00	-0.65	22.11	36.00	Pass
11g	6Mbps	1	6	2437	22.48	30.00	-0.65	21.83	36.00	Pass
11g	6Mbps	1	11	2462	22.29	30.00	-0.65	21.64	36.00	Pass
HT20	MCS0	1	1	2412	21.16	30.00	-0.65	20.51	36.00	Pass
HT20	MCS0	1	6	2437	21.09	30.00	-0.65	20.44	36.00	Pass
HT20	MCS0	1	11	2462	21.36	30.00	-0.65	20.71	36.00	Pass

TEST RESULTS DATA
Average Power Table
(Reporting Only)

2.4GHz Band						
Mod.	Data Rate	NTX	CH.	Freq. (MHz)	Duty Factor (dB)	Average Conducted Power (dBm)
11b	1Mbps	1	1	2412	0.11	17.53
11b	1Mbps	1	6	2437	0.11	16.77
11b	1Mbps	1	11	2462	0.11	17.44
11g	6Mbps	1	1	2412	0.60	15.51
11g	6Mbps	1	6	2437	0.60	14.68
11g	6Mbps	1	11	2462	0.60	14.15
HT20	MCS0	1	1	2412	0.63	12.55
HT20	MCS0	1	6	2437	0.63	12.28
HT20	MCS0	1	11	2462	0.63	12.52

TEST RESULTS DATA
Peak Power Density

2.4GHz Band								
Mod.	Data Rate	NTX	CH.	Freq. (MHz)	Peak PSD (dBm /3kHz)	DG (dBi)	Peak PSD Limit (dBm /3kHz)	Pass/Fail
11b	1Mbps	1	1	2412	-5.06	-0.65	8.00	Pass
11b	1Mbps	1	6	2437	-6.48	-0.65	8.00	Pass
11b	1Mbps	1	11	2462	-5.74	-0.65	8.00	Pass
11g	6Mbps	1	1	2412	-11.07	-0.65	8.00	Pass
11g	6Mbps	1	6	2437	-10.33	-0.65	8.00	Pass
11g	6Mbps	1	11	2462	-11.16	-0.65	8.00	Pass
HT20	MCS0	1	1	2412	-14.16	-0.65	8.00	Pass
HT20	MCS0	1	6	2437	-15.27	-0.65	8.00	Pass
HT20	MCS0	1	11	2462	-13.83	-0.65	8.00	Pass



Appendix B. Radiated Spurious Emission

2.4GHz 2400~2483.5MHz

WIFI 802.11b (Band Edge @ 3m)

WIFI	Note	Frequency	Level	Over	Limit	Read	Antenna	Cable	Preamp	Ant	Table	Peak	Pol.
Ant.				Limit	Line	Level	Factor	Loss	Factor	Pos	Pos	Avg.	
1		(MHz)	(dBμV/m)	(dB)	(dBμV/m)	(dBμV)	(dB/m)	(dB)	(dB)	(cm)	(deg)	(P/A)	(H/V)
802.11b CH 01 2412MHz		2373.63	52.21	-21.79	74	42.97	27.06	5.36	33.16	248	19	P	H
		2387.28	42.13	-11.87	54	32.81	27.11	5.39	33.16	248	19	A	H
	*	2412	105.7	-	-	96.28	27.16	5.43	33.15	248	19	P	H
	*	2412	102.4	-	-	92.98	27.16	5.43	33.15	248	19	A	H
		2388.54	52.02	-21.98	74	42.7	27.11	5.39	33.16	196	294	P	V
		2387.7	42.02	-11.98	54	32.7	27.11	5.39	33.16	196	294	A	V
	*	2412	102.22	-	-	92.8	27.16	5.43	33.15	196	294	P	V
	*	2412	98.52	-	-	89.1	27.16	5.43	33.15	196	294	A	V
802.11b CH 06 2437MHz		2333.38	51.74	-22.26	74	42.7	26.92	5.32	33.18	248	21	P	H
		2389.94	41.42	-12.58	54	32.09	27.11	5.39	33.15	248	21	A	H
	*	2437	108.37	-	-	98.82	27.26	5.45	33.14	248	21	P	H
	*	2437	105.33	-	-	95.78	27.26	5.45	33.14	248	21	A	H
		2493.77	51.6	-22.4	74	41.82	27.4	5.5	33.1	248	21	P	H
		2489.92	41.86	-12.14	54	32.09	27.4	5.5	33.11	248	21	A	H
		2329.46	51.41	-22.59	74	42.37	26.92	5.32	33.18	191	284	P	V
		2387.84	41.35	-12.65	54	32.03	27.11	5.39	33.16	191	284	A	V
	*	2437	104.49	-	-	94.94	27.26	5.45	33.14	191	284	P	V
	*	2437	100.43	-	-	90.88	27.26	5.45	33.14	191	284	A	V
		2498.95	52.2	-21.8	74	42.42	27.4	5.5	33.1	191	284	P	V
	2489.43	41.91	-12.09	54	32.14	27.4	5.5	33.11	191	284	A	V	



802.11b CH 11 2462MHz	*	2462	105.44	-	-	95.82	27.3	5.46	33.12	188	8	P	H
	*	2462	102.1	-	-	92.48	27.3	5.46	33.12	188	8	A	H
		2486.48	52.55	-21.45	74	42.83	27.35	5.5	33.11	188	8	P	H
		2486.64	42.99	-11.01	54	33.27	27.35	5.5	33.11	188	8	A	H
	*	2462	101.52	-	-	91.9	27.3	5.46	33.12	185	284	P	V
	*	2462	98.27	-	-	88.65	27.3	5.46	33.12	185	284	A	V
		2487.96	52.68	-21.32	74	42.91	27.4	5.5	33.11	185	284	P	V
		2486.56	42.67	-11.33	54	32.95	27.35	5.5	33.11	185	284	A	V
Remark	1. No other spurious found. 2. All results are PASS against Peak and Average limit line.												



2.4GHz 2400~2483.5MHz
WIFI 802.11b (Harmonic @ 3m)

Table with 14 columns: WIFI Ant. 1, Note, Frequency (MHz), Level (dBµV/m), Over Limit (dB), Limit Line (dBµV/m), Read Level (dBµV), Antenna Factor (dB/m), Cable Loss (dB), Preamp Factor (dB), Ant Pos (cm), Table Pos (deg), Peak Avg. (P/A), Pol. (H/V). Rows include data for CH 01 (2412MHz) and CH 06 (2437MHz) and CH 11 (2462MHz).



**2.4GHz 2400~2483.5MHz
WIFI 802.11g (Band Edge @ 3m)**

WIFI Ant. 1	Note	Frequency (MHz)	Level (dBμV/m)	Over Limit (dB)	Limit Line (dBμV/m)	Read Level (dBμV)	Antenna Factor (dB/m)	Cable Loss (dB)	Preamp Factor (dB)	Ant Pos (cm)	Table Pos (deg)	Peak Avg. (P/A)	Pol. (H/V)
802.11g CH 01 2412MHz		2389.905	64.54	-9.46	74	55.21	27.11	5.39	33.15	194	18	P	H
		2390	50.93	-3.07	54	41.6	27.11	5.39	33.15	194	18	A	H
	*	2412	105.73	-	-	96.31	27.16	5.43	33.15	194	18	P	H
	*	2412	98.15	-	-	88.73	27.16	5.43	33.15	194	18	A	H
		2389.905	63.79	-10.21	74	54.46	27.11	5.39	33.15	218	229	P	V
		2390	47.69	-6.31	54	38.36	27.11	5.39	33.15	218	229	A	V
	*	2412	101.82	-	-	92.4	27.16	5.43	33.15	218	229	P	V
	*	2412	93.95	-	-	84.53	27.16	5.43	33.15	218	229	A	V
802.11g CH 06 2437MHz		2385.18	52.48	-21.52	74	43.21	27.06	5.39	33.16	170	18	P	H
		2384.9	43.54	-10.46	54	34.27	27.06	5.39	33.16	170	18	A	H
	*	2437	107.46	-	-	97.91	27.26	5.45	33.14	170	18	P	H
	*	2437	99.81	-	-	90.26	27.26	5.45	33.14	170	18	A	H
		2485.16	54.43	-19.57	74	44.71	27.35	5.5	33.11	170	18	P	H
		2489.08	43.9	-10.1	54	34.13	27.4	5.5	33.11	170	18	A	H
		2388.54	51.68	-22.32	74	42.36	27.11	5.39	33.16	192	244	P	V
		2384.76	42.65	-11.35	54	33.38	27.06	5.39	33.16	192	244	A	V
	*	2437	102.95	-	-	93.4	27.26	5.45	33.14	192	244	P	V
	*	2437	95.27	-	-	85.72	27.26	5.45	33.14	192	244	A	V
		2489.01	52.28	-21.72	74	42.51	27.4	5.5	33.11	192	244	P	V
		2489.08	43.07	-10.93	54	33.3	27.4	5.5	33.11	192	244	A	V



802.11g CH 11 2462MHz	*	2462	104.96	-	-	95.34	27.3	5.46	33.12	162	18	P	H
	*	2462	97.17	-	-	87.55	27.3	5.46	33.12	162	18	A	H
		2483.84	65.81	-8.19	74	56.09	27.35	5.5	33.11	162	18	P	H
		2483.6	50.85	-3.15	54	41.13	27.35	5.5	33.11	162	18	A	H
	*	2462	100.74	-	-	91.12	27.3	5.46	33.12	208	250	P	V
	*	2462	92.91	-	-	83.29	27.3	5.46	33.12	208	250	A	V
		2483.72	61.13	-12.87	74	51.41	27.35	5.5	33.11	208	250	P	V
		2483.56	46.8	-7.2	54	37.08	27.35	5.5	33.11	208	250	A	V
Remark	<ol style="list-style-type: none"> No other spurious found. All results are PASS against Peak and Average limit line. 												



2.4GHz 2400~2483.5MHz
WIFI 802.11g (Harmonic @ 3m)

Table with 14 columns: WIFI Ant. 1, Note, Frequency (MHz), Level (dBµV/m), Over Limit (dB), Limit Line (dBµV/m), Read Level (dBµV), Antenna Factor (dB/m), Cable Loss (dB), Preamp Factor (dB), Ant Pos (cm), Table Pos (deg), Peak Avg. (P/A), Pol. (H/V). Rows include test results for 802.11g CH 01 (2412MHz), CH 06 (2437MHz), and CH 11 (2462MHz).



**2.4GHz 2400~2483.5MHz
WIFI 802.11n HT20 (Band Edge @ 3m)**

WIFI Ant. 1	Note	Frequency (MHz)	Level (dBμV/m)	Over Limit (dB)	Limit Line (dBμV/m)	Read Level (dBμV)	Antenna Factor (dB/m)	Cable Loss (dB)	Preamp Factor (dB)	Ant Pos (cm)	Table Pos (deg)	Peak Avg. (P/A)	Pol. (H/V)
802.11n HT20 CH 01 2412MHz		2389.695	60.94	-13.06	74	51.62	27.11	5.39	33.16	166	17	P	H
		2390	46.61	-7.39	54	37.28	27.11	5.39	33.15	166	17	A	H
	*	2412	102.82	-	-	93.4	27.16	5.43	33.15	166	17	P	H
	*	2412	95.23	-	-	85.81	27.16	5.43	33.15	166	17	A	H
		2389.695	53.09	-20.91	74	43.77	27.11	5.39	33.16	217	230	P	V
		2390	44.04	-9.96	54	34.71	27.11	5.39	33.15	217	230	A	V
	*	2412	98.95	-	-	89.53	27.16	5.43	33.15	217	230	P	V
	*	2412	91.15	-	-	81.73	27.16	5.43	33.15	217	230	A	V
802.11n HT20 CH 06 2437MHz		2326.1	52.05	-21.95	74	43.01	26.92	5.32	33.18	167	18	P	H
		2385.6	42.95	-11.05	54	33.63	27.11	5.39	33.16	167	18	A	H
	*	2437	104.46	-	-	94.91	27.26	5.45	33.14	167	18	P	H
	*	2437	96.61	-	-	87.06	27.26	5.45	33.14	167	18	A	H
		2489.64	53.7	-20.3	74	43.93	27.4	5.5	33.11	167	18	P	H
		2488.59	43.55	-10.45	54	33.78	27.4	5.5	33.11	167	18	A	H
		2388.96	51.93	-22.07	74	42.61	27.11	5.39	33.16	221	251	P	V
		2385.32	42.05	-11.95	54	32.78	27.06	5.39	33.16	221	251	A	V
	*	2437	99.62	-	-	90.07	27.26	5.45	33.14	221	251	P	V
	*	2437	91.92	-	-	82.37	27.26	5.45	33.14	221	251	A	V
		2488.8	52.5	-21.5	74	42.73	27.4	5.5	33.11	221	251	P	V
	2489.43	42.47	-11.53	54	32.7	27.4	5.5	33.11	221	251	A	V	



802.11n HT20 CH 11 2462MHz	*	2462	102.66	-	-	93.04	27.3	5.46	33.12	137	19	P	H
	*	2462	95.08	-	-	85.46	27.3	5.46	33.12	137	19	A	H
		2485.56	59.73	-14.27	74	50.01	27.35	5.5	33.11	137	19	P	H
		2483.64	47.98	-6.02	54	38.26	27.35	5.5	33.11	137	19	A	H
	*	2462	98.25	-	-	88.63	27.3	5.46	33.12	209	248	P	V
	*	2462	90.59	-	-	80.97	27.3	5.46	33.12	209	248	A	V
		2484.72	55.67	-18.33	74	45.95	27.35	5.5	33.11	209	248	P	V
	2483.52	45.21	-8.79	54	35.49	27.35	5.5	33.11	209	248	A	V	
Remark	<ol style="list-style-type: none"> No other spurious found. All results are PASS against Peak and Average limit line. 												



2.4GHz 2400~2483.5MHz
WIFI 802.11n HT20 (Harmonic @ 3m)

WIFI Ant. 1	Note	Frequency (MHz)	Level (dBμV/m)	Over Limit (dB)	Limit Line (dBμV/m)	Read Level (dBμV)	Antenna Factor (dB/m)	Cable Loss (dB)	Preamp Factor (dB)	Ant Pos (cm)	Table Pos (deg)	Peak Avg. (P/A)	Pol. (H/V)
802.11n HT20 CH 01 2412MHz		4824	39.9	-34.1	74	64.17	31.19	8.41	64.36	100	0	P	H
		4824	39.05	-34.95	74	63.32	31.19	8.41	64.36	100	0	P	V
802.11n HT20 CH 06 2437MHz		4874	38.55	-35.45	74	62.81	31.28	8.38	64.4	100	0	P	H
		7311	42.66	-31.34	74	61.51	36.18	10.12	65.55	100	0	P	H
		4874	39.14	-34.86	74	63.4	31.28	8.38	64.4	100	0	P	V
		7311	42.71	-31.29	74	61.56	36.18	10.12	65.55	100	0	P	V
802.11n HT20 CH 11 2462MHz		4924	39.22	-34.78	74	63.44	31.38	8.37	64.44	100	0	P	H
		7386	42.97	-31.03	74	61.78	36.37	10.09	65.62	100	0	P	H
		4924	38.92	-35.08	74	63.14	31.38	8.37	64.44	100	0	P	V
		7386	42.79	-31.21	74	61.6	36.37	10.09	65.62	100	0	P	V
Remark	1. No other spurious found. 2. All results are PASS against Peak and Average limit line.												



2.4GHz 2400~2483.5MHz

Emission below 1GHz

2.4GHz WIFI 802.11g (LF)

WIFI	Note	Frequency	Level	Over	Limit	Read	Antenna	Cable	Preamp	Ant	Table	Peak	Pol.
Ant.				Limit	Line	Level	Factor	Loss	Factor	Pos	Pos	Avg.	
1		(MHz)	(dBμV/m)	(dB)	(dBμV/m)	(dBμV)	(dB/m)	(dB)	(dB)	(cm)	(deg)	(P/A)	(H/V)
2.4GHz 802.11g LF		102.9	22.04	-21.46	43.5	37.14	16.32	1.05	32.71			P	H
		162.03	24.43	-19.07	43.5	38.9	16.45	1.33	32.67			P	H
		270.57	28.33	-17.67	46	39.59	19.21	1.72	32.6			P	H
		552	26.99	-19.01	46	31.31	25.35	2.47	32.73			P	H
		711.6	29.04	-16.96	46	31.44	26.95	2.83	32.76			P	H
		944	33.9	-12.1	46	31.03	30.37	3.29	31.59	100	0	P	H
		41.34	29.82	-10.18	40	43.27	18.42	0.78	32.77	100	0	P	V
		161.22	22.6	-20.9	43.5	36.97	16.55	1.33	32.67			P	V
		256.53	23.08	-22.92	46	34.19	19.36	1.72	32.61			P	V
		508.6	24.57	-21.43	46	30.4	23.92	2.4	32.66			P	V
		648.6	29.07	-16.93	46	32.14	26.45	2.68	32.8			P	V
	876.1	31.75	-14.25	46	31	29.12	3.16	32.22			P	V	
Remark	1. No other spurious found. 2. All results are PASS against limit line.												



Note symbol

*	Fundamental Frequency which can be ignored. However, the level of any unwanted emissions shall not exceed the level of the fundamental frequency.
!	Test result is over limit line.
P/A	Peak or Average
H/V	Horizontal or Vertical



A calculation example for radiated spurious emission is shown as below:

WIFI	Note	Frequency	Level	Over	Limit	Read	Antenna	Cable	Preamp	Ant	Table	Peak	Pol.
Ant.				Limit	Line	Level	Factor	Loss	Factor	Pos	Pos	Avg.	
1		(MHz)	(dBμV/m)	(dB)	(dBμV/m)	(dBμV)	(dB/m)	(dB)	(dB)	(cm)	(deg)	(P/A)	(H/V)
802.11b		2390	55.45	-18.55	74	54.51	32.22	4.58	35.86	103	308	P	H
CH 01													
2412MHz		2390	43.54	-10.46	54	42.6	32.22	4.58	35.86	103	308	A	H

- Level(dBμV/m) =
Antenna Factor(dB/m) + Cable Loss(dB) + Read Level(dBμV) - Preamp Factor(dB)
- Over Limit(dB) = Level(dBμV/m) – Limit Line(dBμV/m)

For Peak Limit @ 2390MHz:

- Level(dBμV/m)
= Antenna Factor(dB/m) + Cable Loss(dB) + Read Level(dBμV) - Preamp Factor(dB)
= 32.22(dB/m) + 4.58(dB) + 54.51(dBμV) – 35.86 (dB)
= 55.45 (dBμV/m)
- Over Limit(dB)
= Level(dBμV/m) – Limit Line(dBμV/m)
= 55.45(dBμV/m) – 74(dBμV/m)
= -18.55(dB)

For Average Limit @ 2390MHz:

- Level(dBμV/m)
= Antenna Factor(dB/m) + Cable Loss(dB) + Read Level(dBμV) - Preamp Factor(dB)
= 32.22(dB/m) + 4.58(dB) + 42.6(dBμV) – 35.86 (dB)
= 43.54 (dBμV/m)
- Over Limit(dB)
= Level(dBμV/m) – Limit Line(dBμV/m)
= 43.54(dBμV/m) – 54(dBμV/m)
= -10.46(dB)

Both peak and average measured complies with the limit line, so test result is “PASS”.



Appendix C. Duty Cycle Plots

Band	Duty Cycle(%)	T(ms)	1/T(kHz)	VBW Setting
802.11b	97.59	8.232	0.121	300Hz
802.11g	87.04	1.362	0.734	1kHz
802.11n HT20	86.58	1.281	0.781	1kHz

802.11b

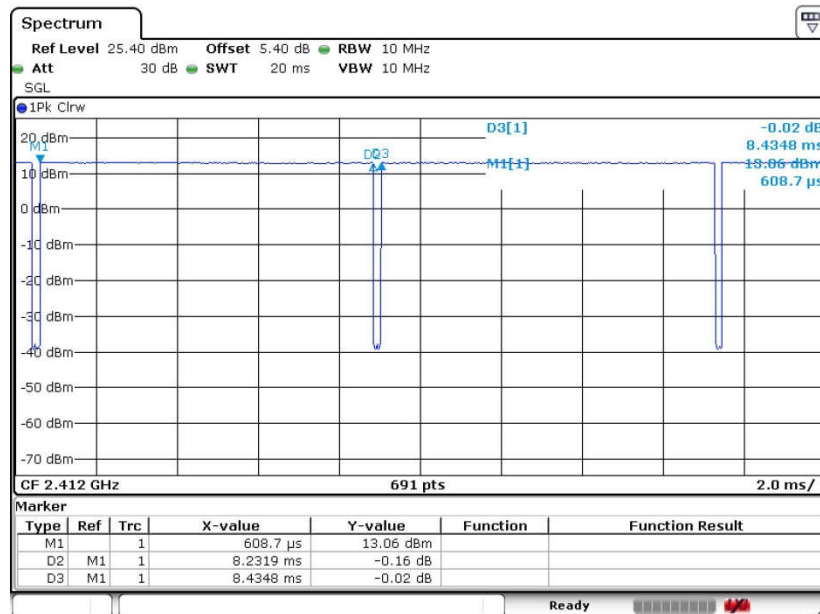



802.11g

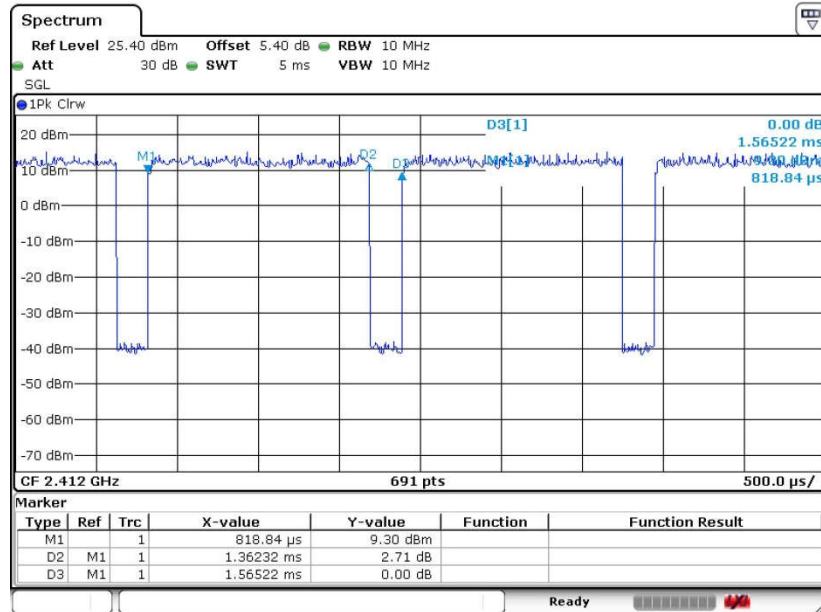

802.11n HT20

