



# FCC RF Test Report

**APPLICANT** : Motorola Mobility LLC  
**EQUIPMENT** : Mobile Cellular Phone  
**BRAND NAME** : Motorola  
**MODEL NAME** : 10566  
**FCC ID** : IHDT56WG1  
**STANDARD** : FCC Part 15 Subpart C §15.247  
**CLASSIFICATION** : (DTS) Digital Transmission System

The product was received on Mar. 22, 2017 and testing was completed on Apr. 27, 2017. We, Sporton International (KunShan) INC., would like to declare that the tested sample has been evaluated in accordance with the test procedures and has been in compliance with the applicable technical standards.

The test results in this report apply exclusively to the tested model / sample. Without written approval of Sporton International (KunShan) INC., the test report shall not be reproduced except in full.

Prepared by: James Huang / Manager



Approved by: Jones Tsai / Manager

**Sporton International (KunShan) INC.**  
**No.3-2, Pingxiang Road, Kunshan Development Zone, Jiangsu, China**



# TABLE OF CONTENTS

**REVISION HISTORY.....3**

**SUMMARY OF TEST RESULT .....4**

**1 GENERAL DESCRIPTION .....5**

    1.1 Applicant .....5

    1.2 Manufacturer .....5

    1.3 Product Feature of Equipment Under Test.....5

    1.4 Product Specification of Equipment Under Test.....6

    1.5 Specification of Accessory .....6

    1.6 Modification of EUT .....6

    1.7 Testing Location .....7

    1.8 Applicable Standards.....7

**2 TEST CONFIGURATION OF EQUIPMENT UNDER TEST .....8**

    2.1 Carrier Frequency and Channel .....8

    2.2 Test Mode.....9

    2.3 Connection Diagram of Test System.....10

    2.4 Support Unit used in test configuration and system .....12

    2.5 EUT Operation Test Setup .....12

**3 TEST RESULT .....13**

    3.1 Radiated Band Edges and Spurious Emission Measurement .....13

    3.2 AC Conducted Emission Measurement.....17

    3.3 Antenna Requirements .....21

**4 LIST OF MEASURING EQUIPMENT .....22**

**5 UNCERTAINTY OF EVALUATION .....23**

**APPENDIX A. RADIATED SPURIOUS EMISSION**

**APPENDIX B. DUTY CYCLE PLOTS**

**APPENDIX C. SETUP PHOTOGRAPHS**

**APPENDIX D. PRODUCT EQUALITY DECLARATION**





### SUMMARY OF TEST RESULT

Report Section	FCC Rule	Description	Limit	Result	Remark
3.1	15.247(d)	Radiated Band Edges and Radiated Spurious Emission	15.209(a) & 15.247(d)	Pass	Under limit 5.36 dB at 37.760 MHz
3.2	15.207	AC Conducted Emission	15.207(a)	Pass	Under limit 15.69 dB at 0.476 MHz
3.3	15.203 & 15.247(b)	Antenna Requirement	N/A	Pass	-



# 1 General Description

## 1.1 Applicant

Motorola Mobility LLC  
222 W, Merchandise Mart Plaza, Chicago IL 60654 USA

## 1.2 Manufacturer

Motorola Mobility LLC  
222 W, Merchandise Mart Plaza, Chicago IL 60654 USA

## 1.3 Product Feature of Equipment Under Test

Product Feature	
Equipment	Mobile Cellular Phone
Brand Name	Motorola
Model Name	10566
FCC ID	IHDT56WG1
EUT supports Radios application	GSM/GPRS/EGPRS/WCDMA/HSPA/ HSPA+(16QAM uplink is not supported)/ WLAN2.4GHz 802.11b/g/n HT20/ Bluetooth v3.0+EDR/Bluetooth v4.0/v4.1/v4.2 LE
IMEI Code	Radiation: 353314080087032/353314080087040 Conduction: 353314080084559/353314080084567
HW Version	98737_1_12
SW Version	Blur-Version.24.10.9.Watson.europe.en.EN
EUT Stage	Identical Prototype

**Remark:**

1. The above EUT's information was declared by manufacturer. Please refer to the specifications or user's manual for more detailed description.
2. This is a variant report for 10566. The product equality declaration can be reference of Appendix D. According to the differences, we only evaluate worst mode of Radiation Spurious emission and Conducted emission, all other test cases were quoted on original test report (Sporton Report Number FR710416C).



### 1.4 Product Specification of Equipment Under Test

Standards-related Product Specification	
Tx/Rx Channel Frequency Range	2412 MHz ~ 2462 MHz
Antenna Type / Gain	PIFA Antenna with gain -2.00 dBi
Type of Modulation	802.11b : DSSS (DBPSK / DQPSK / CCK) 802.11g/n : OFDM (BPSK / QPSK / 16QAM / 64QAM)

### 1.5 Specification of Accessory

Specification of Accessory				
AC Adapter	Brand Name	Motorola (Chenyang)	Model Name	C-P56 SPN5987A
	Power Rating	I/P: 100-240 Vac, 130mA, O/P: 5 Vdc, 1000mA		
Battery	Brand Name	Motorola (SCUD)	Model Name	HC40
	Power Rating	3.8Vdc, 2245/2350mAh (Min/Typ)	Type	Li-ion
Earphone	Brand Name	Motorola (Juwei)	Model Name	JWEP0987-W09R
	Signal Line Type	1.22 meter, non-shielded cable, without ferrite core		
USB Cable	Brand Name	Motorola (Liqi)	Model Name	LQ-025280
	Signal Line Type	1.04 meter, shielded cable, without ferrite core		

### 1.6 Modification of EUT

No modifications are made to the EUT during all test items.



### 1.7 Testing Location

<b>Test Site</b>	Sporton International (KunShan) INC.		
<b>Test Site Location</b>	No. 3-2, PingXiang Road, Kunshan, Jiangsu Province, P. R. China TEL: +86-0512-5790-0158 FAX: +86-0512-5790-0958		
<b>Test Site No.</b>	<b>Sporton Site No.</b>		<b>FCC Registration No.</b>
	CO01-KS	03CH03-KS	306251

Note: The test site complies with ANSI C63.4 2014 requirement.

### 1.8 Applicable Standards

According to the specifications of the manufacturer, the EUT must comply with the requirements of the following standards:

- FCC Part 15 Subpart C §15.247
- FCC KDB Publication No. 558074 D01 DTS Meas. Guidance v04
- ANSI C63.10-2013

**Remark:**

1. All test items were verified and recorded according to the standards and without any deviation during the test.
2. This EUT has also been tested and complied with the requirements of FCC Part 15, Subpart B, recorded in a separate test report.



## 2 Test Configuration of Equipment Under Test

The EUT has been associated with peripherals and configuration operated in a manner tended to maximize its emission characteristics in a typical application. Frequency range investigated: conducted emission (150 kHz to 30 MHz) and radiated emission (9 kHz to the 10th harmonic of the highest fundamental frequency or to 40 GHz, whichever is lower). For radiated measurement, pre-scanned in three orthogonal panels, X, Y, Z. The worst cases were recorded in this report.

### 2.1 Carrier Frequency and Channel

Frequency Band	Channel	Freq. (MHz)	Channel	Freq. (MHz)
2400-2483.5 MHz	1	2412	7	2442
	2	2417	8	2447
	3	2422	9	2452
	4	2427	10	2457
	5	2432	11	2462
	6	2437	-	-



## 2.2 Test Mode

Final test mode of radiated spurious emissions test items are considering the modulation and worse data rates as below table.

Modulation	Data Rate
802.11b	1 Mbps
802.11g	6 Mbps
802.11n HT20	MCS0

Test Cases	
AC Conducted Emission	Mode 1 : GSM850 Idle + Bluetooth Link + WLAN Link + Earphone + USB Cable (Charging from Adapter) + SIM 1 for Sample 1

## 2.3 Connection Diagram of Test System

<WLAN Tx Mode>

For 802.11b/11g

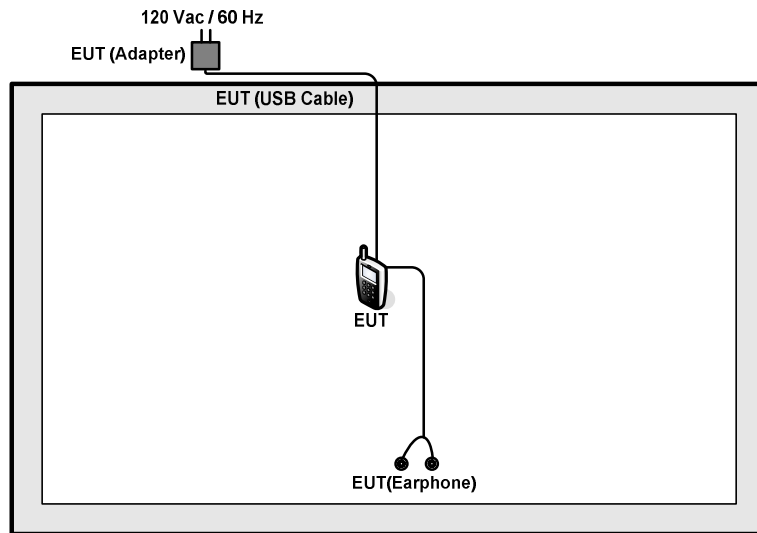

For 802.11n HT20



<AC Conducted Emission Mode>

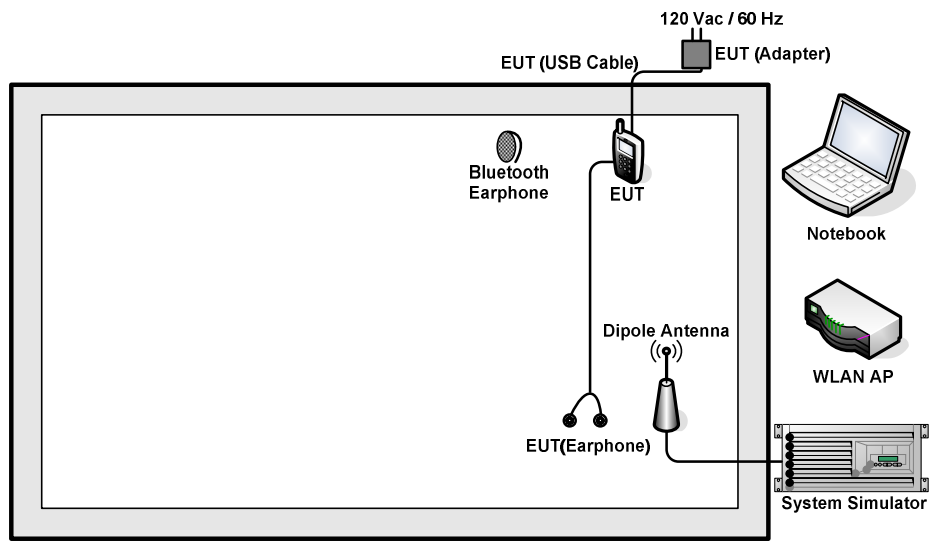



## 2.4 Support Unit used in test configuration and system

Item	Equipment	Trade Name	Model Name	FCC ID	Data Cable	Power Cord
1.	System Simulator	Anritsu	MT8820C	N/A	N/A	Unshielded, 1.8 m
2.	WLAN AP	LINKSYS	WRT600N	Q87-WRT600NV11	N/A	Unshielded, 1.8 m
3.	Notebook	Lenovo	G480	PRC4	N/A	AC I/P: Unshielded, 1.8 m DC O/P: Shielded, 1.8 m
4.	Bluetooth Earphone	Lenovo	LBH308	N/A	N/A	N/A

## 2.5 EUT Operation Test Setup

For WLAN function, the engineering test program was provided and enabled to make EUT continuous transmit/receive.

For AC power line conducted emissions, the EUT was set to WLAN link with the Notebook under large package sizes transmission.



### 3 Test Result

#### 3.1 Radiated Band Edges and Spurious Emission Measurement

##### 3.1.1 Limit of Radiated band edge and Spurious Emission Measurement

In any 100 kHz bandwidth outside the intentional radiator frequency band, all harmonics/spurious must be at least 20 dB below the highest emission level within the authorized band. If the output power of this device was measured by spectrum analyzer, the attenuation under this paragraph shall be 30 dB instead of 20 dB. In addition, radiated emissions which fall in the restricted bands must also comply with the FCC section 15.209 limits as below.

Frequency (MHz)	Field Strength (microvolts/meter)	Measurement Distance (meters)
0.009 – 0.490	2400/F(kHz)	300
0.490 – 1.705	24000/F(kHz)	30
1.705 – 30.0	30	30
30 – 88	100	3
88 – 216	150	3
216 - 960	200	3
Above 960	500	3

##### 3.1.2 Measuring Instruments

The measuring equipment is listed in the section 4 of this test report.



### **3.1.3 Test Procedures**

1. The testing follows FCC KDB Publication No. 558074 D01 DTS Meas. Guidance v04.
2. The EUT was arranged to its worst case and then tune the antenna tower (from 1 m to 4 m) and turntable (from 0 degree to 360 degrees) to find the maximum reading. A pre-amp and a high pass filter are used for the test in order to get better signal level.
3. The EUT was placed on a turntable with 0.8 meter for frequency below 1GHz and 1.5 meter for frequency above 1GHz respectively above ground.
4. The EUT was set 3 meters from the interference receiving antenna, which was mounted on the top of a variable height antenna tower.
5. Corrected Reading: Antenna Factor + Cable Loss + Read Level - Preamp Factor = Level
6. For measurement below 1GHz, If the emission level of the EUT measured by the peak detector is 3 dB lower than the applicable limit, the peak emission level will be reported. Otherwise, the emission measurement will be repeated using the quasi-peak detector and reported.
7. Use the following spectrum analyzer settings:
  - (1) Span shall wide enough to fully capture the emission being measured;
  - (2) Set RBW=100 kHz for  $f < 1$  GHz; VBW  $\geq$  RBW; Sweep = auto; Detector function = peak; Trace = max hold;
  - (3) Set RBW = 1 MHz, VBW= 3MHz for  $f \geq 1$  GHz for peak measurement.  
For average measurement:
    - VBW = 10 Hz, when duty cycle is no less than 98 percent.
    - VBW  $\geq 1/T$ , when duty cycle is less than 98 percent where T is the minimum transmission duration over which the transmitter is on and is transmitting at its maximum power control level for the tested mode of operation.

### 3.1.4 Test Setup

For radiated emissions below 30MHz

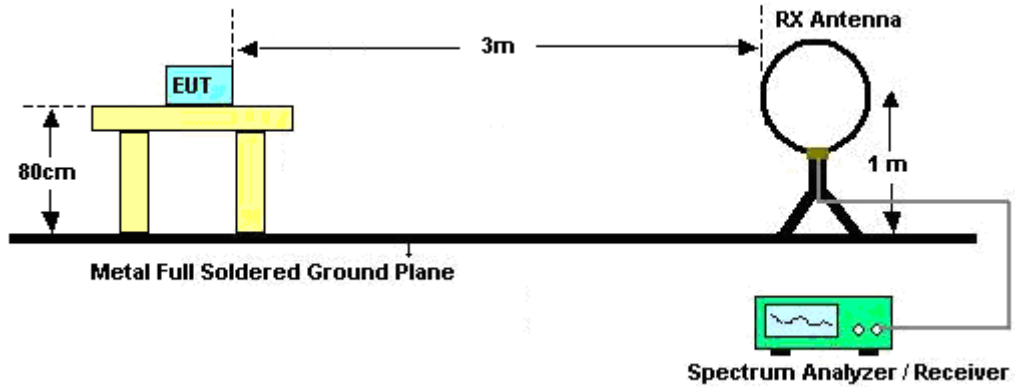

For radiated emissions from 30MHz to 1GHz

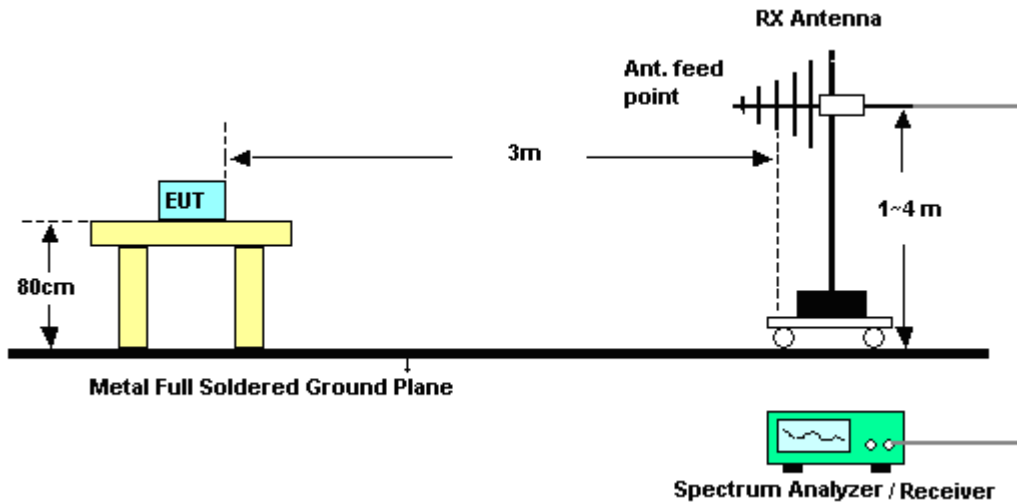

For radiated emissions above 1GHz

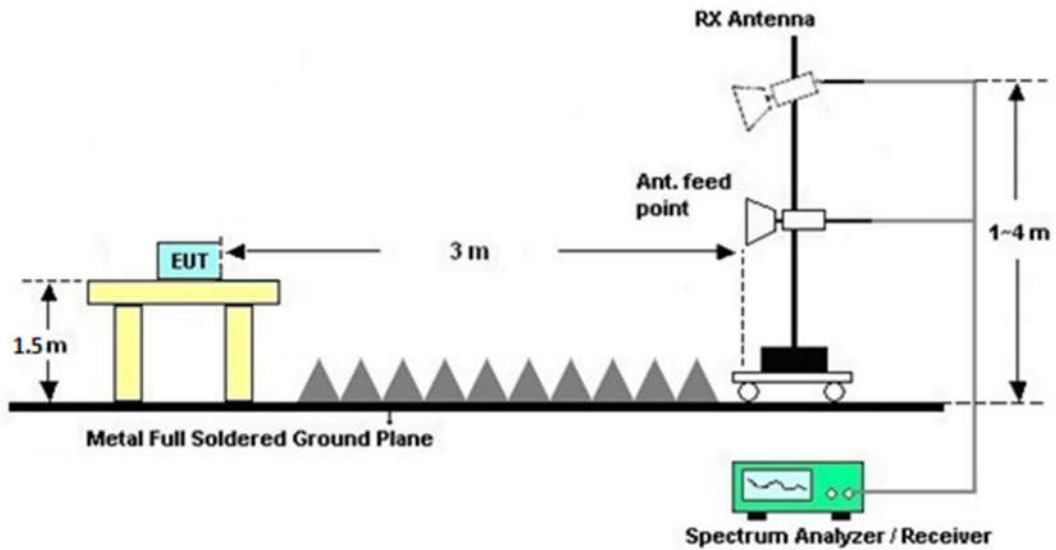

### 3.1.5 Test Results of Radiated Spurious Emissions (9kHz ~ 30MHz)

The low frequency, which started from 9 kHz to 30MHz, was pre-scanned and the result which was 20dB lower than the limit line per 15.31(o) was not reported.

### 3.1.6 Test Result of Radiated Spurious at Band Edges

Please refer to Appendix A.

### 3.1.7 Duty Cycle

Please refer to Appendix B.

### 3.1.8 Test Result of Radiated Spurious Emission (30MHz ~ 10<sup>th</sup> Harmonic)

Please refer to Appendix A.



### 3.2 AC Conducted Emission Measurement

#### 3.2.1 Limit of AC Conducted Emission

For equipment that is designed to be connected to the public utility (AC) power line, the radio frequency voltage that is conducted back onto the AC power line on any frequency or frequencies within the band 150 kHz to 30 MHz shall not exceed the limits in the following table.

Frequency of Emission (MHz)	Conducted Limit (dBµV)	
	Quasi-Peak	Average
0.15-0.5	66 to 56*	56 to 46*
0.5-5	56	46
5-30	60	50

\*Decreases with the logarithm of the frequency.

#### 3.2.2 Measuring Instruments

The measuring equipment is listed in the section 4 of this test report.

#### 3.2.3 Test Procedures

1. The EUT was placed 0.4 meter from the conducting wall of the shielding room, and it was kept at least 80 centimeters from any other grounded conducting surface.
2. Connect EUT to the power mains through a line impedance stabilization network (LISN).
3. All the support units are connecting to the other LISN.
4. The LISN provides 50 ohm coupling impedance for the measuring instrument.
5. The FCC states that a 50 ohm, 50 microhenry LISN should be used.
6. Both sides of AC line were checked for maximum conducted interference.
7. The frequency range from 150 kHz to 30 MHz was searched.
8. Set the test-receiver system to Peak Detect Function and specified bandwidth (IF bandwidth = 9kHz) with Maximum Hold Mode.

### 3.2.4 Test Setup

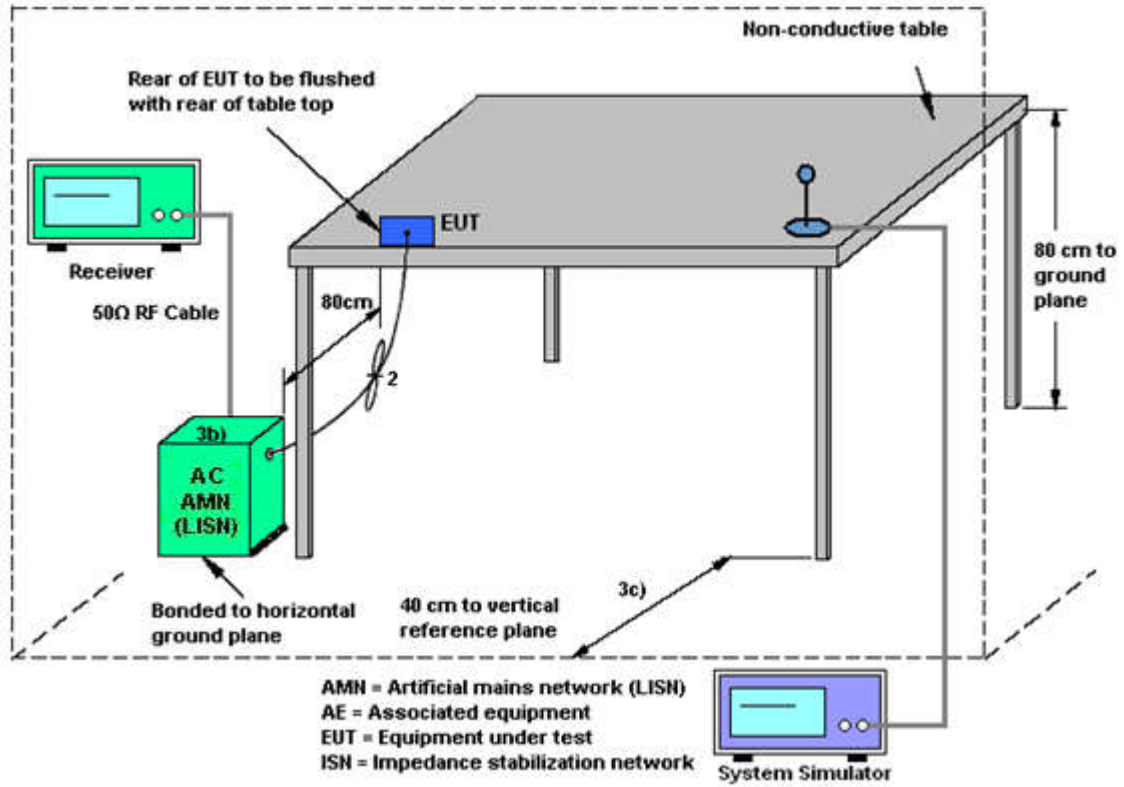



### 3.2.5 Test Result of AC Conducted Emission

Test Mode :	Mode 1	Temperature :	22~24°C
Test Engineer :	Eligah Wang	Relative Humidity :	40~42%
Test Voltage :	120Vac / 60Hz	Phase :	Line
Function Type :	GSM850 Idle + Bluetooth Link + WLAN Link + Earphone + USB Cable (Charging from Adapter) + SIM 1 for Sample 1		

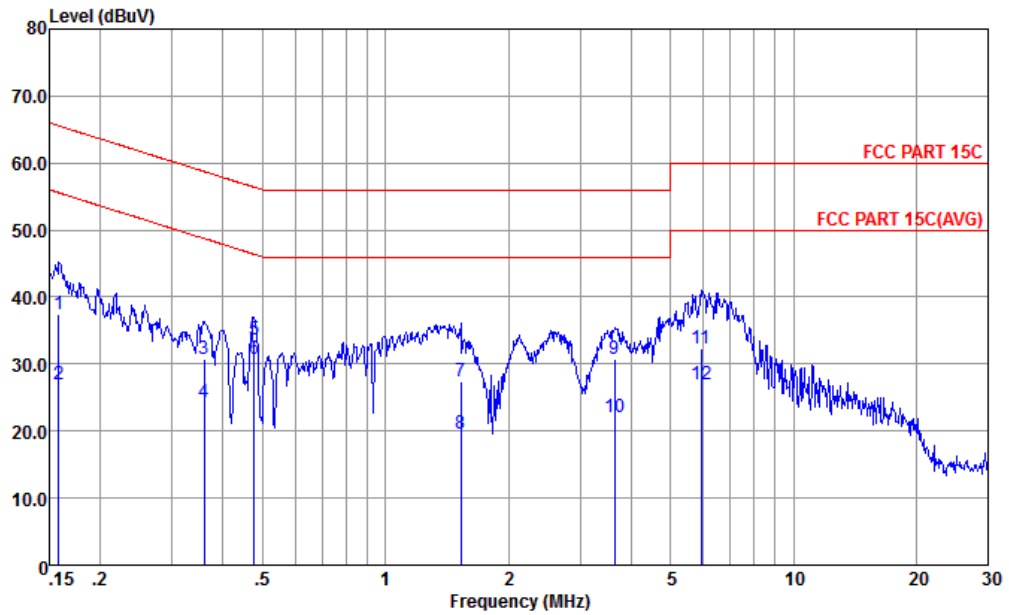

Site : CO01-KS  
 Condition : FCC PART 15C LISN-L-20151024 LINE

Mode : Mode 1  
 IMEI : 353314080084559/67

	Freq	Level	Over Limit	Limit Line	Read Level	LISN Factor	Cable Loss	Remark
	MHz	dBuV	dB	dBuV	dBuV	dB	dB	
1	0.158	37.46	-28.10	65.56	26.60	0.48	10.38	QP
2	0.158	26.96	-28.60	55.56	16.10	0.48	10.38	Average
3	0.360	30.75	-27.99	58.74	20.30	0.23	10.22	QP
4	0.360	24.25	-24.49	48.74	13.80	0.23	10.22	Average
5	0.476	33.72	-22.69	56.41	23.30	0.23	10.19	QP
6 *	0.476	30.72	-15.69	46.41	20.30	0.23	10.19	Average
7	1.527	27.50	-28.50	56.00	17.10	0.21	10.19	QP
8	1.527	19.70	-26.30	46.00	9.30	0.21	10.19	Average
9	3.642	30.72	-25.28	56.00	20.30	0.19	10.23	QP
10	3.642	22.02	-23.98	46.00	11.60	0.19	10.23	Average
11	5.929	32.37	-27.63	60.00	21.90	0.21	10.26	QP
12	5.929	27.07	-22.93	50.00	16.60	0.21	10.26	Average



Test Mode :	Mode 1	Temperature :	22~24°C
Test Engineer :	Eligah Wang	Relative Humidity :	40~42%
Test Voltage :	120Vac / 60Hz	Phase :	Neutral
Function Type :	GSM850 Idle + Bluetooth Link + WLAN Link + Earphone + USB Cable (Charging from Adapter) + SIM 1 for Sample 1		

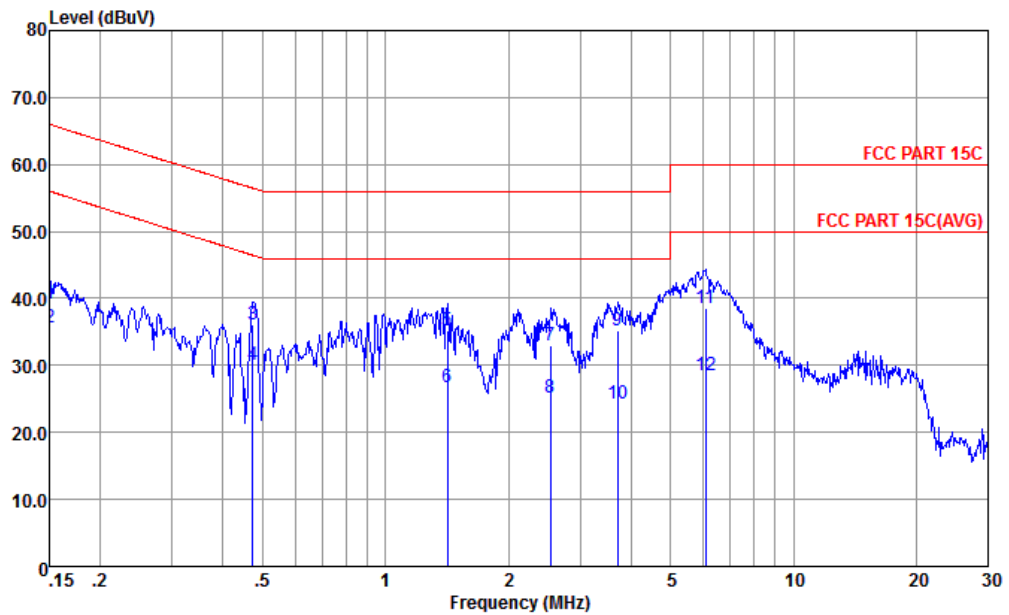

Site : CO01-KS  
 Condition : FCC PART 15C LISN-N-20151024 NEUTRAL

Mode : Mode 1  
 IMEI : 353314080084559/67

	Freq	Level	Over Limit	Limit Line	Read Level	LISN Factor	Cable Loss	Remark
	MHz	dBuV	dB	dBuV	dBuV	dB	dB	
1	0.150	39.29	-26.71	66.00	28.60	0.30	10.39	QP
2	0.150	35.59	-20.41	56.00	24.90	0.30	10.39	Average
3	0.474	36.11	-20.34	56.45	25.60	0.32	10.19	QP
4 *	0.474	30.11	-16.34	46.45	19.60	0.32	10.19	Average
5	1.418	35.16	-20.84	56.00	24.59	0.38	10.19	QP
6	1.418	26.66	-19.34	46.00	16.09	0.38	10.19	Average
7	2.540	32.88	-23.12	56.00	22.30	0.37	10.21	QP
8	2.540	25.18	-20.82	46.00	14.60	0.37	10.21	Average
9	3.700	35.20	-20.80	56.00	24.60	0.37	10.23	QP
10	3.700	24.20	-21.80	46.00	13.60	0.37	10.23	Average
11	6.089	38.48	-21.52	60.00	27.90	0.32	10.26	QP
12	6.089	28.48	-21.52	50.00	17.90	0.32	10.26	Average



### **3.3 Antenna Requirements**

#### **3.3.1 Standard Applicable**

If directional gain of transmitting antennas is greater than 6dBi, the power shall be reduced by the same level in dB comparing to gain minus 6dBi. The use of a permanently attached antenna or of an antenna that uses a unique coupling to the intentional radiator shall be considered sufficient to comply with the FCC rule.

#### **3.3.2 Antenna Anti-Replacement Construction**

An embedded-in antenna design is used.

#### **3.3.3 Antenna Gain**

The antenna peak gain of EUT is less than 6 dBi. Therefore, it is not necessary to reduce maximum peak output power limit.



## 4 List of Measuring Equipment

Instrument	Manufacturer	Model No.	Serial No.	Characteristics	Calibration Date	Test Date	Due Date	Remark
EMI Test Receiver	R&S	ESR7	101403	9kHz~7GHz; Max 30dBm	Aug. 09, 2016	Apr. 27, 2017	Aug. 08, 2017	Radiation (03CH03-KS)
EXA Spectrum Analyzer	Keysight	N9010A	MY551502 44	10Hz~44GHz	Apr. 18, 2017	Apr. 27, 2017	Apr. 17, 2018	Radiation (03CH03-KS)
Loop Antenna	R&S	HFH2-Z2	100321	9kHz~30MHz	Nov. 23, 2016	Apr. 27, 2017	Nov. 22, 2017	Radiation (03CH03-KS)
Bilog Antenna	TeseQ	CBL6112D	35406	25MHz~2GHz	Apr. 22, 2017	Apr. 27, 2017	Apr. 21, 2018	Radiation (03CH03-KS)
Horn Antenna	Schwarzbeck	BBHA9120D	9120D-135 6	1GHz~18GHz	Apr. 22, 2017	Apr. 27, 2017	Apr. 21, 2018	Radiation (03CH03-KS)
SHF-EHF Horn	com-power	AH-840	101070	18GHz~40GHz	Oct. 19, 2016	Apr. 27, 2017	Oct. 18, 2017	Radiation (03CH03-KS)
Amplifier	SONOMA	310N	187289	9kHz~1GHz	Aug. 09, 2016	Apr. 27, 2017	Aug. 08, 2017	Radiation (03CH03-KS)
high gain Amplifier	MITEQ	AMF-7D-0010 1800-30-10P	2025788	1Ghz-18Ghz	Apr. 18, 2017	Apr. 27, 2017	Apr. 17, 2018	Radiation (03CH03-KS)
Amplifier	Agilent	8449B	3008A023 70	1GHz~26.5GHz	Oct. 13, 2016	Apr. 27, 2017	Oct. 12, 2017	Radiation (03CH03-KS)
Amplifier	MITEQ	TTA1840-35- HG	1887435	18~40GHz	Oct. 13, 2016	Apr. 27, 2017	Oct. 12, 2017	Radiation (03CH03-KS)
AC Power Source	Chroma	61601	F1040900 04	N/A	NCR	Apr. 27, 2017	NCR	Radiation (03CH03-KS)
Turn Table	ChamPro	EM 1000-T	060762-T	0~360 degree	NCR	Apr. 27, 2017	NCR	Radiation (03CH03-KS)
Antenna Mast	ChamPro	EM 1000-A	060762-A	1 m~4 m	NCR	Apr. 27, 2017	NCR	Radiation (03CH03-KS)
EMI Receiver	R&S	ESC17	100768	9kHz~7GHz;	Apr. 20, 2016	Apr. 09, 2017	Apr. 19, 2017	Conduction (CO01-KS)
AC LISN	MessTec	AN3016	060103	9kHz~30MHz	Oct. 13, 2016	Apr. 09, 2017	Oct. 13, 2017	Conduction (CO01-KS)
AC LISN (for auxiliary equipment)	MessTec	AN3016	060105	9kHz~30MHz	Oct. 13, 2016	Apr. 09, 2017	Oct. 13, 2017	Conduction (CO01-KS)
AC Power Source	Chroma	61602	ABP00000 0811	AC 0V~300V, 45Hz~1000Hz	Oct. 13, 2016	Apr. 09, 2017	Oct. 13, 2017	Conduction (CO01-KS)

NCR: No Calibration Required



## 5 Uncertainty of Evaluation

### Uncertainty of Conducted Emission Measurement (150kHz ~ 30MHz)

Measuring Uncertainty for a Level of Confidence of 95% ( $U = 2Uc(y)$ )	2.3dB
---	-------

### Uncertainty of Radiated Emission Measurement (30 MHz ~ 1000 MHz)

Measuring Uncertainty for a Level of Confidence of 95% ( $U = 2Uc(y)$ )	4.6dB
---	-------

### Uncertainty of Radiated Emission Measurement (1GHz ~ 18GHz)

Measuring Uncertainty for a Level of Confidence of 95% ( $U = 2Uc(y)$ )	4.5dB
---	-------

### Uncertainty of Radiated Emission Measurement (18GHz ~ 40GHz)

Measuring Uncertainty for a Level of Confidence of 95% ( $U = 2Uc(y)$ )	4.7dB
---	-------



## Appendix A. Radiated Spurious Emission

2.4GHz 2400~2483.5MHz

WIFI 802.11b (Band Edge @ 3m)

WIFI Ant.	Note	Frequency	Level	Over Limit	Limit Line	Read Level	Antenna Factor	Cable Loss	Preamp Factor	Ant Pos	Table Pos	Peak Avg.	Pol.
1		( MHz )	( dBμV/m )	( dB )	( dBμV/m )	( dBμV )	( dB/m )	( dB )	( dB )	( cm )	( deg )	(P/A)	(H/V)
802.11b CH 01 2412MHz		2386.18	51.3	-22.70	74	55.95	26.3	5.47	36.42	100	297	P	H
		2386.31	42.26	-11.74	54	46.91	26.3	5.47	36.42	100	297	A	H
	*	2412	99.74	-	-	104.44	26.26	5.47	36.43	100	297	P	H
	*	2414	96.73	-	-	101.43	26.26	5.47	36.43	100	297	A	H
		2389.95	51.24	-22.76	74	55.89	26.3	5.47	36.42	334	274	P	V
		2386.31	40.84	-13.16	54	45.49	26.3	5.47	36.42	334	274	A	V
	*	2414	96.77	-	-	101.47	26.26	5.47	36.43	334	274	P	V
	*	2414	93.84	-	-	98.54	26.26	5.47	36.43	334	274	A	V



2.4GHz 2400~2483.5MHz
WIFI 802.11b (Harmonic @ 3m)

Table with 14 columns: WIFI Ant. 1, Note, Frequency (MHz), Level (dBµV/m), Over Limit (dB), Limit Line (dBµV/m), Read Level (dBµV), Antenna Factor (dB/m), Cable Loss (dB), Preamp Factor (dB), Ant Pos (cm), Table Pos (deg), Peak Avg. (P/A), Pol. (H/V). It contains two rows of test data for 802.11b CH 01 at 2412MHz.



2.4GHz 2400~2483.5MHz
WIFI 802.11g (Band Edge @ 3m)

Table with 14 columns: WIFI Ant. 1, Note, Frequency (MHz), Level (dBµV/m), Over Limit (dB), Limit Line (dBµV/m), Read Level (dBµV), Antenna Factor (dB/m), Cable Loss (dB), Preamp Factor (dB), Ant Pos (cm), Table Pos (deg), Peak Avg. (P/A), Pol. (H/V). Rows include test data for 802.11g CH 11 at 2462MHz and a Remark section.



2.4GHz 2400~2483.5MHz  
WIFI 802.11g (Harmonic @ 3m)

WIFI Ant. 1	Note	Frequency ( MHz )	Level ( dBμV/m )	Over Limit ( dB )	Limit Line ( dBμV/m )	Read Level ( dBμV )	Antenna Factor ( dB/m )	Cable Loss ( dB )	Preamp Factor ( dB )	Ant Pos ( cm )	Table Pos ( deg )	Peak Avg. (P/A)	Pol. (H/V)
802.11g CH 11 2462MHz		4926	41.98	-32.02	74	39.61	31.13	7.8	36.56	100	360	P	H
		7386	48.55	-25.45	74	39.68	35.29	9.86	36.28	100	360	P	H
		4926	42.1	-31.90	74	39.73	31.13	7.8	36.56	100	360	P	V
		7386	47.07	-26.93	74	38.2	35.29	9.86	36.28	100	360	P	V
Remark	1. No other spurious found. 2. All results are PASS against Peak and Average limit line.												



2.4GHz 2400~2483.5MHz
WIFI 802.11n HT20 (Band Edge @ 3m)

Table with 14 columns: WIFI Ant. 1, Note, Frequency (MHz), Level (dBµV/m), Over Limit (dB), Limit Line (dBµV/m), Read Level (dBµV), Antenna Factor (dB/m), Cable Loss (dB), Preamp Factor (dB), Ant Pos (cm), Table Pos (deg), Peak Avg. (P/A), Pol. (H/V). Rows include test results for 802.11n HT20 CH 11 at 2462MHz and a Remark section.



**2.4GHz 2400~2483.5MHz**  
**WIFI 802.11n HT20 (Harmonic @ 3m)**

WIFI Ant. 1	Note	Frequency ( MHz )	Level ( dBμV/m )	Over Limit ( dB )	Limit Line ( dBμV/m )	Read Level ( dBμV )	Antenna Factor ( dB/m )	Cable Loss ( dB )	Preamp Factor ( dB )	Ant Pos ( cm )	Table Pos ( deg )	Peak Avg. ( P/A )	Pol. ( H/V )
802.11n		4926	41.39	-32.61	74	39.02	31.13	7.8	36.56	100	360	P	H
HT20		7386	46.84	-27.16	74	37.97	35.29	9.86	36.28	100	360	P	H
CH 11		4926	40.79	-33.21	74	38.42	31.13	7.8	36.56	100	360	P	V
2462MHz		7386	47.01	-26.99	74	38.14	35.29	9.86	36.28	100	360	P	V
<b>Remark</b>	1. No other spurious found. 2. All results are PASS against Peak and Average limit line.												



2.4GHz 2400~2483.5MHz

Emission below 1GHz

2.4GHz WIFI 802.11g (LF)

WIFI	Note	Frequency	Level	Over	Limit	Read	Antenna	Cable	Preamp	Ant	Table	Peak	Pol.
Ant.				Limit	Line	Level	Factor	Loss	Factor	Pos	Pos	Avg.	
1		( MHz )	( dBμV/m )	( dB )	( dBμV/m )	( dBμV )	( dB/m )	( dB )	( dB )	( cm )	( deg )	( P/A )	( H/V )
2.4GHz 802.11g LF		30	26.61	-13.39	40	30.03	27.2	0.65	31.27	-	-	P	H
		37.76	25.63	-14.37	40	32.73	23.52	0.74	31.36	-	-	P	H
		103.72	32.56	-10.94	43.5	43.96	18.82	1.23	31.45	-	-	P	H
		195.87	35.55	-7.95	43.5	49.37	15.96	1.71	31.49	100	225	P	H
		244.37	24.57	-21.43	46	37.34	16.95	1.73	31.45	-	-	P	H
		468.44	27.04	-18.96	46	30.91	24.68	2.7	31.25	-	-	P	H
		37.76	34.64	-5.36	40	41.74	23.52	0.74	31.36	100	25	P	V
		49.4	28.81	-11.19	40	42.88	16.5	0.84	31.41	-	-	P	V
		102.75	29.28	-14.22	43.5	40.66	18.84	1.23	31.45	-	-	P	V
		140.58	28.52	-14.98	43.5	40.54	18.08	1.43	31.53	-	-	P	V
		194.9	30.66	-12.84	43.5	44.45	16.01	1.7	31.5	-	-	P	V
	915.61	31.07	-14.93	46	29.18	28.81	3.89	30.81	-	-	P	V	
Remark	1. No other spurious found. 2. All results are PASS against limit line.												



**Note symbol**

*	<b>Fundamental Frequency</b> which can be ignored. However, the level of any unwanted emissions shall not exceed the level of the fundamental frequency.
!	Test result is <b>over limit</b> line.
P/A	<b>Peak</b> or <b>Average</b>
H/V	<b>Horizontal</b> or <b>Vertical</b>



A calculation example for radiated spurious emission is shown as below:

WIFI	Note	Frequency	Level	Over	Limit	Read	Antenna	Cable	Preamp	Ant	Table	Peak	Pol.
Ant.				Limit	Line	Level	Factor	Loss	Factor	Pos	Pos	Avg.	
1		( MHz )	( dBμV/m )	( dB )	( dBμV/m )	( dBμV )	( dB/m )	( dB )	( dB )	( cm )	( deg )	( P/A )	( H/V )
802.11b		2390	55.45	-18.55	74	54.51	32.22	4.58	35.86	103	308	P	H
CH 01													
2412MHz		2390	43.54	-10.46	54	42.6	32.22	4.58	35.86	103	308	A	H

- Level(dBμV/m) =  
Antenna Factor(dB/m) + Cable Loss(dB) + Read Level(dBμV) - Preamp Factor(dB)
- Over Limit(dB) = Level(dBμV/m) – Limit Line(dBμV/m)

**For Peak Limit @ 2390MHz:**

- Level(dBμV/m)  
= Antenna Factor(dB/m) + Cable Loss(dB) + Read Level(dBμV) - Preamp Factor(dB)  
= 32.22(dB/m) + 4.58(dB) + 54.51(dBμV) – 35.86 (dB)  
= 55.45 (dBμV/m)
- Over Limit(dB)  
= Level(dBμV/m) – Limit Line(dBμV/m)  
= 55.45(dBμV/m) – 74(dBμV/m)  
= -18.55(dB)

**For Average Limit @ 2390MHz:**

- Level(dBμV/m)  
= Antenna Factor(dB/m) + Cable Loss(dB) + Read Level(dBμV) - Preamp Factor(dB)  
= 32.22(dB/m) + 4.58(dB) + 42.6(dBμV) – 35.86 (dB)  
= 43.54 (dBμV/m)
- Over Limit(dB)  
= Level(dBμV/m) – Limit Line(dBμV/m)  
= 43.54(dBμV/m) – 54(dBμV/m)  
= -10.46(dB)

Both peak and average measured complies with the limit line, so test result is “PASS”.



## Appendix B. Duty Cycle Plots

Band	Duty Cycle(%)	T(ms)	1/T(kHz)	VBW Setting
802.11b	100	-	-	10Hz
802.11g	97.47	1.396	0.716	1kHz
802.11n HT20	97.29	1.299	0.770	1kHz

### 802.11b

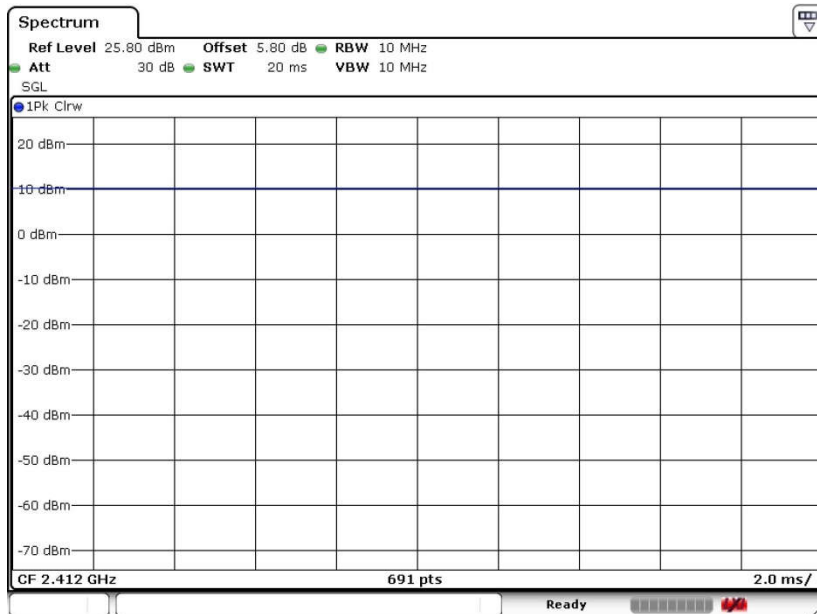



802.11g

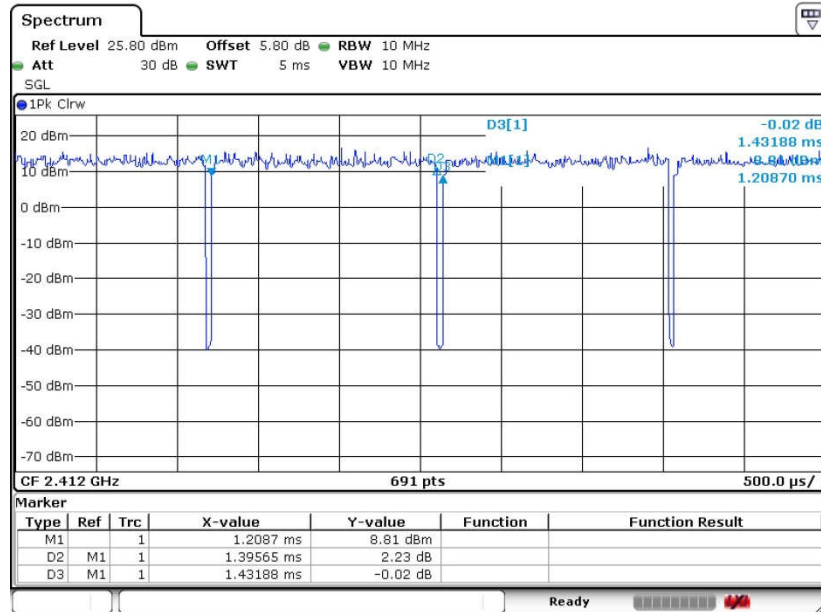

802.11n HT20

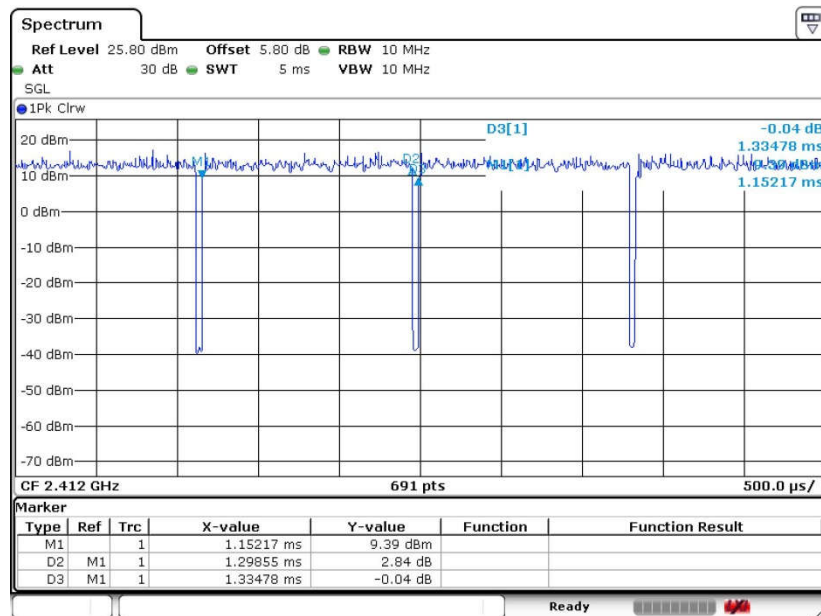



## **Appendix D. Product Equality Declaration**

**Motorola Mobility LLC**  
**222 W,Merchandise Mart Plaza, Chicago IL 60654 USA**  
**Tel: 18150396560**

**Date: June 13, 2017**

**Product Equality Declaration**

We, Motorola Mobility LLC, declare on our sole responsibility for the product of **XT1750** as below, the detailed differences between Original and Variant project are list in the table:

<b>Object</b>	<b>Original</b>	<b>Variant</b>
Motor	<b>Hongzhifa:</b> 1027;Flat;Work height 3.05;Lead 8 mm;At the bottom of the conductive glue, foam thickness of 0.20 mm	<b>AWA:</b> LC-B681
Front Camera	<b>JSL:</b> 2M,FF,C2590,6*6*4.42,ZIF	<b>Broadsands:</b> BLX2375W-S98737AA1-F
Back Camera	<b>Syoptical:</b> 5M,FF,HI-553,6.5*6.5*4.66,BTB	<b>Broadsands:</b> BLX5005W-S98737AA1-CB
LCD	<b>TXD:</b> 5 inches, 480*854, 10 star light, BTB	<b>Holitech:</b> HTB050W361
Touch panel	<b>Holitech:</b> 5 inches, G + F partition 2 MSG2256A, second generation 0.7 asahi	<b>Biel:</b> WTS5002B
USB	<b>STARW:</b> XJ-007075	<b>Liqi:</b> s98736,micro USB, Line 1 m long
Adapter	<b>Acbel:</b> C-P56, C-P57 C-P58 C-P59 C-P60 C-P45	<b>Chenyang:</b> C-P56, C-P57 -P58 C-P59 C-P60 C-P45
headphones	<b>NEW LEADER:</b> NLD-EM127T-97SF	<b>Juwei:</b> s98736,White double channel headphones, hands-free line length of 1.1 m
RCV	<b>Xichun</b>	<b>Bosheng:</b> MRFD1206A123008
speaker	<b>Xichun</b>	<b>Haosheng:</b> XHS151124SW35P33-10-RH
Memory	<b>Samsung :</b> KMFXN0012M-B214	<b>Hynix :</b> H9TQ64A8GTCCUR-KUM
Filtering duplex class	<b>Murata:</b> SAFFB1G56KB0F0A	<b>TAIYO:</b> F6QA1G581M2QZ
Filtering duplex class	<b>Kyocera:</b> SD18-0897R8UBQ1	<b>MURATA:</b> SAYEY897MCA0B0A
The acceleration sensor chip	<b>KIONIX:</b> KXTJ2-1009-HQ	<b>BOSCH :</b> BMA253
High frequency crystal class	<b>TXC:</b> OZ26000004	<b>EPSON:</b> X1E000291001400
Headphone jack	<b>Jie huang:</b> JAF00-05152-0151	<b>Jie huang:</b> PH12-6BS5F3MB
Booth connector	<b>Qiande:</b> TF-1502-001	<b>Qiande:</b> CAF11-08153-011401-CUS
Booth connector	<b>Jie huang :</b> CAF99-08153-010609	<b>Jie huang:</b> S34-0B08F15C
ZIF connector	<b>Kyocera:</b> 04 6298 706 200 883+;04 6298 706 220 883+	<b>UJU :</b> PF050-B06B-C09-A
ZIF connector	<b>UJU:</b> PF030-O25B-C10-H	<b>HIROSE:</b> FH26W-25S-0.3SHW(60)
Other connector	<b>Sinopow:</b> C-10020059	<b>MURATA:</b> MM8030-2610RK0
LED driver	<b>Orientchip:</b> OCP8132AVAD	<b>SGMC:</b> SGM3756YTDI6G/TR
LED driver	<b>AWINIC:</b> AW9961DNR	<b>SILERGY:</b> SYWT78DUC
Low noise put	<b>Maxscend:</b> MXDLN16G	<b>AWINIC:</b> AW5005DNR
barron	<b>ACX:</b> BD2012-20L0820T/LF	<b>WALSIN:</b> RFBLN2012090BM5T25
Filtering duplex class	<b>Kyocera:</b> SD18-1950R8UBQ1	<b>ACX:</b> DP1608-V1524CAT
Filtering duplex class	<b>Walsin:</b> RFDIP1608060TM7T62	<b>MURATA:</b> SAYEY1G95HA0F0A
The main antenna	WELLETRONICS COMMUNICATION TECHNOLOGY CO.,LTD: V2.0	WELLETRONICS COMMUNICATION TECHNOLOGY CO.,LTD: V2.2

Triad antenna	WELLETRONICS COMMUNICATION TECHNOLOGY CO.,LTD: V2.0	WELLETRONICS COMMUNICATION TECHNOLOGY CO.,LTD: Two samples V2.3 Version V2.2 agree with the original antenna in-kind, screen printing is unified with the main antenna, are upgraded to V2.2 (previous consulting certification, is reported to the printing does not need to change) V2.3 is to optimize the factory feedback antenna case become warped, antenna made small optimization, two for the report Mass production using V2.2 (antenna case become warped with other solutions, antenna do not change)
---------------	---	--

Except above, the others are all the same.

Should you have any questions or comments regarding this matter, please have my best attention.

Sincerely yours,

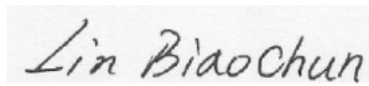

---

Contact Person: Lin BiaoChun

COMPANY: Motorola Mobility LLC.

Tel:86- 18150396560

E-Mail: Linbc@lenovo.com