



FCC RF Test Report

APPLICANT : Motorola Mobility LLC
EQUIPMENT : Mobile Cellular Phone
BRAND NAME : Motorola
MODEL NAME : 10566
FCC ID : IHDT56WG1
STANDARD : FCC 47 CFR Part 2, 22(H), 24(E)
CLASSIFICATION : PCS Licensed Transmitter Held to Ear (PCE)

The product was received on Jan. 04, 2017 and testing was completed on Jan. 06, 2017. We, SPORTON INTERNATIONAL (KUNSHAN) INC., would like to declare that the tested sample has been evaluated in accordance with the test procedures given in ANSI / TIA / EIA-603-D-2010 and has been in compliance with the applicable technical standards.

The test results in this report apply exclusively to the tested model / sample. Without written approval of SPORTON INTERNATIONAL (KUNSHAN) INC., the test report shall not be reproduced except in full.

Prepared by: James Huang / Manager



Approved by: Jones Tsai / Manager

SPORTON INTERNATIONAL (KUNSHAN) INC.
No. 3-2, PingXiang Road, Kunshan, Jiangsu Province, P. R. China



TABLE OF CONTENTS

REVISION HISTORY..... 3

SUMMARY OF TEST RESULT 4

1 GENERAL DESCRIPTION 5

 1.1 Applicant..... 5

 1.2 Manufacturer 5

 1.3 Product Feature of Equipment Under Test 5

 1.4 Product Specification of Equipment Under Test 6

 1.5 Modification of EUT 6

 1.6 Specification of Accessory 7

 1.7 Maximum ERP/EIRP Power, Frequency Tolerance, and Emission Designator 7

 1.8 Testing Location 8

 1.9 Applicable Standards 8

2 TEST CONFIGURATION OF EQUIPMENT UNDER TEST 9

 2.1 Test Mode..... 9

 2.2 Connection Diagram of Test System 10

 2.3 Support Unit used in test configuration 10

 2.4 Measurement Results Explanation Example 10

3 CONDUCTED TEST RESULT..... 11

 3.1 Measuring Instruments..... 11

 3.2 Test Setup 11

 3.3 Test Result of Conducted Test..... 11

 3.4 Conducted Output Power and ERP/EIRP 12

 3.5 Peak-to-Average Ratio 13

 3.6 99% Occupied Bandwidth and 26dB Bandwidth Measurement..... 14

 3.7 Conducted Band Edge 15

 3.8 Conducted Spurious Emission 16

 3.9 Frequency Stability..... 17

4 RADIATED TEST ITEMS 18

 4.1 Measuring Instruments..... 18

 4.2 Test Setup 18

 4.3 Test Result of Radiated Test..... 18

 4.4 Field Strength of Spurious Radiation Measurement 19

5 LIST OF MEASURING EQUIPMENT 20

6 UNCERTAINTY OF EVALUATION 21

APPENDIX A. TEST RESULTS OF CONDUCTED TEST

APPENDIX B. TEST RESULTS OF RADIATED TEST

APPENDIX C. TEST SETUP PHOTOGRAPHS



SUMMARY OF TEST RESULT

| Report Section | FCC Rule | Description | Limit | Result | Remark |
|----------------|-------------------------------------|---|------------------------|--------|--------------------------------------|
| 3.4 | §2.1046 | Conducted Output Power | Reporting Only | PASS | - |
| | §22.913(a)(2) | Effective Radiated Power | < 7 Watts | PASS | - |
| | §24.232(c) | Equivalent Isotropic Radiated Power | < 2 Watts | PASS | - |
| 3.5 | §24.232(d) | Peak-to-Average Ratio | < 13 dB | PASS | - |
| 3.6 | §2.1049 §22.917(b) §24.238(b) | Occupied Bandwidth | Reporting Only | PASS | - |
| 3.7 | §2.1051 §22.917(a) §24.238(a) | Band Edge Measurement | < 43+10log10(P[Watts]) | PASS | - |
| 3.8 | §2.1051 §22.917(a) §24.238(a) | Conducted Emission | < 43+10log10(P[Watts]) | PASS | - |
| 3.9 | §2.1055 §22.355 | Frequency Stability for Temperature & Voltage | < 2.5 ppm for Part 22 | PASS | - |
| | §2.1055 §24.235 | | Within Authorized Band | | |
| 4.4 | §2.1053 §22.917(a) §24.238(a) | Field Strength of Spurious Radiation | < 43+10log10(P[Watts]) | PASS | Under limit 23.83 dB at 5640.000 MHz |



1 General Description

1.1 Applicant

Motorola Mobility LLC
222 W, Merchandise Mart Plaza, Chicago IL 60654 USA

1.2 Manufacturer

Motorola Mobility LLC
222 W, Merchandise Mart Plaza, Chicago IL 60654 USA

1.3 Product Feature of Equipment Under Test

| Product Feature | |
|---------------------------------|---|
| Equipment | Mobile Cellular Phone |
| Brand Name | Motorola |
| Model Name | 10566 |
| FCC ID | IHDT56WG1 |
| EUT supports Radios application | GSM/GPRS/EGPRS/WCDMA/HSPA/HSPA+(16QAM uplink is not supported)/ WLAN 2.4GHz 802.11b/g/n HT20 Bluetooth v3.0 + EDR/Bluetooth v4.0 LE/Bluetooth v4.2 LE |
| HW Version | 98737_1_12 |
| SW Version | Blur-Version.24.10.9.Watson.europe.en.EN |
| IMEI Code | Conducted : 353314080019571/353314080019589 Radiation : 353314080018771/353314080018789 ERP/EIRP: 353314080019456/353314080019464 |
| EUT Stage | Identical Prototype |

Remark: The above EUT's information was declared by manufacturer. Please refer to the specifications or user's manual for more detailed description.

1.4 Product Specification of Equipment Under Test

| Standards-related Product Specification | |
|---|--|
| Tx Frequency | GSM/GPRS/EDGE: 850: 824.2 MHz ~ 848.8 MHz 1900: 1850.2 MHz ~ 1909.8MHz WCDMA: Band V: 826.4 MHz ~ 846.6 MHz Band II: 1852.4 MHz ~ 1907.6 MHz |
| Rx Frequency | GSM/GPRS/EDGE: 850: 869.2 MHz ~ 893.8 MHz 1900: 1930.2 MHz ~ 1989.8 MHz WCDMA: Band V: 871.4 MHz ~ 891.6 MHz Band II: 1932.4 MHz ~ 1987.6 MHz |
| Maximum Output Power to Antenna | GSM/GPRS/EDGE: 850: 32.91 dBm 1900: 29.99 dBm WCDMA: Band V: 23.34 dBm Band II: 23.13 dBm |
| Antenna Type | PIFA Antenna |
| Antenna Gain | Cellular Band: -1.50 dBi PCS Band: -1.10 dBi |
| Type of Modulation | GSM: GMSK GPRS: GMSK EDGE: GMSK / 8PSK WCDMA: BPSK (Uplink) HSDPA : QPSK (Uplink) HSUPA : QPSK (Uplink) HSPA+ : 16QAM (uplink is not supported) |

1.5 Modification of EUT

No modifications are made to the EUT during all test items.

1.6 Specification of Accessory

| Specification of Accessory | | | | |
|----------------------------|------------------|---|------------|-----------------|
| AC Adapter | Brand Name | Motorola (Acbel) | Model Name | C-P56 SPN5947A |
| | Power Rating | I/P: 100-240 Vac, 130mA, O/P: 5 Vdc, 1000mA | | |
| Battery | Brand Name | Motorola (SCUD) | Model Name | HC40 |
| | Power Rating | 3.8Vdc, 2245/2350mAh (Min/Typ) | Type | Li-ion |
| Earphone | Brand Name | Motorola (NEW LEADER) | Model Name | NLD-EM127T-97SF |
| | Signal Line Type | 1.2 meter, non-shielded cable, without ferrite core | | |
| USB Cable | Brand Name | Motorola (STARW) | Model Name | XJ-007075 |
| | Signal Line Type | 1.0 meter, non-shielded cable, without ferrite core | | |

1.7 Maximum ERP/EIRP Power, Frequency Tolerance, and Emission Designator

| FCC Rule | System | Type of Modulation | Maximum ERP/EIRP (W) | Frequency Tolerance (ppm) | Emission Designator |
|----------|----------------------------|--------------------|----------------------|---------------------------|---------------------|
| Part 22 | GSM850 GSM | GMSK | 0.8433 | 0.0347 ppm | 243KGXW |
| Part 22 | GSM850 EDGE class 8 | 8PSK | 0.2228 | 0.0407 ppm | 249KG7W |
| Part 22 | WCDMA Band V RMC 12.2Kbps | BPSK | 0.0931 | 0.0359 ppm | 4M15F9W |
| Part 24 | GSM1900 GSM | GMSK | 0.7745 | 0.0133 ppm | 244KGXW |
| Part 24 | GSM1900 EDGE class 8 | 8PSK | 0.3199 | 0.0287 ppm | 248KG7W |
| Part 24 | WCDMA Band II RMC 12.2Kbps | BPSK | 0.1596 | 0.0234 ppm | 4M15F9W |



1.8 Testing Location

| | | | |
|---------------------------|---|-----------|-----------------------------|
| Test Site | SPORTON INTERNATIONAL (KUNSHAN) INC. | | |
| Test Site Location | No. 3-2, PingXiang Road, Kunshan, Jiangsu Province, P. R. China TEL: +86-0512-5790-0158 FAX: +86-0512-5790-0958 | | |
| Test Site No. | Sporton Site No. | | FCC Registration No. |
| | TH01-KS | 03CH03-KS | 306251 |

Note: The test site complies with ANSI C63.4 2014 requirement.

1.9 Applicable Standards

According to the specifications of the manufacturer, the EUT must comply with the requirements of the following standards:

- ♦ 47 CFR Part 2, 22(H), 24(E)
- ♦ ANSI / TIA / EIA-603-D-2010
- ♦ FCC KDB 971168 D01 Power Meas. License Digital Systems v02r02
- ♦ FCC KDB 412172 D01 Determining ERP and EIRP v01r01

Remark:

1. All test items were verified and recorded according to the standards and without any deviation during the test.
2. This EUT has also been tested and complied with the requirements of FCC Part 15, Subpart B, recorded in a separate test report.



2 Test Configuration of Equipment Under Test

2.1 Test Mode

Antenna port conducted and radiated test items were performed according to KDB 971168 D01 Power Meas. License Digital Systems v02r02 with maximum output power.

Radiated measurements were performed with rotating EUT in different three orthogonal test planes to find the maximum emission.

Radiated emissions were investigated as following frequency range:

1. 30 MHz to 10th harmonic for GSM850 and WCDMA Band V.
2. 30 MHz to 10th harmonic for GSM1900 and WCDMA Band II.

All modes and data rates and positions were investigated.

Test modes are chosen to be reported as the worst case configuration below:

| Test Modes | | |
|---------------|---|---|
| Band | Radiated TCs | Conducted TCs |
| GSM 850 | <ul style="list-style-type: none"> ■ GSM Link ■ EDGE class 8 Link | <ul style="list-style-type: none"> ■ GSM Link ■ EDGE class 8 Link |
| GSM 1900 | <ul style="list-style-type: none"> ■ GSM Link ■ EDGE class 8 Link | <ul style="list-style-type: none"> ■ GSM Link ■ EDGE class 8 Link |
| WCDMA Band V | <ul style="list-style-type: none"> ■ RMC 12.2Kbps Link | <ul style="list-style-type: none"> ■ RMC 12.2Kbps Link |
| WCDMA Band II | <ul style="list-style-type: none"> ■ RMC 12.2Kbps Link | <ul style="list-style-type: none"> ■ RMC 12.2Kbps Link |

2.2 Connection Diagram of Test System

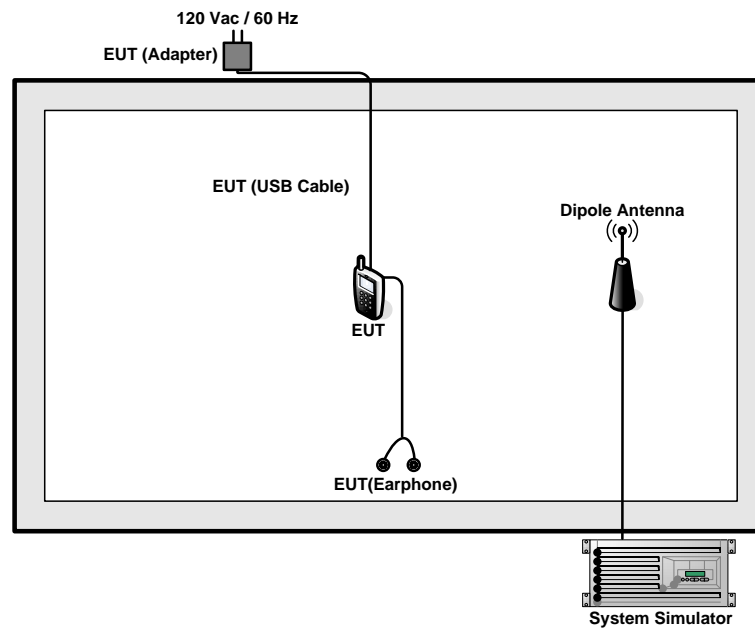

2.3 Support Unit used in test configuration

| Item | Equipment | Trade Name | Model No. | FCC ID | Data Cable | Power Cord |
|------|------------------|------------|-----------|--------|------------|-------------------|
| 1. | System Simulator | R&S | CMU 200 | N/A | N/A | Unshielded, 1.8 m |
| 2. | DC Power Supply | GW INSTRON | GPD-2303S | N/A | N/A | Unshielded, 1.8 m |

2.4 Measurement Results Explanation Example

For all conducted test items:

The offset level is set in the spectrum analyzer to compensate the RF cable loss and attenuator factor between RF conducted output port and spectrum analyzer. With the offset compensation, the spectrum analyzer reading level will be exactly the RF output level.

The spectrum analyzer offset is derived from RF cable loss and attenuator factor.

Offset = RF cable loss + attenuator factor.

The following shows an offset computation example with RF cable loss 4.5 dB and a 10dB attenuator.

Example :

$$\begin{aligned} \text{Offset(dB)} &= \text{RF cable loss(dB)} + \text{attenuator factor(dB)} \\ &= 4.5 + 10 = 14.5 \text{ (dB)} \end{aligned}$$

3 Conducted Test Result

3.1 Measuring Instruments

See list of measuring instruments of this test report.

3.2 Test Setup

3.2.1 Conducted Output Power



3.2.2 Peak-to-Average Ratio, Occupied Bandwidth, Conducted Band-Edge and Conducted Spurious Emission

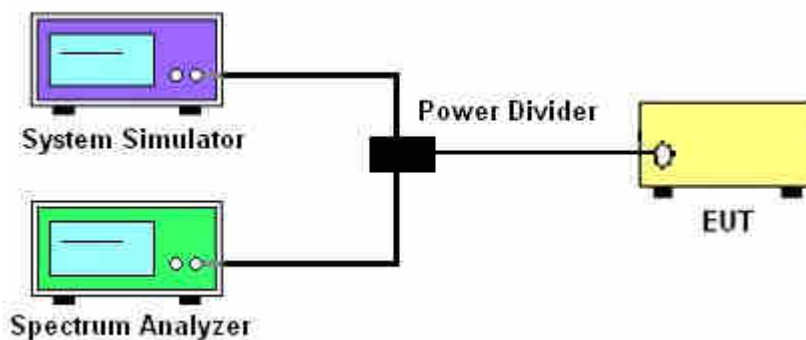

3.2.3 Frequency Stability

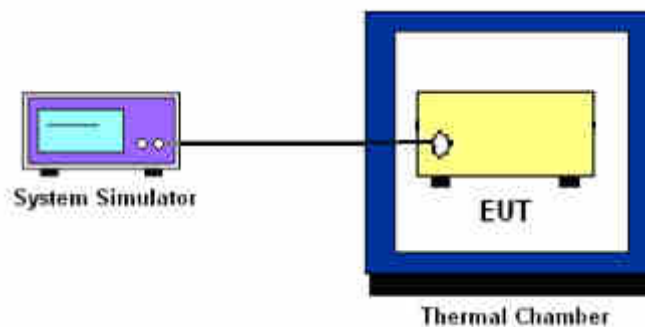

3.3 Test Result of Conducted Test

Please refer to Appendix A.



3.4 Conducted Output Power and ERP/EIRP

3.4.1 Description of the Conducted Output Power and ERP/EIRP

A system simulator was used to establish communication with the EUT. Its parameters were set to enforce EUT transmitting at the maximum power. The measured power in the radio frequency on the transmitter output terminals shall be reported.

The ERP of mobile transmitters must not exceed 7 Watts for GSM850 and WCDMA Band V.

The EIRP of mobile transmitters must not exceed 2 Watts for GSM1900 and WCDMA Band II.

According to KDB 412172 D01 Power Approach,

$EIRP = P_T + G_T - L_C$, $ERP = EIRP - 2.15$, where

P_T = transmitter output power in dBm

G_T = gain of the transmitting antenna in dBi

L_C = signal attenuation in the connecting cable between the transmitter and antenna in dB

3.4.2 Test Procedures

1. The transmitter output port was connected to the system simulator.
2. Set EUT at maximum power through system simulator.
3. Select lowest, middle, and highest channels for each band and different modulation.
4. Measure the maximum burst average power for GSM and maximum average power for other modulation signal.



3.5 Peak-to-Average Ratio

3.5.1 Description of the PAR Measurement

The peak-to-average ratio (PAR) of the transmission may not exceed 13 dB.

3.5.2 Test Procedures

1. The testing follows FCC KDB 971168 D01 v02r02 Section 5.7.1.
2. The EUT was connected to spectrum analyzer and system simulator via a power divider.
3. Set EUT to transmit at maximum output power.
4. When the duty cycle is less than 98%, then signal gating will be implemented on the spectrum analyzer by triggering from the system simulator.
5. Set the CCDF (Complementary Cumulative Distribution Function) option of the spectrum analyzer.
Record the maximum PAPR level associated with a probability of 0.1%.



3.6 99% Occupied Bandwidth and 26dB Bandwidth Measurement

3.6.1 Description of 99% Occupied Bandwidth and 26dB Bandwidth Measurement

The occupied bandwidth is the width of a frequency band such that, below the lower and above the upper frequency limits, the mean powers emitted are each equal to a specified percentage 0.5% of the total mean transmitted power.

The 26 dB emission bandwidth is defined as the frequency range between two points, one above and one below the carrier frequency, at which the spectral density of the emission is attenuated 26 dB below the maximum in-band spectral density of the modulated signal. Spectral density (power per unit bandwidth) is to be measured with a detector of resolution bandwidth equal to approximately 1.0% of the emission bandwidth.

3.6.2 Test Procedures

1. The testing follows FCC KDB 971168 v02r02 Section 4.2.
2. The EUT was connected to spectrum analyzer and system simulator via a power divider.
3. The spectrum analyzer center frequency is set to the nominal EUT channel center frequency. The span range for the spectrum analyzer shall be between two and five times the anticipated OBW.
4. The nominal resolution bandwidth (RBW) shall be in the range of 1 to 5 % of the anticipated OBW, and the VBW shall be at least 3 times the RBW.
5. Set the detection mode to peak, and the trace mode to max hold.
6. Determine the reference value: Set the EUT to transmit a modulated signal. Allow the trace to stabilize. Set the spectrum analyzer marker to the highest level of the displayed trace.
(this is the reference value)
7. Determine the “-26 dB down amplitude” as equal to (Reference Value – X).
8. Place two markers, one at the lowest and the other at the highest frequency of the envelope of the spectral display such that each marker is at or slightly below the “-X dB down amplitude” determined in step 6. If a marker is below this “-X dB down amplitude” value it shall be placed as close as possible to this value. The OBW is the positive frequency difference between the two markers.
9. Use the 99 % power bandwidth function of the spectrum analyzer and report the measured bandwidth.



3.7 Conducted Band Edge

3.7.1 Description of Conducted Band Edge Measurement

The power of any emission outside of the authorized operating frequency ranges must be lower than the transmitter power (P) by a factor of at least $43 + 10 \log (P)$ dB.

3.7.2 Test Procedures

1. The testing follows FCC KDB 971168 D01 v02r02 Section 6.0.
2. The EUT was connected to the spectrum analyzer and system simulator via a power divider.
3. The RF output of EUT was connected to the spectrum analyzer by an RF cable and attenuator. The path loss was compensated to the results for each measurement.
4. The band edges of low and high channels for the highest RF powers were measured.
5. The RF fundamental frequency should be excluded against the limit line in the operating frequency band.
6. The limit line is derived from $43 + 10\log(P)$ dB below the transmitter power P(Watts)
 $= P(W) - [43 + 10\log(P)]$ (dB)
 $= [30 + 10\log(P)]$ (dBm) - $[43 + 10\log(P)]$ (dB)
 $= -13\text{dBm}$.



3.8 Conducted Spurious Emission

3.8.1 Description of Conducted Spurious Emission Measurement

The power of any emission outside of the authorized operating frequency ranges must be lower than the transmitter power (P) by a factor of at least $43 + 10 \log (P)$ dB.

It is measured by means of a calibrated spectrum analyzer and scanned from 30 MHz up to a frequency including its 10th harmonic.

3.8.2 Test Procedures

1. The testing follows FCC KDB 971168 D01 v02r02 Section 6.0.
2. The EUT was connected to the spectrum analyzer and system simulator via a power divider.
3. The RF output of EUT was connected to the spectrum analyzer by an RF cable and attenuator. The path loss was compensated to the results for each measurement.
4. The middle channel for the highest RF power within the transmitting frequency was measured.
5. The conducted spurious emission for the whole frequency range was taken.
6. The RF fundamental frequency should be excluded against the limit line in the operating frequency band.
7. The limit line is derived from $43 + 10\log(P)$ dB below the transmitter power P(Watts)
= $P(W) - [43 + 10\log(P)]$ (dB)
= $[30 + 10\log(P)]$ (dBm) - $[43 + 10\log(P)]$ (dB)
= -13dBm.



3.9 Frequency Stability

3.9.1 Description of Frequency Stability Measurement

The frequency stability shall be measured by variation of ambient temperature and variation of primary supply voltage to ensure that the fundamental emission stays within the authorized frequency block. The frequency stability of the transmitter shall be maintained within $\pm 0.00025\%$ ($\pm 2.5\text{ppm}$) of the center frequency.

3.9.2 Test Procedures for Temperature Variation

1. The testing follows FCC KDB 971168 D01 v02r02 Section 9.0.
2. The EUT was set up in the thermal chamber and connected with the system simulator.
3. With power OFF, the temperature was decreased to -30°C and the EUT was stabilized before testing. Power was applied and the maximum change in frequency was recorded within one minute.
4. With power OFF, the temperature was raised in 10°C steps up to 50°C . The EUT was stabilized at each step for at least half an hour. Power was applied and the maximum frequency change was recorded within one minute.

3.9.3 Test Procedures for Voltage Variation

1. The testing follows FCC KDB 971168 D01 v02r02 Section 9.0.
2. The EUT was placed in a temperature chamber at $20\pm 5^{\circ}\text{C}$ and connected with the system simulator.
3. The power supply voltage to the EUT was varied from 85% to 115% of the nominal value measured at the input to the EUT.
4. The variation in frequency was measured for the worst case.

4 Radiated Test Items

4.1 Measuring Instruments

See list of measuring instruments of this test report.

4.2 Test Setup

4.2.1 For radiated test from 30MHz to 1GHz

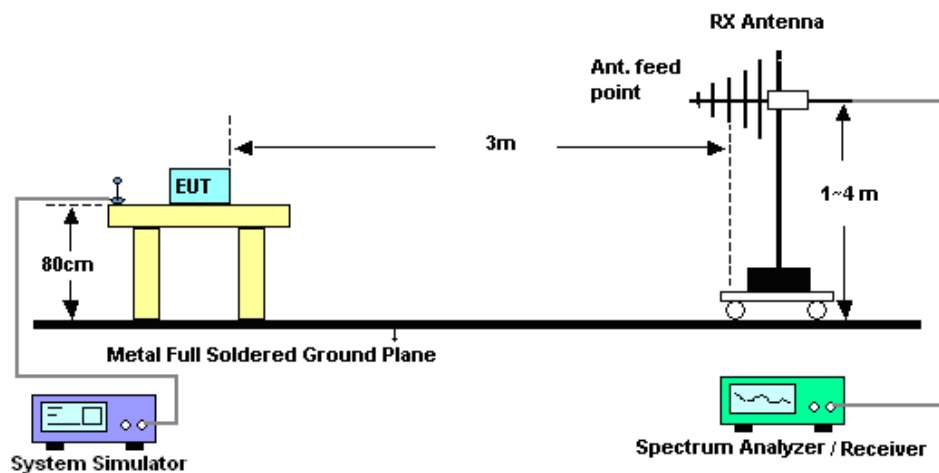

4.2.2 For radiated test above 1GHz

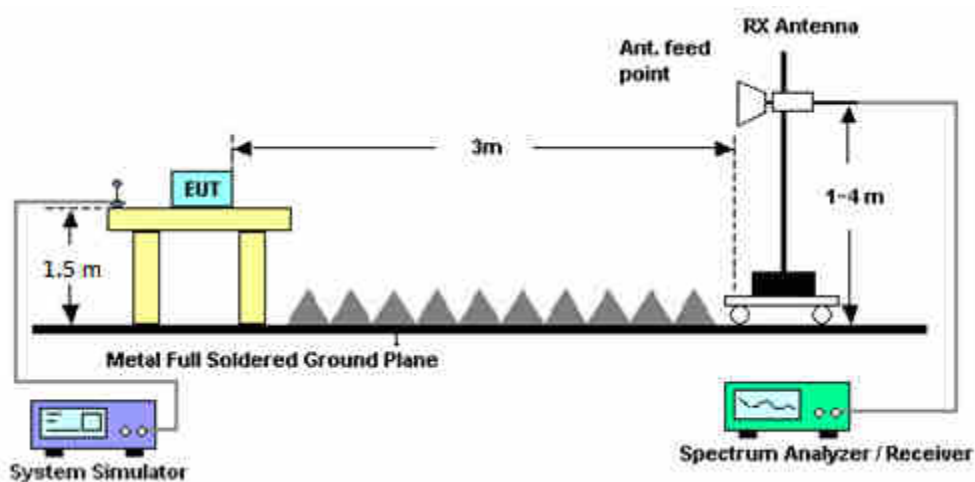

4.3 Test Result of Radiated Test

Please refer to Appendix B.



4.4 Field Strength of Spurious Radiation Measurement

4.4.1 Description of Field Strength of Spurious Radiated Measurement

The power of any emission outside of the authorized operating frequency ranges must be attenuated below the transmitter power (P) by a factor of at least $43 + 10 \log (P)$ dB. The spectrum is scanned from 30 MHz up to a frequency including its 10th harmonic.

4.4.2 Test Procedures

1. The testing follows FCC KDB 971168 D01 v02r02 Section 5.8 and ANSI / TIA-603-D-2010 Section 2.2.12.
2. The EUT was placed on a rotatable wooden table 0.8 meters for frequency below 1GHz and 1.5 meter for frequency above 1GHz above the ground.
3. The EUT was set 3 meters from the receiving antenna, which was mounted on the antenna tower.
4. The table was rotated 360 degrees to determine the position of the highest spurious emission.
5. The height of the receiving antenna is varied between one meter and four meters to search for the maximum spurious emission for both horizontal and vertical polarizations.
6. Make the measurement with the spectrum analyzer's RBW = 1MHz, VBW = 3MHz, taking record of maximum spurious emission.
7. A horn antenna was substituted in place of the EUT and was driven by a signal generator.
8. Tune the output power of signal generator to the same emission level with EUT maximum spurious emission.
9. Taking the record of output power at antenna port.
10. Repeat step 7 to step 8 for another polarization.
11. $EIRP \text{ (dBm)} = S.G. \text{ Power} - Tx \text{ Cable Loss} + Tx \text{ Antenna Gain}$
12. $ERP \text{ (dBm)} = EIRP - 2.15$
13. The RF fundamental frequency should be excluded against the limit line in the operating frequency band.
14. The limit line is derived from $43 + 10\log(P)$ dB below the transmitter power P(Watts)
= $P(W) - [43 + 10\log(P)] \text{ (dB)}$
= $[30 + 10\log(P)] \text{ (dBm)} - [43 + 10\log(P)] \text{ (dB)}$
= -13dBm.



5 List of Measuring Equipment

| Instrument | Manufacturer | Model No. | Serial No. | Characteristics | Calibration Date | Test Date | Due Date | Remark |
|-----------------------|--------------|-------------------------|------------|-----------------|------------------|---------------|---------------|-----------------------|
| Spectrum Analyzer | R&S | FSV40 | 101040 | 10Hz~40GHz | Aug. 09, 2016 | Jan. 06, 2017 | Aug. 08, 2017 | Conducted (TH01-KS) |
| Thermal Chamber | Ten Billion | TTC-B3S | TBN-960502 | -40~+150°C | Oct. 13, 2016 | Jan. 06, 2017 | Oct. 12, 2017 | Conducted (TH01-KS) |
| EXA Spectrum Analyzer | Keysight | N9010A | MY55150244 | 10Hz~44GHz | Apr. 22, 2016 | Jan. 25, 2017 | Apr. 21, 2017 | Radiation (03CH03-KS) |
| Bilog Antenna | TeseQ | CBL6112D | 35406 | 25MHz~2GHz | Apr. 16, 2016 | Jan. 06, 2017 | Apr. 15, 2017 | Radiation (03CH03-KS) |
| Horn Antenna | Schwarzbeck | BBHA9120 D | 9120D-1356 | 1GHz~18GHz | Apr. 16, 2016 | Jan. 06, 2017 | Apr. 15, 2017 | Radiation (03CH03-KS) |
| SHF-EHF Horn | Schwarzbeck | BBHA 9170 | BBHA170249 | 15GHz~40GHz | Mar. 03, 2016 | Jan. 06, 2017 | Mar. 02, 2017 | Radiation (03CH03-KS) |
| Amplifier | SONOMA | 310N | 187289 | 9kHz~1GHz | Aug. 09, 2016 | Jan. 06, 2017 | Aug. 08, 2017 | Radiation (03CH03-KS) |
| high gain Amplifier | MITEQ | AMF-7D-00 101800-30- | 1943529 | 1GHz~18GHz | Jan. 20, 2016 | Jan. 06, 2017 | Jan. 19, 2017 | Radiation (03CH03-KS) |
| Amplifier | MITEQ | TTA1840-35 -HG | 1887435 | 18GHz~40GHz | Jan. 20, 2016 | Jan. 06, 2017 | Jan. 19, 2017 | Radiation (03CH03-KS) |
| AC Power Source | Chroma | 61601 | F104090004 | N/A | NCR | Jan. 06, 2017 | NCR | Radiation (03CH03-KS) |
| Turn Table | ChamPro | EM 1000-T | 060762-T | 0~360 degree | NCR | Jan. 06, 2017 | NCR | Radiation (03CH03-KS) |
| Antenna Mast | ChamPro | EM 1000-A | 060762-A | 1 m~4 m | NCR | Jan. 06, 2017 | NCR | Radiation (03CH03-KS) |

NCR: No Calibration Required



6 Uncertainty of Evaluation

Uncertainty of Radiated Emission Measurement (30 MHz ~ 1000 MHz)

| | |
|---|-------|
| Measuring Uncertainty for a Level of Confidence of 95% ($U = 2Uc(y)$) | 4.5dB |
|---|-------|

Uncertainty of Radiated Emission Measurement (1GHz ~ 18GHz)

| | |
|---|-------|
| Measuring Uncertainty for a Level of Confidence of 95% ($U = 2Uc(y)$) | 4.5dB |
|---|-------|

Uncertainty of Radiated Emission Measurement (18GHz ~ 40GHz)

| | |
|---|-------|
| Measuring Uncertainty for a Level of Confidence of 95% ($U = 2Uc(y)$) | 4.6dB |
|---|-------|



Appendix A. Test Results of Conducted Test

Conducted Output Power(Average power)

| Conducted Power (*Unit: dBm) | | | | | | |
|------------------------------|--------|-------|-------|---------|--------|--------|
| Band | GSM850 | | | GSM1900 | | |
| Channel | 128 | 189 | 251 | 512 | 661 | 810 |
| Frequency | 824.2 | 836.4 | 848.8 | 1850.2 | 1880.0 | 1909.8 |
| GSM | 32.91 | 32.72 | 32.59 | 29.99 | 29.79 | 29.98 |
| GPRS class 8 | 32.88 | 32.68 | 32.55 | 29.92 | 29.76 | 29.94 |
| GPRS class 10 | 31.33 | 31.15 | 30.99 | 28.80 | 28.67 | 28.87 |
| GPRS class 11 | 29.37 | 29.18 | 29.02 | 26.38 | 26.25 | 26.46 |
| GPRS class 12 | 28.44 | 28.22 | 28.08 | 25.93 | 25.80 | 26.01 |
| EGPRS class 8 | 27.13 | 27.09 | 26.86 | 26.15 | 26.00 | 25.72 |
| EGPRS class 10 | 26.15 | 26.18 | 25.93 | 24.92 | 24.70 | 24.38 |
| EGPRS class 11 | 24.04 | 24.08 | 23.83 | 22.81 | 22.68 | 22.31 |
| EGPRS class 12 | 22.81 | 22.81 | 22.66 | 21.48 | 21.24 | 21.14 |

| Conducted Power (*Unit: dBm) | | | | | | |
|------------------------------|--------------|-------|-------|---------------|-------|--------|
| Band | WCDMA Band V | | | WCDMA Band II | | |
| Channel | 4132 | 4182 | 4233 | 9262 | 9400 | 9538 |
| Frequency | 826.4 | 836.4 | 846.6 | 1852.4 | 1880 | 1907.6 |
| AMR 12.2Kbps | 23.01 | 23.11 | 23.33 | 22.85 | 22.93 | 22.90 |
| RMC 12.2Kbps | 23.04 | 23.12 | 23.34 | 22.87 | 23.13 | 22.91 |
| HSDPA Subtest-1 | 22.04 | 22.15 | 22.26 | 21.84 | 22.00 | 21.90 |
| HSDPA Subtest-2 | 22.07 | 22.14 | 22.28 | 21.81 | 21.91 | 21.89 |
| HSDPA Subtest-3 | 21.61 | 21.67 | 21.79 | 21.32 | 21.43 | 21.40 |
| HSDPA Subtest-4 | 21.59 | 21.61 | 21.76 | 21.27 | 21.41 | 21.37 |
| HSUPA Subtest-1 | 20.11 | 20.18 | 20.30 | 19.83 | 19.92 | 19.94 |
| HSUPA Subtest-2 | 20.09 | 20.16 | 20.30 | 19.77 | 19.90 | 19.92 |
| HSUPA Subtest-3 | 21.13 | 21.15 | 21.28 | 20.82 | 20.93 | 20.93 |
| HSUPA Subtest-4 | 19.60 | 19.62 | 19.77 | 19.25 | 19.38 | 19.36 |
| HSUPA Subtest-5 | 21.50 | 22.20 | 22.30 | 21.80 | 21.90 | 22.00 |



ERP/EIRP

| GSM850 ($G_T - L_C = -1.50$ dB) | | | |
|---|--------------|--------------|---------------|
| Channel | 128 | 189 | 251 |
| | (Low) | (Mid) | (High) |
| Frequency | 824.2 | 836.4 | 848.8 |
| (MHz) | | | |
| Conducted Power (dBm) | 32.91 | 32.72 | 32.59 |
| Conducted Power (Watts) | 1.9543 | 1.8707 | 1.8155 |
| ERP(dBm) | 29.26 | 29.07 | 28.94 |
| ERP(Watts) | 0.8433 | 0.8072 | 0.7834 |

| EDGE850 ($G_T - L_C = -1.50$ dB) | | | |
|--|--------------|--------------|---------------|
| Channel | 128 | 189 | 251 |
| | (Low) | (Mid) | (High) |
| Frequency | 824.2 | 836.4 | 848.8 |
| (MHz) | | | |
| Conducted Power (dBm) | 27.13 | 27.09 | 26.86 |
| Conducted Power (Watts) | 0.5164 | 0.5117 | 0.4853 |
| ERP(dBm) | 23.48 | 23.44 | 23.21 |
| ERP(Watts) | 0.2228 | 0.2208 | 0.2094 |



| GSM1900 (G _T - L _C = -1.10 dB) | | | |
|--|--------|--------|--------|
| Channel | 512 | 661 | 810 |
| | (Low) | (Mid) | (High) |
| Frequency | 1850.2 | 1880 | 1909.8 |
| (MHz) | | | |
| Conducted Power (dBm) | 29.99 | 29.79 | 29.98 |
| Conducted Power (Watts) | 0.9977 | 0.9528 | 0.9954 |
| EIRP(dBm) | 28.89 | 28.69 | 28.88 |
| EIRP(Watts) | 0.7745 | 0.7396 | 0.7727 |

| EDGE1900 (G _T - L _C = -1.10 dB) | | | |
|---|--------|--------|--------|
| Channel | 512 | 661 | 810 |
| | (Low) | (Mid) | (High) |
| Frequency | 1850.2 | 1880 | 1909.8 |
| (MHz) | | | |
| Conducted Power (dBm) | 26.15 | 26.00 | 25.72 |
| Conducted Power (Watts) | 0.4121 | 0.3981 | 0.3733 |
| EIRP(dBm) | 25.05 | 24.90 | 24.62 |
| EIRP(Watts) | 0.3199 | 0.3090 | 0.2897 |



| WCDMA Band V ($G_T - L_C = -1.50$ dB) | | | |
|--|--------|--------|--------|
| Channel | 4132 | 4182 | 4233 |
| | (Low) | (Mid) | (High) |
| Frequency | 826.4 | 836.4 | 846.6 |
| (MHz) | | | |
| Conducted Power (dBm) | 23.04 | 23.12 | 23.34 |
| Conducted Power (Watts) | 0.2014 | 0.2051 | 0.2158 |
| ERP(dBm) | 19.39 | 19.47 | 19.69 |
| ERP(Watts) | 0.0869 | 0.0885 | 0.0931 |

| WCDMA Band II ($G_T - L_C = -1.10$ dB) | | | |
|---|--------|--------|--------|
| Channel | 9262 | 9400 | 9538 |
| | (Low) | (Mid) | (High) |
| Frequency | 1852.4 | 1880 | 1907.6 |
| (MHz) | | | |
| Conducted Power (dBm) | 22.87 | 23.13 | 22.91 |
| Conducted Power (Watts) | 0.1936 | 0.2056 | 0.1954 |
| EIRP(dBm) | 21.77 | 22.03 | 21.81 |
| EIRP(Watts) | 0.1503 | 0.1596 | 0.1517 |



Peak-to-Average Ratio

| Mode | GSM850(dB) | | Limit: 13dB |
|------------|------------|--------------|-------------|
| Mod. | GSM | EDGE class 8 | Result |
| Lowest CH | 0.12 | 3.01 | PASS |
| Middle CH | 0.12 | 3.04 | |
| Highest CH | 0.20 | 3.19 | |

| Mode | GSM1900(dB) | | Limit: 13dB |
|------------|-------------|--------------|-------------|
| Mod. | GSM | EDGE class 8 | Result |
| Lowest CH | 0.12 | 3.16 | PASS |
| Middle CH | 0.14 | 3.57 | |
| Highest CH | 0.14 | 3.42 | |

| Mode | WCDMA Band V(dB) | WCDMA Band II(dB) | Limit: 13dB |
|------------|------------------|-------------------|-------------|
| Mod. | RMC 12.2Kbps | RMC 12.2Kbps | Result |
| Lowest CH | 3.10 | 3.16 | PASS |
| Middle CH | 3.07 | 3.16 | |
| Highest CH | 3.10 | 3.22 | |

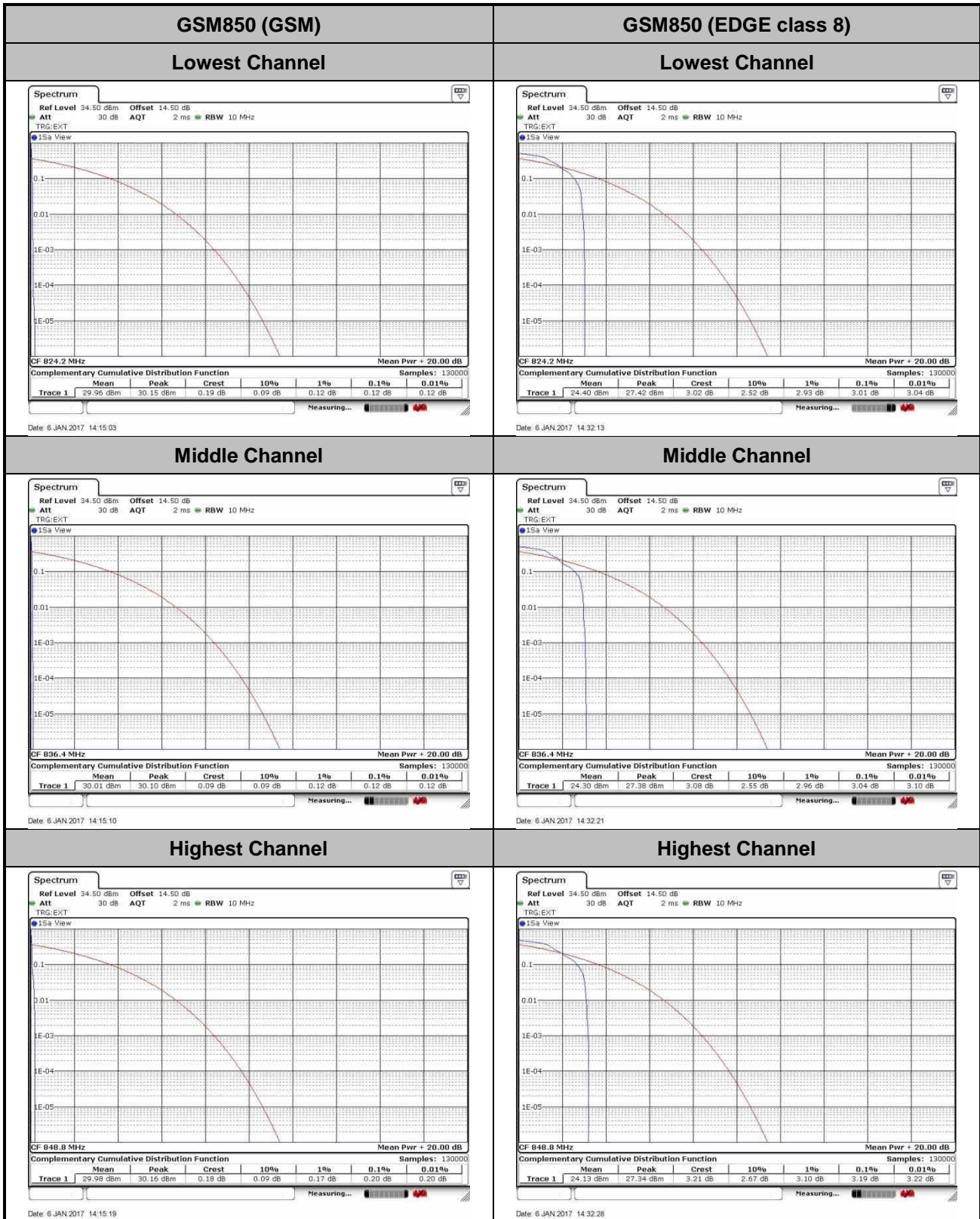

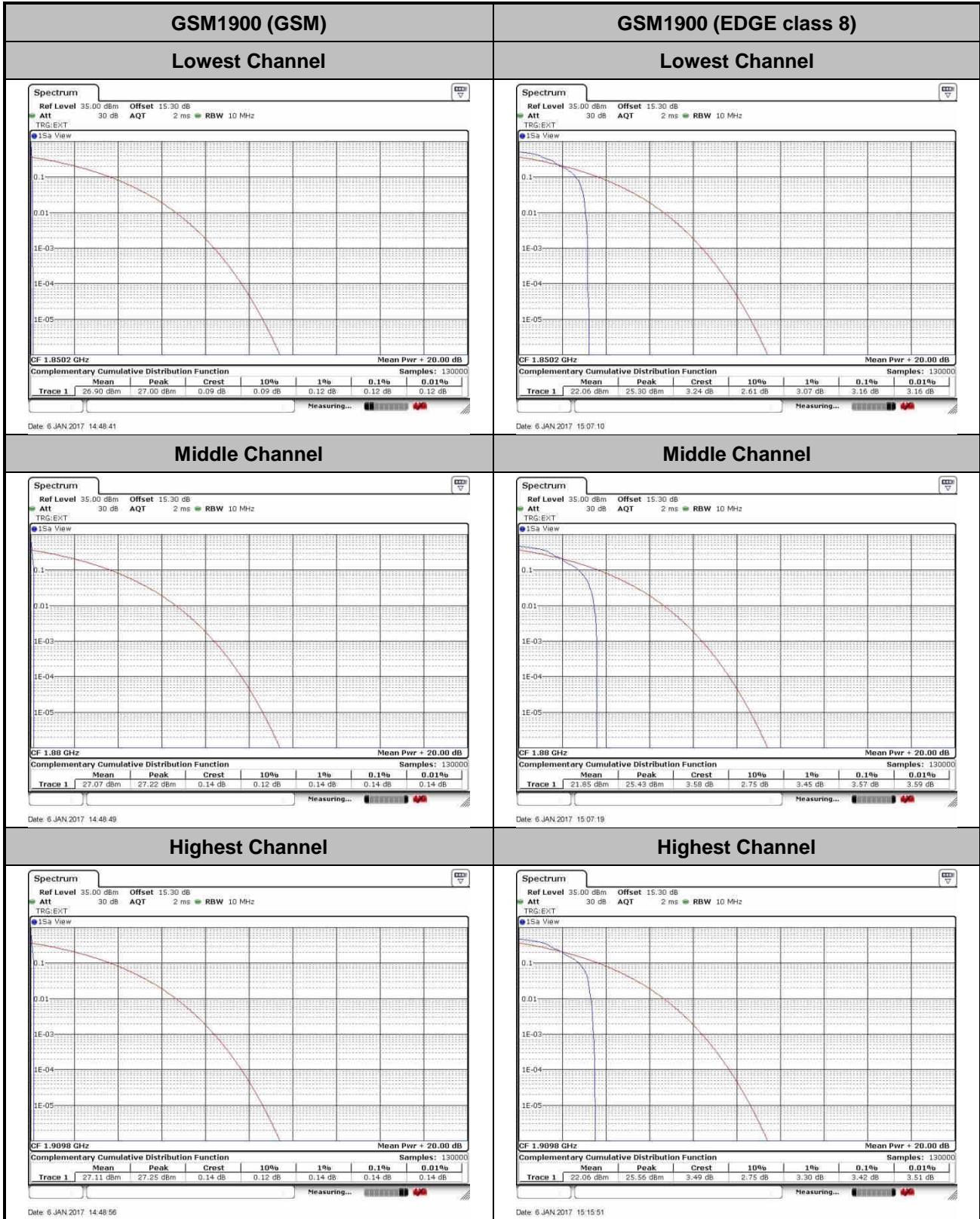

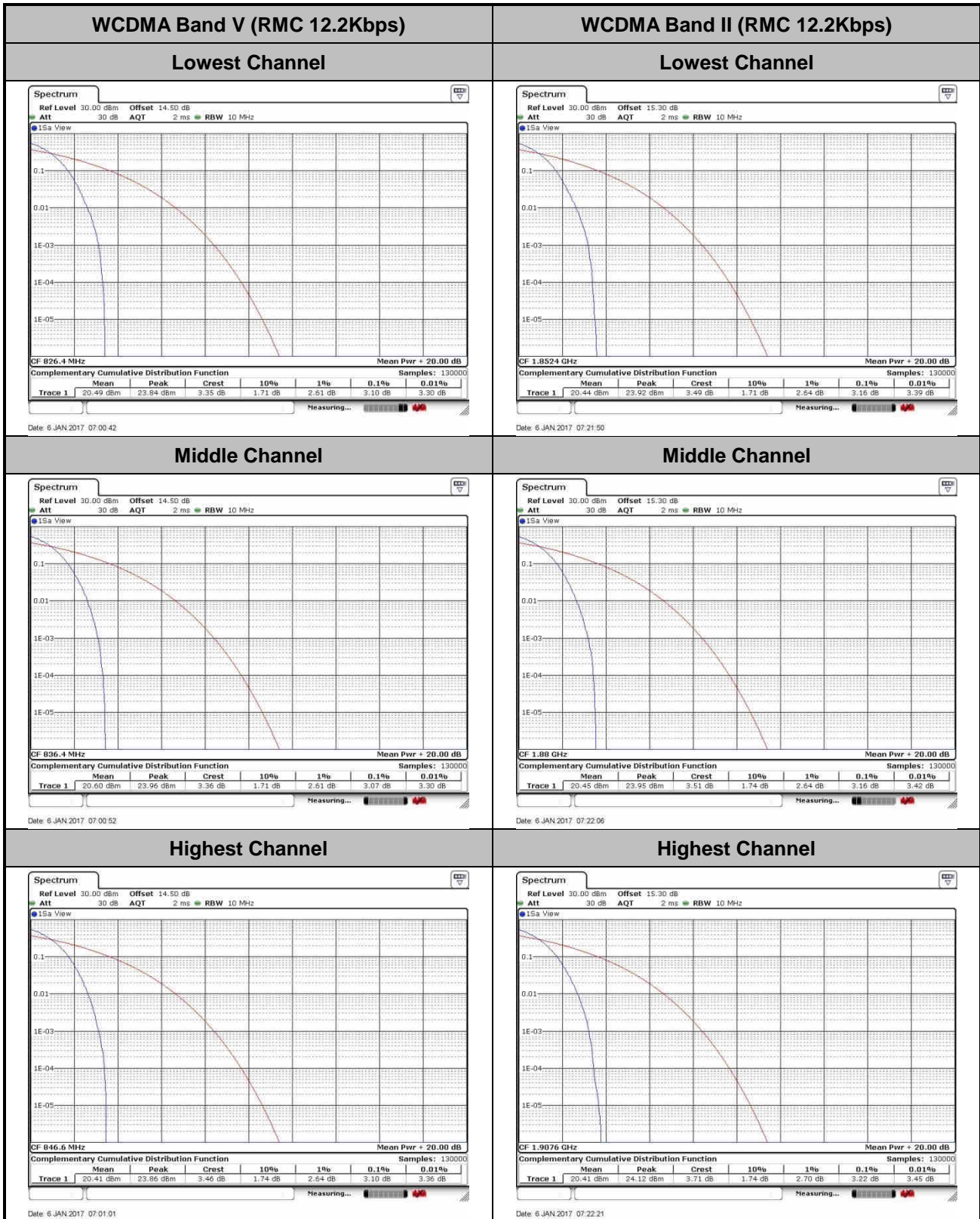



26dB Bandwidth

| Mode | GSM850(MHz) | |
|------------|-------------|--------------|
| Mod. | GSM | EDGE class 8 |
| Lowest CH | 0.317 | 0.315 |
| Middle CH | 0.318 | 0.320 |
| Highest CH | 0.318 | 0.315 |

| Mode | GSM1900(MHz) | |
|------------|--------------|--------------|
| Mod. | GSM | EDGE class 8 |
| Lowest CH | 0.316 | 0.314 |
| Middle CH | 0.316 | 0.312 |
| Highest CH | 0.316 | 0.314 |

| Mode | WCDMA Band V(MHz) | WCDMA Band II(MHz) |
|------------|-------------------|--------------------|
| Mod. | RMC 12.2Kbps | RMC 12.2Kbps |
| Lowest CH | 4.70 | 4.69 |
| Middle CH | 4.68 | 4.69 |
| Highest CH | 4.69 | 4.69 |



GSM850 (GSM)

Lowest Channel

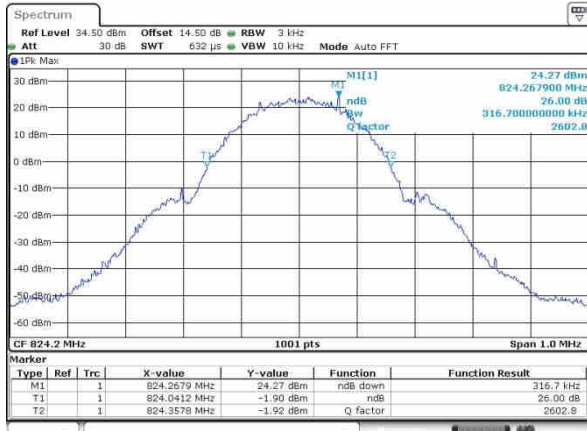

Date: 6 JAN 2017 13:51:04

GSM850 (EDGE class 8)

Lowest Channel

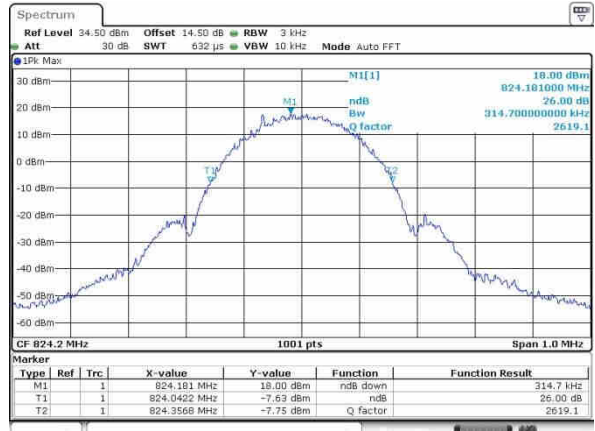

Date: 6 JAN 2017 14:17:30

Middle Channel

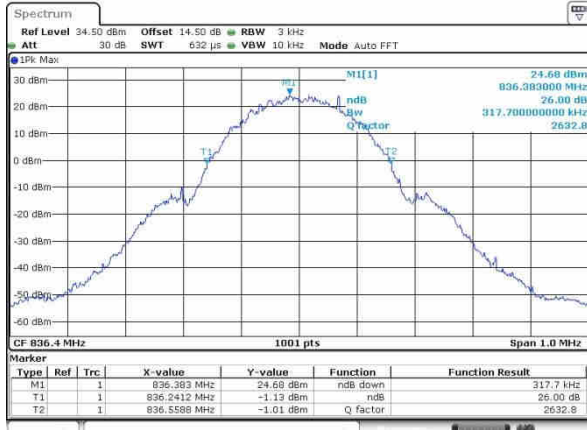

Date: 6 JAN 2017 13:51:32

Middle Channel

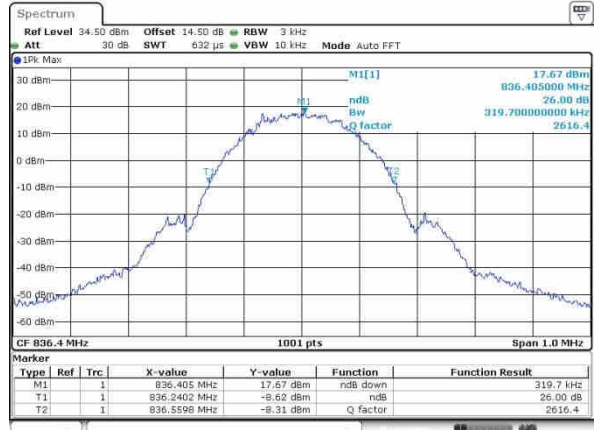

Date: 6 JAN 2017 14:18:16

Highest Channel

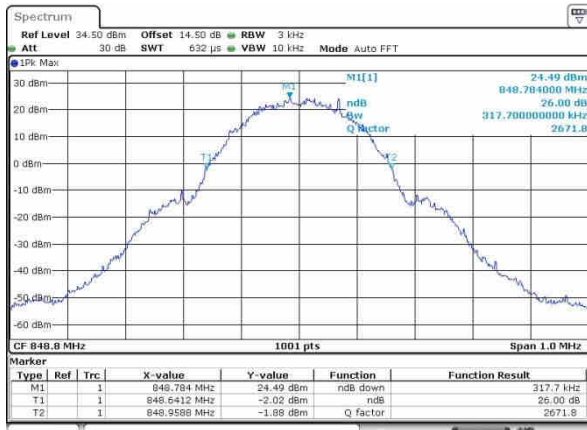

Date: 6 JAN 2017 13:52:01

Highest Channel

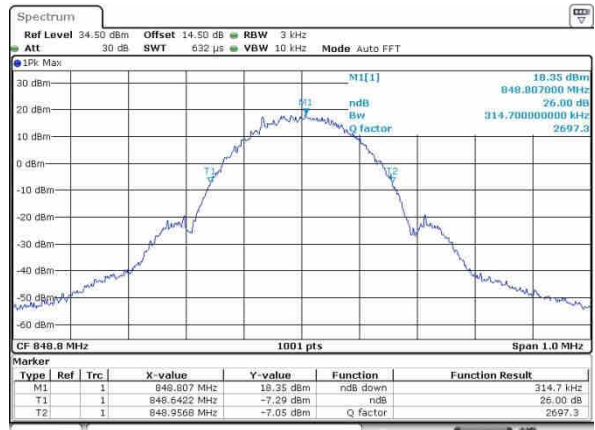

Date: 6 JAN 2017 14:18:52



GSM1900 (GSM)

Lowest Channel

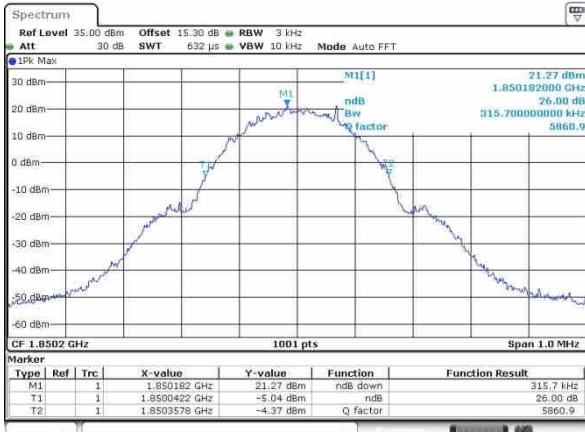

Date: 6 JAN 2017 14:35:10

GSM1900 (EDGE class 8)

Lowest Channel

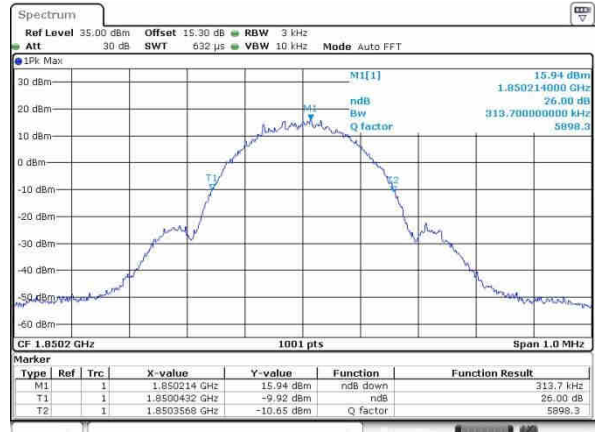

Date: 6 JAN 2017 14:51:40

Middle Channel

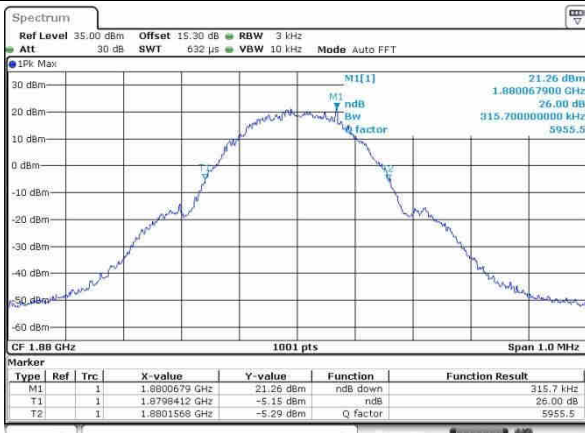

Date: 6 JAN 2017 14:35:38

Middle Channel

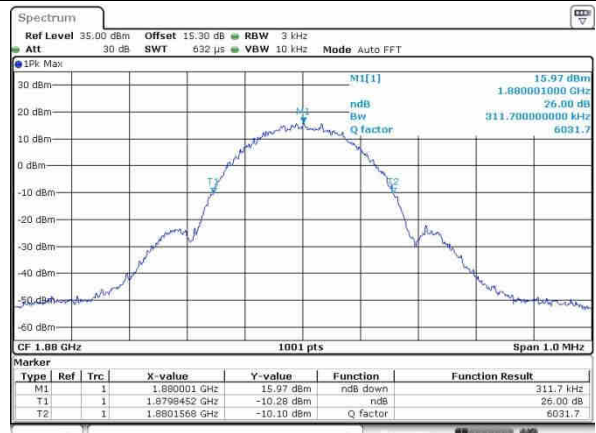

Date: 6 JAN 2017 14:52:30

Highest Channel

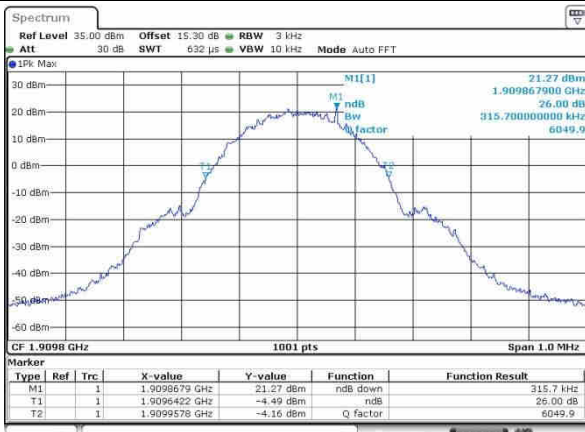

Date: 6 JAN 2017 14:36:06

Highest Channel

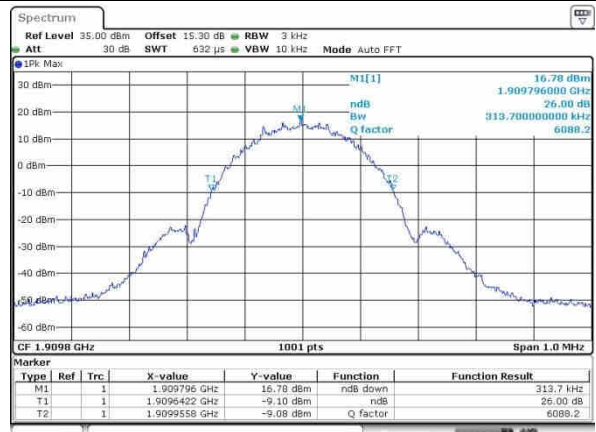

Date: 6 JAN 2017 14:53:48



WCDMA Band V (RMC 12.2Kbps)

Lowest Channel

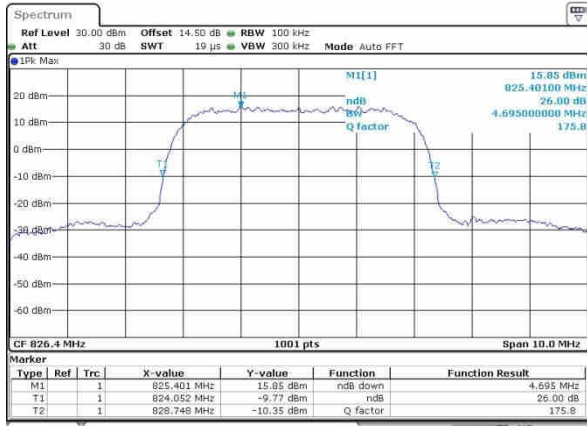

Date: 6 JAN 2017 06:42:36

WCDMA Band II (RMC 12.2Kbps)

Lowest Channel

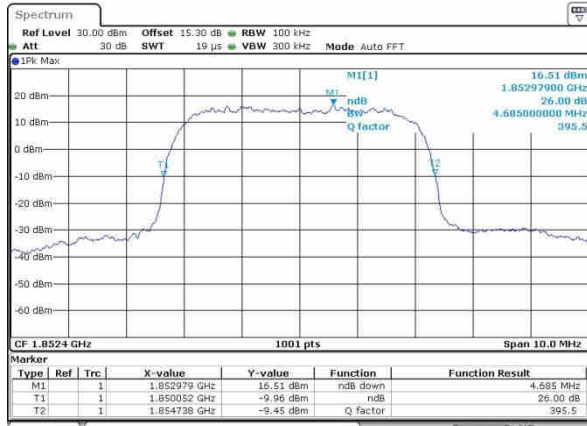

Date: 6 JAN 2017 07:02:45

Middle Channel

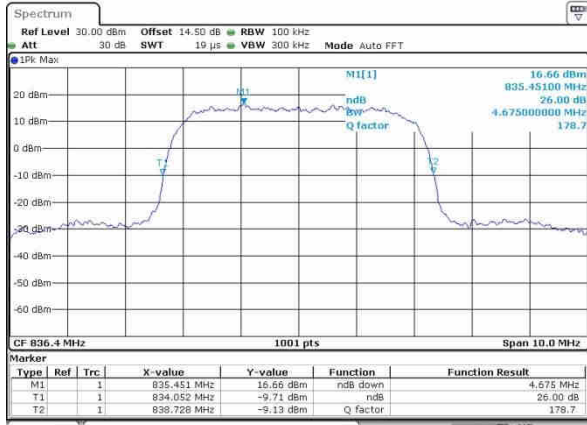

Date: 6 JAN 2017 06:43:13

Middle Channel

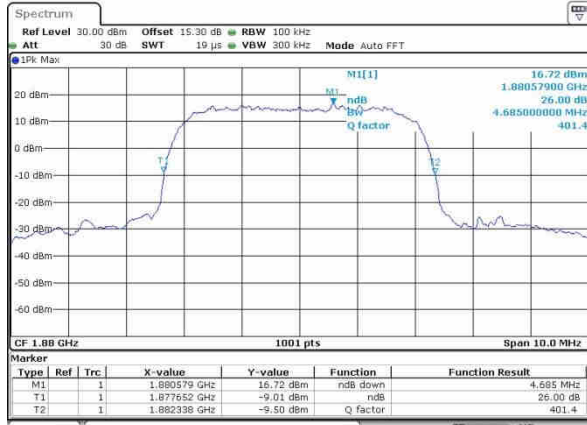

Date: 6 JAN 2017 07:03:30

Highest Channel

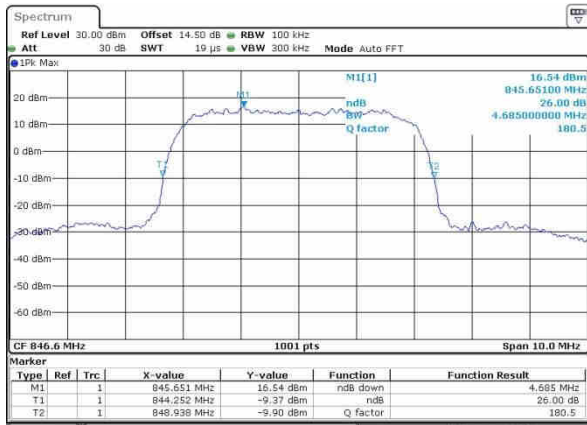

Date: 6 JAN 2017 06:44:01

Highest Channel

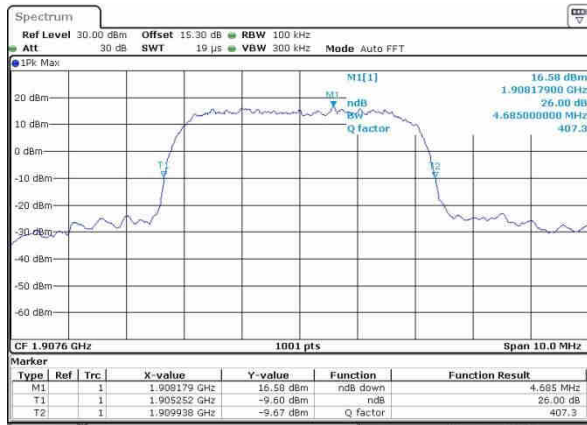

Date: 6 JAN 2017 07:04:07



Occupied Bandwidth

| Mode | GSM850(MHz) | |
|------------|-------------|--------------|
| Mod. | GSM | EDGE class 8 |
| Lowest CH | 0.243 | 0.249 |
| Middle CH | 0.243 | 0.245 |
| Highest CH | 0.243 | 0.249 |

| Mode | GSM1900(MHz) | |
|------------|--------------|--------------|
| Mod. | GSM | EDGE class 8 |
| Lowest CH | 0.244 | 0.246 |
| Middle CH | 0.244 | 0.247 |
| Highest CH | 0.244 | 0.248 |

| Mode | WCDMA Band V(MHz) | WCDMA Band II(MHz) |
|------------|-------------------|--------------------|
| Mod. | RMC 12.2Kbps | RMC 12.2Kbps |
| Lowest CH | 4.14 | 4.15 |
| Middle CH | 4.13 | 4.15 |
| Highest CH | 4.15 | 4.15 |



GSM850 (GSM)

Lowest Channel

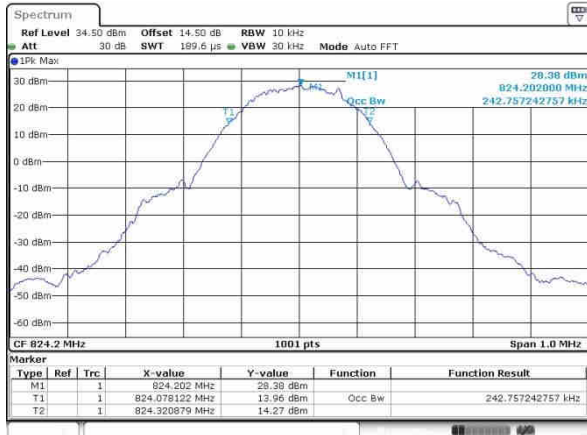

Date: 6 JAN 2017 14:00:31

GSM850 (EDGE class 8)

Lowest Channel

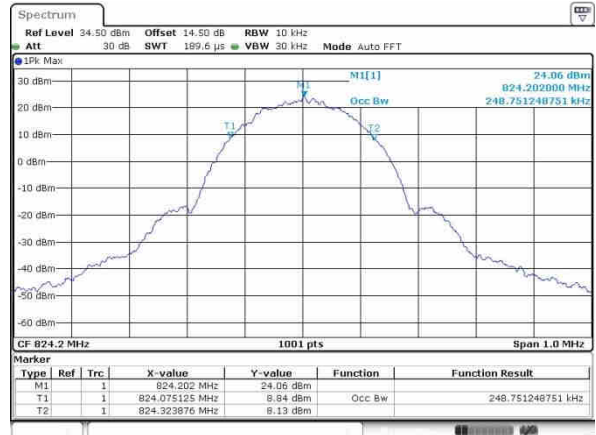

Date: 6 JAN 2017 14:22:29

Middle Channel

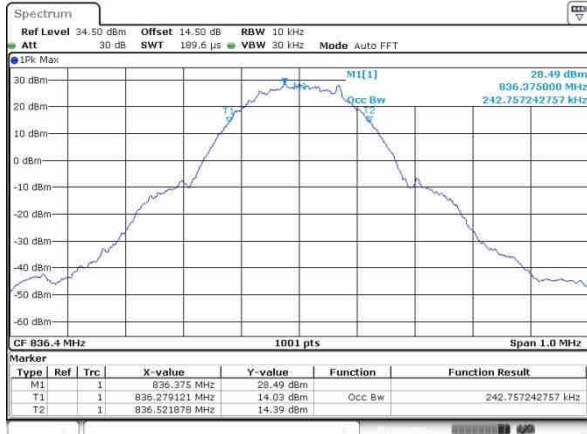

Date: 6 JAN 2017 14:01:00

Middle Channel

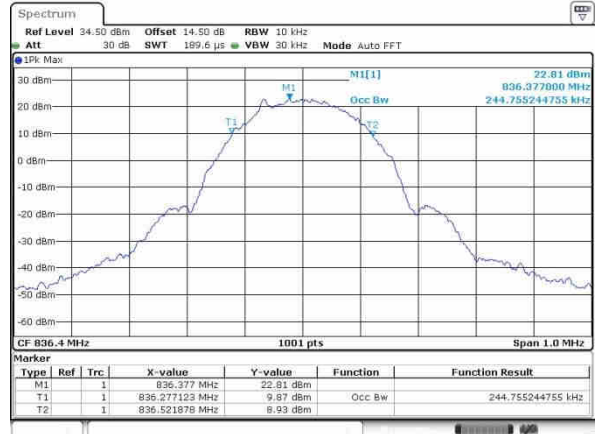

Date: 6 JAN 2017 14:23:04

Highest Channel

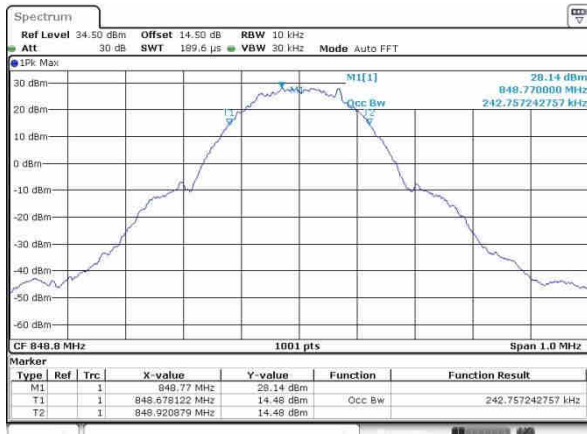

Date: 6 JAN 2017 14:01:28

Highest Channel

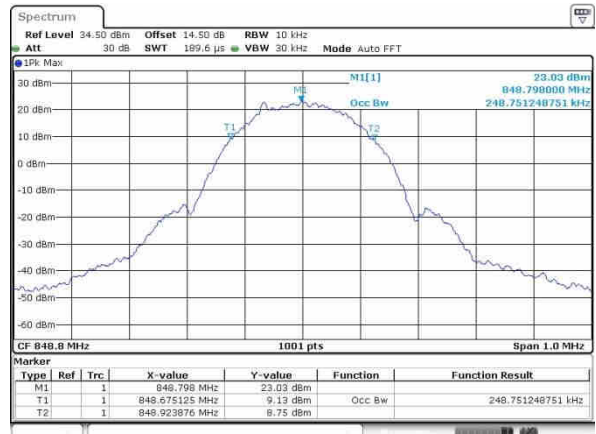

Date: 6 JAN 2017 14:23:40



GSM1900 (GSM)

Lowest Channel

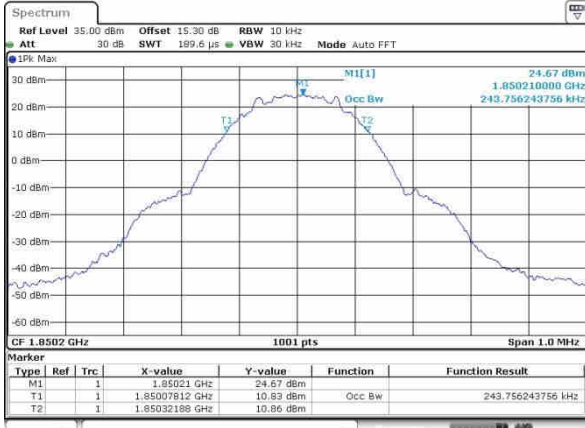

Date: 6 JAN 2017 14:39:31

GSM1900 (EDGE class 8)

Lowest Channel

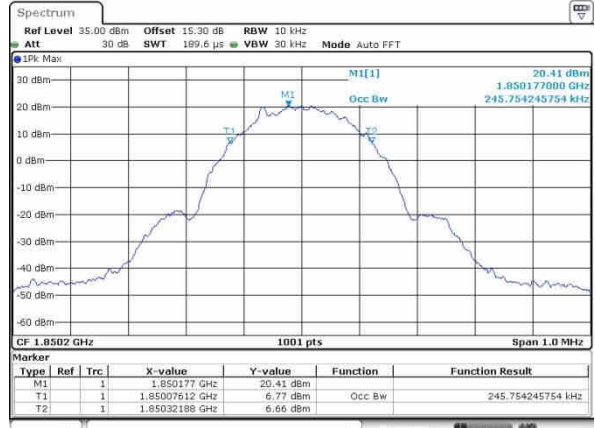

Date: 6 JAN 2017 14:59:33

Middle Channel

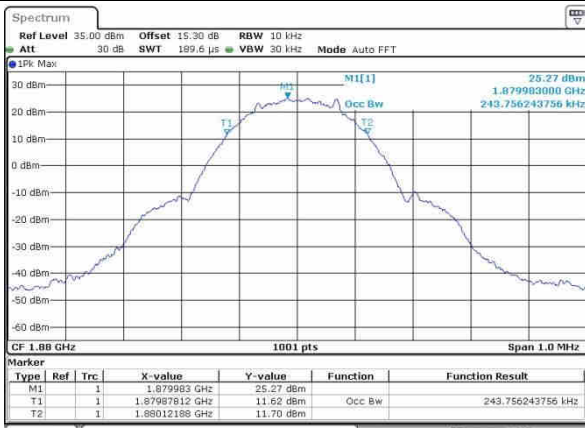

Date: 6 JAN 2017 14:39:58

Middle Channel

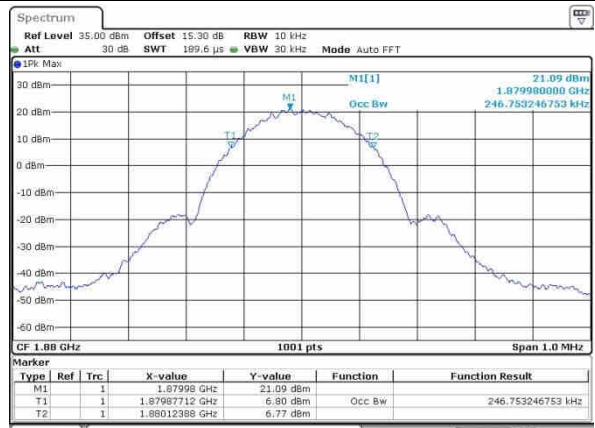

Date: 6 JAN 2017 14:57:06

Highest Channel

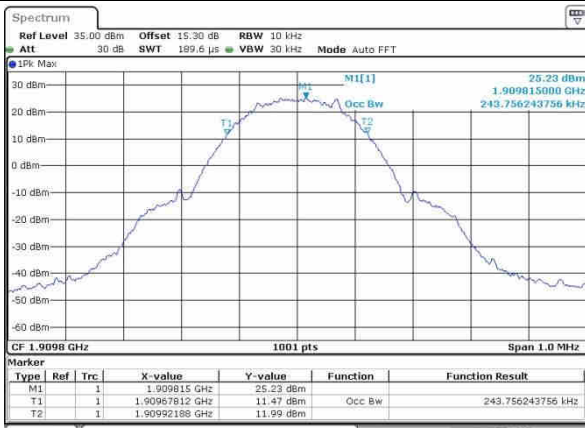

Date: 6 JAN 2017 14:40:28

Highest Channel

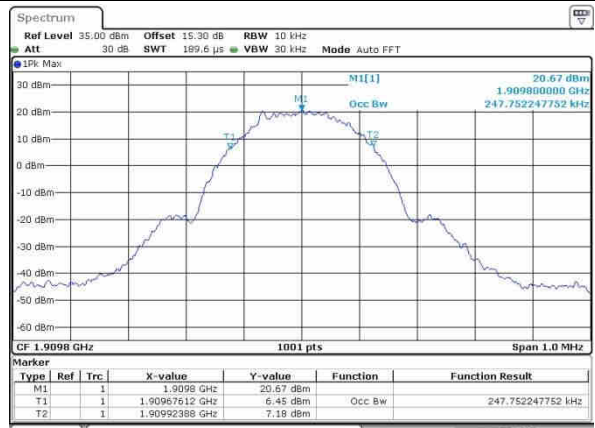

Date: 6 JAN 2017 14:57:48



WCDMA Band V (RMC 12.2Kbps)

Lowest Channel

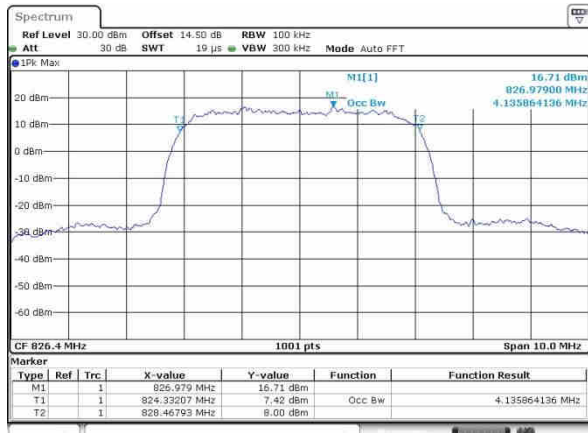

Date: 6 JAN 2017 06:47:18

WCDMA Band II (RMC 12.2Kbps)

Lowest Channel

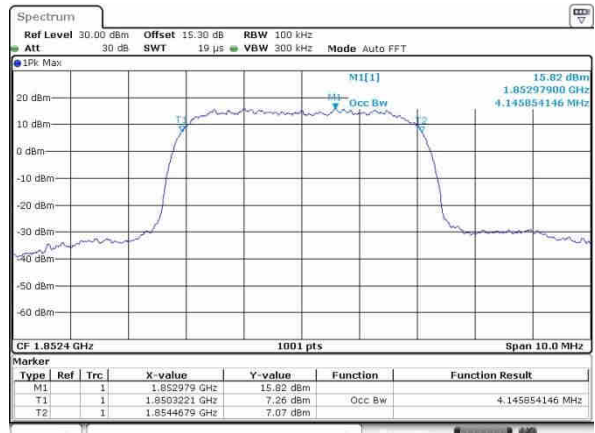

Date: 6 JAN 2017 07:05:06

Middle Channel

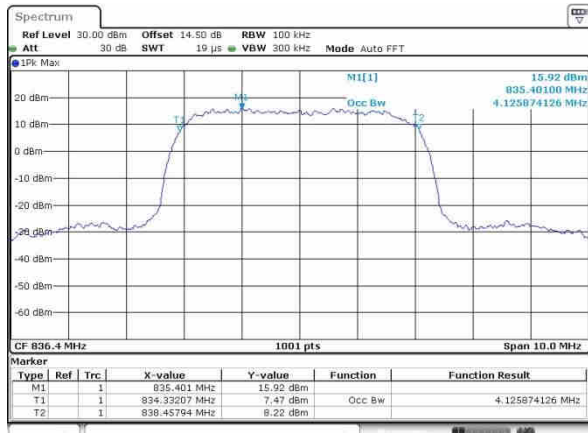

Date: 6 JAN 2017 06:48:04

Middle Channel

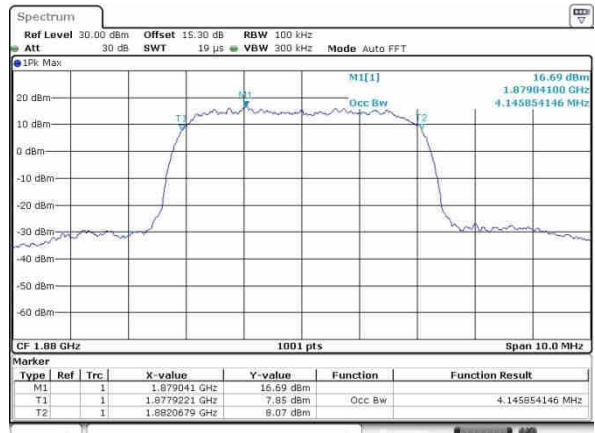

Date: 6 JAN 2017 07:05:53

Highest Channel

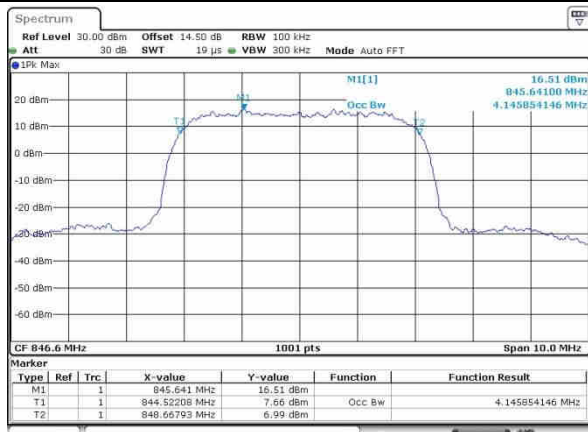

Date: 6 JAN 2017 06:48:46

Highest Channel

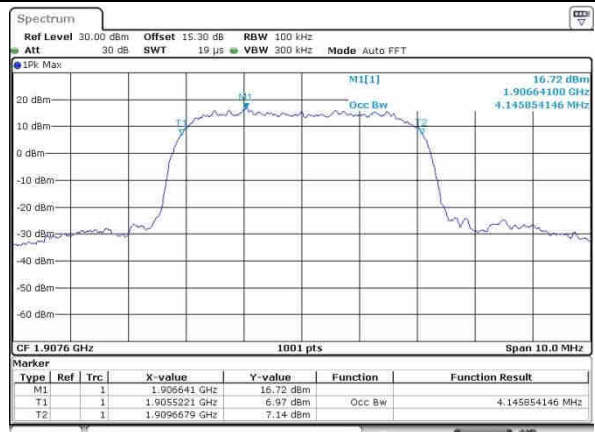

Date: 6 JAN 2017 07:06:30



Conducted Band Edge

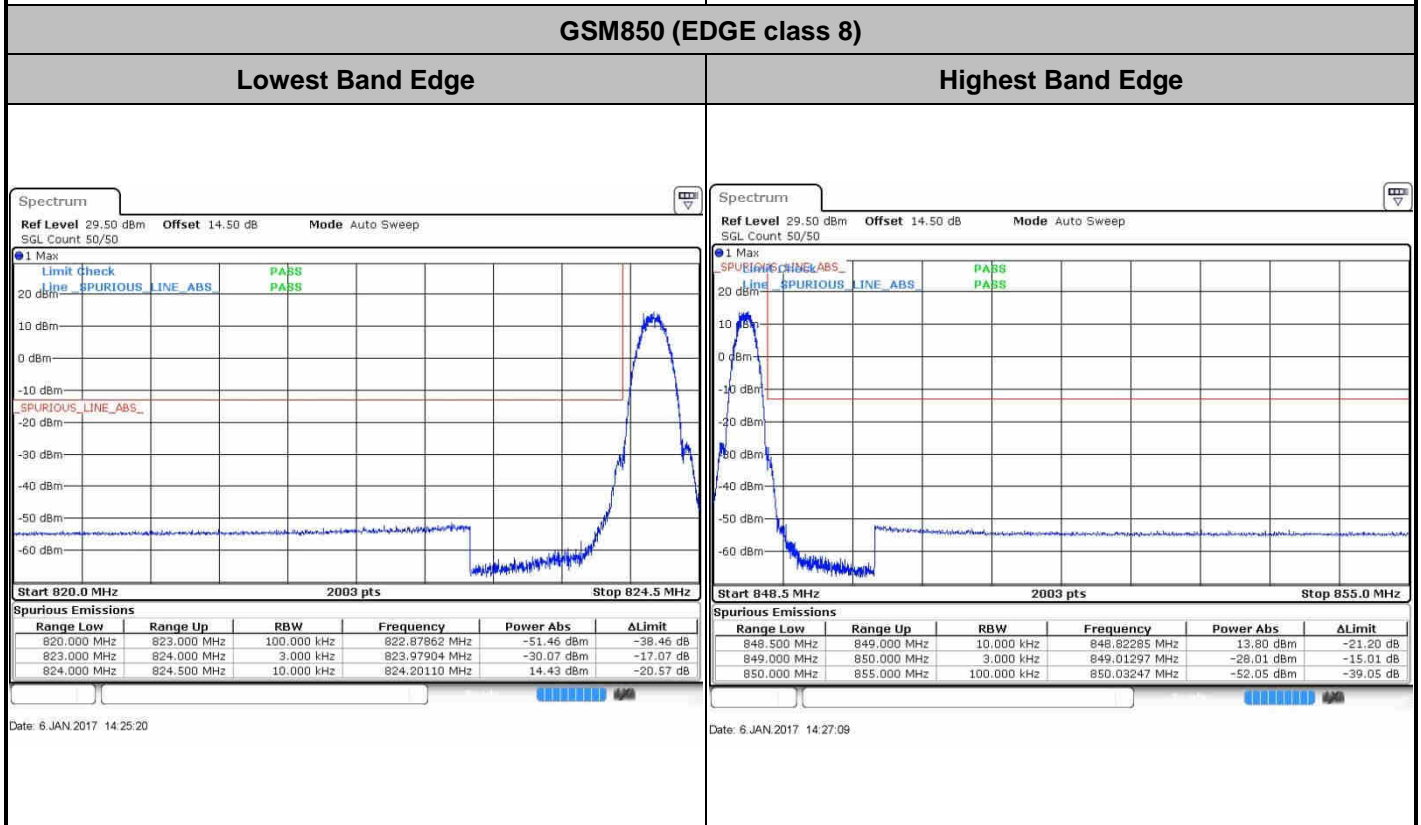
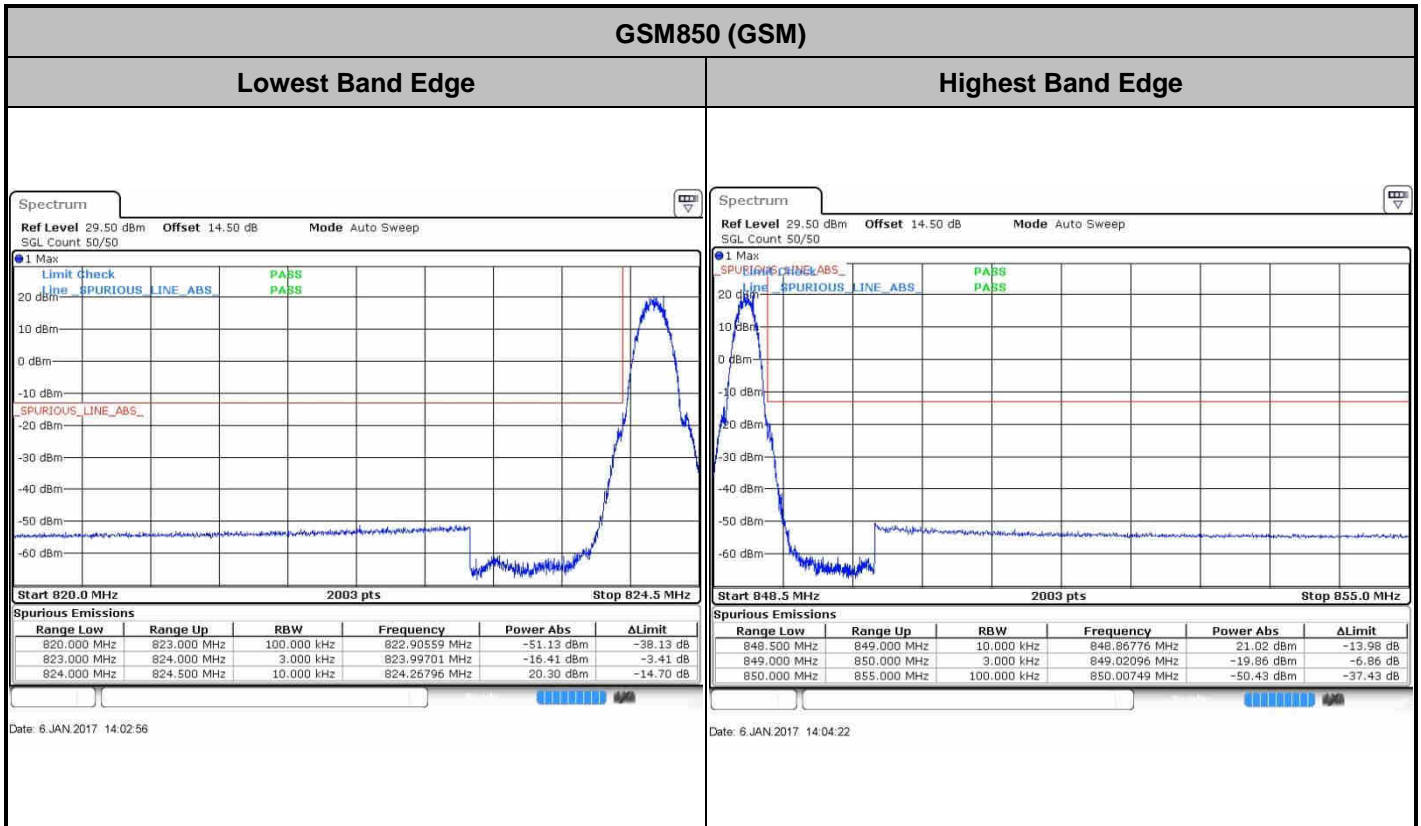



GSM1900 (GSM)

Lowest Band Edge

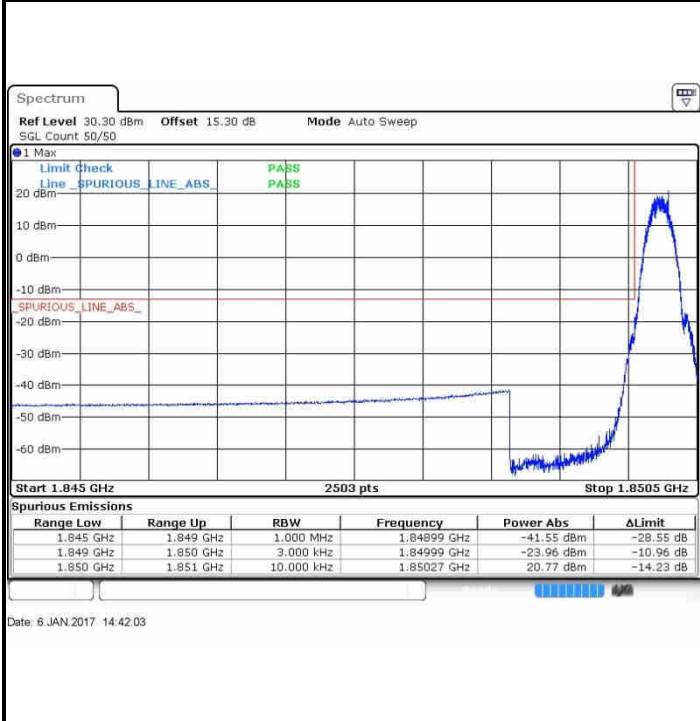

Highest Band Edge

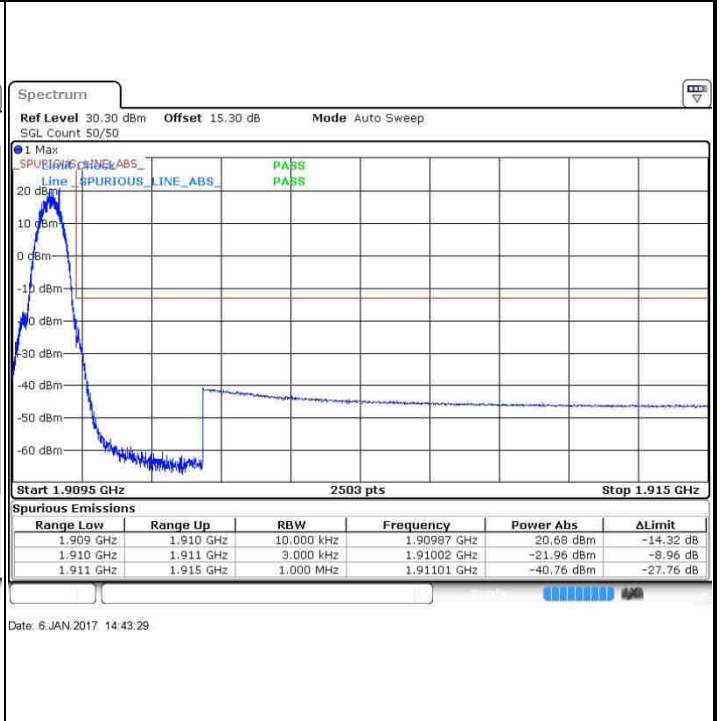

GSM1900 (EDGE class 8)

Lowest Band Edge

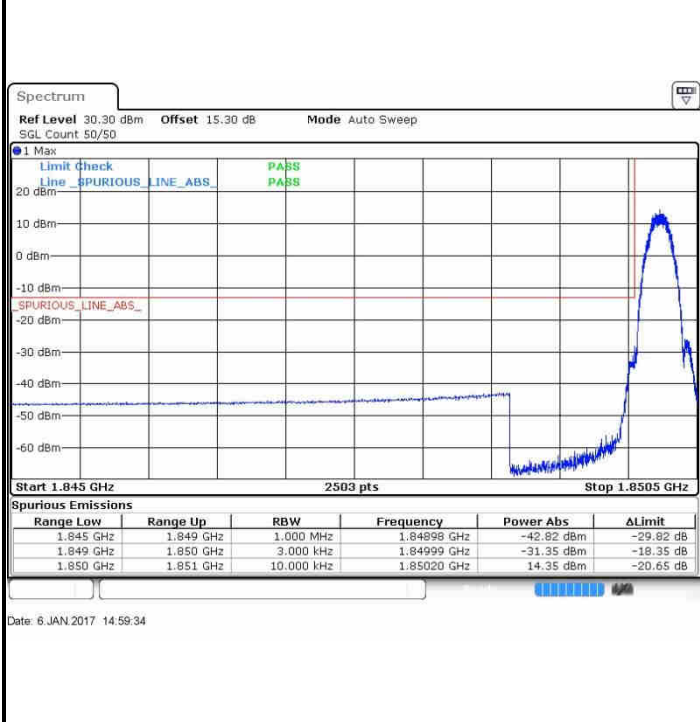

Highest Band Edge

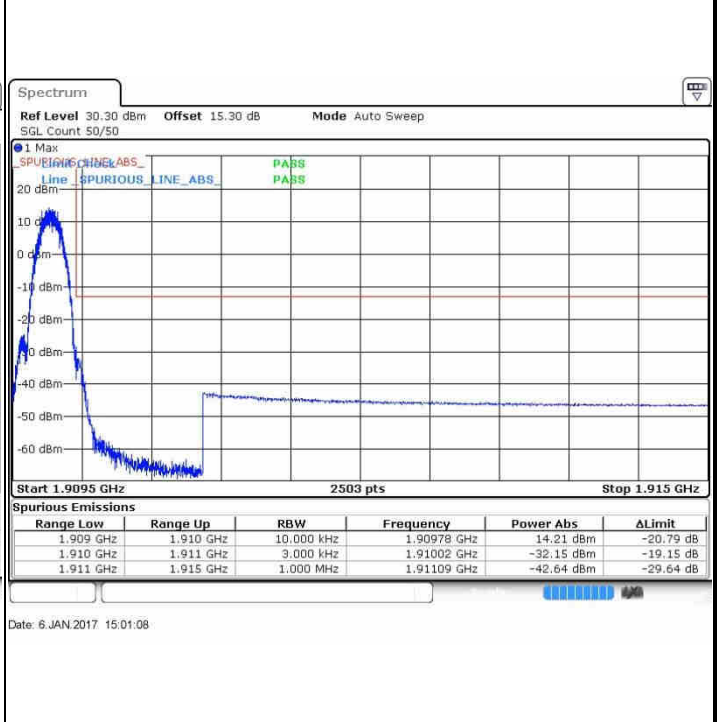



WCDMA Band V (RMC 12.2Kbps)

Lowest Band Edge

Highest Band Edge

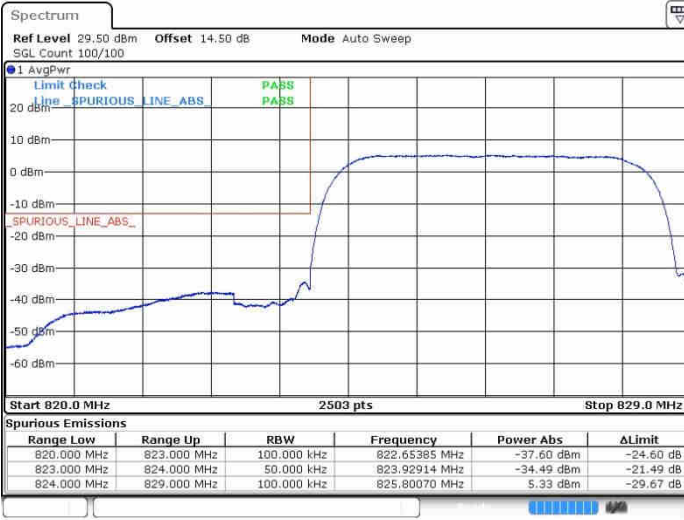

Date: 6 JAN 2017 06:51:44

Date: 6 JAN 2017 06:54:33

WCDMA Band II (RMC 12.2Kbps)

Lowest Band Edge

Highest Band Edge

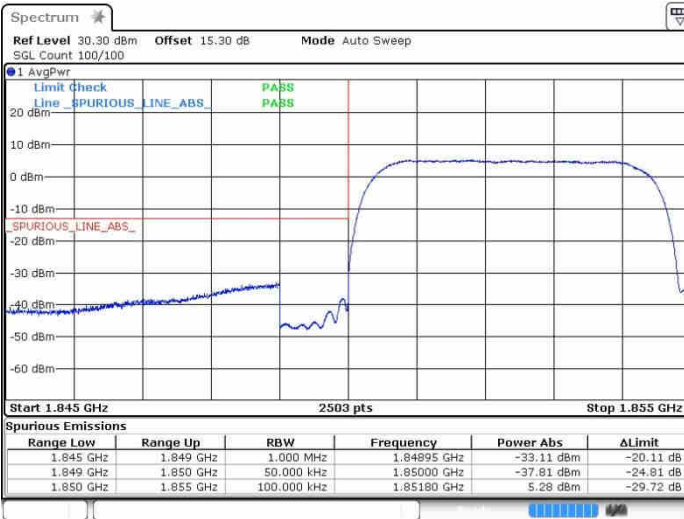

Date: 6 JAN 2017 07:11:50

Date: 6 JAN 2017 07:15:03



Conducted Spurious Emission

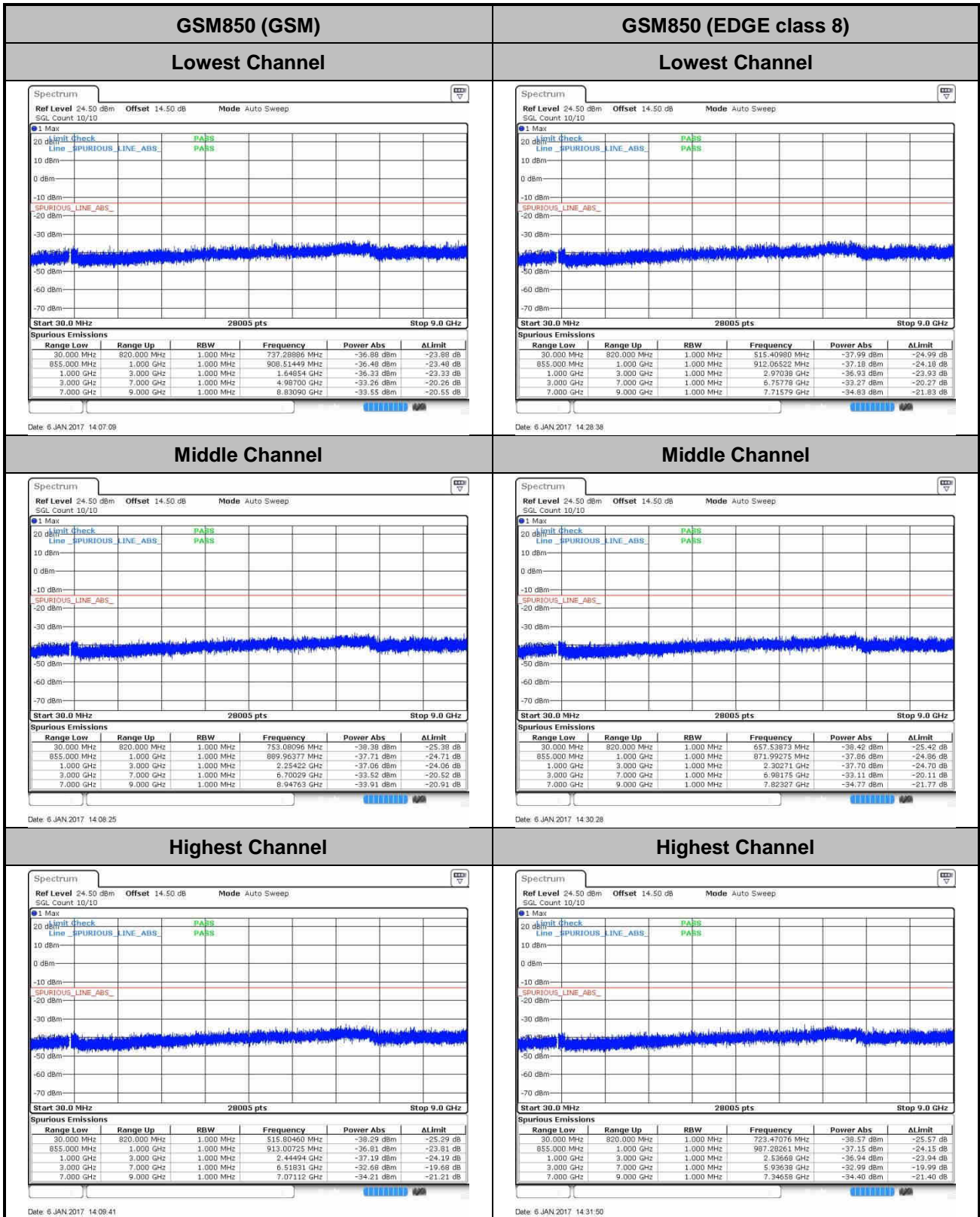



GSM1900 (GSM)

Lowest Channel

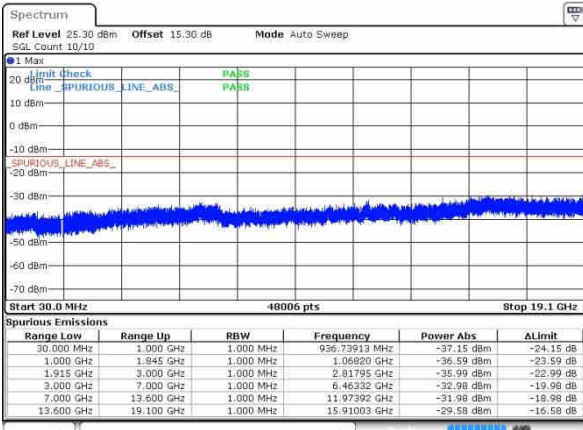

Date: 6 JAN 2017 14:45:39

GSM1900 (EDGE class 8)

Lowest Channel

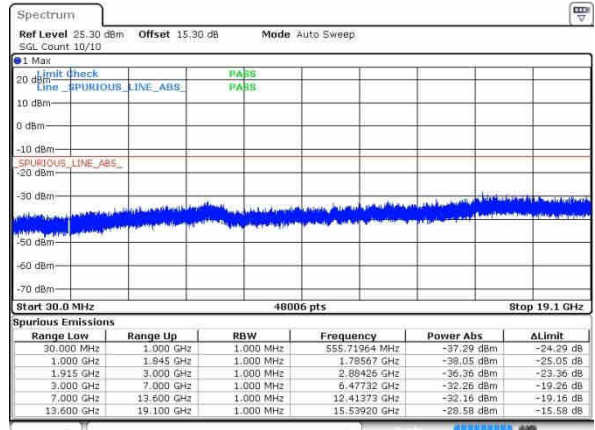

Date: 6 JAN 2017 15:03:31

Middle Channel

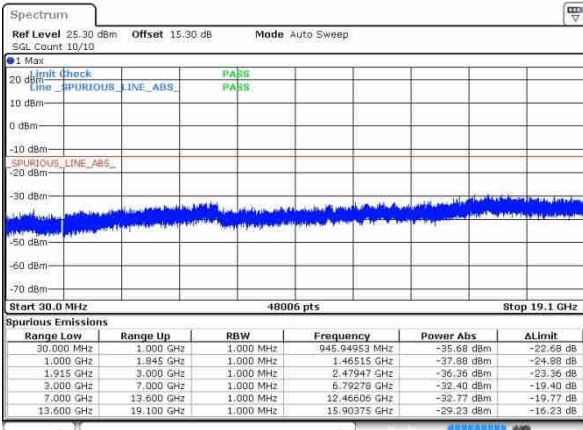

Date: 6 JAN 2017 14:46:55

Middle Channel

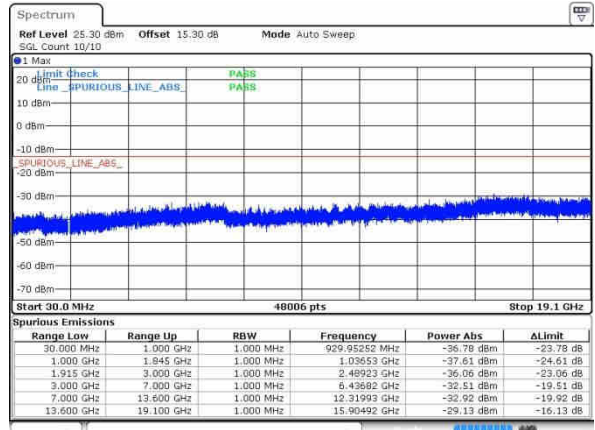

Date: 6 JAN 2017 15:05:02

Highest Channel

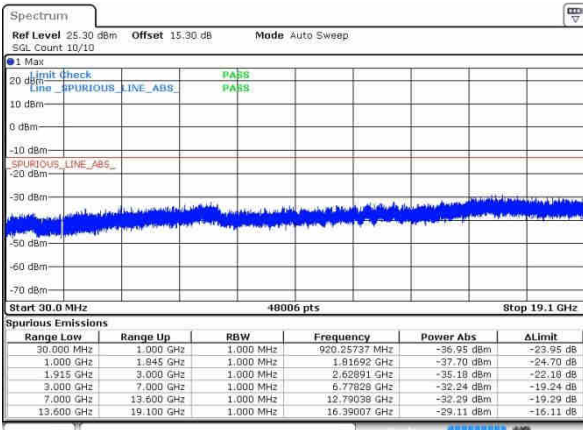

Date: 6 JAN 2017 14:48:11

Highest Channel

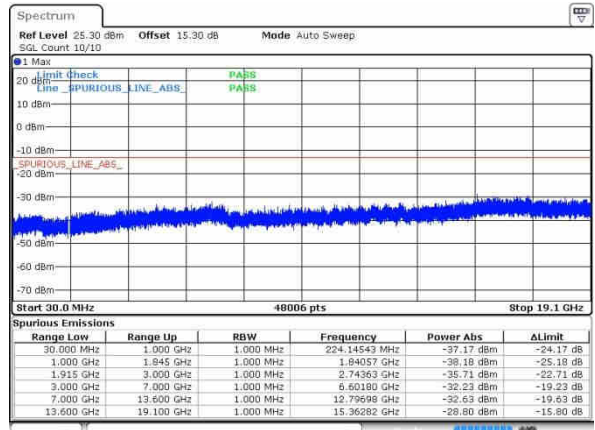

Date: 6 JAN 2017 15:06:26



WCDMA Band V (RMC 12.2Kbps)

Lowest Channel

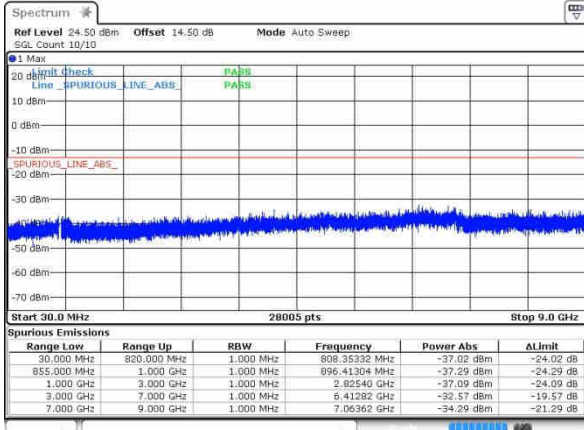

Date: 6 JAN 2017 06:56:03

WCDMA Band II (RMC 12.2Kbps)

Lowest Channel

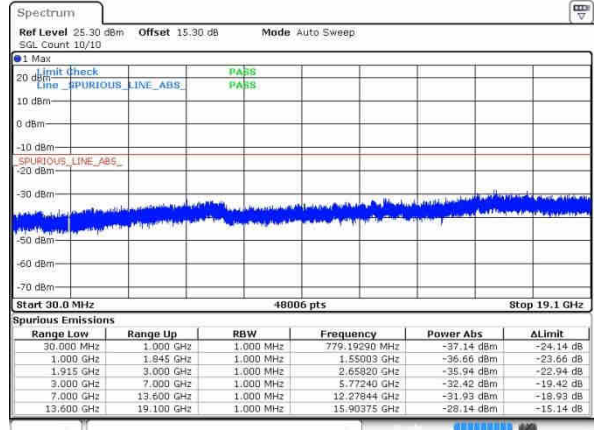

Date: 6 JAN 2017 07:16:30

Middle Channel

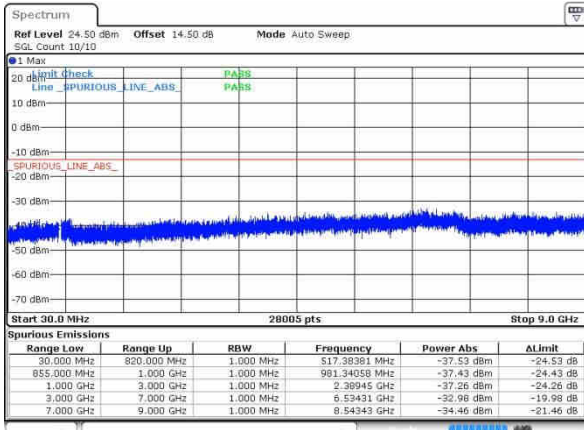

Date: 6 JAN 2017 06:57:25

Middle Channel

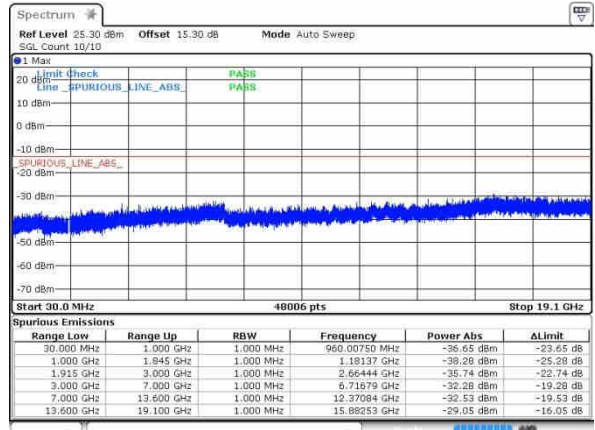

Date: 6 JAN 2017 07:19:14

Highest Channel

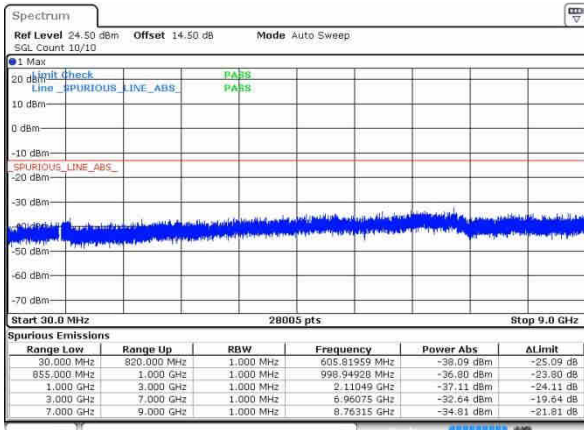

Date: 6 JAN 2017 06:58:00

Highest Channel

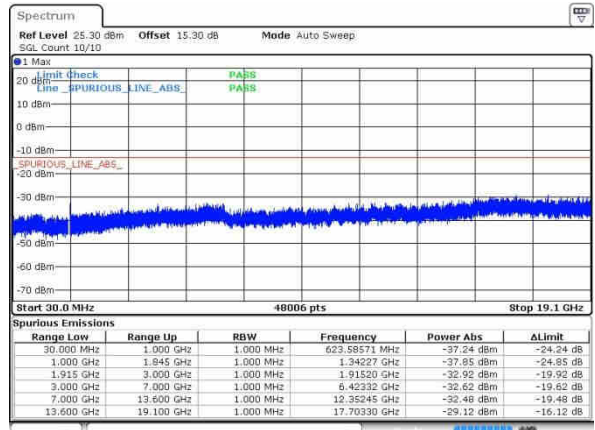

Date: 6 JAN 2017 07:21:15



Frequency Stability

| Test Conditions | Middle Channel | GSM850 (GSM) | GSM850 (EDGE class 8) | Limit 2.5ppm |
|------------------|-------------------|-----------------|-----------------------|--------------|
| Temperature (°C) | Voltage (Volt) | Deviation (ppm) | | Result |
| 50 | Normal Voltage | 0.0287 | 0.0407 | PASS |
| 40 | Normal Voltage | 0.0275 | 0.0347 | |
| 30 | Normal Voltage | 0.0311 | 0.0060 | |
| 20(Ref.) | Normal Voltage | 0.0000 | 0.0000 | |
| 10 | Normal Voltage | 0.0024 | 0.0024 | |
| 0 | Normal Voltage | 0.0335 | 0.0024 | |
| -10 | Normal Voltage | 0.0012 | 0.0371 | |
| -20 | Normal Voltage | 0.0048 | 0.0347 | |
| -30 | Normal Voltage | 0.0275 | 0.0323 | |
| 20 | Maximum Voltage | 0.0347 | 0.0024 | |
| 20 | Normal Voltage | 0.0072 | 0.0108 | |
| 20 | Battery End Point | 0.0084 | 0.0000 | |

Note: Normal Voltage = 3.8V. ; Battery End Point (BEP) = 3.6 V. ; Maximum Voltage =4.2 V

| Test Conditions | Middle Channel | GSM1900 (GSM) | GSM1900 (EDGE class 8) | Limit Note 2. |
|------------------|-------------------|-----------------|------------------------|---------------|
| Temperature (°C) | Voltage (Volt) | Deviation (ppm) | | Result |
| 50 | Normal Voltage | 0.0059 | 0.0160 | PASS |
| 40 | Normal Voltage | 0.0069 | 0.0287 | |
| 30 | Normal Voltage | 0.0101 | 0.0011 | |
| 20(Ref.) | Normal Voltage | 0.0000 | 0.0000 | |
| 10 | Normal Voltage | 0.0106 | 0.0037 | |
| 0 | Normal Voltage | 0.0122 | 0.0128 | |
| -10 | Normal Voltage | 0.0021 | 0.0027 | |
| -20 | Normal Voltage | 0.0027 | 0.0021 | |
| -30 | Normal Voltage | 0.0074 | 0.0255 | |
| 20 | Maximum Voltage | 0.0069 | 0.0282 | |
| 20 | Normal Voltage | 0.0011 | 0.0261 | |
| 20 | Battery End Point | 0.0133 | 0.0085 | |

Note:

1. Normal Voltage = 3.8V. ; Battery End Point (BEP) = 3.6 V. ; Maximum Voltage =4.2 V
2. The frequency fundamental emissions stay within the authorized frequency block based on the frequency deviation measured is small.



| Test Conditions | Middle Channel | WCDMA Band V (RMC 12.2Kbps) | Limit 2.5ppm |
|------------------|-------------------|--------------------------------|-----------------|
| Temperature (°C) | Voltage (Volt) | Deviation (ppm) | Result |
| 50 | Normal Voltage | 0.0287 | PASS |
| 40 | Normal Voltage | 0.0275 | |
| 30 | Normal Voltage | 0.0048 | |
| 20(Ref.) | Normal Voltage | 0.0000 | |
| 10 | Normal Voltage | 0.0132 | |
| 0 | Normal Voltage | 0.0036 | |
| -10 | Normal Voltage | 0.0239 | |
| -20 | Normal Voltage | 0.0359 | |
| -30 | Normal Voltage | 0.0048 | |
| 20 | Maximum Voltage | 0.0323 | |
| 20 | Normal Voltage | 0.0084 | |
| 20 | Battery End Point | 0.0036 | |

Note: Normal Voltage = 3.8V. ; Battery End Point (BEP) = 3.6 V. ; Maximum Voltage =4.2 V

| Test Conditions | Middle Channel | WCDMA Band II (RMC 12.2Kbps) | Limit Note 2. |
|------------------|-------------------|---------------------------------|------------------|
| Temperature (°C) | Voltage (Volt) | Deviation (ppm) | Result |
| 50 | Normal Voltage | 0.0059 | PASS |
| 40 | Normal Voltage | 0.0037 | |
| 30 | Normal Voltage | 0.0021 | |
| 20(Ref.) | Normal Voltage | 0.0000 | |
| 10 | Normal Voltage | 0.0048 | |
| 0 | Normal Voltage | 0.0064 | |
| -10 | Normal Voltage | 0.0202 | |
| -20 | Normal Voltage | 0.0234 | |
| -30 | Normal Voltage | 0.0053 | |
| 20 | Maximum Voltage | 0.0229 | |
| 20 | Normal Voltage | 0.0027 | |
| 20 | Battery End Point | 0.0016 | |

Note:

1. Normal Voltage = 3.8V. ; Battery End Point (BEP) = 3.6 V. ; Maximum Voltage =4.2 V
2. The frequency fundamental emissions stay within the authorized frequency block based on the frequency deviation measured is small.



Appendix B. Test Results of Radiated Test

Radiated Spurious Emission

| GSM850 (GSM) | | | | | | | | | |
|--------------|-------------------|-------------|---------------|-------------------|-------------------|--------------------|----------------------|-----------------------|--------------------|
| Channel | Frequency (MHz) | ERP (dBm) | Limit (dBm) | Over Limit (dB) | SPA Reading (dBm) | S.G. Power (dBm) | TX Cable loss (dB) | TX Antenna Gain (dBi) | Polarization (H/V) |
| Middle | 1672 | -58.85 | -13 | -45.85 | -57.48 | -60.71 | 1.19 | 5.20 | H |
| | 2508 | -45.80 | -13 | -32.80 | -51.03 | -48.02 | 1.53 | 5.90 | H |
| | 3345 | -62.37 | -13 | -49.37 | -66.32 | -65.16 | 1.76 | 6.70 | H |
| | 4182 | -65.59 | -13 | -52.59 | -70.22 | -68.74 | 1.90 | 7.20 | H |
| | 1672 | -58.26 | -13 | -45.26 | -56.22 | -60.12 | 1.19 | 5.20 | V |
| | 2508 | -49.88 | -13 | -36.88 | -53.34 | -52.10 | 1.53 | 5.90 | V |
| | 3345 | -65.23 | -13 | -52.23 | -68.55 | -68.02 | 1.76 | 6.70 | V |
| | 4182 | -62.57 | -13 | -49.57 | -68.68 | -65.72 | 1.90 | 7.20 | V |

Remark: Spurious emissions within 30-1000MHz were found more than 20dB below limit line.

| GSM850 (EDGE class 8) | | | | | | | | | |
|-----------------------|-------------------|-------------|---------------|-------------------|-------------------|--------------------|----------------------|-----------------------|--------------------|
| Channel | Frequency (MHz) | ERP (dBm) | Limit (dBm) | Over Limit (dB) | SPA Reading (dBm) | S.G. Power (dBm) | TX Cable loss (dB) | TX Antenna Gain (dBi) | Polarization (H/V) |
| Middle | 1672 | -60.35 | -13 | -47.35 | -58.98 | -62.21 | 1.19 | 5.20 | H |
| | 2508 | -55.83 | -13 | -42.83 | -58.82 | -58.05 | 1.53 | 5.90 | H |
| | 3345 | -67.63 | -13 | -54.63 | -71.58 | -70.42 | 1.76 | 6.70 | H |
| | 1672 | -62.84 | -13 | -49.84 | -60.8 | -64.70 | 1.19 | 5.20 | V |
| | 2508 | -59.42 | -13 | -46.42 | -61.4 | -61.64 | 1.53 | 5.90 | V |
| | 3345 | -67.55 | -13 | -54.55 | -70.87 | -70.34 | 1.76 | 6.70 | V |

Remark: Spurious emissions within 30-1000MHz were found more than 20dB below limit line.

| GSM1900 (GSM) | | | | | | | | | |
|---------------|-------------------|--------------|---------------|-------------------|-------------------|--------------------|----------------------|-----------------------|--------------------|
| Channel | Frequency (MHz) | EIRP (dBm) | Limit (dBm) | Over Limit (dB) | SPA Reading (dBm) | S.G. Power (dBm) | TX Cable loss (dB) | TX Antenna Gain (dBi) | Polarization (H/V) |
| Middle | 3762 | -65.72 | -13 | -52.72 | -69.23 | -70.71 | 1.88 | 6.87 | H |
| | 5640 | -42.76 | -13 | -29.76 | -55.31 | -50.06 | 2.38 | 9.68 | H |
| | 7518 | -63.82 | -13 | -50.82 | -75.85 | -72.89 | 2.74 | 11.81 | H |
| | 3762 | -64.11 | -13 | -51.11 | -67.9 | -69.10 | 1.88 | 6.87 | V |
| | 5640 | -36.83 | -13 | -23.83 | -52.37 | -44.13 | 2.38 | 9.68 | V |
| | 7518 | -65.02 | -13 | -52.02 | -75.73 | -74.09 | 2.74 | 11.81 | V |

Remark: Spurious emissions within 30-1000MHz were found more than 20dB below limit line.



| GSM1900 (EDGE class 8) | | | | | | | | | |
|------------------------|-------------------|--------------|---------------|-------------------|-------------------|--------------------|----------------------|-----------------------|--------------------|
| Channel | Frequency (MHz) | EIRP (dBm) | Limit (dBm) | Over Limit (dB) | SPA Reading (dBm) | S.G. Power (dBm) | TX Cable loss (dB) | TX Antenna Gain (dBi) | Polarization (H/V) |
| Middle | 3760 | -70.22 | -13 | -57.22 | -73.73 | -75.21 | 1.88 | 6.87 | H |
| | 5640 | -56.95 | -13 | -43.95 | -65.14 | -64.25 | 2.38 | 9.68 | H |
| | 7520 | -63.81 | -13 | -50.81 | -75.84 | -72.88 | 2.74 | 11.81 | H |
| | 3760 | -69.52 | -13 | -56.52 | -73.31 | -74.51 | 1.88 | 6.87 | V |
| | 5640 | -50.61 | -13 | -37.61 | -60.08 | -57.91 | 2.38 | 9.68 | V |
| | 7520 | -65.14 | -13 | -52.14 | -75.85 | -74.21 | 2.74 | 11.81 | V |

Remark: Spurious emissions within 30-1000MHz were found more than 20dB below limit line.

| WCDMA Band V(RMC 12.2Kbps) | | | | | | | | | |
|----------------------------|-------------------|-------------|---------------|-------------------|-------------------|--------------------|----------------------|-----------------------|--------------------|
| Channel | Frequency (MHz) | ERP (dBm) | Limit (dBm) | Over Limit (dB) | SPA Reading (dBm) | S.G. Power (dBm) | TX Cable loss (dB) | TX Antenna Gain (dBi) | Polarization (H/V) |
| Middle | 1672 | -56.17 | -13 | -43.17 | -54.96 | -58.03 | 1.19 | 5.20 | H |
| | 2510 | -58.38 | -13 | -45.38 | -61.37 | -60.60 | 1.53 | 5.90 | H |
| | 3345 | -67.34 | -13 | -54.34 | -71.29 | -70.13 | 1.76 | 6.70 | H |
| | 1672 | -61.41 | -13 | -48.41 | -59.37 | -63.27 | 1.19 | 5.20 | V |
| | 2510 | -66.02 | -13 | -53.02 | -68 | -68.24 | 1.53 | 5.90 | V |
| | 3345 | -66.64 | -13 | -53.64 | -69.96 | -69.43 | 1.76 | 6.70 | V |

Remark: Spurious emissions within 30-1000MHz were found more than 20dB below limit line.

| WCDMA Band II(RMC 12.2Kbps) | | | | | | | | | |
|-----------------------------|-------------------|--------------|---------------|-------------------|-------------------|--------------------|----------------------|-----------------------|--------------------|
| Channel | Frequency (MHz) | EIRP (dBm) | Limit (dBm) | Over Limit (dB) | SPA Reading (dBm) | S.G. Power (dBm) | TX Cable loss (dB) | TX Antenna Gain (dBi) | Polarization (H/V) |
| Middle | 3760 | -65.27 | -13 | -52.27 | -68.78 | -70.26 | 1.88 | 6.87 | H |
| | 5640 | -54.55 | -13 | -41.55 | -62.74 | -61.85 | 2.38 | 9.68 | H |
| | 7520 | -63.15 | -13 | -50.15 | -75.18 | -72.22 | 2.74 | 11.81 | H |
| | 3760 | -66.38 | -13 | -53.38 | -70.17 | -71.37 | 1.88 | 6.87 | V |
| | 5640 | -54.02 | -13 | -41.02 | -62.59 | -61.32 | 2.38 | 9.68 | V |
| | 7520 | -64.42 | -13 | -51.42 | -75.13 | -73.49 | 2.74 | 11.81 | V |

Remark: Spurious emissions within 30-1000MHz were found more than 20dB below limit line.