



FCC Test Report

APPLICANT : Motorola Mobility LLC
EQUIPMENT : Mobile Cellular Phone
BRAND NAME : Motorola
MODEL NAME : 10509
FCC ID : IHDT56WC7
STANDARD : FCC 47 CFR FCC Part 15 Subpart B
CLASSIFICATION : Certification

The product was received on Jan. 19, 2017 and testing was completed on Mar. 20, 2017. We, Sporton International (KunShan) INC., would like to declare that the tested sample has been evaluated in accordance with the test procedures given in ANSI C63.4-2014 and has been in compliance with the applicable technical standards.

The test results in this report apply exclusively to the tested model / sample. Without written approval of Sporton International (KunShan) INC., the test report shall not be reproduced except in full.

Prepared by: James Huang / Manager



Approved by: Jones Tsai / Manager

Sporton International (KunShan) INC.
No.3-2, Pingxiang Road, Kunshan Development Zone, Jiangsu, China



TABLE OF CONTENTS

REVISION HISTORY.....3

SUMMARY OF TEST RESULT4

1. GENERAL DESCRIPTION5

 1.1. Applicant.....5

 1.2. Manufacturer5

 1.3. Product Feature of Equipment Under Test5

 1.4. Product Specification of Equipment Under Test6

 1.5. Specification of Accessory7

 1.6. Modification of EUT7

 1.7. Test Location8

 1.8. Applicable Standards8

2. TEST CONFIGURATION OF EQUIPMENT UNDER TEST.....9

 2.1. Test Mode9

 2.2. Connection Diagram of Test System 10

 2.3. Support Unit used in test configuration and system.....11

 2.4. EUT Operation Test Setup11

3. TEST RESULT.....12

 3.1. Test of AC Conducted Emission Measurement12

 3.2. Test of Radiated Emission Measurement16

4. LIST OF MEASURING EQUIPMENT20

5. UNCERTAINTY OF EVALUATION21

APPENDIX A. SETUP PHOTOGRAPHS



REVISION HISTORY

REPORT NO.	VERSION	DESCRIPTION	ISSUED DATE
FC711913-02	Rev. 01	Initial issue of report	Apr. 01, 2017



SUMMARY OF TEST RESULT

Report Section	FCC Rule	Description	Limit	Result	Remark
3.1	15.107	AC Conducted Emission	< 15.107 limits	PASS	Under limit 11.91 dB at 0.447 MHz
3.2	15.109	Radiated Emission	< 15.109 limits	PASS	Under limit 7.55 dB at 598.420 MHz



1. General Description

1.1. Applicant

Motorola Mobility LLC
222 W, Merchandise Mart Plaza, Chicago IL 60654 USA

1.2. Manufacturer

Motorola Mobility LLC
222 W, Merchandise Mart Plaza, Chicago IL 60654 USA

1.3. Product Feature of Equipment Under Test

Product Feature	
Equipment	Mobile Cellular Phone
Brand Name	Motorola
Model Name	10509
FCC ID	IHDT56WC7
EUT supports Radios application	GSM/GPRS/EGPRS/WCDMA/HSPA/DC-HSDPA/HSPA+/LTE/ WLAN 2.4GHz 802.11b/g/n HT20/ Bluetooth v3.0 + EDR/ Bluetooth v 4.0 LE/ Bluetooth v4.1 LE/ Bluetooth v4.2 LE
IMEI Code	Conduction: 355637080017718/355637080017726 Radiation: 355637080018377/355637080018385
HW Version	WKGMA1A4-3
SW Version	woods- userdebug 7.0 NMA25.27 314 intcfg,test-keys
EUT Stage	Identical Prototype

Remark: The above EUT's information was declared by manufacturer. Please refer to the specifications or user's manual for more detailed description.



1.4. Product Specification of Equipment Under Test

Standards-related Product Specification	
Tx Frequency	GSM850: 824.2 MHz ~ 848.8 MHz GSM1900: 1850.2 MHz ~ 1909.8MHz WCDMA Band V: 826.4 MHz ~ 846.6 MHz WCDMA Band II: 1852.4 MHz ~ 1907.6 MHz LTE Band 5 : 824.7 MHz ~ 848.3 MHz LTE Band 7 : 2502.5 MHz ~ 2567.5 MHz 802.11b/g/n: 2412 MHz ~ 2462 MHz Bluetooth: 2402 MHz ~ 2480 MHz
Rx Frequency	GSM850: 869.2 MHz ~ 893.8 MHz GSM1900: 1930.2 MHz ~ 1989.8 MHz WCDMA Band V: 871.4 MHz ~ 891.6 MHz WCDMA Band II: 1932.4 MHz ~ 1987.6 MHz LTE Band 5 : 869.7 MHz ~ 893.3 MHz LTE Band 7: 2622.5 MHz ~ 2687.5 MHz 802.11b/g/n: 2412 MHz ~ 2462 MHz Bluetooth: 2402 MHz ~ 2480 MHz GPS : 1.57542 GHz FM : 88 MHz ~ 108 MHz
Antenna Type	WWAN: PIFA Antenna WLAN: PIFA Antenna Bluetooth: PIFA Antenna GPS: PIFA Antenna FM: External headset Antenna
Type of Modulation	GSM: GMSK GPRS: GMSK EDGE(MCS 0-4): GMSK / (MCS 5-9): 8PSK WCDMA : BPSK (Uplink) HSDPA/DC-HSDPA : QPSK (Uplink) HSUPA : QPSK (Uplink) HSPA+ : 16QAM DC-HSDPA : 64QAM LTE: QPSK / 16QAM / 64QAM(Downlink only) 802.11b : DSSS (DBPSK / DQPSK / CCK) 802.11g/n : OFDM (BPSK / QPSK / 16QAM / 64QAM) Bluetooth LE : GFSK Bluetooth (1Mbps) : GFSK Bluetooth (2Mbps) : $\pi/4$ -DQPSK Bluetooth (3Mbps) : 8-DPSK GPS : BPSK FM

1.5. Specification of Accessory

Specification of Accessory			
AC Adapter IN	Brand Name	Motorola (AcBel)	Model Name C-P45 SPN5952A
	Power Rating	I/P: 100-240 Vac, 130mA, O/P: 5 Vdc, 1000mA	
AC Adapter US	Brand Name	Motorola (AcBel)	Model Name C-P56 SPN5947A
	Power Rating	I/P: 100-240 Vac, 130mA, O/P: 5 Vdc, 1000mA	
AC Adapter EU	Brand Name	Motorola (AcBel)	Model Name C-P57 SPN5948A
	Power Rating	I/P: 100-240 Vac, 130mA, O/P: 5 Vdc, 1000mA	
AC Adapter UK	Brand Name	Motorola (AcBel)	Model Name C-P58 SPN5950A
	Power Rating	I/P: 100-240 Vac, 130mA, O/P: 5 Vdc, 1000mA	
AC Adapter AU	Brand Name	Motorola (AcBel)	Model Name C-P59 SPN5957A
	Power Rating	I/P: 100-240 Vac, 130mA, O/P: 5 Vdc, 1000mA	
Battery 1	Brand Name	Motorola (ATL)	Model Name GK40
	Power Rating	3.8Vdc,2685/2800mAh (Min/Typ)	Type Li-ion
Battery 2	Brand Name	Motorola (Sunwoda)	Model Name GK40
	Power Rating	3.8Vdc,2685/2800mAh (Min/Typ)	Type Li-ion
Earphone	Brand Name	Motorola(hetong)	Model Name PY-13A1602-01KC39
	Signal Line Type	1.4 meter, non-shielded cable, without ferrite core	
USB Cable	Brand Name	Motorola (Sai Bao)	Model Name SYD-A015A
	Signal Line Type	1.0 meter, shielded cable, without ferrite core	

1.6. Modification of EUT

No modifications are made to the EUT during all test items.



1.7. Test Location

Test Site	Sporton International (KunShan) INC.		
Test Site Location	No.3-2, Pingxiang Road, Kunshan Development Zone, Jiangsu, China TEL: +86-0512-5790-0158 FAX: +86-0512-5790-0958		
Test Site No.	Sporton Site No.		FCC Registration No.
	CO01-KS	03CH02-KS	418269

Note: The test site complies with ANSI C63.4 2014 requirement.

1.8. Applicable Standards

According to the specifications of the manufacturer, the EUT must comply with the requirements of the following standards:

- ♦ FCC 47 CFR FCC Part 15 Subpart B
- ♦ ANSI C63.4-2014

Remark:

1. All test items were verified and recorded according to the standards and without any deviation during the test.
2. For FCC 15 Subpart B - Unintentional Radiators, device supporting USB interface or similar peripherals (defined as the Section 15.3 (r) Peripheral device) acting as a peripheral for personal computers shall be authorized as “The Class B personal computers and peripherals” per the Section 15.101 (a) Equipment authorization of unintentional radiators.
3. For other Unintentional Radiators features of this EUT, test reports are be issued separately.
Per the Note of the Section 15.101, when device supports features (USB, FM Radio, digital devices...etc) more than one category of authorization, type of authorization shall be appropriately chosen for FCC 15B compliance rule, and the Section 15.101 (b), only those receivers that operate (tune) within the frequency range of 30-960 MHz, CB receivers and radar detectors are subject to the authorizations shown in paragraph (a) of the Section 15.101. However, receivers indicated as being subject to Declaration of Conformity that are contained within a transceiver, the transmitter portion of which is subject to certification, shall be authorized under the verification procedure.



2. Test Configuration of Equipment Under Test

2.1. Test Mode

The EUT has been associated with peripherals pursuant to ANSI C63.4-2014 and configuration operated in a manner tended to maximize its emission characteristics in a typical application.

Frequency range investigated: conduction (150 kHz to 30 MHz), radiation (30MHz to the 5th harmonic of the highest fundamental frequency or to 40 GHz, whichever is lower).

Test Items	Function Type
AC Conducted Emission	Mode 1: LTE Band 5 Idle + Bluetooth Idle + WLAN Idle + Earphone + USB Cable(Data Link with Notebook) + Battery 1 + GPS Rx + SIM 1 Mode 2: LTE Band 5 Idle + Bluetooth Idle + WLAN Idle + Earphone + USB Cable(Data Link with Notebook) + Battery 2 + GPS Rx + SIM1
Radiated Emissions < 1GHz	Mode 1: LTE Band 5 Idle + Bluetooth Idle + WLAN Idle + Earphone + USB Cable(Data Link with Notebook) + Battery 1 + GPS Rx Mode 2: LTE Band 5 Idle + Bluetooth Idle + WLAN Idle + Earphone + USB Cable(Data Link with Notebook) + Battery 2 + GPS Rx
Radiated Emissions ≥ 1GHz	Mode 1: LTE Band 5 Idle + Bluetooth Idle + WLAN Idle + Earphone + USB Cable(Data Link with Notebook) + Battery 1 + GPS Rx
Remark:	
<ol style="list-style-type: none"> The worst case of AC is mode 2; only the test data of this mode was reported. The worst case of RE < 1G is mode 1; only the test data of this mode was reported. 	

2.2. Connection Diagram of Test System

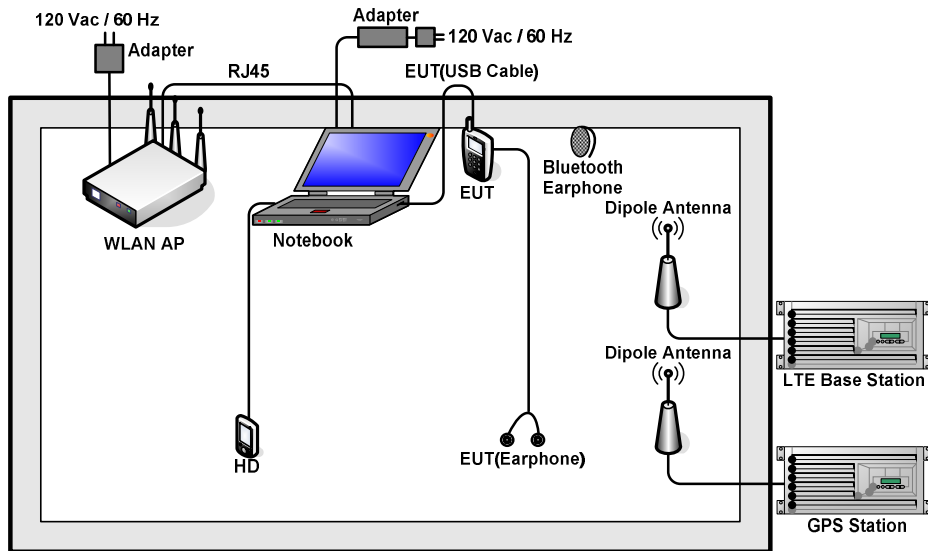



2.3. Support Unit used in test configuration and system

Item	Equipment	Trade Name	Model Name	FCC ID	Data Cable	Power Cord
1.	LTE Base Station	Anritsu	MT8820C	N/A	N/A	Unshielded, 1.8 m
2.	GPS Station	ADIVIC	MP9000	N/A	N/A	Unshielded, 1.8 m
3.	WLAN AP	LINKSYS	WRT600N	Q87-WRT600NV11	N/A	Unshielded, 1.8 m
4.	WLAN AP	D-link	DIR-855	KA2DIR855A2	N/A	Unshielded, 1.8 m
5.	Notebook	Lenovo	G480	N/A	N/A	AC I/P: Unshielded, 1.8 m DC O/P: Shielded, 1.8 m
6.	Bluetooth Earphone	Lenovo	LBH308	N/A	N/A	N/A
7.	Bluetooth Earphone	Lenovo	LBH301	QTLBH-106	N/A	N/A
8.	Hard Disk	Lenovo	F310	FCC DoC	Shielded, 0.5 m	N/A
9.	SD Card	Kingston	4GB	N/A	N/A	N/A
10.	SD Card	SanDisk	Uitra	N/A	N/A	N/A

2.4. EUT Operation Test Setup

The EUT was in LTE idle mode during the testing. The EUT was synchronized to the BCCH, and is in continuous receiving mode by setting system simulator's paging reorganization.

At the same time, the EUT was attached to the Bluetooth earphone or WLAN AP, and the following programs installed in the EUT were programmed during the test.

1. Data application is transferred between Notebook and EUT via USB cable.
2. Turn on GPS function to make the EUT receive continuous signals from GPS station.

3. Test Result

3.1. Test of AC Conducted Emission Measurement

3.1.1 Limits of AC Conducted Emission

For equipment that is designed to be connected to the public utility (AC) power line, the radio frequency voltage that is conducted back onto the AC power line on any frequency or frequencies within the band 150 kHz to 30 MHz shall not exceed the limits in the following table.

Frequency of emission (MHz)	Conducted limit (dBuV)	
	Quasi-peak	Average
0.15-0.5	66 to 56*	56 to 46*
0.5-5	56	46
5-30	60	50

*Decreases with the logarithm of the frequency.

3.1.2 Measuring Instruments

The measuring equipment is listed in the section 4 of this test report.

3.1.3 Test Procedure

1. The EUT was placed 0.4 meter from the conducting wall of the shielding room was kept at least 80 centimeters from any other grounded conducting surface.
2. Connect EUT to the power mains through a line impedance stabilization network (LISN).
3. All the support units are connecting to the other LISN.
4. The LISN provides 50 ohm coupling impedance for the measuring instrument.
5. The FCC states that a 50 ohm, 50 microhenry LISN should be used.
6. Both sides of AC line were checked for maximum conducted interference.
7. The frequency range from 150 kHz to 30 MHz was searched.
8. Set the test-receiver system to Peak Detect Function and specified bandwidth (IF Bandwidth = 9kHz) with Maximum Hold Mode. Then measurement is also conducted by Average Detector and Quasi-Peak Detector Function respectively.

3.1.4 Test Setup

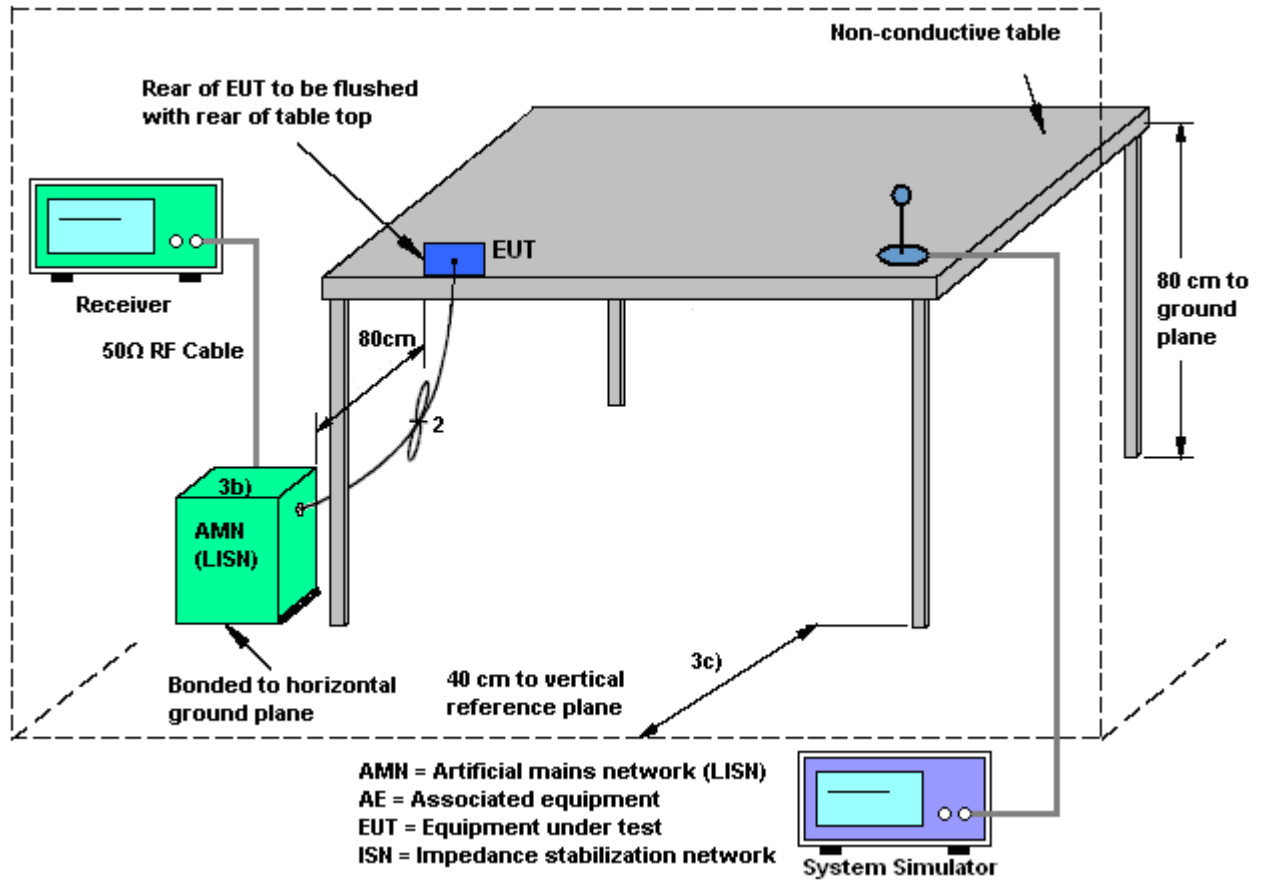



3.1.5 Test Result of AC Conducted Emission

Test Mode :	Mode 2	Temperature :	20~22°C
Test Engineer :	Peter Wei	Relative Humidity :	40~42%
Test Voltage :	120Vac / 60Hz	Phase :	Line
Function Type :	LTE Band 5 Idle + Bluetooth Idle + WLAN Idle + Earphone + USB Cable(Data Link with Notebook) + Battery 2 + GPS Rx + SIM1		

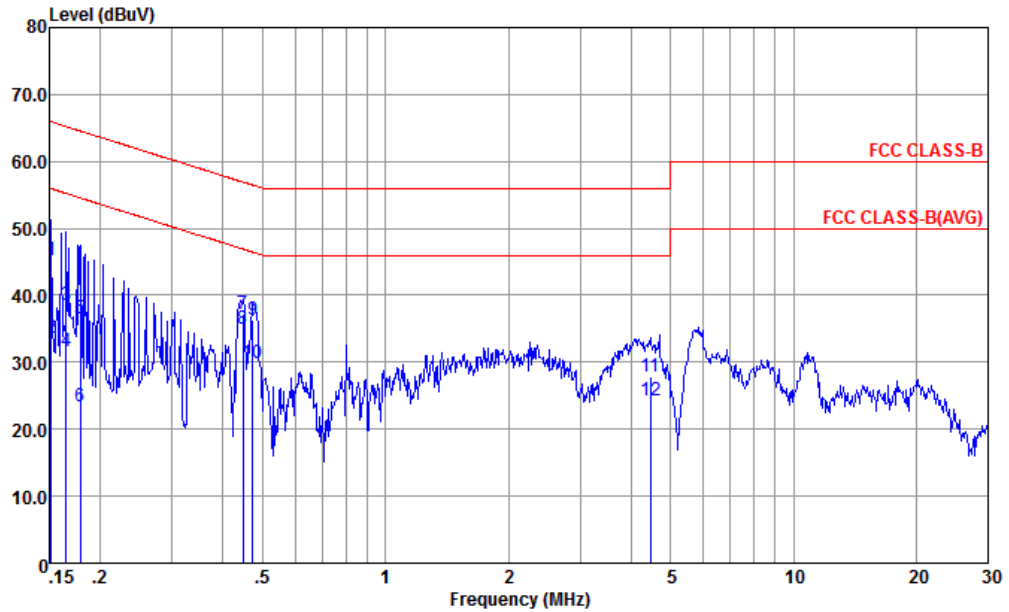

Site : CO01-KS
 Condition : FCC CLASS-B LISN-L-20151024 LINE
 Project : (FC) 711913-02
 mode : Mode 2
 IMEI : 355637080017718/726 #10

	Freq	Level	Over Limit	Limit Line	Read Level	LISN Factor	Cable Loss	Remark
	MHz	dBuV	dB	dBuV	dBuV	dB	dB	
1	0.152	45.31	-20.60	65.91	34.40	0.52	10.39	QP
2	0.152	33.61	-22.30	55.91	22.70	0.52	10.39	Average
3	0.165	38.50	-26.71	65.21	27.71	0.42	10.37	QP
4	0.165	31.70	-23.51	55.21	20.91	0.42	10.37	Average
5	0.179	36.60	-27.95	64.55	25.90	0.34	10.36	QP
6	0.179	23.40	-31.15	54.55	12.70	0.34	10.36	Average
7	0.447	37.12	-19.81	56.93	26.70	0.23	10.19	QP
8 *	0.447	35.02	-11.91	46.93	24.60	0.23	10.19	Average
9	0.474	36.22	-20.23	56.45	25.80	0.23	10.19	QP
10	0.474	29.82	-16.63	46.45	19.40	0.23	10.19	Average
11	4.454	27.93	-28.07	56.00	17.50	0.19	10.24	QP
12	4.454	24.33	-21.67	46.00	13.90	0.19	10.24	Average



Test Mode :	Mode 2	Temperature :	20~22°C
Test Engineer :	Peter Wei	Relative Humidity :	40~42%
Test Voltage :	120Vac / 60Hz	Phase :	Neutral
Function Type :	LTE Band 5 Idle + Bluetooth Idle + WLAN Idle + Earphone + USB Cable(Data Link with Notebook) + Battery 2 + GPS Rx + SIM1		

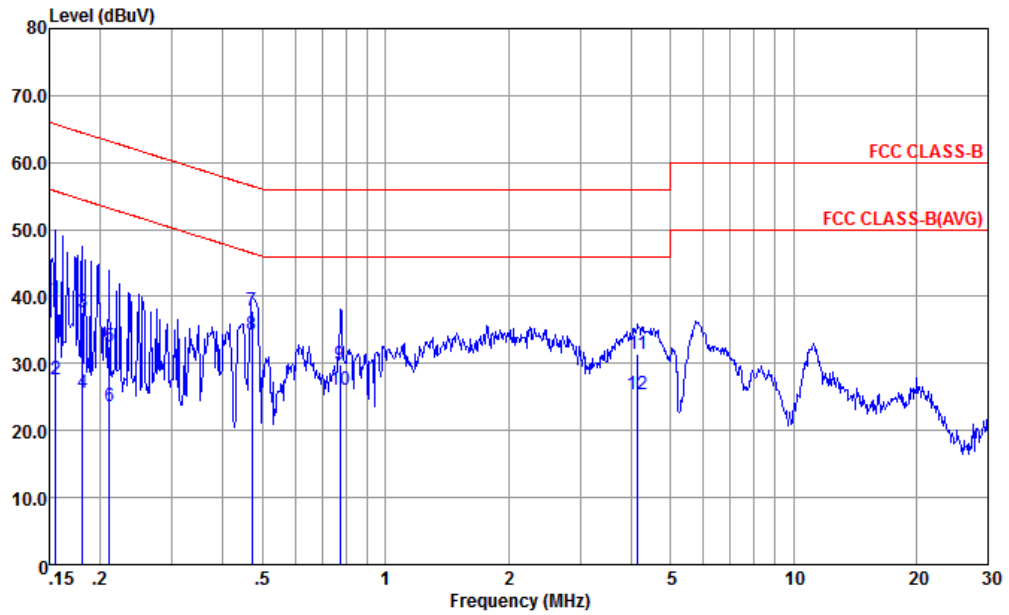

Site : CO01-KS
 Condition : FCC CLASS-B LISN-N-20151024 NEUTRAL
 Project : (FC) 711913-02
 mode : Mode 2
 IMEI : 355637080017718/726 #10

	Freq	Level	Over Limit	Limit Line	Read Level	LISN Factor	Cable Loss	Remark
	MHz	dBuV	dB	dBuV	dBuV	dB	dB	
1	0.156	39.69	-26.00	65.69	29.00	0.30	10.39	QP
2	0.156	27.59	-28.10	55.69	16.90	0.30	10.39	Average
3	0.181	37.76	-26.70	64.46	27.10	0.31	10.35	QP
4	0.181	25.56	-28.90	54.46	14.90	0.31	10.35	Average
5	0.211	32.53	-30.65	63.18	21.90	0.31	10.32	QP
6	0.211	23.53	-29.65	53.18	12.90	0.31	10.32	Average
7	0.471	37.91	-18.58	56.49	27.40	0.32	10.19	QP
8 *	0.471	34.21	-12.28	46.49	23.70	0.32	10.19	Average
9	0.775	29.92	-26.08	56.00	19.40	0.35	10.17	QP
10	0.775	26.12	-19.88	46.00	15.60	0.35	10.17	Average
11	4.158	31.50	-24.50	56.00	20.90	0.36	10.24	QP
12	4.158	25.30	-20.70	46.00	14.70	0.36	10.24	Average



3.2. Test of Radiated Emission Measurement

3.2.1. Limit of Radiated Emission

The emissions from an unintentional radiator shall not exceed the field strength levels specified in the following table:

Frequency (MHz)	Field Strength (microvolts/meter)	Measurement Distance (meters)
30 – 88	100	3
88 – 216	150	3
216 - 960	200	3
Above 960	500	3

3.2.2. Measuring Instruments

The measuring equipment is listed in the section 4 of this test report.

3.2.3. Test Procedures

1. The EUT was placed on a turntable with 0.8 meter above ground.
2. The EUT was set 3 meters from the interference receiving antenna, which was mounted on the top of a variable height antenna tower.
3. The table was rotated 360 degrees to determine the position of the highest radiation.
4. The antenna is a Bi-Log antenna and its height is adjusted between one to four meters above ground to find the maximum value of the field strength for both horizontal polarization and vertical polarization of the antenna.
5. For each suspected emission, the EUT was arranged to its worst case and then tune the antenna tower (from 1 m to 4 m) and turntable (from 0 degree to 360 degrees) to find the maximum reading.
6. Set the test-receiver system to Peak Detect Function and specified bandwidth with Maximum Hold Mode (RBW=120kHz/VBW=300kHz for frequency below 1GHz; RBW=1MHz VBW=3MHz (Peak), RBW=1MHz/VBW=10Hz (Average) for frequency above 1GHz).
7. If the emission level of the EUT in peak mode was 3 dB lower than the limit specified, peak values of EUT will be reported. Otherwise, the emission will be repeated by using the quasi-peak method and reported.
8. Emission level (dBµV/m) = 20 log Emission level (µV/m)
9. Corrected Reading: Antenna Factor + Cable Loss + Read Level - Preamp Factor = Level

3.2.4. Test Setup of Radiated Emission

For radiated emissions from 30MHz to 1GHz



For radiated emissions above 1GHz

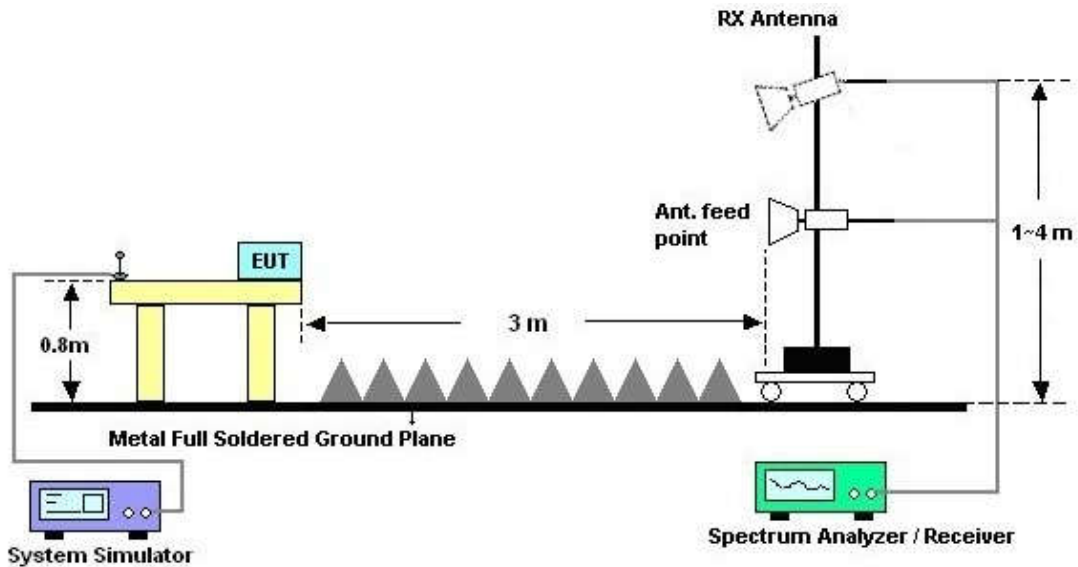



3.2.5. Test Result of Radiated Emission

Test Mode :	Mode 1	Temperature :	21~22°C
Test Engineer :	Jason Peng	Relative Humidity :	41~42%
Test Distance :	3m	Polarization :	Horizontal
Function Type :	LTE Band 5 Idle + Bluetooth Idle + WLAN Idle + Earphone + USB Cable(Data Link with Notebook) + Battery 1 + GPS Rx		
Remark :	#6 is system simulator signal which can be ignored.		

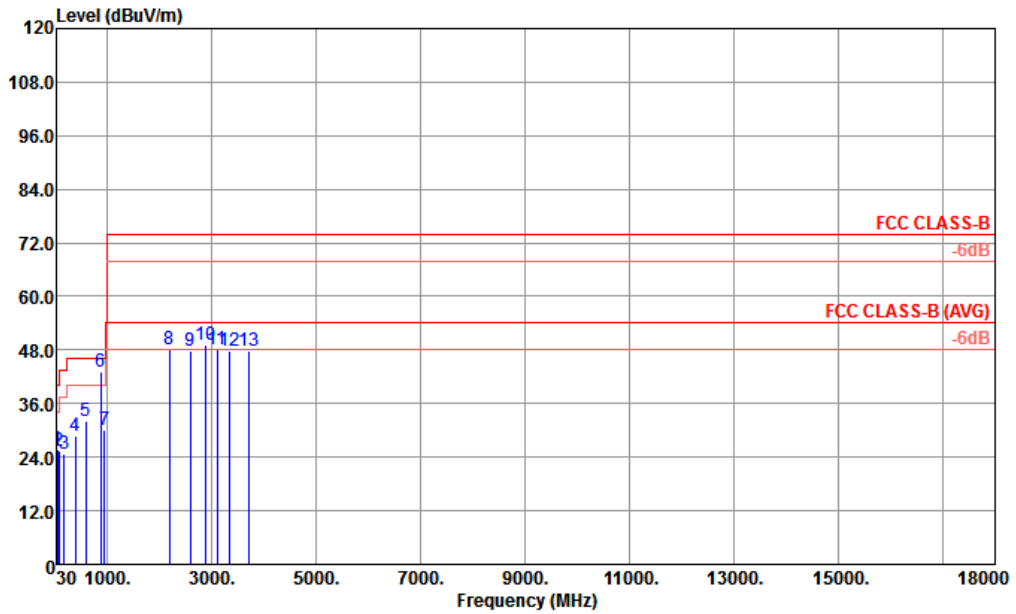

Site : 03CH02-KS
 Condition : FCC CLASS-B 3m 966-02 LF ANT HORIZONTAL
 Project : (FC)711913-02
 Mode : 1
 IMEI : 355637080018377 355637080018385 #7

	Freq	Level	Over Limit	Limit Line	ReadAntenna	Cable	Preamp	A/Pos	T/Pos	Remark	
	MHz	dBuV/m	dB	dBuV/m	dBuV	dB/m	dB	dB	cm	deg	
1	45.52	25.72	-14.28	40.00	37.98	19.50	0.14	31.90	---	---	Peak
2	79.47	25.34	-14.66	40.00	41.65	15.20	0.20	31.71	---	---	Peak
3	182.29	24.74	-18.76	43.50	39.95	16.13	0.38	31.72	---	---	Peak
4	397.63	28.74	-17.26	46.00	33.35	25.01	0.91	30.53	---	---	Peak
5	597.45	32.15	-13.85	46.00	35.85	24.32	0.90	28.92	100	0	Peak
6 !	878.75	43.17			41.22	27.43	1.57	27.05	---	---	Peak
7	949.56	30.01	-15.99	46.00	26.40	28.39	1.71	26.49	---	---	Peak
8	2194.00	48.15	-25.85	74.00	45.52	31.14	5.80	34.31	---	---	Peak
9	2588.00	47.72	-26.28	74.00	44.20	31.64	3.74	31.86	---	---	Peak
10	2898.00	49.05	-24.95	74.00	41.86	32.35	2.95	28.11	---	---	Peak
11	3102.00	48.16	-25.84	74.00	40.67	33.04	4.43	29.98	---	---	Peak
12	3339.00	47.71	-26.29	74.00	39.07	33.60	5.96	30.92	---	---	Peak
13	3705.00	47.84	-26.16	74.00	38.54	34.30	6.34	31.34	---	---	Peak



Test Mode :	Mode 1	Temperature :	21~22°C
Test Engineer :	Jason Peng	Relative Humidity :	41~42%
Test Distance :	3m	Polarization :	Vertical
Function Type :	LTE Band 5 Idle + Bluetooth Idle + WLAN Idle + Earphone + USB Cable(Data Link with Notebook) + Battery 1 + GPS Rx		
Remark :	#7 is system simulator signal which can be ignored.		

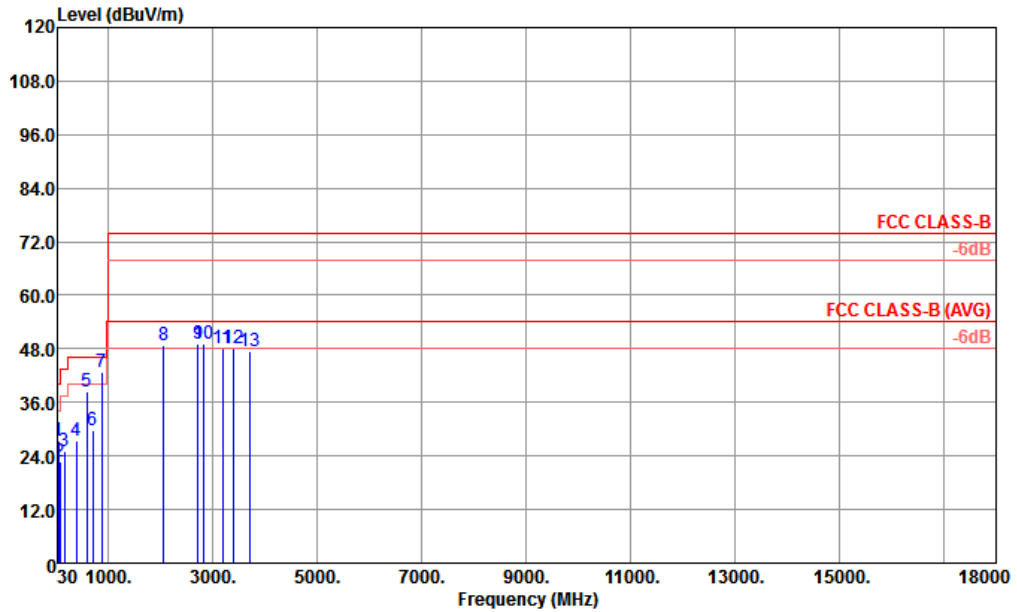

Site : 03CH02-KS
 Condition : FCC CLASS-B 3m 966-02 LF ANT VERTICAL
 Project : (FC)711913-02
 Mode : 1
 IMEI : 355637080018377 355637080018385 #7

	Freq	Level	Over	Limit	ReadAntenna	Cable	Preamp	A/Pos	T/Pos	Remark	
	MHz	dBuV/m	dB	dBuV/m	dBuV	dB/m	dB	dB	cm	deg	
1	45.52	27.42	-12.58	40.00	39.68	19.50	0.14	31.90	---	---	Peak
2	79.47	22.83	-17.17	40.00	39.14	15.20	0.20	31.71	---	---	Peak
3	172.59	24.94	-18.56	43.50	39.49	16.59	0.36	31.50	---	---	Peak
4	397.63	27.57	-18.43	46.00	32.18	25.01	0.91	30.53	---	---	Peak
5	598.42	38.45	-7.55	46.00	42.13	24.33	0.90	28.91	100	0	Peak
6	711.91	29.65	-16.35	46.00	29.95	26.64	1.22	28.16	---	---	Peak
7 !	880.69	42.84			40.84	27.45	1.58	27.03	---	---	Peak
8	2070.00	48.73	-25.27	74.00	47.52	30.73	5.05	34.57	---	---	Peak
9	2722.00	49.01	-24.99	74.00	43.11	31.92	3.01	29.03	---	---	Peak
10	2840.00	49.21	-24.79	74.00	42.00	32.18	2.81	27.78	---	---	Peak
11	3192.00	48.00	-26.00	74.00	40.05	33.40	5.73	31.18	---	---	Peak
12	3396.00	48.06	-25.94	74.00	39.41	33.66	5.93	30.94	---	---	Peak
13	3723.00	47.39	-26.61	74.00	38.10	34.37	6.34	31.42	---	---	Peak



4. List of Measuring Equipment

Instrument	Manufacturer	Model No.	Serial No.	Characteristics	Calibration Date	Test Date	Due Date	Remark
EMI Receiver	R&S	ESC17	100768	9kHz~7GHz	Apr. 29, 2016	Mar. 20, 2017	Apr. 28, 2017	Conduction (CO01-KS)
AC LISN	MessTec	AN3016	060103	9kHz~30MHz	Oct. 13, 2016	Mar. 20, 2017	Oct. 12, 2017	Conduction (CO01-KS)
AC LISN (for auxiliary equipment)	MessTec	AN3016	060105	9kHz~30MHz	Oct. 13, 2016	Mar. 20, 2017	Oct. 12, 2017	Conduction (CO01-KS)
AC Power Source	Chroma	61602	ABP0000008 11	AC 0V~300V, 45Hz~1000Hz	Oct. 13, 2016	Mar. 20, 2017	Oct. 12, 2017	Conduction (CO01-KS)
EMI Test Receiver	R&S	ESR7	101403	9kHz~7GHz; Max 30dBm	Aug. 09, 2016	Mar. 18, 2017	Aug. 08, 2017	Radiation (03CH02-KS)
EXA Spectrum Analyzer	Keysight	N9010A	MY55150208	10Hz~44GHz, MAX 30dB	Apr. 22, 2016	Mar. 18, 2017	Apr. 21, 2017	Radiation (03CH02-KS)
Bilog Antenna	TeseQ	CBL6112D	37879	30MHz~2GHz	Aug. 20, 2016	Mar. 18, 2017	Aug. 19, 2017	Radiation (03CH02-KS)
Double Ridge Horn Antenna	ETS-Lindgren	3117	75957	1GHz~18GHz	Oct. 22, 2016	Mar. 18, 2017	Oct. 21, 2017	Radiation (03CH02-KS)
Amplifier	com-power	PA-103A	161069	1kHz~1000MHz / 32 dB	Apr. 22, 2016	Mar. 18, 2017	Apr. 21, 2017	Radiation (03CH02-KS)
Amplifier	Agilent	8449B	3008A02384	1-26.5GHz Gain 30dB	Oct. 13, 2016	Mar. 18, 2017	Oct. 12, 2017	Radiation (03CH02-KS)
AC Power Source	Chroma	61601	61601000247 3	N/A	NCR	Mar. 18, 2017	NCR	Radiation (03CH02-KS)
Turn Table	MF	MF7802	N/A	0~360 degree	NCR	Mar. 18, 2017	NCR	Radiation (03CH02-KS)
Antenna Mast	MF	MF7802	N/A	1 m~4 m	NCR	Mar. 18, 2017	NCR	Radiation (03CH02-KS)

NCR: No Calibration Required



5. Uncertainty of Evaluation

Uncertainty of Conducted Emission Measurement (150 kHz ~ 30 MHz)

Measuring Uncertainty for a Level of Confidence of 95% ($U = 2Uc(y)$)	2.3dB
---	-------

Uncertainty of Radiated Emission Measurement (30 MHz ~ 1000 MHz)

Measuring Uncertainty for a Level of Confidence of 95% ($U = 2Uc(y)$)	5.2dB
---	-------

Uncertainty of Radiated Emission Measurement (1GHz ~ 18GHz)

Measuring Uncertainty for a Level of Confidence of 95% ($U = 2Uc(y)$)	4.7dB
---	-------