



FCC RF Test Report

APPLICANT : Motorola Mobility LLC
EQUIPMENT : Mobile Cellular Phone
BRAND NAME : Motorola
MODEL NAME : 10715, 10716
FCC ID : IHDT56WC4
STANDARD : FCC Part 15 Subpart C §15.247
CLASSIFICATION : (DTS) Digital Transmission System

The product was received on Jan. 19, 2017 and testing was completed on Mar. 14, 2017. We, Sporton International (KunShan) INC., would like to declare that the tested sample has been evaluated in accordance with the test procedures and has been in compliance with the applicable technical standards.

The test results in this report apply exclusively to the tested model / sample. Without written approval of Sporton International (KunShan) INC., the test report shall not be reproduced except in full.

Prepared by: James Huang / Manager



Approved by: Jones Tsai / Manager

Sporton International (KunShan) INC.
No.3-2, Pingxiang Road, Kunshan Development Zone, Jiangsu, China



TABLE OF CONTENTS

SUMMARY OF TEST RESULT 4

1 GENERAL DESCRIPTION..... 5

1.1 Applicant 5

1.2 Manufacturer 5

1.3 Product Feature of Equipment Under Test..... 5

1.4 Product Specification of Equipment Under Test..... 6

1.5 Specification of Accessory 6

1.6 Modification of EUT 6

1.7 Re-use of Measured Data 7

1.8 Testing Location 8

1.9 Applicable Standards..... 8

2 TEST CONFIGURATION OF EQUIPMENT UNDER TEST..... 9

2.1 Descriptions of Test Mode 9

2.2 Test Mode 9

2.3 Connection Diagram of Test System 10

2.4 Support Unit used in test configuration and system 11

2.5 EUT Operation Test Setup 11

2.6 Radiated Band Edges and Spurious Emission Measurement 12

2.7 AC Conducted Emission Measurement..... 16

2.8 Antenna Requirements 20

3 LIST OF MEASURING EQUIPMENT..... 21

4 UNCERTAINTY OF EVALUATION..... 22

APPENDIX A. RADIATED SPURIOUS EMISSION

APPENDIX B. DUTY CYCLE PLOTS

APPENDIX C. SETUP PHOTOGRAPHS

APPENDIX D. PRODUCT EQUALITY DECLARATION

APPENDIX E. REFERENCE REPORT



SUMMARY OF TEST RESULT

Report Section	FCC Rule	Description	Limit	Result	Remark
2.6	15.247(d)	Radiated Band Edges and Spurious Emission	15.209(a) & 15.247(d)	Pass	Under limit 6.70 dB at 40.670 MHz
2.7	15.207	AC Conducted Emission	15.207(a)	Pass	Under limit 8.56 dB at 0.150 MHz
2.8	15.203 & 15.247(b)	Antenna Requirement	N/A	Pass	-



1 General Description

1.1 Applicant

Motorola Mobility LLC
222 W, Merchandise Mart Plaza, Chicago IL 60654 USA

1.2 Manufacturer

Motorola Mobility LLC
222 W, Merchandise Mart Plaza, Chicago IL 60654 USA

1.3 Product Feature of Equipment Under Test

Product Feature	
Equipment	Mobile Cellular Phone
Brand Name	Motorola
Model Name	10715, 10716
FCC ID	IHDT56WC4
EUT supports Radios application	GSM/GPRS/EGPRS/WCDMA/HSPA/HSPA+/DC-HSDPA/LTE/ WLAN2.4GHz 802.11b/g/n HT20/ Bluetooth v3.0+EDR Bluetooth v4.0 LE/Bluetooth v4.1 LE/Bluetooth v4.2 LE
IMEI Code	Radiation: 355647080006330/355647080006348 Conduction: 355639080022672/355639080022680
HW Version	WKGMA1A4-3
SW Version	woods- userdebug 7.0 NMA25.27 314 intcfg,test-keys
EUT Stage	Identical Prototype

Remark:

1. The above EUT's information was declared by manufacturer. Please refer to the specifications or user's manual for more detailed description.
2. There are two types of EUT sample 1 and sample 2, the differences between two samples are only for SIM slot, sample 1(model name: 10715) is dual SIM slot, sample 2(model name: 10716) is single SIM slot. According to the difference, the sample 1 to perform full test.



1.4 Product Specification of Equipment Under Test

Standards-related Product Specification	
Tx/Rx Frequency Range	2402 MHz ~ 2480 MHz
Number of Channels	40
Carrier Frequency of Each Channel	40 Channel(37 hopping + 3 advertising channel)
Antenna Type / Gain	PIFA Antenna with gain -0.6 dBi
Type of Modulation	Bluetooth LE : GFSK

1.5 Specification of Accessory

Specification of Accessory				
AC Adapter	Brand Name	Motorola (Salom)	Model Name	SSW-2865BR SPN5933A
	Power Rating	I/P: 100-240 Vac, 500mA, O/P: 5.0Vdc, 2000mA		
Battery 1	Brand Name	Motorola (ATL)	Model Name	GK40
	Power Rating	3.8Vdc,2685/2800mAh (Min/Typ)	Type	Li-ion
Battery 2	Brand Name	Motorola (Sunwoda)	Model Name	GK40
	Power Rating	3.8Vdc,2685/2800mAh (Min/Typ)	Type	Li-ion
Earphone	Brand Name	Motorola (Cosonic)	Model Name	SH38C16617
	Signal Line Type	1.1 meter, non-shielded cable, without ferrite core		
USB Cable	Brand Name	Motorola (Sai Bao)	Model Name	SYD-A017A
	Signal Line Type	1.0 meter, shielded cable, without ferrite core		

1.6 Modification of EUT

No modifications are made to the EUT during all test items.



1.7 Re-use of Measured Data

1.7.1 Introduction Section

This application re-uses data collected on a similar device. The subject device of this application (Model: 10715, 10716, FCC ID: IHDT56WC4) is electrically identical to the reference device (Model: 10714, FCC ID: IHDT56WC6) for the portions of the circuitry corresponding to the data being re-used, as treated by KDB Publication 178919 D01.

1.7.2 Difference Section

For details concerning the similarity with respect to component placement, mechanical/electrical design etc., please refer to Product Equality Declaration as Appendix D..

The re-used RF data includes the following bands provided in Appendix E (Sporton RF Report No. FR711913B for the reference device Model: 10714, FCC ID: IHDT56WC6)

1.7.3 Spot Check Verification Data Section

In order to confirm hardware similarity of the subject device with the reference device, spot check measurements were performed on the subject device for radiated spurious emission and conducted Emission.

Assertions concerning the similarity of these devices are based on representations by the applicant. The applicant accepts full responsibility for the validity of the similarity claim, and for the determination that verification test data are sufficient to support it.

1.7.4 Reference detail Section:

Equipment Class	Reference FCC ID	Folder Test/RF Exposure	Report Title/Section
DSS	IHDT56WC6	Part15C(FR711913A)	Conducted sections applicable
DTS (BLE)	IHDT56WC6	Part15C(FR711913B)	Conducted sections applicable
DTS (WLAN)	IHDT56WC6	Part15C(FR711913C)	Conducted sections applicable



1.8 Testing Location

Test Site	Sporton International (KunShan) INC.	
Test Site Location	No.3-2, Pingxiang Road, Kunshan Development Zone, Jiangsu, China TEL: +86-0512-5790-0158 FAX: +86-0512-5790-0958	
Test Site No.	Sporton Site No.	FCC Registration No.
	03CH02-KS	418269

Test Site	SPORTON International (ShenZhen) INC.	
Test Site Location	1/F, 2/F, Bldg 5, Shiling Industrial Zone, Xinwei Village, Xili, Nanshan District, Shenzhen City, Guangdong Province, China TEL: +86-755-8637-9589 FAX: +86-755-8637-9595	
Test Site No.	Sporton Site No.	
	CO01-SZ	

Note: The test site complies with ANSI C63.4 2014 requirement.

1.9 Applicable Standards

According to the specifications of the manufacturer, the EUT must comply with the requirements of the following standards:

- FCC Part 15 Subpart C §15.247
- FCC KDB Publication No. 558074 D01 DTS Meas. Guidance v03r05
- ANSI C63.10-2013

Remark:

1. All test items were verified and recorded according to the standards and without any deviation during the test.
2. This EUT has also been tested and complied with the requirements of FCC Part 15, Subpart B, recorded in a separate test report.



2 Test Configuration of Equipment Under Test

2.1 Descriptions of Test Mode

- a. The EUT has been associated with peripherals and configuration operated in a manner tended to maximize its emission characteristics in a typical application. Frequency range investigated: conduction (150 kHz to 30 MHz), radiation (9 kHz to the 10th harmonic of the highest fundamental frequency or to 40 GHz, whichever is lower). Pre-scanned tests, X, Y, Z in three orthogonal panels to determine the final configuration (Z plane as worst plane) from all possible combinations.
- b. AC power line Conducted Emission was tested under maximum output power.

2.2 Test Mode

The following summary table is showing all test modes to demonstrate in compliance with the standard.

Summary table of Test Cases	
Test Item	Data Rate / Modulation
	Bluetooth LE / GFSK
Radiated TCs	Mode 1: Bluetooth Tx CH00_2402 MHz_1Mbps Mode 2: Bluetooth Tx CH19_2440 MHz_1Mbps Mode 3: Bluetooth Tx CH39_2480 MHz_1Mbps
AC Conducted Emission	Mode 1: GSM850 Idle + Bluetooth Link + WLAN Link + Earphone + Battery 1 + USB Cable (Charging from Adapter) + SIM 1 for Sample 1 Mode 2: GSM850 Idle + Bluetooth Link + WLAN Link + Earphone + Battery 2 + USB Cable (Charging from Adapter) + SIM 1 for Sample 1
Remark: 1. The worst case of conducted emission is mode 2; only the test data of it was reported. 2. For Radiated TCs, The tests were performed with Adapter, Battery 1, Battery 2, Earphone and USB Cable for Sample 1.	

2.3 Connection Diagram of Test System

<Bluetooth LE Tx Mode>

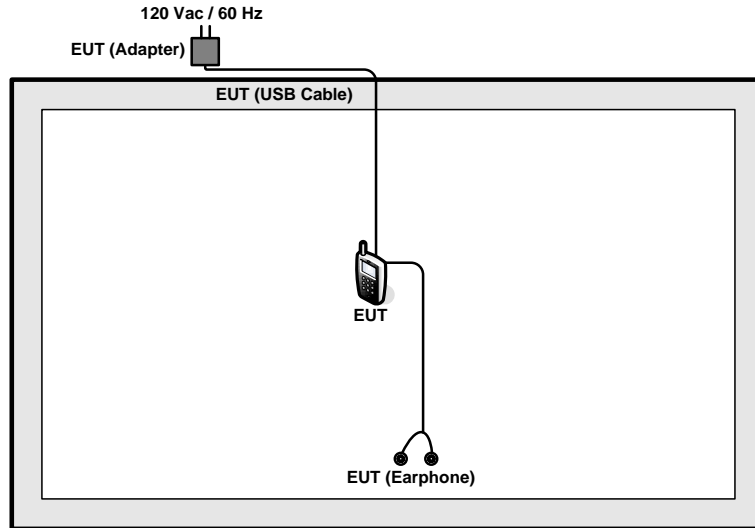

<AC Conducted Emission Mode>

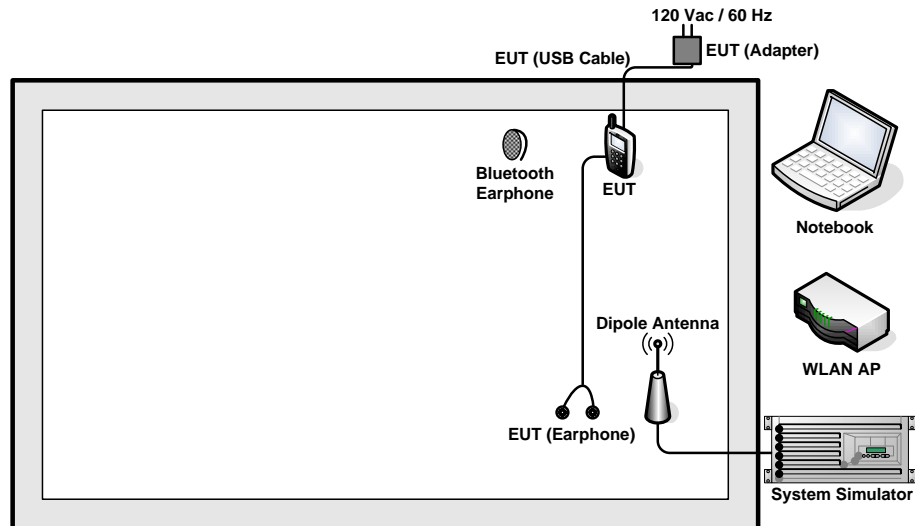

2.4 Support Unit used in test configuration and system

Item	Equipment	Trade Name	Model Name	FCC ID	Data Cable	Power Cord
1.	System Simulator	R&S	CMU 200	N/A	N/A	Unshielded, 1.8 m
2.	WLAN AP	Dlink	DIR-820L	KA2IR820LA1	N/A	Unshielded, 1.8 m
3.	Notebook	Lenovo	E540	FCC DoC	N/A	AC I/P: Unshielded, 1.2 m DC O/P: Shielded, 1.8 m
4.	Bluetooth Earphone	Nokia	BH-108	PYAHS-107W	N/A	N/A

2.5 EUT Operation Test Setup

For Bluetooth LE function, the engineering test program was provided and enabled to make EUT continuous transmit/receive.

For AC power line conducted emissions, the EUT was set to connect with the WLAN AP under large package sizes transmission.



2.6 Radiated Band Edges and Spurious Emission Measurement

2.6.1 Limit of Radiated Band Edges and Spurious Emission

In any 100 kHz bandwidth outside the intentional radiator frequency band, all harmonics/spurious must be at least 20 dB below the highest emission level within the authorized band. If the output power of this device was measured by spectrum analyzer, the attenuation under this paragraph shall be 30 dB instead of 20 dB. In addition, radiated emissions which fall in the restricted bands must also comply with the FCC section 15.209 limits as below.

Frequency (MHz)	Field Strength (microvolts/meter)	Measurement Distance (meters)
0.009 – 0.490	2400/F(kHz)	300
0.490 – 1.705	24000/F(kHz)	30
1.705 – 30.0	30	30
30 – 88	100	3
88 – 216	150	3
216 - 960	200	3
Above 960	500	3

2.6.2 Measuring Instruments

The section 3.0 of List of Measuring Equipment of this test report is used for test.



2.6.3 Test Procedures

1. The testing follows FCC KDB Publication No. 558074 D01 DTS Meas. Guidance v03r05.
2. The EUT was arranged to its worst case and then tune the antenna tower (from 1 m to 4 m) and turntable (from 0 degree to 360 degrees) to find the maximum reading. A pre-amp and a high pass filter are used for the test in order to get better signal level.
3. The EUT was placed on a turntable with 0.8 meter for frequency below 1GHz and 1.5 meter for frequency above 1GHz respectively above ground.
4. The EUT was set 3 meters from the interference receiving antenna, which was mounted on the top of a variable height antenna tower.
5. Corrected Reading: Antenna Factor + Cable Loss + Read Level - Preamp Factor = Level
6. For measurement below 1GHz, If the emission level of the EUT measured by the peak detector is 3 dB lower than the applicable limit, the peak emission level will be reported. Otherwise, the emission measurement will be repeated using the quasi-peak detector and reported.
7. Use the following spectrum analyzer settings:
 - (1) Span shall wide enough to fully capture the emission being measured;
 - (2) Set RBW=100 kHz for $f < 1$ GHz; VBW \geq RBW; Sweep = auto; Detector function = peak; Trace = max hold;
 - (3) Set RBW = 1 MHz, VBW= 3MHz for $f \geq 1$ GHz for peak measurement.

For average measurement:

 - VBW = 10 Hz, when duty cycle is no less than 98 percent.
 - VBW $\geq 1/T$, when duty cycle is less than 98 percent where T is the minimum transmission duration over which the transmitter is on and is transmitting at its maximum power control level for the tested mode of operation.

2.6.4 Test Setup

For radiated emissions below 30MHz

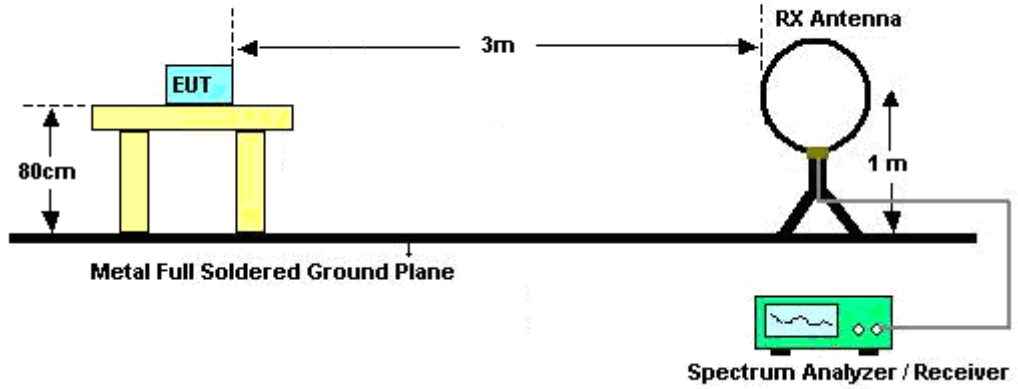

For radiated emissions from 30MHz to 1GHz

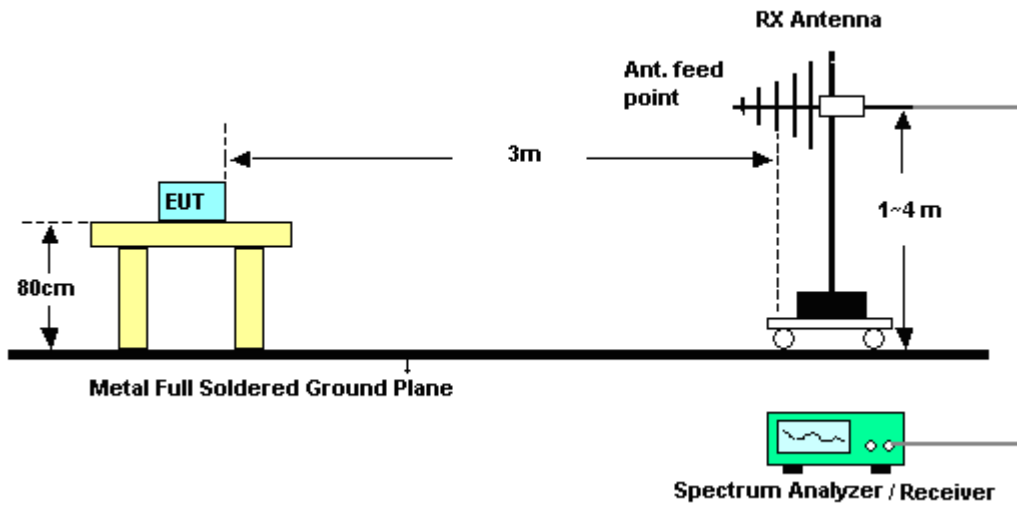

For radiated emissions above 1GHz

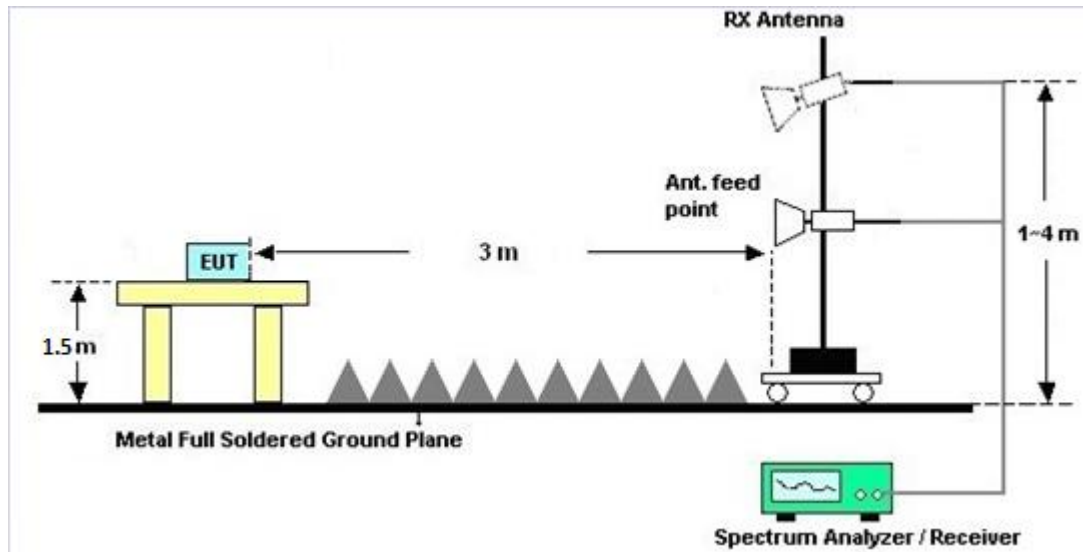

2.6.5 Test Results of Radiated Spurious Emissions (9 kHz ~ 30 MHz)

The low frequency, which started from 9 kHz to 30MHz, was pre-scanned and the result which was 20dB lower than the limit line per 15.31(o) was not reported.

2.6.6 Test Result of Radiated Spurious at Band Edges

Please refer to Appendix A.

2.6.7 Duty Cycle

Please refer to Appendix B.

2.6.8 Test Result of Radiated Spurious Emission (30MHz ~ 10th Harmonic)

Please refer to Appendix A.



2.7 AC Conducted Emission Measurement

2.7.1 Limit of AC Conducted Emission

For equipment that is designed to be connected to the public utility (AC) power line, the radio frequency voltage that is conducted back onto the AC power line on any frequency or frequencies within the band 150 kHz to 30 MHz shall not exceed the limits in the following table.

Frequency of emission (MHz)	Conducted limit (dB μ V)	
	Quasi-peak	Average
0.15-0.5	66 to 56*	56 to 46*
0.5-5	56	46
5-30	60	50

*Decreases with the logarithm of the frequency.

2.7.2 Measuring Instruments

The section 3.0 of List of Measuring Equipment of this test report is used for test.

2.7.3 Test Procedures

1. The EUT was placed 0.4 meter from the conducting wall of the shielding room was kept at least 80 centimeters from any other grounded conducting surface.
2. Connect EUT to the power mains through a line impedance stabilization network (LISN).
3. All the support units are connecting to the other LISN.
4. The LISN provides 50 ohm coupling impedance for the measuring instrument.
5. The FCC states that a 50 ohm, 50 microhenry LISN should be used.
6. Both sides of AC line were checked for maximum conducted interference.
7. The frequency range from 150 kHz to 30 MHz was searched.
8. Set the test-receiver system to Peak Detect Function and specified bandwidth (IF Bandwidth = 9kHz) with Maximum Hold Mode. Then measurement is also conducted by Average Detector and Quasi-Peak Detector Function respectively.

2.7.4 Test Setup

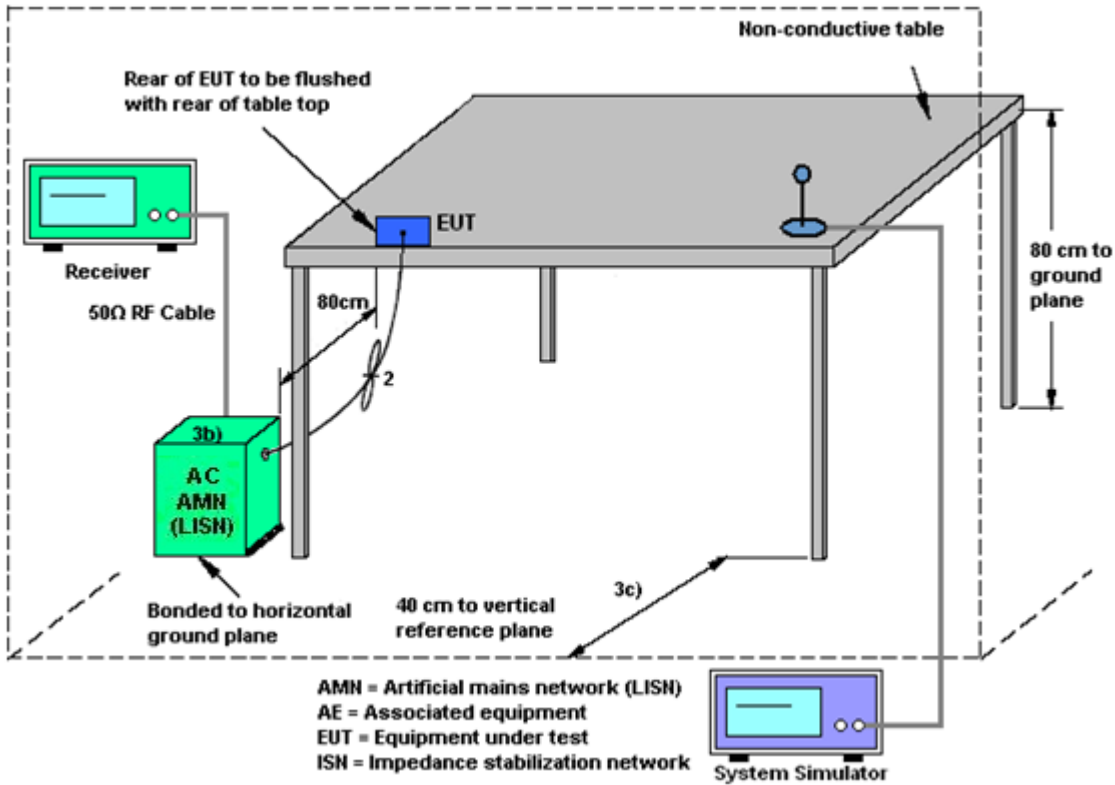



2.7.5 Test Result of AC Conducted Emission

Test Mode :	Mode 2	Temperature :	21~23°C
Test Engineer :	Tao Cheng	Relative Humidity :	41~42%
Test Voltage :	120Vac / 60Hz	Phase :	Line
Function Type :	GSM850 Idle + Bluetooth Link + WLAN Link + Earphone + Battery 2 + USB Cable (Charging from Adapter) + SIM 1 for Sample 1		

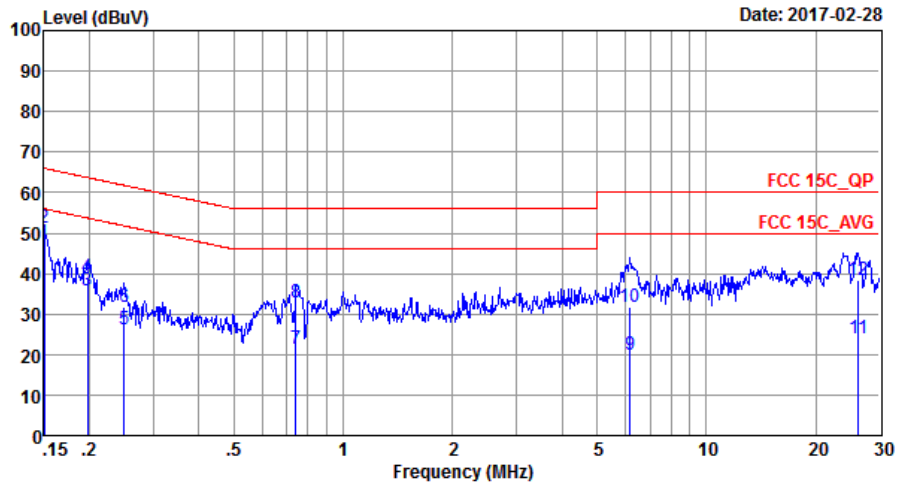

Site : CO01-SZ
 Condition: FCC 15C_QP LISN_20170301_L LINE

Mode : Mode 2
 IMEI : 355639080022672/355639080022680

	Freq	Level	Over Limit	Limit Line	Read Level	LISN Factor	Cable Loss	Remark
	MHz	dBuV	dB	dBuV	dBuV	dB	dB	
1 *	0.15	47.44	-8.56	56.00	37.00	0.03	10.41	Average
2	0.15	51.14	-14.86	66.00	40.70	0.03	10.41	QP
3	0.20	35.96	-17.75	53.71	25.70	0.03	10.23	Average
4	0.20	39.06	-24.65	63.71	28.80	0.03	10.23	QP
5	0.25	26.15	-25.63	51.78	15.90	0.03	10.22	Average
6	0.25	31.55	-30.23	61.78	21.30	0.03	10.22	QP
7	0.74	21.39	-24.61	46.00	11.20	0.03	10.16	Average
8	0.74	32.89	-23.11	56.00	22.70	0.03	10.16	QP
9	6.15	19.82	-30.18	50.00	9.30	0.21	10.31	Average
10	6.15	31.72	-28.28	60.00	21.20	0.21	10.31	QP
11	26.28	23.86	-26.14	50.00	12.00	1.38	10.48	Average
12	26.28	38.26	-21.74	60.00	26.40	1.38	10.48	QP



Test Mode :	Mode 2	Temperature :	21~23°C
Test Engineer :	Tao Cheng	Relative Humidity :	41~42%
Test Voltage :	120Vac / 60Hz	Phase :	Neutral
Function Type :	GSM850 Idle + Bluetooth Link + WLAN Link + Earphone + Battery 2 + USB Cable (Charging from Adapter) + SIM 1 for Sample 1		

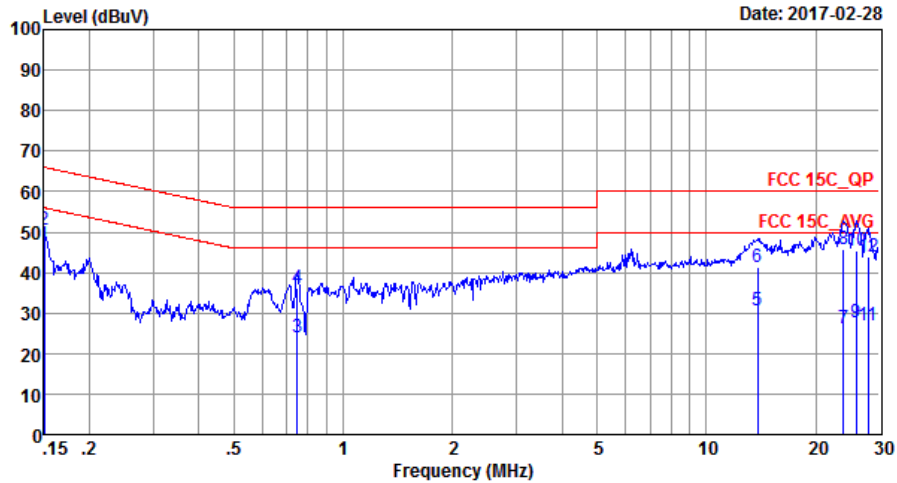

Site : CO01-SZ
 Condition: FCC 15C_QP LISN_20170301_N NEUTRAL

Mode : Mode 2
 IMEI : 355639080022672/355639080022680

	Freq	Level	Over Limit	Limit Line	Read Level	LISN Factor	Cable Loss	Remark
	MHz	dBuV	dB	dBuV	dBuV	dB	dB	
1 *	0.15	46.84	-9.16	56.00	36.40	0.03	10.41	Average
2	0.15	50.54	-15.46	66.00	40.10	0.03	10.41	QP
3	0.75	23.99	-22.01	46.00	13.80	0.03	10.16	Average
4	0.75	36.29	-19.71	56.00	26.10	0.03	10.16	QP
5	13.84	30.52	-19.48	50.00	19.90	0.30	10.32	Average
6	13.84	41.22	-18.78	60.00	30.60	0.30	10.32	QP
7	23.89	26.38	-23.62	50.00	14.90	0.91	10.57	Average
8	23.89	45.78	-14.22	60.00	34.30	0.91	10.57	QP
9	25.86	27.57	-22.43	50.00	16.00	1.06	10.51	Average
10	25.86	45.57	-14.43	60.00	34.00	1.06	10.51	QP
11	27.86	27.10	-22.90	50.00	15.50	1.20	10.40	Average
12	27.86	43.90	-16.10	60.00	32.30	1.20	10.40	QP



2.8 Antenna Requirements

2.8.1 Standard Applicable

If directional gain of transmitting antennas is greater than 6dBi, the power shall be reduced by the same level in dB comparing to gain minus 6dBi. The use of a permanently attached antenna or of an antenna that uses a unique coupling to the intentional radiator shall be considered sufficient to comply with the FCC rule.

2.8.2 Antenna Anti-Replacement Construction

An embedded-in antenna design is used.

2.8.3 Antenna Gain

The antenna peak gain of EUT is less than 6 dBi. Therefore, it is not necessary to reduce maximum peak output power limit.



3 List of Measuring Equipment

Instrument	Manufacturer	Model No.	Serial No.	Characteristics	Calibration Date	Test Date	Due Date	Remark
EMI Test Receiver	R&S	ESR7	101403	9kHz~7GHz; Max 30dBm	Aug. 09, 2016	Mar. 02, 2017 Mar. 14, 2017	Aug. 08, 2017	Radiation (03CH02-KS)
EXA Spectrum Analyzer	Keysight	N9010A	MY551502 08	10Hz~44GHz, MAX 30dB	Apr. 22, 2016	Mar. 02, 2017 Mar. 14, 2017	Apr. 21, 2017	Radiation (03CH02-KS)
Loop Antenna	R&S	HFH2-Z2	100321	9kHz~30MHz	Nov. 23, 2016	Mar. 02, 2017 Mar. 14, 2017	Nov. 22, 2017	Radiation (03CH02-KS)
Bilog Antenna	TeseQ	CBL6112D	37879	30MHz~2GHz	Aug. 20, 2016	Mar. 02, 2017 Mar. 14, 2017	Aug. 19, 2017	Radiation (03CH02-KS)
Double Ridge Horn Antenna	ETS-Lindgren	3117	75957	1GHz~18GHz	Oct. 22, 2016	Mar. 02, 2017 Mar. 14, 2017	Oct. 21, 2017	Radiation (03CH02-KS)
SHF-EHF Horn	Schwarzbeck	BBHA 9170	BBHA1702 49	15GHz~40GHz	Feb. 14, 2017	Mar. 02, 2017 Mar. 14, 2017	Feb. 13, 2018	Radiation (03CH02-KS)
Amplifier	com-power	PA-103A	161069	1kHz~1000MHz / 32 dB	Apr. 22, 2016	Mar. 02, 2017 Mar. 14, 2017	Apr. 21, 2017	Radiation (03CH02-KS)
Amplifier	Agilent	8449B	3008A023 84	1GHz~26.5GHz	Oct. 13, 2016	Mar. 02, 2017 Mar. 14, 2017	Oct. 12, 2017	Radiation (03CH02-KS)
Amplifier	MITEQ	TTA1840-35- HG	1887435	18GHz~40GHz	Oct. 13, 2016	Mar. 02, 2017 Mar. 14, 2017	Oct. 12, 2017	Radiation (03CH02-KS)
AC Power Source	Chroma	61601	616010002 473	N/A	NCR	Mar. 02, 2017 Mar. 14, 2017	NCR	Radiation (03CH02-KS)
Turn Table	MF	MF7802	N/A	0~360 degree	NCR	Mar. 02, 2017 Mar. 14, 2017	NCR	Radiation (03CH02-KS)
Antenna Mast	MF	MF7802	N/A	1 m~4 m	NCR	Mar. 02, 2017 Mar. 14, 2017	NCR	Radiation (03CH02-KS)
EMI Receiver	R&S	ESR7	101630	9kHz~7GHz;	Jan. 06, 2017	Feb. 28, 2017	Jan. 05, 2018	Conduction (CO01-SZ)
AC LISN	EMCO	3816/2SH	00103892	9kHz~30MHz	Jan. 05, 2017	Feb. 28, 2017	Jan. 04, 2018	Conduction (CO01-SZ)
AC LISN (for auxiliary equipment)	MessTec	3816/2SH	00103912	9kHz~30MHz	Jan. 05, 2017	Feb. 28, 2017	Jan. 04, 2018	Conduction (CO01-SZ)
AC Power Source	Chroma	61602	616020000 891	100Vac~250Vac	Jul. 16, 2016	Feb. 28, 2017	Jul. 15, 2017	Conduction (CO01-SZ)

NCR: No Calibration Required



4 Uncertainty of Evaluation

Uncertainty of Conducted Emission Measurement (150 kHz ~ 30 MHz)

Measuring Uncertainty for a Level of Confidence of 95% ($U = 2Uc(y)$)	2.5dB
---	-------

Uncertainty of Radiated Emission Measurement (30 MHz ~ 1000 MHz)

Measuring Uncertainty for a Level of Confidence of 95% ($U = 2Uc(y)$)	5.2dB
---	-------

Uncertainty of Radiated Emission Measurement (1000 MHz ~ 18000 MHz)

Measuring Uncertainty for a Level of Confidence of 95% ($U = 2Uc(y)$)	4.7dB
---	-------

Uncertainty of Radiated Emission Measurement (18000 MHz ~ 40000 MHz)

Measuring Uncertainty for a Level of Confidence of 95% ($U = 2Uc(y)$)	5.3dB
---	-------



Appendix A. Radiated Spurious Emission

2.4GHz 2400~2483.5MHz

BLE (Band Edge @ 3m)

Battery 1:

BLE	Note	Frequency	Level	Over Limit	Limit Line	Read Level	Antenna Factor	Cable Loss	Preamp Factor	Ant Pos	Table Pos	Peak Avg.	Pol.
		(MHz)	(dBμV/m)	(dB)	(dBμV/m)	(dBμV)	(dB/m)	(dB)	(dB)	(cm)	(deg)	(P/A)	(H/V)
BLE CH 00 2402MHz		2367.85	40.18	-33.82	74	41.7	25.29	4.73	31.54	100	28	P	H
		2381.63	30.87	-23.13	54	32.3	25.35	4.75	31.53	100	28	A	H
	*	2402	92.97	-	-	94.33	25.4	4.76	31.52	100	28	P	H
	*	2402	92.55	-	-	93.91	25.4	4.76	31.52	100	28	A	H
		2364.73	40.57	-33.43	74	42.09	25.29	4.73	31.54	134	135	P	V
		2367.46	30.75	-23.25	54	32.27	25.29	4.73	31.54	134	135	A	V
	*	2402	98.12	-	-	99.48	25.4	4.76	31.52	134	135	P	V
	*	2402	97.68	-	-	99.04	25.4	4.76	31.52	134	135	A	V
BLE CH 19 2440MHz		2373.96	40.46	-33.54	74	41.89	25.35	4.75	31.53	100	35	P	H
		2385.4	30.71	-23.29	54	32.14	25.35	4.75	31.53	100	35	A	H
	*	2440	97.53	-	-	98.36	25.83	4.82	31.48	100	35	P	H
	*	2440	97.05	-	-	97.88	25.83	4.82	31.48	100	35	A	H
		2496.1	41.62	-32.38	74	41.93	26.26	4.88	31.45	100	35	P	H
		2495.8	31.87	-22.13	54	32.18	26.26	4.88	31.45	100	35	A	H
		2350.04	41.4	-32.60	74	43	25.24	4.71	31.55	118	264	P	V
		2387.35	30.77	-23.23	54	32.13	25.4	4.76	31.52	118	264	A	V
	*	2440	101.35	-	-	102.18	25.83	4.82	31.48	118	264	P	V
	*	2440	100.71	-	-	101.54	25.83	4.82	31.48	118	264	A	V
		2498.44	41.76	-32.24	74	42.07	26.26	4.88	31.45	118	264	P	V
		2498.26	31.93	-22.07	54	32.24	26.26	4.88	31.45	118	264	A	V



BLE CH 39 2480MHz	*	2480	96.36	-	-	96.85	26.11	4.86	31.46	306	332	P	H
	*	2480	95.81	-	-	96.3	26.11	4.86	31.46	306	332	A	H
		2484.1	42.63	-31.37	74	43.12	26.11	4.86	31.46	306	332	P	H
		2483.5	39.41	-14.59	54	39.9	26.11	4.86	31.46	306	332	A	H
	*	2480	98.23	-	-	98.72	26.11	4.86	31.46	143	129	P	V
	*	2480	97.73	-	-	98.22	26.11	4.86	31.46	143	129	A	V
		2484.22	43.44	-30.56	74	43.93	26.11	4.86	31.46	143	129	P	V
		2483.5	41.11	-12.89	54	41.6	26.11	4.86	31.46	143	129	A	V



2.4GHz 2400~2483.5MHz

BLE (Band Edge @ 3m)

Battery 2:

BLE	Note	Frequency	Level	Over Limit	Limit Line	Read Level	Antenna Factor	Cable Loss	Preamp Factor	Ant Pos	Table Pos	Peak Avg.	Pol.
		(MHz)	(dBμV/m)	(dB)	(dBμV/m)	(dBμV)	(dB/m)	(dB)	(dB)	(cm)	(deg)	(P/A)	(H/V)
BLE CH 39 2480MHz		2480	97.17	-	-	97.66	26.11	4.86	31.46	306	25	P	H
		2480	96.65	-	-	97.14	26.11	4.86	31.46	306	25	A	H
	*	2483.8	42.9	-31.10	74	43.39	26.11	4.86	31.46	306	25	P	H
	*	2483.5	40.11	-13.89	54	40.6	26.11	4.86	31.46	306	25	A	H
		2480	99	-	-	99.49	26.11	4.86	31.46	141	59	P	V
		2480	98.56	-	-	99.05	26.11	4.86	31.46	141	59	A	V
	*	2483.74	43.92	-30.08	74	44.41	26.11	4.86	31.46	141	59	P	V
	*	2483.5	41.81	-12.19	54	42.3	26.11	4.86	31.46	141	59	A	V
Remark	1. No other spurious found. 2. All results are PASS against Peak and Average limit line.												



2.4GHz 2400~2483.5MHz
BLE (Harmonic @ 3m)

Table with 14 columns: BLE, Note, Frequency (MHz), Level (dBµV/m), Over Limit (dB), Limit Line (dBµV/m), Read Level (dBµV), Antenna Factor (dB/m), Cable Loss (dB), Preamp Factor (dB), Ant Pos (cm), Table Pos (deg), Peak Avg. (P/A), Pol. (H/V). Rows include data for CH 00 (2402MHz), CH 19 (2440MHz), and CH 39 (2480MHz).



Emission below 1GHz

2.4GHz BLE (LF)

BLE	Note	Frequency	Level	Over Limit	Limit Line	Read Level	Antenna Factor	Cable Loss	Preamp Factor	Ant Pos	Table Pos	Peak Avg.	Pol.
		(MHz)	(dBμV/m)	(dB)	(dBμV/m)	(dBμV)	(dB/m)	(dB)	(dB)	(cm)	(deg)	(P/A)	(H/V)
2.4GHz BLE LF		34.85	25.05	-14.95	40	32.52	23.5	0.03	31	160	20	P	H
		99.84	21.28	-22.22	43.5	33.79	17.8	0.39	30.7	-	-	P	H
		152.22	21.79	-21.71	43.5	34.31	17.24	1.15	30.91	-	-	P	H
		205.57	18.19	-25.31	43.5	31.74	15.95	1.61	31.11	-	-	P	H
		406.36	22.1	-23.90	46	28.42	22.69	2.5	31.51	-	-	P	H
		815.7	25.46	-20.54	46	25.69	28.02	2.61	30.86	-	-	P	H
		40.67	33.3	-6.70	40	44.59	19.64	0.31	31.24	160	32	P	V
		80.44	20.19	-19.81	40	35.34	15.4	0.85	31.4	-	-	P	V
		400.54	22.22	-23.78	46	28.63	22.61	2.48	31.5	-	-	P	V
		696.39	23.87	-22.13	46	25.59	26.76	2.4	30.88	-	-	P	V
		856.44	25.74	-20.26	46	25.82	28.58	2.53	31.19	-	-	P	V
		972.84	27.59	-26.41	54	24.95	30.57	3.46	31.39	-	-	P	V
Remark	1. No other spurious found. 2. All results are PASS against limit line.												



Note symbol

*	Fundamental Frequency which can be ignored. However, the level of any unwanted emissions shall not exceed the level of the fundamental frequency.
!	Test result is over limit line.
P/A	Peak or Average
H/V	Horizontal or Vertical



A calculation example for radiated spurious emission is shown as below:

WIFI	Note	Frequency	Level	Over	Limit	Read	Antenna	Cable	Preamp	Ant	Table	Peak	Pol.
Ant.				Limit	Line	Level	Factor	Loss	Factor	Pos	Pos	Avg.	
1+2		(MHz)	(dBμV/m)	(dB)	(dBμV/m)	(dBμV)	(dB/m)	(dB)	(dB)	(cm)	(deg)	(P/A)	(H/V)
802.11b		2390	55.45	-18.55	74	54.51	32.22	4.58	35.86	103	308	P	H
CH 01													
2412MHz		2390	43.54	-10.46	54	42.6	32.22	4.58	35.86	103	308	A	H

- Level(dBμV/m) =
Antenna Factor(dB/m) + Cable Loss(dB) + Read Level(dBμV) - Preamp Factor(dB)
- Over Limit(dB) = Level(dBμV/m) – Limit Line(dBμV/m)

For Peak Limit @ 2390MHz:

- Level(dBμV/m)
= Antenna Factor(dB/m) + Cable Loss(dB) + Read Level(dBμV) - Preamp Factor(dB)
= 32.22(dB/m) + 4.58(dB) + 54.51(dBμV) – 35.86 (dB)
= 55.45 (dBμV/m)
- Over Limit(dB)
= Level(dBμV/m) – Limit Line(dBμV/m)
= 55.45(dBμV/m) – 74(dBμV/m)
= -18.55(dB)

For Average Limit @ 2390MHz:

- Level(dBμV/m)
= Antenna Factor(dB/m) + Cable Loss(dB) + Read Level(dBμV) - Preamp Factor(dB)
= 32.22(dB/m) + 4.58(dB) + 42.6(dBμV) – 35.86 (dB)
= 43.54 (dBμV/m)
- Over Limit(dB)
= Level(dBμV/m) – Limit Line(dBμV/m)
= 43.54(dBμV/m) – 54(dBμV/m)
= -10.46(dB)

Both peak and average measured complies with the limit line, so test result is “PASS”.



Appendix B. Duty Cycle Plots

Band	Duty Cycle(%)	T(ms)	1/T(kHz)	VBW Setting
Bluetooth LE	60.28	0.38	2.63	3kHz

Bluetooth v4.2 LE

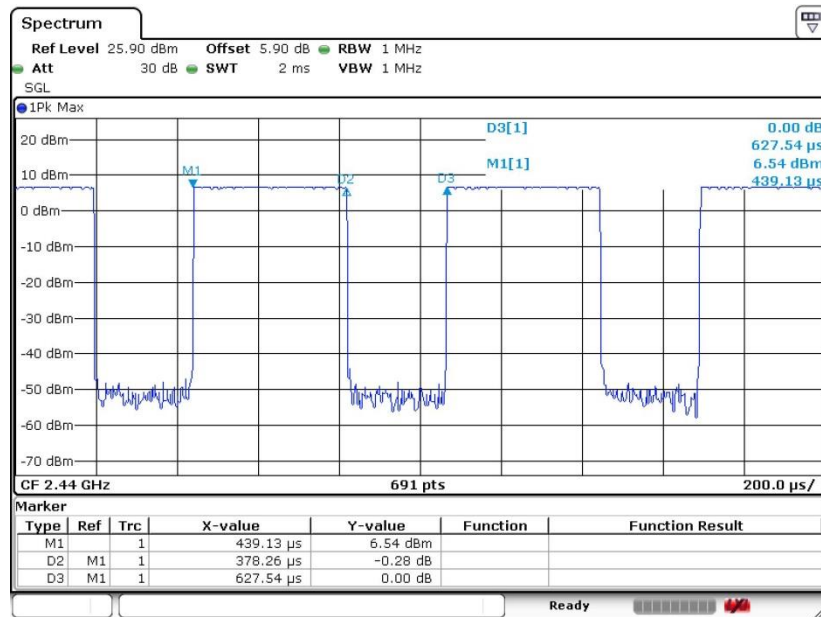



Appendix D. Product Equality Declaration

Motorola Mobility LLC.

222 W, Merchandise Mart Plaza, Chicago IL 60654 USA

Product Equality Declaration

We, Motorola Mobility LLC. declare on our sole responsibility for the product as below:

The differences between Latam DS (XT1763), Latam SS(XT1764), EMEA DS (XT1762), EMEA SS(XT1761), APAC DS (XT1760), AP-DS+B28(XT1769) as below:

■ RF section

1. Frequency band difference

<i>Bands/Modes</i>	<i>LatAm (XT1763)</i>	<i>LatAm (XT1764)</i>	<i>EMEA (XT1762)</i>	<i>EMEA (XT1761)</i>	<i>APAC (XT1760)</i>	<i>AP-DS+B28 (XT1769)</i>
<i>SIM Slots</i>	<i>DS</i>	<i>SS</i>	<i>DS</i>	<i>SS</i>	<i>DS</i>	<i>DS</i>
<i>Type name</i>	<i>M29DC</i>	<i>M29DC</i>	<i>M29DA</i>	<i>M29D9</i>	<i>M290D</i>	<i>M2C64</i>
<i>FCC Model</i>	<i>10715</i>	<i>10716</i>	<i>10714</i>	<i>10713</i>	<i>10509</i>	<i>11364</i>
<i>FCC ID</i>	<i>IHDT56WC4</i>	<i>IHDT56WC4</i>	<i>IHDT56WC6</i>	<i>IHDT56WC5</i>	<i>IHDT56WC7</i>	<i>IHDT56WC8</i>
<i>GSM 850</i>	<i>Y</i>	<i>Y</i>	<i>Y</i>	<i>Y</i>	<i>Y</i>	<i>Y</i>
<i>GSM 900</i>	<i>Y</i>	<i>Y</i>	<i>Y</i>	<i>Y</i>	<i>Y</i>	<i>Y</i>
<i>GSM 1800</i>	<i>Y</i>	<i>Y</i>	<i>Y</i>	<i>Y</i>	<i>Y</i>	<i>Y</i>
<i>GSM 1900</i>	<i>Y</i>	<i>Y</i>	<i>Y</i>	<i>Y</i>	<i>Y</i>	<i>Y</i>
<i>LTE 1</i>	<i>N</i>	<i>N</i>	<i>Y</i>	<i>Y</i>	<i>Y</i>	<i>Y</i>
<i>LTE 2</i>	<i>Y</i>	<i>Y</i>	<i>N</i>	<i>N</i>	<i>N</i>	<i>N</i>
<i>LTE 3</i>	<i>Y</i>	<i>Y</i>	<i>Y</i>	<i>Y</i>	<i>Y</i>	<i>Y</i>
<i>LTE 4</i>	<i>Y</i>	<i>Y</i>	<i>N</i>	<i>N</i>	<i>N</i>	<i>N</i>
<i>LTE 5</i>	<i>Y</i>	<i>Y</i>	<i>Y</i>	<i>Y</i>	<i>Y</i>	<i>Y</i>
<i>LTE 7</i>	<i>Y</i>	<i>Y</i>	<i>Y</i>	<i>Y</i>	<i>Y</i>	<i>Y</i>
<i>LTE 8</i>	<i>N</i>	<i>N</i>	<i>Y</i>	<i>Y</i>	<i>Y</i>	<i>Y</i>
<i>LTE 20</i>	<i>N</i>	<i>N</i>	<i>Y</i>	<i>Y</i>	<i>N</i>	<i>N</i>
<i>LTE 28</i>	<i>Y</i>	<i>Y</i>	<i>N</i>	<i>N</i>	<i>N</i>	<i>Y</i>
<i>LTE 38</i>	<i>N</i>	<i>N</i>	<i>Y</i>	<i>Y</i>	<i>N</i>	<i>N</i>
<i>LTE 40</i>	<i>N</i>	<i>N</i>	<i>Y</i>	<i>Y</i>	<i>Y</i>	<i>Y</i>
<i>WCDMA 1</i>	<i>Y</i>	<i>Y</i>	<i>Y</i>	<i>Y</i>	<i>Y</i>	<i>Y</i>
<i>WCDMA 2</i>	<i>Y</i>	<i>Y</i>	<i>Y</i>	<i>Y</i>	<i>Y</i>	<i>Y</i>
<i>WCDMA 4</i>	<i>Y</i>	<i>Y</i>	<i>N</i>	<i>N</i>	<i>N</i>	<i>N</i>
<i>WCDMA 5</i>	<i>Y</i>	<i>Y</i>	<i>Y</i>	<i>Y</i>	<i>Y</i>	<i>Y</i>
<i>WCDMA 8</i>	<i>Y</i>	<i>Y</i>	<i>Y</i>	<i>Y</i>	<i>Y</i>	<i>Y</i>
<i>WLAN 2.4GHz</i>	<i>Y</i>	<i>Y</i>	<i>Y</i>	<i>Y</i>	<i>Y</i>	<i>Y</i>
<i>Bluetooth</i>	<i>Y</i>	<i>Y</i>	<i>Y</i>	<i>Y</i>	<i>Y</i>	<i>Y</i>
<i>NFC</i>	<i>N</i>	<i>N</i>	<i>N</i>	<i>Y</i>	<i>N</i>	<i>N</i>

2. Board difference

		LatAm (XT1763)	LatAm (XT1764)	EMEA (XT1762)	EMEA (XT1761)	APAC (XT1760)	AP-DS+B28 (XT1769)
		DS	SS	DS	SS	DS	DS
		M29DC	M29DC	M29DA	M29D9	M290D	M2C64
		10715	10716	10714	10713	10509	11364
		IHDT56WC4	IHDT56WC4	IHDT56WC6	IHDT56WC5	IHDT56WC7	IHDT56WC8
WWAN	IC	MT6169	MT6169	MT6169	MT6169	MT6169	MT6169
	Component on PCB	some difference of population/depopulation to enable support of different cellular bands					
	Antenna	EMEA DS (XT1762), EMEA SS(XT1761) , APAC DS (XT1760) and AP-DS+B28(XT1769) are the same antenna pattern and matching; Latam DS (XT1763), Latam SS(XT1764) is different antenna pattern and matching compared above.					
BT	IC	MT6625L	MT6625L	MT6625L	MT6625L	MT6625L	MT6625L
	Component on PCB	Same across all SKUs					
	Antenna	EMEA DS (XT1762), EMEA SS(XT1761) , APAC DS (XT1760), Latam DS (XT1763), Latam SS(XT1764) and AP-DS+B28(XT1769) are the same antenna pattern and matching.					
WLAN 2.4GHz	IC	MT6625L	MT6625L	MT6625L	MT6625L	MT6625L	MT6625L
	Component on PCB	Same across all SKUs					
	Antenna	EMEA DS (XT1762), EMEA SS(XT1761) , APAC DS (XT1760), Latam DS (XT1763), Latam SS(XT1764) and AP-DS+B28(XT1769) are the same antenna pattern and matching.					
NFC	IC	Not support	Not support	Not support	PN548 Support	Not support	Not support
	Component on PCB	EMEA (XT1761for CE , 10713 for FCC)has NFC function					
	Antenna	Others has no NFC chipset and antenna except for EMEA (XT1761for CE , 10713 for FCC)					

■ SW section

For this particular Motorola project all SKUs will be sharing the same SW version. The main differences exist per SKUs are related to RF Bands supported (including here availability of CDMA RAT or not). Regarding the SW/FW, there is NOT much difference between SKUs. Note that specific features are enabled via MCFG depending on SIM Card inserted to device, as the lab tests are usually performed with a base FSG setup, we should not expect differences on the protocol level between all SKUs.

■ HW section

- WCDMA/LTE bands: Difference of population/depopulation on duplex, SPDT Switch and matching capacitance inductance to enable support of different cellular bands.
- RF trace: same across Latam DS (XT1763), Latam SS(XT1764), EMEA DS (XT1762), EMEA SS(XT1761),APAC DS (XT1760),AP-DS+B28(XT1769)SKUs.
- PCB layout: same across Latam DS (XT1763), Latam SS(XT1764), EMEA DS (XT1762), EMEA SS(XT1761),APAC DS (XT1760),AP-DS+B28(XT1769)SKUs.
- PCBA: for any DS/SS models under the same SKU the same PCBA will be used. For example, EMEA DS/SS(XT1762/XT1761) will share the same PCBA and the only difference is that SS model will have only one SIM slot. PCBA of each SKU is unique because the RF components will differ from SKU to SKU.
- WLAN/BT/GPS/Diversity antenna type, antenna pattern, antenna location, antenna matching value and chipset: Same across EMEA, APAC, LatAm sku and AP-DS+B28 sku.
- NFC antenna type, antenna pattern, antenna location and chipset: Only EMEA SS(XT1761) SKU support NFC.
- WWAN antenna, same pattern and matching for all EMEA, APAC and AP-DS+B28 skus; LatAm Sku is different compared with above WWAN antennas.

■ Mechanical section

There is no difference in mechanical design and materials used for all SKUs. There are differences in number of SIM's supported across different SKUs.

Region	Country / Sub-region	RF SKU	FCC Model	FCC ID	SIM	Memory
Latam	Latam	Latam-DS(XT1763)	10715	IHDT56WC4	DS	2+16G
	Latam	RoLA-SS(XT1764)	10716	IHDT56WC4	SS	2+16G
EMEA	EMEA	EMEA-DS(XT1762)	10714	IHDT56WC6	DS	2+16G
	EMEA	EMEA-SS NFC(XT1761)	10713	IHDT56WC5	SS	2+16G
APAC	APAC	AP-DS(XT1760)	10509	IHDT56WC7	DS	2+16G
	APAC	AP-DS+B28(XT1769)	11364	IHDT56WC8	DS	2+16G

Except listings above, the others are all the same.

Should you have any questions or comments regarding this matter, please have my best

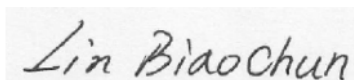

Contact Person: Lin Biaochun

COMPANY: Motorola Mobility LLC.

Tel:86-18150396560

E-Mail: Linbc@lenovo.com



Appendix E. Reference Report

Please refer to Sporton report number FR711913B which is issued separately.