

#01_GSM850_GPRS (4 Tx slots)_Left Cheek_Ch189

Communication System: GSM850; Frequency: 836.4 MHz; Duty Cycle: 1:2.08

Medium: HSL_850_170509 Medium parameters used: $f = 836.4$ MHz; $\sigma = 0.86$ mho/m; $\epsilon_r = 40.1$; $\rho = 1000$ kg/m³

Ambient Temperature : 23.3 °C ; Liquid Temperature : 22.3 °C

DASY4 Configuration:

- Probe: ES3DV3 - SN3270; ConvF(6.03, 6.03, 6.03); Calibrated: 2016/8/26
- Sensor-Surface: 3mm (Mechanical Surface Detection)
- Electronics: DAE4 Sn778; Calibrated: 2016/5/12
- Phantom: SAM_Right; Type: QD000P40CD; Serial: TP:1815
- ;Postprocessing SW: SEMCAD, V1.8 Build 159

Area Scan (71x121x1): Measurement grid: dx=15mm, dy=15mm

Maximum value of SAR (interpolated) = 0.153 mW/g

Zoom Scan (5x5x7)/Cube 0: Measurement grid: dx=8mm, dy=8mm, dz=5mm

Reference Value = 13.5 V/m; Power Drift = -0.116 dB

Peak SAR (extrapolated) = 0.165 W/kg

SAR(1 g) = 0.137 mW/g; SAR(10 g) = 0.111 mW/g

Maximum value of SAR (measured) = 0.147 mW/g

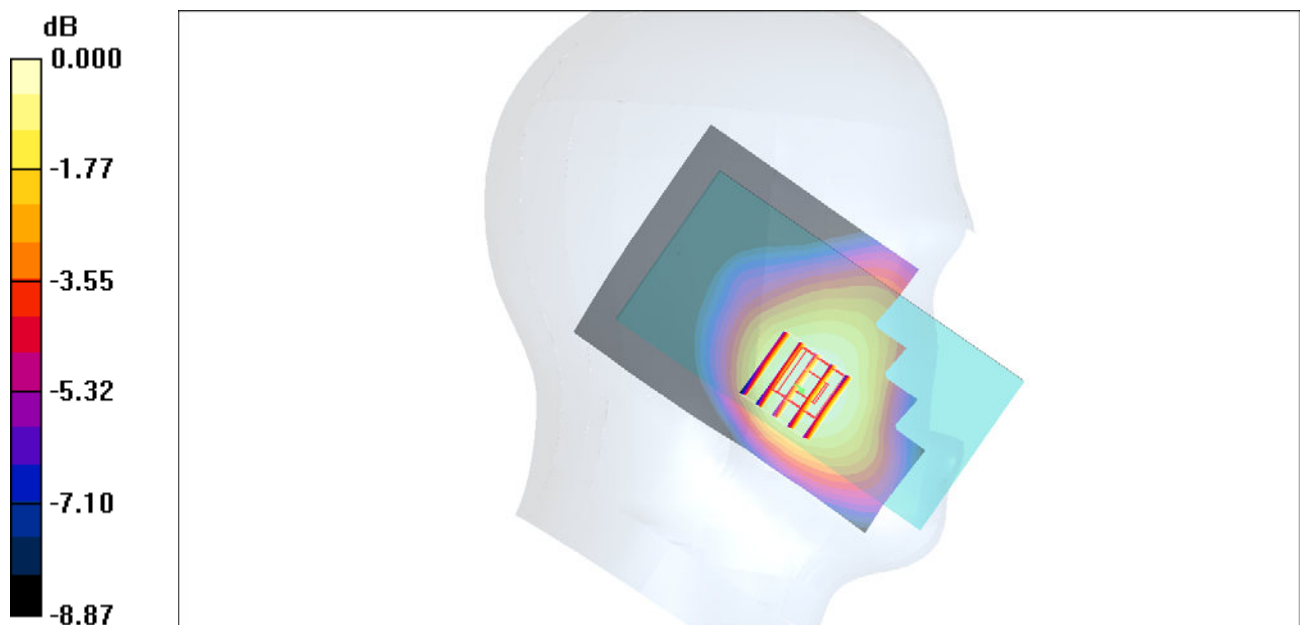

0 dB = 0.147mW/g

#02_GSM1900_GPRS (4 Tx slots)_Right Cheek_Ch512

Communication System: PCS; Frequency: 1850.2 MHz; Duty Cycle: 1:2.08

Medium: HSL_1900_170508 Medium parameters used: $f = 1850.2$ MHz; $\sigma = 1.37$ mho/m; $\epsilon_r = 40.1$;

$\rho = 1000$ kg/m³

Ambient Temperature : 23.9 °C ; Liquid Temperature : 22.9 °C

DASY4 Configuration:

- Probe: ES3DV3 - SN3270; ConvF(5.08, 5.08, 5.08); Calibrated: 2016/8/26

- Sensor-Surface: 3mm (Mechanical Surface Detection)

- Electronics: DAE4 Sn778; Calibrated: 2016/5/12

- Phantom: SAM_Right; Type: QD000P40CD; Serial: TP:1815

- ;Postprocessing SW: SEMCAD, V1.8 Build 159

Area Scan (71x121x1): Measurement grid: dx=15mm, dy=15mm

Maximum value of SAR (interpolated) = 0.158 mW/g

Zoom Scan (5x5x7)/Cube 0: Measurement grid: dx=8mm, dy=8mm, dz=5mm

Reference Value = 8.92 V/m; Power Drift = 0.066 dB

Peak SAR (extrapolated) = 0.187 W/kg

SAR(1 g) = 0.131 mW/g; SAR(10 g) = 0.084 mW/g

Maximum value of SAR (measured) = 0.150 mW/g

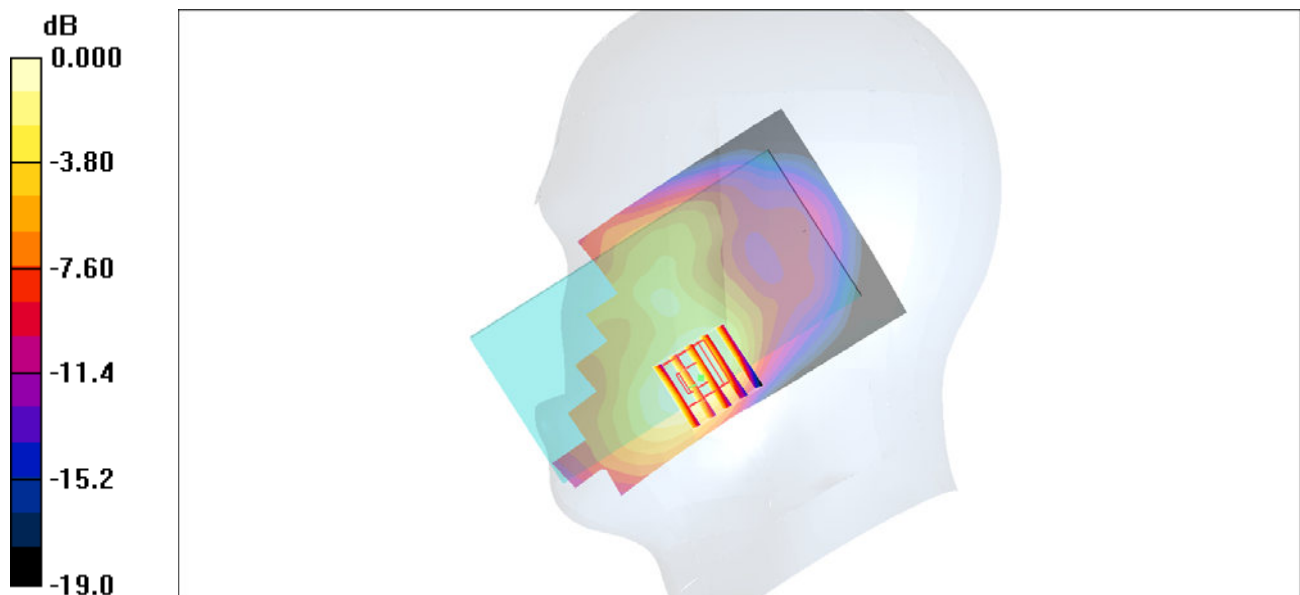

0 dB = 0.150mW/g

#03_WCDMA II_RMC 12.2Kbps_Right Cheek_Ch9262

Communication System: WCDMA; Frequency: 1852.4 MHz; Duty Cycle: 1:1

Medium: HSL_1900_170508 Medium parameters used: $f = 1852.4$ MHz; $\sigma = 1.38$ mho/m; $\epsilon_r = 40.1$;

$\rho = 1000$ kg/m³

Ambient Temperature : 23.9 °C ; Liquid Temperature : 22.9 °C

DASY4 Configuration:

- Probe: ES3DV3 - SN3270; ConvF(5.08, 5.08, 5.08); Calibrated: 2016/8/26
- Sensor-Surface: 3mm (Mechanical Surface Detection)
- Electronics: DAE4 Sn778; Calibrated: 2016/5/12
- Phantom: SAM_Right; Type: QD000P40CD; Serial: TP:1815
- ;Postprocessing SW: SEMCAD, V1.8 Build 159

Area Scan (71x121x1): Measurement grid: dx=15mm, dy=15mm

Maximum value of SAR (interpolated) = 0.306 mW/g

Zoom Scan (5x5x7)/Cube 0: Measurement grid: dx=8mm, dy=8mm, dz=5mm

Reference Value = 12.4 V/m; Power Drift = 0.082 dB

Peak SAR (extrapolated) = 0.360 W/kg

SAR(1 g) = 0.252 mW/g; SAR(10 g) = 0.162 mW/g

Maximum value of SAR (measured) = 0.285 mW/g

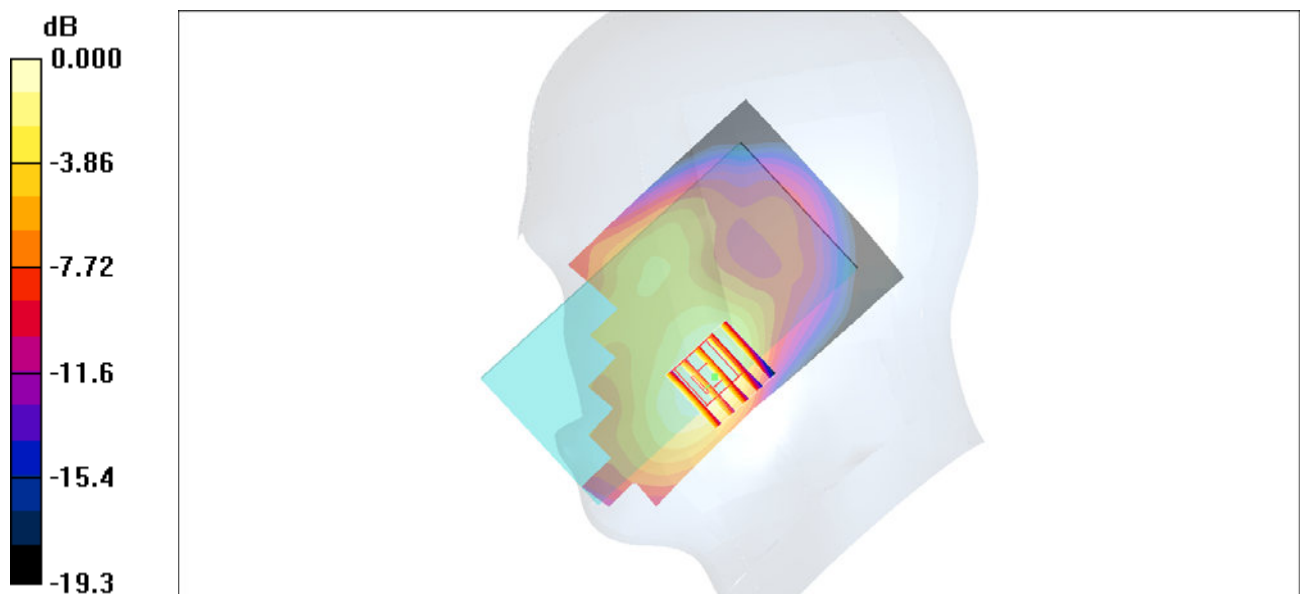

0 dB = 0.285mW/g

#04_WCDMA IV_RMC 12.2Kbps_Right Cheek_Ch1513

Communication System: WCDMA; Frequency: 1752.6 MHz; Duty Cycle: 1:1

Medium: HSL_1750_170509 Medium parameters used: $f = 1753$ MHz; $\sigma = 1.37$ mho/m; $\epsilon_r = 41.3$; $\rho = 1000$ kg/m³

Ambient Temperature : 23.3 °C; Liquid Temperature : 22.3 °C

DASY4 Configuration:

- Probe: ES3DV3 - SN3270; ConvF(5.21, 5.21, 5.21); Calibrated: 2016/8/26
- Sensor-Surface: 3mm (Mechanical Surface Detection)
- Electronics: DAE4 Sn778; Calibrated: 2016/5/12
- Phantom: SAM_Right; Type: QD000P40CD; Serial: TP:1815
- ;Postprocessing SW: SEMCAD, V1.8 Build 159

Area Scan (71x121x1): Measurement grid: dx=15mm, dy=15mm

Maximum value of SAR (interpolated) = 0.212 mW/g

Zoom Scan (5x5x7)/Cube 0: Measurement grid: dx=8mm, dy=8mm, dz=5mm

Reference Value = 10.8 V/m; Power Drift = -0.102 dB

Peak SAR (extrapolated) = 0.256 W/kg

SAR(1 g) = 0.182 mW/g; SAR(10 g) = 0.119 mW/g

Maximum value of SAR (measured) = 0.212 mW/g

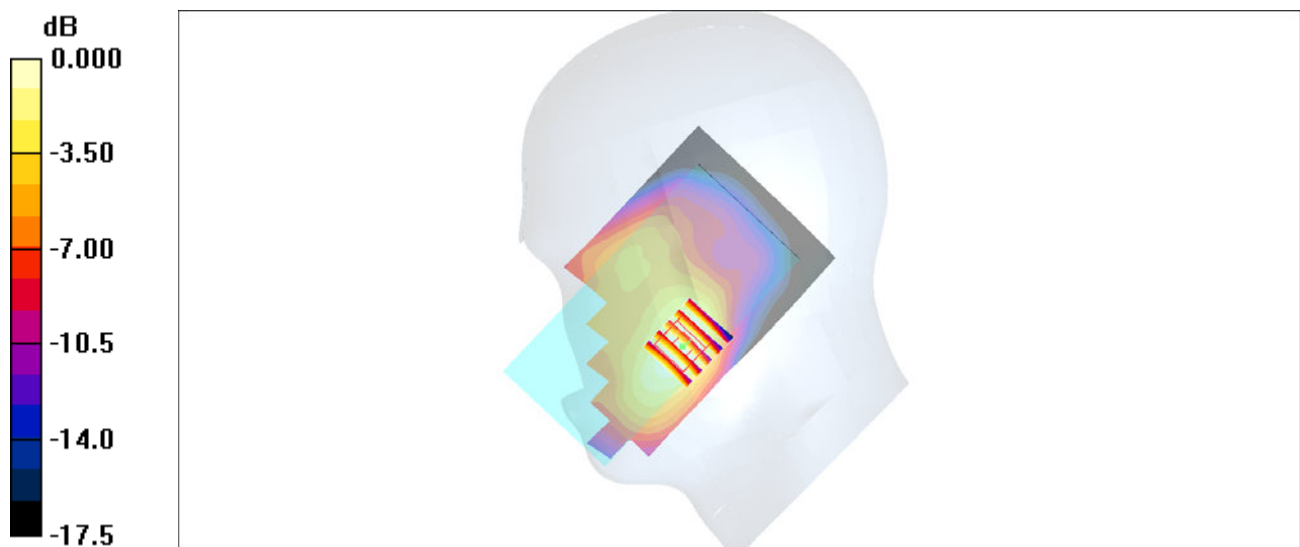

0 dB = 0.212mW/g

#05_WCDMA V_RMC 12.2Kbps_Left Cheek_Ch4132

Communication System: WCDMA; Frequency: 826.4 MHz; Duty Cycle: 1:1

Medium: HSL_850_170509 Medium parameters used: $f = 826.4$ MHz; $\sigma = 0.851$ mho/m; $\epsilon_r = 40.2$; $\rho = 1000$ kg/m³

Ambient Temperature : 23.3 °C; Liquid Temperature : 22.3 °C

DASY4 Configuration:

- Probe: ES3DV3 - SN3270; ConvF(6.03, 6.03, 6.03); Calibrated: 2016/8/26
- Sensor-Surface: 3mm (Mechanical Surface Detection)
- Electronics: DAE4 Sn778; Calibrated: 2016/5/12
- Phantom: SAM_Right; Type: QD000P40CD; Serial: TP:1815
- ;Postprocessing SW: SEMCAD, V1.8 Build 159

Area Scan (71x121x1): Measurement grid: dx=15mm, dy=15mm

Maximum value of SAR (interpolated) = 0.313 mW/g

Zoom Scan (5x5x7)/Cube 0: Measurement grid: dx=8mm, dy=8mm, dz=5mm

Reference Value = 19.2 V/m; Power Drift = 0.023 dB

Peak SAR (extrapolated) = 0.343 W/kg

SAR(1 g) = 0.286 mW/g; SAR(10 g) = 0.231 mW/g

Maximum value of SAR (measured) = 0.303 mW/g

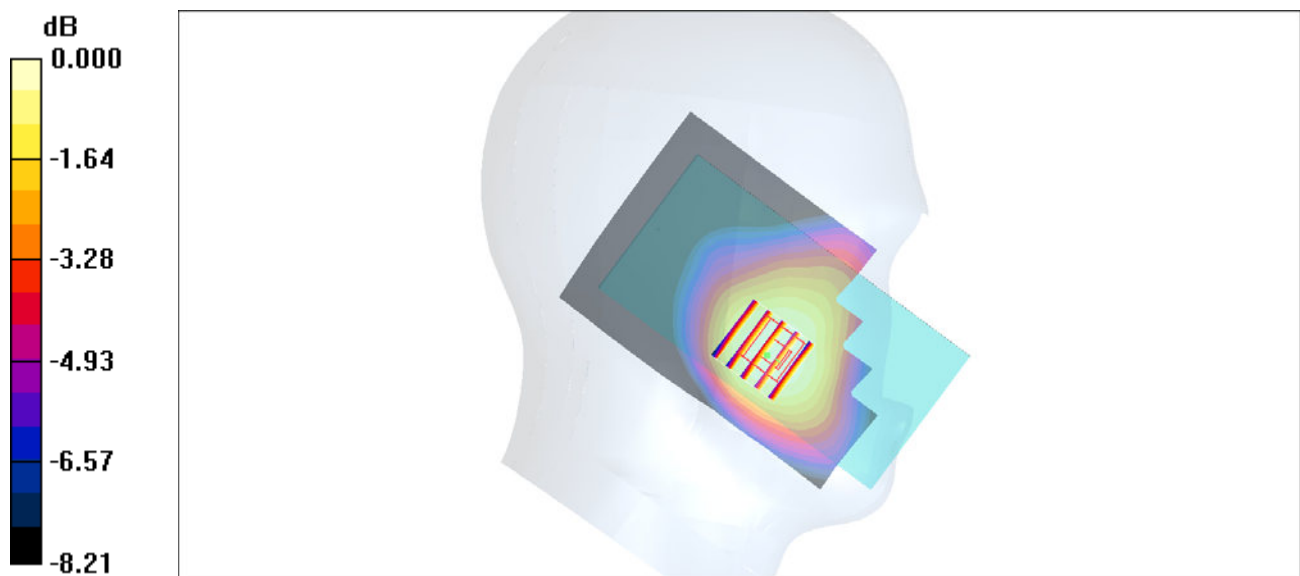

0 dB = 0.303mW/g

#06_CDMA BC0_1xRTT RC3 SO55_Right Cheek_Ch1013

Communication System: CDMA ; Frequency: 824.7 MHz; Duty Cycle: 1:1

Medium: HSL_850_170509 Medium parameters used: $f = 825$ MHz; $\sigma = 0.849$ mho/m; $\epsilon_r = 40.2$; $\rho = 1000$ kg/m³

Ambient Temperature : 23.3 °C ; Liquid Temperature : 22.3 °C

DASY4 Configuration:

- Probe: ES3DV3 - SN3270; ConvF(6.03, 6.03, 6.03); Calibrated: 2016/8/26
- Sensor-Surface: 3mm (Mechanical Surface Detection)
- Electronics: DAE4 Sn778; Calibrated: 2016/5/12
- Phantom: SAM_Right; Type: QD000P40CD; Serial: TP:1815
- ;Postprocessing SW: SEMCAD, V1.8 Build 159

Area Scan (71x121x1): Measurement grid: dx=15mm, dy=15mm

Maximum value of SAR (interpolated) = 0.447 mW/g

Zoom Scan (5x5x7)/Cube 0: Measurement grid: dx=8mm, dy=8mm, dz=5mm

Reference Value = 23.6 V/m; Power Drift = -0.162 dB

Peak SAR (extrapolated) = 0.560 W/kg

SAR(1 g) = 0.380 mW/g; SAR(10 g) = 0.265 mW/g

Maximum value of SAR (measured) = 0.439 mW/g

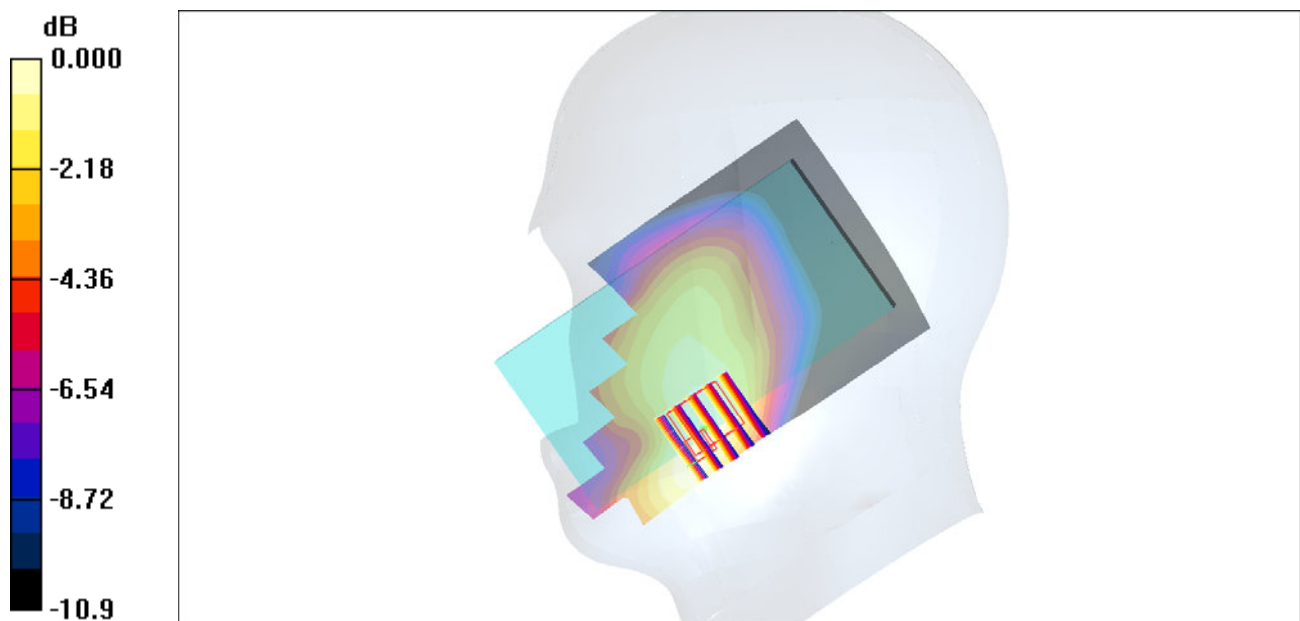

0 dB = 0.439mW/g

#07_CDMA BC1_1xRTT RC3 SO55_Right Cheek_Ch600

Communication System: CDMA ; Frequency: 1880 MHz;Duty Cycle: 1:1

Medium: HSL_1900_170508 Medium parameters used: $f = 1880$ MHz; $\sigma = 1.4$ mho/m; $\epsilon_r = 40$; $\rho = 1000$ kg/m³

Ambient Temperature : 23.9 °C ; Liquid Temperature : 22.9 °C

DASY4 Configuration:

- Probe: ES3DV3 - SN3270; ConvF(5.08, 5.08, 5.08); Calibrated: 2016/8/26
- Sensor-Surface: 3mm (Mechanical Surface Detection)
- Electronics: DAE4 Sn778; Calibrated: 2016/5/12
- Phantom: SAM_Right; Type: QD000P40CD; Serial: TP:1815
- ;Postprocessing SW: SEMCAD, V1.8 Build 159

Area Scan (71x121x1): Measurement grid: dx=15mm, dy=15mm

Maximum value of SAR (interpolated) = 0.373 mW/g

Zoom Scan (5x5x7)/Cube 0: Measurement grid: dx=8mm, dy=8mm, dz=5mm

Reference Value = 12.8 V/m; Power Drift = 0.029 dB

Peak SAR (extrapolated) = 0.429 W/kg

SAR(1 g) = 0.294 mW/g; SAR(10 g) = 0.187 mW/g

Maximum value of SAR (measured) = 0.343 mW/g

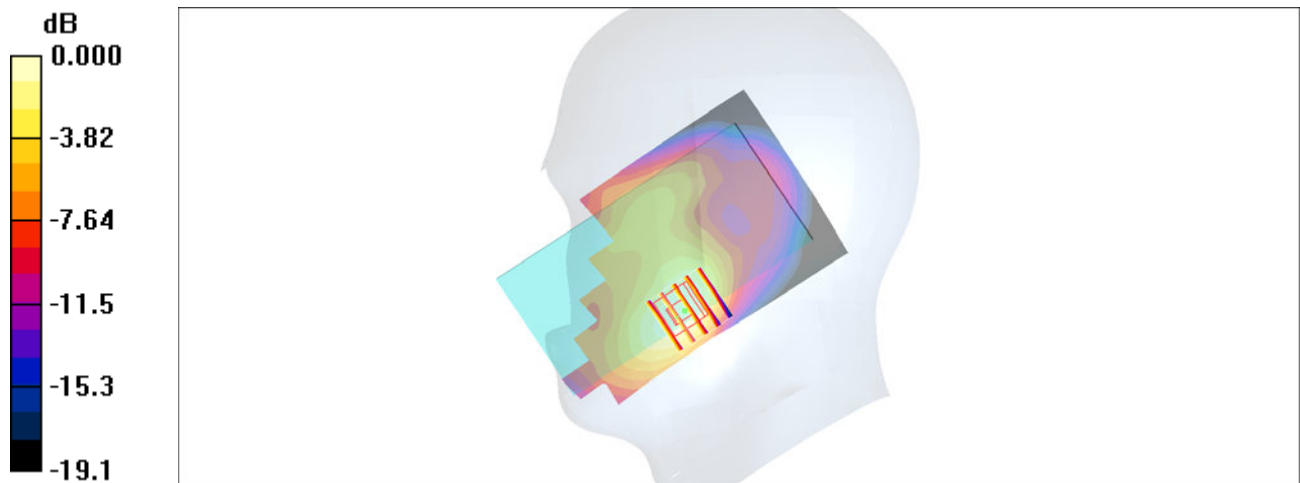

0 dB = 0.343mW/g

#08_CDMA BC10_1xRTT RC3 SO55_Right Cheek_Ch580

Communication System: CDMA ; Frequency: 820.5 MHz; Duty Cycle: 1:1
Medium: HSL_850_170509 Medium parameters used: $f = 820.5$ MHz; $\sigma = 0.845$ mho/m; $\epsilon_r = 40.3$; $\rho = 1000$ kg/m³
Ambient Temperature : 23.3 °C ; Liquid Temperature : 22.3 °C

DASY4 Configuration:

- Probe: ES3DV3 - SN3270; ConvF(6.03, 6.03, 6.03); Calibrated: 2016/8/26
- Sensor-Surface: 3mm (Mechanical Surface Detection)
- Electronics: DAE4 Sn778; Calibrated: 2016/5/12
- Phantom: SAM_Right; Type: QD000P40CD; Serial: TP:1815
- ;Postprocessing SW: SEMCAD, V1.8 Build 159

Area Scan (71x121x1): Measurement grid: dx=15mm, dy=15mm
Maximum value of SAR (interpolated) = 0.423 mW/g

Zoom Scan (5x5x7)/Cube 0: Measurement grid: dx=8mm, dy=8mm, dz=5mm
Reference Value = 22.4 V/m; Power Drift = 0.006 dB
Peak SAR (extrapolated) = 0.520 W/kg
SAR(1 g) = 0.355 mW/g; SAR(10 g) = 0.250 mW/g
Maximum value of SAR (measured) = 0.407 mW/g

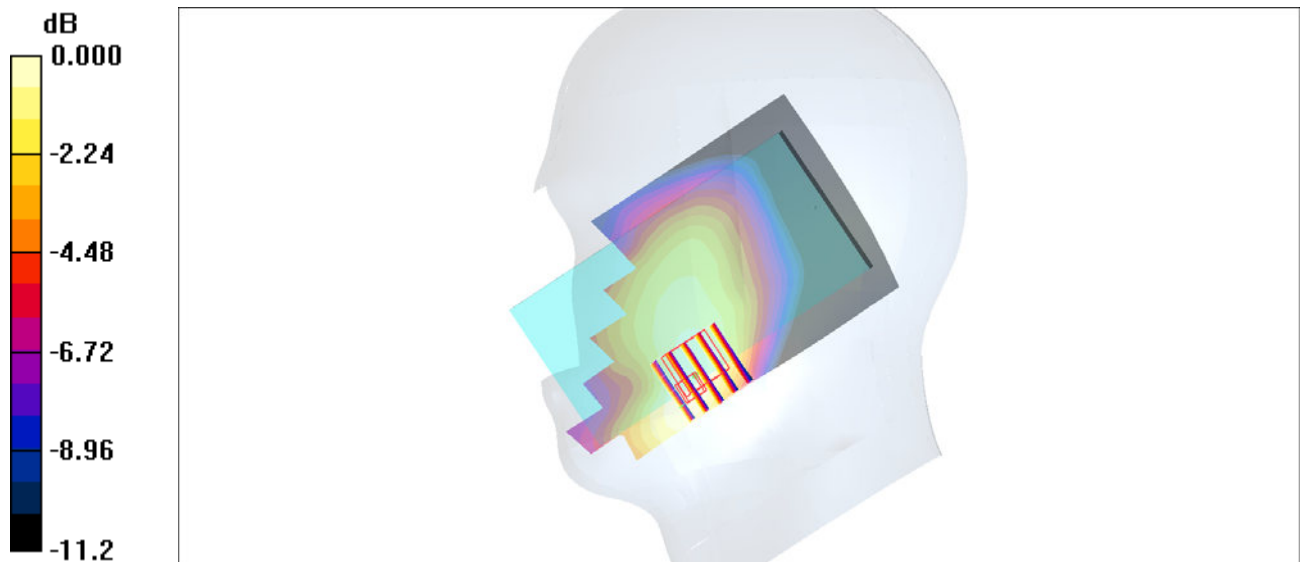

0 dB = 0.407mW/g

#09_LTE Band 2_20M_QPSK_1_0_Left Cheek_Ch19100

Communication System: LTE; Frequency: 1900 MHz; Duty Cycle: 1:1

Medium: HSL_1900_170508 Medium parameters used: $f = 1900$ MHz; $\sigma = 1.43$ mho/m; $\epsilon_r = 40$; $\rho = 1000$ kg/m³

Ambient Temperature : 23.9 °C; Liquid Temperature : 22.9 °C

DASY4 Configuration:

- Probe: ES3DV3 - SN3270; ConvF(5.08, 5.08, 5.08); Calibrated: 2016/8/26
- Sensor-Surface: 3mm (Mechanical Surface Detection)
- Electronics: DAE4 Sn778; Calibrated: 2016/5/12
- Phantom: SAM_Right; Type: QD000P40CD; Serial: TP:1815
- ;Postprocessing SW: SEMCAD, V1.8 Build 159

Area Scan (71x121x1): Measurement grid: dx=15mm, dy=15mm

Maximum value of SAR (interpolated) = 0.331 mW/g

Zoom Scan (5x5x7)/Cube 0: Measurement grid: dx=8mm, dy=8mm, dz=5mm

Reference Value = 11.9 V/m; Power Drift = 0.152 dB

Peak SAR (extrapolated) = 0.391 W/kg

SAR(1 g) = 0.265 mW/g; SAR(10 g) = 0.170 mW/g

Maximum value of SAR (measured) = 0.307 mW/g

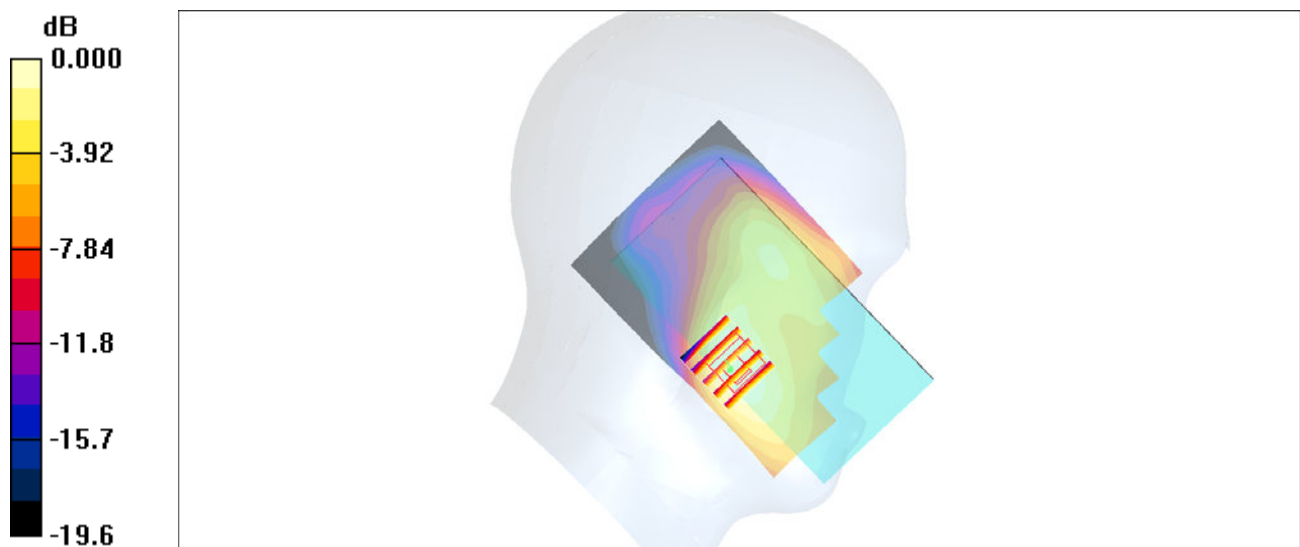

0 dB = 0.307mW/g

#10_LTE Band 4_20M_QPSK_1_0_Left Cheek_Ch20175

Communication System: LTE; Frequency: 1732.5 MHz; Duty Cycle: 1:1

Medium: HSL_1750_170509 Medium parameters used: $f = 1732.5$ MHz; $\sigma = 1.35$ mho/m; $\epsilon_r = 41.4$;

$\rho = 1000$ kg/m³

Ambient Temperature : 23.3 °C ; Liquid Temperature : 22.3 °C

DASY4 Configuration:

- Probe: ES3DV3 - SN3270; ConvF(5.21, 5.21, 5.21); Calibrated: 2016/8/26
- Sensor-Surface: 3mm (Mechanical Surface Detection)
- Electronics: DAE4 Sn778; Calibrated: 2016/5/12
- Phantom: SAM_Right; Type: QD000P40CD; Serial: TP:1815
- ;Postprocessing SW: SEMCAD, V1.8 Build 159

Area Scan (71x121x1): Measurement grid: dx=15mm, dy=15mm

Maximum value of SAR (interpolated) = 0.314 mW/g

Zoom Scan (5x5x7)/Cube 0: Measurement grid: dx=8mm, dy=8mm, dz=5mm

Reference Value = 12.0 V/m; Power Drift = 0.116 dB

Peak SAR (extrapolated) = 0.369 W/kg

SAR(1 g) = 0.262 mW/g; SAR(10 g) = 0.177 mW/g

Maximum value of SAR (measured) = 0.301 mW/g

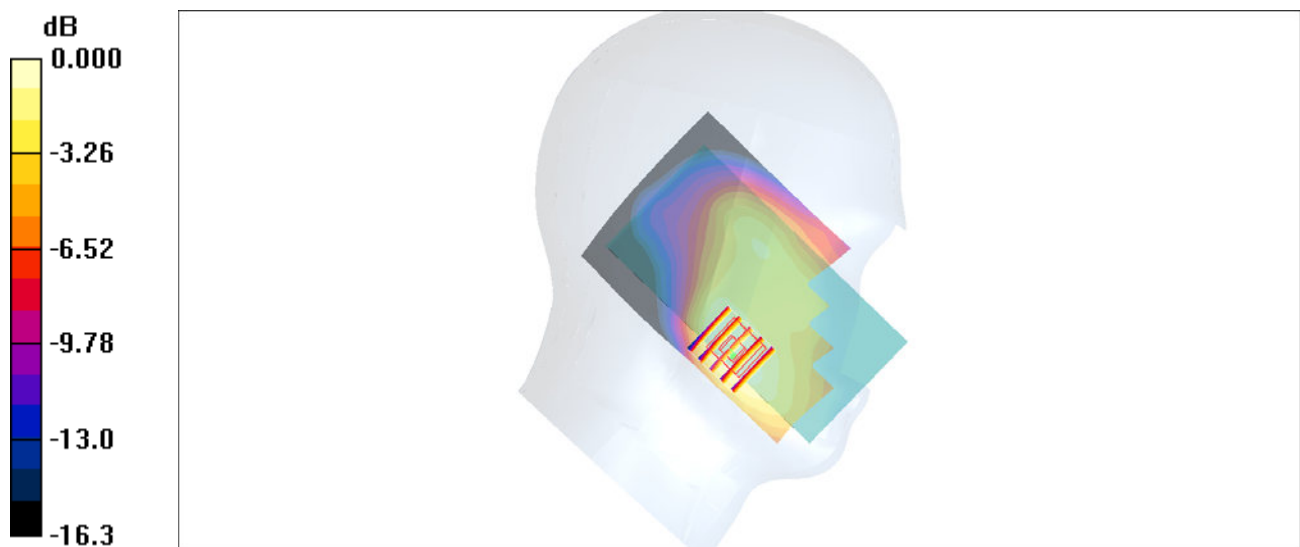

0 dB = 0.301mW/g

#11_LTE Band 5_10M_QPSK_1_0_Right Cheek_Ch20525

Communication System: LTE; Frequency: 836.5 MHz; Duty Cycle: 1:1

Medium: HSL_850_170509 Medium parameters used: $f = 836.5$ MHz; $\sigma = 0.86$ mho/m; $\epsilon_r = 40.1$; $\rho = 1000$ kg/m³

Ambient Temperature : 23.3 °C; Liquid Temperature : 22.3 °C

DASY4 Configuration:

- Probe: ES3DV3 - SN3270; ConvF(6.03, 6.03, 6.03); Calibrated: 2016/8/26
- Sensor-Surface: 3mm (Mechanical Surface Detection)
- Electronics: DAE4 Sn778; Calibrated: 2016/5/12
- Phantom: SAM_Right; Type: QD000P40CD; Serial: TP:1815
- ;Postprocessing SW: SEMCAD, V1.8 Build 159

Area Scan (71x121x1): Measurement grid: dx=15mm, dy=15mm

Maximum value of SAR (interpolated) = 0.367 mW/g

Zoom Scan (5x5x7)/Cube 0: Measurement grid: dx=8mm, dy=8mm, dz=5mm

Reference Value = 20.7 V/m; Power Drift = -0.048 dB

Peak SAR (extrapolated) = 0.449 W/kg

SAR(1 g) = 0.311 mW/g; SAR(10 g) = 0.217 mW/g

Maximum value of SAR (measured) = 0.354 mW/g

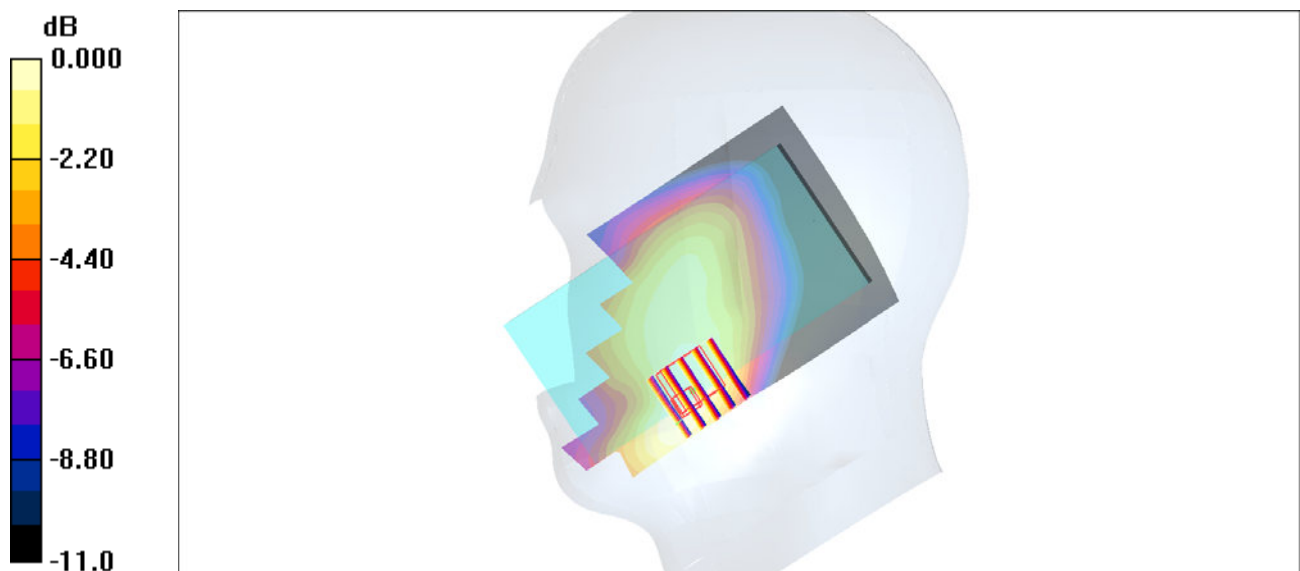

0 dB = 0.354mW/g

#12_LTE Band 7_20M_QPSK_1_0_Right Cheek_Ch21100

Communication System: LTE; Frequency: 2535 MHz; Duty Cycle: 1:1

Medium: HSL_2600_170514 Medium parameters used: $f = 2535$ MHz; $\sigma = 1.89$ S/m; $\epsilon_r = 39.484$; $\rho = 1000$ kg/m³

Ambient Temperature : 23.6 °C; Liquid Temperature : 22.6 °C

DASY5 Configuration

- Probe: EX3DV4 - SN7375; ConvF(7.27, 7.27, 7.27); Calibrated: 2016/12/8;
- Sensor-Surface: 1.4mm (Mechanical Surface Detection)
- Electronics: DAE4 Sn1305; Calibrated: 2016/12/15
- Phantom: SAM_RIGHT; Type: QD000P40CD; Serial: 1719
- Measurement SW: DASY52, Version 52.8 (8); SEMCAD X Version 14.6.10 (7373)

Area Scan (81x141x1): Interpolated grid: dx=1.200 mm, dy=1.200 mm

Maximum value of SAR (interpolated) = 0.580 W/kg

Zoom Scan (7x7x7)/Cube 0: Measurement grid: dx=5mm, dy=5mm, dz=5mm

Reference Value = 16.38 V/m; Power Drift = -0.15 dB

Peak SAR (extrapolated) = 0.619 W/kg

SAR(1 g) = 0.352 W/kg; SAR(10 g) = 0.188 W/kg

Maximum value of SAR (measured) = 0.530 W/kg

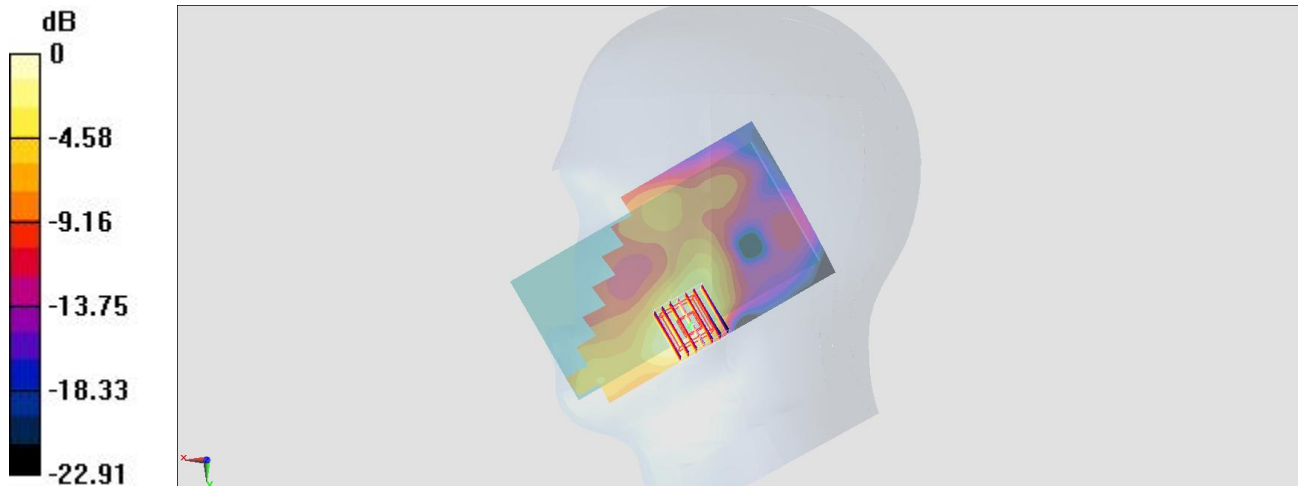

0 dB = 0.530 W/kg = -2.76 dBW/kg

#13_LTE Band 12_10M_QPSK_1_0_Right Cheek_Ch23095

Communication System: LTE; Frequency: 707.5 MHz; Duty Cycle: 1:1

Medium: HSL_750_170510 Medium parameters used: $f = 707.5$ MHz; $\sigma = 0.849$ mho/m; $\epsilon_r = 44.1$; $\rho = 1000$ kg/m³

Ambient Temperature : 23.2 °C ; Liquid Temperature : 22.2 °C

DASY4 Configuration:

- Probe: ES3DV3 - SN3270; ConvF(6.19, 6.19, 6.19); Calibrated: 2016/8/26
- Sensor-Surface: 3mm (Mechanical Surface Detection)
- Electronics: DAE4 Sn778; Calibrated: 2016/5/12
- Phantom: SAM_Right; Type: QD000P40CD; Serial: TP:1815
- ;Postprocessing SW: SEMCAD, V1.8 Build 159

Area Scan (71x121x1): Measurement grid: dx=15mm, dy=15mm

Maximum value of SAR (interpolated) = 0.247 mW/g

Zoom Scan (5x5x7)/Cube 0: Measurement grid: dx=8mm, dy=8mm, dz=5mm

Reference Value = 17.4 V/m; Power Drift = -0.005 dB

Peak SAR (extrapolated) = 0.309 W/kg

SAR(1 g) = 0.212 mW/g; SAR(10 g) = 0.145 mW/g

Maximum value of SAR (measured) = 0.241 mW/g

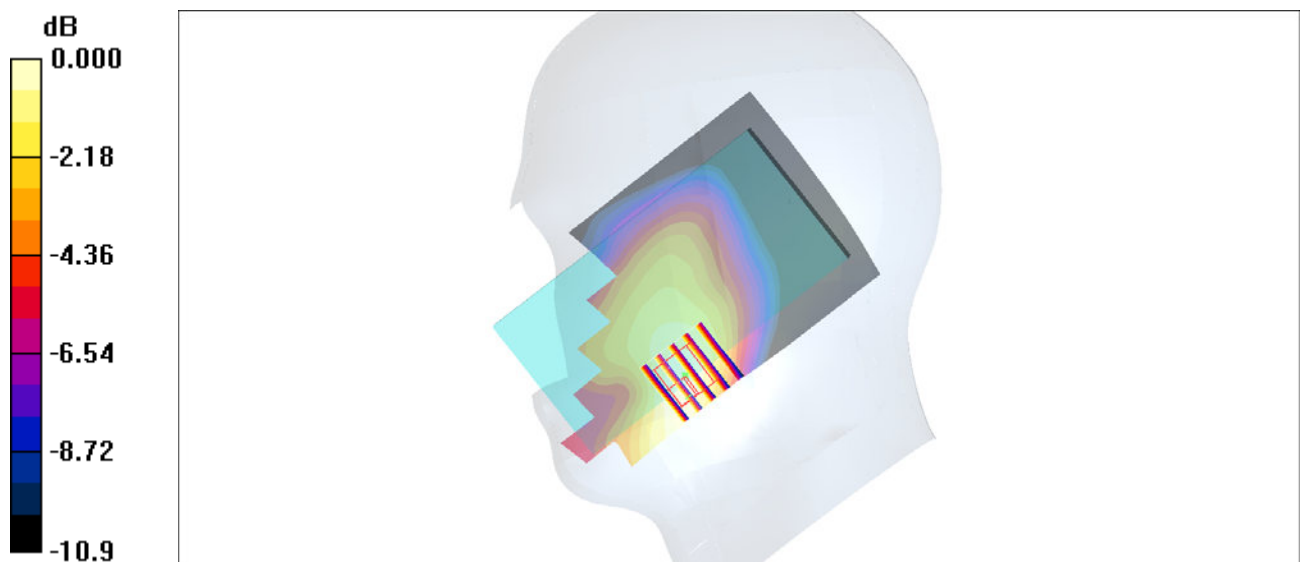

0 dB = 0.241mW/g

#14_LTE Band 17_10M_QPSK_1_0_Right Cheek_Ch23790

Communication System: LTE; Frequency: 710 MHz; Duty Cycle: 1:1

Medium: HSL_750_170510 Medium parameters used: $f = 710$ MHz; $\sigma = 0.852$ mho/m; $\epsilon_r = 44.1$; $\rho = 1000$ kg/m³

Ambient Temperature : 23.2 °C; Liquid Temperature : 22.2 °C

DASY4 Configuration:

- Probe: ES3DV3 - SN3270; ConvF(6.19, 6.19, 6.19); Calibrated: 2016/8/26
- Sensor-Surface: 3mm (Mechanical Surface Detection)
- Electronics: DAE4 Sn778; Calibrated: 2016/5/12
- Phantom: SAM_Right; Type: QD000P40CD; Serial: TP:1815
- ;Postprocessing SW: SEMCAD, V1.8 Build 159

Area Scan (71x121x1): Measurement grid: dx=15mm, dy=15mm

Maximum value of SAR (interpolated) = 0.252 mW/g

Zoom Scan (5x5x7)/Cube 0: Measurement grid: dx=8mm, dy=8mm, dz=5mm

Reference Value = 17.5 V/m; Power Drift = -0.079 dB

Peak SAR (extrapolated) = 0.313 W/kg

SAR(1 g) = 0.214 mW/g; SAR(10 g) = 0.147 mW/g

Maximum value of SAR (measured) = 0.245 mW/g

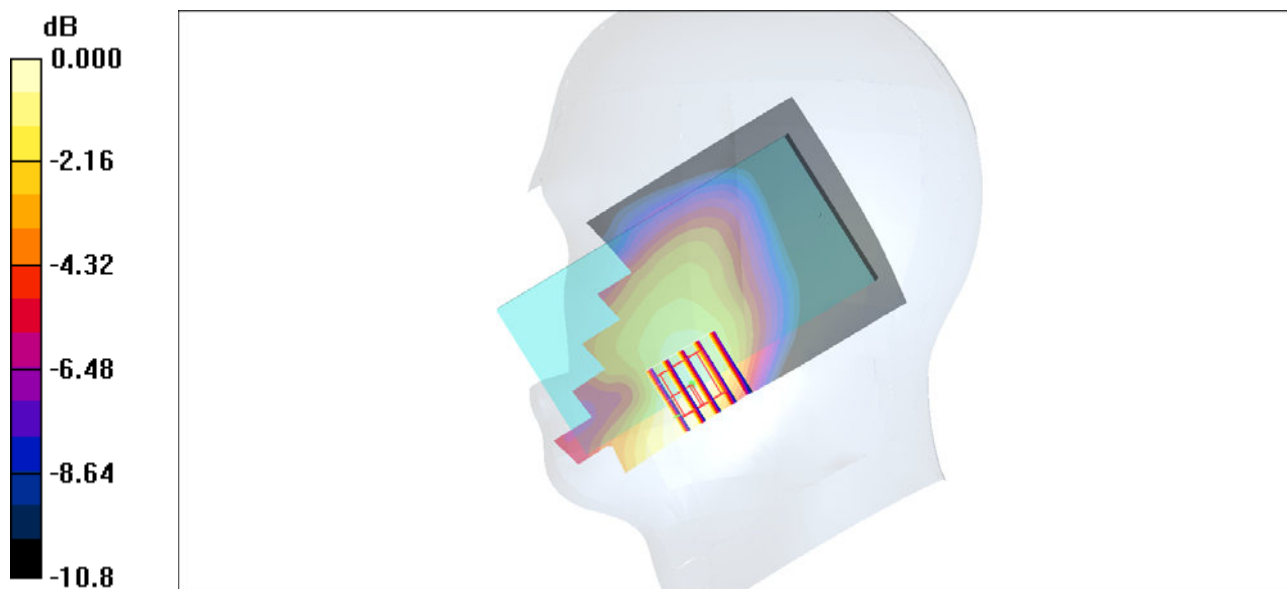

0 dB = 0.245mW/g

#15_LTE Band 26_15M_QPSK_1_0_Left Cheek_Ch26865

Communication System: LTE; Frequency: 831.5 MHz; Duty Cycle: 1:1

Medium: HSL_850_170509 Medium parameters used: $f = 831.5$ MHz; $\sigma = 0.855$ mho/m; $\epsilon_r = 40.1$; $\rho = 1000$ kg/m³

Ambient Temperature : 23.3 °C; Liquid Temperature : 22.3 °C

DASY4 Configuration:

- Probe: ES3DV3 - SN3270; ConvF(6.03, 6.03, 6.03); Calibrated: 2016/8/26
- Sensor-Surface: 3mm (Mechanical Surface Detection)
- Electronics: DAE4 Sn778; Calibrated: 2016/5/12
- Phantom: SAM_Right; Type: QD000P40CD; Serial: TP:1815
- ;Postprocessing SW: SEMCAD, V1.8 Build 159

Area Scan (71x121x1): Measurement grid: dx=15mm, dy=15mm

Maximum value of SAR (interpolated) = 0.375 mW/g

Zoom Scan (5x5x7)/Cube 0: Measurement grid: dx=8mm, dy=8mm, dz=5mm

Reference Value = 21.3 V/m; Power Drift = -0.015 dB

Peak SAR (extrapolated) = 0.406 W/kg

SAR(1 g) = 0.347 mW/g; SAR(10 g) = 0.282 mW/g

Maximum value of SAR (measured) = 0.368 mW/g

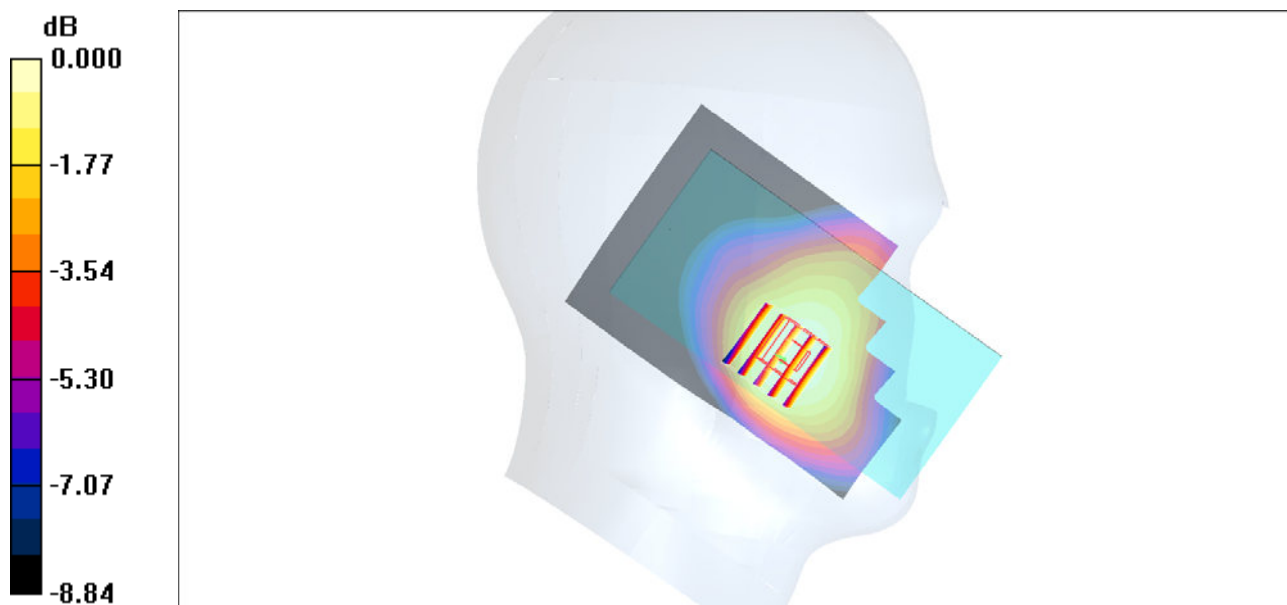

0 dB = 0.368mW/g

#16_LTE Band 38_20M_QPSK_1_0_Right Cheek_Ch37850

Communication System: LTE; Frequency: 2580 MHz; Duty Cycle: 1:1.59

Medium: HSL_2600_170514 Medium parameters used: $f = 2580$ MHz; $\sigma = 1.943$ S/m; $\epsilon_r = 39.305$; $\rho = 1000$ kg/m³

Ambient Temperature : 23.6 °C; Liquid Temperature : 22.6 °C

DASY5 Configuration

- Probe: EX3DV4 - SN7375; ConvF(7.25, 7.25, 7.25); Calibrated: 2016/12/8;
- Sensor-Surface: 1.4mm (Mechanical Surface Detection)
- Electronics: DAE4 Sn1305; Calibrated: 2016/12/15
- Phantom: SAM_RIGHT; Type: QD000P40CD; Serial: 1719
- Measurement SW: DASY52, Version 52.8 (8); SEMCAD X Version 14.6.10 (7373)

Area Scan (81x141x1): Interpolated grid: dx=1.200 mm, dy=1.200 mm

Maximum value of SAR (interpolated) = 0.307 W/kg

Zoom Scan (7x7x7)/Cube 0: Measurement grid: dx=5mm, dy=5mm, dz=5mm

Reference Value = 8.406 V/m; Power Drift = 0.06 dB

Peak SAR (extrapolated) = 0.298 W/kg

SAR(1 g) = 0.167 W/kg; SAR(10 g) = 0.089 W/kg

Maximum value of SAR (measured) = 0.247 W/kg

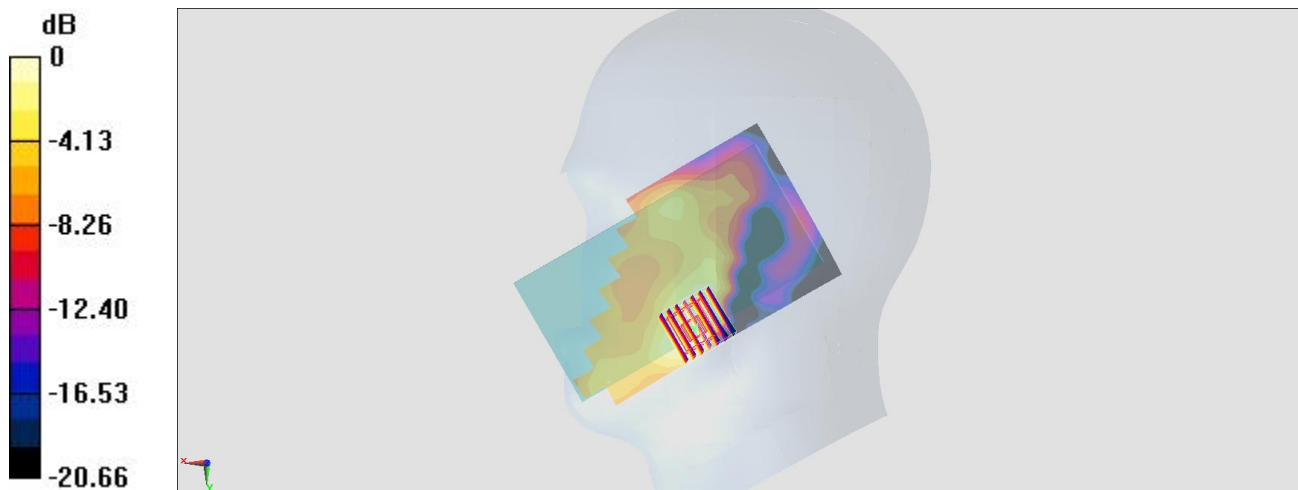

0 dB = 0.247 W/kg = -6.07 dBW/kg

#17_LTE Band 41_20M_QPSK_1_0_Right Cheek_Ch40770

Communication System: LTE; Frequency: 2608 MHz; Duty Cycle: 1:1.59

Medium: HSL_2600_170514 Medium parameters used: $f = 2608$ MHz; $\sigma = 1.975$ S/m; $\epsilon_r = 39.21$; $\rho = 1000$ kg/m³

Ambient Temperature : 23.6 °C; Liquid Temperature : 22.6 °C

DASY5 Configuration

- Probe: EX3DV4 - SN7375; ConvF(7.25, 7.25, 7.25); Calibrated: 2016/12/8;
- Sensor-Surface: 1.4mm (Mechanical Surface Detection)
- Electronics: DAE4 Sn1305; Calibrated: 2016/12/15
- Phantom: SAM_RIGHT; Type: QD000P40CD; Serial: 1719
- Measurement SW: DASY52, Version 52.8 (8); SEMCAD X Version 14.6.10 (7373)

Area Scan (81x141x1): Interpolated grid: dx=1.200 mm, dy=1.200 mm

Maximum value of SAR (interpolated) = 0.245 W/kg

Zoom Scan (7x7x7)/Cube 0: Measurement grid: dx=5mm, dy=5mm, dz=5mm

Reference Value = 7.489 V/m; Power Drift = -0.01 dB

Peak SAR (extrapolated) = 0.268 W/kg

SAR(1 g) = 0.148 W/kg; SAR(10 g) = 0.077 W/kg

Maximum value of SAR (measured) = 0.222 W/kg

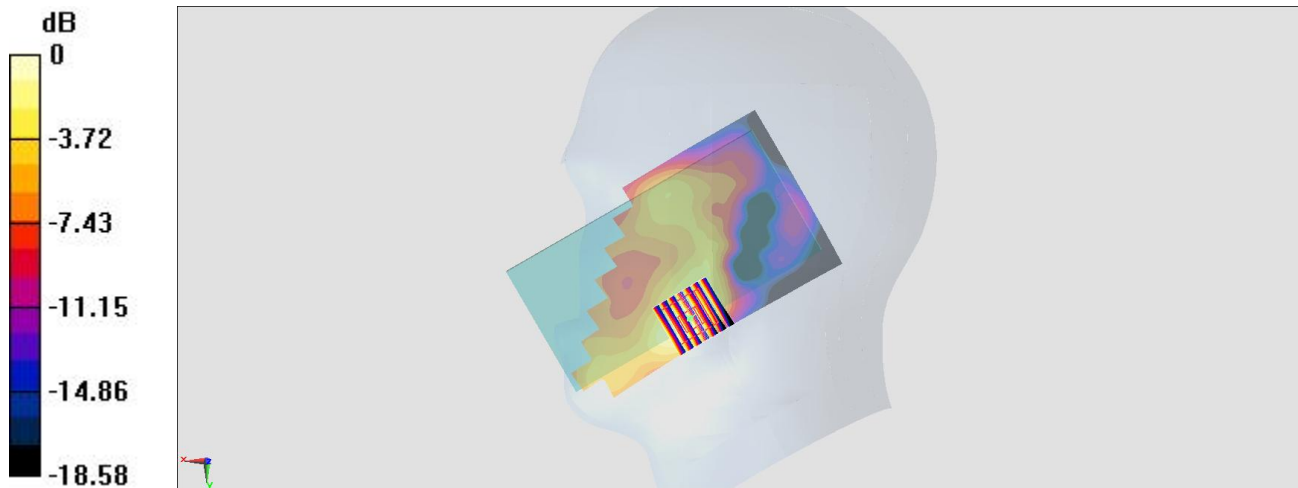

0 dB = 0.222 W/kg = -6.54 dBW/kg

#18_WLAN2.4GHz_802.11b 1Mbps_Left Cheek_Ch11;Ant 1

Communication System: 802.11b ; Frequency: 2462 MHz;Duty Cycle: 1:1

Medium: HSL_2450_170428 Medium parameters used: $f = 2462$ MHz; $\sigma = 1.79$ S/m; $\epsilon_r = 40.586$; $\rho = 1000$ kg/m³

Ambient Temperature : 23.4 °C ; Liquid Temperature : 22.4 °C

DASY5 Configuration:

- Probe: EX3DV4 - SN3931; ConvF(7.6, 7.6, 7.6); Calibrated: 2016/10/3;
- Sensor-Surface: 1.4mm (Mechanical Surface Detection)
- Electronics: DAE3 Sn577; Calibrated: 2016/9/28
- Phantom: SAM-Right; Type: SAM; Serial: TP-1303
- Measurement SW: DASY52, Version 52.8 (8);SEMCAD X Version 14.6.10 (7373)

Area Scan (91x151x1): Interpolated grid: dx=1.200 mm, dy=1.200 mm

Maximum value of SAR (interpolated) = 0.774 W/kg

Zoom Scan (7x7x7)/Cube 0: Measurement grid: dx=5mm, dy=5mm, dz=5mm

Reference Value = 18.18 V/m; Power Drift = -0.09 dB

Peak SAR (extrapolated) = 1.08 W/kg

SAR(1 g) = 0.548 W/kg; SAR(10 g) = 0.270 W/kg

Maximum value of SAR (measured) = 0.858 W/kg

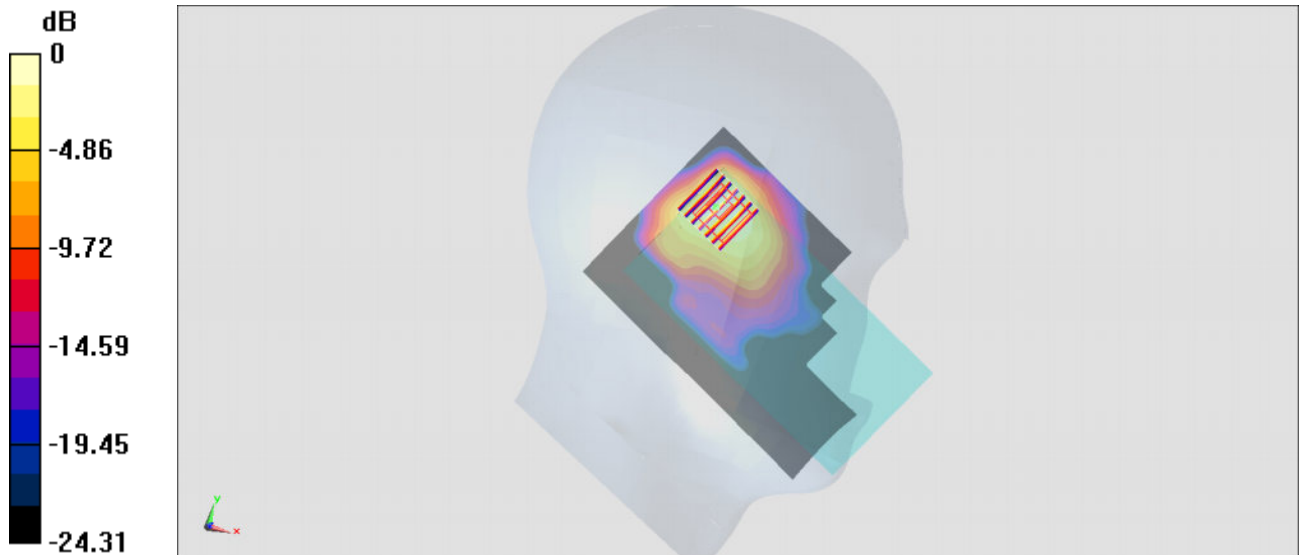

0 dB = 0.858 W/kg = -0.67 dBW/kg

#19_WLAN5GHz_802.11n-HT40 MCS0_Left Tilted_Ch54;Ant 1

Communication System: 802.11n ; Frequency: 5270 MHz;Duty Cycle: 1:1.116

Medium: HSL_5G_170428 Medium parameters used: $f = 5270$ MHz; $\sigma = 4.578$ S/m; $\epsilon_r = 37.347$; $\rho = 1000$ kg/m³

Ambient Temperature : 23.4 °C ; Liquid Temperature : 22.4 °C

DASY5 Configuration:

- Probe: EX3DV4 - SN3931; ConvF(5.38, 5.38, 5.38); Calibrated: 2016/10/3;
- Sensor-Surface: 1.4mm (Mechanical Surface Detection)
- Electronics: DAE3 Sn577; Calibrated: 2016/9/28
- Phantom: SAM-Right; Type: SAM; Serial: TP-1303
- Measurement SW: DASY52, Version 52.8 (8);SEMCAD X Version 14.6.10 (7373)

Area Scan (101x181x1): Interpolated grid: dx=1.000 mm, dy=1.000 mm

Maximum value of SAR (interpolated) = 1.02 W/kg

Zoom Scan (7x7x7)/Cube 0: Measurement grid: dx=4mm, dy=4mm, dz=1.4mm

Reference Value = 5.248 V/m; Power Drift = 0.03 dB

Peak SAR (extrapolated) = 1.74 W/kg

SAR(1 g) = 0.396 W/kg; SAR(10 g) = 0.121 W/kg

Maximum value of SAR (measured) = 0.981 W/kg

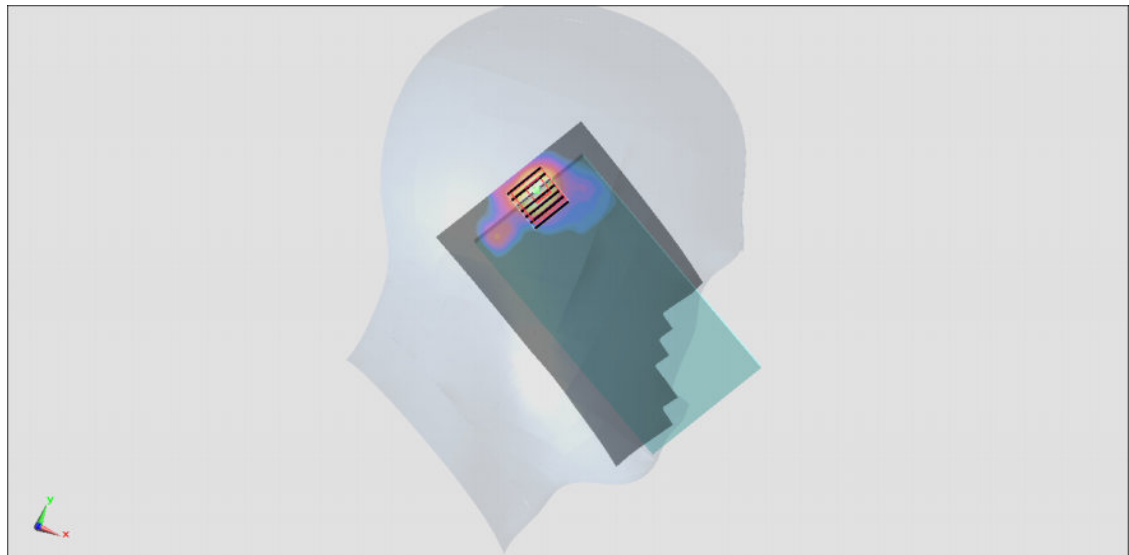
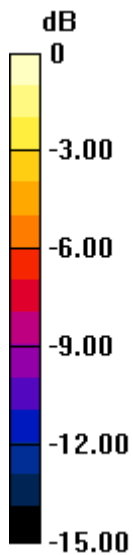

0 dB = 0.981 W/kg = -0.08 dBW/kg

#20_WLAN5GHz_802.11ac-VHT80 MCS0_Left Tilted_Ch106;Ant 1

Communication System: 802.11ac; Frequency: 5530 MHz; Duty Cycle: 1:1.156

Medium: HSL_5G_170416 Medium parameters used: $f = 5530$ MHz; $\sigma = 4.94$ mho/m; $\epsilon_r = 36.2$; $\rho = 1000$ kg/m³

Ambient Temperature : 23.8 °C; Liquid Temperature : 22.8 °C

DASY4 Configuration:

- Probe: EX3DV4 - SN3925; ConvF(4.66, 4.66, 4.66); Calibrated: 2016/5/26
- Sensor-Surface: 1.4mm (Mechanical Surface Detection)
- Electronics: DAE3 Sn495; Calibrated: 2016/5/27
- Phantom: SAM_Right; Type: QD000P40CD; Serial: TP:1815
- ;Postprocessing SW: SEMCAD, V1.8 Build 159

Area Scan (101x181x1): Measurement grid: dx=10mm, dy=10mm

Maximum value of SAR (interpolated) = 1.38 mW/g

Zoom Scan (7x7x7)/Cube 0: Measurement grid: dx=4mm, dy=4mm, dz=1.4mm

Reference Value = 6.02 V/m; Power Drift = 0.150 dB

Peak SAR (extrapolated) = 2.43 W/kg

SAR(1 g) = 0.527 mW/g; SAR(10 g) = 0.153 mW/g

Maximum value of SAR (measured) = 1.39 mW/g

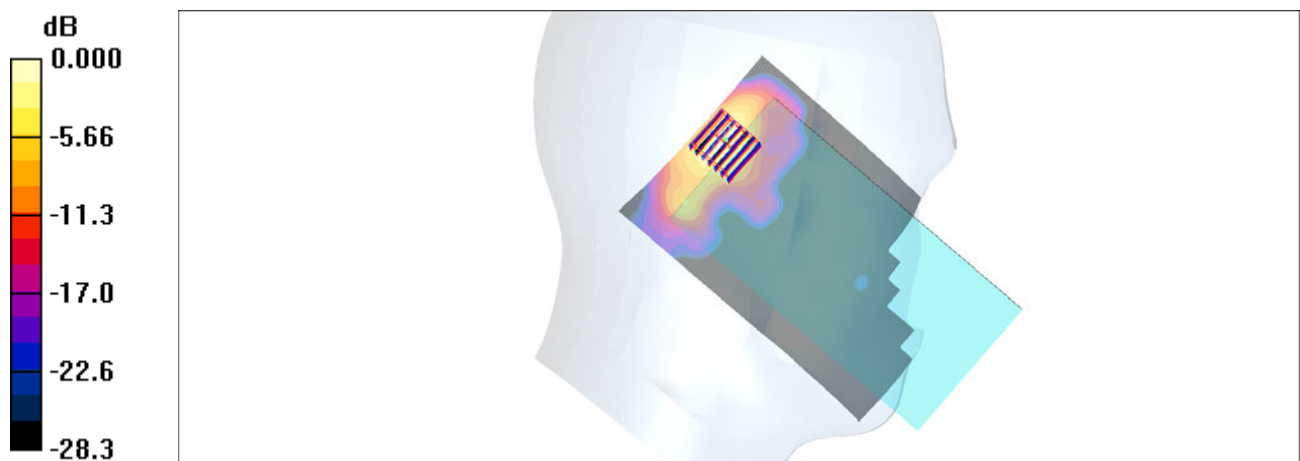

0 dB = 1.39mW/g

#21_WLAN5GHz_802.11ac-VHT80 MCS0_Right Tilted_Ch155;Ant 2

Communication System: 802.11ac; Frequency: 5775 MHz; Duty Cycle: 1:1.167

Medium: HSL_5G_170428 Medium parameters used: $f = 5775$ MHz; $\sigma = 5.091$ S/m; $\epsilon_r = 36.698$; $\rho = 1000$ kg/m³

Ambient Temperature : 23.4 °C ; Liquid Temperature : 22.4 °C

DASY5 Configuration:

- Probe: EX3DV4 - SN3931; ConvF(4.84, 4.84, 4.84); Calibrated: 2016/10/3;
- Sensor-Surface: 1.4mm (Mechanical Surface Detection)
- Electronics: DAE3 Sn577; Calibrated: 2016/9/28
- Phantom: SAM-Right; Type: SAM; Serial: TP-1303
- Measurement SW: DASY52, Version 52.8 (8); SEMCAD X Version 14.6.10 (7373)

Area Scan (101x181x1): Interpolated grid: dx=1.000 mm, dy=1.000 mm

Maximum value of SAR (interpolated) = 1.62 W/kg

Zoom Scan (7x7x7)/Cube 0: Measurement grid: dx=4mm, dy=4mm, dz=1.4mm

Reference Value = 6.806 V/m; Power Drift = -0.04 dB

Peak SAR (extrapolated) = 3.68 W/kg

SAR(1 g) = 0.713 W/kg; SAR(10 g) = 0.186 W/kg

Maximum value of SAR (measured) = 1.96 W/kg

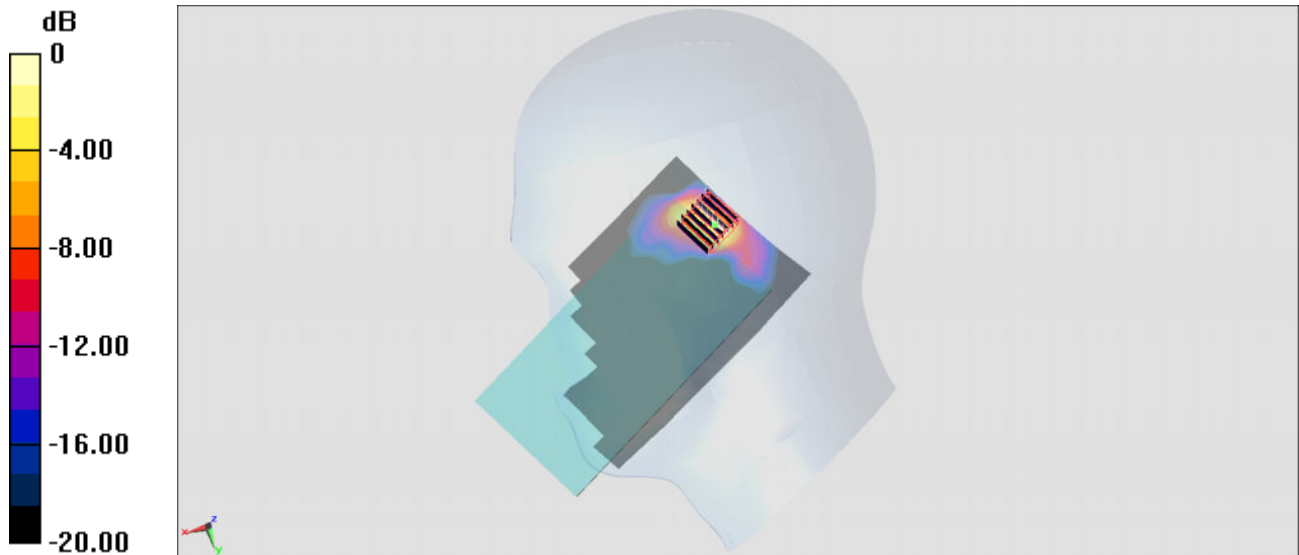

0 dB = 1.96 W/kg = 2.92 dBW/kg

#22_GSM850_GPRS (4 Tx slots)_Back_10mm_Ch189

Communication System: GSM850 ; Frequency: 836.4 MHz; Duty Cycle: 1:2.08

Medium: MSL_850_170517 Medium parameters used: $f = 836.4$ MHz; $\sigma = 0.962$ S/m; $\epsilon_r = 54.628$; $\rho = 1000$ kg/m³

Ambient Temperature : 23.4 °C ; Liquid Temperature : 22.4 °C

DASY5 Configuration:

- Probe: EX3DV4 - SN3976; ConvF(10.41, 10.41, 10.41); Calibrated: 2017/2/21;
- Sensor-Surface: 1.4mm (Mechanical Surface Detection)
- Electronics: DAE4 Sn1424; Calibrated: 2017/2/16
- Phantom: SAM-Right; Type: SAM; Serial: TP-1303
- Measurement SW: DASY52, Version 52.8 (8); SEMCAD X Version 14.6.10 (7373)

Area Scan (71x91x1): Interpolated grid: dx=1.500 mm, dy=1.500 mm

Maximum value of SAR (interpolated) = 0.710 W/kg

Zoom Scan (5x5x7)/Cube 0: Measurement grid: dx=8mm, dy=8mm, dz=5mm

Reference Value = 26.00 V/m; Power Drift = -0.06 dB

Peak SAR (extrapolated) = 0.890 W/kg

SAR(1 g) = 0.503 W/kg; SAR(10 g) = 0.296 W/kg

Maximum value of SAR (measured) = 0.729 W/kg

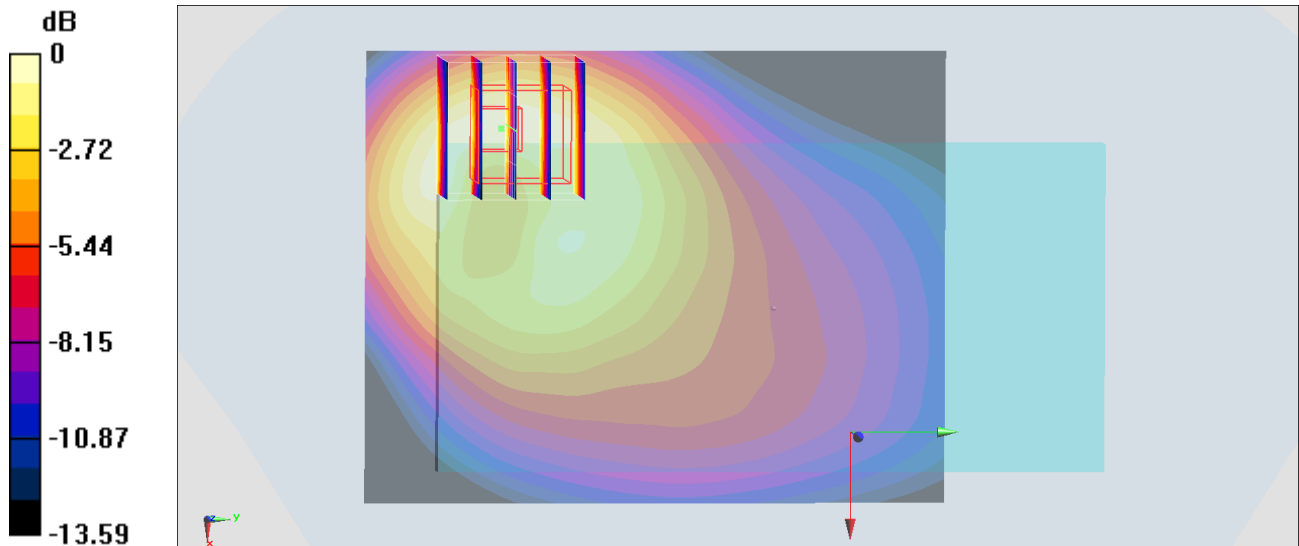

0 dB = 0.729 W/kg = -1.37 dBW/kg

#23_GSM1900_GPRS (4 Tx slots)_Bottom Side_10mm_Ch512

Communication System: PCS ; Frequency: 1850.2 MHz; Duty Cycle: 1:2.08

Medium: MSL_1900_170515 Medium parameters used: $f = 1850.2$ MHz; $\sigma = 1.515$ S/m; $\epsilon_r = 54.477$; $\rho = 1000$ kg/m³

Ambient Temperature : 23.4 °C ; Liquid Temperature : 22.4 °C

DASY5 Configuration:

- Probe: EX3DV4 - SN3976; ConvF(8.31, 8.31, 8.31); Calibrated: 2017/2/21;
- Sensor-Surface: 1.4mm (Mechanical Surface Detection)
- Electronics: DAE4 Sn1424; Calibrated: 2017/2/16
- Phantom: SAM-Right; Type: SAM; Serial: TP-1303
- Measurement SW: DASY52, Version 52.8 (8); SEMCAD X Version 14.6.10 (7373)

Area Scan (41x81x1): Interpolated grid: dx=1.500 mm, dy=1.500 mm

Maximum value of SAR (interpolated) = 0.618 W/kg

Zoom Scan (5x5x7)/Cube 0: Measurement grid: dx=8mm, dy=8mm, dz=5mm

Reference Value = 19.59 V/m; Power Drift = -0.08 dB

Peak SAR (extrapolated) = 0.682 W/kg

SAR(1 g) = 0.382 W/kg; SAR(10 g) = 0.213 W/kg

Maximum value of SAR (measured) = 0.569 W/kg

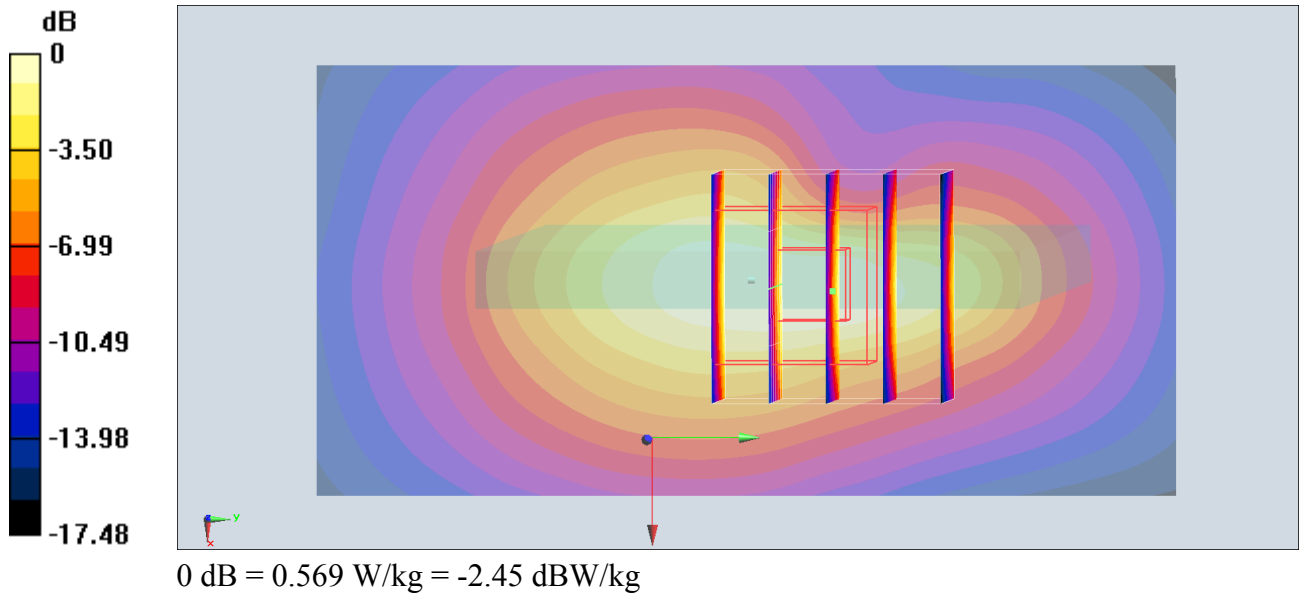

#24_WCDMA II_RMC 12.2Kbps_Bottom Side_10mm_Ch9262

Communication System: WCDMA ; Frequency: 1852.4 MHz;Duty Cycle: 1:1

Medium: MSL_1900_170512 Medium parameters used : $f = 1852.4$ MHz; $\sigma = 1.485$ S/m; $\epsilon_r = 54.114$; $\rho = 1000$ kg/m³

Ambient Temperature : 23.6 °C ; Liquid Temperature : 22.6 °C

DASY5 Configuration:

- Probe: EX3DV4 - SN3976; ConvF(8.31, 8.31, 8.31); Calibrated: 2017/2/21;
- Sensor-Surface: 1.4mm (Mechanical Surface Detection)
- Electronics: DAE4 Sn1424; Calibrated: 2017/2/16
- Phantom: SAM-Right; Type: SAM; Serial: TP-1303
- Measurement SW: DASY52, Version 52.8 (8);SEMCAD X Version 14.6.10 (7373)

Area Scan (41x81x1): Interpolated grid: dx=1.500 mm, dy=1.500 mm

Maximum value of SAR (interpolated) = 1.25 W/kg

Zoom Scan (5x5x7)/Cube 0: Measurement grid: dx=8mm, dy=8mm, dz=5mm

Reference Value = 28.50 V/m; Power Drift = 0.01 dB

Peak SAR (extrapolated) = 1.42 W/kg

SAR(1 g) = 0.792 W/kg; SAR(10 g) = 0.444 W/kg

Maximum value of SAR (measured) = 1.20 W/kg

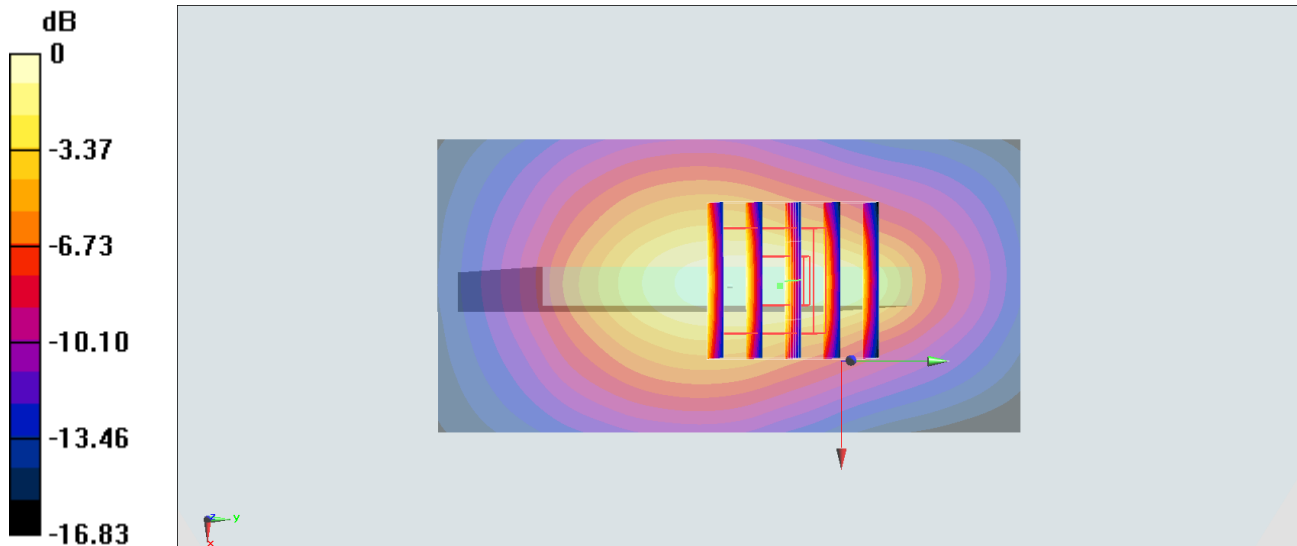

0 dB = 1.20 W/kg = 0.79 dBW/kg

#25_WCDMA IV_RMC 12.2Kbps_Back_10mm_Ch1413

Communication System: WCDMA; Frequency: 1732.6 MHz; Duty Cycle: 1:1

Medium: MSL_1750_170515 Medium parameters used: $f = 1733$ MHz; $\sigma = 1.468$ S/m; $\epsilon_r = 55.941$; $\rho = 1000$ kg/m³

Ambient Temperature : 23.4 °C ; Liquid Temperature : 22.4 °C

DASY5 Configuration:

- Probe: EX3DV4 - SN3976; ConvF(8.57, 8.57, 8.57); Calibrated: 2017/2/21;
- Sensor-Surface: 1.4mm (Mechanical Surface Detection)
- Electronics: DAE4 Sn1424; Calibrated: 2017/2/16
- Phantom: SAM-Right; Type: SAM; Serial: TP-1303
- Measurement SW: DASY52, Version 52.8 (8); SEMCAD X Version 14.6.10 (7373)

Area Scan (71x121x1): Interpolated grid: dx=1.500 mm, dy=1.500 mm

Maximum value of SAR (interpolated) = 1.01 W/kg

Zoom Scan (5x5x7)/Cube 0: Measurement grid: dx=8mm, dy=8mm, dz=5mm

Reference Value = 27.60 V/m; Power Drift = -0.06 dB

Peak SAR (extrapolated) = 1.16 W/kg

SAR(1 g) = 0.729 W/kg; SAR(10 g) = 0.460 W/kg

Maximum value of SAR (measured) = 0.966 W/kg

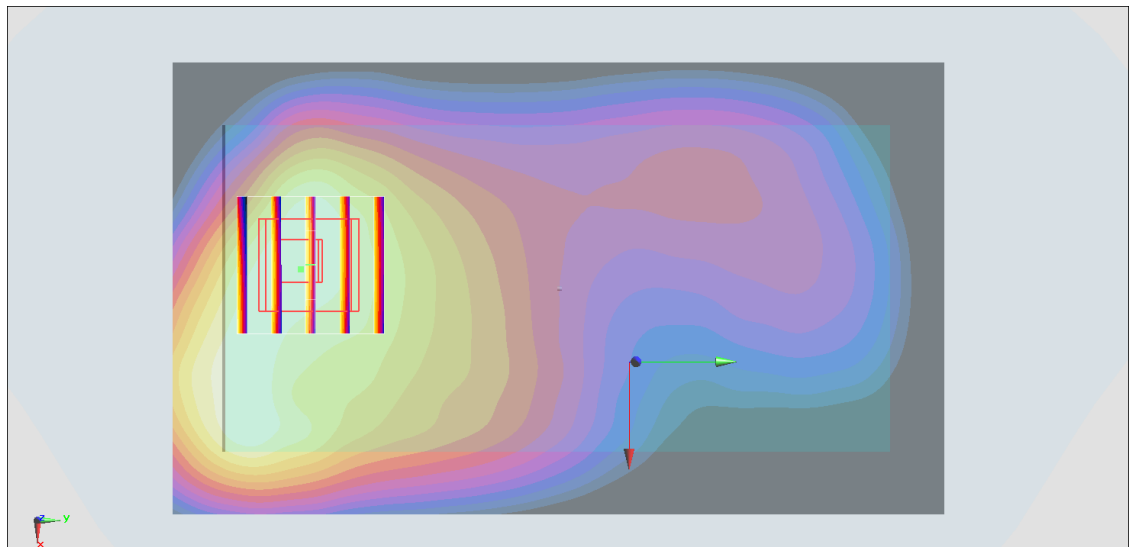
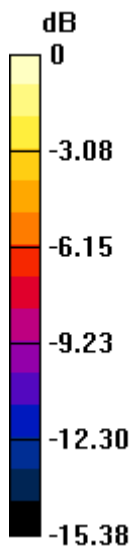

0 dB = 0.966 W/kg = -0.15 dBW/kg

#26_WCDMA V_RMC 12.2Kbps_Back_10mm_Ch4233

Communication System: WCDMA ; Frequency: 846.6 MHz; Duty Cycle: 1:1

Medium: MSL_850_170517 Medium parameters used: $f = 847$ MHz; $\sigma = 0.973$ S/m; $\epsilon_r = 54.524$; $\rho = 1000$ kg/m³

Ambient Temperature : 23.4 °C ; Liquid Temperature : 22.4 °C

DASY5 Configuration:

- Probe: EX3DV4 - SN3976; ConvF(10.41, 10.41, 10.41); Calibrated: 2017/2/21;
- Sensor-Surface: 1.4mm (Mechanical Surface Detection)
- Electronics: DAE4 Sn1424; Calibrated: 2017/2/16
- Phantom: SAM-Right; Type: SAM; Serial: TP-1303
- Measurement SW: DASY52, Version 52.8 (8); SEMCAD X Version 14.6.10 (7373)

Area Scan (71x81x1): Interpolated grid: dx=1.500 mm, dy=1.500 mm

Maximum value of SAR (interpolated) = 1.10 W/kg

Zoom Scan (5x5x7)/Cube 0: Measurement grid: dx=8mm, dy=8mm, dz=5mm

Reference Value = 31.43 V/m; Power Drift = -0.00 dB

Peak SAR (extrapolated) = 1.40 W/kg

SAR(1 g) = 0.776 W/kg; SAR(10 g) = 0.455 W/kg

Maximum value of SAR (measured) = 1.11 W/kg

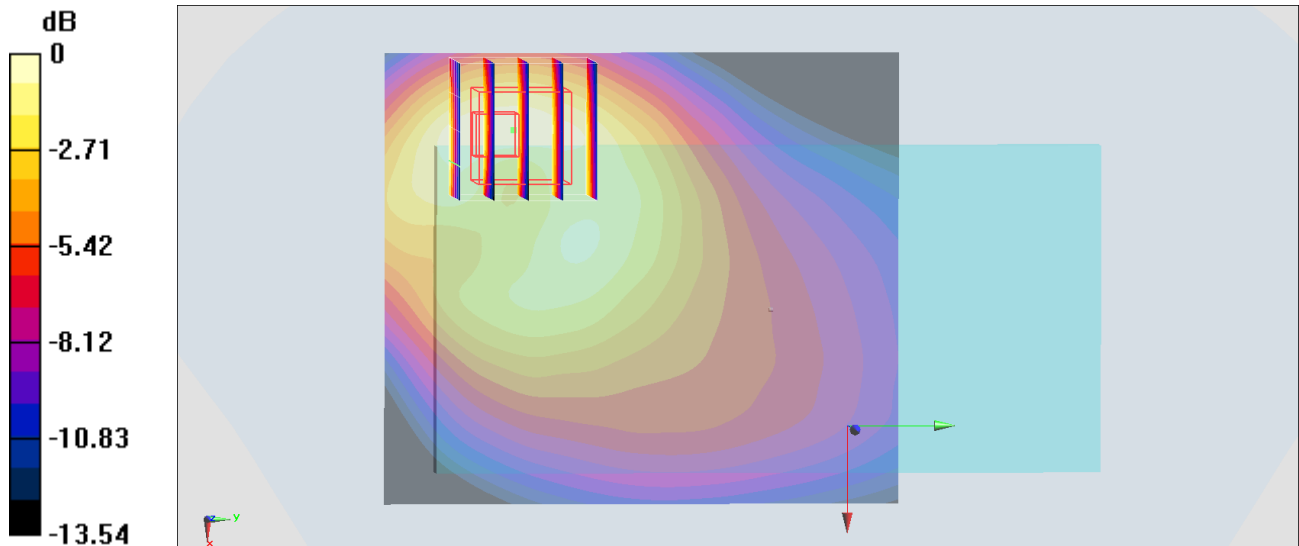

0 dB = 1.11 W/kg = 0.45 dBW/kg

#27_CDMA BC0_RTAP 153.6Kbps_Back_10mm_Ch777

Communication System: CDMA ; Frequency: 848.31 MHz; Duty Cycle: 1:1

Medium: MSL_850_170517 Medium parameters used: $f = 848.31$ MHz; $\sigma = 0.974$ S/m; $\epsilon_r = 54.512$; $\rho = 1000$ kg/m³

Ambient Temperature : 23.4 °C ; Liquid Temperature : 22.4 °C

DASY5 Configuration:

- Probe: EX3DV4 - SN3976; ConvF(10.41, 10.41, 10.41); Calibrated: 2017/2/21;
- Sensor-Surface: 1.4mm (Mechanical Surface Detection)
- Electronics: DAE4 Sn1424; Calibrated: 2017/2/16
- Phantom: SAM-Right; Type: SAM; Serial: TP-1303
- Measurement SW: DASY52, Version 52.8 (8); SEMCAD X Version 14.6.10 (7373)

Area Scan (71x101x1): Interpolated grid: dx=1.500 mm, dy=1.500 mm

Maximum value of SAR (interpolated) = 1.16 W/kg

Zoom Scan (5x5x7)/Cube 0: Measurement grid: dx=8mm, dy=8mm, dz=5mm

Reference Value = 32.61 V/m; Power Drift = 0.01 dB

Peak SAR (extrapolated) = 1.47 W/kg

SAR(1 g) = 0.817 W/kg; SAR(10 g) = 0.479 W/kg

Maximum value of SAR (measured) = 1.16 W/kg

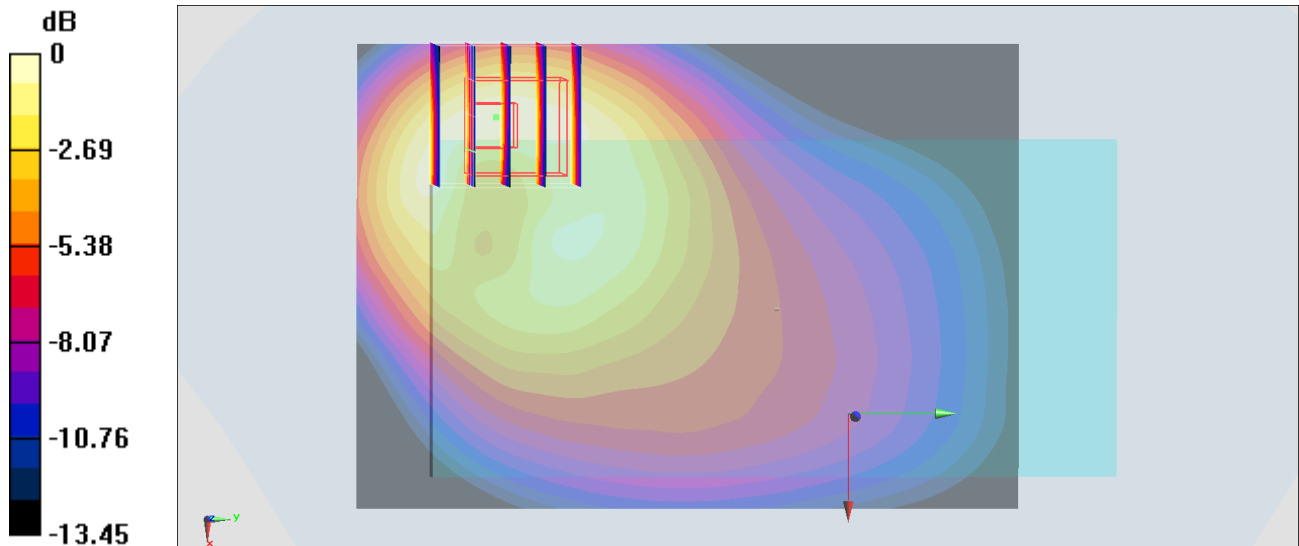

0 dB = 1.16 W/kg = 0.64 dBW/kg

#28_CDMA BC1_RTAP 153.6Kbps_Back_10mm_Ch25

Communication System: CDMA ; Frequency: 1851.25 MHz; Duty Cycle: 1:1

Medium: MSL_1900_170515 Medium parameters used : $f = 1851.25$ MHz; $\sigma = 1.516$ S/m; $\epsilon_r = 54.473$; $\rho = 1000$ kg/m³

Ambient Temperature : 23.4 °C ; Liquid Temperature : 22.4 °C

DASY5 Configuration:

- Probe: EX3DV4 - SN3976; ConvF(8.31, 8.31, 8.31); Calibrated: 2017/2/21;
- Sensor-Surface: 1.4mm (Mechanical Surface Detection)
- Electronics: DAE4 Sn1424; Calibrated: 2017/2/16
- Phantom: SAM-Right; Type: SAM; Serial: TP-1303
- Measurement SW: DASY52, Version 52.8 (8); SEMCAD X Version 14.6.10 (7373)

Area Scan (71x71x1): Interpolated grid: dx=1.500 mm, dy=1.500 mm

Maximum value of SAR (interpolated) = 1.29 W/kg

Zoom Scan (5x5x7)/Cube 0: Measurement grid: dx=8mm, dy=8mm, dz=5mm

Reference Value = 24.05 V/m; Power Drift = -0.01 dB

Peak SAR (extrapolated) = 1.37 W/kg

SAR(1 g) = 0.792 W/kg; SAR(10 g) = 0.423 W/kg

Maximum value of SAR (measured) = 1.11 W/kg

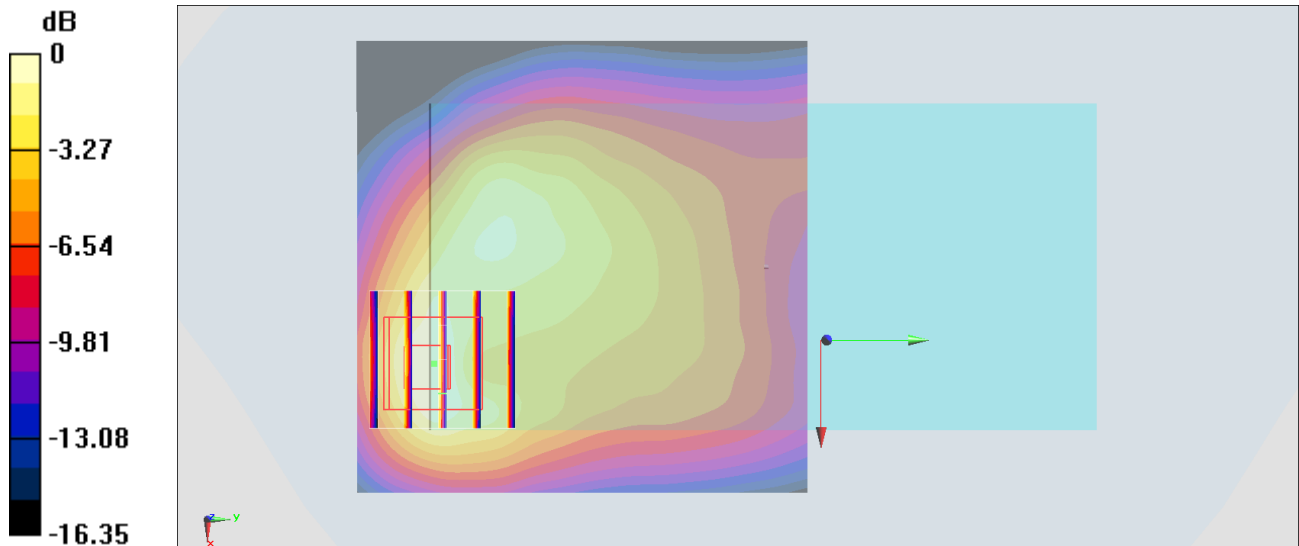

0 dB = 1.11 W/kg = 0.45 dBW/kg

#29_CDMA BC10_RTAP 153.6Kbps_Back_10mm_Ch580

Communication System: CDMA ; Frequency: 820.5 MHz; Duty Cycle: 1:1

Medium: MSL_850_170512 Medium parameters used: $f = 820.5$ MHz; $\sigma = 0.931$ S/m; $\epsilon_r = 54.51$; $\rho = 1000$ kg/m³

Ambient Temperature : 23.6 °C ; Liquid Temperature : 22.6 °C

DASY5 Configuration:

- Probe: EX3DV4 - SN3976; ConvF(10.41, 10.41, 10.41); Calibrated: 2017/2/21;
- Sensor-Surface: 1.4mm (Mechanical Surface Detection)
- Electronics: DAE4 Sn1424; Calibrated: 2017/2/16
- Phantom: SAM-Right; Type: SAM; Serial: TP-1303
- Measurement SW: DASY52, Version 52.8 (8); SEMCAD X Version 14.6.10 (7373)

Area Scan (71x121x1): Interpolated grid: dx=1.500 mm, dy=1.500 mm

Maximum value of SAR (interpolated) = 1.14 W/kg

Zoom Scan (5x5x7)/Cube 0: Measurement grid: dx=8mm, dy=8mm, dz=5mm

Reference Value = 34.76 V/m; Power Drift = 0.03 dB

Peak SAR (extrapolated) = 1.37 W/kg

SAR(1 g) = 0.751 W/kg; SAR(10 g) = 0.433 W/kg

Maximum value of SAR (measured) = 1.11 W/kg

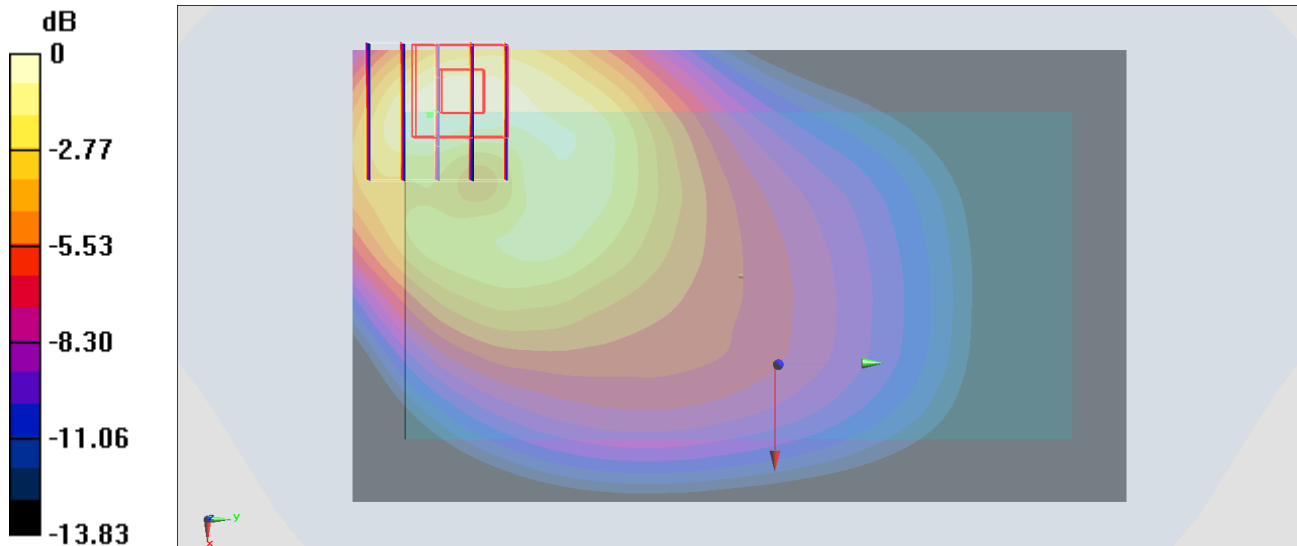

0 dB = 1.11 W/kg = 0.45 dBW/kg

#30_LTE Band 2_20M_QPSK_1_0_Bottom Side_10mm_Ch18900

Communication System: LTE ; Frequency: 1880 MHz;Duty Cycle: 1:1

Medium: MSL_1900_170512 Medium parameters used: $f = 1880$ MHz; $\sigma = 1.518$ S/m; $\epsilon_r = 54.01$; $\rho = 1000$ kg/m³

Ambient Temperature : 23.6 °C ; Liquid Temperature : 22.6 °C

DASY5 Configuration:

- Probe: EX3DV4 - SN3976; ConvF(8.31, 8.31, 8.31); Calibrated: 2017/2/21;
- Sensor-Surface: 1.4mm (Mechanical Surface Detection)
- Electronics: DAE4 Sn1424; Calibrated: 2017/2/16
- Phantom: SAM-Right; Type: SAM; Serial: TP-1303
- Measurement SW: DASY52, Version 52.8 (8);SEMCAD X Version 14.6.10 (7373)

Area Scan (41x81x1): Interpolated grid: dx=1.500 mm, dy=1.500 mm

Maximum value of SAR (interpolated) = 1.25 W/kg

Zoom Scan (5x5x7)/Cube 0: Measurement grid: dx=8mm, dy=8mm, dz=5mm

Reference Value = 28.19 V/m; Power Drift = -0.00 dB

Peak SAR (extrapolated) = 1.40 W/kg

SAR(1 g) = 0.781 W/kg; SAR(10 g) = 0.436 W/kg

Maximum value of SAR (measured) = 1.16 W/kg

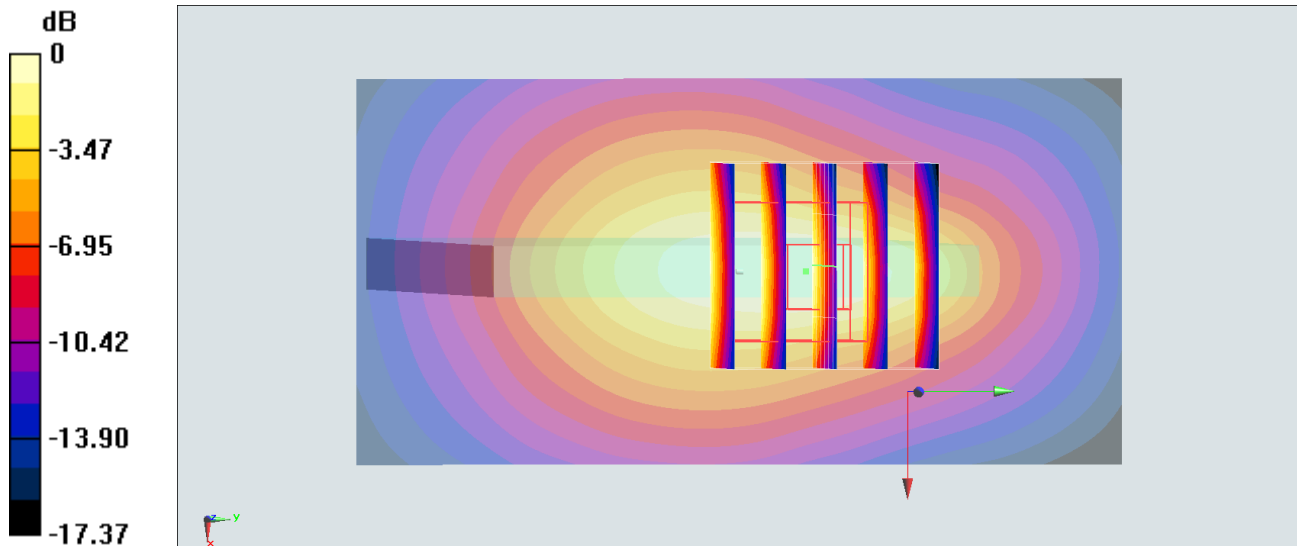

0 dB = 1.16 W/kg = 0.64 dBW/kg

#31_LTE Band 4_20M_QPSK_100_0_Back_10mm_Ch20175

Communication System: LTE; Frequency: 1732.5 MHz; Duty Cycle: 1:1

Medium: MSL_1750_170515 Medium parameters used: $f = 1732.5$ MHz; $\sigma = 1.468$ S/m; $\epsilon_r = 55.943$; $\rho = 1000$ kg/m³

Ambient Temperature : 23.4 °C ; Liquid Temperature : 22.4 °C

DASY5 Configuration:

- Probe: EX3DV4 - SN3976; ConvF(8.57, 8.57, 8.57); Calibrated: 2017/2/21;
- Sensor-Surface: 1.4mm (Mechanical Surface Detection)
- Electronics: DAE4 Sn1424; Calibrated: 2017/2/16
- Phantom: SAM-Right; Type: SAM; Serial: TP-1303
- Measurement SW: DASY52, Version 52.8 (8); SEMCAD X Version 14.6.10 (7373)

Area Scan (71x71x1): Interpolated grid: dx=1.500 mm, dy=1.500 mm

Maximum value of SAR (interpolated) = 1.06 W/kg

Zoom Scan (5x5x7)/Cube 0: Measurement grid: dx=8mm, dy=8mm, dz=5mm

Reference Value = 23.83 V/m; Power Drift = -0.02 dB

Peak SAR (extrapolated) = 1.14 W/kg

SAR(1 g) = 0.654 W/kg; SAR(10 g) = 0.371 W/kg

Maximum value of SAR (measured) = 0.895 W/kg

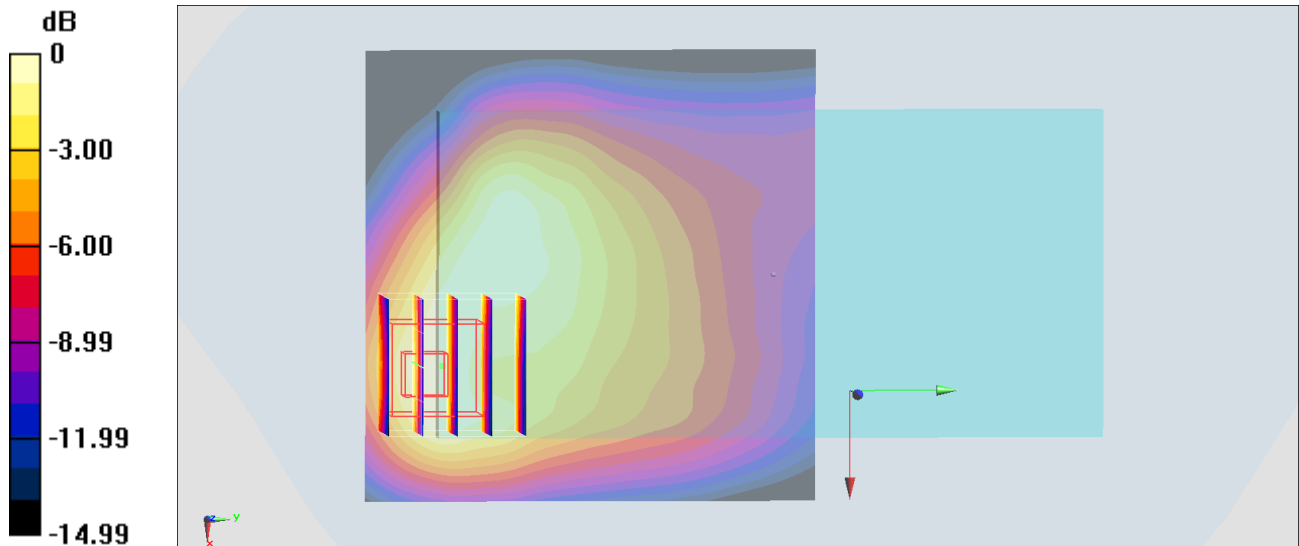

0 dB = 0.895 W/kg = -0.48 dBW/kg

#32_LTE Band 5_10M_QPSK_1_0_Back_10mm_Ch20525

Communication System: LTE; Frequency: 836.5 MHz; Duty Cycle: 1:1

Medium: MSL_850_170517 Medium parameters used: $f = 836.5$ MHz; $\sigma = 0.963$ S/m; $\epsilon_r = 54.627$; $\rho = 1000$ kg/m³

Ambient Temperature : 23.4 °C ; Liquid Temperature : 22.4 °C

DASY5 Configuration:

- Probe: EX3DV4 - SN3976; ConvF(10.41, 10.41, 10.41); Calibrated: 2017/2/21;
- Sensor-Surface: 1.4mm (Mechanical Surface Detection)
- Electronics: DAE4 Sn1424; Calibrated: 2017/2/16
- Phantom: SAM-Right; Type: SAM; Serial: TP-1303
- Measurement SW: DASY52, Version 52.8 (8); SEMCAD X Version 14.6.10 (7373)

Area Scan (71x81x1): Interpolated grid: dx=1.500 mm, dy=1.500 mm

Maximum value of SAR (interpolated) = 1.23 W/kg

Zoom Scan (5x5x7)/Cube 0: Measurement grid: dx=8mm, dy=8mm, dz=5mm

Reference Value = 33.40 V/m; Power Drift = -0.09 dB

Peak SAR (extrapolated) = 1.60 W/kg

SAR(1 g) = 0.836 W/kg; SAR(10 g) = 0.468 W/kg

Maximum value of SAR (measured) = 1.26 W/kg

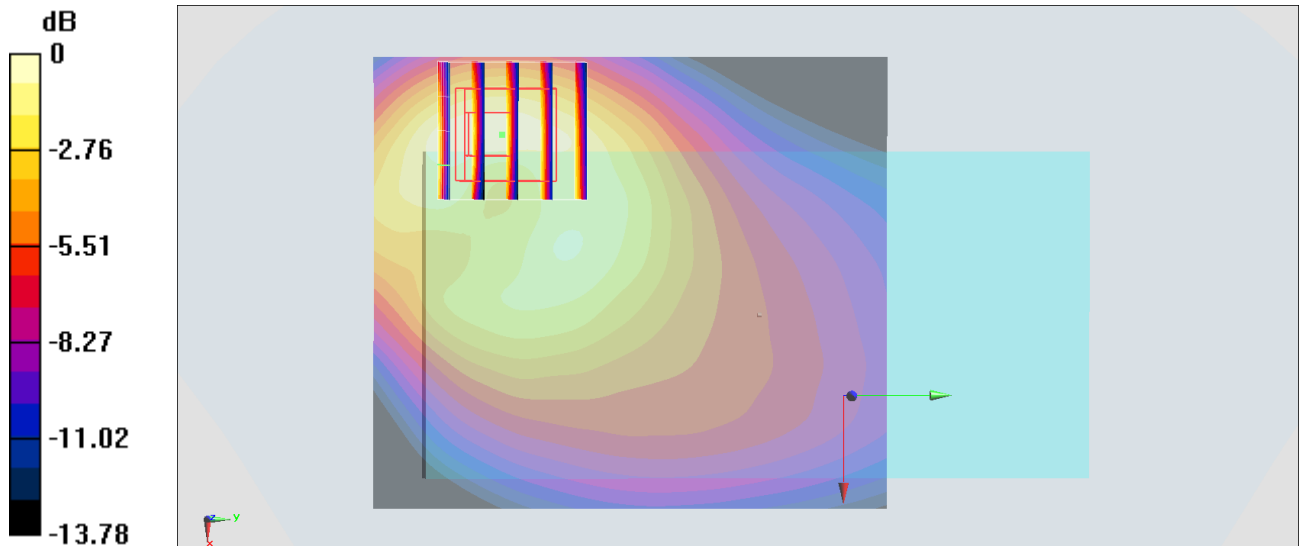

0 dB = 1.26 W/kg = 1.00 dBW/kg

#33_LTE Band 7_20M_QPSK_1_0_Front_10mm_Ch21100

Communication System: LTE ; Frequency: 2535 MHz;Duty Cycle: 1:1

Medium: MSL_2600_170513 Medium parameters used : $f = 2535$ MHz; $\sigma = 2.067$ S/m; $\epsilon_r = 52.467$; $\rho = 1000$ kg/m³

Ambient Temperature : 23.4 °C ; Liquid Temperature : 22.4 °C

DASY5 Configuration:

- Probe: EX3DV4 - SN3976; ConvF(7.59, 7.59, 7.59); Calibrated: 2017/2/21;
- Sensor-Surface: 1.4mm (Mechanical Surface Detection)
- Electronics: DAE4 Sn1424; Calibrated: 2017/2/16
- Phantom: SAM-Right; Type: SAM; Serial: TP-1303
- Measurement SW: DASY52, Version 52.8 (8);SEMCAD X Version 14.6.10 (7373)

Area Scan (91x81x1): Interpolated grid: dx=1.200 mm, dy=1.200 mm

Maximum value of SAR (interpolated) = 1.30 W/kg

Zoom Scan (7x7x7)/Cube 0: Measurement grid: dx=5mm, dy=5mm, dz=5mm

Reference Value = 19.12 V/m; Power Drift = -0.16 dB

Peak SAR (extrapolated) = 1.55 W/kg

SAR(1 g) = 0.807 W/kg; SAR(10 g) = 0.405 W/kg

Maximum value of SAR (measured) = 1.22 W/kg

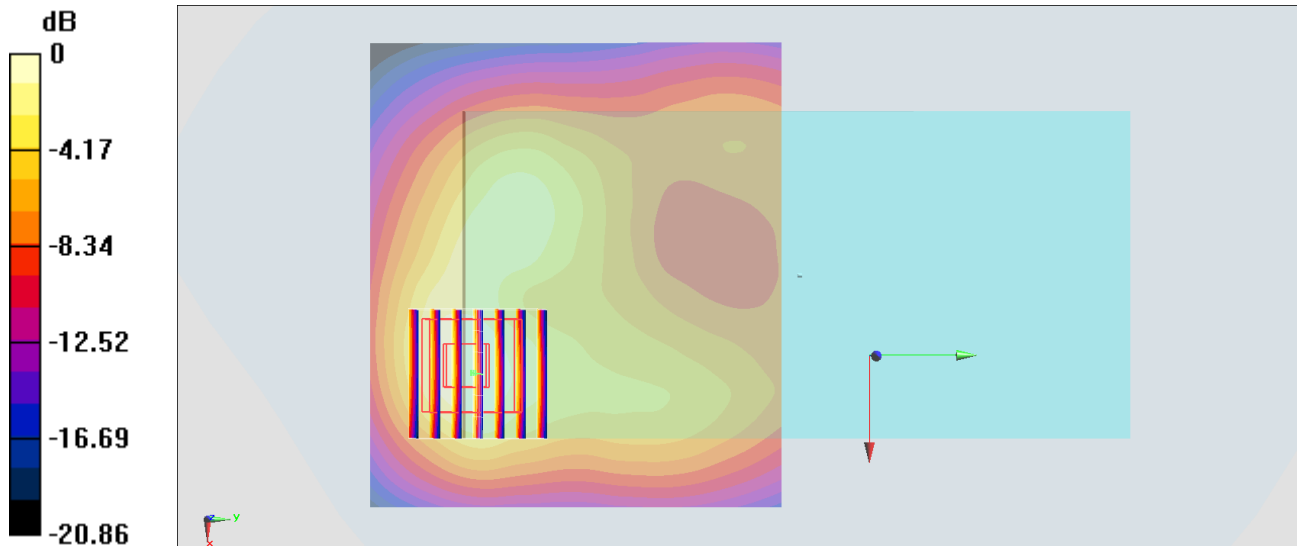

0 dB = 1.22 W/kg = 0.86 dBW/kg

#34_LTE Band 12_10M_QPSK_1_0_Front_10mm_Ch23095

Communication System: LTE; Frequency: 707.5 MHz; Duty Cycle: 1:1

Medium: MSL_750_170518 Medium parameters used: $f = 707.5$ MHz; $\sigma = 0.936$ S/m; $\epsilon_r = 54.755$; $\rho = 1000$ kg/m³

Ambient Temperature : 23.5 °C ; Liquid Temperature : 22.5 °C

DASY5 Configuration:

- Probe: EX3DV4 - SN3976; ConvF(10.68, 10.68, 10.68); Calibrated: 2017/2/21;
- Sensor-Surface: 1.4mm (Mechanical Surface Detection)
- Electronics: DAE4 Sn1424; Calibrated: 2017/2/16
- Phantom: SAM-Right; Type: SAM; Serial: TP-1303
- Measurement SW: DASY52, Version 52.8 (8); SEMCAD X Version 14.6.10 (7373)

Area Scan (71x81x1): Interpolated grid: dx=1.500 mm, dy=1.500 mm

Maximum value of SAR (interpolated) = 1.03 W/kg

Zoom Scan (5x5x7)/Cube 0: Measurement grid: dx=8mm, dy=8mm, dz=5mm

Reference Value = 33.37 V/m; Power Drift = -0.05 dB

Peak SAR (extrapolated) = 1.39 W/kg

SAR(1 g) = 0.750 W/kg; SAR(10 g) = 0.433 W/kg

Maximum value of SAR (measured) = 1.14 W/kg

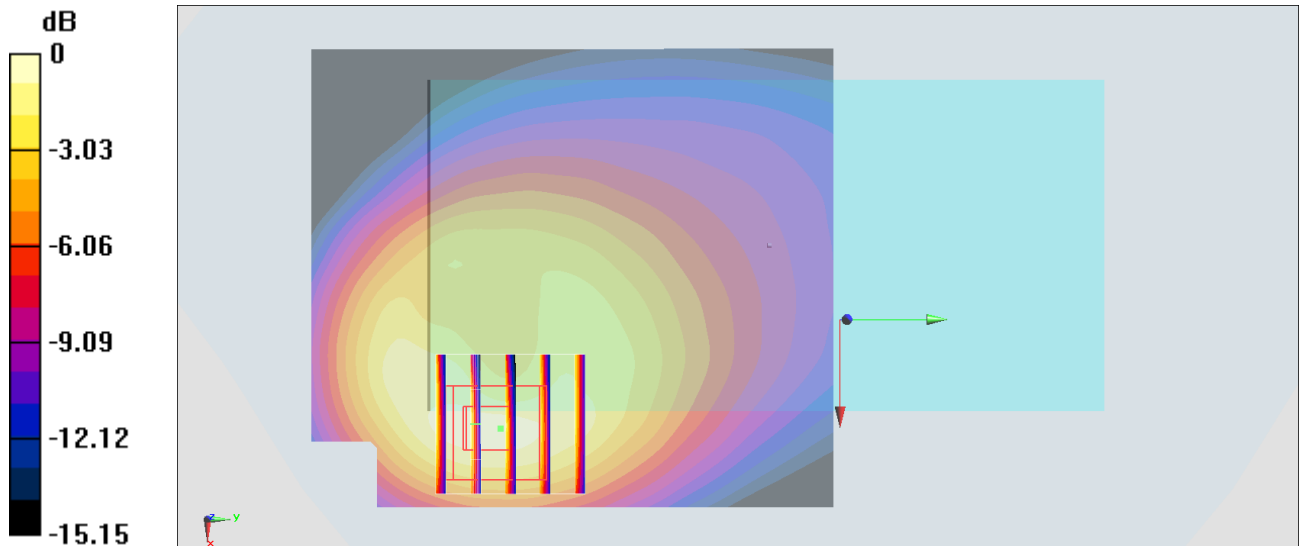

0 dB = 1.14 W/kg = 0.57 dBW/kg

#35_LTE Band 17_10M_QPSK_1_0_Front_10mm_Ch23790

Communication System: LTE; Frequency: 710 MHz; Duty Cycle: 1:1

Medium: MSL_750_170518 Medium parameters used: $f = 710$ MHz; $\sigma = 0.939$ S/m; $\epsilon_r = 54.731$; $\rho = 1000$ kg/m³

Ambient Temperature : 23.5 °C ; Liquid Temperature : 22.5 °C

DASY5 Configuration:

- Probe: EX3DV4 - SN3976; ConvF(10.68, 10.68, 10.68); Calibrated: 2017/2/21;
- Sensor-Surface: 1.4mm (Mechanical Surface Detection)
- Electronics: DAE4 Sn1424; Calibrated: 2017/2/16
- Phantom: SAM-Right; Type: SAM; Serial: TP-1303
- Measurement SW: DASY52, Version 52.8 (8); SEMCAD X Version 14.6.10 (7373)

Area Scan (71x81x1): Interpolated grid: dx=1.500 mm, dy=1.500 mm

Maximum value of SAR (interpolated) = 1.04 W/kg

Zoom Scan (5x5x7)/Cube 0: Measurement grid: dx=8mm, dy=8mm, dz=5mm

Reference Value = 33.38 V/m; Power Drift = -0.14 dB

Peak SAR (extrapolated) = 1.39 W/kg

SAR(1 g) = 0.743 W/kg; SAR(10 g) = 0.425 W/kg

Maximum value of SAR (measured) = 1.14 W/kg

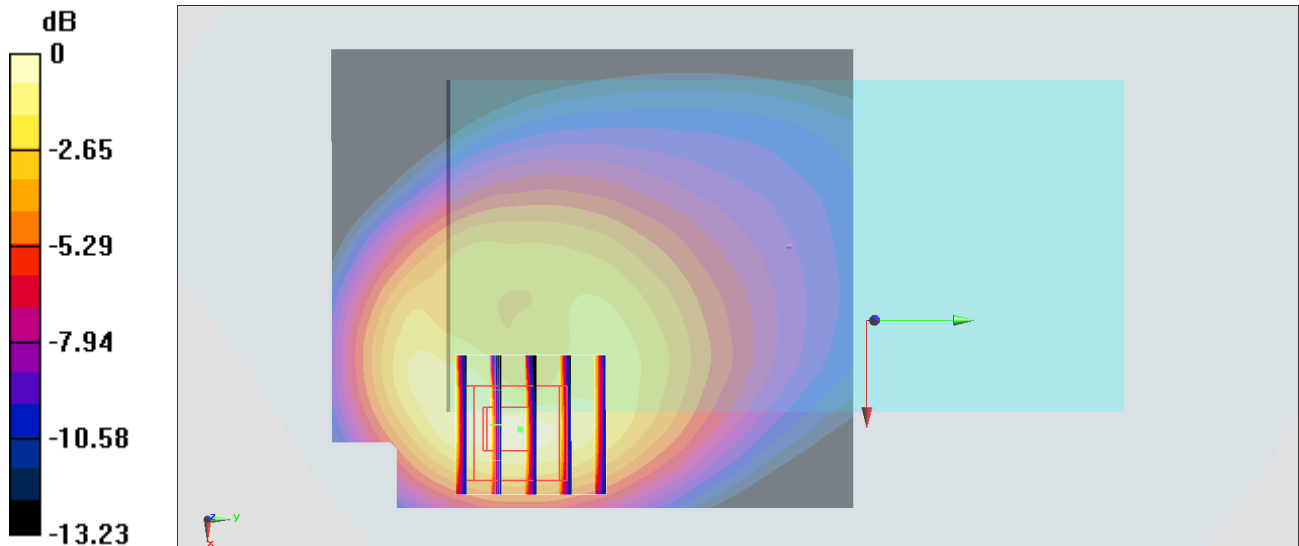

0 dB = 1.14 W/kg = 0.57 dBW/kg

#36_LTE Band 26_15M_QPSK_1_0_Back_10mm_Ch26865

Communication System: LTE; Frequency: 831.5 MHz; Duty Cycle: 1:1

Medium: MSL_850_170517 Medium parameters used: $f = 831.5$ MHz; $\sigma = 0.958$ S/m; $\epsilon_r = 54.678$; $\rho = 1000$ kg/m³

Ambient Temperature : 23.4 °C ; Liquid Temperature : 22.4 °C

DASY5 Configuration:

- Probe: EX3DV4 - SN3976; ConvF(10.41, 10.41, 10.41); Calibrated: 2017/2/21;
- Sensor-Surface: 1.4mm (Mechanical Surface Detection)
- Electronics: DAE4 Sn1424; Calibrated: 2017/2/16
- Phantom: SAM-Right; Type: SAM; Serial: TP-1303
- Measurement SW: DASY52, Version 52.8 (8); SEMCAD X Version 14.6.10 (7373)

Area Scan (71x81x1): Interpolated grid: dx=1.500 mm, dy=1.500 mm

Maximum value of SAR (interpolated) = 1.22 W/kg

Zoom Scan (5x5x7)/Cube 0: Measurement grid: dx=8mm, dy=8mm, dz=5mm

Reference Value = 33.38 V/m; Power Drift = -0.02 dB

Peak SAR (extrapolated) = 1.59 W/kg

SAR(1 g) = 0.861 W/kg; SAR(10 g) = 0.505 W/kg

Maximum value of SAR (measured) = 1.25 W/kg

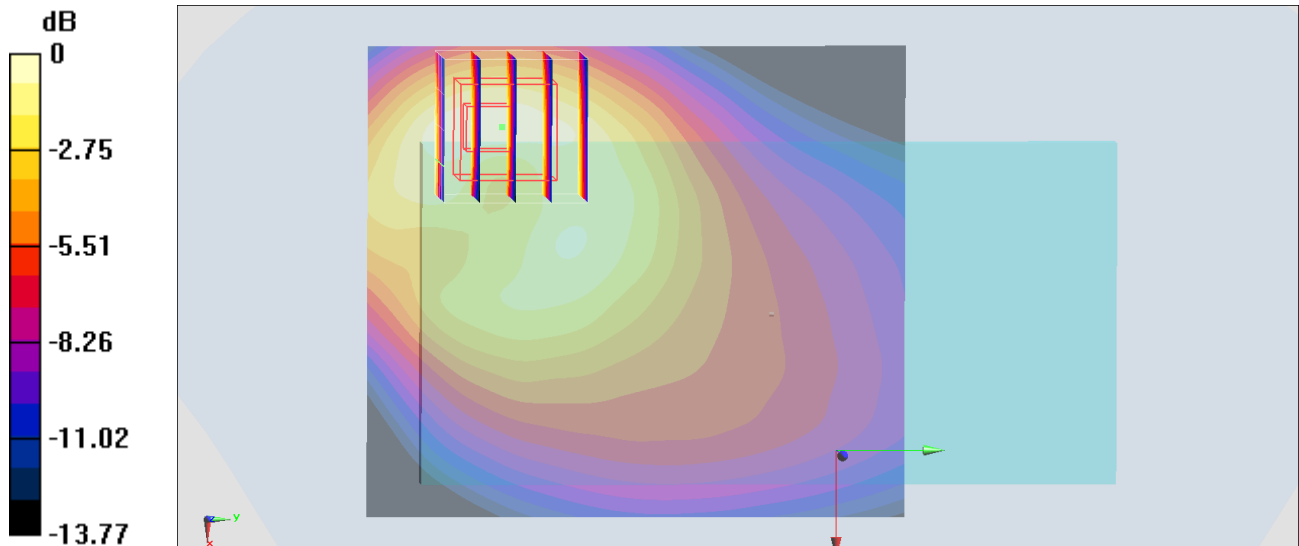

#37_LTE Band 38_20M_QPSK_1_0_Bottom Side_10mm_Ch38150

Communication System: LTE ; Frequency: 2610 MHz; Duty Cycle: 1:1.59

Medium: MSL_2600_170514 Medium parameters used: $f = 2610$ MHz; $\sigma = 2.179$ S/m; $\epsilon_r = 52.701$; $\rho = 1000$ kg/m³

Ambient Temperature : 23.5 °C ; Liquid Temperature : 22.5 °C

DASY5 Configuration:

- Probe: EX3DV4 - SN3976; ConvF(7.59, 7.59, 7.59); Calibrated: 2017/2/21;
- Sensor-Surface: 1.4mm (Mechanical Surface Detection)
- Electronics: DAE4 Sn1424; Calibrated: 2017/2/16
- Phantom: SAM-Right; Type: SAM; Serial: TP-1303
- Measurement SW: DASY52, Version 52.8 (8); SEMCAD X Version 14.6.10 (7373)

Area Scan (41x91x1): Interpolated grid: dx=1.200 mm, dy=1.200 mm

Maximum value of SAR (interpolated) = 1.08 W/kg

Zoom Scan (7x7x7)/Cube 0: Measurement grid: dx=5mm, dy=5mm, dz=5mm

Reference Value = 20.43 V/m; Power Drift = 0.02 dB

Peak SAR (extrapolated) = 1.40 W/kg

SAR(1 g) = 0.640 W/kg; SAR(10 g) = 0.302 W/kg

Maximum value of SAR (measured) = 1.09 W/kg

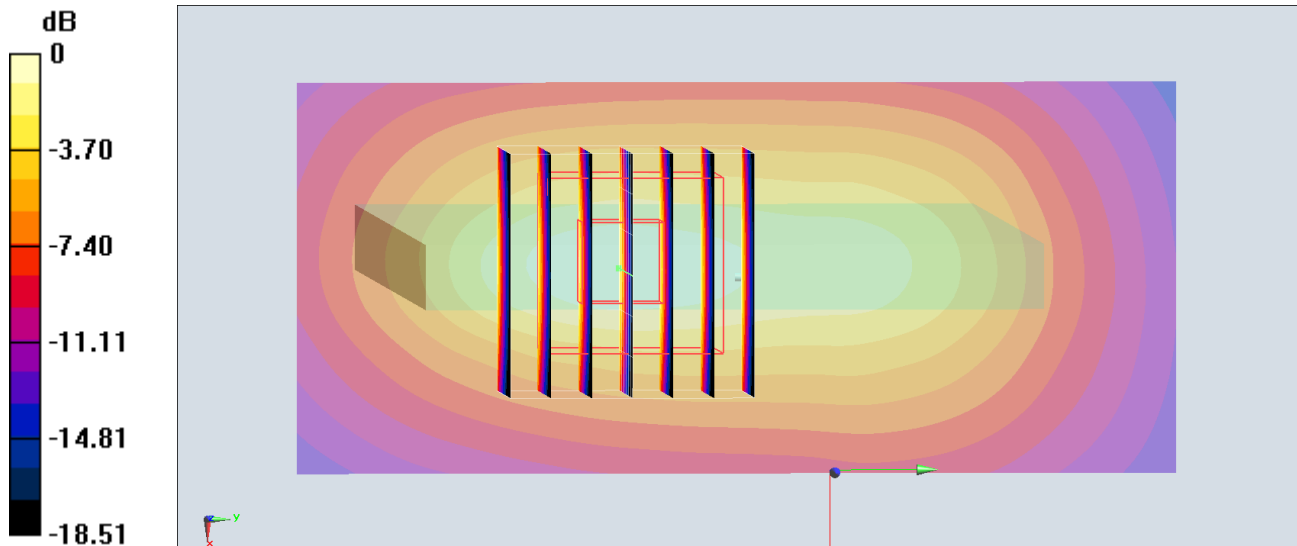

0 dB = 1.09 W/kg = 0.37 dBW/kg

#38_LTE Band 41_20M_QPSK_1_0_Back_10mm_Ch41140

Communication System: LTE ; Frequency: 2645 MHz;Duty Cycle: 1:1.59

Medium: MSL_2600_170513 Medium parameters used : $f = 2645$ MHz; $\sigma = 2.219$ S/m; $\epsilon_r = 52.052$; $\rho = 1000$ kg/m³

Ambient Temperature : 23.4 °C ; Liquid Temperature : 22.4 °C

DASY5 Configuration:

- Probe: EX3DV4 - SN3976; ConvF(7.59, 7.59, 7.59); Calibrated: 2017/2/21;
- Sensor-Surface: 1.4mm (Mechanical Surface Detection)
- Electronics: DAE4 Sn1424; Calibrated: 2017/2/16
- Phantom: SAM-Right; Type: SAM; Serial: TP-1303
- Measurement SW: DASY52, Version 52.8 (8);SEMCAD X Version 14.6.10 (7373)

Area Scan (91x81x1): Interpolated grid: dx=1.200 mm, dy=1.200 mm

Maximum value of SAR (interpolated) = 0.828 W/kg

Zoom Scan (7x7x7)/Cube 0: Measurement grid: dx=5mm, dy=5mm, dz=5mm

Reference Value = 13.63 V/m; Power Drift = 0.12 dB

Peak SAR (extrapolated) = 1.01 W/kg

SAR(1 g) = 0.481 W/kg; SAR(10 g) = 0.240 W/kg

Maximum value of SAR (measured) = 0.780 W/kg

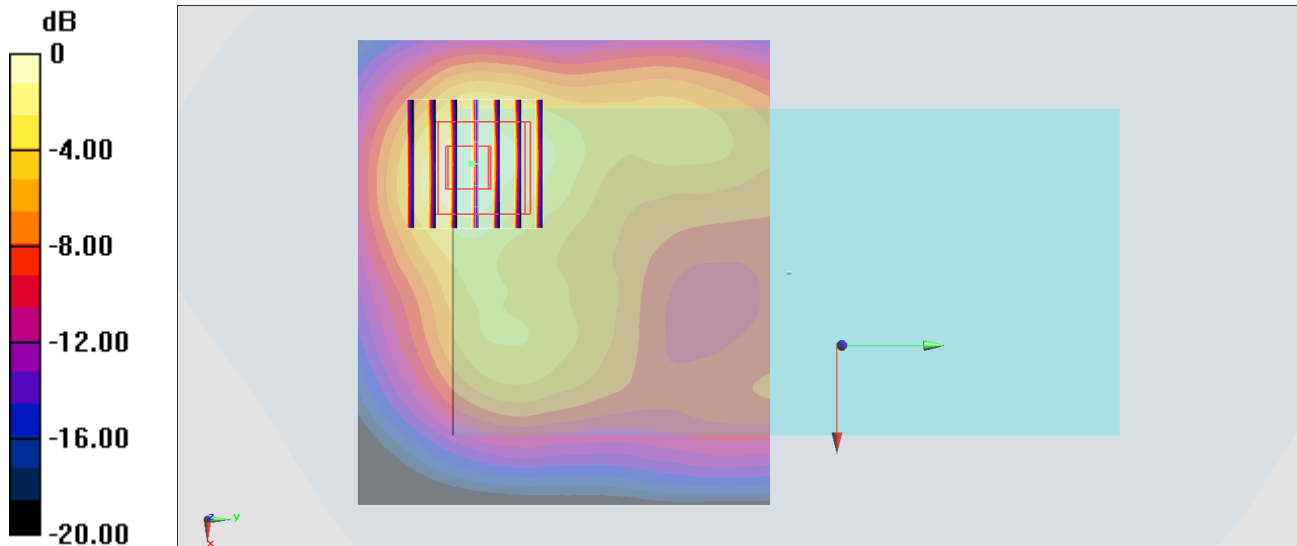

0 dB = 0.780 W/kg = -1.08 dBW/kg

#39_WLAN2.4GHz_802.11b 1Mbps_Bottom side_10mm_Ch11;Ant 2

Communication System: 802.11b; Frequency: 2462 MHz; Duty Cycle: 1:1

Medium: MSL_2450_170423 Medium parameters used: $f = 2462$ MHz; $\sigma = 2.04$ S/m; $\epsilon_r = 52.141$; $\rho = 1000$ kg/m³

Ambient Temperature : 23.4 °C ; Liquid Temperature : 22.4 °C

DASY5 Configuration:

- Probe: EX3DV4 - SN3931; ConvF(7.73, 7.73, 7.73); Calibrated: 2016/10/3;
- Sensor-Surface: 1.4mm (Mechanical Surface Detection)
- Electronics: DAE3 Sn577; Calibrated: 2016/9/28
- Phantom: SAM-Right; Type: SAM; Serial: TP-1303
- Measurement SW: DASY52, Version 52.8 (8); SEMCAD X Version 14.6.10 (7373)

Area Scan (51x71x1): Interpolated grid: dx=1.200 mm, dy=1.200 mm

Maximum value of SAR (interpolated) = 0.604 W/kg

Zoom Scan (7x7x7)/Cube 0: Measurement grid: dx=5mm, dy=5mm, dz=5mm

Reference Value = 15.15 V/m; Power Drift = -0.07 dB

Peak SAR (extrapolated) = 0.739 W/kg

SAR(1 g) = 0.303 W/kg; SAR(10 g) = 0.175 W/kg

Maximum value of SAR (measured) = 0.589 W/kg

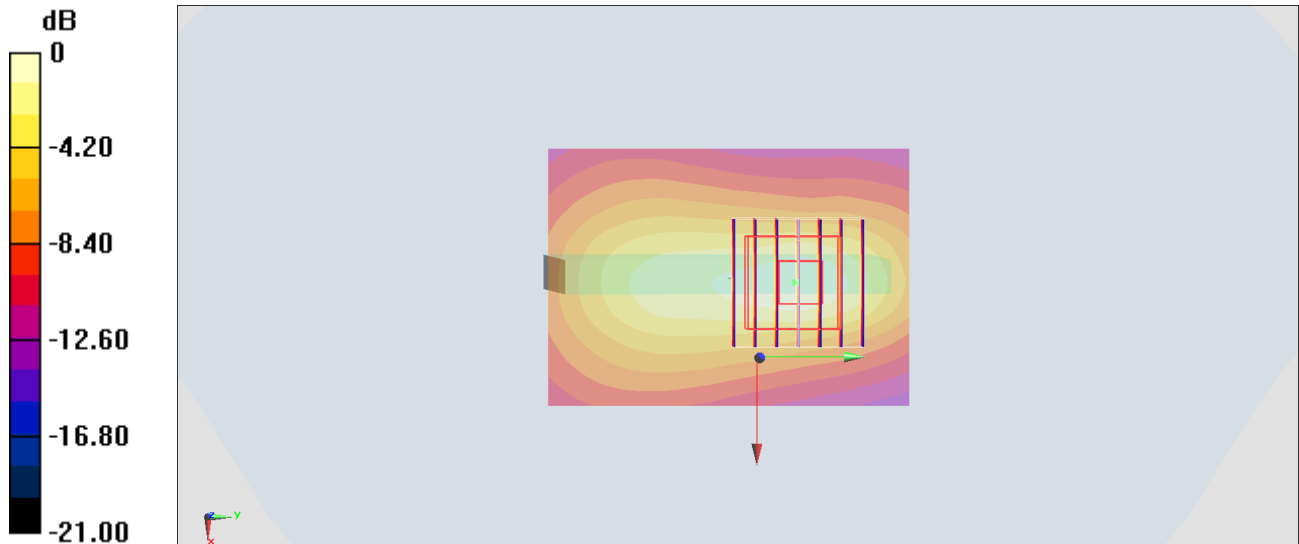

0 dB = 0.589 W/kg = -2.30 dBW/kg

#40_WLAN5GHz_802.11a 6Mbps_Front_10mm_Ch36;Ant 1

Communication System: 802.11a; Frequency: 5180 MHz; Duty Cycle: 1:1.156

Medium: MSL_5G_170417 Medium parameters used: $f = 5180$ MHz; $\sigma = 5.427$ mho/m; $\epsilon_r = 47.15$; $\rho = 1000$ kg/m³

Ambient Temperature : 23.7 °C; Liquid Temperature : 22.7 °C

DASY4 Configuration:

- Probe: EX3DV4 - SN3925; ConvF(4.39, 4.39, 4.39); Calibrated: 2016/5/26
- Sensor-Surface: 1.4mm (Mechanical Surface Detection)
- Electronics: DAE3 Sn495; Calibrated: 2016/5/27
- Phantom: SAM_Right; Type: QD000P40CD; Serial: TP:1815
- ;Postprocessing SW: SEMCAD, V1.8 Build 159

Area Scan (101x91x1): Measurement grid: dx=10mm, dy=10mm

Maximum value of SAR (interpolated) = 0.243 mW/g

Zoom Scan (7x7x7)/Cube 0: Measurement grid: dx=4mm, dy=4mm, dz=1.4mm

Reference Value = 5.69 V/m; Power Drift = -0.158 dB

Peak SAR (extrapolated) = 0.418 W/kg

SAR(1 g) = 0.109 mW/g; SAR(10 g) = 0.029 mW/g

Maximum value of SAR (measured) = 0.246 mW/g

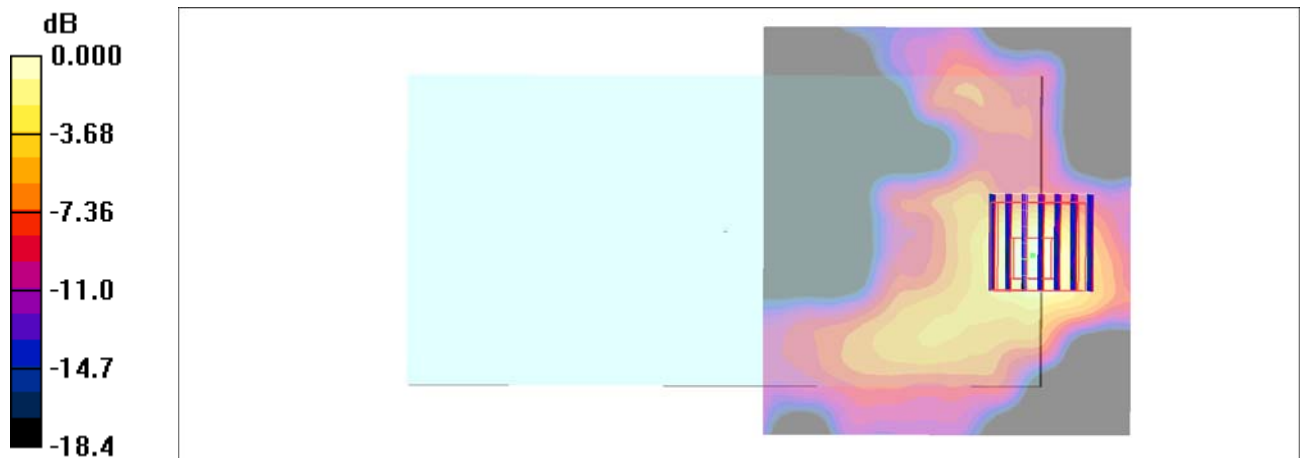

0 dB = 0.246mW/g

#41_WLAN5GHz_802.11ac-VHT80 MCS0_Top Side_10mm_Ch155;Ant 2

Communication System: 802.11ac; Frequency: 5775 MHz; Duty Cycle: 1:1.167

Medium: MSL_5G_170417 Medium parameters used: $f = 5775$ MHz; $\sigma = 6.2$ mho/m; $\epsilon_r = 46.2$; $\rho = 1000$ kg/m³

Ambient Temperature : 23.7 °C ; Liquid Temperature : 22.7 °C

DASY4 Configuration:

- Probe: EX3DV4 - SN3925; ConvF(3.85, 3.85, 3.85); Calibrated: 2016/5/26
- Sensor-Surface: 1.4mm (Mechanical Surface Detection)
- Electronics: DAE3 Sn495; Calibrated: 2016/5/27
- Phantom: SAM_Right; Type: QD000P40CD; Serial: TP:1815
- ;Postprocessing SW: SEMCAD, V1.8 Build 159

Area Scan (51x101x1): Measurement grid: dx=10mm, dy=10mm

Maximum value of SAR (interpolated) = 0.467 mW/g

Zoom Scan (7x7x7)/Cube 0: Measurement grid: dx=4mm, dy=4mm, dz=1.4mm

Reference Value = 6.98 V/m; Power Drift = 0.013 dB

Peak SAR (extrapolated) = 0.706 W/kg

SAR(1 g) = 0.168 mW/g; SAR(10 g) = 0.058 mW/g

Maximum value of SAR (measured) = 0.467 mW/g

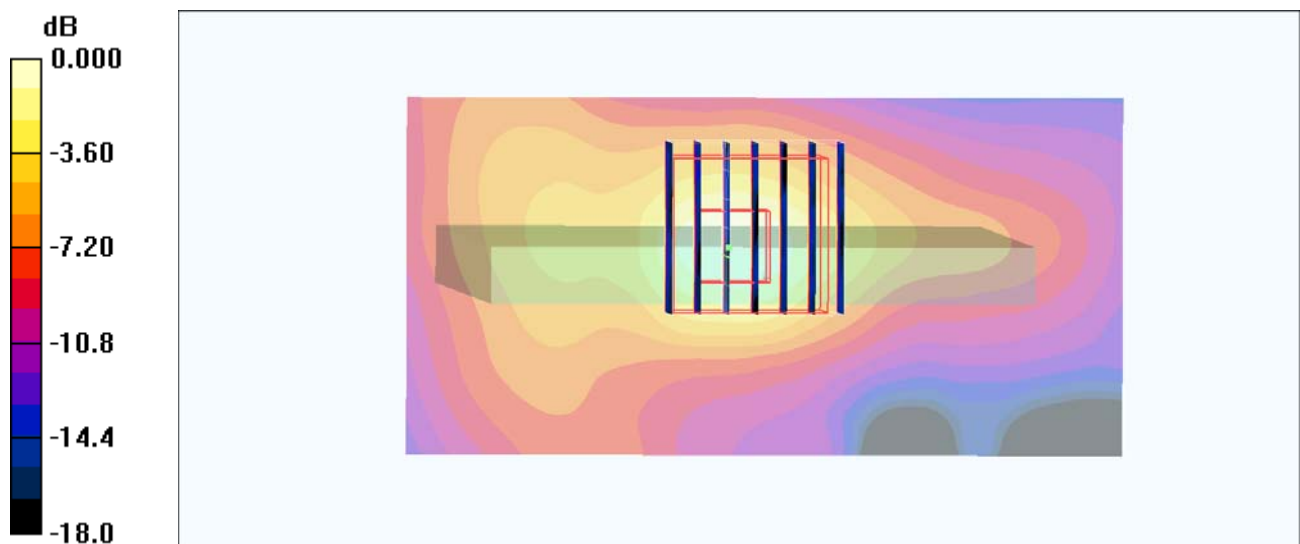

0 dB = 0.467mW/g

#42_WCDMA II_RMC 12.2Kbps_Bottom Side_0mm_Ch9538

Communication System: WCDMA; Frequency: 1907.6 MHz; Duty Cycle: 1:1

Medium: MSL_1900_170512 Medium parameters used: $f = 1908$ MHz; $\sigma = 1.553$ S/m; $\epsilon_r = 53.925$; $\rho = 1000$ kg/m³

Ambient Temperature : 23.6 °C ; Liquid Temperature : 22.6 °C

DASY5 Configuration:

- Probe: EX3DV4 - SN3976; ConvF(8.31, 8.31, 8.31); Calibrated: 2017/2/21;
- Sensor-Surface: 1.4mm (Mechanical Surface Detection)
- Electronics: DAE4 Sn1424; Calibrated: 2017/2/16
- Phantom: SAM-Right; Type: SAM; Serial: TP-1303
- Measurement SW: DASY52, Version 52.8 (8); SEMCAD X Version 14.6.10 (7373)

Area Scan (41x81x1): Interpolated grid: dx=1.500 mm, dy=1.500 mm

Maximum value of SAR (interpolated) = 12.0 W/kg

Zoom Scan (5x5x7)/Cube 0: Measurement grid: dx=8mm, dy=8mm, dz=5mm

Reference Value = 81.07 V/m; Power Drift = -0.01 dB

Peak SAR (extrapolated) = 15.1 W/kg

SAR(1 g) = 5.92 W/kg; SAR(10 g) = 2.5 W/kg

Maximum value of SAR (measured) = 12.4 W/kg

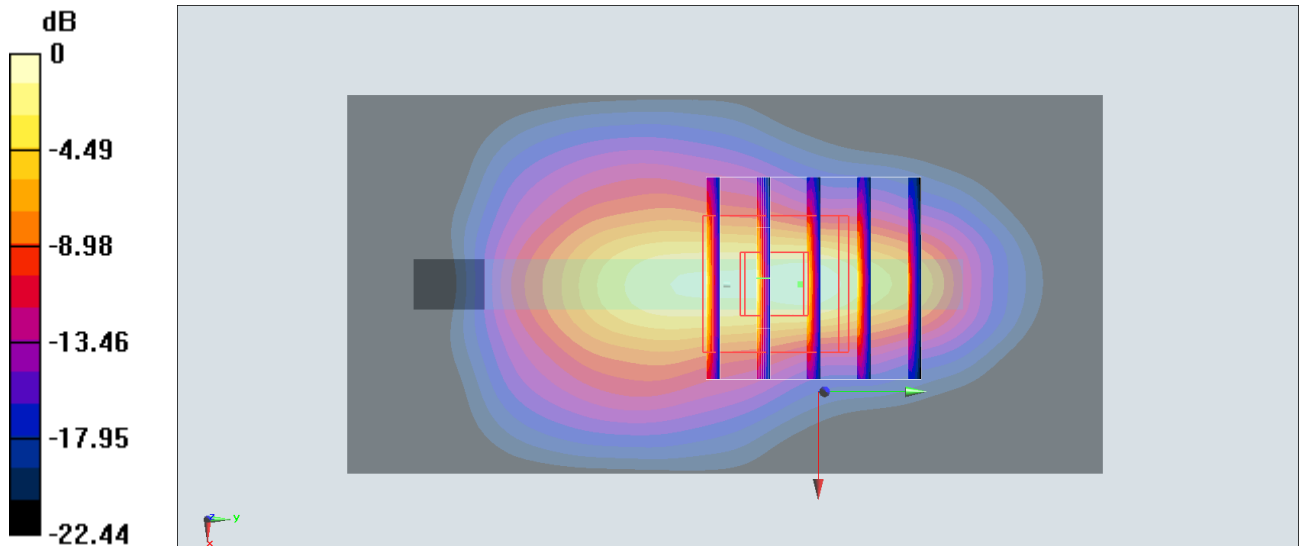

0 dB = 12.4 W/kg = 10.93 dBW/kg

#43_CDMA BC1_RTAP 153.6Kbps_Bottom Side_0mm_Ch1175

Communication System: CDMA ; Frequency: 1908.75 MHz; Duty Cycle: 1:1

Medium: MSL_1900_170515 Medium parameters used: $f = 1909$ MHz; $\sigma = 1.574$ S/m; $\epsilon_r = 54.269$; $\rho = 1000$ kg/m³

Ambient Temperature : 23.4 °C ; Liquid Temperature : 22.4 °C

DASY5 Configuration:

- Probe: EX3DV4 - SN3976; ConvF(8.31, 8.31, 8.31); Calibrated: 2017/2/21;
- Sensor-Surface: 1.4mm (Mechanical Surface Detection)
- Electronics: DAE4 Sn1424; Calibrated: 2017/2/16
- Phantom: SAM-Right; Type: SAM; Serial: TP-1303
- Measurement SW: DASY52, Version 52.8 (8); SEMCAD X Version 14.6.10 (7373)

Area Scan (41x61x1): Interpolated grid: dx=1.500 mm, dy=1.500 mm

Maximum value of SAR (interpolated) = 11.5 W/kg

Zoom Scan (5x6x7)/Cube 0: Measurement grid: dx=8mm, dy=8mm, dz=5mm

Reference Value = 95.46 V/m; Power Drift = 0.09 dB

Peak SAR (extrapolated) = 18.0 W/kg

SAR(1 g) = 6.37 W/kg; SAR(10 g) = 2.65 W/kg

Maximum value of SAR (measured) = 14.5 W/kg

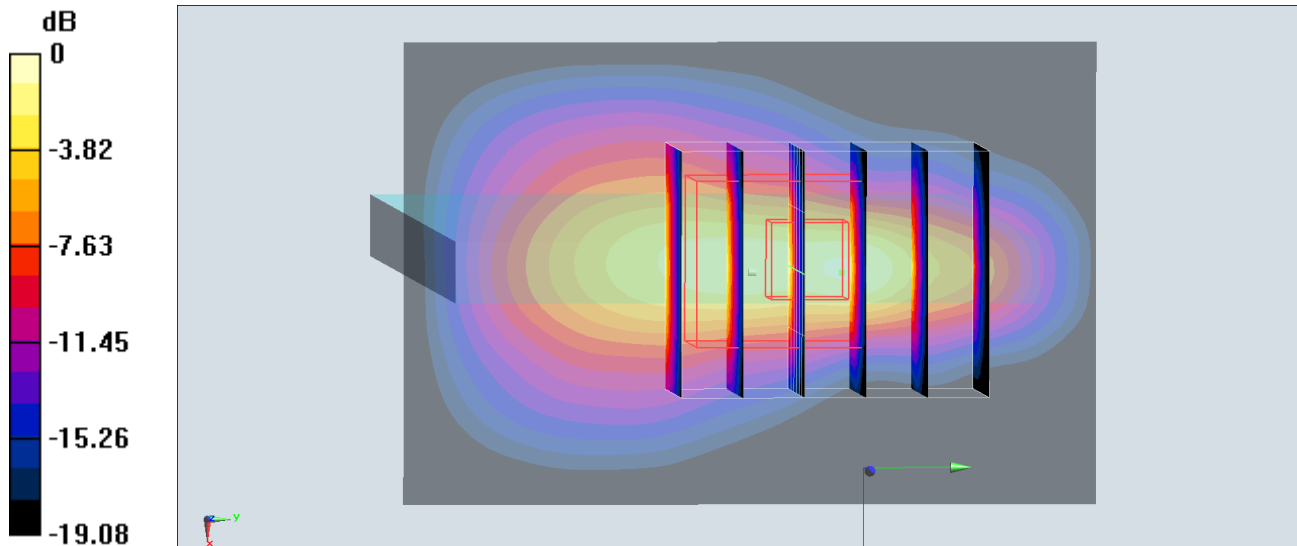

0 dB = 14.5 W/kg = 11.61 dBW/kg

#44_LTE Band 2_20M_QPSK_1_0_Bottom Side_0mm_Ch18900

Communication System: LTE; Frequency: 1900 MHz; Duty Cycle: 1:1

Medium: MSL_1900_170512 Medium parameters used: $f = 1900$ MHz; $\sigma = 1.546$ S/m; $\epsilon_r = 53.932$; $\rho = 1000$ kg/m³

Ambient Temperature : 23.6 °C ; Liquid Temperature : 22.6 °C

DASY5 Configuration:

- Probe: EX3DV4 - SN3976; ConvF(8.31, 8.31, 8.31); Calibrated: 2017/2/21;
- Sensor-Surface: 1.4mm (Mechanical Surface Detection)
- Electronics: DAE4 Sn1424; Calibrated: 2017/2/16
- Phantom: SAM-Right; Type: SAM; Serial: TP-1303
- Measurement SW: DASY52, Version 52.8 (8); SEMCAD X Version 14.6.10 (7373)

Area Scan (41x81x1): Interpolated grid: dx=1.500 mm, dy=1.500 mm

Maximum value of SAR (interpolated) = 10.8 W/kg

Zoom Scan (5x5x7)/Cube 0: Measurement grid: dx=8mm, dy=8mm, dz=5mm

Reference Value = 80.94 V/m; Power Drift = -0.06 dB

Peak SAR (extrapolated) = 14.0 W/kg

SAR(1 g) = 5.74 W/kg; SAR(10 g) = 2.46 W/kg

Maximum value of SAR (measured) = 11.2 W/kg

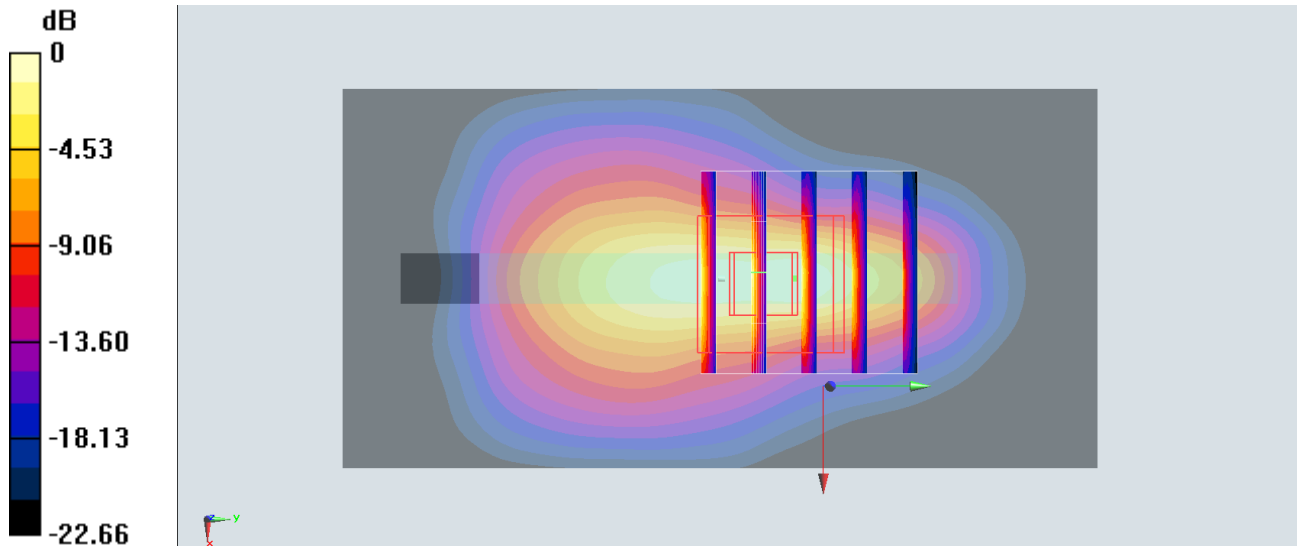

#45_WLAN5GHz_802.11a_6Mbps_Front_0mm_Ch64;Ant 2

Communication System: 802.11a ; Frequency: 5320 MHz;Duty Cycle: 1:1.054

Medium: MSL_5G_170427 Medium parameters used: $f = 5320$ MHz; $\sigma = 5.314$ S/m; $\epsilon_r = 46.815$; $\rho = 1000$ kg/m³

Ambient Temperature : 23.4 °C ; Liquid Temperature : 22.4 °C

DASY5 Configuration:

- Probe: EX3DV4 - SN3931; ConvF(4.57, 4.57, 4.57); Calibrated: 2016/10/3;
- Sensor-Surface: 1.4mm (Mechanical Surface Detection)
- Electronics: DAE3 Sn577; Calibrated: 2016/9/28
- Phantom: SAM-Right; Type: SAM; Serial: TP-1303
- Measurement SW: DASY52, Version 52.8 (8);SEMCAD X Version 14.6.10 (7373)

Area Scan (101x91x1): Interpolated grid: dx=1.000 mm, dy=1.000 mm

Maximum value of SAR (interpolated) = 9.32 W/kg

Zoom Scan (9x9x7)/Cube 0: Measurement grid: dx=4mm, dy=4mm, dz=1.4mm

Reference Value = 26.01 V/m; Power Drift = 0.12 dB

Peak SAR (extrapolated) = 21.6 W/kg

SAR(1 g) = 2.7 W/kg; SAR(10 g) = 0.718 W/kg

Maximum value of SAR (measured) = 8.74 W/kg

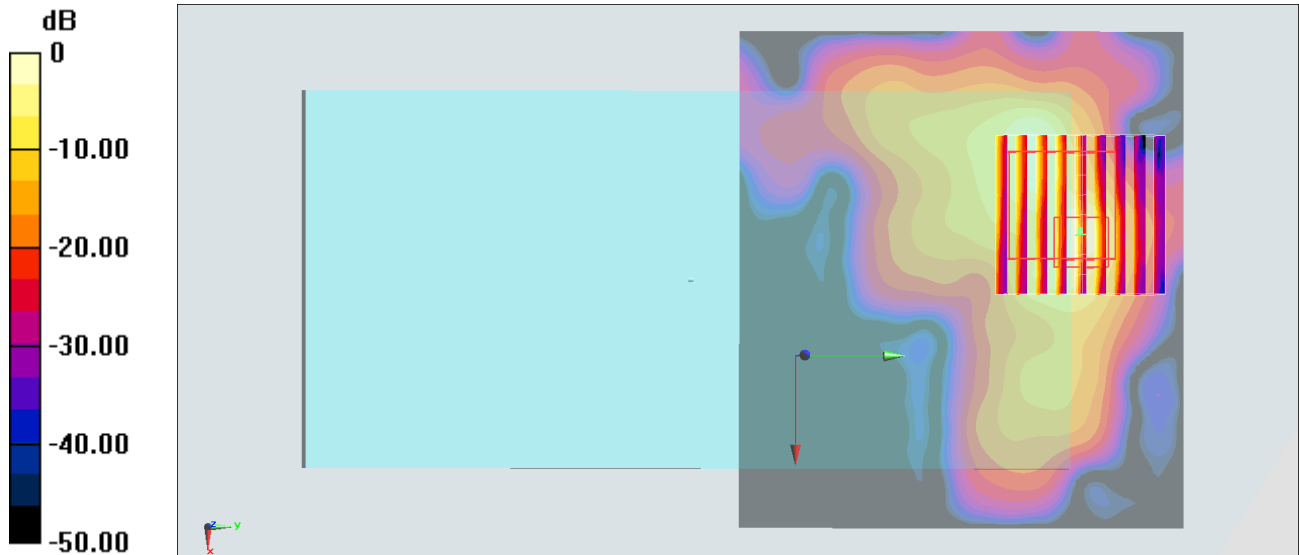

0 dB = 8.74 W/kg = 9.42 dBW/kg

#46_WLAN5GHz_802.11ac-VHT80 MCS0_Top Side_0mm_Ch138;Ant 2

Communication System: 802.11ac ; Frequency: 5690 MHz;Duty Cycle: 1:1.167

Medium: MSL_5G_170427 Medium parameters used: $f = 5690$ MHz; $\sigma = 5.777$ S/m; $\epsilon_r = 46.254$; $\rho = 1000$ kg/m³

Ambient Temperature : 23.4 °C ; Liquid Temperature : 22.4 °C

DASY5 Configuration:

- Probe: EX3DV4 - SN3931; ConvF(3.71, 3.71, 3.71); Calibrated: 2016/10/3;
- Sensor-Surface: 1.4mm (Mechanical Surface Detection)
- Electronics: DAE3 Sn577; Calibrated: 2016/9/28
- Phantom: SAM-Right; Type: SAM; Serial: TP-1303
- Measurement SW: DASY52, Version 52.8 (8);SEMCAD X Version 14.6.10 (7373)

Area Scan (61x91x1): Interpolated grid: dx=1.000 mm, dy=1.000 mm

Maximum value of SAR (interpolated) = 14.7 W/kg

Zoom Scan (8x9x7)/Cube 0: Measurement grid: dx=4mm, dy=4mm, dz=1.4mm

Reference Value = 5.454 V/m; Power Drift = 0.11 dB

Peak SAR (extrapolated) = 35.5 W/kg

SAR(1 g) = 4.72 W/kg; SAR(10 g) = 1 W/kg

Maximum value of SAR (measured) = 17.7 W/kg

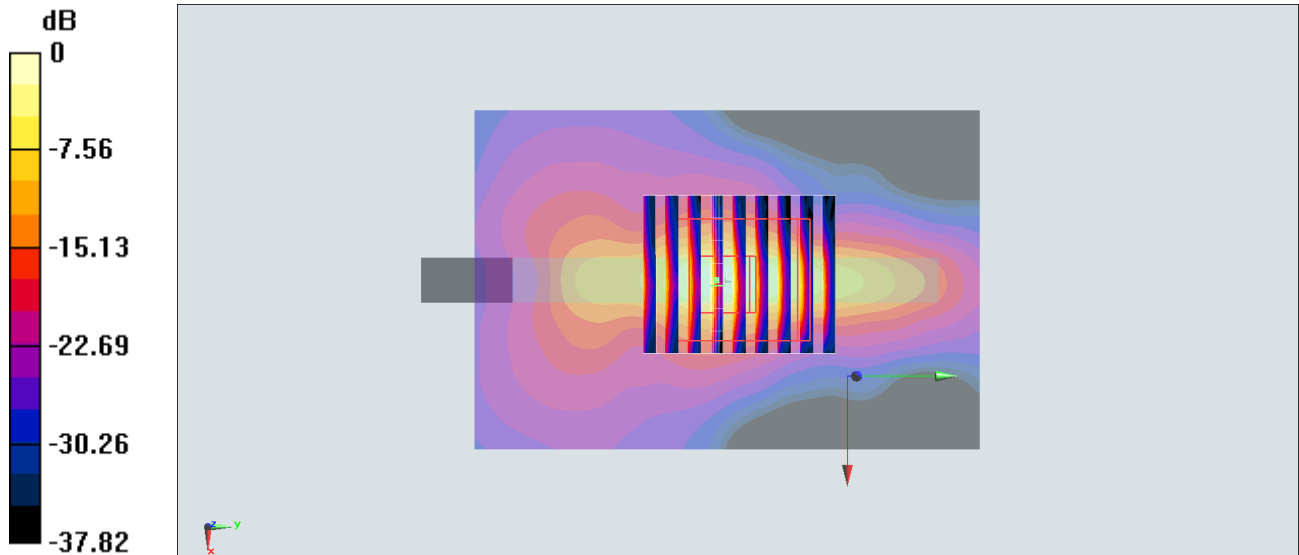

0 dB = 17.7 W/kg = 12.48 dBW/kg

#47_GSM850_GPRS (4 Tx slots)_Back_10mm_Ch189

Communication System: GSM850 ; Frequency: 836.4 MHz; Duty Cycle: 1:2.08

Medium: MSL_850_170517 Medium parameters used: $f = 836.4$ MHz; $\sigma = 0.962$ S/m; $\epsilon_r = 54.628$; $\rho = 1000$ kg/m³

Ambient Temperature : 23.4 °C ; Liquid Temperature : 22.4 °C

DASY5 Configuration:

- Probe: EX3DV4 - SN3976; ConvF(10.41, 10.41, 10.41); Calibrated: 2017/2/21;
- Sensor-Surface: 1.4mm (Mechanical Surface Detection)
- Electronics: DAE4 Sn1424; Calibrated: 2017/2/16
- Phantom: SAM-Right; Type: SAM; Serial: TP-1303
- Measurement SW: DASY52, Version 52.8 (8); SEMCAD X Version 14.6.10 (7373)

Area Scan (71x91x1): Interpolated grid: dx=1.500 mm, dy=1.500 mm

Maximum value of SAR (interpolated) = 0.710 W/kg

Zoom Scan (5x5x7)/Cube 0: Measurement grid: dx=8mm, dy=8mm, dz=5mm

Reference Value = 26.00 V/m; Power Drift = -0.06 dB

Peak SAR (extrapolated) = 0.890 W/kg

SAR(1 g) = 0.503 W/kg; SAR(10 g) = 0.296 W/kg

Maximum value of SAR (measured) = 0.729 W/kg

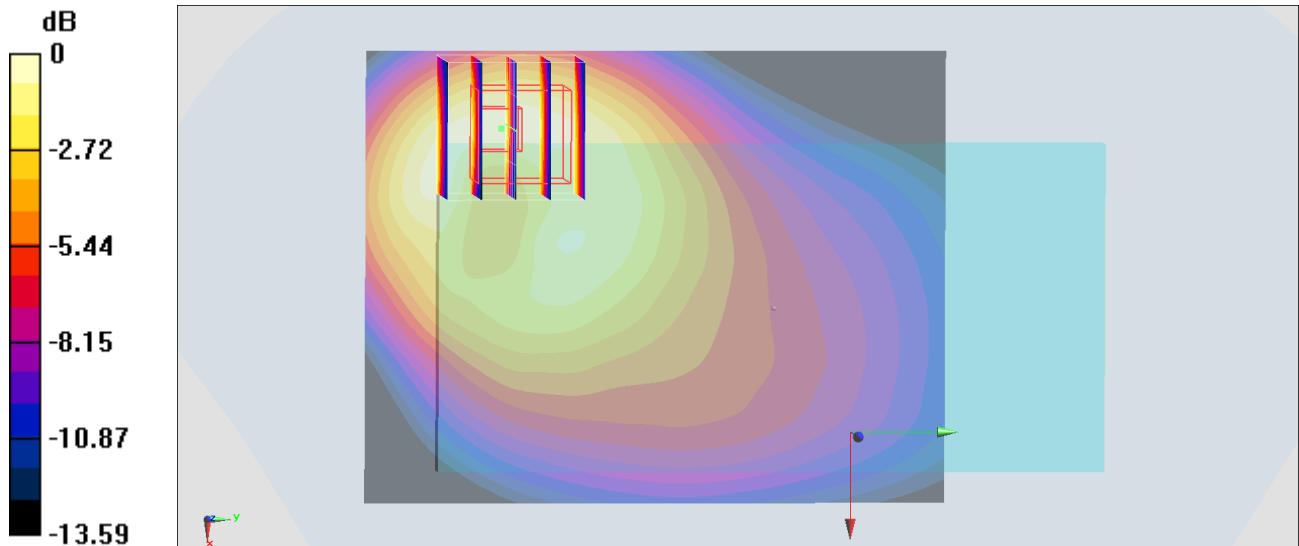

0 dB = 0.729 W/kg = -1.37 dBW/kg

#48_GSM1900_GPRS (4 Tx slots)_Back_10mm_Ch512

Communication System: PCS ; Frequency: 1850.2 MHz; Duty Cycle: 1:2.08

Medium: MSL_1900_170515 Medium parameters used: $f = 1850.2$ MHz; $\sigma = 1.515$ S/m; $\epsilon_r = 54.477$; $\rho = 1000$ kg/m³

Ambient Temperature : 23.4 °C ; Liquid Temperature : 22.4 °C

DASY5 Configuration:

- Probe: EX3DV4 - SN3976; ConvF(8.31, 8.31, 8.31); Calibrated: 2017/2/21;
- Sensor-Surface: 1.4mm (Mechanical Surface Detection)
- Electronics: DAE4 Sn1424; Calibrated: 2017/2/16
- Phantom: SAM-Right; Type: SAM; Serial: TP-1303
- Measurement SW: DASY52, Version 52.8 (8); SEMCAD X Version 14.6.10 (7373)

Area Scan (71x71x1): Interpolated grid: dx=1.500 mm, dy=1.500 mm

Maximum value of SAR (interpolated) = 0.606 W/kg

Zoom Scan (5x5x7)/Cube 0: Measurement grid: dx=8mm, dy=8mm, dz=5mm

Reference Value = 14.15 V/m; Power Drift = -0.02 dB

Peak SAR (extrapolated) = 0.640 W/kg

SAR(1 g) = 0.374 W/kg; SAR(10 g) = 0.205 W/kg

Maximum value of SAR (measured) = 0.538 W/kg

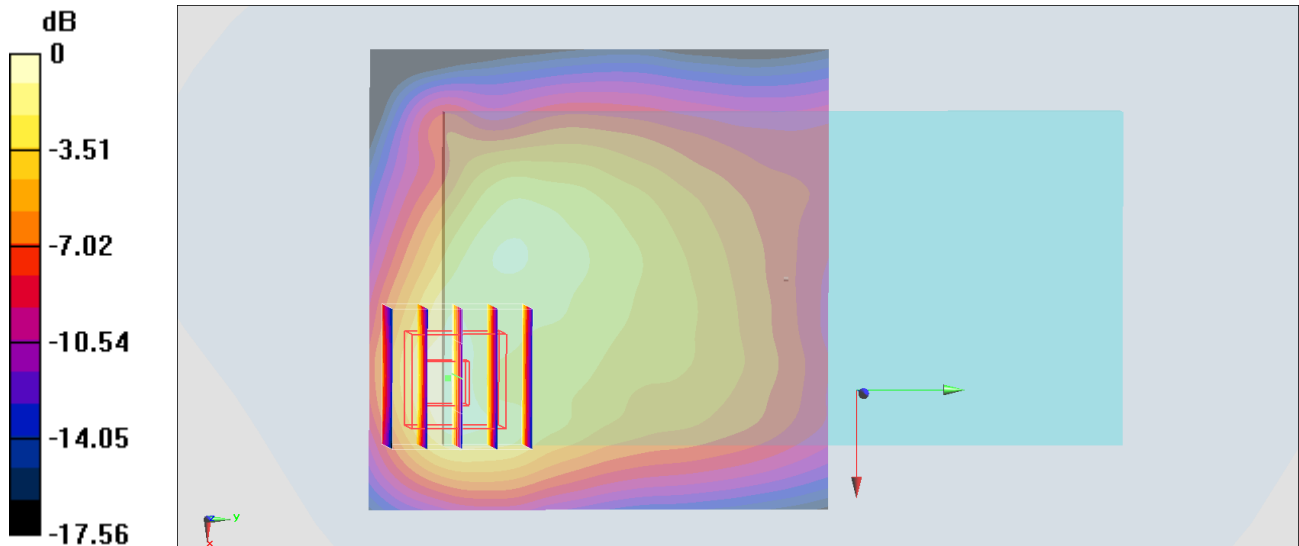

0 dB = 0.538 W/kg = -2.69 dBW/kg

#49_WCDMA II_RMC 12.2Kbps_Back_10mm_Ch9262

Communication System: WCDMA ; Frequency: 1852.4 MHz;Duty Cycle: 1:1

Medium: MSL_1900_170512 Medium parameters used : $f = 1852.4$ MHz; $\sigma = 1.485$ S/m; $\epsilon_r = 54.114$; $\rho = 1000$ kg/m³

Ambient Temperature : 23.6 °C ; Liquid Temperature : 22.6 °C

DASY5 Configuration:

- Probe: EX3DV4 - SN3976; ConvF(8.31, 8.31, 8.31); Calibrated: 2017/2/21;
- Sensor-Surface: 1.4mm (Mechanical Surface Detection)
- Electronics: DAE4 Sn1424; Calibrated: 2017/2/16
- Phantom: SAM-Right; Type: SAM; Serial: TP-1303
- Measurement SW: DASY52, Version 52.8 (8);SEMCAD X Version 14.6.10 (7373)

Area Scan (71x121x1): Interpolated grid: dx=1.500 mm, dy=1.500 mm

Maximum value of SAR (interpolated) = 1.04 W/kg

Zoom Scan (5x5x7)/Cube 0: Measurement grid: dx=8mm, dy=8mm, dz=5mm

Reference Value = 22.68 V/m; Power Drift = -0.02 dB

Peak SAR (extrapolated) = 1.25 W/kg

SAR(1 g) = 0.712 W/kg; SAR(10 g) = 0.391 W/kg

Maximum value of SAR (measured) = 0.988 W/kg

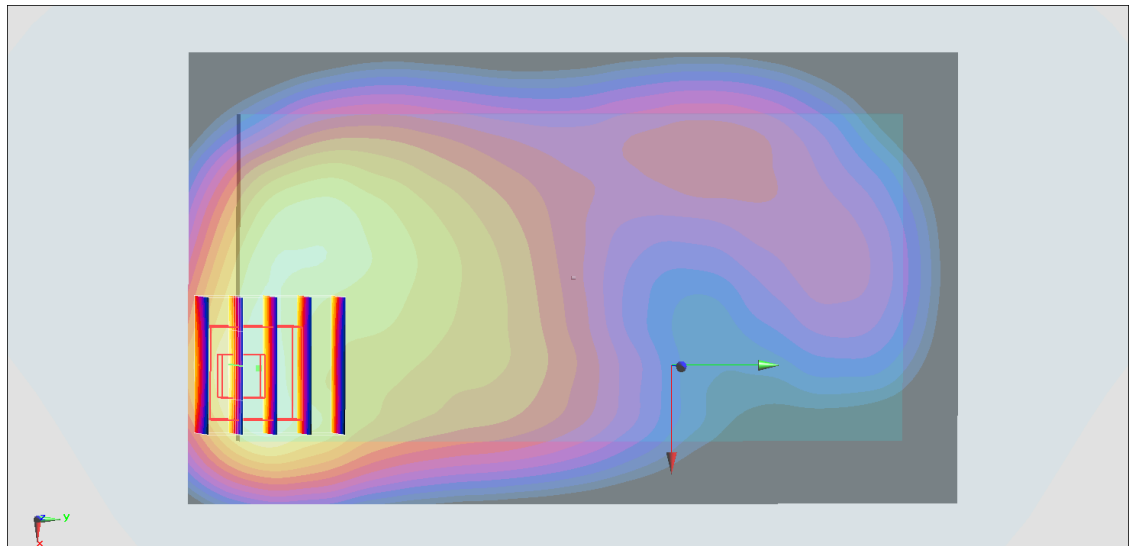
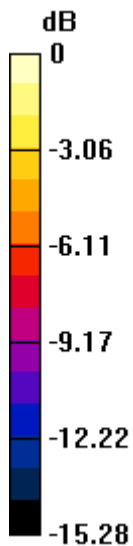

0 dB = 0.988 W/kg = -0.05 dBW/kg

#50_WCDMA_IV_RMC_12.2Kbps_Back_10mm_Ch1413

Communication System: WCDMA; Frequency: 1732.6 MHz; Duty Cycle: 1:1

Medium: MSL_1750_170515 Medium parameters used: $f = 1733$ MHz; $\sigma = 1.468$ S/m; $\epsilon_r = 55.941$; $\rho = 1000$ kg/m³

Ambient Temperature : 23.4 °C ; Liquid Temperature : 22.4 °C

DASY5 Configuration:

- Probe: EX3DV4 - SN3976; ConvF(8.57, 8.57, 8.57); Calibrated: 2017/2/21;
- Sensor-Surface: 1.4mm (Mechanical Surface Detection)
- Electronics: DAE4 Sn1424; Calibrated: 2017/2/16
- Phantom: SAM-Right; Type: SAM; Serial: TP-1303
- Measurement SW: DASY52, Version 52.8 (8); SEMCAD X Version 14.6.10 (7373)

Area Scan (71x121x1): Interpolated grid: dx=1.500 mm, dy=1.500 mm

Maximum value of SAR (interpolated) = 1.01 W/kg

Zoom Scan (5x5x7)/Cube 0: Measurement grid: dx=8mm, dy=8mm, dz=5mm

Reference Value = 27.60 V/m; Power Drift = -0.06 dB

Peak SAR (extrapolated) = 1.16 W/kg

SAR(1 g) = 0.729 W/kg; SAR(10 g) = 0.460 W/kg

Maximum value of SAR (measured) = 0.966 W/kg

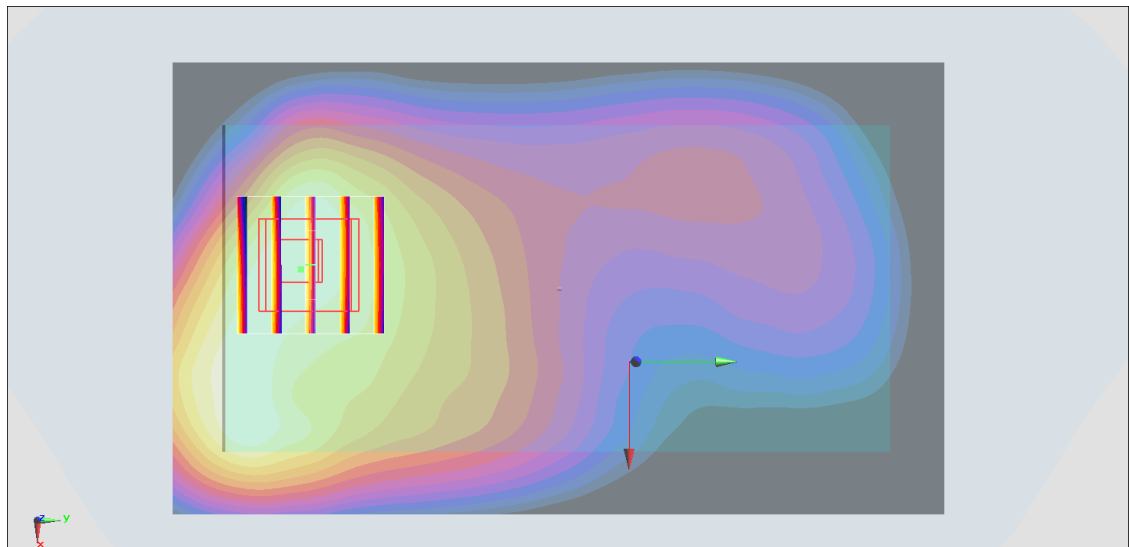
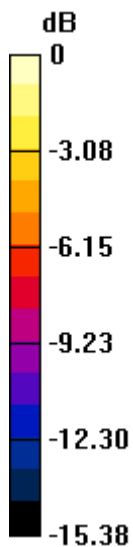

#51_WCDMA V_RMC 12.2Kbps_Back_10mm_Ch4233

Communication System: WCDMA ; Frequency: 846.6 MHz; Duty Cycle: 1:1

Medium: MSL_850_170517 Medium parameters used: $f = 847$ MHz; $\sigma = 0.973$ S/m; $\epsilon_r = 54.524$; $\rho = 1000$ kg/m³

Ambient Temperature : 23.4 °C ; Liquid Temperature : 22.4 °C

DASY5 Configuration:

- Probe: EX3DV4 - SN3976; ConvF(10.41, 10.41, 10.41); Calibrated: 2017/2/21;
- Sensor-Surface: 1.4mm (Mechanical Surface Detection)
- Electronics: DAE4 Sn1424; Calibrated: 2017/2/16
- Phantom: SAM-Right; Type: SAM; Serial: TP-1303
- Measurement SW: DASY52, Version 52.8 (8); SEMCAD X Version 14.6.10 (7373)

Area Scan (71x81x1): Interpolated grid: dx=1.500 mm, dy=1.500 mm

Maximum value of SAR (interpolated) = 1.10 W/kg

Zoom Scan (5x5x7)/Cube 0: Measurement grid: dx=8mm, dy=8mm, dz=5mm

Reference Value = 31.43 V/m; Power Drift = -0.00 dB

Peak SAR (extrapolated) = 1.40 W/kg

SAR(1 g) = 0.776 W/kg; SAR(10 g) = 0.455 W/kg

Maximum value of SAR (measured) = 1.11 W/kg

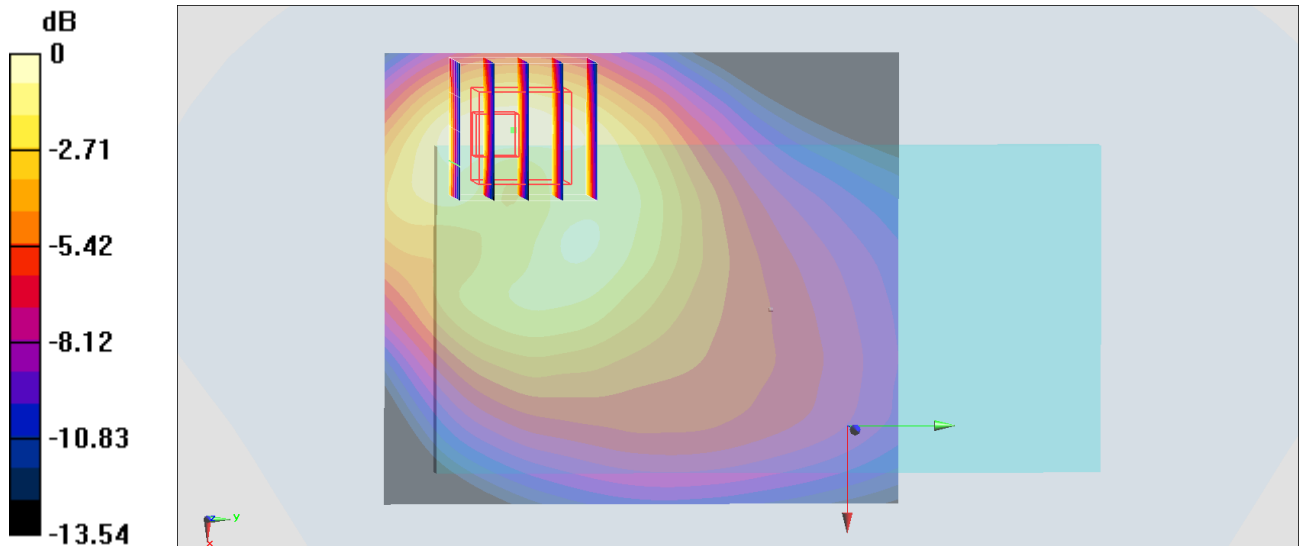

0 dB = 1.11 W/kg = 0.45 dBW/kg

#52_CDMA BC0_1xRTT RC3 SO32_Back_10mm_Ch777

Communication System: CDMA; Frequency: 848.31 MHz; Duty Cycle: 1:1

Medium: MSL_850_170517 Medium parameters used: $f = 848.31$ MHz; $\sigma = 0.974$ S/m; $\epsilon_r = 54.512$; $\rho = 1000$ kg/m³

Ambient Temperature : 23.4 °C ; Liquid Temperature : 22.4 °C

DASY5 Configuration:

- Probe: EX3DV4 - SN3976; ConvF(10.41, 10.41, 10.41); Calibrated: 2017/2/21;
- Sensor-Surface: 1.4mm (Mechanical Surface Detection)
- Electronics: DAE4 Sn1424; Calibrated: 2017/2/16
- Phantom: SAM-Right; Type: SAM; Serial: TP-1303
- Measurement SW: DASY52, Version 52.8 (8); SEMCAD X Version 14.6.10 (7373)

Area Scan (71x101x1): Interpolated grid: dx=1.500 mm, dy=1.500 mm

Maximum value of SAR (interpolated) = 1.24 W/kg

Zoom Scan (5x5x7)/Cube 0: Measurement grid: dx=8mm, dy=8mm, dz=5mm

Reference Value = 32.92 V/m; Power Drift = -0.03 dB

Peak SAR (extrapolated) = 1.49 W/kg

SAR(1 g) = 0.818 W/kg; SAR(10 g) = 0.479 W/kg

Maximum value of SAR (measured) = 1.20 W/kg

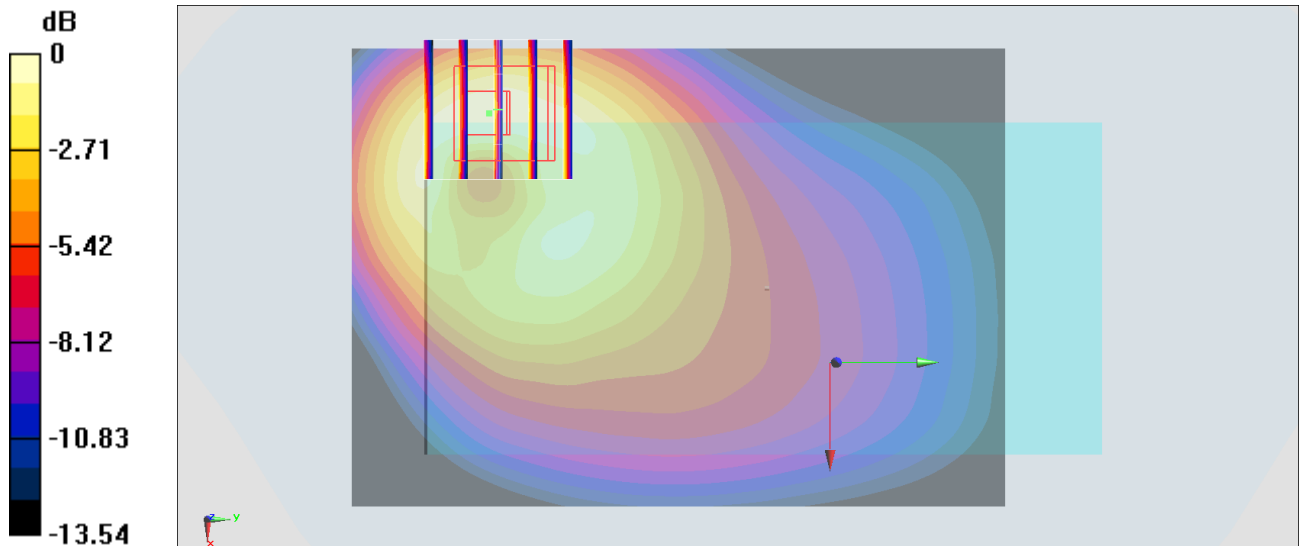

0 dB = 1.20 W/kg = 0.79 dBW/kg

#53_CDMA BC1_1xRTT RC3 SO32_Back_10mm_Ch600

Communication System: CDMA ; Frequency: 1880 MHz; Duty Cycle: 1:1

Medium: MSL_1900_170515 Medium parameters used: $f = 1880$ MHz; $\sigma = 1.544$ S/m; $\epsilon_r = 54.372$; $\rho = 1000$ kg/m³

Ambient Temperature : 23.4 °C ; Liquid Temperature : 22.4 °C

DASY5 Configuration:

- Probe: EX3DV4 - SN3976; ConvF(8.31, 8.31, 8.31); Calibrated: 2017/2/21;
- Sensor-Surface: 1.4mm (Mechanical Surface Detection)
- Electronics: DAE4 Sn1424; Calibrated: 2017/2/16
- Phantom: SAM-Right; Type: SAM; Serial: TP-1303
- Measurement SW: DASY52, Version 52.8 (8); SEMCAD X Version 14.6.10 (7373)

Area Scan (71x71x1): Interpolated grid: dx=1.500 mm, dy=1.500 mm

Maximum value of SAR (interpolated) = 1.32 W/kg

Zoom Scan (5x5x7)/Cube 0: Measurement grid: dx=8mm, dy=8mm, dz=5mm

Reference Value = 23.16 V/m; Power Drift = -0.01 dB

Peak SAR (extrapolated) = 1.41 W/kg

SAR(1 g) = 0.807 W/kg; SAR(10 g) = 0.434 W/kg

Maximum value of SAR (measured) = 1.17 W/kg

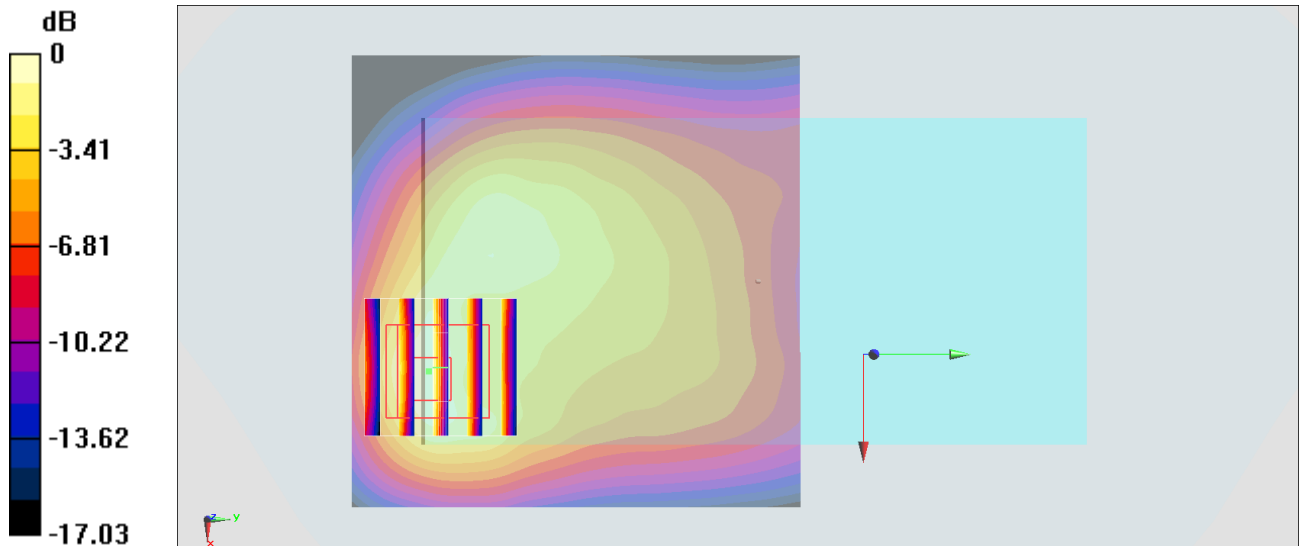

0 dB = 1.17 W/kg = 0.68 dBW/kg

#54_CDMA BC10_1xRTT RC3 SO32_Back_10mm_Ch580

Communication System: CDMA; Frequency: 820.5 MHz; Duty Cycle: 1:1

Medium: MSL_850_170517 Medium parameters used: $f = 820.5$ MHz; $\sigma = 0.948$ S/m; $\epsilon_r = 54.789$; $\rho = 1000$ kg/m³

Ambient Temperature : 23.4 °C ; Liquid Temperature : 22.4 °C

DASY5 Configuration:

- Probe: EX3DV4 - SN3976; ConvF(10.41, 10.41, 10.41); Calibrated: 2017/2/21;
- Sensor-Surface: 1.4mm (Mechanical Surface Detection)
- Electronics: DAE4 Sn1424; Calibrated: 2017/2/16
- Phantom: SAM-Right; Type: SAM; Serial: TP-1303
- Measurement SW: DASY52, Version 52.8 (8); SEMCAD X Version 14.6.10 (7373)

Area Scan (71x101x1): Interpolated grid: dx=1.500 mm, dy=1.500 mm

Maximum value of SAR (interpolated) = 1.11 W/kg

Zoom Scan (5x5x7)/Cube 0: Measurement grid: dx=8mm, dy=8mm, dz=5mm

Reference Value = 32.51 V/m; Power Drift = -0.05 dB

Peak SAR (extrapolated) = 1.42 W/kg

SAR(1 g) = 0.782 W/kg; SAR(10 g) = 0.435 W/kg

Maximum value of SAR (measured) = 1.17 W/kg

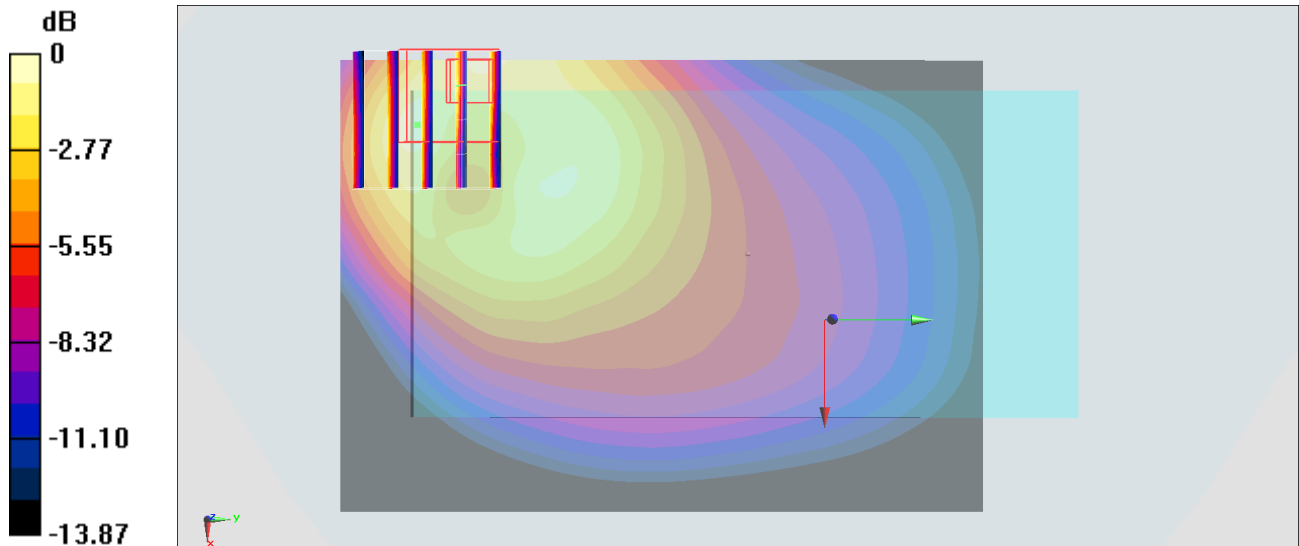

0 dB = 1.17 W/kg = 0.68 dBW/kg

#55_LTE Band 2_20M_QPSK_1_0_Back_10mm_Ch18900

Communication System: LTE ; Frequency: 1880 MHz;Duty Cycle: 1:1

Medium: MSL_1900_170512 Medium parameters used: $f = 1880$ MHz; $\sigma = 1.518$ S/m; $\epsilon_r = 54.01$; $\rho = 1000$ kg/m³

Ambient Temperature : 23.6 °C ; Liquid Temperature : 22.6 °C

DASY5 Configuration:

- Probe: EX3DV4 - SN3976; ConvF(8.31, 8.31, 8.31); Calibrated: 2017/2/21;
- Sensor-Surface: 1.4mm (Mechanical Surface Detection)
- Electronics: DAE4 Sn1424; Calibrated: 2017/2/16
- Phantom: SAM-Right; Type: SAM; Serial: TP-1303
- Measurement SW: DASY52, Version 52.8 (8);SEMCAD X Version 14.6.10 (7373)

Area Scan (71x61x1): Interpolated grid: dx=1.500 mm, dy=1.500 mm

Maximum value of SAR (interpolated) = 1.01 W/kg

Zoom Scan (5x5x7)/Cube 0: Measurement grid: dx=8mm, dy=8mm, dz=5mm

Reference Value = 21.45 V/m; Power Drift = -0.04 dB

Peak SAR (extrapolated) = 1.19 W/kg

SAR(1 g) = 0.675 W/kg; SAR(10 g) = 0.374 W/kg

Maximum value of SAR (measured) = 0.933 W/kg

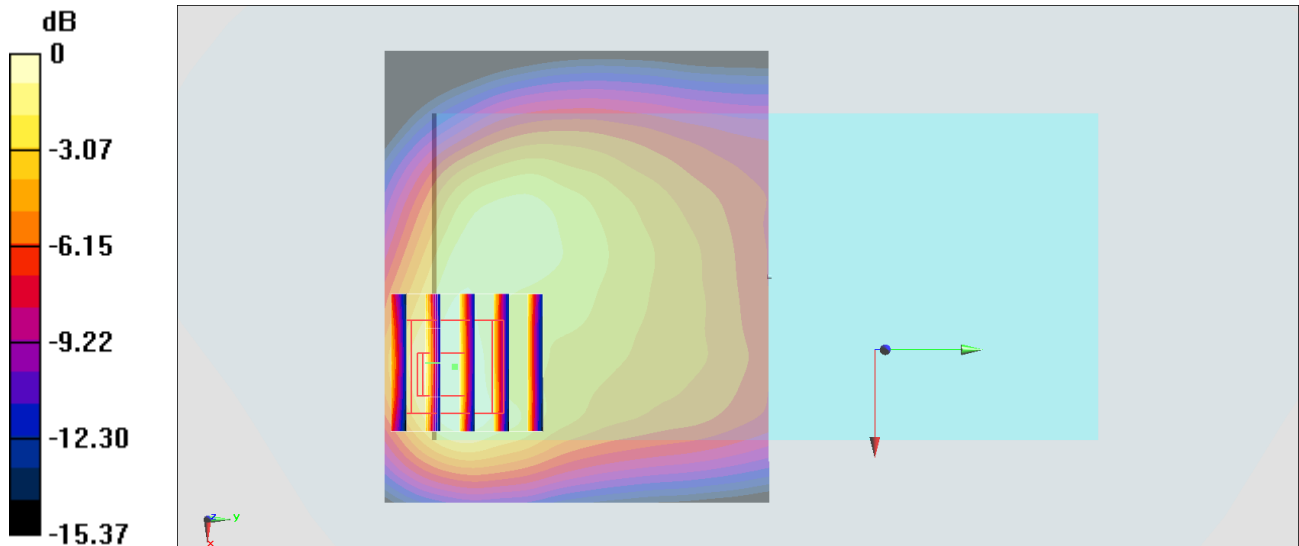

0 dB = 0.933 W/kg = -0.30 dBW/kg

#56_LTE Band 4_20M_QPSK_100_0_Back_10mm_Ch20175

Communication System: LTE; Frequency: 1732.5 MHz; Duty Cycle: 1:1

Medium: MSL_1750_170515 Medium parameters used: $f = 1732.5$ MHz; $\sigma = 1.468$ S/m; $\epsilon_r = 55.943$; $\rho = 1000$ kg/m³

Ambient Temperature : 23.4 °C ; Liquid Temperature : 22.4 °C

DASY5 Configuration:

- Probe: EX3DV4 - SN3976; ConvF(8.57, 8.57, 8.57); Calibrated: 2017/2/21;
- Sensor-Surface: 1.4mm (Mechanical Surface Detection)
- Electronics: DAE4 Sn1424; Calibrated: 2017/2/16
- Phantom: SAM-Right; Type: SAM; Serial: TP-1303
- Measurement SW: DASY52, Version 52.8 (8); SEMCAD X Version 14.6.10 (7373)

Area Scan (71x71x1): Interpolated grid: dx=1.500 mm, dy=1.500 mm

Maximum value of SAR (interpolated) = 1.06 W/kg

Zoom Scan (5x5x7)/Cube 0: Measurement grid: dx=8mm, dy=8mm, dz=5mm

Reference Value = 23.83 V/m; Power Drift = -0.02 dB

Peak SAR (extrapolated) = 1.14 W/kg

SAR(1 g) = 0.654 W/kg; SAR(10 g) = 0.371 W/kg

Maximum value of SAR (measured) = 0.895 W/kg

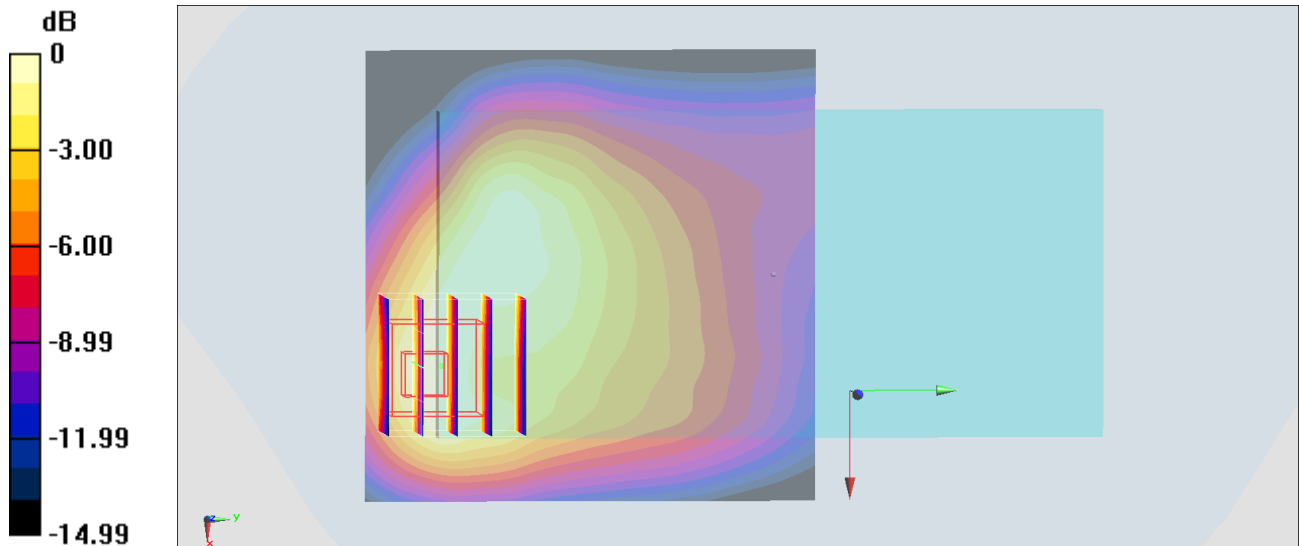

0 dB = 0.895 W/kg = -0.48 dBW/kg

#57_LTE Band 5_10M_QPSK_1_0_Back_10mm_Ch20525

Communication System: LTE; Frequency: 836.5 MHz; Duty Cycle: 1:1

Medium: MSL_850_170517 Medium parameters used: $f = 836.5$ MHz; $\sigma = 0.963$ S/m; $\epsilon_r = 54.627$; $\rho = 1000$ kg/m³

Ambient Temperature : 23.4 °C ; Liquid Temperature : 22.4 °C

DASY5 Configuration:

- Probe: EX3DV4 - SN3976; ConvF(10.41, 10.41, 10.41); Calibrated: 2017/2/21;
- Sensor-Surface: 1.4mm (Mechanical Surface Detection)
- Electronics: DAE4 Sn1424; Calibrated: 2017/2/16
- Phantom: SAM-Right; Type: SAM; Serial: TP-1303
- Measurement SW: DASY52, Version 52.8 (8); SEMCAD X Version 14.6.10 (7373)

Area Scan (71x81x1): Interpolated grid: dx=1.500 mm, dy=1.500 mm

Maximum value of SAR (interpolated) = 1.23 W/kg

Zoom Scan (5x5x7)/Cube 0: Measurement grid: dx=8mm, dy=8mm, dz=5mm

Reference Value = 33.40 V/m; Power Drift = -0.09 dB

Peak SAR (extrapolated) = 1.60 W/kg

SAR(1 g) = 0.836 W/kg; SAR(10 g) = 0.468 W/kg

Maximum value of SAR (measured) = 1.26 W/kg

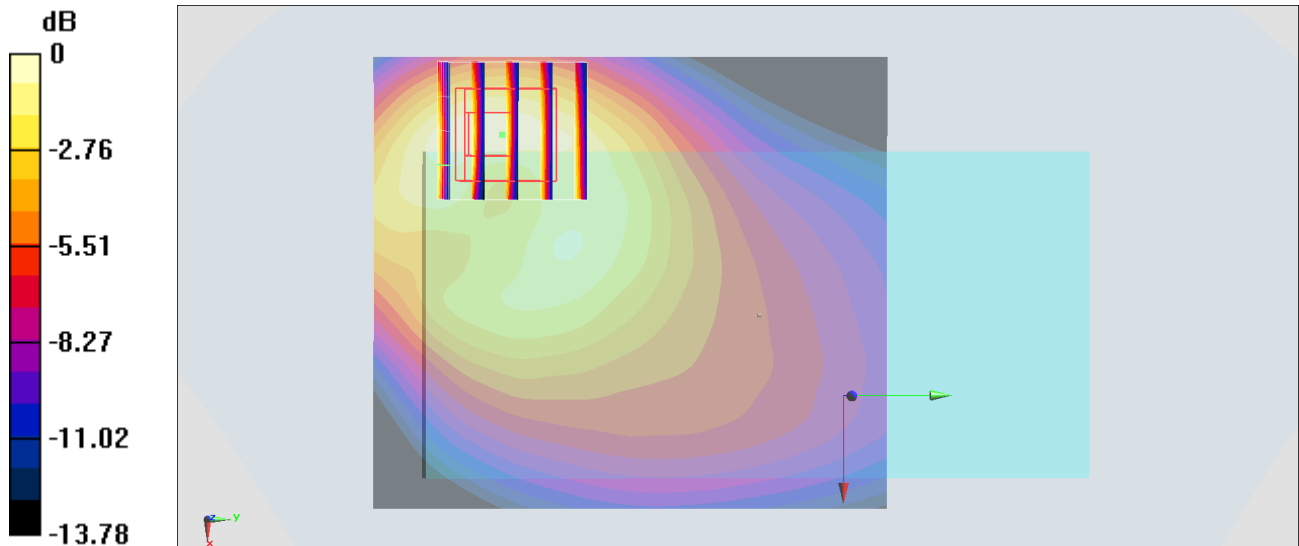

0 dB = 1.26 W/kg = 1.00 dBW/kg

#58_LTE Band 7_20M_QPSK_1_0_Front_10mm_Ch21100

Communication System: LTE ; Frequency: 2535 MHz;Duty Cycle: 1:1

Medium: MSL_2600_170513 Medium parameters used : $f = 2535$ MHz; $\sigma = 2.067$ S/m; $\epsilon_r = 52.467$; $\rho = 1000$ kg/m³

Ambient Temperature : 23.4 °C ; Liquid Temperature : 22.4 °C

DASY5 Configuration:

- Probe: EX3DV4 - SN3976; ConvF(7.59, 7.59, 7.59); Calibrated: 2017/2/21;
- Sensor-Surface: 1.4mm (Mechanical Surface Detection)
- Electronics: DAE4 Sn1424; Calibrated: 2017/2/16
- Phantom: SAM-Right; Type: SAM; Serial: TP-1303
- Measurement SW: DASY52, Version 52.8 (8);SEMCAD X Version 14.6.10 (7373)

Area Scan (91x81x1): Interpolated grid: dx=1.200 mm, dy=1.200 mm

Maximum value of SAR (interpolated) = 1.30 W/kg

Zoom Scan (7x7x7)/Cube 0: Measurement grid: dx=5mm, dy=5mm, dz=5mm

Reference Value = 19.12 V/m; Power Drift = -0.16 dB

Peak SAR (extrapolated) = 1.55 W/kg

SAR(1 g) = 0.807 W/kg; SAR(10 g) = 0.405 W/kg

Maximum value of SAR (measured) = 1.22 W/kg

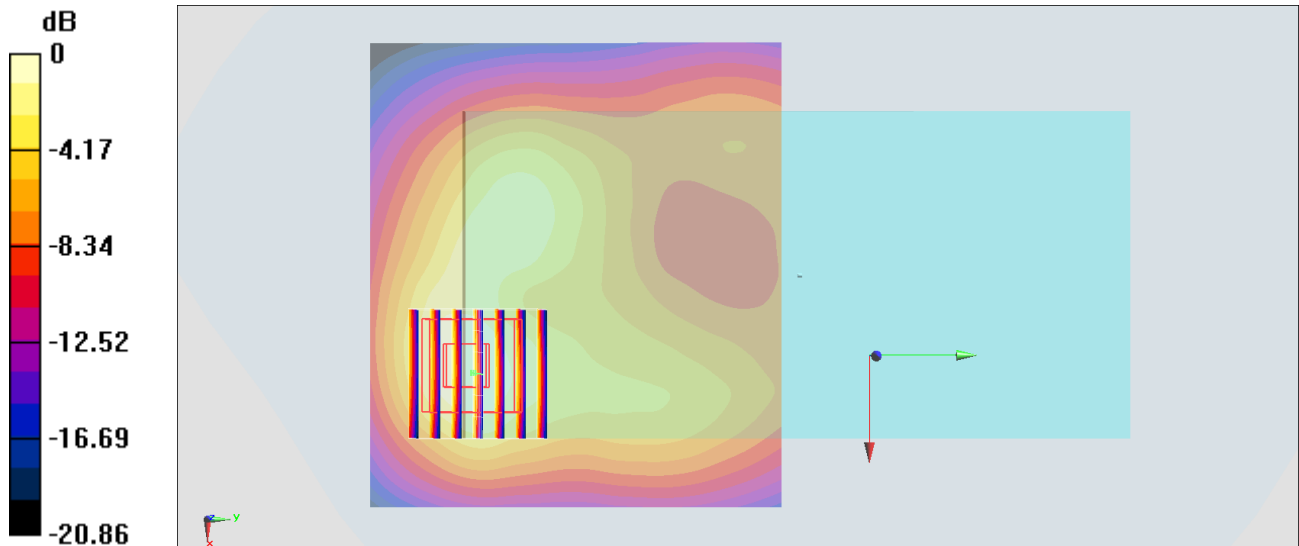

0 dB = 1.22 W/kg = 0.86 dBW/kg

#59_LTE Band 12_10M_QPSK_1_0_Front_10mm_Ch23095

Communication System: LTE; Frequency: 707.5 MHz; Duty Cycle: 1:1

Medium: MSL_750_170518 Medium parameters used: $f = 707.5$ MHz; $\sigma = 0.936$ S/m; $\epsilon_r = 54.755$; $\rho = 1000$ kg/m³

Ambient Temperature : 23.5 °C ; Liquid Temperature : 22.5 °C

DASY5 Configuration:

- Probe: EX3DV4 - SN3976; ConvF(10.68, 10.68, 10.68); Calibrated: 2017/2/21;
- Sensor-Surface: 1.4mm (Mechanical Surface Detection)
- Electronics: DAE4 Sn1424; Calibrated: 2017/2/16
- Phantom: SAM-Right; Type: SAM; Serial: TP-1303
- Measurement SW: DASY52, Version 52.8 (8); SEMCAD X Version 14.6.10 (7373)

Area Scan (71x81x1): Interpolated grid: dx=1.500 mm, dy=1.500 mm

Maximum value of SAR (interpolated) = 1.03 W/kg

Zoom Scan (5x5x7)/Cube 0: Measurement grid: dx=8mm, dy=8mm, dz=5mm

Reference Value = 33.37 V/m; Power Drift = -0.05 dB

Peak SAR (extrapolated) = 1.39 W/kg

SAR(1 g) = 0.750 W/kg; SAR(10 g) = 0.433 W/kg

Maximum value of SAR (measured) = 1.14 W/kg

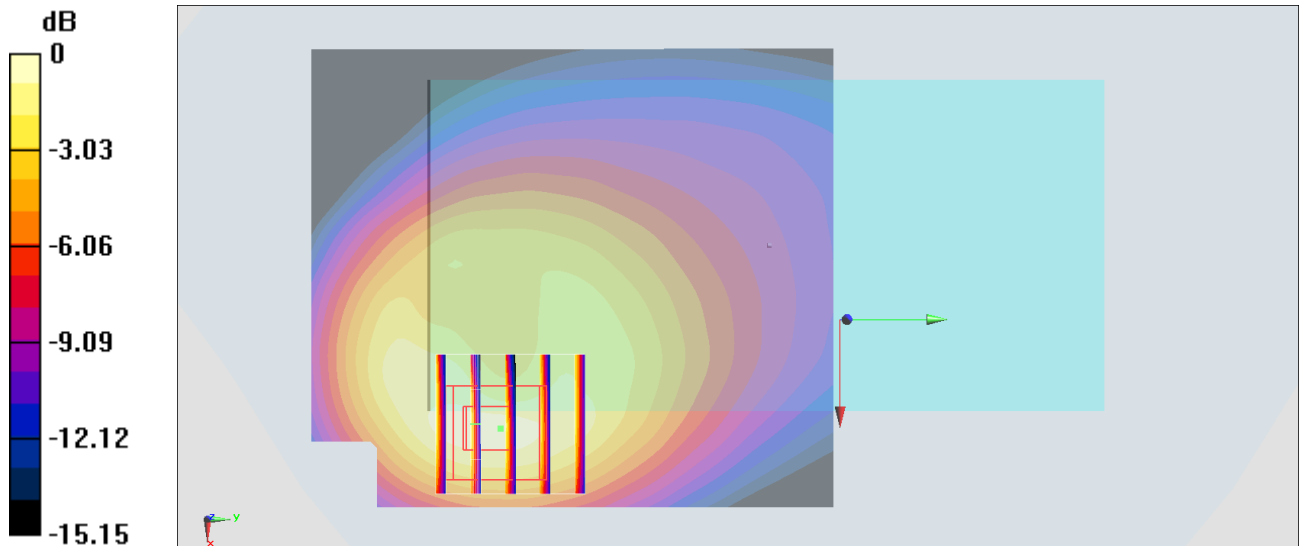

0 dB = 1.14 W/kg = 0.57 dBW/kg

#60_LTE Band 17_10M_QPSK_1_0_Front_10mm_Ch23790

Communication System: LTE; Frequency: 710 MHz; Duty Cycle: 1:1

Medium: MSL_750_170518 Medium parameters used: $f = 710$ MHz; $\sigma = 0.939$ S/m; $\epsilon_r = 54.731$; $\rho = 1000$ kg/m³

Ambient Temperature : 23.5 °C ; Liquid Temperature : 22.5 °C

DASY5 Configuration:

- Probe: EX3DV4 - SN3976; ConvF(10.68, 10.68, 10.68); Calibrated: 2017/2/21;
- Sensor-Surface: 1.4mm (Mechanical Surface Detection)
- Electronics: DAE4 Sn1424; Calibrated: 2017/2/16
- Phantom: SAM-Right; Type: SAM; Serial: TP-1303
- Measurement SW: DASY52, Version 52.8 (8); SEMCAD X Version 14.6.10 (7373)

Area Scan (71x81x1): Interpolated grid: dx=1.500 mm, dy=1.500 mm

Maximum value of SAR (interpolated) = 1.04 W/kg

Zoom Scan (5x5x7)/Cube 0: Measurement grid: dx=8mm, dy=8mm, dz=5mm

Reference Value = 33.38 V/m; Power Drift = -0.14 dB

Peak SAR (extrapolated) = 1.39 W/kg

SAR(1 g) = 0.743 W/kg; SAR(10 g) = 0.425 W/kg

Maximum value of SAR (measured) = 1.14 W/kg

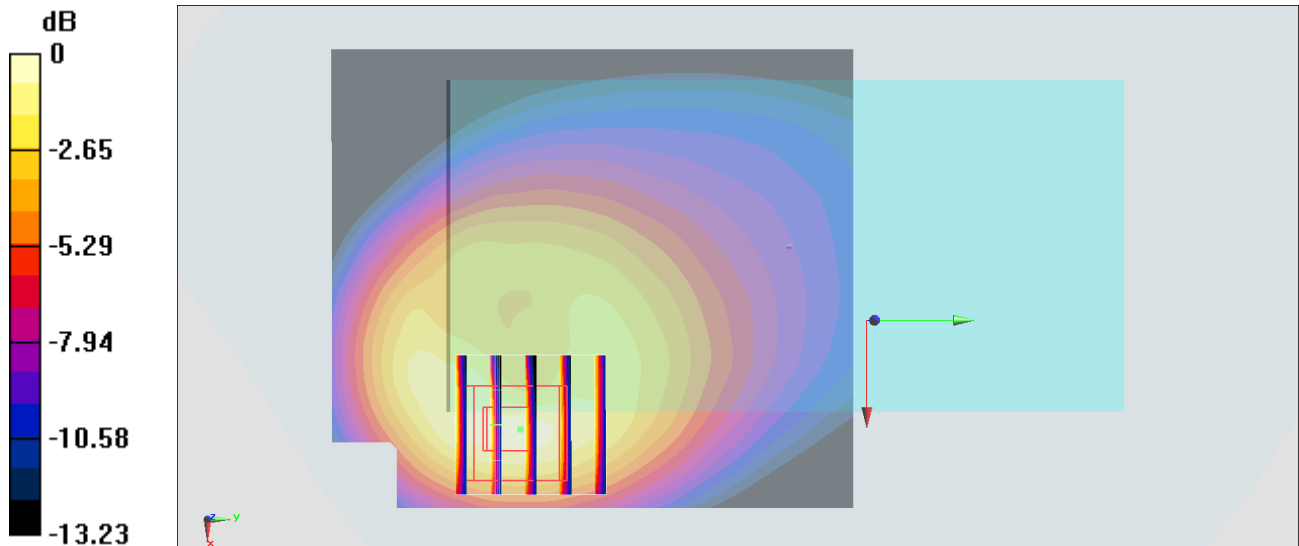

0 dB = 1.14 W/kg = 0.57 dBW/kg

#61_LTE Band 26_15M_QPSK_1_0_Back_10mm_Ch26865

Communication System: LTE; Frequency: 831.5 MHz; Duty Cycle: 1:1

Medium: MSL_850_170517 Medium parameters used: $f = 831.5$ MHz; $\sigma = 0.958$ S/m; $\epsilon_r = 54.678$; $\rho = 1000$ kg/m³

Ambient Temperature : 23.4 °C ; Liquid Temperature : 22.4 °C

DASY5 Configuration:

- Probe: EX3DV4 - SN3976; ConvF(10.41, 10.41, 10.41); Calibrated: 2017/2/21;
- Sensor-Surface: 1.4mm (Mechanical Surface Detection)
- Electronics: DAE4 Sn1424; Calibrated: 2017/2/16
- Phantom: SAM-Right; Type: SAM; Serial: TP-1303
- Measurement SW: DASY52, Version 52.8 (8); SEMCAD X Version 14.6.10 (7373)

Area Scan (71x81x1): Interpolated grid: dx=1.500 mm, dy=1.500 mm

Maximum value of SAR (interpolated) = 1.22 W/kg

Zoom Scan (5x5x7)/Cube 0: Measurement grid: dx=8mm, dy=8mm, dz=5mm

Reference Value = 33.38 V/m; Power Drift = -0.02 dB

Peak SAR (extrapolated) = 1.59 W/kg

SAR(1 g) = 0.861 W/kg; SAR(10 g) = 0.505 W/kg

Maximum value of SAR (measured) = 1.25 W/kg

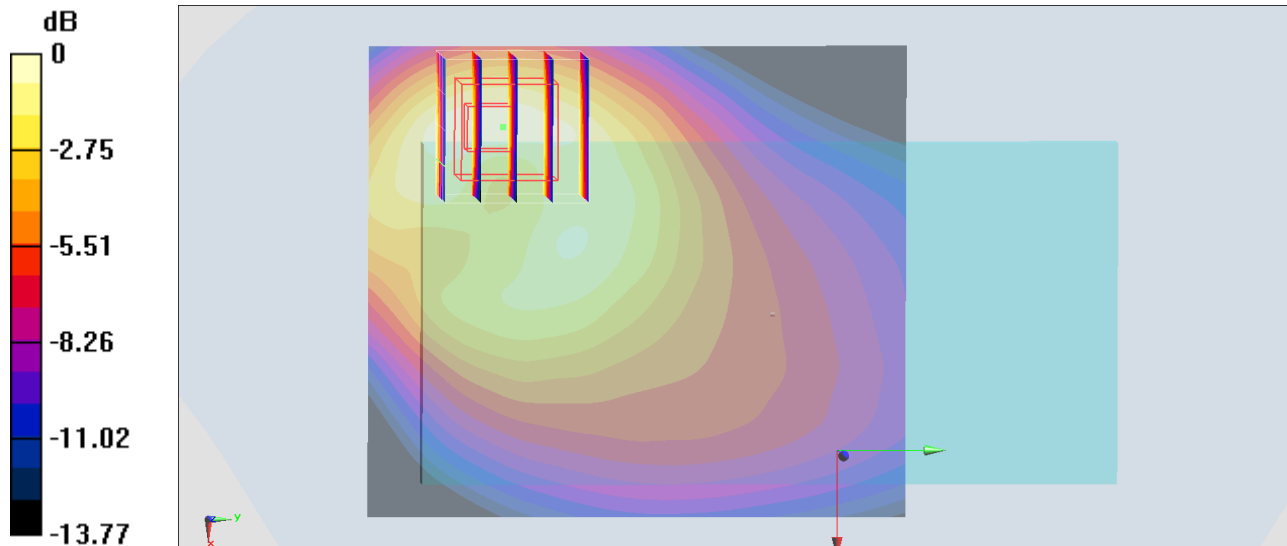

0 dB = 1.25 W/kg = 0.97 dBW/kg

#62_LTE Band 38_20M_QPSK_1_0_Front_10mm_Ch38150

Communication System: LTE ; Frequency: 2610 MHz;Duty Cycle: 1:1.59

Medium: MSL_2600_170514 Medium parameters used: $f = 2610$ MHz; $\sigma = 2.179$ S/m; $\epsilon_r = 52.701$; $\rho = 1000$ kg/m³

Ambient Temperature : 23.5 °C ; Liquid Temperature : 22.5 °C

DASY5 Configuration:

- Probe: EX3DV4 - SN3976; ConvF(7.59, 7.59, 7.59); Calibrated: 2017/2/21;
- Sensor-Surface: 1.4mm (Mechanical Surface Detection)
- Electronics: DAE4 Sn1424; Calibrated: 2017/2/16
- Phantom: SAM-Right; Type: SAM; Serial: TP-1303
- Measurement SW: DASY52, Version 52.8 (8);SEMCAD X Version 14.6.10 (7373)

Area Scan (91x81x1): Interpolated grid: dx=1.200 mm, dy=1.200 mm

Maximum value of SAR (interpolated) = 1.06 W/kg

Zoom Scan (7x7x7)/Cube 0: Measurement grid: dx=5mm, dy=5mm, dz=5mm

Reference Value = 16.60 V/m; Power Drift = -0.12 dB

Peak SAR (extrapolated) = 1.27 W/kg

SAR(1 g) = 0.634 W/kg; SAR(10 g) = 0.311 W/kg

Maximum value of SAR (measured) = 0.987 W/kg

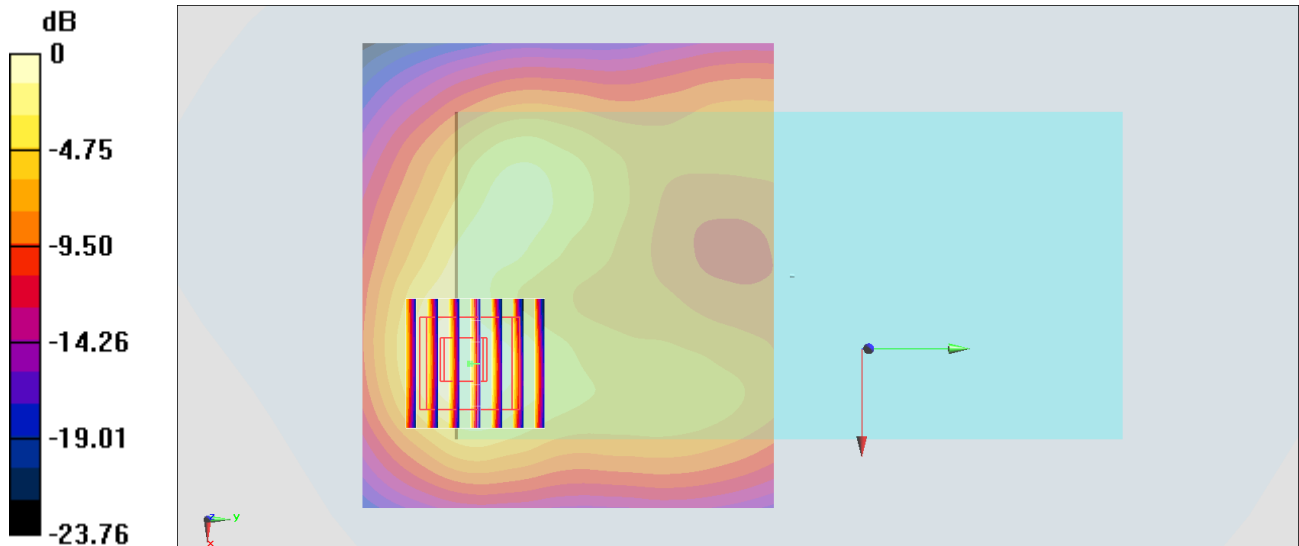

0 dB = 0.987 W/kg = -0.06 dBW/kg

#63_LTE Band 41_20M_QPSK_1_0_Back_10mm_Ch41140

Communication System: LTE ; Frequency: 2645 MHz;Duty Cycle: 1:1.59

Medium: MSL_2600_170513 Medium parameters used : $f = 2645$ MHz; $\sigma = 2.219$ S/m; $\epsilon_r = 52.052$; $\rho = 1000$ kg/m³

Ambient Temperature : 23.4 °C ; Liquid Temperature : 22.4 °C

DASY5 Configuration:

- Probe: EX3DV4 - SN3976; ConvF(7.59, 7.59, 7.59); Calibrated: 2017/2/21;
- Sensor-Surface: 1.4mm (Mechanical Surface Detection)
- Electronics: DAE4 Sn1424; Calibrated: 2017/2/16
- Phantom: SAM-Right; Type: SAM; Serial: TP-1303
- Measurement SW: DASY52, Version 52.8 (8);SEMCAD X Version 14.6.10 (7373)

Area Scan (91x81x1): Interpolated grid: dx=1.200 mm, dy=1.200 mm

Maximum value of SAR (interpolated) = 0.828 W/kg

Zoom Scan (7x7x7)/Cube 0: Measurement grid: dx=5mm, dy=5mm, dz=5mm

Reference Value = 13.63 V/m; Power Drift = 0.12 dB

Peak SAR (extrapolated) = 1.01 W/kg

SAR(1 g) = 0.481 W/kg; SAR(10 g) = 0.240 W/kg

Maximum value of SAR (measured) = 0.780 W/kg

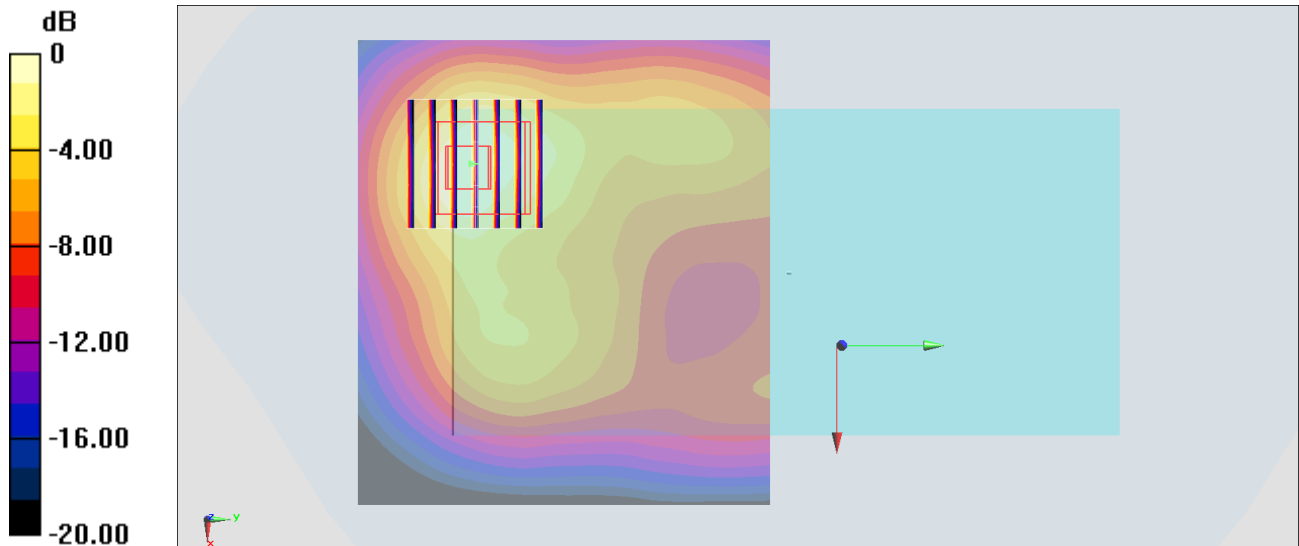

0 dB = 0.780 W/kg = -1.08 dBW/kg

#64_WLAN2.4GHz_802.11b 1Mbps_Back_10mm_Ch11;Ant 2

Communication System: 802.11b; Frequency: 2462 MHz; Duty Cycle: 1:1

Medium: MSL_2450_170423 Medium parameters used: $f = 2462$ MHz; $\sigma = 2.04$ S/m; $\epsilon_r = 52.141$; $\rho = 1000$ kg/m³

Ambient Temperature : 23.4 °C; Liquid Temperature : 22.4 °C

DASY5 Configuration:

- Probe: EX3DV4 - SN3931; ConvF(7.73, 7.73, 7.73); Calibrated: 2016/10/3;
- Sensor-Surface: 1.4mm (Mechanical Surface Detection)
- Electronics: DAE3 Sn577; Calibrated: 2016/9/28
- Phantom: SAM-Right; Type: SAM; Serial: TP-1303
- Measurement SW: DASY52, Version 52.8 (8); SEMCAD X Version 14.6.10 (7373)

Area Scan (91x71x1): Interpolated grid: dx=1.200 mm, dy=1.200 mm

Maximum value of SAR (interpolated) = 0.532 W/kg

Zoom Scan (7x7x7)/Cube 0: Measurement grid: dx=5mm, dy=5mm, dz=5mm

Reference Value = 5.238 V/m; Power Drift = -0.05 dB

Peak SAR (extrapolated) = 0.641 W/kg

SAR(1 g) = 0.255 W/kg; SAR(10 g) = 0.173 W/kg

Maximum value of SAR (measured) = 0.527 W/kg

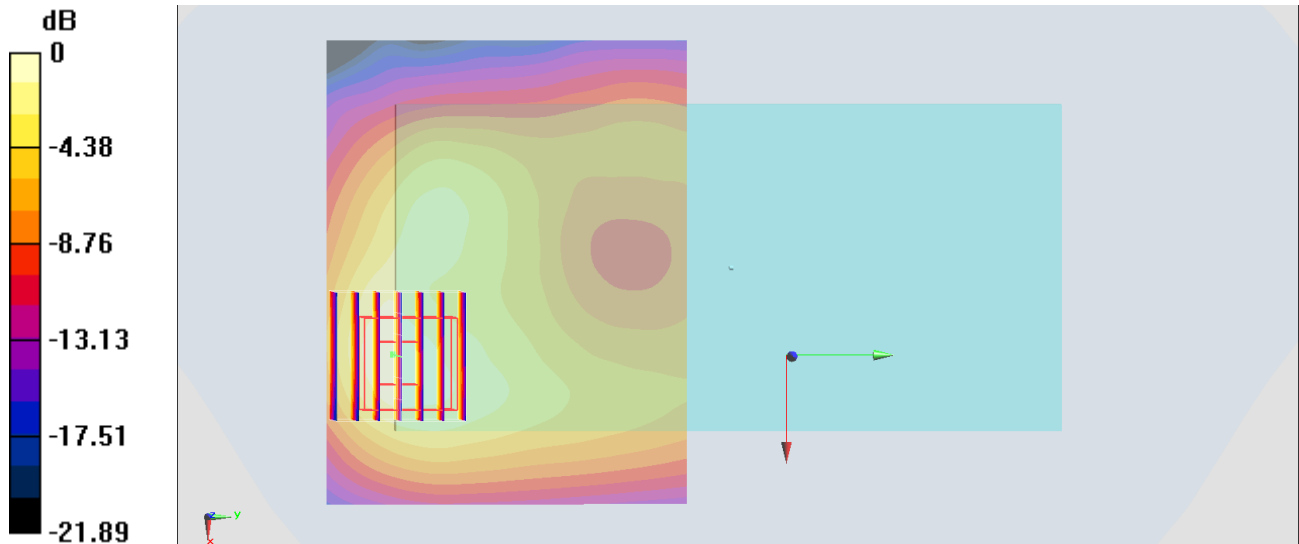

0 dB = 0.527 W/kg = -2.78 dBW/kg

#65_WLAN5GHz_802.11a 6Mbps_Back_10mm_Ch56;Ant 2

Communication System: 802.11a ; Frequency: 5280 MHz; Duty Cycle: 1:1.054

Medium: MSL_5G_170427 Medium parameters used: $f = 5280$ MHz; $\sigma = 5.268$ S/m; $\epsilon_r = 46.88$; $\rho = 1000$ kg/m³

Ambient Temperature : 23.4 °C ; Liquid Temperature : 22.4 °C

DASY5 Configuration:

- Probe: EX3DV4 - SN3931; ConvF(4.57, 4.57, 4.57); Calibrated: 2016/10/3;
- Sensor-Surface: 1.4mm (Mechanical Surface Detection)
- Electronics: DAE3 Sn577; Calibrated: 2016/9/28
- Phantom: SAM-Right; Type: SAM; Serial: TP-1303
- Measurement SW: DASY52, Version 52.8 (8); SEMCAD X Version 14.6.10 (7373)

Area Scan (101x91x1): Interpolated grid: dx=1.000 mm, dy=1.000 mm

Maximum value of SAR (interpolated) = 0.308 W/kg

Zoom Scan (7x7x7)/Cube 0: Measurement grid: dx=4mm, dy=4mm, dz=1.4mm

Reference Value = 3.168 V/m; Power Drift = 0.02 dB

Peak SAR (extrapolated) = 0.527 W/kg

SAR(1 g) = 0.147 W/kg; SAR(10 g) = 0.043 W/kg

Maximum value of SAR (measured) = 0.321 W/kg

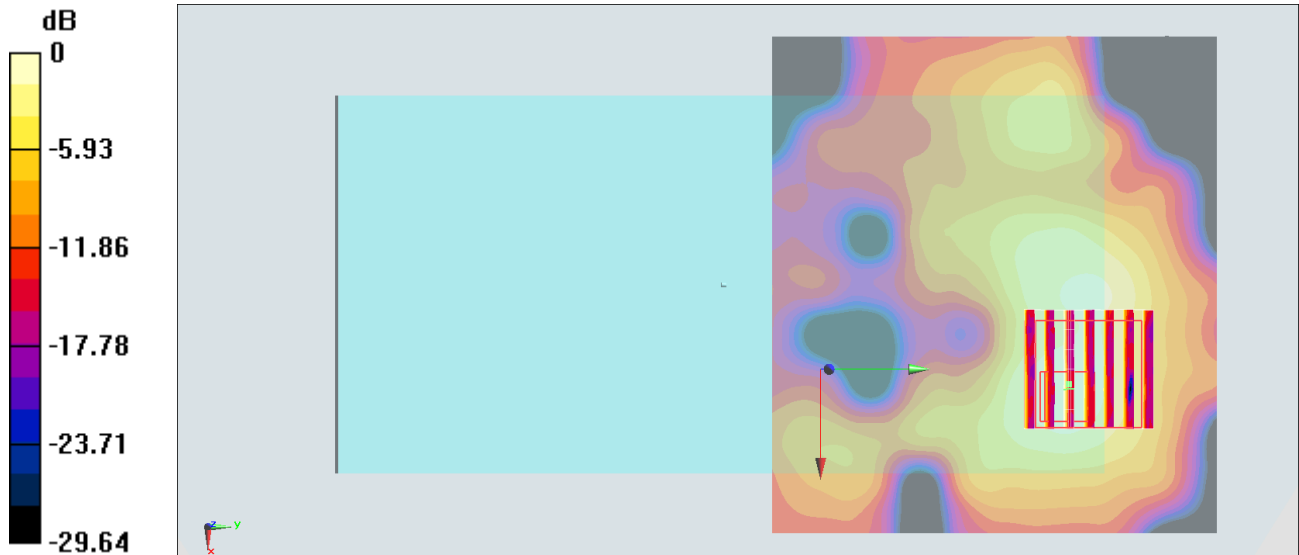

0 dB = 0.321 W/kg = -4.93 dBW/kg

#66_WLAN5GHz_802.11ac-VHT80 MCS0_Front_10mm_Ch138;Ant 2

Communication System: 802.11ac ; Frequency: 5690 MHz;Duty Cycle: 1:1.156

Medium: MSL_5G_170427 Medium parameters used: $f = 5690$ MHz; $\sigma = 5.777$ S/m; $\epsilon_r = 46.254$; $\rho = 1000$ kg/m³

Ambient Temperature : 23.4 °C ; Liquid Temperature : 22.4 °C

DASY5 Configuration:

- Probe: EX3DV4 - SN3931; ConvF(3.71, 3.71, 3.71); Calibrated: 2016/10/3;
- Sensor-Surface: 1.4mm (Mechanical Surface Detection)
- Electronics: DAE3 Sn577; Calibrated: 2016/9/28
- Phantom: SAM-Right; Type: SAM; Serial: TP-1303
- Measurement SW: DASY52, Version 52.8 (8);SEMCAD X Version 14.6.10 (7373)

Area Scan (101x91x1): Interpolated grid: dx=1.000 mm, dy=1.000 mm

Maximum value of SAR (interpolated) = 0.300 W/kg

Zoom Scan (7x7x7)/Cube 0: Measurement grid: dx=4mm, dy=4mm, dz=1.4mm

Reference Value = 5.294 V/m; Power Drift = -0.12 dB

Peak SAR (extrapolated) = 0.481 W/kg

SAR(1 g) = 0.133 W/kg; SAR(10 g) = 0.042 W/kg

Maximum value of SAR (measured) = 0.306 W/kg

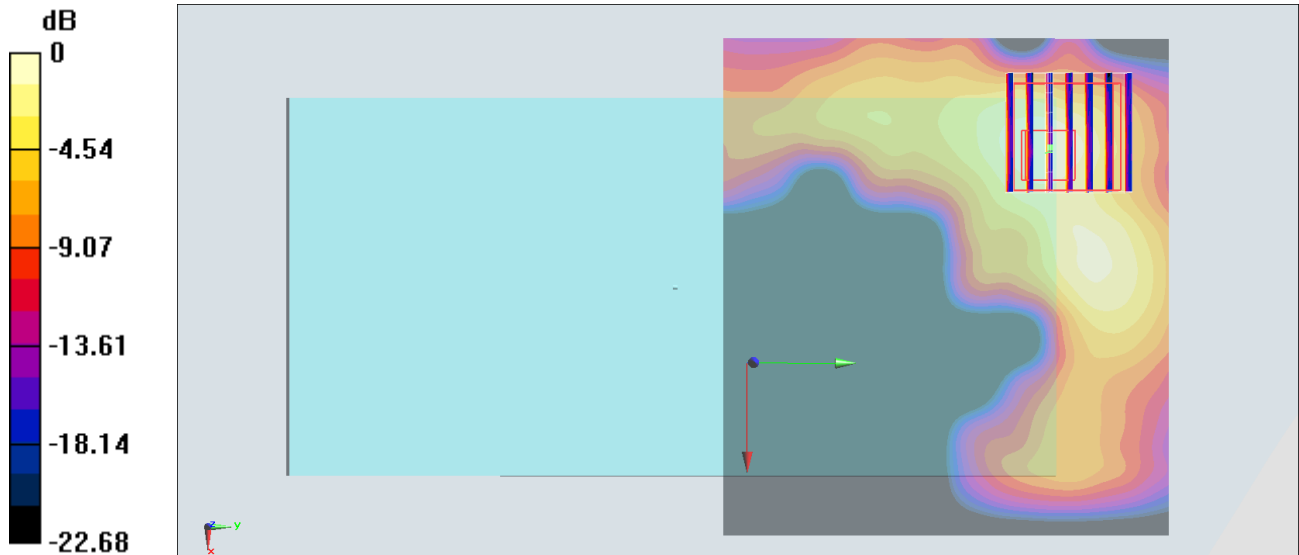

0 dB = 0.306 W/kg = -5.14 dBW/kg

#67_WLAN5GHz_802.11ac-VHT80 MCS0_Front_10mm_Ch155;Ant 2

Communication System: 802.11ac; Frequency: 5775 MHz;Duty Cycle: 1:1.167

Medium: MSL_5G_170417 Medium parameters used: $f = 5775$ MHz; $\sigma = 6.2$ mho/m; $\epsilon_r = 46.2$; $\rho = 1000$ kg/m³

Ambient Temperature : 23.7 °C ; Liquid Temperature : 22.7 °C

DASY4 Configuration:

- Probe: EX3DV4 - SN3925; ConvF(3.85, 3.85, 3.85); Calibrated: 2016/5/26
- Sensor-Surface: 1.4mm (Mechanical Surface Detection)
- Electronics: DAE3 Sn495; Calibrated: 2016/5/27
- Phantom: SAM_Right; Type: QD000P40CD; Serial: TP:1815
- ;Postprocessing SW: SEMCAD, V1.8 Build 159

Area Scan (101x91x1): Measurement grid: dx=10mm, dy=10mm

Maximum value of SAR (interpolated) = 0.369 mW/g

Zoom Scan (7x7x7)/Cube 0: Measurement grid: dx=4mm, dy=4mm, dz=1.4mm

Reference Value = 7.40 V/m; Power Drift = 0.079 dB

Peak SAR (extrapolated) = 0.626 W/kg

SAR(1 g) = 0.161 mW/g; SAR(10 g) = 0.053 mW/g

Maximum value of SAR (measured) = 0.399 mW/g

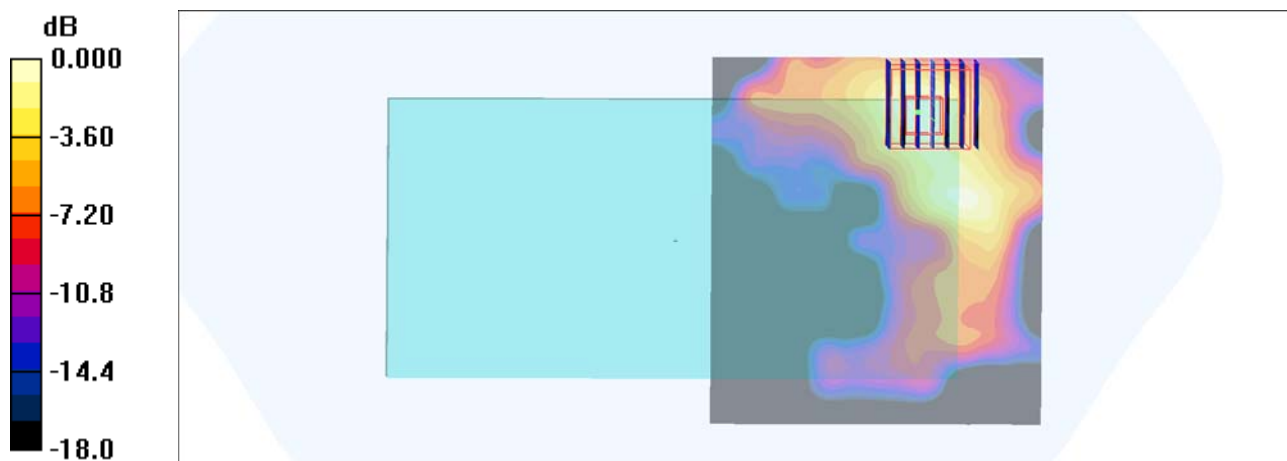

0 dB = 0.399mW/g

#68_Bluetooth_1Mbps_Back_10mm_Ch78;Ant 1

Communication System: Bluetooth; Frequency: 2480 MHz; Duty Cycle: 1:1.305

Medium: MSL_2450_170423 Medium parameters used: $f = 2480$ MHz; $\sigma = 2.041$ S/m; $\epsilon_r = 52.071$; $\rho = 1000$ kg/m³

Ambient Temperature : 23.4 °C ; Liquid Temperature : 22.4 °C

DASY5 Configuration:

- Probe: EX3DV4 - SN3931; ConvF(7.73, 7.73, 7.73); Calibrated: 2016/10/3;
- Sensor-Surface: 1.4mm (Mechanical Surface Detection)
- Electronics: DAE3 Sn577; Calibrated: 2016/9/28
- Phantom: SAM-Right; Type: SAM; Serial: TP-1303
- Measurement SW: DASY52, Version 52.8 (8); SEMCAD X Version 14.6.10 (7373)

Area Scan (91x71x1): Interpolated grid: dx=1.200 mm, dy=1.200 mm

Maximum value of SAR (interpolated) = 0.0379 W/kg

Zoom Scan (7x7x7)/Cube 0: Measurement grid: dx=5mm, dy=5mm, dz=5mm

Reference Value = 2.415 V/m; Power Drift = -0.18 dB

Peak SAR (extrapolated) = 0.0440 W/kg

SAR(1 g) = 0.023 W/kg; SAR(10 g) = 0.012 W/kg

Maximum value of SAR (measured) = 0.0361 W/kg

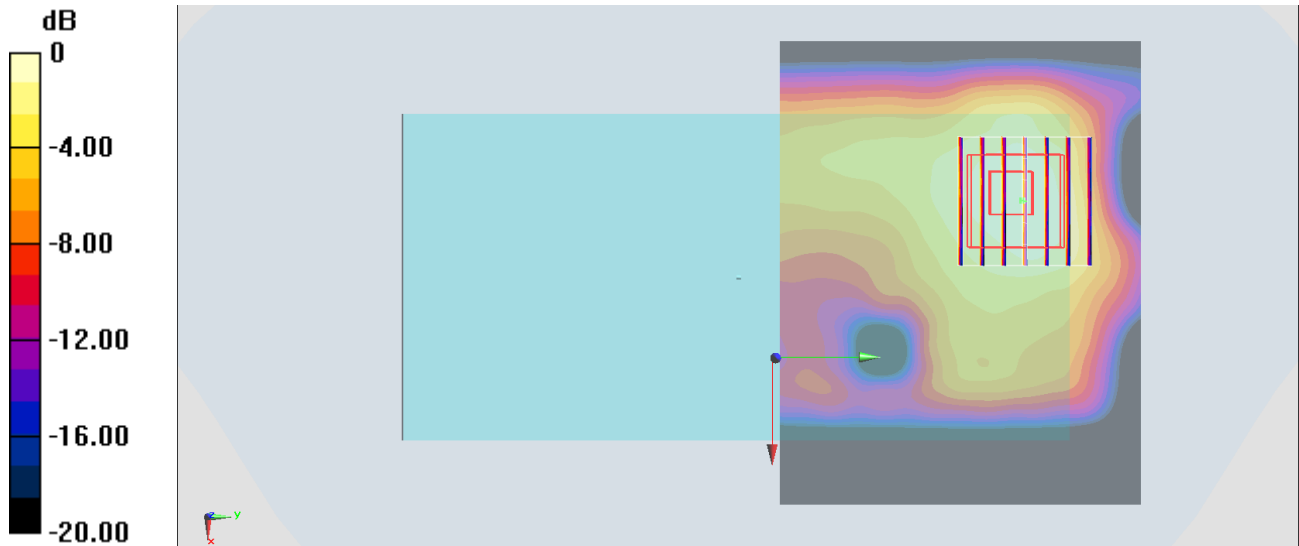

0 dB = 0.0361 W/kg = -14.42 dBW/kg