



FCC RF Test Report

APPLICANT : Motorola Mobility, LLC
EQUIPMENT : Mobile Cellular Phone
BRAND NAME : Motorola
MODEL NAME : 10720
FCC ID : IHDT56WB2
STANDARD : FCC Part 15 Subpart E §15.407
CLASSIFICATION : (NII) Unlicensed National Information Infrastructure

This is a variant report which is only valid together with the original test report. The product was received on Mar. 31, 2017 and testing was completed on May 06, 2017. We, SPORTON INTERNATIONAL INC., would like to declare that the tested sample has been evaluated in accordance with the test procedures and has been in compliance with the applicable technical standards.

The test results in this report apply exclusively to the tested model / sample. Without written approval of SPORTON INTERNATIONAL INC., the test report shall not be reproduced except in full.

Reviewed by: Joseph Lin / Supervisor

Approved by: Jones Tsai / Manager



SPORTON INTERNATIONAL INC.

No. 52, Hwa Ya 1st Rd., Hwa Ya Technology Park, Kwei-Shan District, Tao Yuan City, Taiwan, R.O.C.

SPORTON INTERNATIONAL INC.

TEL : 886-3-327-3456

FAX : 886-3-328-4978

FCC ID : IHDT56WB2

Page Number : 1 of 22

Report Issued Date : May 19, 2017

Report Version : Rev. 01

Report Template No.: BU5-FR15EWLB4 AC MA Version 1.5



TABLE OF CONTENTS

REVISION HISTORY..... 3

SUMMARY OF TEST RESULT 4

1 GENERAL DESCRIPTION 5

 1.1 Applicant 5

 1.2 Manufacturer 5

 1.3 Product Feature of Equipment Under Test..... 5

 1.4 Product Specification of Equipment Under Test..... 7

 1.5 Modification of EUT 7

 1.6 Testing Location 8

 1.7 Applicable Standards..... 9

2 TEST CONFIGURATION OF EQUIPMENT UNDER TEST 10

 2.1 Carrier Frequency and Channel 10

 2.2 Test Mode 10

 2.3 Connection Diagram of Test System 11

 2.4 EUT Operation Test Setup 11

3 TEST RESULT 12

 3.1 Maximum Conducted Output Power Measurement 12

 3.2 Unwanted Emissions Measurement 13

 3.3 Automatically Discontinue Transmission 19

 3.4 Antenna Requirements 20

4 LIST OF MEASURING EQUIPMENT 21

5 UNCERTAINTY OF EVALUATION 22

APPENDIX A. CONDUCTED TEST RESULTS

APPENDIX B. RADIATED SPURIOUS EMISSION

APPENDIX C. RADIATED SPURIOUS EMISSION PLOTS

APPENDIX D. DUTY CYCLE PLOTS

APPENDIX E. ORIGINAL REPORT



SUMMARY OF TEST RESULT

Report Section	FCC Rule	Description	Limit	Result	Remark
3.1	15.407(a)	Maximum Conducted Output Power	≤ 30 dBm	Pass	-
3.2	15.407(b)	Unwanted Emissions	15.407(b)(4)(i)	Pass	Under limit 10.56 dB at 67.800 MHz
3.3	15.407(c)	Automatically Discontinue Transmission	Discontinue Transmission	Pass	-
3.4	15.203 & 15.407(a)	Antenna Requirement	N/A	Pass	-



1 General Description

1.1 Applicant

Motorola Mobility, LLC

222 W Merchandise Mart Plaza, Suite 1800, Chicago, IL 60654, United States

1.2 Manufacturer

Motorola Mobility, LLC

222 W Merchandise Mart Plaza, Suite 1800, Chicago, IL 60654, United States

1.3 Product Feature of Equipment Under Test

Product Feature	
Equipment	Mobile Cellular Phone
Brand Name	Motorola
Model Name	10720
FCC ID	IHDT56WB2
IMEI Code	990007530005609
EUT supports Radios application	CDMA/EV-DO/GSM/EGPRS/WCDMA/HSPA/LTE/NFC WLAN 11b/g/n HT20 WLAN 11a/n HT20/HT40 WLAN 11ac VHT20/VHT40/VHT80 Bluetooth BR/EDR/LE
HW Version	DVT2
EUT Stage	Identical Prototype

Remark:

1. The above EUT's information was declared by manufacturer. Please refer to the specifications or user's manual for more detailed description.
2. This is a variant report. All the test cases were performed on original report which can be referred to Sporton Report Number FR733129F.



Accessory List		
AC Adapter 1	Brand Name :	Motorola
	Model Name :	SPN5970A
AC Adapter 2	Brand Name :	Motorola
	Model Name :	SPN5993A
AC Adapter 3	Brand Name :	Motorola
	Model Name :	SPN5978A
Battery 1	Brand Name :	Motorola
	Model Name :	SNN5986A
Battery 2	Brand Name :	Motorola
	Model Name :	SNN5897A
Earphone	Brand Name :	Motorola
	Model Name :	SH38C16618
USB Cable	Brand Name :	Motorola
	Model Name :	SKN6473A
USB-C Data Cable	Brand Name :	Motorola
	Model Name :	SKN6474A



1.4 Product Specification of Equipment Under Test

Standards-related Product Specification										
Tx/Rx Channel Frequency Range	5745 MHz ~ 5825 MHz									
Maximum Output Power	<p><Ant. 1> 802.11a : 17.24 dBm / 0.0530 W 802.11n HT20 : 17.31 dBm / 0.0538 W 802.11n HT40 : 16.57 dBm / 0.0454 W 802.11ac VHT20 : 17.25 dBm / 0.0531 W 802.11ac VHT40 : 16.61 dBm / 0.0458 W 802.11ac VHT80 : 17.39 dBm / 0.0548 W</p> <p><Ant. 2> 802.11a : 18.00 dBm / 0.0631 W 802.11n HT20 : 17.92 dBm / 0.0619 W 802.11n HT40 : 17.25 dBm / 0.0531 W 802.11ac VHT20 : 18.05 dBm / 0.0638 W 802.11ac VHT40 : 17.38 dBm / 0.0547 W 802.11ac VHT80 : 18.00 dBm / 0.0631 W</p> <p>MIMO <Ant. 1 + 2> 802.11a : 20.54 dBm / 0.1132 W 802.11n HT20 : 20.58 dBm / 0.1143 W 802.11n HT40 : 19.79 dBm / 0.0953 W 802.11ac VHT20 : 20.67 dBm / 0.1167 W 802.11ac VHT40 : 19.99 dBm / 0.0998 W 802.11ac VHT80 : 20.54 dBm / 0.1132 W</p>									
Antenna Type / Gain	<p><Ant. 1> Fixed Internal Antenna type with gain -2.40 dBi</p> <p><Ant. 2> Fixed Internal Antenna type with gain -3.50 dBi</p>									
Type of Modulation	802.11a/n : OFDM (BPSK / QPSK / 16QAM / 64QAM) 802.11ac : OFDM (BPSK / QPSK / 16QAM / 64QAM / 256QAM)									
Antenna Function Description	<table border="1"> <thead> <tr> <th></th> <th>Ant. 1</th> <th>Ant. 2</th> </tr> </thead> <tbody> <tr> <td>802.11 a/n/ac</td> <td>V</td> <td>V</td> </tr> <tr> <td>802.11 a/n/ac MIMO</td> <td>V</td> <td>V</td> </tr> </tbody> </table>		Ant. 1	Ant. 2	802.11 a/n/ac	V	V	802.11 a/n/ac MIMO	V	V
	Ant. 1	Ant. 2								
802.11 a/n/ac	V	V								
802.11 a/n/ac MIMO	V	V								

Note: MIMO Ant. 1+2 is a calculated result from sum of the power MIMO Ant. 1 and MIMO Ant. 2.

1.5 Modification of EUT

No modifications are made to the EUT during all test items.



1.6 Testing Location

Sporton Lab is accredited to ISO 17025 by Taiwan Accreditation Foundation (TAF code : 1190) and the FCC designation No. TW0007 under the FCC 2.948(e) by Mutual Recognition Agreement (MRA) in FCC Test.

Test Site	SPORTON INTERNATIONAL INC.
Test Site Location	No. 52, Hwa Ya 1 st Rd., Hwa Ya Technology Park, Kwei-Shan District, Tao Yuan City, Taiwan, R.O.C. TEL: +886-3-327-3456 FAX: +886-3-328-4978
Test Site No.	Sporton Site No. TH05-HY

Note: The test site complies with ANSI C63.4 2014 requirement.

Test Site	SPORTON INTERNATIONAL INC.
Test Site Location	No.58, Aly. 75, Ln. 564, Wenhua 3rd Rd. Guishan Dist, Taoyuan City, Taiwan (R.O.C.) TEL: +886-3-327-0868 FAX: +886-3-327-0855
Test Site No.	Sporton Site No. 03CH11-HY

Note: The test site complies with ANSI C63.4 2014 requirement.



1.7 Applicable Standards

According to the specifications of the manufacturer, the EUT must comply with the requirements of the following standards:

- ♦ FCC Part 15 Subpart E
- ♦ FCC KDB 789033 D02 General UNII Test Procedures New Rules v01r04
- ♦ FCC KDB 662911 D01 Multiple Transmitter Output v02r01.
- ♦ FCC KDB 644545 D03 Guidance for IEEE 802 11ac New Rules v01
- ♦ ANSI C63.10-2013

Remark:

1. All test items were verified and recorded according to the standards and without any deviation during the test.
2. This EUT has also been tested and complied with the requirements of FCC Part 15, Subpart B, recorded in a separate test report.



2 Test Configuration of Equipment Under Test

The EUT has been associated with peripherals and configuration operated in a manner tended to maximize its emission characteristics in a typical application. Frequency range investigated: conducted emission (150 kHz to 30 MHz) and radiated emission (9 kHz to the 10th harmonic of the highest fundamental frequency or to 40 GHz, whichever is lower). For radiated measurement, pre-scanned in three orthogonal panels, X, Y, Z. The worst cases (X plane) were recorded in this report.

2.1 Carrier Frequency and Channel

Frequency Band	Channel	Freq. (MHz)	Channel	Freq. (MHz)
5725-5850 MHz Band 4 (U-NII-3)	149	5745	157	5785
	151*	5755	159*	5795
	153	5765	161	5805
	155#	5775	165	5825

Note:

1. The above Frequency and Channel in "*" were 802.11n HT40 and 802.11ac VHT40.
2. The above Frequency and Channel in "#n" were 802.11ac VHT80.

2.2 Test Mode

Final test mode of conducted test items and radiated spurious emissions are considering the modulation and worse data rates as below table.

MIMO Antenna

Modulation	Data Rate
802.11a	6 Mbps

Remark: All the radiated test cases were performance with Adapter 1 and Battery 2.

Ch. #		Band IV : 5725-5850 MHz	
		802.11a	
L	Low	-	
M	Middle	157	
H	High	-	

2.3 Connection Diagram of Test System

<WLAN Tx Mode>

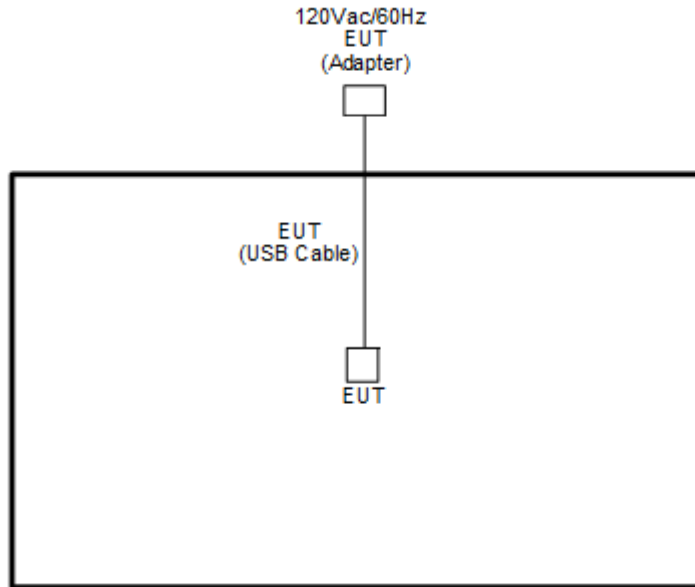

2.4 EUT Operation Test Setup

The RF test items, programmed RF utility, "QRCT" installed in the notebook make the EUT provide functions like channel selection and power level for continuous transmitting and receiving signals.

3 Test Result

3.1 Maximum Conducted Output Power Measurement

3.1.1 Limit of Maximum Conducted Output Power

For the band 5.725–5.85 GHz, the maximum conducted output power over the frequency band of operation shall not exceed 1 W.

If transmitting antennas of directional gain greater than 6 dBi are used, the peak output power shall be reduced by the amount in dB that the directional gain of the antenna exceeds 6 dBi.

3.1.2 Measuring Instruments

The measuring equipment is listed in the section 4 of this test report.

3.1.3 Test Procedures

The testing follows Method PM of FCC KDB 789033 D02 General UNII Test Procedures New Rules v01r03.

Method PM (Measurement using an RF average power meter):

1. Measurement is performed using a wideband RF power meter.
2. The EUT is configured to transmit continuously with a consistent duty cycle at its maximum power control level.
3. Measure the average power of the transmitter, and the average power is corrected with duty factor, $10 \log(1/x)$, where x is the duty cycle.

3.1.4 Test Setup

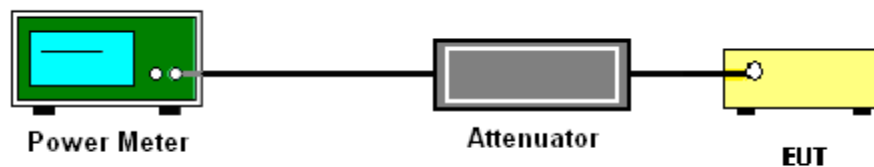

3.1.5 Test Result of Maximum Conducted Output Power

Please refer to Appendix A.



3.2 Unwanted Emissions Measurement

This section is to measure unwanted emissions through radiated measurement for band edge spurious emissions and out of band emissions measurement.

3.2.1 Limit of Unwanted Emissions

- (1) For transmitters operating in the 5.725-5.85 GHz band:
15.407(b)(4)(i) All emissions shall be limited to a level of -27 dBm/MHz at 75 MHz or more above or below the band edge increasing linearly to 10 dBm/MHz at 25 MHz above or below the band edge, and from 25 MHz above or below the band edge increasing linearly to a level of 15.6 dBm/MHz at 5 MHz above or below the band edge, and from 5 MHz above or below the band edge increasing linearly to a level of 27 dBm/MHz at the band edge.
- (2) Unwanted spurious emissions fallen in restricted bands shall comply with the general field strength limits set forth as below table,

Frequency (MHz)	Field Strength (microvolts/meter)	Measurement Distance (meters)
0.009 – 0.490	2400/F(kHz)	300
0.490 – 1.705	24000/F(kHz)	30
1.705 – 30.0	30	30
30 – 88	100	3
88 – 216	150	3
216 - 960	200	3
Above 960	500	3

Note: The following formula is used to convert the EIRP to field strength.

$$E = \frac{1000000\sqrt{30P}}{3} \mu V/m, \text{ where } P \text{ is the eirp (Watts)}$$



EIRP (dBm)	Field Strength at 3m (dBµV/m)
-17	78.3
- 27	68.3

(3) KDB789033 D02 v01r04 G)2)c)

- (i) Sections 15.407(b)(1) to (b)(3) specify the unwanted emission limits for the U-NII-1 and U-NII-2 bands. As specified, emissions above 1000 MHz that are outside of the restricted bands are subject to a peak emission limit of -27 dBm/MHz.³
- (ii) Section 15.407(b)(4) specifies the unwanted emission limit for the U-NII-3 band. A band emissions mask is specified in Section 15.407(b)(4)(i). The emission limits are in terms of a Peak detector. An alternative to the band emissions mask is specified in Section 15.407(b)(4)(ii). The alternative limits are based on the highest antenna gain specified in the filing. There are also marketing and importation restrictions for the devices using the alternative limit.⁴

Note 3: An out-of-band emission that complies with both the average and peak limits of Section 15.209 is not required to satisfy the -27 dBm/MHz peak emission limit.

Note 4: Only devices with antenna gains of 10 dBi or less may be approved using the emission limits specified in Section 15.247(d) till March 2, 2018; all other devices operating in this band must use the mask specified in Section 15.407(b)(4)(i).

3.2.2 Measuring Instruments

The measuring equipment is listed in the section 4 of this test report.



3.2.3 Test Procedures

1. The testing follows FCC KDB 789033 D02 General UNII Test Procedures New Rules v01r03. Section G) Unwanted emissions measurement.

(1) Procedure for Unwanted Emissions Measurements Below 1000MHz

- RBW = 120 kHz
- VBW = 300 kHz
- Detector = Peak
- Trace mode = max hold

(2) Procedure for Peak Unwanted Emissions Measurements Above 1000 MHz

- RBW = 1 MHz
- VBW \geq 3 MHz
- Detector = Peak
- Sweep time = auto
- Trace mode = max hold

(3) Procedures for Average Unwanted Emissions Measurements Above 1000MHz

- RBW = 1 MHz
- VBW = 10 Hz, when duty cycle is no less than 98 percent.
- VBW \geq 1/T, when duty cycle is less than 98 percent where T is the minimum transmission duration over which the transmitter is on and is transmitting at its maximum power control level for the tested mode of operation.

2. The EUT was placed on a turntable with 0.8 meter for frequency below 1GHz and 1.5 meter for frequency above 1GHz respectively above ground.
3. The EUT was set 3 meters from the interference receiving antenna which was mounted on the top of a variable height antenna tower.
4. The antenna is a broadband antenna and its height is adjusted between one meter and four meters above ground to find the maximum value of the field strength for both horizontal polarization and vertical polarization of the antenna.
5. For each suspected emission, the EUT was arranged to its worst case and then adjust the antenna tower (from 1 m to 4 m) and turntable (from 0 degree to 360 degrees) to find the maximum reading.
6. For testing below 1GHz, if the emission level of the EUT in peak mode was 3 dB lower than the limit specified, then peak values of EUT will be reported, otherwise, the emissions will be repeated one by one using the CISPR quasi-peak method and reported.
7. For testing above 1GHz, the emission level of the EUT in peak mode was 20dB lower than average limit (that means the emission level in average mode also complies with the limit in average mode), then peak values of EUT will be reported, otherwise, the emissions will be measured in average mode again and reported.

3.2.4 Test Setup

For radiated emissions below 30MHz

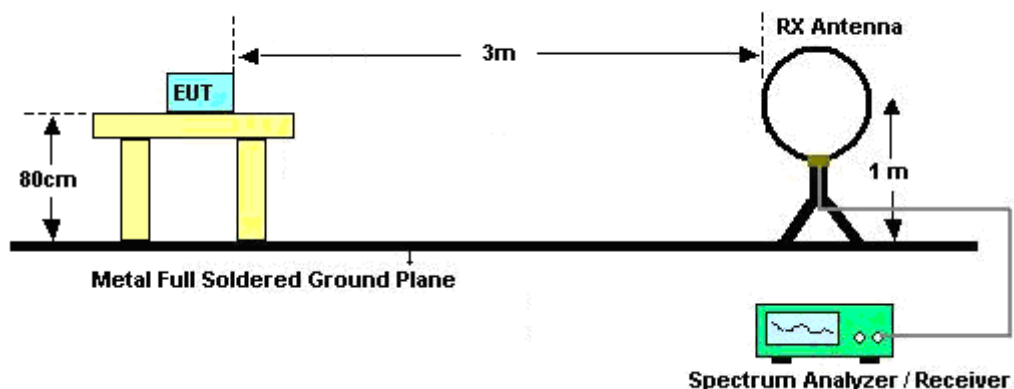

For radiated emissions from 30MHz to 1GHz

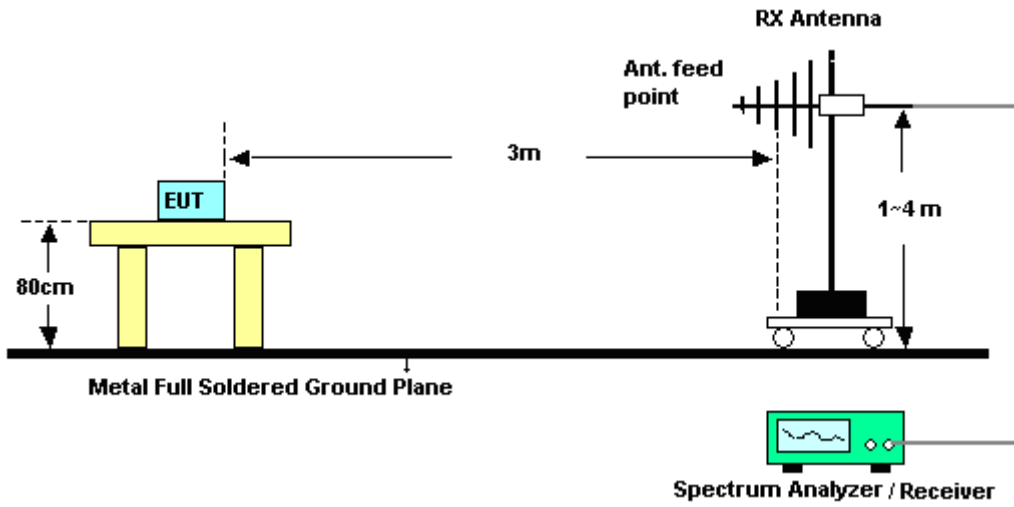

For radiated emissions above 1GHz

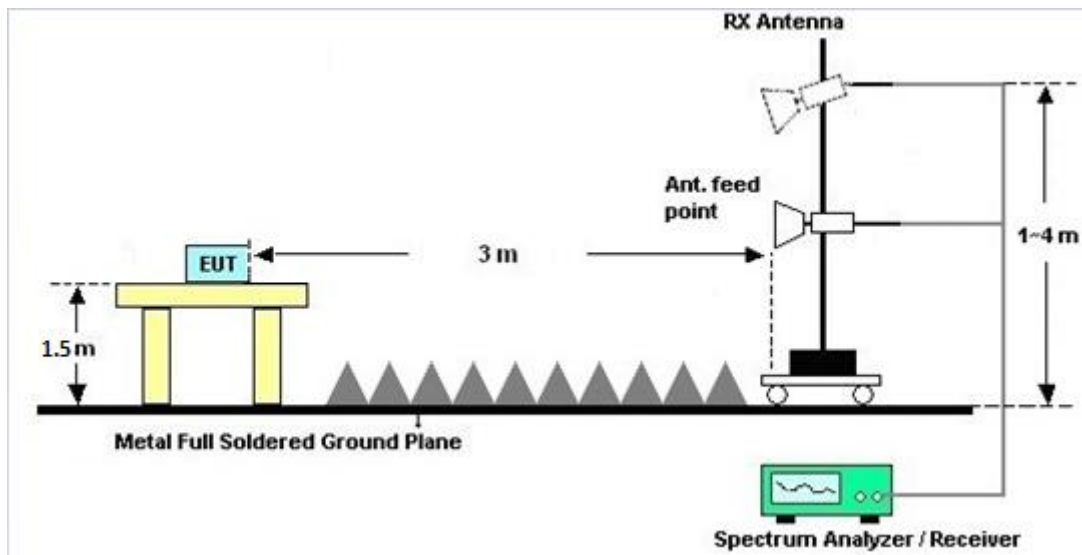



3.2.5 Test Results of Radiated Spurious Emissions (9 kHz ~ 30 MHz)

The low frequency, which started from 9 kHz to 30MHz, was pre-scanned and the result which was 20dB lower than the limit line was not reported.

3.2.6 Test Result of Radiated Spurious at Band Edges

Please refer to Appendix B and C.

3.2.7 Duty Cycle

Please refer to Appendix D.

3.2.8 Test Result of Radiated Spurious Emissions (30MHz ~ 10th Harmonic)

Please refer to Appendix B and C.



3.3 Automatically Discontinue Transmission

3.3.1 Limit of Automatically Discontinue Transmission

The device shall automatically discontinue transmission in case of either absence of information to transmit or operational failure. These provisions are not intended to preclude the transmission of control or signaling information or the use of repetitive codes used by certain digital technologies to complete frame or burst intervals. Applicants shall include in their application for equipment authorization to describe how this requirement is met.

3.3.2 Measuring Instruments

The measuring equipment is listed in the section 4 of this test report.

3.3.3 Test Result of Automatically Discontinue Transmission

While the EUT is not transmitting any information, the EUT can automatically discontinue transmission and become standby mode for power saving. The EUT can detect the controlling signal of ACK message transmitting from remote device and verify whether it shall resend or discontinue transmission.



3.4 Antenna Requirements

3.4.1 Standard Applicable

If transmitting antenna directional gain is greater than 6 dBi, both the peak transmit power and the peak power spectral density shall be reduced by the amount in dB that the directional gain of the antenna exceeds 6 dBi.

3.4.2 Antenna Anti-Replacement Construction

An embedded-in antenna design is used.

3.4.3 Antenna Gain

FCC KDB 662911 D01 Multiple Transmitter Output v02r01

For CDD transmissions, directional gain is calculated as

Directional gain = $G_{ANT} + \text{Array Gain}$, where Array Gain is as follows.

For power spectral density (PSD) measurements on all devices,

Array Gain = $10 \log(N_{ANT}/N_{SS}=1)$ dB.

For power measurements on IEEE 802.11 devices,

Array Gain = 0 dB (i.e., no array gain) for $N_{ANT} \leq 4$.

Directional gain may be calculated by using the formulas applicable to equal gain antennas with G_{ANT} set equal to the gain of the antenna having the highest gain;

The EUT supports CDD mode.

For power, the directional gain G_{ANT} is set equal to the antenna having the highest gain, i.e., F)2)f)i).

For PSD, the directional gain calculation is following F)2)f)ii) of KDB 662911 D01 v02r01.

The power and PSD limit should be modified if the directional gain of EUT is over 6 dBi,

The directional gain "DG" is calculated as following table.

			DG for Power (dBi)	DG for PSD (dBi)	Power Limit Reduction (dB)	PSD Limit Reduction (dB)
	Ant 1 (dBi)	Ant 2 (dBi)				
Band IV	-2.40	-3.50	-2.40	0.08	0.00	0.00

Power limit reduction = Composite gain – 6dBi, (min = 0)

PSD limit reduction = Composite gain + PSD Array gain – 6dBi, (min = 0)



4 List of Measuring Equipment

Instrument	Manufacturer	Model No.	Serial No.	Characteristics	Calibration Date	Test Date	Due Date	Remark
Power Meter	Anritsu	ML2495A	0932001	300MHz~40GHz	Sep. 29, 2016	May 02, 2017~ May 06, 2017	Sep. 28, 2017	Conducted (TH05-HY)
Power Sensor	Anritsu	MA2411B	0846202	300MHz~40GHz	Sep. 29, 2016	May 02, 2017~ May 06, 2017	Sep. 28, 2017	Conducted (TH05-HY)
Amplifier	SONOMA	310N	187312	9kHz~1GHz	Nov. 10, 2016	Apr. 27, 2017~ Apr. 29, 2017	Nov. 09, 2017	Radiation (03CH11-HY)
Loop Antenna	Rohde & Schwarz	HFH2-Z2	100315	9 kHz~30 MHz	Sep. 02, 2015	Apr. 27, 2017~ Apr. 29, 2017	Sep. 01, 2017	Radiation (03CH11-HY)
Bilog Antenna	TESEQ	CBL 6111D	35414	30MHz~1GHz	Oct. 15, 2016	Apr. 27, 2017~ Apr. 29, 2017	Oct. 14, 2017	Radiation (03CH11-HY)
Horn Antenna	SCHWARZBECK	BBHA 9120 D	9120D-1326	1GHz ~ 18GHz	Oct. 07, 2016	Apr. 27, 2017~ Apr. 29, 2017	Oct. 06, 2017	Radiation (03CH11-HY)
Preamplifier	Keysight	83017A	MY53270080	1GHz~26.5GHz	Nov. 10, 2016	Apr. 27, 2017~ Apr. 29, 2017	Nov. 09, 2017	Radiation (03CH11-HY)
Spectrum Analyzer	Keysight	N9010A	MY54200486	10Hz ~ 44GHz	Oct. 12, 2016	Apr. 27, 2017~ Apr. 29, 2017	Oct. 11, 2017	Radiation (03CH11-HY)
Antenna Mast	EMEC	AM-BS-4500-B	N/A	1~4m	N/A	Apr. 27, 2017~ Apr. 29, 2017	N/A	Radiation (03CH11-HY)
Turn Table	EMEC	TT 2000	N/A	0~360 Degree	N/A	Apr. 27, 2017~ Apr. 29, 2017	N/A	Radiation (03CH11-HY)
Preamplifier	MITEQ	AMF-7D-0010 1800-30-10P	1815698	1GHz~18GHz	Dec. 01, 2016	Apr. 27, 2017~ Apr. 29, 2017	Nov. 30, 2017	Radiation (03CH11-HY)
SHF-EHF Horn Antenna	SCHWARZBECK	BBHA 9170	BBHA917058 4	18GHz- 40GHz	Nov. 08, 2016	Apr. 27, 2017~ Apr. 29, 2017	Nov. 07, 2017	Radiation (03CH11-HY)
Preamplifier	MITEQ	TTA0204	1872107	2GHz~40GHz	Feb. 15, 2017	Apr. 27, 2017~ Apr. 29, 2017	Feb. 14, 2018	Radiation (03CH11-HY)



5 Uncertainty of Evaluation

Uncertainty of Radiated Emission Measurement (30 MHz ~ 1000 MHz)

Measuring Uncertainty for a Level of Confidence of 95% ($U = 2Uc(y)$)	5.2
---	-----

Uncertainty of Radiated Emission Measurement (1000 MHz ~ 18000 MHz)

Measuring Uncertainty for a Level of Confidence of 95% ($U = 2Uc(y)$)	5.5
---	-----

Uncertainty of Radiated Emission Measurement (18000 MHz ~ 40000 MHz)

Measuring Uncertainty for a Level of Confidence of 95% ($U = 2Uc(y)$)	5.2
---	-----

Appendix A. Test Result of Conducted Test Items

Test Engineer:	Kai Liao	Temperature:	21~25	°C
Test Date:	2017/5/2 ~2017/5/6	Relative Humidity:	51~54	%

TEST RESULTS DATA
Average Power Table

Band IV														
Mod.	Data Rate	NTX	CH.	Freq. (MHz)	Duty Factor (dB)		Average Conducted Power (dBm)			FCC Conducted Power Limit (dBm)		DG (dBi)		Pass/Fail
					Ant 1	Ant 2	Ant 1	Ant 2	SUM	Ant 1	Ant 2	Ant 1	Ant 2	
11a	6Mbps	1	149	5745	0.23	0.23	17.15	17.90		30.00	30.00	-2.40	-3.50	Pass
11a	6Mbps	1	157	5785	0.23	0.23	17.17	17.90		30.00	30.00	-2.40	-3.50	Pass
11a	6Mbps	1	165	5825	0.23	0.23	17.24	18.00		30.00	30.00	-2.40	-3.50	Pass
HT20	MCS0	1	149	5745	0.28	0.25	17.31	17.83		30.00	30.00	-2.40	-3.50	Pass
HT20	MCS0	1	157	5785	0.28	0.25	17.27	17.75		30.00	30.00	-2.40	-3.50	Pass
HT20	MCS0	1	165	5825	0.28	0.25	17.16	17.92		30.00	30.00	-2.40	-3.50	Pass
HT40	MCS0	1	151	5755	0.40	0.37	16.53	17.06		30.00	30.00	-2.40	-3.50	Pass
HT40	MCS0	1	159	5795	0.40	0.37	16.57	17.25		30.00	30.00	-2.40	-3.50	Pass
VHT20	MCS0	1	149	5745	0.26	0.26	17.25	17.93		30.00	30.00	-2.40	-3.50	Pass
VHT20	MCS0	1	157	5785	0.26	0.26	17.17	17.78		30.00	30.00	-2.40	-3.50	Pass
VHT20	MCS0	1	165	5825	0.26	0.26	17.16	18.05		30.00	30.00	-2.40	-3.50	Pass
VHT40	MCS0	1	151	5755	0.48	0.52	16.51	17.20		30.00	30.00	-2.40	-3.50	Pass
VHT40	MCS0	1	159	5795	0.48	0.52	16.61	17.38		30.00	30.00	-2.40	-3.50	Pass
VHT80	MCS0	1	155	5775	0.62	0.62	17.39	18.00		30.00	30.00	-2.40	-3.50	Pass
11a	6Mbps	2	149	5745	0.23	0.23	17.11	17.87	20.52	30.00		-2.40		Pass
11a	6Mbps	2	157	5785	0.23	0.23	17.05	17.87	20.49	30.00		-2.40		Pass
11a	6Mbps	2	165	5825	0.23	0.23	17.05	17.96	20.54	30.00		-2.40		Pass
HT20	MCS0	2	149	5745	0.28	0.26	16.79	18.03	20.47	30.00		-2.40		Pass
HT20	MCS0	2	157	5785	0.28	0.26	16.98	18.00	20.53	30.00		-2.40		Pass
HT20	MCS0	2	165	5825	0.28	0.26	17.25	17.87	20.58	30.00		-2.40		Pass
HT40	MCS0	2	151	5755	0.37	0.33	16.15	16.95	19.58	30.00		-2.40		Pass
HT40	MCS0	2	159	5795	0.37	0.33	16.27	17.24	19.79	30.00		-2.40		Pass
VHT20	MCS0	2	149	5745	0.26	0.28	16.83	18.01	20.47	30.00		-2.40		Pass
VHT20	MCS0	2	157	5785	0.26	0.28	16.89	18.05	20.52	30.00		-2.40		Pass
VHT20	MCS0	2	165	5825	0.26	0.28	17.01	18.22	20.67	30.00		-2.40		Pass
VHT40	MCS0	2	151	5755	0.52	0.48	16.30	16.98	19.66	30.00		-2.40		Pass
VHT40	MCS0	2	159	5795	0.52	0.48	16.52	17.41	19.99	30.00		-2.40		Pass
VHT80	MCS0	2	155	5775	0.62	0.62	17.04	17.96	20.54	30.00		-2.40		Pass



Appendix B. Radiated Spurious Emission

Test Engineer :	J.C. Liang, Jacky Hung, and Kan Wu	Temperature :	18~22°C
		Relative Humidity :	55~58%

Band 4 - 5725~5850MHz

WIFI 802.11a (Band Edge @ 3m)

WIFI Ant.	Note	Frequency (MHz)	Level (dBμV/m)	Over Limit (dB)	Limit Line (dBμV/m)	Read Level (dBμV)	Antenna Factor (dB/m)	Cable Loss (dB)	Preamp Factor (dB)	Ant Pos (cm)	Table Pos (deg)	Peak Avg. (P/A)	Pol. (H/V)
802.11a CH 157 5785MHz		5606.6	50.83	-17.37	68.2	41.78	32.65	9.48	33.08	100	238	P	H
		5650.6	51.05	-17.6	68.65	41.76	32.77	9.62	33.1	100	238	P	H
		5716.4	49.75	-60.04	109.79	40.21	32.9	9.77	33.13	100	238	P	H
		5722.4	51.52	-64.75	116.27	41.89	32.94	9.82	33.13	100	238	P	H
	*	5785	110.26	-	-	100.4	33.06	9.97	33.17	100	238	P	H
	*	5785	102.7	-	-	92.84	33.06	9.97	33.17	100	238	A	H
		5850.4	49.96	-71.33	121.29	39.9	33.23	10.02	33.19	100	238	P	H
		5859.6	49.93	-59.58	109.51	39.85	33.27	10.02	33.21	100	238	P	H
		5894.2	50.26	-40.69	90.95	40.11	33.35	10.02	33.22	100	238	P	H
		5945.8	50	-18.2	68.2	39.74	33.48	10.02	33.24	100	238	P	H
		5639.4	50.72	-17.48	68.2	41.51	32.73	9.58	33.1	314	87	P	V
		5651.2	49.95	-19.14	69.09	40.66	32.77	9.62	33.1	314	87	P	V
		5719.6	52.07	-58.62	110.69	42.44	32.94	9.82	33.13	314	87	P	V
		5722.4	49.24	-67.03	116.27	39.61	32.94	9.82	33.13	314	87	P	V
	*	5785	111.21	-	-	101.35	33.06	9.97	33.17	314	87	P	V
	*	5785	104.26	-	-	94.4	33.06	9.97	33.17	314	87	A	V
		5853.2	49.51	-65.39	114.9	39.45	33.23	10.02	33.19	314	87	P	V
		5868.2	51.37	-55.73	107.1	41.29	33.27	10.02	33.21	314	87	P	V
	5901.4	50.42	-35.2	85.62	40.27	33.35	10.02	33.22	314	87	P	V	
	5939	49.25	-18.95	68.2	38.99	33.48	10.02	33.24	314	87	P	V	
Remark	1. No other spurious found. 2. All results are PASS against Peak and Average limit line.												



Band 4 5725~5850MHz

WIFI 802.11a (Harmonic @ 3m)

WIFI Ant. 1+2	Note	Frequency (MHz)	Level (dBμV/m)	Over Limit (dB)	Limit Line (dBμV/m)	Read Level (dBμV)	Antenna Factor (dB/m)	Cable Loss (dB)	Preamp Factor (dB)	Ant Pos (cm)	Table Pos (deg)	Peak Avg. (P/A)	Pol. (H/V)	
802.11a CH 157 5785MHz		11570	49.81	-24.19	74	60.47	38.56	15.87	65.37	100	0	P	H	
		17355	47.23	-20.97	68.2	50.37	40.69	19.91	64.11	100	0	P	H	
													H	
													H	
			11570	54.58	-19.42	74	65.52	38.56	15.87	65.37	100	254	P	V
			11570	43.03	-10.97	54	53.97	38.56	15.87	65.37	100	254	A	V
			17355	48.42	-19.78	68.2	51.56	40.69	19.91	64.11	100	0	P	V
														V
Remark	1. No other spurious found. 2. All results are PASS against Peak and Average limit line.													



Emission below 1GHz
5GHz WIFI 802.11a (LF @ 3m)

WIFI	Note	Frequency	Level	Over	Limit	Read	Antenna	Cable	Preamp	Ant	Table	Peak	Pol.	
Ant.				Limit	Line	Level	Factor	Loss	Factor	Pos	Pos	Avg.		
1+2		(MHz)	(dBμV/m)	(dB)	(dBμV/m)	(dBμV)	(dB/m)	(dB)	(dB)	(cm)	(deg)	(P/A)	(H/V)	
5GHz 802.11a LF		40.8	22.45	-17.55	40	35.16	18.83	0.94	32.49			P	H	
		67.8	24.98	-15.02	40	44.27	12.12	1.06	32.49			P	H	
		205.23	25.73	-17.77	43.5	41.24	15.02	1.8	32.39			P	H	
		358.8	24.62	-21.38	46	33.93	20.61	2.39	32.35			P	H	
		555.5	27.11	-18.89	46	30.56	25.9	2.98	32.42			P	H	
		951.7	33.01	-12.99	46	29.34	30.86	3.82	31.18	100	0	P	H	
													H	
													H	
													H	
													H	
													H	
													H	
			47.01	28.76	-11.24	40	44.93	15.38	0.94	32.49			P	V
			67.8	29.44	-10.56	40	48.73	12.12	1.06	32.49	100	0	P	V
			204.69	26.4	-17.1	43.5	41.93	15	1.8	32.39			P	V
			462.4	28.12	-17.88	46	34.26	23.43	2.75	32.36			P	V
			563.9	27.16	-18.84	46	30.31	26.17	3.02	32.43			P	V
			947.5	33.53	-12.47	46	30.08	30.69	3.82	31.23			P	V
													V	
													V	
												V		
												V		
												V		
												V		
Remark	1. No other spurious found. 2. All results are PASS against limit line.													



Note symbol

*	Fundamental Frequency which can be ignored. However, the level of any unwanted emissions shall not exceed the level of the fundamental frequency.
!	Test result is over limit line.
P/A	Peak or Average
H/V	Horizontal or Vertical



A calculation example for radiated spurious emission is shown as below:

WIFI	Note	Frequency	Level	Over	Limit	Read	Antenna	Cable	Preamp	Ant	Table	Peak	Pol.
Ant.				Limit	Line	Level	Factor	Loss	Factor	Pos	Pos	Avg.	
1+2		(MHz)	(dBμV/m)	(dB)	(dBμV/m)	(dBμV)	(dB/m)	(dB)	(dB)	(cm)	(deg)	(P/A)	(H/V)
802.11b		2390	55.45	-18.55	74	54.51	32.22	4.58	35.86	103	308	P	H
CH 01													
2412MHz		2390	43.54	-10.46	54	42.6	32.22	4.58	35.86	103	308	A	H

- Level(dBμV/m) =
Antenna Factor(dB/m) + Cable Loss(dB) + Read Level(dBμV) - Preamp Factor(dB)
- Over Limit(dB) = Level(dBμV/m) – Limit Line(dBμV/m)

For Peak Limit @ 2390MHz:

- Level(dBμV/m)
= Antenna Factor(dB/m) + Cable Loss(dB) + Read Level(dBμV) - Preamp Factor(dB)
= 32.22(dB/m) + 4.58(dB) + 54.51(dBμV) – 35.86 (dB)
= 55.45 (dBμV/m)
- Over Limit(dB)
= Level(dBμV/m) – Limit Line(dBμV/m)
= 55.45(dBμV/m) – 74(dBμV/m)
= -18.55(dB)

For Average Limit @ 2390MHz:

- Level(dBμV/m)
= Antenna Factor(dB/m) + Cable Loss(dB) + Read Level(dBμV) - Preamp Factor(dB)
= 32.22(dB/m) + 4.58(dB) + 42.6(dBμV) – 35.86 (dB)
= 43.54 (dBμV/m)
- Over Limit(dB)
= Level(dBμV/m) – Limit Line(dBμV/m)
= 43.54(dBμV/m) – 54(dBμV/m)
= -10.46(dB)

Both peak and average measured complies with the limit line, so test result is “PASS”.



Appendix C. Radiated Spurious Emission Plots

Test Engineer :	J.C. Liang, Jacky Hung, and Kan Wu	Temperature :	18~22°C
		Relative Humidity :	55~58%

Note symbol

-L	Low channel location
-R	High channel location



Band 4 - 5725~5850MHz
WIFI 802.11a (Band Edge @ 3m)

WIFI	Band 4 5725~5850MHz Band Edge @ 3m	
ANT	802.11a CH157 5785MHz	
1+2	Horizontal	Fundamental
<p align="center">Peak</p>	<p>Date: 2017.04.27 PEAK_BE(B4)_16-24</p> <p>Site : 03CH11-HY Condition : PEAK_BE(B4)_16-24 3m HORN 9120D-HF HORIZONTAL Detector : Peak Project : 733129-04 Setting : 18</p>	<p>Date: 2017.04.27 PEAK(B4)</p> <p>Site : 03CH11-HY Condition : PEAK(LINII) 3m HORN 9120D-HF HORIZONTAL Detector : Peak Project : 733129-04 Setting : 18</p>
<p align="center">Peak</p>	<p>Date: 2017.04.27 PEAK_BE(B4)_16-24</p> <p>Site : 03CH11-HY Condition : PEAK_BE(B4)_16-24 3m HORN 9120D-HF HORIZONTAL Detector : Peak Project : 733129-04 Setting : 18</p>	<p align="center">Left blank</p>



WIFI	Band 4 5725~5850MHz Band Edge @ 3m	
ANT	802.11a CH157 5785MHz	
1+2	Vertical	Fundamental
Peak	<p>Site : 03CH11-HY Condition : PEAK_BE(B4)_16-24 3m HORN 9120D-HF VERTICAL Detector : Peak Project : 733129-04 Setting : 18</p>	<p>Site : 03CH11-HY Condition : PEAK(UNII) 3m HORN 9120D-HF VERTICAL Detector : Peak Project : 733129-04 Setting : 18</p>
Peak	<p>Site : 03CH11-HY Condition : PEAK_BE(B4)_16-24 3m HORN 9120D-HF VERTICAL Detector : Peak Project : 733129-04 Setting : 18</p>	Left blank



**Band 4 - 5725~5850MHz
WIFI 802.11a (Harmonic @ 3m)**

WIFI	Band 4 5725~5850MHz Harmonic @ 3m	
ANT	802.11a CH157 5785MHz	
1+2	Horizontal	Vertical
Peak Avg.	<p>Site : 03CH11-4FY Condition : PEAK(UNII) 3m 9170 SH-F HORM_150809 HORIZONTAL Detector : Peak Project : 733129-04</p>	<p>Site : 03CH11-4FY Condition : PEAK(UNII) 3m 9170 SH-F HORM_150809 VERTICAL Detector : Peak Project : 733129-04</p>



Emission below 1GHz
5GHz WIFI 802.11a (LF)

WIFI	5GHz 5725~5850MHz	
ANT	802.11a LF	
1+2	Horizontal	Vertical
QP / Peak	<p>Site : 03CH11-FY Condition : QP 3m BT-LOG 6111D-LF_ETC HORIZONTAL Project : 733129-04</p>	<p>Site : 03CH11-FY Condition : QP 3m BT-LOG 6111D-LF_ETC VERTICAL Project : 733129-04</p>



Appendix D. Duty Cycle Plots

Antenna	Band	Duty Cycle(%)	T(us)	1/T(kHz)	VBW Setting
1+2	5GHz 802.11a for Ant 1	94.85	2064	0.484	1kHz
1+2	5GHz 802.11a for Ant 2	94.85	2064	0.484	1kHz



<MIMO Ant. 1>

802.11a

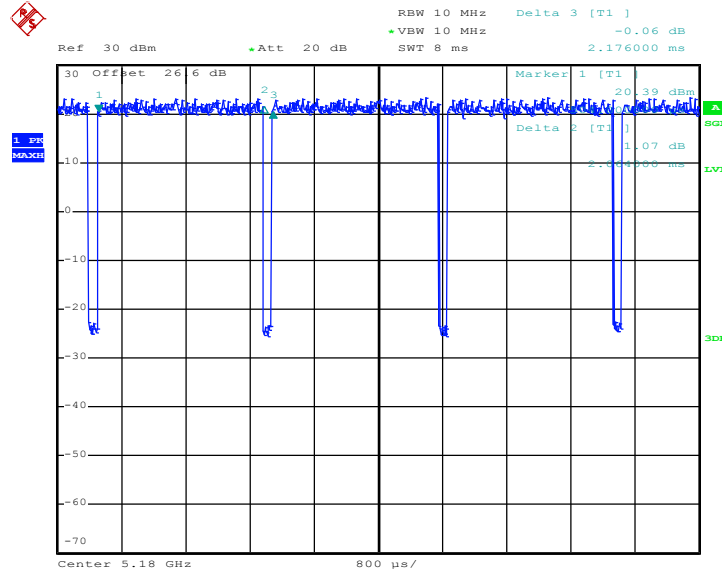

Date: 3.MAY.2017 00:28:27

<MIMO Ant. 2>

802.11a

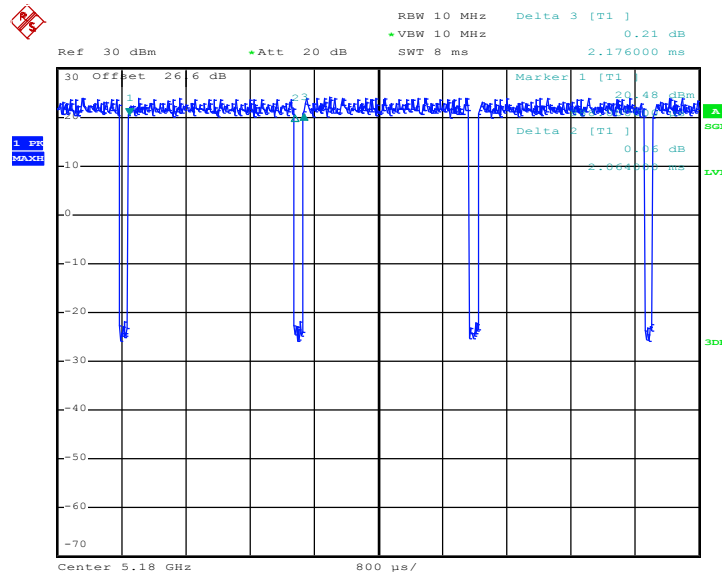

Date: 3.MAY.2017 00:29:30



Appendix E. Original Report

Please refer to Sporton report number FR733129F