



FCC RF Test Report

APPLICANT : Motorola Mobility, LLC
EQUIPMENT : Mobile Cellular Phone
BRAND NAME : Motorola
MODEL NAME : 10722
FCC ID : IHDT56WB4
STANDARD : FCC 47 CFR Part 2, 22(H), 24(E), 27(L)
CLASSIFICATION : PCS Licensed Transmitter Held to Ear (PCE)

The product was received on Mar. 31, 2017 and testing was completed on Apr. 26, 2017. We, SPORTON INTERNATIONAL INC., would like to declare that the tested sample has been evaluated in accordance with the test procedures given in ANSI / TIA / EIA-603-D-2010 and has been in compliance with the applicable technical standards.

The test results in this report apply exclusively to the tested model / sample. Without written approval of SPORTON INTERNATIONAL INC., the test report shall not be reproduced except in full.

Reviewed by: Joseph Lin / Supervisor

Approved by: Jones Tsai / Manager



SPORTON INTERNATIONAL INC.

No. 52, Hwa Ya 1st Rd., Hwa Ya Technology Park, Kwei-Shan District, Tao Yuan City, Taiwan, R.O.C.

SPORTON INTERNATIONAL INC.

TEL : 886-3-327-3456

FAX : 886-3-328-4978

FCC ID : IHDT56WB4

Page Number : 1 of 22

Report Issued Date : May 04, 2017

Report Version : Rev. 01

Report Template No.: BU5-FG22/24/27 Version 1.2



TABLE OF CONTENTS

REVISION HISTORY.....3

SUMMARY OF TEST RESULT4

1 GENERAL DESCRIPTION5

1.1 Applicant.....5

1.2 Manufacturer5

1.3 Product Feature of Equipment Under Test5

1.4 Product Specification of Equipment Under Test6

1.5 Modification of EUT6

1.6 Maximum ERP/EIRP Power, Frequency Tolerance, and Emission Designator7

1.7 Testing Location8

1.8 Applicable Standards8

2 TEST CONFIGURATION OF EQUIPMENT UNDER TEST.....9

2.1 Test Mode.....9

2.2 Connection Diagram of Test System10

2.3 Support Unit used in test configuration10

2.4 Measurement Results Explanation Example10

2.5 Frequency List of Low/Middle/High Channels.....11

3 CONDUCTED TEST RESULT.....12

3.1 Measuring Instruments.....12

3.2 Test Setup12

3.3 Test Result of Conducted Test.....12

3.4 Conducted Output Power and ERP/EIRP13

3.5 Peak-to-Average Ratio14

3.6 99% Occupied Bandwidth and 26dB Bandwidth Measurement.....15

3.7 Conducted Band Edge16

3.8 Conducted Spurious Emission17

3.9 Frequency Stability.....18

4 RADIATED TEST ITEMS19

4.1 Measuring Instruments.....19

4.2 Test Setup19

4.3 Test Result of Radiated Test.....19

4.4 Field Strength of Spurious Radiation Measurement20

5 LIST OF MEASURING EQUIPMENT21

6 UNCERTAINTY OF EVALUATION.....22

APPENDIX A. TEST RESULTS OF CONDUCTED TEST

APPENDIX B. TEST RESULTS OF ERP/EIRP AND RADIATED TEST



REVISION HISTORY

REPORT NO.	VERSION	DESCRIPTION	ISSUED DATE
FG733129A	Rev. 01	Initial issue of report	May 04, 2017



SUMMARY OF TEST RESULT

Report Section	FCC Rule	Description	Limit	Result	Remark
3.4	§2.1046	Conducted Output Power	Reporting Only	PASS	-
	§22.913(a)(2)	Effective Radiated Power	< 7 Watts		
	§24.232(c)	Equivalent Isotropic Radiated Power	< 2 Watts		
	§27.50(d)(4)	Equivalent Isotropic Radiated Power	< 1 Watts		
3.5	§24.232(d)	Peak-to-Average Ratio	< 13 dB	PASS	-
3.6	§2.1049 §22.917(b) §24.238(b) §27.53(g)	Occupied Bandwidth	Reporting Only	PASS	-
3.7	§2.1051 §22.917(a) §24.238(a) §27.53(h)	Band Edge Measurement	< 43+10log10(P[Watts])	PASS	-
3.8	§2.1051 §22.917(a) §24.238(a) §27.53(h)	Conducted Emission	< 43+10log10(P[Watts])	PASS	-
3.9	§2.1055 §22.355	Frequency Stability for Temperature & Voltage	< 2.5 ppm for Part 22	PASS	-
	§2.1055 §24.235 §27.54		Within Authorized Band		
4.4	§2.1053 §22.917(a) §24.238(a) §27.53(h)	Field Strength of Spurious Radiation	< 43+10log10(P[Watts])	PASS	Under limit 23.83 dB at 1672.000 MHz



1 General Description

1.1 Applicant

Motorola Mobility, LLC

222 W Merchandise Mart Plaza, Suite 1800, Chicago, IL 60654, United States

1.2 Manufacturer

Motorola Mobility, LLC

222 W Merchandise Mart Plaza, Suite 1800, Chicago, IL 60654, United States

1.3 Product Feature of Equipment Under Test

Product Feature	
Equipment	Mobile Cellular Phone
Brand Name	Motorola
Model Name	10722
FCC ID	IHDT56WB4
IMEI Code	353311080000221 (for Radiation) 353311080000700 (for Conducted)
EUT supports Radios application	GSM/EGPRS/WCDMA/HSPA/LTE/NFC WLAN 11b/g/n HT20 WLAN 11a/n HT20/HT40 WLAN 11ac VHT20/VHT40/VHT80 Bluetooth BR/EDR/LE
HW Version	DVT2
EUT Stage	Identical Prototype

Accessory List	
AC Adapter 1	Brand Name : Motorola
	Model Name : SPN5970A
AC Adapter 2	Brand Name : Motorola
	Model Name : SPN5993A
AC Adapter 3	Brand Name : Motorola
	Model Name : SPN5978A
Battery 1	Brand Name : Motorola
	Model Name : SNN5986A
Battery 2	Brand Name : Motorola
	Model Name : SNN5897A
Earphone	Brand Name : Motorola
	Model Name : SH38C16618
USB Cable	Brand Name : Motorola
	Model Name : SKN6473A
USB-C Data Cable	Brand Name : Motorola
	Model Name : SKN6474A



1.4 Product Specification of Equipment Under Test

Standards-related Product Specification	
Tx Frequency	GSM/GPRS/EDGE: 850: 824.2 MHz ~ 848.8 MHz 1900: 1850.2 MHz ~ 1909.8MHz WCDMA: Band V: 826.4 MHz ~ 846.6 MHz Band II: 1852.4 MHz ~ 1907.6 MHz Band IV: 1712.4 MHz ~ 1752.6 MHz
Rx Frequency	GSM/GPRS/EDGE: 850: 869.2 MHz ~ 893.8 MHz 1900: 1930.2 MHz ~ 1989.8 MHz WCDMA: Band V: 871.4 MHz ~ 891.6 MHz Band II: 1932.4 MHz ~ 1987.6 MHz Band IV: 2112.4 MHz ~ 2152.6 MHz
Maximum Output Power to Antenna	GSM/GPRS/EDGE: 850: 33.44 dBm 1900: 29.46 dBm WCDMA: Band V: 23.41 dBm Band II: 22.70 dBm Band IV: 22.51 dBm
Antenna Type	Fixed Internal Antenna
Antenna Gain	Cellular Band: -0.70 dBi PCS Band: 0.30 dBi AWS Band: -0.50 dBi
Type of Modulation	GSM: GMSK GPRS: GMSK EDGE: GMSK / 8PSK WCDMA: BPSK (Uplink) HSDPA: 64QAM (Downlink) HSUPA: QPSK (Uplink)

1.5 Modification of EUT

No modifications are made to the EUT during all test items.



1.6 Maximum ERP/EIRP Power, Frequency Tolerance, and Emission Designator

FCC Rule	Frequency Range (MHz)	System	Type of Modulation	Maximum ERP/EIRP (W)	Frequency Tolerance (ppm)	Emission Designator
Part 22	824.2 ~848.8	GSM850 GPRS class 8	GMSK	1.1455	0.0143 ppm	250KGXW
Part 22	824.2 ~848.8	GSM850 EDGE class 8	8PSK	0.2183	0.0060 ppm	245KG7W
Part 22	826.4 ~846.6	WCDMA Band V RMC 12.2Kbps	BPSK	0.1138	0.0167 ppm	4M12F9W
Part 24	1850.2 ~1909.8	GSM1900 GPRS class 8	GMSK	0.9462	0.0271 ppm	244KGXW
Part 24	1850.2 ~1909.8	GSM1900 EDGE class 8	8PSK	0.3524	0.0048 ppm	245KG7W
Part 24	1852.4 ~ 1907.6	WCDMA Band II RMC 12.2Kbps	BPSK	0.1995	0.0053 ppm	4M13F9W
Part 27	1712.4 ~ 1752.6	WCDMA Band IV RMC 12.2Kbps	BPSK	0.1589	0.0185 ppm	4M12F9W



1.7 Testing Location

Sporton Lab is accredited to ISO 17025 by Taiwan Accreditation Foundation (TAF code : 1190) and the FCC designation No. TW0007 under the FCC 2.948(e) by Mutual Recognition Agreement (MRA) in FCC Test.

Test Site	SPORTON INTERNATIONAL INC.
Test Site Location	No. 52, Hwa Ya 1 st Rd., Hwa Ya Technology Park, Kwei-Shan District, Tao Yuan City, Taiwan, R.O.C. TEL: +886-3-327-3456 FAX: +886-3-328-4978
Test Site No.	Sporton Site No.
	TH03-HY

Test Site	SPORTON INTERNATIONAL INC.
Test Site Location	No.58, Aly. 75, Ln. 564, Wenhua 3rd Rd. Guishan Dist, Taoyuan City, Taiwan (R.O.C.) TEL: +886-3-327-0868 FAX: +886-3-327-0855
Test Site No.	Sporton Site No.
	03CH12-HY

1.8 Applicable Standards

According to the specifications of the manufacturer, the EUT must comply with the requirements of the following standards:

- ♦ 47 CFR Part 2, 22(H), 24(E), 27(L)
- ♦ ANSI / TIA / EIA-603-D-2010
- ♦ FCC KDB 971168 D01 Power Meas. License Digital Systems v02r02
- ♦ FCC KDB 412172 D01 Determining ERP and EIRP v01r01

Remark:

1. All test items were verified and recorded according to the standards and without any deviation during the test.
2. This EUT has also been tested and complied with the requirements of FCC Part 15, Subpart B, recorded in a separate test report.



2 Test Configuration of Equipment Under Test

2.1 Test Mode

Antenna port conducted and radiated test items were performed according to KDB 971168 D01 Power Meas. License Digital Systems v02r02 with maximum output power.

Radiated measurements were performed with rotating EUT in different three orthogonal test planes to find the maximum emission.

Radiated emissions were investigated as following frequency range:

1. 30 MHz to 9000 MHz for GSM850 and WCDMA Band V.
2. 30 MHz to 18000 MHz for WCDMA Band IV.
3. 30 MHz to 19100 MHz for GSM1900 and WCDMA Band II.

All modes and data rates and positions were investigated.

Test modes are chosen to be reported as the worst case configuration below:

Test Modes		
Band	Radiated TCs	Conducted TCs
GSM 850	<ul style="list-style-type: none"> ■ GPRS class 8 Link ■ EDGE class 8 Link 	<ul style="list-style-type: none"> ■ GPRS class 8 Link ■ EDGE class 8 Link
GSM 1900	<ul style="list-style-type: none"> ■ GPRS class 8 Link ■ EDGE class 8 Link 	<ul style="list-style-type: none"> ■ GPRS class 8 Link ■ EDGE class 8 Link
WCDMA Band V	<ul style="list-style-type: none"> ■ RMC 12.2Kbps Link 	<ul style="list-style-type: none"> ■ RMC 12.2Kbps Link
WCDMA Band II	<ul style="list-style-type: none"> ■ RMC 12.2Kbps Link 	<ul style="list-style-type: none"> ■ RMC 12.2Kbps Link
WCDMA Band IV	<ul style="list-style-type: none"> ■ RMC 12.2Kbps Link 	<ul style="list-style-type: none"> ■ RMC 12.2Kbps Link

Remark: All the radiated test cases were performance with Adapter 1 and Battery 2.

2.2 Connection Diagram of Test System

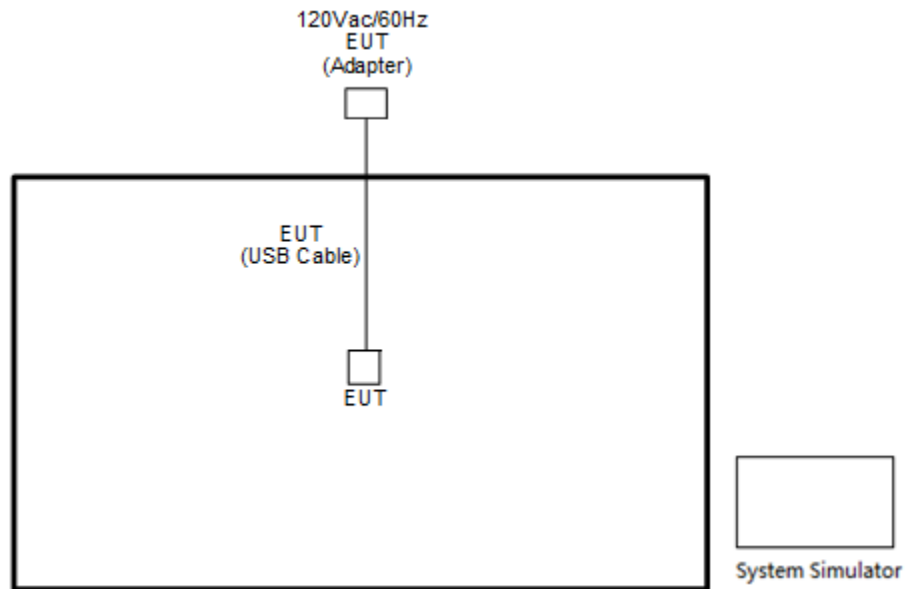

2.3 Support Unit used in test configuration

Item	Equipment	Trade Name	Model No.	FCC ID	Data Cable	Power Cord
1.	System Simulator	R&S	CMU 200	N/A	N/A	Unshielded, 1.8 m

2.4 Measurement Results Explanation Example

For all conducted test items:

The offset level is set in the spectrum analyzer to compensate the RF cable loss and attenuator factor between RF conducted output port and spectrum analyzer. With the offset compensation, the spectrum analyzer reading level will be exactly the RF output level.

The spectrum analyzer offset is derived from RF cable loss and attenuator factor.

Offset = RF cable loss + attenuator factor.

The following shows an offset computation example with RF cable loss 4.2 dB and a 10dB attenuator.

Example :

Offset(dB) = RF cable loss(dB) + attenuator factor(dB).

$$= 4.2 + 10 = 14.2 \text{ (dB)}$$



2.5 Frequency List of Low/Middle/High Channels

Frequency List				
Band	Channel/Frequency(MHz)	Lowest	Middle	Highest
GSM850	Channel	128	189	251
	Frequency	824.2	836.4	848.8
WCDMA Band V	Channel	4132	4182	4233
	Frequency	826.4	836.4	846.6
GSM1900	Channel	512	661	810
	Frequency	1850.2	1880.0	1909.8
WCDMA Band II	Channel	9262	9400	9538
	Frequency	1852.4	1880.0	1907.6
WCDMA Band IV	Channel	1312	1413	1513
	Frequency	1712.4	1732.6	1752.6

3 Conducted Test Result

3.1 Measuring Instruments

See list of measuring instruments of this test report.

3.2 Test Setup

3.2.1 Conducted Output Power

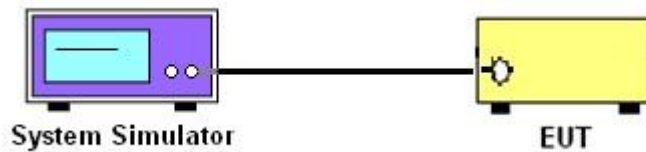

3.2.2 Peak-to-Average Ratio, Occupied Bandwidth, Conducted Band-Edge and Conducted Spurious Emission

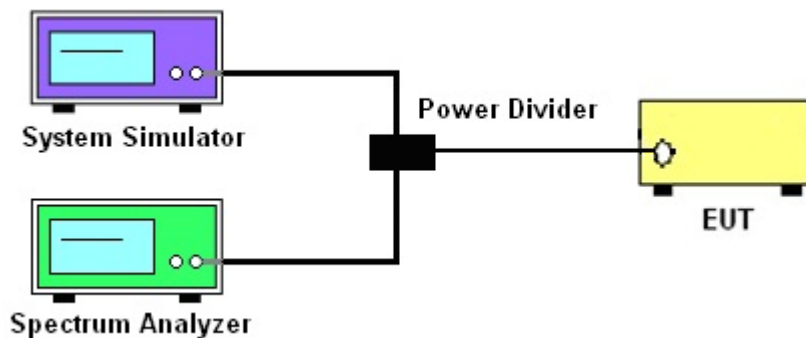

3.2.3 Frequency Stability

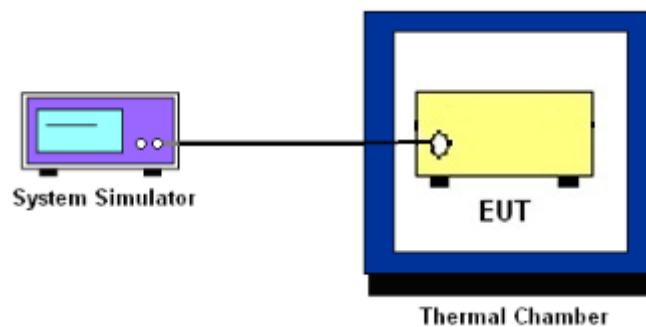

3.3 Test Result of Conducted Test

Please refer to Appendix A.



3.4 Conducted Output Power and ERP/EIRP

3.4.1 Description of the Conducted Output Power and ERP/EIRP

A system simulator was used to establish communication with the EUT. Its parameters were set to enforce EUT transmitting at the maximum power. The measured power in the radio frequency on the transmitter output terminals shall be reported.

The ERP of mobile transmitters must not exceed 7 Watts for GSM850 and WCDMA Band V.

The EIRP of mobile transmitters must not exceed 2 Watts for GSM1900 and WCDMA Band II.

The EIRP of mobile transmitters must not exceed 1 Watts for WCDMA Band IV.

According to KDB 412172 D01 Power Approach,

$EIRP = P_T + G_T - L_C$, $ERP = EIRP - 2.15$, where

P_T = transmitter output power in dBm

G_T = gain of the transmitting antenna in dBi

L_C = signal attenuation in the connecting cable between the transmitter and antenna in dB

3.4.2 Test Procedures

1. The transmitter output port was connected to the system simulator.
2. Set EUT at maximum power through system simulator.
3. Select lowest, middle, and highest channels for each band and different modulation.
4. Measure the maximum burst average power for GSM and maximum average power for other modulation signal.



3.5 Peak-to-Average Ratio

3.5.1 Description of the PAR Measurement

The peak-to-average ratio (PAR) of the transmission may not exceed 13 dB.

3.5.2 Test Procedures

1. The testing follows FCC KDB 971168 D01 v02r02 Section 5.7.1.
2. The EUT was connected to spectrum analyzer and system simulator via a power divider.
3. Set EUT to transmit at maximum output power.
4. When the duty cycle is less than 98%, then signal gating will be implemented on the spectrum analyzer by triggering from the system simulator.
5. Set the CCDF (Complementary Cumulative Distribution Function) option of the spectrum analyzer.
Record the maximum PAPR level associated with a probability of 0.1%.



3.6 99% Occupied Bandwidth and 26dB Bandwidth Measurement

3.6.1 Description of 99% Occupied Bandwidth and 26dB Bandwidth Measurement

The occupied bandwidth is the width of a frequency band such that, below the lower and above the upper frequency limits, the mean powers emitted are each equal to a specified percentage 0.5% of the total mean transmitted power.

The 26 dB emission bandwidth is defined as the frequency range between two points, one above and one below the carrier frequency, at which the spectral density of the emission is attenuated 26 dB below the maximum in-band spectral density of the modulated signal. Spectral density (power per unit bandwidth) is to be measured with a detector of resolution bandwidth equal to approximately 1.0% of the emission bandwidth.

3.6.2 Test Procedures

1. The testing follows FCC KDB 971168 v02r02 Section 4.2.
2. The EUT was connected to spectrum analyzer and system simulator via a power divider.
3. The spectrum analyzer center frequency is set to the nominal EUT channel center frequency. The span range for the spectrum analyzer shall be between two and five times the anticipated OBW.
4. The nominal resolution bandwidth (RBW) shall be in the range of 1 to 5 % of the anticipated OBW, and the VBW shall be at least 3 times the RBW.
5. Set the detection mode to peak, and the trace mode to max hold.
6. Determine the reference value: Set the EUT to transmit a modulated signal. Allow the trace to stabilize. Set the spectrum analyzer marker to the highest level of the displayed trace.
(this is the reference value)
7. Determine the “-26 dB down amplitude” as equal to (Reference Value – X).
8. Place two markers, one at the lowest and the other at the highest frequency of the envelope of the spectral display such that each marker is at or slightly below the “-X dB down amplitude” determined in step 6. If a marker is below this “-X dB down amplitude” value it shall be placed as close as possible to this value. The OBW is the positive frequency difference between the two markers.
9. Use the 99 % power bandwidth function of the spectrum analyzer and report the measured bandwidth.



3.7 Conducted Band Edge

3.7.1 Description of Conducted Band Edge Measurement

The power of any emission outside of the authorized operating frequency ranges must be lower than the transmitter power (P) by a factor of at least $43 + 10 \log (P)$ dB.

3.7.2 Test Procedures

1. The testing follows FCC KDB 971168 D01 v02r02 Section 6.0.
2. The EUT was connected to the spectrum analyzer and system simulator via a power divider.
3. The RF output of EUT was connected to the spectrum analyzer by an RF cable and attenuator. The path loss was compensated to the results for each measurement.
4. The band edges of low and high channels for the highest RF powers were measured.
5. The RF fundamental frequency should be excluded against the limit line in the operating frequency band.
6. The limit line is derived from $43 + 10\log(P)$ dB below the transmitter power P(Watts)



3.8 Conducted Spurious Emission

3.8.1 Description of Conducted Spurious Emission Measurement

The power of any emission outside of the authorized operating frequency ranges must be lower than the transmitter power (P) by a factor of at least $43 + 10 \log (P)$ dB.

It is measured by means of a calibrated spectrum analyzer and scanned from 30 MHz up to a frequency including its 10th harmonic.

3.8.2 Test Procedures

1. The testing follows FCC KDB 971168 D01 v02r02 Section 6.0.
2. The EUT was connected to the spectrum analyzer and system simulator via a power divider.
3. The RF output of EUT was connected to the spectrum analyzer by an RF cable and attenuator. The path loss was compensated to the results for each measurement.
4. The middle channel for the highest RF power within the transmitting frequency was measured.
5. The conducted spurious emission for the whole frequency range was taken.
6. The RF fundamental frequency should be excluded against the limit line in the operating frequency band.
7. The limit line is derived from $43 + 10\log(P)$ dB below the transmitter power P(Watts)



3.9 Frequency Stability

3.9.1 Description of Frequency Stability Measurement

The frequency stability shall be measured by variation of ambient temperature and variation of primary supply voltage to ensure that the fundamental emission stays within the authorized frequency block. The frequency stability of the transmitter shall be maintained within $\pm 0.00025\%$ ($\pm 2.5\text{ppm}$) of the center frequency.

3.9.2 Test Procedures for Temperature Variation

1. The testing follows FCC KDB 971168 D01 v02r02 Section 9.0.
2. The EUT was set up in the thermal chamber and connected with the system simulator.
3. With power OFF, the temperature was decreased to -30°C and the EUT was stabilized before testing. Power was applied and the maximum change in frequency was recorded within one minute.
4. With power OFF, the temperature was raised in 10°C steps up to 50°C . The EUT was stabilized at each step for at least half an hour. Power was applied and the maximum frequency change was recorded within one minute.

3.9.3 Test Procedures for Voltage Variation

1. The testing follows FCC KDB 971168 D01 v02r02 Section 9.0.
2. The EUT was placed in a temperature chamber at $20\pm 5^{\circ}\text{C}$ and connected with the system simulator.
3. The power supply voltage to the EUT was varied from 85% to 115% of the nominal value measured at the input to the EUT.
4. The variation in frequency was measured for the worst case.

4 Radiated Test Items

4.1 Measuring Instruments

See list of measuring instruments of this test report.

4.2 Test Setup

4.2.1 For radiated test from 30MHz to 1GHz

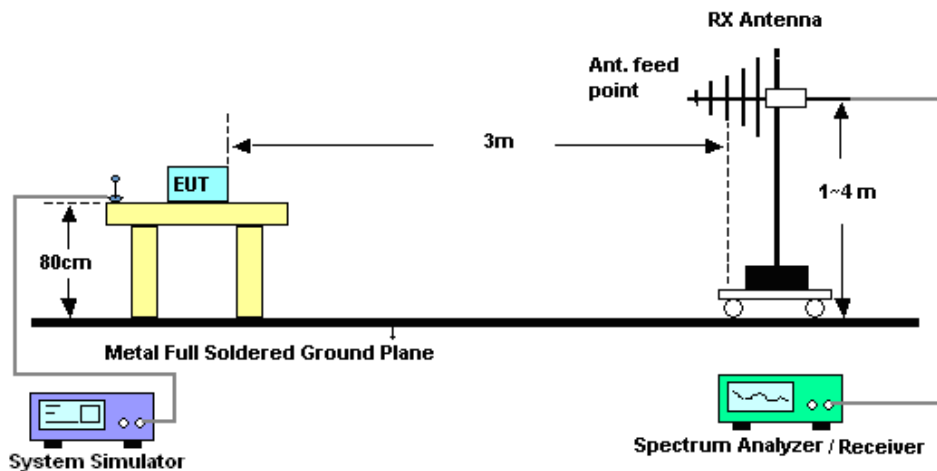

4.2.2 For radiated test above 1GHz

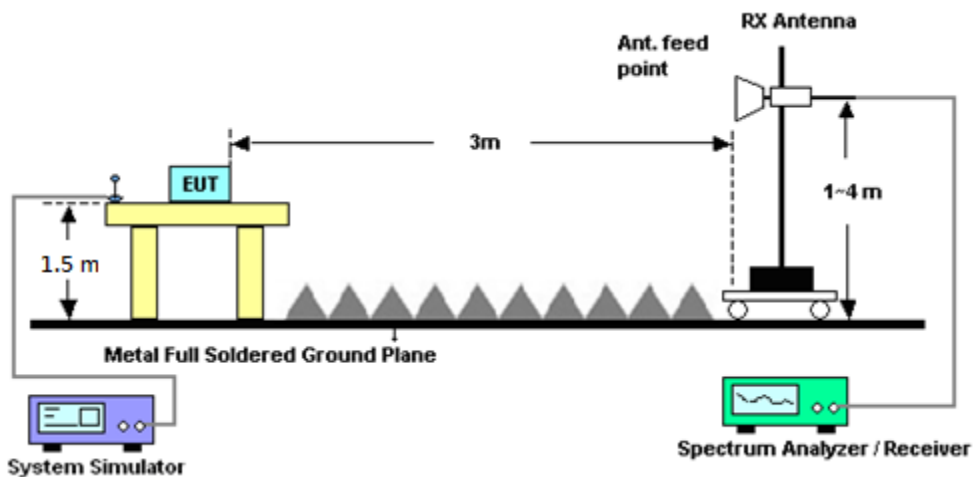

4.3 Test Result of Radiated Test

Please refer to Appendix B.



4.4 Field Strength of Spurious Radiation Measurement

4.4.1 Description of Field Strength of Spurious Radiated Measurement

The power of any emission outside of the authorized operating frequency ranges must be attenuated below the transmitter power (P) by a factor of at least $43 + 10 \log (P)$ dB. The spectrum is scanned from 30 MHz up to a frequency including its 10th harmonic.

4.4.2 Test Procedures

1. The testing follows FCC KDB 971168 D01 v02r02 Section 5.8 and ANSI / TIA-603-D-2010 Section 2.2.12.
2. The EUT was placed on a rotatable wooden table 0.8 meters for frequency below 1GHz and 1.5 meter for frequency above 1GHz above the ground.
3. The EUT was set 3 meters from the receiving antenna, which was mounted on the antenna tower.
4. The table was rotated 360 degrees to determine the position of the highest spurious emission.
5. The height of the receiving antenna is varied between one meter and four meters to search for the maximum spurious emission for both horizontal and vertical polarizations.
6. Make the measurement with the spectrum analyzer's RBW = 1MHz, VBW = 3MHz, taking record of maximum spurious emission.
7. A horn antenna was substituted in place of the EUT and was driven by a signal generator.
8. Tune the output power of signal generator to the same emission level with EUT maximum spurious emission.
9. Taking the record of output power at antenna port.
10. Repeat step 7 to step 8 for another polarization.
11. $EIRP \text{ (dBm)} = S.G. \text{ Power} - Tx \text{ Cable Loss} + Tx \text{ Antenna Gain}$
12. $ERP \text{ (dBm)} = EIRP - 2.15$
13. The RF fundamental frequency should be excluded against the limit line in the operating frequency band.
14. The limit line is derived from $43 + 10\log(P)$ dB below the transmitter power P(Watts)



5 List of Measuring Equipment

Instrument	Manufacturer	Model No.	Serial No.	Characteristics	Calibration Date	Test Date	Due Date	Remark
Spectrum Analyzer	Rohde & Schwarz	FSP30	101329	9kHz~30GHz	Jun. 27, 2016	Apr. 08, 2017~ Apr. 26, 2017	Jun. 26, 2017	Conducted (TH03-HY)
Temperature Chamber	ESPEC	SU-641	92013721	-30°C ~70°C	Nov. 16, 2016	Apr. 08, 2017~ Apr. 26, 2017	Nov. 15, 2017	Conducted (TH03-HY)
Programmable Power Supply	GW Instek	PSS-2005	EL883644	Voltage:0~20V;Current:0~5A	Nov. 22, 2016	Apr. 08, 2017~ Apr. 26, 2017	Nov. 21, 2017	Conducted (TH03-HY)
Base Station (Measure)	Rohde & Schwarz	CMU200	117997	GSM / GPRS / WCDMA / CDMA	Aug. 05, 2016	Apr. 08, 2017~ Apr. 26, 2017	Aug. 04, 2017	Conducted (TH03-HY)
Bilog Antenna	TESEQ	CBL 6111D&008	37059&01	30MHz~1GHz	Oct. 15, 2016	Apr. 13, 2017 ~ Apr. 20, 2017	Oct. 14, 2017	Radiation (03CH12-HY)
Horn Antenna	SCHWARZBECK	BBHA 9120D	9120D-1328	1GHz ~ 18GHz	Oct. 25, 2016	Apr. 13, 2017 ~ Apr. 20, 2017	Oct. 24, 2017	Radiation (03CH12-HY)
EMI Test Receiver	Rohde & Schwarz	ESU26	100390	20Hz~26.5GHz	Dec. 23, 2016	Apr. 13, 2017 ~ Apr. 20, 2017	Dec. 22, 2017	Radiation (03CH12-HY)
Loop Antenna	Rohde & Schwarz	HFH2-Z2	100315	9 kHz~30 MHz	Sep. 02, 2015	Apr. 13, 2017 ~ Apr. 20, 2017	Sep. 01, 2017	Radiation (03CH12-HY)
Preamplifier	MITEQ	AMF-7D-00 101800-30-1	1815698	1GHz~18GHz	Dec. 01, 2016	Apr. 13, 2017 ~ Apr. 20, 2017	Nov. 30, 2017	Radiation (03CH12-HY)
Amplifier	SONOMA	310N	187312	9kHz~1GHz	Nov. 10, 2016	Apr. 13, 2017 ~ Apr. 20, 2017	Nov. 09, 2017	Radiation (03CH12-HY)
Spectrum Analyzer	Agilent	N9030A	MY52350276	3Hz~44GHz	Mar. 23, 2017	Apr. 13, 2017 ~ Apr. 20, 2017	Mar. 22, 2018	Radiation (03CH12-HY)
Antenna Mast	EMEC	AM-BS-450 0-B	N/A	1m~4m	N/A	Apr. 13, 2017 ~ Apr. 20, 2017	N/A	Radiation (03CH12-HY)
Turn Table	EMEC	TT2000	N/A	0~360 Degree	N/A	Apr. 13, 2017 ~ Apr. 20, 2017	N/A	Radiation (03CH12-HY)
Preamplifier	MITEQ	JS44-18004 000-33-8P	1840917	18GHz ~ 40GHz	Jun. 14, 2016	Apr. 13, 2017 ~ Apr. 20, 2017	Jun. 13, 2017	Radiation (03CH12-HY)
SHF-EHF Horn Antenna	SCHWARZBECK	BBHA 9170	BBHA917025 1	18GHz- 40GHz	Nov. 08, 2016	Apr. 13, 2017 ~ Apr. 20, 2017	Nov. 07, 2017	Radiation (03CH12-HY)
Signal Generator	Anritsu	MG3694C	163401	0.1Hz~40GHz	Jan. 04, 2017	Apr. 13, 2017 ~ Apr. 20, 2017	Jan. 03, 2018	Radiation (03CH12-HY)



6 Uncertainty of Evaluation

Uncertainty of Radiated Emission Measurement (30 MHz ~ 1000 MHz)

Measuring Uncertainty for a Level of Confidence of 95% ($U = 2Uc(y)$)	3.36
---	------

Uncertainty of Radiated Emission Measurement (1 GHz ~ 18 GHz)

Measuring Uncertainty for a Level of Confidence of 95% ($U = 2Uc(y)$)	3.70
---	------

Uncertainty of Radiated Emission Measurement (18 GHz ~ 40 GHz)

Measuring Uncertainty for a Level of Confidence of 95% ($U = 2Uc(y)$)	3.98
---	------



Appendix A. Test Results of Conducted Test

Conducted Output Power(Average power)

Conducted Power (*Unit: dBm)						
Band	GSM850			GSM1900		
Channel	128	189	251	512	661	810
Frequency	824.2	836.4	848.8	1850.2	1880	1909.8
GSM	33.16	33.19	33.39	29.45	29.40	29.45
GPRS class 8	33.02	33.07	33.44	29.46	29.43	29.44
GPRS class 10	28.88	28.94	28.93	25.70	25.74	25.82
GPRS class 11	27.09	27.41	27.32	24.35	24.40	24.32
GPRS class 12	26.40	26.45	26.36	22.92	22.96	22.78
EGPRS class 8	26.24	26.21	26.09	25.11	25.15	25.17
EGPRS class 10	25.96	25.97	25.74	24.75	24.85	24.83
EGPRS class 11	25.14	25.17	24.91	23.63	23.73	23.68
EGPRS class 12	24.12	23.94	23.84	22.12	22.03	22.15

Conducted Power (*Unit: dBm)						
Band	WCDMA Band V			WCDMA Band II		
Channel	4132	4182	4233	9262	9400	9538
Frequency	826.4	836.4	846.6	1852.4	1880	1907.6
RMC 12.2K	23.41	23.31	23.12	22.67	22.31	22.70
HSDPA Subtest-1	22.43	22.20	22.13	21.66	21.33	21.49
HSDPA Subtest-2	22.45	22.18	22.15	21.78	21.35	21.64
HSDPA Subtest-3	21.96	21.71	21.66	21.09	20.93	20.97
HSDPA Subtest-4	21.95	21.68	21.60	21.04	20.85	21.04
HSUPA Subtest-1	22.30	22.27	22.10	21.53	21.30	21.46
HSUPA Subtest-2	20.32	20.21	20.07	19.51	19.37	19.47
HSUPA Subtest-3	21.32	21.18	21.13	20.59	20.41	20.53
HSUPA Subtest-4	20.31	20.17	20.09	19.50	19.35	19.41
HSUPA Subtest-5	22.32	22.28	22.13	21.66	21.42	21.78

Conducted Power (*Unit: dBm)			
Band	WCDMA Band V		
Channel	1312	1413	1513
Frequency	1712.4	1732.6	1752.6
RMC 12.2K	22.51	22.37	22.43
HSDPA Subtest-1	21.49	21.37	21.42
HSDPA Subtest-2	21.53	21.27	21.43
HSDPA Subtest-3	20.98	20.83	20.94
HSDPA Subtest-4	21.00	20.86	20.91
HSUPA Subtest-1	21.49	21.15	21.22
HSUPA Subtest-2	19.43	19.13	19.18
HSUPA Subtest-3	20.37	20.16	20.11
HSUPA Subtest-4	19.41	19.15	19.20
HSUPA Subtest-5	21.59	21.15	21.43



A2. GSM

Peak-to-Average Ratio

Mode	GSM850		Limit: 13dB
Mod.	GPRS class 8	EDGE class 8	Result
Lowest CH	0.24	3.04	PASS
Middle CH	0.20	3.24	
Highest CH	0.24	3.16	

Mode	GSM1900		Limit: 13dB
Mod.	GPRS class 8	EDGE class 8	Result
Lowest CH	0.32	3.36	PASS
Middle CH	0.32	3.20	
Highest CH	0.32	3.20	

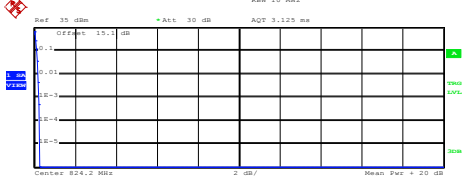
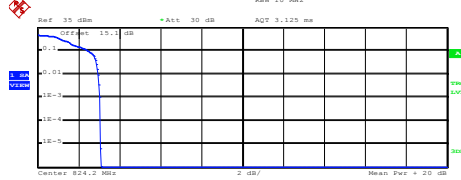
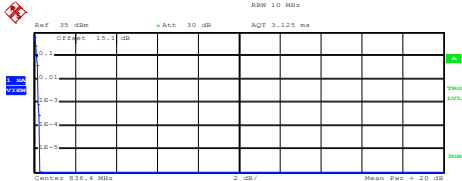
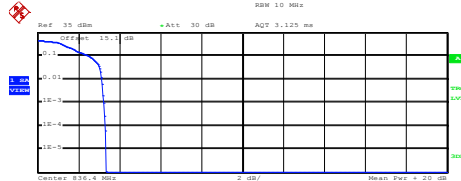
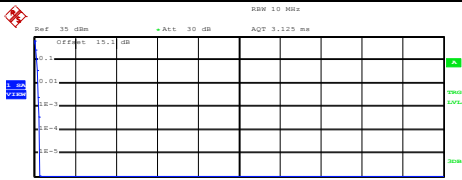
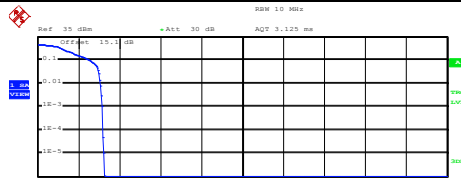

GSM850 (GPRS class 8)	GSM850 (EDGE class 8)																
<p align="center">Lowest Channel</p>  <p>Ref: 35 dBm Att: 30 dB AQT: 3.125 ms</p> <p>Center: 824.2 MHz 2 dB/ Mean Pwr: +20 dB</p> <p>Complementary Cumulative Distribution Function (100000 samples)</p> <p>Trace 1</p> <p>Mean: 31.34 dBm Peak: 31.58 dBm Crest: 0.24 dB</p> <table border="1"> <tr><td>10 %</td><td>0.12 dB</td></tr> <tr><td>1 %</td><td>0.20 dB</td></tr> <tr><td>.1 %</td><td>0.24 dB</td></tr> <tr><td>.01 %</td><td>0.28 dB</td></tr> </table> <p>Date: 8.APR.2017 10:08:41</p>	10 %	0.12 dB	1 %	0.20 dB	.1 %	0.24 dB	.01 %	0.28 dB	<p align="center">Lowest Channel</p>  <p>Ref: 35 dBm Att: 30 dB AQT: 3.125 ms</p> <p>Center: 824.2 MHz 2 dB/ Mean Pwr: +20 dB</p> <p>Complementary Cumulative Distribution Function (100000 samples)</p> <p>Trace 1</p> <p>Mean: 25.28 dBm Peak: 28.41 dBm Crest: 3.12 dB</p> <table border="1"> <tr><td>10 %</td><td>2.48 dB</td></tr> <tr><td>1 %</td><td>2.96 dB</td></tr> <tr><td>.1 %</td><td>3.04 dB</td></tr> <tr><td>.01 %</td><td>3.08 dB</td></tr> </table> <p>Date: 8.APR.2017 10:26:08</p>	10 %	2.48 dB	1 %	2.96 dB	.1 %	3.04 dB	.01 %	3.08 dB
10 %	0.12 dB																
1 %	0.20 dB																
.1 %	0.24 dB																
.01 %	0.28 dB																
10 %	2.48 dB																
1 %	2.96 dB																
.1 %	3.04 dB																
.01 %	3.08 dB																
<p align="center">Middle Channel</p>  <p>Ref: 35 dBm Att: 30 dB AQT: 3.125 ms</p> <p>Center: 836.4 MHz 2 dB/ Mean Pwr: +20 dB</p> <p>Complementary Cumulative Distribution Function (100000 samples)</p> <p>Trace 1</p> <p>Mean: 31.32 dBm Peak: 31.58 dBm Crest: 0.26 dB</p> <table border="1"> <tr><td>10 %</td><td>0.12 dB</td></tr> <tr><td>1 %</td><td>0.20 dB</td></tr> <tr><td>.1 %</td><td>0.20 dB</td></tr> <tr><td>.01 %</td><td>0.28 dB</td></tr> </table> <p>Date: 8.APR.2017 10:09:09</p>	10 %	0.12 dB	1 %	0.20 dB	.1 %	0.20 dB	.01 %	0.28 dB	<p align="center">Middle Channel</p>  <p>Ref: 35 dBm Att: 30 dB AQT: 3.125 ms</p> <p>Center: 836.4 MHz 2 dB/ Mean Pwr: +20 dB</p> <p>Complementary Cumulative Distribution Function (100000 samples)</p> <p>Trace 1</p> <p>Mean: 25.01 dBm Peak: 28.34 dBm Crest: 3.32 dB</p> <table border="1"> <tr><td>10 %</td><td>2.52 dB</td></tr> <tr><td>1 %</td><td>3.12 dB</td></tr> <tr><td>.1 %</td><td>3.24 dB</td></tr> <tr><td>.01 %</td><td>3.32 dB</td></tr> </table> <p>Date: 8.APR.2017 10:26:44</p>	10 %	2.52 dB	1 %	3.12 dB	.1 %	3.24 dB	.01 %	3.32 dB
10 %	0.12 dB																
1 %	0.20 dB																
.1 %	0.20 dB																
.01 %	0.28 dB																
10 %	2.52 dB																
1 %	3.12 dB																
.1 %	3.24 dB																
.01 %	3.32 dB																
<p align="center">Highest Channel</p>  <p>Ref: 35 dBm Att: 30 dB AQT: 3.125 ms</p> <p>Center: 848.8 MHz 2 dB/ Mean Pwr: +20 dB</p> <p>Complementary Cumulative Distribution Function (100000 samples)</p> <p>Trace 1</p> <p>Mean: 31.26 dBm Peak: 31.51 dBm Crest: 0.25 dB</p> <table border="1"> <tr><td>10 %</td><td>0.12 dB</td></tr> <tr><td>1 %</td><td>0.20 dB</td></tr> <tr><td>.1 %</td><td>0.24 dB</td></tr> <tr><td>.01 %</td><td>0.28 dB</td></tr> </table> <p>Date: 8.APR.2017 10:09:48</p>	10 %	0.12 dB	1 %	0.20 dB	.1 %	0.24 dB	.01 %	0.28 dB	<p align="center">Highest Channel</p>  <p>Ref: 35 dBm Att: 30 dB AQT: 3.125 ms</p> <p>Center: 848.8 MHz 2 dB/ Mean Pwr: +20 dB</p> <p>Complementary Cumulative Distribution Function (100000 samples)</p> <p>Trace 1</p> <p>Mean: 25.09 dBm Peak: 28.34 dBm Crest: 3.24 dB</p> <table border="1"> <tr><td>10 %</td><td>2.56 dB</td></tr> <tr><td>1 %</td><td>3.08 dB</td></tr> <tr><td>.1 %</td><td>3.16 dB</td></tr> <tr><td>.01 %</td><td>3.20 dB</td></tr> </table> <p>Date: 8.APR.2017 10:27:23</p>	10 %	2.56 dB	1 %	3.08 dB	.1 %	3.16 dB	.01 %	3.20 dB
10 %	0.12 dB																
1 %	0.20 dB																
.1 %	0.24 dB																
.01 %	0.28 dB																
10 %	2.56 dB																
1 %	3.08 dB																
.1 %	3.16 dB																
.01 %	3.20 dB																

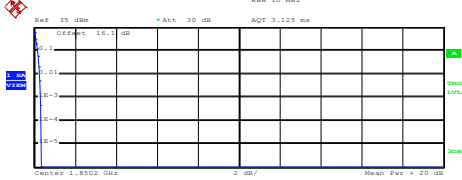
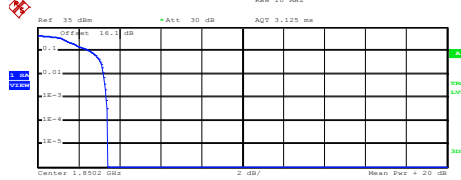
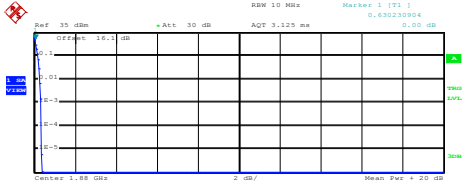
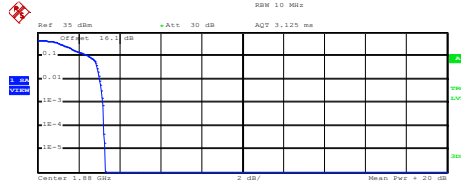
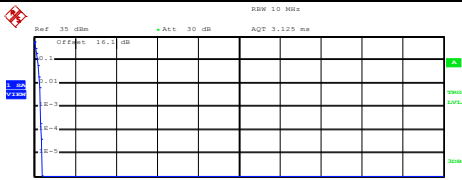
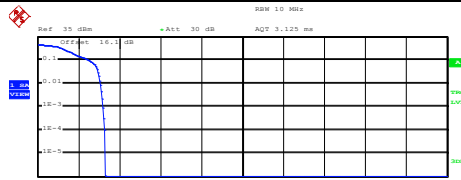

GSM1900 (GPRS class 8)	GSM1900 (EDGE class 8)																												
<p align="center">Lowest Channel</p>  <p>Ref: 35 dBm Att: 30 dB AQT: 3.125 ms Mean Pwr: +20 dB</p> <p>Center: 1.8502 GHz 2 dB/ Mean Pwr: +20 dB</p> <p>Complementary Cumulative Distribution Function (100000 samples)</p> <p>Trace 1</p> <table border="1"> <tr><td>Mean</td><td>28.01 dBm</td></tr> <tr><td>Peak</td><td>28.34 dBm</td></tr> <tr><td>Crest</td><td>0.32 dB</td></tr> </table> <table border="1"> <tr><td>10 %</td><td>0.16 dB</td></tr> <tr><td>1 %</td><td>0.28 dB</td></tr> <tr><td>.1 %</td><td>0.32 dB</td></tr> <tr><td>.01 %</td><td>0.36 dB</td></tr> </table> <p>Date: 8.APR.2017 10:46:31</p>	Mean	28.01 dBm	Peak	28.34 dBm	Crest	0.32 dB	10 %	0.16 dB	1 %	0.28 dB	.1 %	0.32 dB	.01 %	0.36 dB	<p align="center">Lowest Channel</p>  <p>Ref: 35 dBm Att: 30 dB AQT: 3.125 ms Mean Pwr: +20 dB</p> <p>Center: 1.8502 GHz 2 dB/ Mean Pwr: +20 dB</p> <p>Complementary Cumulative Distribution Function (100000 samples)</p> <p>Trace 1</p> <table border="1"> <tr><td>Mean</td><td>23.78 dBm</td></tr> <tr><td>Peak</td><td>27.21 dBm</td></tr> <tr><td>Crest</td><td>3.42 dB</td></tr> </table> <table border="1"> <tr><td>10 %</td><td>2.56 dB</td></tr> <tr><td>1 %</td><td>3.20 dB</td></tr> <tr><td>.1 %</td><td>3.36 dB</td></tr> <tr><td>.01 %</td><td>3.44 dB</td></tr> </table> <p>Date: 8.APR.2017 10:58:15</p>	Mean	23.78 dBm	Peak	27.21 dBm	Crest	3.42 dB	10 %	2.56 dB	1 %	3.20 dB	.1 %	3.36 dB	.01 %	3.44 dB
Mean	28.01 dBm																												
Peak	28.34 dBm																												
Crest	0.32 dB																												
10 %	0.16 dB																												
1 %	0.28 dB																												
.1 %	0.32 dB																												
.01 %	0.36 dB																												
Mean	23.78 dBm																												
Peak	27.21 dBm																												
Crest	3.42 dB																												
10 %	2.56 dB																												
1 %	3.20 dB																												
.1 %	3.36 dB																												
.01 %	3.44 dB																												
<p align="center">Middle Channel</p>  <p>Ref: 35 dBm Att: 30 dB AQT: 3.125 ms Mean Pwr: +20 dB</p> <p>Center: 1.88 GHz 2 dB/ Mean Pwr: +20 dB</p> <p>Complementary Cumulative Distribution Function (100000 samples)</p> <p>Trace 1</p> <table border="1"> <tr><td>Mean</td><td>28.08 dBm</td></tr> <tr><td>Peak</td><td>28.48 dBm</td></tr> <tr><td>Crest</td><td>0.40 dB</td></tr> </table> <table border="1"> <tr><td>10 %</td><td>0.20 dB</td></tr> <tr><td>1 %</td><td>0.28 dB</td></tr> <tr><td>.1 %</td><td>0.32 dB</td></tr> <tr><td>.01 %</td><td>0.36 dB</td></tr> </table> <p>Date: 8.APR.2017 10:47:02</p>	Mean	28.08 dBm	Peak	28.48 dBm	Crest	0.40 dB	10 %	0.20 dB	1 %	0.28 dB	.1 %	0.32 dB	.01 %	0.36 dB	<p align="center">Middle Channel</p>  <p>Ref: 35 dBm Att: 30 dB AQT: 3.125 ms Mean Pwr: +20 dB</p> <p>Center: 1.88 GHz 2 dB/ Mean Pwr: +20 dB</p> <p>Complementary Cumulative Distribution Function (100000 samples)</p> <p>Trace 1</p> <table border="1"> <tr><td>Mean</td><td>23.98 dBm</td></tr> <tr><td>Peak</td><td>27.28 dBm</td></tr> <tr><td>Crest</td><td>3.30 dB</td></tr> </table> <table border="1"> <tr><td>10 %</td><td>2.52 dB</td></tr> <tr><td>1 %</td><td>3.04 dB</td></tr> <tr><td>.1 %</td><td>3.20 dB</td></tr> <tr><td>.01 %</td><td>3.24 dB</td></tr> </table> <p>Date: 8.APR.2017 10:58:40</p>	Mean	23.98 dBm	Peak	27.28 dBm	Crest	3.30 dB	10 %	2.52 dB	1 %	3.04 dB	.1 %	3.20 dB	.01 %	3.24 dB
Mean	28.08 dBm																												
Peak	28.48 dBm																												
Crest	0.40 dB																												
10 %	0.20 dB																												
1 %	0.28 dB																												
.1 %	0.32 dB																												
.01 %	0.36 dB																												
Mean	23.98 dBm																												
Peak	27.28 dBm																												
Crest	3.30 dB																												
10 %	2.52 dB																												
1 %	3.04 dB																												
.1 %	3.20 dB																												
.01 %	3.24 dB																												
<p align="center">Highest Channel</p>  <p>Ref: 35 dBm Att: 30 dB AQT: 3.125 ms Mean Pwr: +20 dB</p> <p>Center: 1.9098 GHz 2 dB/ Mean Pwr: +20 dB</p> <p>Complementary Cumulative Distribution Function (100000 samples)</p> <p>Trace 1</p> <table border="1"> <tr><td>Mean</td><td>28.32 dBm</td></tr> <tr><td>Peak</td><td>28.69 dBm</td></tr> <tr><td>Crest</td><td>0.37 dB</td></tr> </table> <table border="1"> <tr><td>10 %</td><td>0.16 dB</td></tr> <tr><td>1 %</td><td>0.28 dB</td></tr> <tr><td>.1 %</td><td>0.32 dB</td></tr> <tr><td>.01 %</td><td>0.36 dB</td></tr> </table> <p>Date: 8.APR.2017 10:47:28</p>	Mean	28.32 dBm	Peak	28.69 dBm	Crest	0.37 dB	10 %	0.16 dB	1 %	0.28 dB	.1 %	0.32 dB	.01 %	0.36 dB	<p align="center">Highest Channel</p>  <p>Ref: 35 dBm Att: 30 dB AQT: 3.125 ms Mean Pwr: +20 dB</p> <p>Center: 1.9098 GHz 2 dB/ Mean Pwr: +20 dB</p> <p>Complementary Cumulative Distribution Function (100000 samples)</p> <p>Trace 1</p> <table border="1"> <tr><td>Mean</td><td>24.18 dBm</td></tr> <tr><td>Peak</td><td>27.49 dBm</td></tr> <tr><td>Crest</td><td>3.31 dB</td></tr> </table> <table border="1"> <tr><td>10 %</td><td>2.52 dB</td></tr> <tr><td>1 %</td><td>3.08 dB</td></tr> <tr><td>.1 %</td><td>3.20 dB</td></tr> <tr><td>.01 %</td><td>3.28 dB</td></tr> </table> <p>Date: 8.APR.2017 10:59:10</p>	Mean	24.18 dBm	Peak	27.49 dBm	Crest	3.31 dB	10 %	2.52 dB	1 %	3.08 dB	.1 %	3.20 dB	.01 %	3.28 dB
Mean	28.32 dBm																												
Peak	28.69 dBm																												
Crest	0.37 dB																												
10 %	0.16 dB																												
1 %	0.28 dB																												
.1 %	0.32 dB																												
.01 %	0.36 dB																												
Mean	24.18 dBm																												
Peak	27.49 dBm																												
Crest	3.31 dB																												
10 %	2.52 dB																												
1 %	3.08 dB																												
.1 %	3.20 dB																												
.01 %	3.28 dB																												



26dB Bandwidth

Mode	GSM850	
Mod.	GPRS class 8	EDGE class 8
Lowest CH	0.308	0.283
Middle CH	0.316	0.286
Highest CH	0.310	0.288

Mode	GSM1900	
Mod.	GPRS class 8	EDGE class 8
Lowest CH	0.295	0.299
Middle CH	0.313	0.306
Highest CH	0.291	0.299

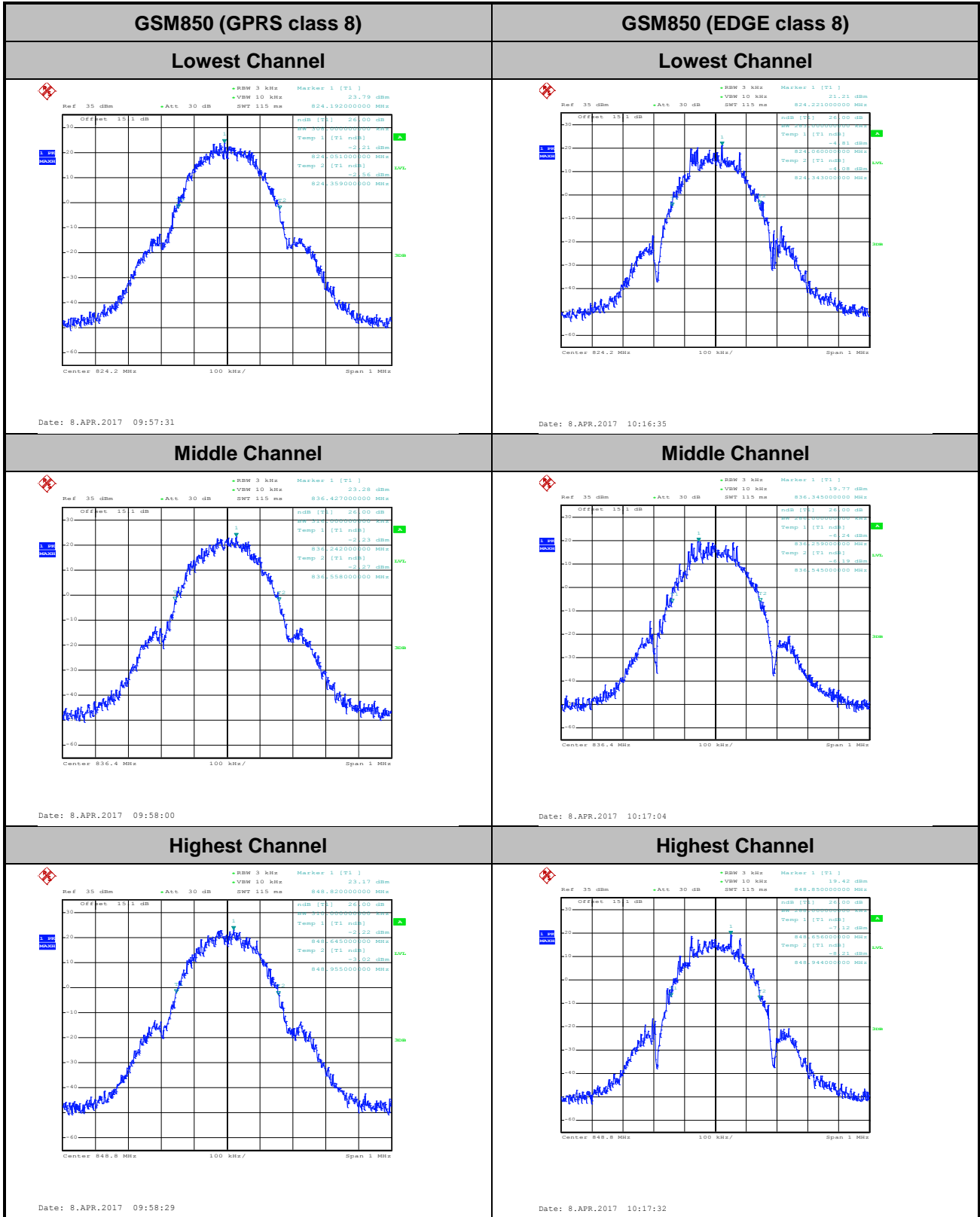

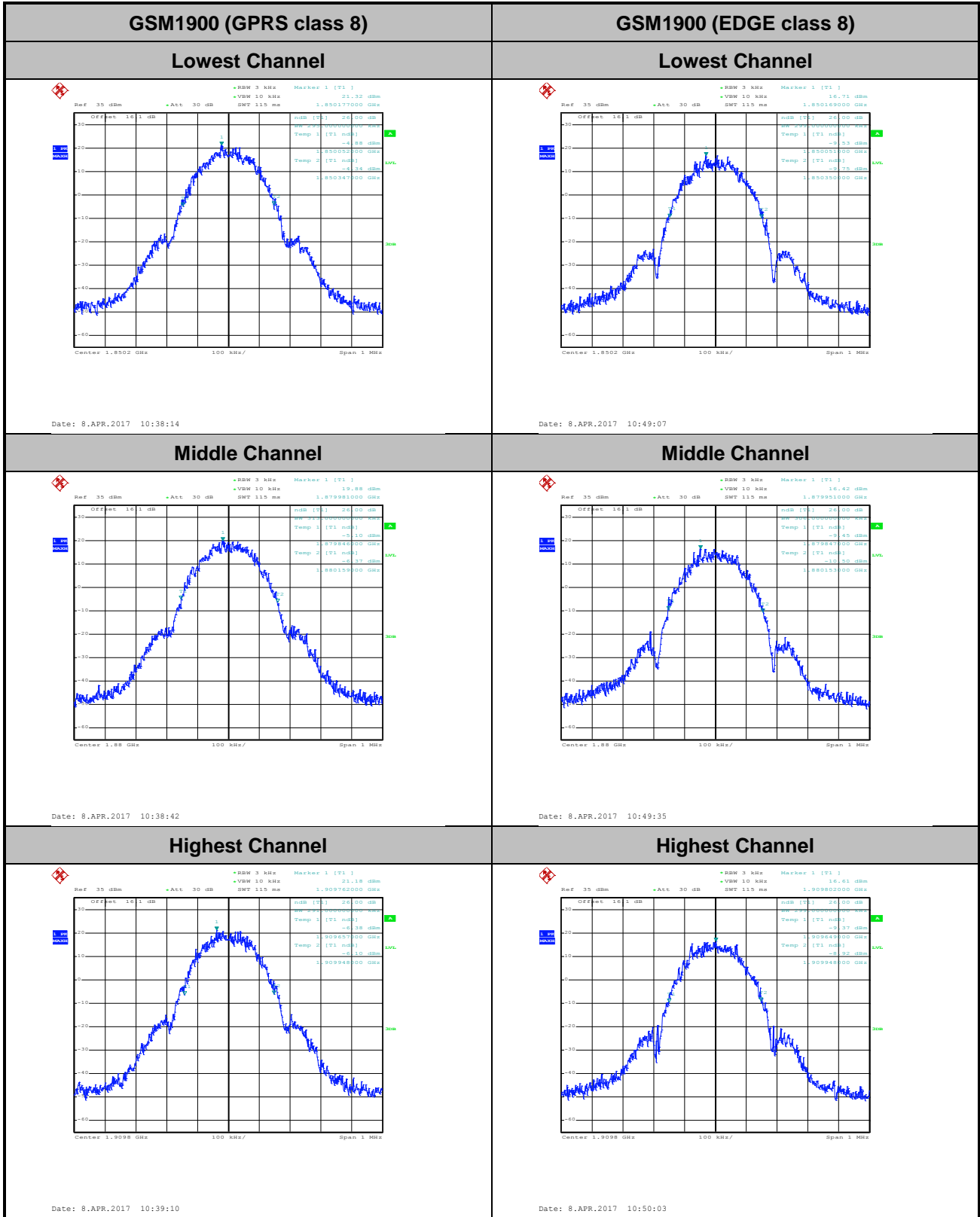



Occupied Bandwidth

Mode	GSM850	
Mod.	GPRS class 8	EDGE class 8
Lowest CH	0.245	0.240
Middle CH	0.250	0.231
Highest CH	0.244	0.245

Mode	GSM1900	
Mod.	GPRS class 8	EDGE class 8
Lowest CH	0.244	0.244
Middle CH	0.242	0.238
Highest CH	0.244	0.245

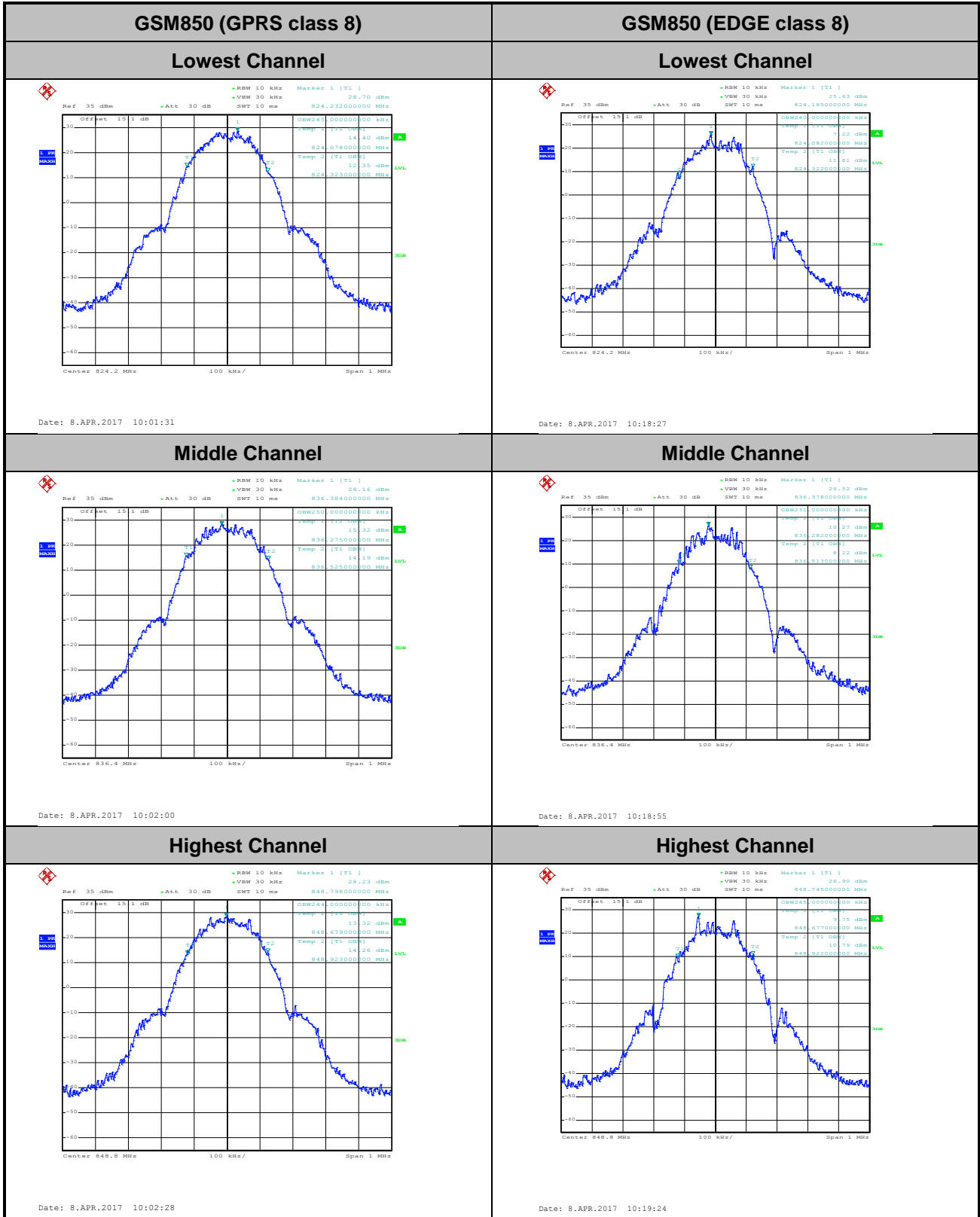

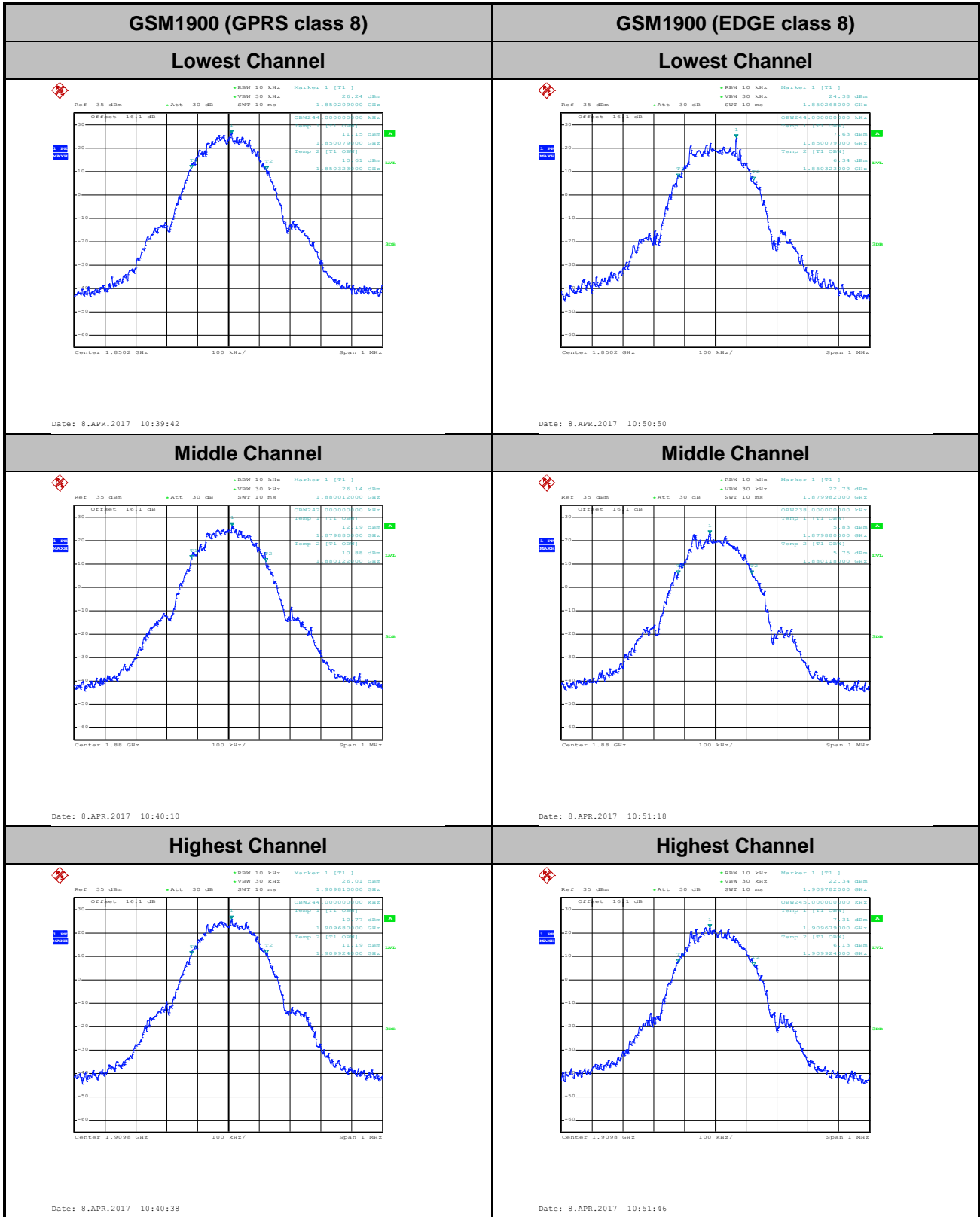



Conducted Band Edge

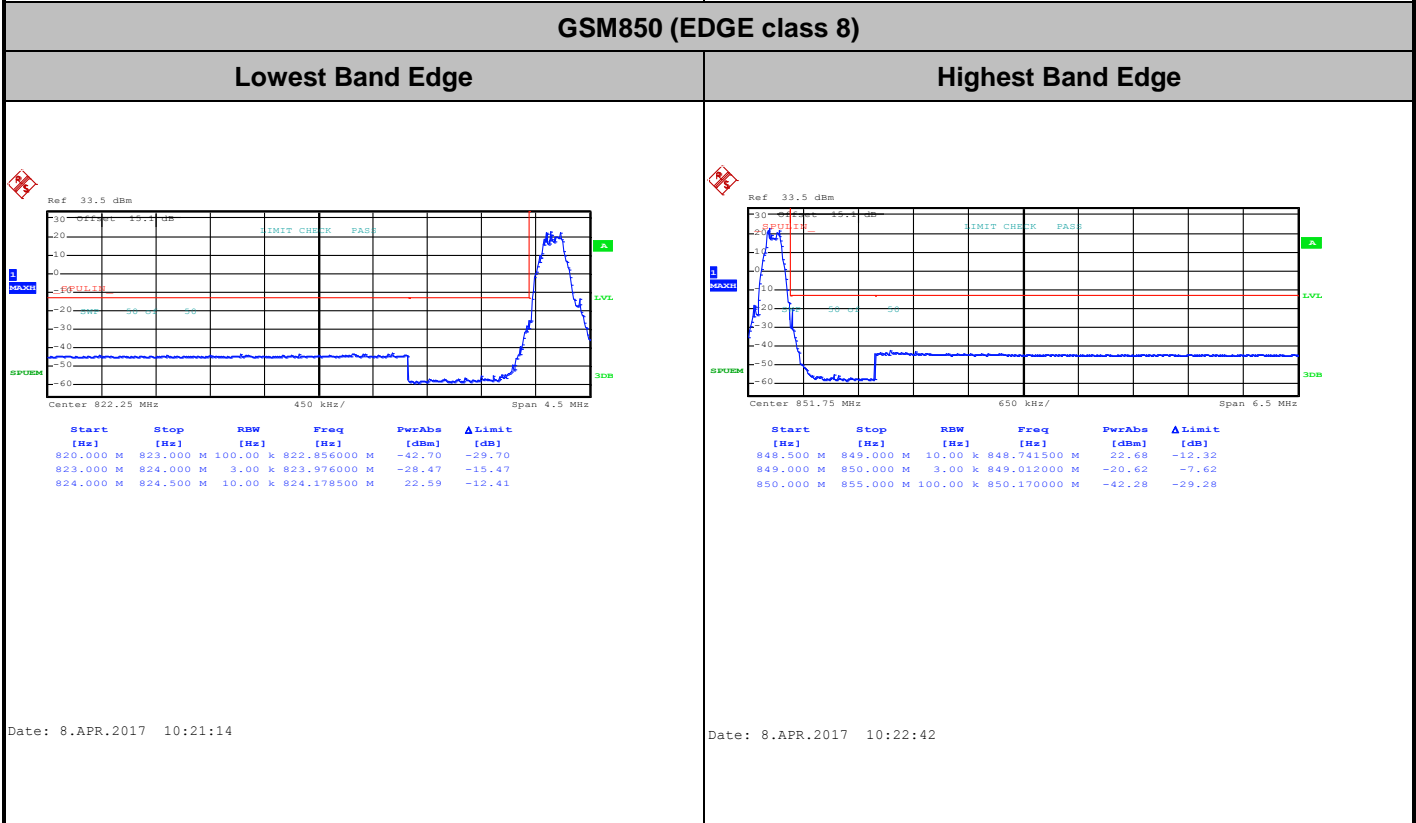
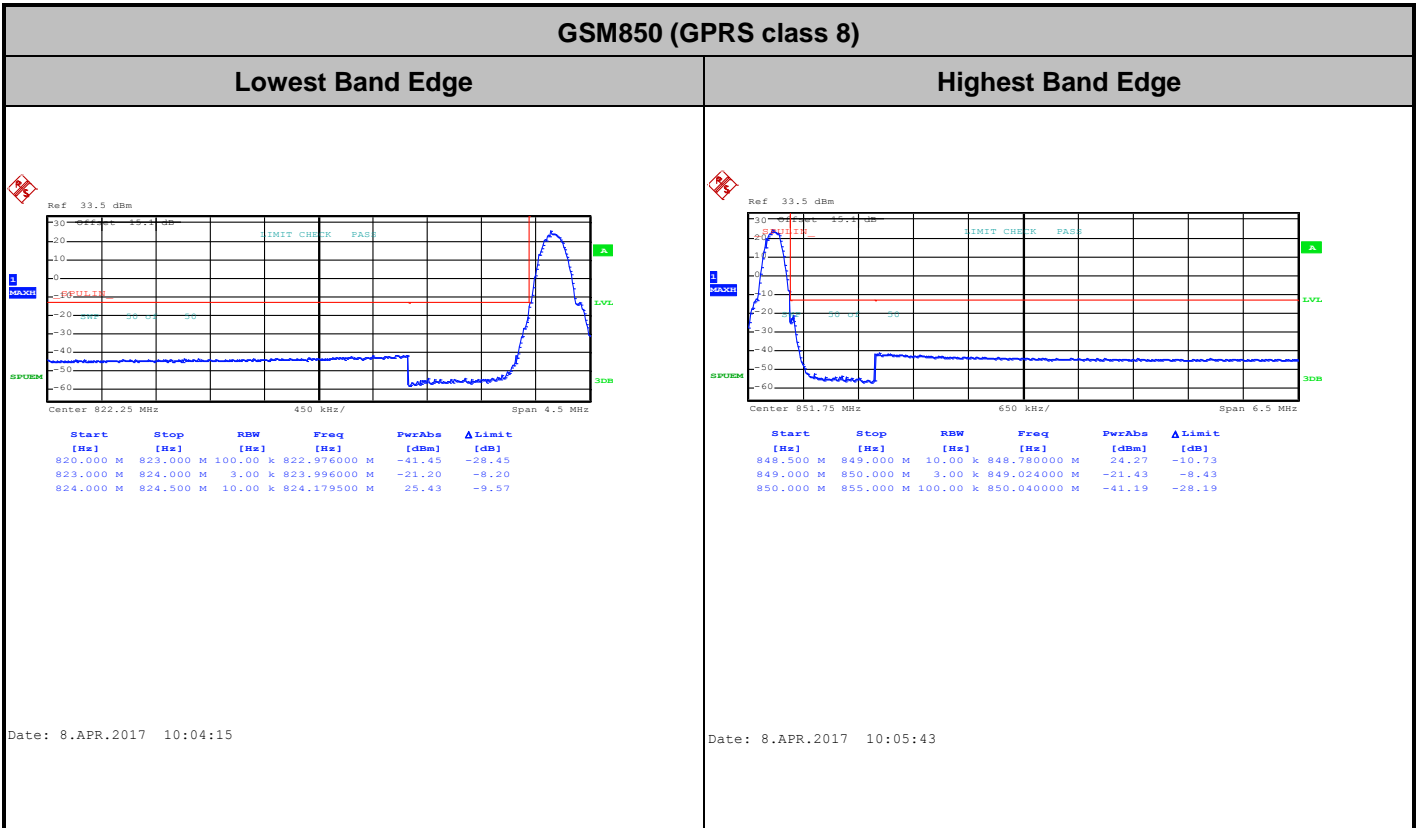



GSM1900 (GPRS class 8)

Lowest Band Edge

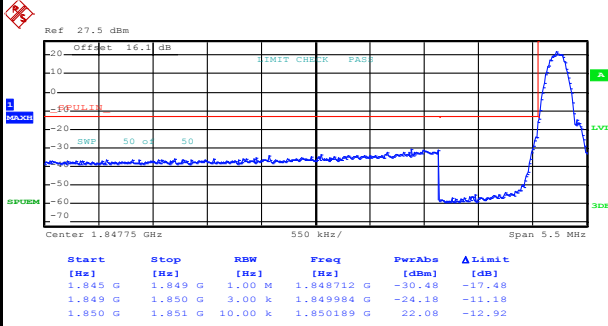

Date: 8.APR.2017 10:42:07

Highest Band Edge

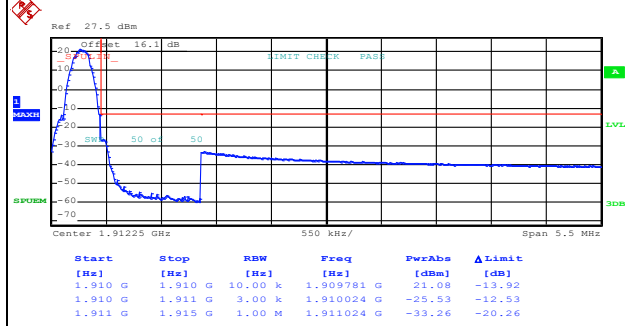

Date: 8.APR.2017 10:43:34

GSM1900 (EDGE class 8)

Lowest Band Edge

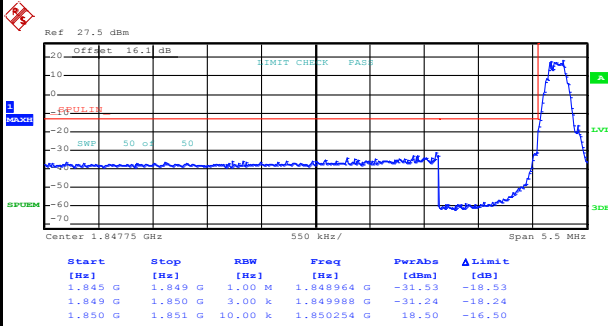

Date: 8.APR.2017 10:53:48

Highest Band Edge

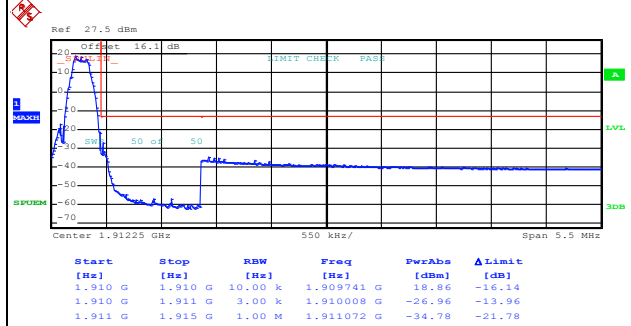

Date: 8.APR.2017 10:55:15

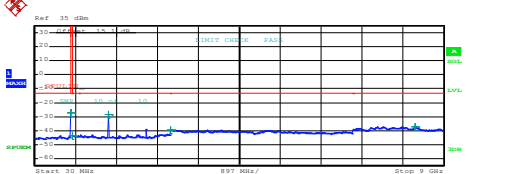
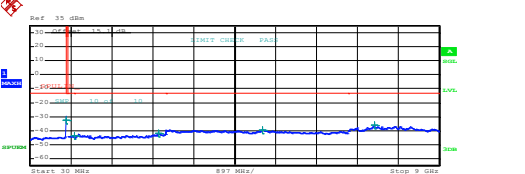
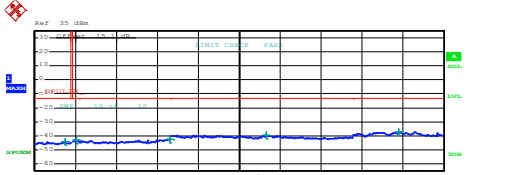
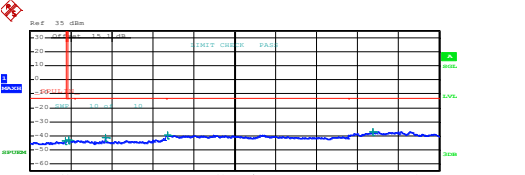
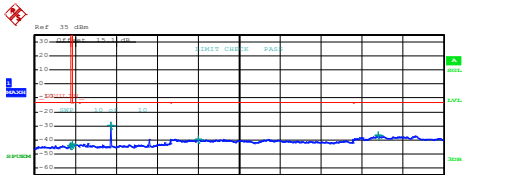
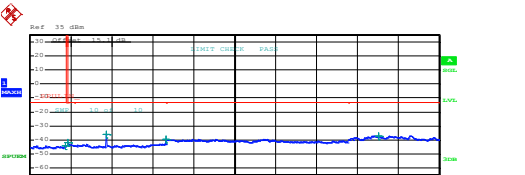

Conducted Spurious Emission

GSM850 (GPRS class 8)	GSM850 (EDGE class 8)																																																																								
Lowest Channel	Lowest Channel																																																																								
 <table border="1" data-bbox="239 622 702 705"> <thead> <tr> <th>Start [Hz]</th> <th>Stop [Hz]</th> <th>RBW [Hz]</th> <th>Freq [Hz]</th> <th>PwrAve [dBm]</th> <th>ΔLimit [dB]</th> </tr> </thead> <tbody> <tr> <td>35,000 M</td> <td>820,000 M</td> <td>1,000 M</td> <td>816,800000 M</td> <td>-27.93</td> <td>-24.33</td> </tr> <tr> <td>855,000 M</td> <td>1,000 G</td> <td>1,000 M</td> <td>857,827500 M</td> <td>-43.60</td> <td>-30.60</td> </tr> <tr> <td>1,000 G</td> <td>3,000 G</td> <td>1,000 M</td> <td>1,688500 G</td> <td>-28.42</td> <td>-25.42</td> </tr> <tr> <td>3,000 G</td> <td>7,000 G</td> <td>1,000 M</td> <td>3,001000 G</td> <td>-39.50</td> <td>-26.50</td> </tr> <tr> <td>7,000 G</td> <td>9,000 G</td> <td>1,000 M</td> <td>8,367000 G</td> <td>-36.93</td> <td>-23.93</td> </tr> </tbody> </table> <p>Date: 8.APR.2017 10:06:37</p>	Start [Hz]	Stop [Hz]	RBW [Hz]	Freq [Hz]	PwrAve [dBm]	ΔLimit [dB]	35,000 M	820,000 M	1,000 M	816,800000 M	-27.93	-24.33	855,000 M	1,000 G	1,000 M	857,827500 M	-43.60	-30.60	1,000 G	3,000 G	1,000 M	1,688500 G	-28.42	-25.42	3,000 G	7,000 G	1,000 M	3,001000 G	-39.50	-26.50	7,000 G	9,000 G	1,000 M	8,367000 G	-36.93	-23.93	 <table border="1" data-bbox="893 622 1356 705"> <thead> <tr> <th>Start [Hz]</th> <th>Stop [Hz]</th> <th>RBW [Hz]</th> <th>Freq [Hz]</th> <th>PwrAve [dBm]</th> <th>ΔLimit [dB]</th> </tr> </thead> <tbody> <tr> <td>35,000 M</td> <td>820,000 M</td> <td>1,000 M</td> <td>816,800000 M</td> <td>-27.97</td> <td>-24.37</td> </tr> <tr> <td>855,000 M</td> <td>1,000 G</td> <td>1,000 M</td> <td>857,827500 M</td> <td>-43.79</td> <td>-30.79</td> </tr> <tr> <td>1,000 G</td> <td>3,000 G</td> <td>1,000 M</td> <td>2,849500 G</td> <td>-42.37</td> <td>-29.37</td> </tr> <tr> <td>3,000 G</td> <td>7,000 G</td> <td>1,000 M</td> <td>5,121000 G</td> <td>-39.41</td> <td>-26.41</td> </tr> <tr> <td>7,000 G</td> <td>9,000 G</td> <td>1,000 M</td> <td>7,580500 G</td> <td>-36.31</td> <td>-23.31</td> </tr> </tbody> </table> <p>Date: 8.APR.2017 10:23:49</p>	Start [Hz]	Stop [Hz]	RBW [Hz]	Freq [Hz]	PwrAve [dBm]	ΔLimit [dB]	35,000 M	820,000 M	1,000 M	816,800000 M	-27.97	-24.37	855,000 M	1,000 G	1,000 M	857,827500 M	-43.79	-30.79	1,000 G	3,000 G	1,000 M	2,849500 G	-42.37	-29.37	3,000 G	7,000 G	1,000 M	5,121000 G	-39.41	-26.41	7,000 G	9,000 G	1,000 M	7,580500 G	-36.31	-23.31
Start [Hz]	Stop [Hz]	RBW [Hz]	Freq [Hz]	PwrAve [dBm]	ΔLimit [dB]																																																																				
35,000 M	820,000 M	1,000 M	816,800000 M	-27.93	-24.33																																																																				
855,000 M	1,000 G	1,000 M	857,827500 M	-43.60	-30.60																																																																				
1,000 G	3,000 G	1,000 M	1,688500 G	-28.42	-25.42																																																																				
3,000 G	7,000 G	1,000 M	3,001000 G	-39.50	-26.50																																																																				
7,000 G	9,000 G	1,000 M	8,367000 G	-36.93	-23.93																																																																				
Start [Hz]	Stop [Hz]	RBW [Hz]	Freq [Hz]	PwrAve [dBm]	ΔLimit [dB]																																																																				
35,000 M	820,000 M	1,000 M	816,800000 M	-27.97	-24.37																																																																				
855,000 M	1,000 G	1,000 M	857,827500 M	-43.79	-30.79																																																																				
1,000 G	3,000 G	1,000 M	2,849500 G	-42.37	-29.37																																																																				
3,000 G	7,000 G	1,000 M	5,121000 G	-39.41	-26.41																																																																				
7,000 G	9,000 G	1,000 M	7,580500 G	-36.31	-23.31																																																																				
Middle Channel	Middle Channel																																																																								
 <table border="1" data-bbox="239 1137 702 1220"> <thead> <tr> <th>Start [Hz]</th> <th>Stop [Hz]</th> <th>RBW [Hz]</th> <th>Freq [Hz]</th> <th>PwrAve [dBm]</th> <th>ΔLimit [dB]</th> </tr> </thead> <tbody> <tr> <td>35,000 M</td> <td>820,000 M</td> <td>1,000 M</td> <td>885,107500 M</td> <td>-44.07</td> <td>-31.07</td> </tr> <tr> <td>855,000 M</td> <td>1,000 G</td> <td>1,000 M</td> <td>949,293750 M</td> <td>-43.19</td> <td>-30.19</td> </tr> <tr> <td>1,000 G</td> <td>3,000 G</td> <td>1,000 M</td> <td>2,982000 G</td> <td>-42.35</td> <td>-29.35</td> </tr> <tr> <td>3,000 G</td> <td>7,000 G</td> <td>1,000 M</td> <td>5,109000 G</td> <td>-39.61</td> <td>-26.61</td> </tr> <tr> <td>7,000 G</td> <td>9,000 G</td> <td>1,000 M</td> <td>8,022000 G</td> <td>-37.93</td> <td>-24.93</td> </tr> </tbody> </table> <p>Date: 8.APR.2017 10:07:23</p>	Start [Hz]	Stop [Hz]	RBW [Hz]	Freq [Hz]	PwrAve [dBm]	ΔLimit [dB]	35,000 M	820,000 M	1,000 M	885,107500 M	-44.07	-31.07	855,000 M	1,000 G	1,000 M	949,293750 M	-43.19	-30.19	1,000 G	3,000 G	1,000 M	2,982000 G	-42.35	-29.35	3,000 G	7,000 G	1,000 M	5,109000 G	-39.61	-26.61	7,000 G	9,000 G	1,000 M	8,022000 G	-37.93	-24.93	 <table border="1" data-bbox="893 1137 1356 1220"> <thead> <tr> <th>Start [Hz]</th> <th>Stop [Hz]</th> <th>RBW [Hz]</th> <th>Freq [Hz]</th> <th>PwrAve [dBm]</th> <th>ΔLimit [dB]</th> </tr> </thead> <tbody> <tr> <td>35,000 M</td> <td>820,000 M</td> <td>1,000 M</td> <td>885,780000 M</td> <td>-43.45</td> <td>-30.45</td> </tr> <tr> <td>855,000 M</td> <td>1,000 G</td> <td>1,000 M</td> <td>886,388750 M</td> <td>-43.23</td> <td>-30.23</td> </tr> <tr> <td>1,000 G</td> <td>3,000 G</td> <td>1,000 M</td> <td>1,672500 G</td> <td>-41.06</td> <td>-28.06</td> </tr> <tr> <td>3,000 G</td> <td>7,000 G</td> <td>1,000 M</td> <td>3,038000 G</td> <td>-39.40</td> <td>-26.40</td> </tr> <tr> <td>7,000 G</td> <td>9,000 G</td> <td>1,000 M</td> <td>7,543500 G</td> <td>-36.55</td> <td>-23.55</td> </tr> </tbody> </table> <p>Date: 8.APR.2017 10:24:35</p>	Start [Hz]	Stop [Hz]	RBW [Hz]	Freq [Hz]	PwrAve [dBm]	ΔLimit [dB]	35,000 M	820,000 M	1,000 M	885,780000 M	-43.45	-30.45	855,000 M	1,000 G	1,000 M	886,388750 M	-43.23	-30.23	1,000 G	3,000 G	1,000 M	1,672500 G	-41.06	-28.06	3,000 G	7,000 G	1,000 M	3,038000 G	-39.40	-26.40	7,000 G	9,000 G	1,000 M	7,543500 G	-36.55	-23.55
Start [Hz]	Stop [Hz]	RBW [Hz]	Freq [Hz]	PwrAve [dBm]	ΔLimit [dB]																																																																				
35,000 M	820,000 M	1,000 M	885,107500 M	-44.07	-31.07																																																																				
855,000 M	1,000 G	1,000 M	949,293750 M	-43.19	-30.19																																																																				
1,000 G	3,000 G	1,000 M	2,982000 G	-42.35	-29.35																																																																				
3,000 G	7,000 G	1,000 M	5,109000 G	-39.61	-26.61																																																																				
7,000 G	9,000 G	1,000 M	8,022000 G	-37.93	-24.93																																																																				
Start [Hz]	Stop [Hz]	RBW [Hz]	Freq [Hz]	PwrAve [dBm]	ΔLimit [dB]																																																																				
35,000 M	820,000 M	1,000 M	885,780000 M	-43.45	-30.45																																																																				
855,000 M	1,000 G	1,000 M	886,388750 M	-43.23	-30.23																																																																				
1,000 G	3,000 G	1,000 M	1,672500 G	-41.06	-28.06																																																																				
3,000 G	7,000 G	1,000 M	3,038000 G	-39.40	-26.40																																																																				
7,000 G	9,000 G	1,000 M	7,543500 G	-36.55	-23.55																																																																				
Highest Channel	Highest Channel																																																																								
 <table border="1" data-bbox="239 1653 702 1736"> <thead> <tr> <th>Start [Hz]</th> <th>Stop [Hz]</th> <th>RBW [Hz]</th> <th>Freq [Hz]</th> <th>PwrAve [dBm]</th> <th>ΔLimit [dB]</th> </tr> </thead> <tbody> <tr> <td>35,000 M</td> <td>820,000 M</td> <td>1,000 M</td> <td>817,200000 M</td> <td>-44.17</td> <td>-31.17</td> </tr> <tr> <td>855,000 M</td> <td>1,000 G</td> <td>1,000 M</td> <td>857,030000 M</td> <td>-43.10</td> <td>-30.10</td> </tr> <tr> <td>1,000 G</td> <td>3,000 G</td> <td>1,000 M</td> <td>1,697500 G</td> <td>-39.62</td> <td>-26.62</td> </tr> <tr> <td>3,000 G</td> <td>7,000 G</td> <td>1,000 M</td> <td>3,613000 G</td> <td>-39.30</td> <td>-26.30</td> </tr> <tr> <td>7,000 G</td> <td>9,000 G</td> <td>1,000 M</td> <td>7,560000 G</td> <td>-36.88</td> <td>-23.88</td> </tr> </tbody> </table> <p>Date: 8.APR.2017 10:08:08</p>	Start [Hz]	Stop [Hz]	RBW [Hz]	Freq [Hz]	PwrAve [dBm]	ΔLimit [dB]	35,000 M	820,000 M	1,000 M	817,200000 M	-44.17	-31.17	855,000 M	1,000 G	1,000 M	857,030000 M	-43.10	-30.10	1,000 G	3,000 G	1,000 M	1,697500 G	-39.62	-26.62	3,000 G	7,000 G	1,000 M	3,613000 G	-39.30	-26.30	7,000 G	9,000 G	1,000 M	7,560000 G	-36.88	-23.88	 <table border="1" data-bbox="893 1653 1356 1736"> <thead> <tr> <th>Start [Hz]</th> <th>Stop [Hz]</th> <th>RBW [Hz]</th> <th>Freq [Hz]</th> <th>PwrAve [dBm]</th> <th>ΔLimit [dB]</th> </tr> </thead> <tbody> <tr> <td>35,000 M</td> <td>820,000 M</td> <td>1,000 M</td> <td>808,240000 M</td> <td>-43.99</td> <td>-30.99</td> </tr> <tr> <td>855,000 M</td> <td>1,000 G</td> <td>1,000 M</td> <td>855,108750 M</td> <td>-42.15</td> <td>-29.15</td> </tr> <tr> <td>1,000 G</td> <td>3,000 G</td> <td>1,000 M</td> <td>1,697500 G</td> <td>-39.21</td> <td>-26.21</td> </tr> <tr> <td>3,000 G</td> <td>7,000 G</td> <td>1,000 M</td> <td>3,013000 G</td> <td>-39.48</td> <td>-26.48</td> </tr> <tr> <td>7,000 G</td> <td>9,000 G</td> <td>1,000 M</td> <td>7,669000 G</td> <td>-37.18</td> <td>-24.18</td> </tr> </tbody> </table> <p>Date: 8.APR.2017 10:25:20</p>	Start [Hz]	Stop [Hz]	RBW [Hz]	Freq [Hz]	PwrAve [dBm]	ΔLimit [dB]	35,000 M	820,000 M	1,000 M	808,240000 M	-43.99	-30.99	855,000 M	1,000 G	1,000 M	855,108750 M	-42.15	-29.15	1,000 G	3,000 G	1,000 M	1,697500 G	-39.21	-26.21	3,000 G	7,000 G	1,000 M	3,013000 G	-39.48	-26.48	7,000 G	9,000 G	1,000 M	7,669000 G	-37.18	-24.18
Start [Hz]	Stop [Hz]	RBW [Hz]	Freq [Hz]	PwrAve [dBm]	ΔLimit [dB]																																																																				
35,000 M	820,000 M	1,000 M	817,200000 M	-44.17	-31.17																																																																				
855,000 M	1,000 G	1,000 M	857,030000 M	-43.10	-30.10																																																																				
1,000 G	3,000 G	1,000 M	1,697500 G	-39.62	-26.62																																																																				
3,000 G	7,000 G	1,000 M	3,613000 G	-39.30	-26.30																																																																				
7,000 G	9,000 G	1,000 M	7,560000 G	-36.88	-23.88																																																																				
Start [Hz]	Stop [Hz]	RBW [Hz]	Freq [Hz]	PwrAve [dBm]	ΔLimit [dB]																																																																				
35,000 M	820,000 M	1,000 M	808,240000 M	-43.99	-30.99																																																																				
855,000 M	1,000 G	1,000 M	855,108750 M	-42.15	-29.15																																																																				
1,000 G	3,000 G	1,000 M	1,697500 G	-39.21	-26.21																																																																				
3,000 G	7,000 G	1,000 M	3,013000 G	-39.48	-26.48																																																																				
7,000 G	9,000 G	1,000 M	7,669000 G	-37.18	-24.18																																																																				

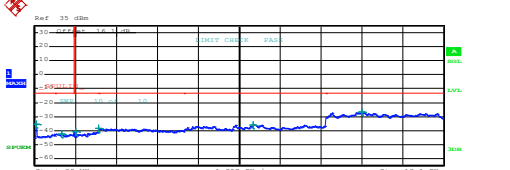
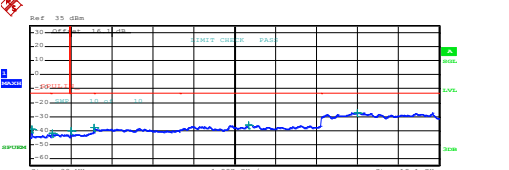
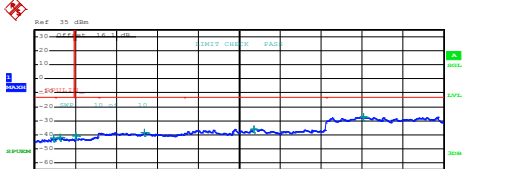
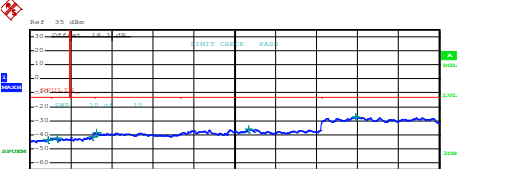
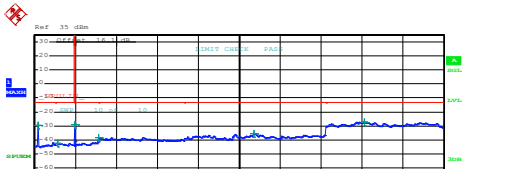
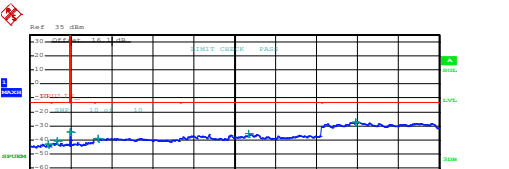

GSM1900 (GPRS class 8)	GSM1900 (EDGE class 8)																																																																																				
Lowest Channel	Lowest Channel																																																																																				
 <table border="1" data-bbox="239 526 750 616"> <thead> <tr> <th>Start [Hz]</th> <th>Stop [Hz]</th> <th>RBW [Hz]</th> <th>Freq [Hz]</th> <th>PwrAve [dBm]</th> <th>ΔLimit [dB]</th> </tr> </thead> <tbody> <tr><td>30,000 M</td><td>1,000 G</td><td>1,000 M</td><td>111,945000 M</td><td>-35.70</td><td>-22.70</td></tr> <tr><td>1,000 G</td><td>1,845 G</td><td>1,000 M</td><td>1,273790 G</td><td>-42.51</td><td>-29.51</td></tr> <tr><td>1,845 G</td><td>3,000 G</td><td>1,000 M</td><td>1,947950 G</td><td>-40.62</td><td>-27.62</td></tr> <tr><td>3,000 G</td><td>7,000 G</td><td>1,000 M</td><td>3,011500 G</td><td>-38.20</td><td>-25.20</td></tr> <tr><td>7,000 G</td><td>13,600 G</td><td>1,000 M</td><td>10,208425 G</td><td>-35.79</td><td>-22.79</td></tr> <tr><td>13,600 G</td><td>19,100 G</td><td>1,000 M</td><td>15,206063 G</td><td>-26.96</td><td>-13.96</td></tr> </tbody> </table> <p data-bbox="207 784 383 801">Date: 8.APR.2017 10:44:27</p>	Start [Hz]	Stop [Hz]	RBW [Hz]	Freq [Hz]	PwrAve [dBm]	ΔLimit [dB]	30,000 M	1,000 G	1,000 M	111,945000 M	-35.70	-22.70	1,000 G	1,845 G	1,000 M	1,273790 G	-42.51	-29.51	1,845 G	3,000 G	1,000 M	1,947950 G	-40.62	-27.62	3,000 G	7,000 G	1,000 M	3,011500 G	-38.20	-25.20	7,000 G	13,600 G	1,000 M	10,208425 G	-35.79	-22.79	13,600 G	19,100 G	1,000 M	15,206063 G	-26.96	-13.96	 <table border="1" data-bbox="893 526 1404 616"> <thead> <tr> <th>Start [Hz]</th> <th>Stop [Hz]</th> <th>RBW [Hz]</th> <th>Freq [Hz]</th> <th>PwrAve [dBm]</th> <th>ΔLimit [dB]</th> </tr> </thead> <tbody> <tr><td>30,000 M</td><td>1,000 G</td><td>1,000 M</td><td>111,945000 M</td><td>-35.01</td><td>-24.01</td></tr> <tr><td>1,000 G</td><td>1,845 G</td><td>1,000 M</td><td>1,034080 G</td><td>-41.86</td><td>-28.86</td></tr> <tr><td>1,845 G</td><td>3,000 G</td><td>1,000 M</td><td>1,947921 G</td><td>-40.35</td><td>-27.35</td></tr> <tr><td>3,000 G</td><td>7,000 G</td><td>1,000 M</td><td>3,013500 G</td><td>-37.96</td><td>-24.96</td></tr> <tr><td>7,000 G</td><td>13,600 G</td><td>1,000 M</td><td>10,217990 G</td><td>-36.02</td><td>-23.02</td></tr> <tr><td>13,600 G</td><td>19,100 G</td><td>1,000 M</td><td>15,205375 G</td><td>-27.14</td><td>-14.14</td></tr> </tbody> </table> <p data-bbox="861 784 1037 801">Date: 8.APR.2017 10:56:07</p>	Start [Hz]	Stop [Hz]	RBW [Hz]	Freq [Hz]	PwrAve [dBm]	ΔLimit [dB]	30,000 M	1,000 G	1,000 M	111,945000 M	-35.01	-24.01	1,000 G	1,845 G	1,000 M	1,034080 G	-41.86	-28.86	1,845 G	3,000 G	1,000 M	1,947921 G	-40.35	-27.35	3,000 G	7,000 G	1,000 M	3,013500 G	-37.96	-24.96	7,000 G	13,600 G	1,000 M	10,217990 G	-36.02	-23.02	13,600 G	19,100 G	1,000 M	15,205375 G	-27.14	-14.14
Start [Hz]	Stop [Hz]	RBW [Hz]	Freq [Hz]	PwrAve [dBm]	ΔLimit [dB]																																																																																
30,000 M	1,000 G	1,000 M	111,945000 M	-35.70	-22.70																																																																																
1,000 G	1,845 G	1,000 M	1,273790 G	-42.51	-29.51																																																																																
1,845 G	3,000 G	1,000 M	1,947950 G	-40.62	-27.62																																																																																
3,000 G	7,000 G	1,000 M	3,011500 G	-38.20	-25.20																																																																																
7,000 G	13,600 G	1,000 M	10,208425 G	-35.79	-22.79																																																																																
13,600 G	19,100 G	1,000 M	15,206063 G	-26.96	-13.96																																																																																
Start [Hz]	Stop [Hz]	RBW [Hz]	Freq [Hz]	PwrAve [dBm]	ΔLimit [dB]																																																																																
30,000 M	1,000 G	1,000 M	111,945000 M	-35.01	-24.01																																																																																
1,000 G	1,845 G	1,000 M	1,034080 G	-41.86	-28.86																																																																																
1,845 G	3,000 G	1,000 M	1,947921 G	-40.35	-27.35																																																																																
3,000 G	7,000 G	1,000 M	3,013500 G	-37.96	-24.96																																																																																
7,000 G	13,600 G	1,000 M	10,217990 G	-36.02	-23.02																																																																																
13,600 G	19,100 G	1,000 M	15,205375 G	-27.14	-14.14																																																																																
Middle Channel	Middle Channel																																																																																				
 <table border="1" data-bbox="239 1041 750 1131"> <thead> <tr> <th>Start [Hz]</th> <th>Stop [Hz]</th> <th>RBW [Hz]</th> <th>Freq [Hz]</th> <th>PwrAve [dBm]</th> <th>ΔLimit [dB]</th> </tr> </thead> <tbody> <tr><td>30,000 M</td><td>1,000 G</td><td>1,000 M</td><td>894,270000 M</td><td>-42.60</td><td>-29.60</td></tr> <tr><td>1,000 G</td><td>3,845 G</td><td>1,000 M</td><td>1,213980 G</td><td>-43.62</td><td>-30.62</td></tr> <tr><td>1,915 G</td><td>3,000 G</td><td>1,000 M</td><td>1,947950 G</td><td>-40.86</td><td>-27.86</td></tr> <tr><td>3,000 G</td><td>7,000 G</td><td>1,000 M</td><td>3,132000 G</td><td>-38.40</td><td>-25.40</td></tr> <tr><td>7,000 G</td><td>13,600 G</td><td>1,000 M</td><td>10,207500 G</td><td>-35.98</td><td>-22.98</td></tr> <tr><td>13,600 G</td><td>19,100 G</td><td>1,000 M</td><td>15,205325 G</td><td>-27.15</td><td>-14.15</td></tr> </tbody> </table> <p data-bbox="207 1299 383 1317">Date: 8.APR.2017 10:45:13</p>	Start [Hz]	Stop [Hz]	RBW [Hz]	Freq [Hz]	PwrAve [dBm]	ΔLimit [dB]	30,000 M	1,000 G	1,000 M	894,270000 M	-42.60	-29.60	1,000 G	3,845 G	1,000 M	1,213980 G	-43.62	-30.62	1,915 G	3,000 G	1,000 M	1,947950 G	-40.86	-27.86	3,000 G	7,000 G	1,000 M	3,132000 G	-38.40	-25.40	7,000 G	13,600 G	1,000 M	10,207500 G	-35.98	-22.98	13,600 G	19,100 G	1,000 M	15,205325 G	-27.15	-14.15	 <table border="1" data-bbox="893 1041 1404 1131"> <thead> <tr> <th>Start [Hz]</th> <th>Stop [Hz]</th> <th>RBW [Hz]</th> <th>Freq [Hz]</th> <th>PwrAve [dBm]</th> <th>ΔLimit [dB]</th> </tr> </thead> <tbody> <tr><td>30,000 M</td><td>1,000 G</td><td>1,000 M</td><td>870,990000 M</td><td>-43.41</td><td>-30.41</td></tr> <tr><td>1,000 G</td><td>3,845 G</td><td>1,000 M</td><td>1,20818 G</td><td>-42.45</td><td>-29.45</td></tr> <tr><td>1,915 G</td><td>3,000 G</td><td>1,000 M</td><td>2,916726 G</td><td>-41.23</td><td>-28.23</td></tr> <tr><td>3,000 G</td><td>7,000 G</td><td>1,000 M</td><td>3,137000 G</td><td>-38.66</td><td>-25.66</td></tr> <tr><td>7,000 G</td><td>13,600 G</td><td>1,000 M</td><td>10,209700 G</td><td>-36.00</td><td>-23.00</td></tr> <tr><td>13,600 G</td><td>19,100 G</td><td>1,000 M</td><td>15,206625 G</td><td>-27.48</td><td>-14.48</td></tr> </tbody> </table> <p data-bbox="861 1299 1037 1317">Date: 8.APR.2017 10:56:53</p>	Start [Hz]	Stop [Hz]	RBW [Hz]	Freq [Hz]	PwrAve [dBm]	ΔLimit [dB]	30,000 M	1,000 G	1,000 M	870,990000 M	-43.41	-30.41	1,000 G	3,845 G	1,000 M	1,20818 G	-42.45	-29.45	1,915 G	3,000 G	1,000 M	2,916726 G	-41.23	-28.23	3,000 G	7,000 G	1,000 M	3,137000 G	-38.66	-25.66	7,000 G	13,600 G	1,000 M	10,209700 G	-36.00	-23.00	13,600 G	19,100 G	1,000 M	15,206625 G	-27.48	-14.48
Start [Hz]	Stop [Hz]	RBW [Hz]	Freq [Hz]	PwrAve [dBm]	ΔLimit [dB]																																																																																
30,000 M	1,000 G	1,000 M	894,270000 M	-42.60	-29.60																																																																																
1,000 G	3,845 G	1,000 M	1,213980 G	-43.62	-30.62																																																																																
1,915 G	3,000 G	1,000 M	1,947950 G	-40.86	-27.86																																																																																
3,000 G	7,000 G	1,000 M	3,132000 G	-38.40	-25.40																																																																																
7,000 G	13,600 G	1,000 M	10,207500 G	-35.98	-22.98																																																																																
13,600 G	19,100 G	1,000 M	15,205325 G	-27.15	-14.15																																																																																
Start [Hz]	Stop [Hz]	RBW [Hz]	Freq [Hz]	PwrAve [dBm]	ΔLimit [dB]																																																																																
30,000 M	1,000 G	1,000 M	870,990000 M	-43.41	-30.41																																																																																
1,000 G	3,845 G	1,000 M	1,20818 G	-42.45	-29.45																																																																																
1,915 G	3,000 G	1,000 M	2,916726 G	-41.23	-28.23																																																																																
3,000 G	7,000 G	1,000 M	3,137000 G	-38.66	-25.66																																																																																
7,000 G	13,600 G	1,000 M	10,209700 G	-36.00	-23.00																																																																																
13,600 G	19,100 G	1,000 M	15,206625 G	-27.48	-14.48																																																																																
Highest Channel	Highest Channel																																																																																				
 <table border="1" data-bbox="239 1556 750 1646"> <thead> <tr> <th>Start [Hz]</th> <th>Stop [Hz]</th> <th>RBW [Hz]</th> <th>Freq [Hz]</th> <th>PwrAve [dBm]</th> <th>ΔLimit [dB]</th> </tr> </thead> <tbody> <tr><td>30,000 M</td><td>1,000 G</td><td>1,000 M</td><td>171,620000 M</td><td>-32.68</td><td>-19.68</td></tr> <tr><td>1,000 G</td><td>1,845 G</td><td>1,000 M</td><td>1,107315 G</td><td>-42.45</td><td>-29.45</td></tr> <tr><td>1,915 G</td><td>3,000 G</td><td>1,000 M</td><td>1,932071 G</td><td>-39.12</td><td>-26.12</td></tr> <tr><td>3,000 G</td><td>7,000 G</td><td>1,000 M</td><td>3,022000 G</td><td>-38.46</td><td>-25.46</td></tr> <tr><td>7,000 G</td><td>13,600 G</td><td>1,000 M</td><td>10,202190 G</td><td>-35.57</td><td>-22.57</td></tr> <tr><td>13,600 G</td><td>19,100 G</td><td>1,000 M</td><td>15,407438 G</td><td>-27.10</td><td>-14.10</td></tr> </tbody> </table> <p data-bbox="207 1814 383 1832">Date: 8.APR.2017 10:45:59</p>	Start [Hz]	Stop [Hz]	RBW [Hz]	Freq [Hz]	PwrAve [dBm]	ΔLimit [dB]	30,000 M	1,000 G	1,000 M	171,620000 M	-32.68	-19.68	1,000 G	1,845 G	1,000 M	1,107315 G	-42.45	-29.45	1,915 G	3,000 G	1,000 M	1,932071 G	-39.12	-26.12	3,000 G	7,000 G	1,000 M	3,022000 G	-38.46	-25.46	7,000 G	13,600 G	1,000 M	10,202190 G	-35.57	-22.57	13,600 G	19,100 G	1,000 M	15,407438 G	-27.10	-14.10	 <table border="1" data-bbox="893 1556 1404 1646"> <thead> <tr> <th>Start [Hz]</th> <th>Stop [Hz]</th> <th>RBW [Hz]</th> <th>Freq [Hz]</th> <th>PwrAve [dBm]</th> <th>ΔLimit [dB]</th> </tr> </thead> <tbody> <tr><td>30,000 M</td><td>1,000 G</td><td>1,000 M</td><td>871,210000 M</td><td>-42.99</td><td>-29.99</td></tr> <tr><td>1,000 G</td><td>1,845 G</td><td>1,000 M</td><td>1,284785 G</td><td>-40.93</td><td>-27.93</td></tr> <tr><td>1,915 G</td><td>3,000 G</td><td>1,000 M</td><td>1,932071 G</td><td>-39.27</td><td>-22.27</td></tr> <tr><td>3,000 G</td><td>7,000 G</td><td>1,000 M</td><td>3,210000 G</td><td>-38.78</td><td>-25.78</td></tr> <tr><td>7,000 G</td><td>13,600 G</td><td>1,000 M</td><td>10,215025 G</td><td>-35.30</td><td>-22.30</td></tr> <tr><td>13,600 G</td><td>19,100 G</td><td>1,000 M</td><td>15,207333 G</td><td>-27.30</td><td>-14.30</td></tr> </tbody> </table> <p data-bbox="861 1814 1037 1832">Date: 8.APR.2017 10:57:39</p>	Start [Hz]	Stop [Hz]	RBW [Hz]	Freq [Hz]	PwrAve [dBm]	ΔLimit [dB]	30,000 M	1,000 G	1,000 M	871,210000 M	-42.99	-29.99	1,000 G	1,845 G	1,000 M	1,284785 G	-40.93	-27.93	1,915 G	3,000 G	1,000 M	1,932071 G	-39.27	-22.27	3,000 G	7,000 G	1,000 M	3,210000 G	-38.78	-25.78	7,000 G	13,600 G	1,000 M	10,215025 G	-35.30	-22.30	13,600 G	19,100 G	1,000 M	15,207333 G	-27.30	-14.30
Start [Hz]	Stop [Hz]	RBW [Hz]	Freq [Hz]	PwrAve [dBm]	ΔLimit [dB]																																																																																
30,000 M	1,000 G	1,000 M	171,620000 M	-32.68	-19.68																																																																																
1,000 G	1,845 G	1,000 M	1,107315 G	-42.45	-29.45																																																																																
1,915 G	3,000 G	1,000 M	1,932071 G	-39.12	-26.12																																																																																
3,000 G	7,000 G	1,000 M	3,022000 G	-38.46	-25.46																																																																																
7,000 G	13,600 G	1,000 M	10,202190 G	-35.57	-22.57																																																																																
13,600 G	19,100 G	1,000 M	15,407438 G	-27.10	-14.10																																																																																
Start [Hz]	Stop [Hz]	RBW [Hz]	Freq [Hz]	PwrAve [dBm]	ΔLimit [dB]																																																																																
30,000 M	1,000 G	1,000 M	871,210000 M	-42.99	-29.99																																																																																
1,000 G	1,845 G	1,000 M	1,284785 G	-40.93	-27.93																																																																																
1,915 G	3,000 G	1,000 M	1,932071 G	-39.27	-22.27																																																																																
3,000 G	7,000 G	1,000 M	3,210000 G	-38.78	-25.78																																																																																
7,000 G	13,600 G	1,000 M	10,215025 G	-35.30	-22.30																																																																																
13,600 G	19,100 G	1,000 M	15,207333 G	-27.30	-14.30																																																																																



Frequency Stability

Test Conditions	Middle Channel	GSM850 (GPRS class 8)	GSM850 (EDGE class 8)	Limit 2.5ppm
Temperature (°C)	Voltage (Volt)	Deviation (ppm)		Result
50	Normal Voltage	0.0072	0.0024	PASS
40	Normal Voltage	0.0048	0.0048	
30	Normal Voltage	0.0024	0.0012	
20(Ref.)	Normal Voltage	0.0000	0.0000	
10	Normal Voltage	0.0072	0.0048	
0	Normal Voltage	0.0024	0.0012	
-10	Normal Voltage	0.0084	0.0036	
-20	Normal Voltage	0.0143	0.0060	
-30	Normal Voltage	0.0096	0.0024	
20	Maximum Voltage	0.0036	0.0060	
20	Normal Voltage	0.0000	0.0000	
20	Battery End Point	0.0012	0.0000	

Test Conditions	Middle Channel	GSM1900 (GPRS class 8)	GSM1900 (EDGE class 8)	Limit Note 2.
Temperature (°C)	Voltage (Volt)	Deviation (ppm)		Result
50	Normal Voltage	0.0016	0.0043	PASS
40	Normal Voltage	0.0176	0.0011	
30	Normal Voltage	0.0186	0.0027	
20(Ref.)	Normal Voltage	0.0000	0.0000	
10	Normal Voltage	0.0165	0.0048	
0	Normal Voltage	0.0191	0.0037	
-10	Normal Voltage	0.0261	0.0016	
-20	Normal Voltage	0.0271	0.0027	
-30	Normal Voltage	0.0271	0.0016	
20	Maximum Voltage	0.0191	0.0016	
20	Normal Voltage	0.0000	0.0000	
20	Battery End Point	0.0207	0.0027	

Note:

1. Normal Voltage = 3.8V. ; Battery End Point (BEP) = 3.4 V. ; Maximum Voltage =4.35 V
2. The frequency fundamental emissions stay within the authorized frequency block.



A3. WCDMA

Peak-to-Average Ratio

Mode	WCDMA Band V	WCDMA Band II	WCDMA Band IV	Limit: 13dB
Mod.	RMC 12.2Kbps	RMC 12.2Kbps	RMC 12.2Kbps	Result
Lowest CH	2.88	3.36	3.24	PASS
Middle CH	3.12	3.44	3.16	
Highest CH	3.08	3.40	3.40	

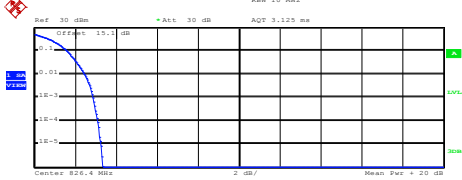
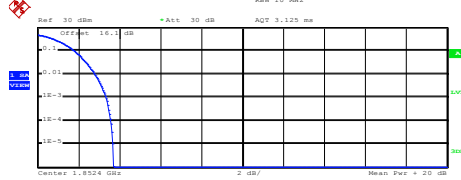
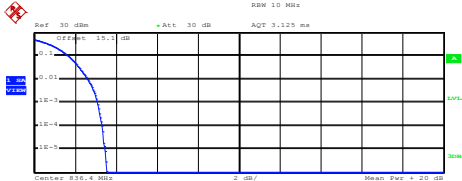
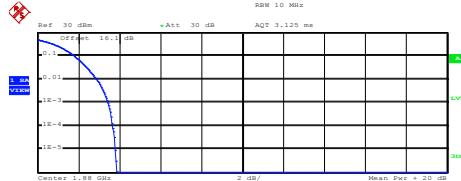
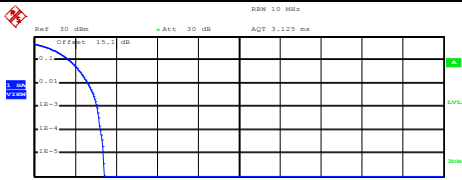
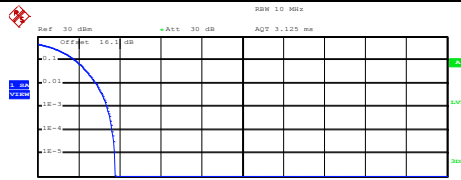

WCDMA Band V (RMC 12.2Kbps)	WCDMA Band II (RMC 12.2Kbps)																
<p style="text-align: center;">Lowest Channel</p>  <p>Center 826.4 MHz 2 dB/ Mean Pwr + 20 dB</p> <p>Complementary Cumulative Distribution Function (100000 samples) Trace 1 Mean 21.84 dBm Peak 25.17 dBm Crest 3.33 dB</p> <table border="1"> <tr><td>10 %</td><td>1.60 dB</td></tr> <tr><td>1 %</td><td>2.48 dB</td></tr> <tr><td>.1 %</td><td>2.88 dB</td></tr> <tr><td>.01 %</td><td>3.12 dB</td></tr> </table> <p>Date: 8.APR.2017 11:33:31</p>	10 %	1.60 dB	1 %	2.48 dB	.1 %	2.88 dB	.01 %	3.12 dB	<p style="text-align: center;">Lowest Channel</p>  <p>Center 1.8524 GHz 2 dB/ Mean Pwr + 20 dB</p> <p>Complementary Cumulative Distribution Function (100000 samples) Trace 1 Mean 21.41 dBm Peak 25.10 dBm Crest 3.69 dB</p> <table border="1"> <tr><td>10 %</td><td>1.80 dB</td></tr> <tr><td>1 %</td><td>2.80 dB</td></tr> <tr><td>.1 %</td><td>3.36 dB</td></tr> <tr><td>.01 %</td><td>3.60 dB</td></tr> </table> <p>Date: 8.APR.2017 11:16:54</p>	10 %	1.80 dB	1 %	2.80 dB	.1 %	3.36 dB	.01 %	3.60 dB
10 %	1.60 dB																
1 %	2.48 dB																
.1 %	2.88 dB																
.01 %	3.12 dB																
10 %	1.80 dB																
1 %	2.80 dB																
.1 %	3.36 dB																
.01 %	3.60 dB																
<p style="text-align: center;">Middle Channel</p>  <p>Center 830.4 MHz 2 dB/ Mean Pwr + 20 dB</p> <p>Complementary Cumulative Distribution Function (100000 samples) Trace 1 Mean 21.78 dBm Peak 25.31 dBm Crest 3.53 dB</p> <table border="1"> <tr><td>10 %</td><td>1.68 dB</td></tr> <tr><td>1 %</td><td>2.60 dB</td></tr> <tr><td>.1 %</td><td>3.12 dB</td></tr> <tr><td>.01 %</td><td>3.32 dB</td></tr> </table> <p>Date: 8.APR.2017 11:33:40</p>	10 %	1.68 dB	1 %	2.60 dB	.1 %	3.12 dB	.01 %	3.32 dB	<p style="text-align: center;">Middle Channel</p>  <p>Center 1.88 GHz 2 dB/ Mean Pwr + 20 dB</p> <p>Complementary Cumulative Distribution Function (100000 samples) Trace 1 Mean 21.17 dBm Peak 25.03 dBm Crest 3.86 dB</p> <table border="1"> <tr><td>10 %</td><td>1.80 dB</td></tr> <tr><td>1 %</td><td>2.88 dB</td></tr> <tr><td>.1 %</td><td>3.44 dB</td></tr> <tr><td>.01 %</td><td>3.68 dB</td></tr> </table> <p>Date: 8.APR.2017 11:17:04</p>	10 %	1.80 dB	1 %	2.88 dB	.1 %	3.44 dB	.01 %	3.68 dB
10 %	1.68 dB																
1 %	2.60 dB																
.1 %	3.12 dB																
.01 %	3.32 dB																
10 %	1.80 dB																
1 %	2.88 dB																
.1 %	3.44 dB																
.01 %	3.68 dB																
<p style="text-align: center;">Highest Channel</p>  <p>Center 846.6 MHz 2 dB/ Mean Pwr + 20 dB</p> <p>Complementary Cumulative Distribution Function (100000 samples) Trace 1 Mean 21.56 dBm Peak 24.96 dBm Crest 3.40 dB</p> <table border="1"> <tr><td>10 %</td><td>1.72 dB</td></tr> <tr><td>1 %</td><td>2.64 dB</td></tr> <tr><td>.1 %</td><td>3.08 dB</td></tr> <tr><td>.01 %</td><td>3.24 dB</td></tr> </table> <p>Date: 8.APR.2017 11:33:49</p>	10 %	1.72 dB	1 %	2.64 dB	.1 %	3.08 dB	.01 %	3.24 dB	<p style="text-align: center;">Highest Channel</p>  <p>Center 1.9076 GHz 2 dB/ Mean Pwr + 20 dB</p> <p>Complementary Cumulative Distribution Function (100000 samples) Trace 1 Mean 21.54 dBm Peak 25.31 dBm Crest 3.77 dB</p> <table border="1"> <tr><td>10 %</td><td>1.84 dB</td></tr> <tr><td>1 %</td><td>2.84 dB</td></tr> <tr><td>.1 %</td><td>3.40 dB</td></tr> <tr><td>.01 %</td><td>3.64 dB</td></tr> </table> <p>Date: 8.APR.2017 11:17:13</p>	10 %	1.84 dB	1 %	2.84 dB	.1 %	3.40 dB	.01 %	3.64 dB
10 %	1.72 dB																
1 %	2.64 dB																
.1 %	3.08 dB																
.01 %	3.24 dB																
10 %	1.84 dB																
1 %	2.84 dB																
.1 %	3.40 dB																
.01 %	3.64 dB																



WCDMA Band IV (RMC 12.2Kbps)

Lowest Channel

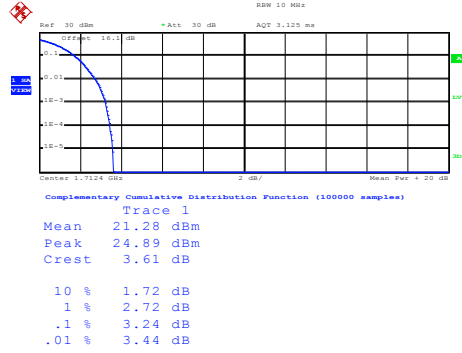

Date: 8.APR.2017 11:49:10

Middle Channel

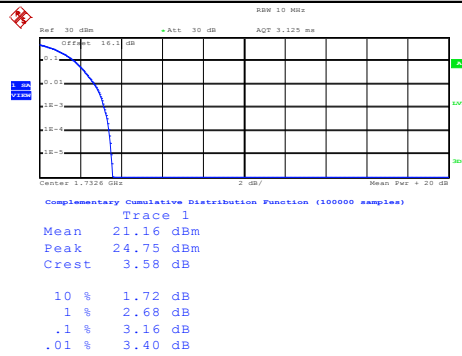

Date: 8.APR.2017 11:49:19

Highest Channel

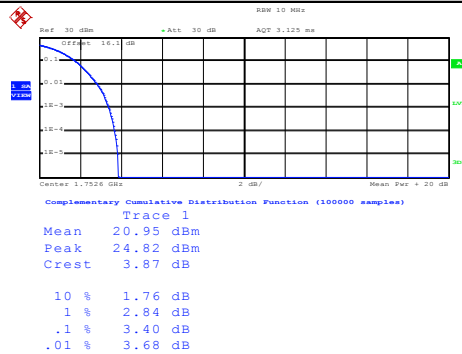

Date: 8.APR.2017 11:49:28



26dB Bandwidth

Mode	WCDMA Band V	WCDMA Band II	WCDMA Band IV
Mod.	RMC 12.2Kbps	RMC 12.2Kbps	RMC 12.2Kbps
Lowest CH	4.70	4.68	4.69
Middle CH	4.71	4.69	4.69
Highest CH	4.71	4.68	4.69

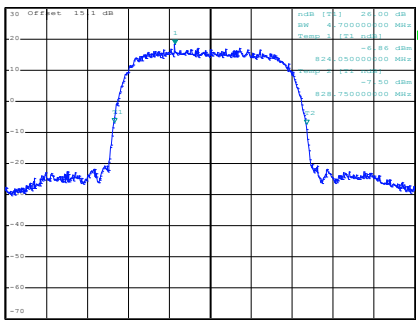
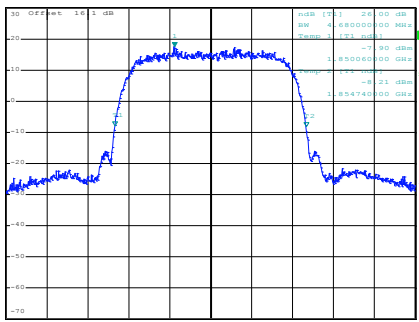
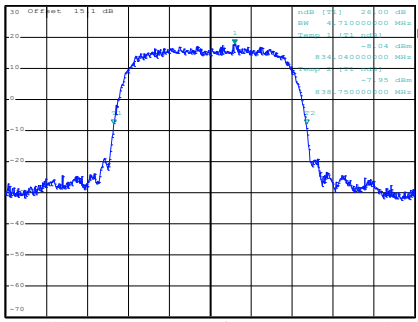
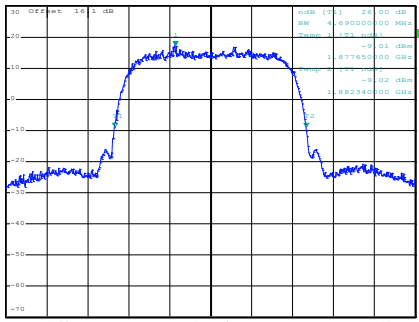
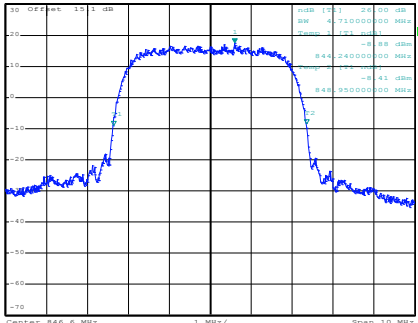
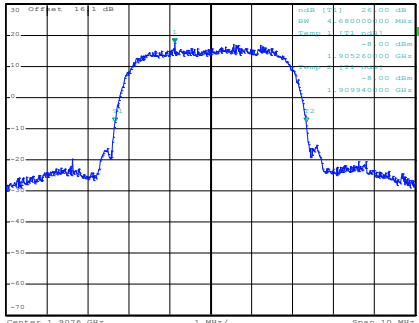

WCDMA Band V (RMC 12.2Kbps)	WCDMA Band II (RMC 12.2Kbps)
<p style="text-align: center;">Lowest Channel</p>  <p>Date: 8.APR.2017 11:22:04</p>	<p style="text-align: center;">Lowest Channel</p>  <p>Date: 8.APR.2017 11:35:42</p>
<p style="text-align: center;">Middle Channel</p>  <p>Date: 8.APR.2017 11:22:32</p>	<p style="text-align: center;">Middle Channel</p>  <p>Date: 8.APR.2017 11:36:10</p>
<p style="text-align: center;">Highest Channel</p>  <p>Date: 8.APR.2017 11:23:00</p>	<p style="text-align: center;">Highest Channel</p>  <p>Date: 8.APR.2017 11:36:38</p>



WCDMA Band IV (RMC 12.2Kbps)

Lowest Channel

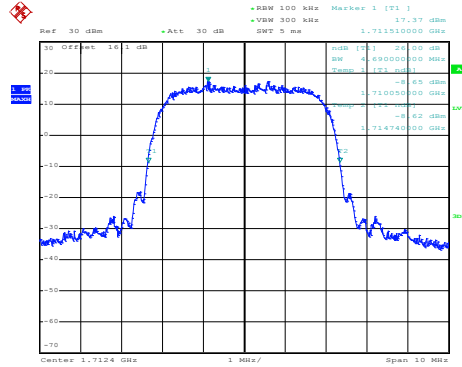

Date: 8.APR.2017 11:37:33

Middle Channel

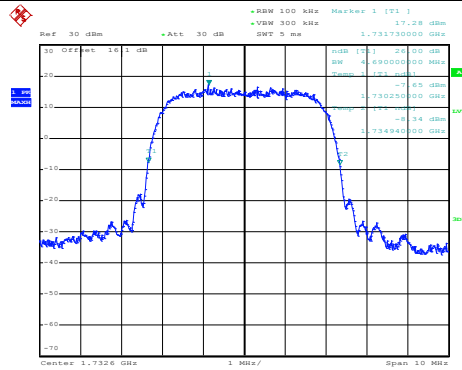

Date: 8.APR.2017 11:38:01

Highest Channel

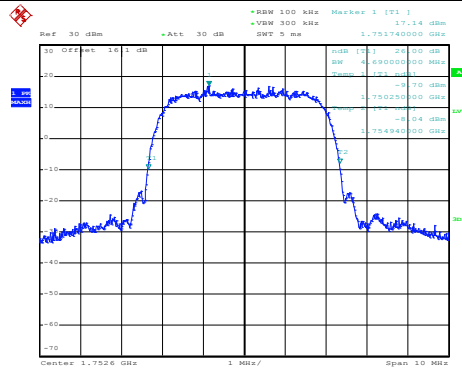

Date: 8.APR.2017 11:38:29



Occupied Bandwidth

Mode	WCDMA Band V	WCDMA Band II	WCDMA Band IV
Mod.	RMC 12.2Kbps	RMC 12.2Kbps	RMC 12.2Kbps
Lowest CH	4.12	4.13	4.12
Middle CH	4.12	4.12	4.11
Highest CH	4.12	4.11	4.11

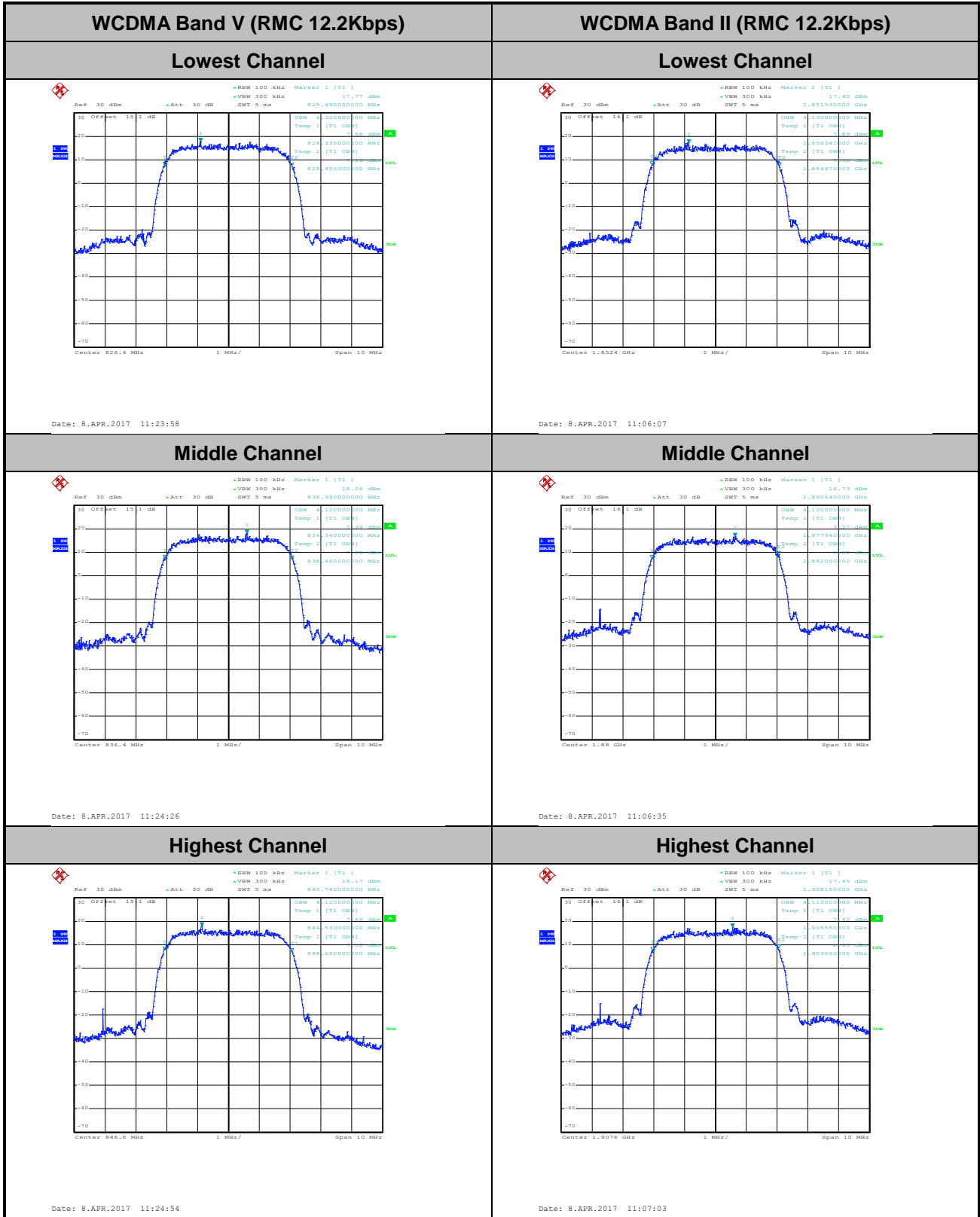



WCDMA Band IV (RMC 12.2Kbps)

Lowest Channel

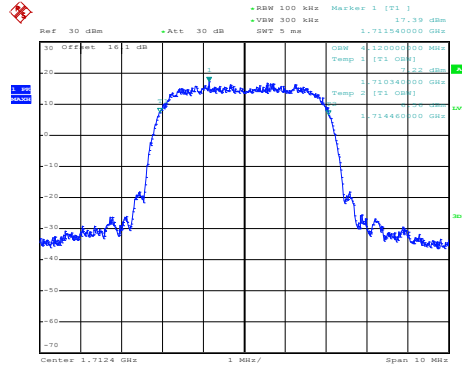

Date: 8.APR.2017 11:39:10

Middle Channel

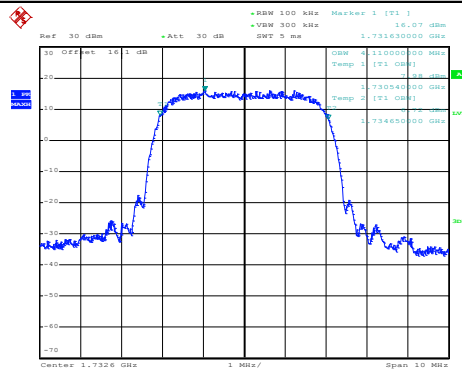

Date: 8.APR.2017 11:39:38

Highest Channel

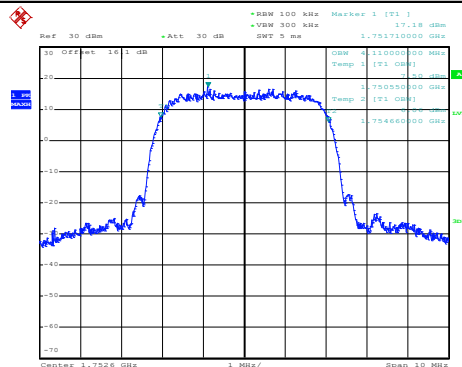

Date: 8.APR.2017 11:40:05



Conducted Band Edge

WCDMA Band V (RMC 12.2Kbps)

Lowest Band Edge

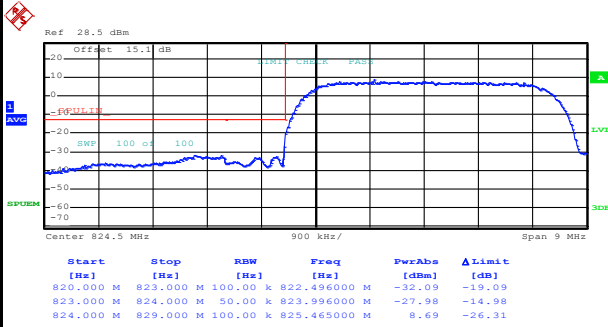

Date: 8.APR.2017 11:27:36

Highest Band Edge

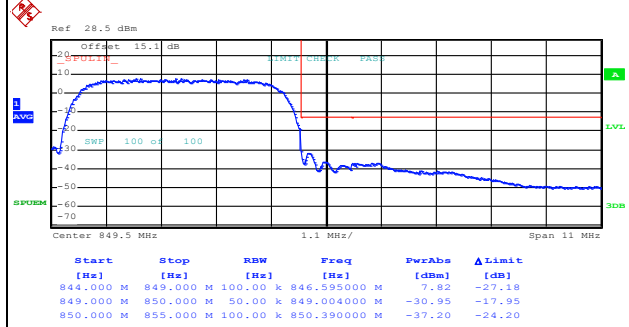

Date: 8.APR.2017 11:30:19

WCDMA Band II (RMC 12.2Kbps)

Lowest Band Edge

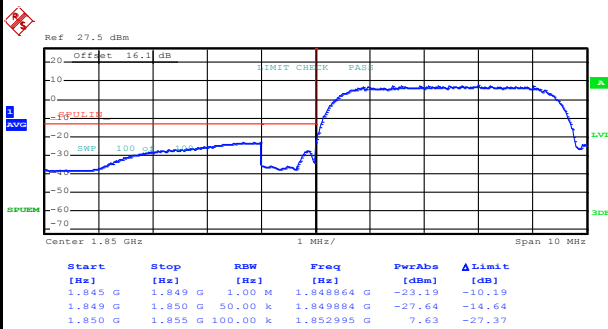

Date: 8.APR.2017 11:09:50

Highest Band Edge

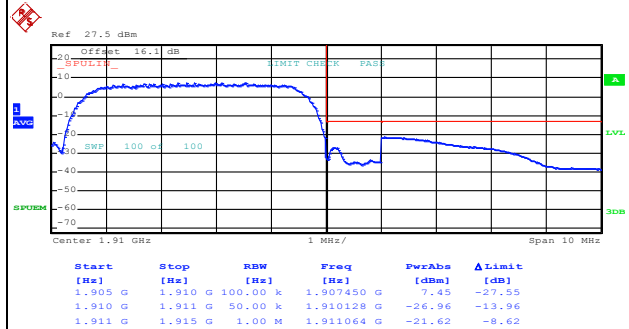

Date: 8.APR.2017 11:12:33



WCDMA Band IV (RMC 12.2Kbps)

Lowest Band Edge

Highest Band Edge

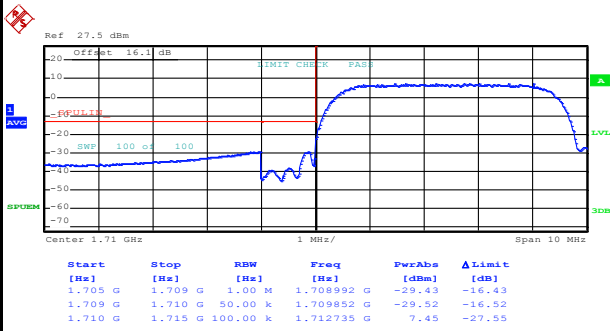

Date: 8.APR.2017 11:43:19

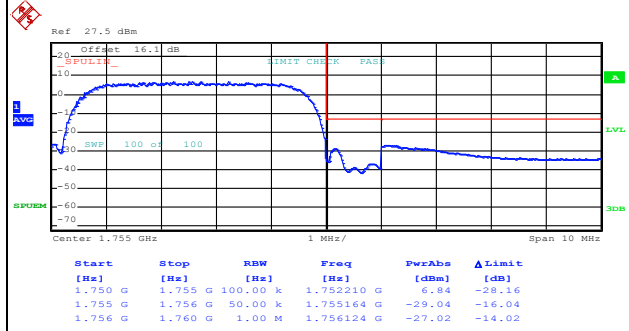

Date: 8.APR.2017 11:46:01



Conducted Spurious Emission

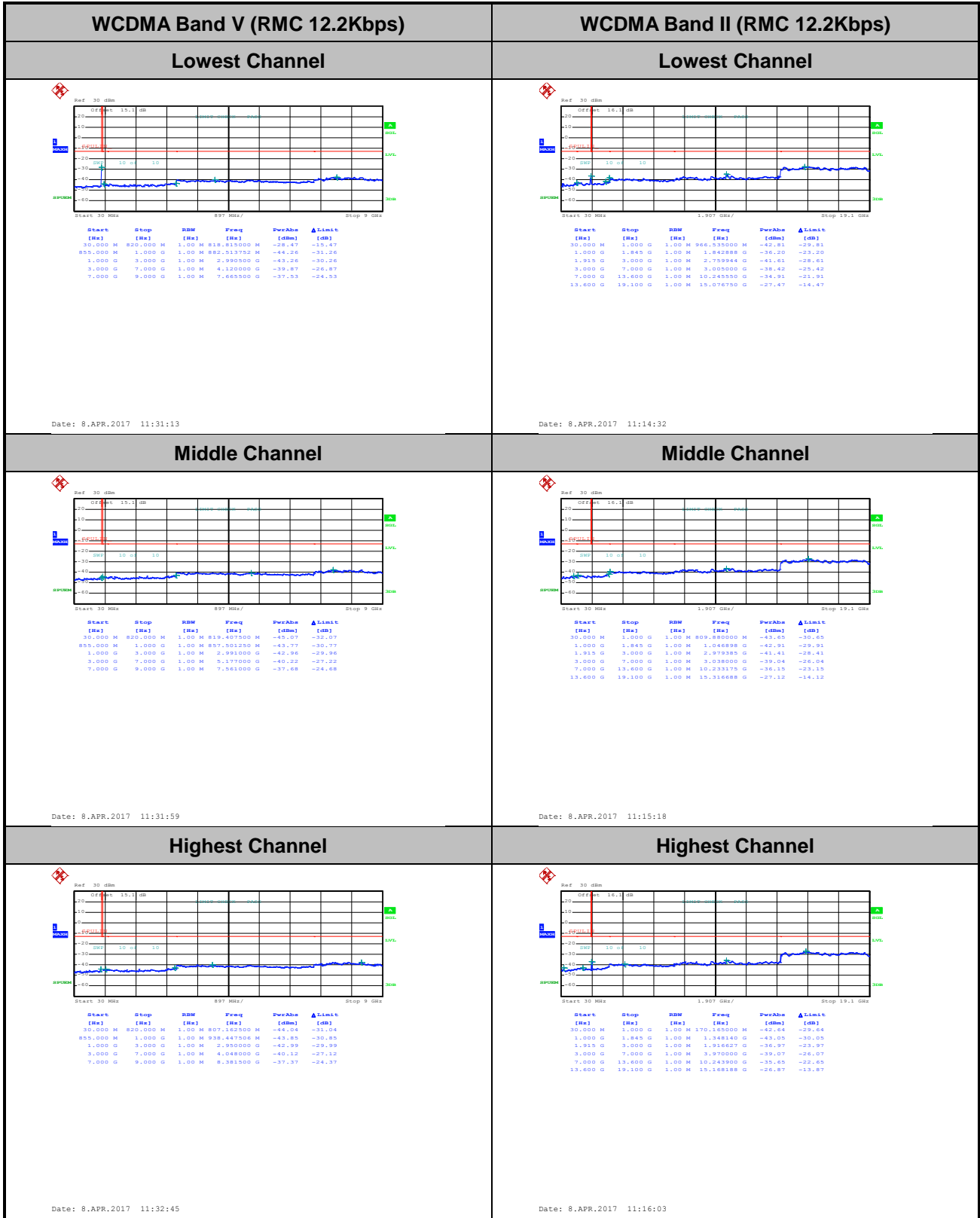



WCDMA Band IV (RMC 12.2Kbps)

Lowest Channel

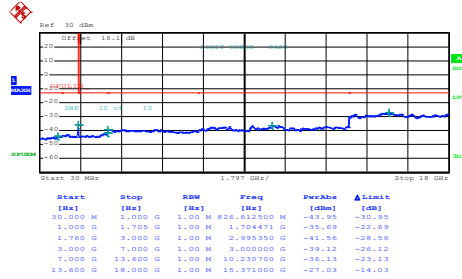

Date: 8.APR.2017 11:46:56

Middle Channel

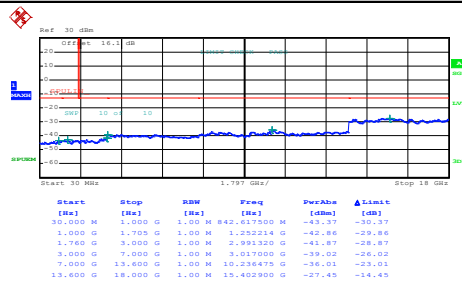

Date: 8.APR.2017 11:47:41

Highest Channel

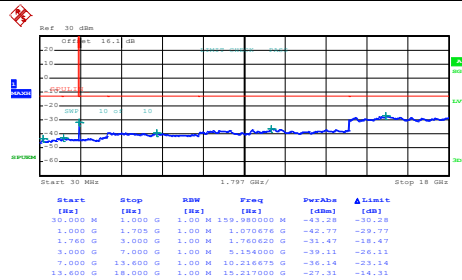

Date: 8.APR.2017 11:48:27



Frequency Stability

Test Conditions	Middle Channel	WCDMA Band V (RMC 12.2Kbps)	Limit 2.5ppm
Temperature (°C)	Voltage (Volt)	Deviation (ppm)	Result
50	Normal Voltage	0.0143	PASS
40	Normal Voltage	0.0012	
30	Normal Voltage	0.0120	
20(Ref.)	Normal Voltage	0.0000	
10	Normal Voltage	0.0167	
0	Normal Voltage	0.0060	
-10	Normal Voltage	0.0012	
-20	Normal Voltage	0.0024	
-30	Normal Voltage	0.0048	
20	Maximum Voltage	0.0024	
20	Normal Voltage	0.0000	
20	Battery End Point	0.0024	

Test Conditions	Middle Channel	WCDMA Band II (RMC 12.2Kbps)	Limit Note 2.
Temperature (°C)	Voltage (Volt)	Deviation (ppm)	Result
50	Normal Voltage	0.0011	PASS
40	Normal Voltage	0.0011	
30	Normal Voltage	0.0053	
20(Ref.)	Normal Voltage	0.0000	
10	Normal Voltage	0.0032	
0	Normal Voltage	0.0053	
-10	Normal Voltage	0.0011	
-20	Normal Voltage	0.0027	
-30	Normal Voltage	0.0043	
20	Maximum Voltage	0.0011	
20	Normal Voltage	0.0000	
20	Battery End Point	0.0027	



Test Conditions	Middle Channel	WCDMA Band IV (RMC 12.2Kbps)	Limit Note 2.
Temperature (°C)	Voltage (Volt)	Deviation (ppm)	Result
50	Normal Voltage	0.0035	PASS
40	Normal Voltage	0.0023	
30	Normal Voltage	0.0017	
20(Ref.)	Normal Voltage	0.0000	
10	Normal Voltage	0.0052	
0	Normal Voltage	0.0185	
-10	Normal Voltage	0.0052	
-20	Normal Voltage	0.0167	
-30	Normal Voltage	0.0179	
20	Maximum Voltage	0.0006	
20	Normal Voltage	0.0000	
20	Battery End Point	0.0052	

Note:

1. Normal Voltage = 3.8V. ; Battery End Point (BEP) = 3.4 V. ; Maximum Voltage =4.35 V
2. The frequency fundamental emissions stay within the authorized frequency block.



Appendix B. Test Results of ERP/EIRP and Radiated Test

ERP/EIRP

Channel	Mode	Conducted		ERP	
		Power (dBm)	Power (Watts)	ERP(dBm)	ERP(W)
Lowest	GSM850	33.02	2.0045	30.17	1.0399
Middle	GPRS class 8	33.07	2.0277	30.22	1.0520
Highest	(GT - LC = -0.7 dB)	33.44	2.2080	30.59	1.1455
Lowest	GSM850	26.24	0.4207	23.39	0.2183
Middle	EDGE class 8	26.21	0.4178	23.36	0.2168
Highest	(GT - LC = -0.7 dB)	26.09	0.4064	23.24	0.2109
Lowest	WCDMA Band V	23.41	0.2193	20.56	0.1138
Middle	AMR 12.2Kbps	23.31	0.2143	20.46	0.1112
Highest	(GT - LC = -0.7 dB)	23.12	0.2051	20.27	0.1064
Limit	ERP < 7W	Result		PASS	

Channel	Mode	Conducted		EIRP	
		Power (dBm)	Power (Watts)	EIRP(dBm)	EIRP(W)
Lowest	GSM1900	29.46	0.8831	29.76	0.9462
Middle	GPRS class 8	29.43	0.8770	29.73	0.9397
Highest	(GT - LC = 0.3 dB)	29.44	0.8790	29.74	0.9419
Lowest	GSM1900	25.11	0.3243	25.41	0.3475
Middle	EDGE class 8	25.15	0.3273	25.45	0.3508
Highest	(GT - LC = 0.3 dB)	25.17	0.3289	25.47	0.3524
Lowest	WCDMA Band II	22.67	0.1849	22.97	0.1982
Middle	AMR 12.2Kbps	22.31	0.1702	22.61	0.1824
Highest	(GT - LC = 0.3 dB)	22.70	0.1862	23.00	0.1995
Limit	EIRP < 2W	Result		PASS	

Channel	Mode	Conducted		EIRP	
		Power (dBm)	Power (Watts)	EIRP(dBm)	EIRP(W)
Lowest	WCDMA Band IV	22.51	0.1782	22.01	0.1589
Middle	AMR 12.2Kbps	22.37	0.1726	21.87	0.1538
Highest	(GT - LC = -0.5 dB)	22.43	0.1750	21.93	0.1560
Limit	EIRP < 1W	Result		PASS	



Radiated Spurious Emission

Part22H GPRS 850

GPRS 850									
Channel	Frequency (MHz)	ERP (dBm)	Limit (dBm)	Over Limit (dB)	SPA Reading (dBm)	S.G. Power (dBm)	TX Cable loss (dB)	TX Antenna Gain (dBi)	Polarization (H/V)
Lowest	1648	-39.29	-13	-26.29	-25.97	-41.05	0.98	4.89	H
	2472	-48.82	-13	-35.82	-39.33	-50.70	1.28	5.32	H
	3296	-67.46	-13	-54.46	-60.4	-70.87	1.54	7.10	H
									H
									H
									H
	1648	-39.90	-13	-26.90	-26.75	-41.66	0.98	4.89	V
	2472	-52.45	-13	-39.45	-42.98	-54.33	1.28	5.32	V
	3296	-68.04	-13	-55.04	-60.76	-71.45	1.54	7.10	V
									V
									V
									V
Middle	1672	-38.19	-13	-25.19	-25.03	-39.87	0.99	4.82	H
	2512	-49.78	-13	-36.78	-40.42	-51.75	1.29	5.41	H
	3344	-68.05	-13	-55.05	-61.1	-71.66	1.56	7.31	H
									H
									H
									H
	1672	-36.83	-13	-23.83	-23.77	-38.51	0.99	4.82	V
	2512	-49.03	-13	-36.03	-39.71	-51.00	1.29	5.41	V
	3344	-68.28	-13	-55.28	-61.08	-71.89	1.56	7.31	V
									V
									V
									V



Highest	1696	-42.12	-13	-29.12	-29.04	-43.72	1.00	4.75	H
	2544	-52.07	-13	-39.07	-42.83	-54.05	1.30	5.44	H
	3392	-66.55	-13	-53.55	-59.7	-70.35	1.57	7.52	H
									H
									H
									H
									H
	1696	-39.96	-13	-26.96	-26.95	-41.56	1.00	4.75	V
	2544	-54.46	-13	-41.46	-45.25	-56.44	1.30	5.44	V
	3392	-66.85	-13	-53.85	-59.74	-70.65	1.57	7.52	V
									V
									V
									V
									V

Remark: Spurious emissions within 30-1000MHz were found more than 20dB below limit line.



Part22H EDGE 850

EDGE 850									
Channel	Frequency (MHz)	ERP (dBm)	Limit (dBm)	Over Limit (dB)	SPA Reading (dBm)	S.G. Power (dBm)	TX Cable loss (dB)	TX Antenna Gain (dBi)	Polarization (H/V)
Lowest	1648	-50.98	-13	-37.98	-37.66	-52.74	0.98	4.89	H
	2472	-66.86	-13	-53.86	-57.37	-68.74	1.28	5.32	H
	3296	-67.91	-13	-54.91	-60.85	-71.32	1.54	7.10	H
									H
									H
									H
									H
	1648	-51.75	-13	-38.75	-38.6	-53.51	0.98	4.89	V
	2472	-64.59	-13	-51.59	-55.12	-66.47	1.28	5.32	V
	3296	-68.25	-13	-55.25	-60.97	-71.66	1.54	7.10	V
									V
									V
									V
									V
Middle	1672	-52.04	-13	-39.04	-38.88	-53.72	0.99	4.82	H
	2512	-66.29	-13	-53.29	-56.93	-68.26	1.29	5.41	H
	3344	-68.18	-13	-55.18	-61.23	-71.79	1.56	7.31	H
									H
									H
									H
									H
	1672	-48.69	-13	-35.69	-35.63	-50.37	0.99	4.82	V
	2512	-66.73	-13	-53.73	-57.41	-68.70	1.29	5.41	V
	3344	-68.14	-13	-55.14	-60.94	-71.75	1.56	7.31	V
									V
									V
									V
									V



Highest	1696	-51.82	-13	-38.82	-38.74	-53.42	1.00	4.75	H
	2544	-64.90	-13	-51.90	-55.66	-66.88	1.30	5.44	H
	3392	-68.38	-13	-55.38	-61.53	-72.18	1.57	7.52	H
									H
									H
									H
									H
	1696	-50.82	-13	-37.82	-37.81	-52.42	1.00	4.75	V
	2544	-65.22	-13	-52.22	-56.01	-67.20	1.30	5.44	V
	3392	-68.73	-13	-55.73	-61.62	-72.53	1.57	7.52	V
									V
									V
									V
									V

Remark: Spurious emissions within 30-1000MHz were found more than 20dB below limit line.



Part22H WCDMA 850

WCDMA 850									
Channel	Frequency (MHz)	ERP (dBm)	Limit (dBm)	Over Limit (dB)	SPA Reading (dBm)	S.G. Power (dBm)	TX Cable loss (dB)	TX Antenna Gain (dBi)	Polarization (H/V)
Lowest	1656	-59.09	-13	-46.09	-45.85	-60.82	0.98	4.86	H
	2480	-69.23	-13	-56.23	-59.74	-71.14	1.28	5.34	H
	3304	-68.15	-13	-55.15	-61.13	-71.59	1.54	7.14	H
									H
									H
									H
									H
	1656	-58.96	-13	-45.96	-45.86	-60.69	0.98	4.86	V
	2480	-69.37	-13	-56.37	-59.9	-71.28	1.28	5.34	V
	3304	-68.44	-13	-55.44	-61.19	-71.88	1.54	7.14	V
									V
									V
									V
									V
Middle	1672	-56.55	-13	-43.55	-43.39	-58.23	0.99	4.82	H
	2512	-68.82	-13	-55.82	-59.46	-70.79	1.29	5.41	H
	3344	-67.81	-13	-54.81	-60.86	-71.42	1.56	7.31	H
									H
									H
									H
									H
	1672	-54.13	-13	-41.13	-41.07	-55.81	0.99	4.82	V
	2512	-67.64	-13	-54.64	-58.32	-69.61	1.29	5.41	V
	3344	-68.28	-13	-55.28	-61.08	-71.89	1.56	7.31	V
									V
									V
									V
									V
								V	



Highest	1696	-60.08	-13	-47.08	-47	-61.68	1.00	4.75	H
	2536	-67.87	-13	-54.87	-58.57	-69.85	1.30	5.43	H
	3384	-68.24	-13	-55.24	-61.36	-72.01	1.57	7.49	H
									H
									H
									H
									H
	1696	-57.09	-13	-44.09	-44.08	-58.69	1.00	4.75	V
	2536	-67.86	-13	-54.86	-58.59	-69.84	1.30	5.43	V
	3384	-68.50	-13	-55.50	-61.36	-72.27	1.57	7.49	V
									V
									V
									V
									V

Remark: Spurious emissions within 30-1000MHz were found more than 20dB below limit line.



Part24E GSM 1900

GSM 1900									
Channel	Frequency (MHz)	EIRP (dBm)	Limit (dBm)	Over Limit (dB)	SPA Reading (dBm)	S.G. Power (dBm)	TX Cable loss (dB)	TX Antenna Gain (dBi)	Polarization (H/V)
Lowest	3700	-53.75	-13	-40.75	-47.41	-60.32	1.67	8.24	H
	5548	-62.52	-13	-49.52	-63.07	-69.59	2.65	9.72	H
	7403	-59.56	-13	-46.56	-65.54	-68.71	2.46	11.61	H
									H
									H
									H
									H
	3700	-53.06	-13	-40.06	-46.47	-59.63	1.67	8.24	V
	5548	-59.62	-13	-46.62	-60.13	-66.69	2.65	9.72	V
	7403	-57.38	-13	-44.38	-63.66	-66.53	2.46	11.61	V
									V
									V
									V
									V
Middle	3763	-58.89	-13	-45.89	-52.64	-65.52	1.69	8.32	H
	5639	-63.66	-13	-50.66	-64.41	-70.71	2.71	9.76	H
	7522	-58.83	-13	-45.83	-65.1	-68.22	2.42	11.81	H
	11283	-53.58	-13	-40.58	-68.56	-63.28	2.68	12.39	H
									H
									H
									H
	3763	-58.60	-13	-45.60	-52.13	-65.23	1.69	8.32	V
	5639	-60.35	-13	-47.35	-61.04	-67.40	2.71	9.76	V
	7522	-55.86	-13	-42.86	-62.41	-65.25	2.42	11.81	V
	11283	-53.81	-13	-40.81	-68.58	-63.51	2.68	12.39	V
									V
									V
									V
								V	



Highest	3819	-58.37	-13	-45.37	-52.19	-65.05	1.70	8.38	H
	5730	-62.33	-13	-49.33	-63.28	-69.36	2.76	9.79	H
	7641	-58.72	-13	-45.72	-65.24	-68.22	2.38	11.88	H
									H
									H
									H
									H
	3819	-59.03	-13	-46.03	-52.65	-65.71	1.70	8.38	V
	5730	-57.89	-13	-44.89	-58.77	-64.92	2.76	9.79	V
	7641	-56.02	-13	-43.02	-62.77	-65.52	2.38	11.88	V
	11464	-52.20	-13	-39.20	-67.28	-61.83	2.68	12.31	V
									V
									V
									V

Remark: Spurious emissions within 30-1000MHz were found more than 20dB below limit line.



Part24E EDGE 1900

EDGE 1900									
Channel	Frequency (MHz)	EIRP (dBm)	Limit (dBm)	Over Limit (dB)	SPA Reading (dBm)	S.G. Power (dBm)	TX Cable loss (dB)	TX Antenna Gain (dBi)	Polarization (H/V)
Lowest	3700	-63.22	-13	-50.22	-57.68	-69.79	1.67	8.24	H
	5548	-63.44	-13	-50.44	-64.46	-70.51	2.65	9.72	H
	7403	-59.55	-13	-46.55	-65.82	-68.70	2.46	11.61	H
									H
									H
									H
									H
	3700	-64.12	-13	-51.12	-58.33	-70.69	1.67	8.24	V
	5548	-63.36	-13	-50.36	-64.34	-70.43	2.65	9.72	V
	7403	-59.56	-13	-46.56	-66.13	-68.71	2.46	11.61	V
									V
									V
									V
									V
Middle	3756	-64.17	-13	-51.17	-57.89	-70.79	1.68	8.31	H
	5639	-64.12	-13	-51.12	-64.87	-71.17	2.71	9.76	H
	7522	-58.12	-13	-45.12	-64.39	-67.51	2.42	11.81	H
									H
									H
									H
									H
	3756	-63.59	-13	-50.59	-57.09	-70.21	1.68	8.31	V
	5639	-64.38	-13	-51.38	-65.07	-71.43	2.71	9.76	V
	7522	-58.48	-13	-45.48	-65.03	-67.87	2.42	11.81	V
									V
									V
									V
									V
								V	



Highest	3819	-65.05	-13	-52.05	-66.05	-71.73	1.70	8.38	H
	5730	-62.71	-13	-49.71	-63.71	-69.74	2.76	9.79	H
	7641	-58.37	-13	-45.37	-59.37	-67.87	2.38	11.88	H
									H
									H
									H
									H
	3819	-64.09	-13	-51.09	-58.44	-70.77	1.70	8.38	V
	5730	-62.76	-13	-49.76	-64.06	-69.79	2.76	9.79	V
	7641	-58.07	-13	-45.07	-65.29	-67.57	2.38	11.88	V
									V
									V
									V
									V

Remark: Spurious emissions within 30-1000MHz were found more than 20dB below limit line.



Part24E WCDMA 1900

WCDMA 1900									
Channel	Frequency (MHz)	EIRP (dBm)	Limit (dBm)	Over Limit (dB)	SPA Reading (dBm)	S.G. Power (dBm)	TX Cable loss (dB)	TX Antenna Gain (dBi)	Polarization (H/V)
Lowest	3705	-67.21	-13	-54.21	-60.87	-73.79	1.67	8.25	H
	5557	-63.55	-13	-50.55	-64.1	-70.61	2.66	9.72	H
	11112	-53.40	-13	-40.40	-68.23	-63.17	2.69	12.46	H
									H
									H
									H
									H
	3705	-67.75	-13	-54.75	-61.16	-74.33	1.67	8.25	V
	5557	-63.37	-13	-50.37	-63.88	-70.43	2.66	9.72	V
	11112	-51.91	-13	-38.91	-66.39	-61.68	2.69	12.46	V
									V
									V
									V
									V
Middle	3760	-67.38	-13	-54.38	-61.1	-74.01	1.69	8.31	H
	5640	-64.15	-13	-51.15	-64.9	-71.20	2.71	9.76	H
	11280	-49.94	-13	-36.94	-64.92	-59.64	2.68	12.39	H
									H
									H
									H
									H
	3760	-67.60	-13	-54.60	-61.1	-74.23	1.69	8.31	V
	5640	-63.95	-13	-50.95	-64.64	-71.00	2.71	9.76	V
	11280	-48.22	-13	-35.22	-62.99	-57.92	2.68	12.39	V
									V
									V
									V
									V



Highest	3815	-67.75	-13	-54.75	-61.57	-74.42	1.70	8.38	H
	5723	-62.99	-13	-49.99	-63.94	-70.03	2.75	9.79	H
	11445	-52.16	-13	-39.16	-67.27	-61.80	2.68	12.32	H
									H
									H
									H
									H
	3815	-67.82	-13	-54.82	-61.44	-74.49	1.70	8.38	V
	5723	-63.14	-13	-50.14	-64.02	-70.18	2.75	9.79	V
	11445	-50.06	-13	-37.06	-65.09	-59.70	2.68	12.32	V
									V
									V
									V
									V

Remark: Spurious emissions within 30-1000MHz were found more than 20dB below limit line.



Part27L WCDMA 1700

WCDMA 1700									
Channel	Frequency (MHz)	EIRP (dBm)	Limit (dBm)	Over Limit (dB)	SPA Reading (dBm)	S.G. Power (dBm)	TX Cable loss (dB)	TX Antenna Gain (dBi)	Polarization (H/V)
Lowest	3424	-68.26	-13	-55.26	-61.48	-74.35	1.58	7.67	H
	5136	-64.86	-13	-51.86	-64.3	-72.14	2.42	9.70	H
	11986	-54.40	-13	-41.40	-70.29	-64.02	2.68	12.30	H
									H
									H
									H
									H
	3424	-68.27	-13	-55.27	-61.21	-74.36	1.58	7.67	V
	5136	-64.91	-13	-51.91	-64.17	-72.19	2.42	9.70	V
	11986	-52.88	-13	-39.88	-68.39	-62.50	2.68	12.30	V
									V
									V
									V
									V
Middle	3465	-67.65	-13	-54.65	-60.97	-73.90	1.59	7.85	H
	5198	-64.45	-13	-51.45	-64.07	-71.70	2.45	9.70	H
	12128	-54.08	-13	-41.08	-69.91	-63.70	2.71	12.33	H
									H
									H
									H
									H
	3465	-68.23	-13	-55.23	-61.23	-74.48	1.59	7.85	V
	5198	-64.64	-13	-51.64	-64.11	-71.89	2.45	9.70	V
	12128	-53.64	-13	-40.64	-69.03	-63.26	2.71	12.33	V
									V
									V
									V
									V



Highest	3505	-67.04	-13	-54.04	-60.4	-73.44	1.61	8.01	H
	5258	-64.61	-13	-51.61	-64.36	-71.82	2.49	9.70	H
	12268	-54.70	-13	-41.70	-70.44	-64.31	2.75	12.35	H
									H
									H
									H
									H
	3505	-67.25	-13	-54.25	-60.3	-73.65	1.61	8.01	V
	5258	-64.52	-13	-51.52	-64.15	-71.73	2.49	9.70	V
	12268	-55.15	-13	-42.15	-70.41	-64.76	2.75	12.35	V
									V
									V
									V
									V
								V	

Remark: Spurious emissions within 30-1000MHz were found more than 20dB below limit line.