



# FCC RF Test Report

**APPLICANT** : Motorola Mobility, LLC  
**EQUIPMENT** : Mobile Cellular Phone  
**BRAND NAME** : Motorola  
**MODEL NAME** : 9653  
**FCC ID** : IHDT56WA1  
**STANDARD** : 47 CFR Part 2, 22(H), 24(E), 27  
**CLASSIFICATION** : PCS Licensed Transmitter Held to Ear (PCE)

The product was received on Feb. 03, 2017 and completely tested on Feb. 22, 2017. We, SPORTON INTERNATIONAL INC., would like to declare that the tested sample has been evaluated in accordance with the test procedures given in ANSI / TIA / EIA-603-D-2010 and the testing has shown the tested sample to be in compliance with the applicable technical standards.

The test results in this report apply exclusively to the tested model / sample. Without written approval of SPORTON INTERNATIONAL INC., the test report shall not be reproduced except in full.

---

Reviewed by: Joseph Lin / Supervisor

---

Approved by: Jones Tsai / Manager



## **SPORTON INTERNATIONAL INC.**

**No. 52, Hwa Ya 1<sup>st</sup> Rd., Hwa Ya Technology Park, Kwei-Shan District, Tao Yuan City, Taiwan, R.O.C.**

---

SPORTON INTERNATIONAL INC.

TEL : 886-3-327-3456

FAX : 886-3-328-4978

FCC ID : IHDT56WA1

Page Number : 1 of 36

Report Issued Date : Mar. 20, 2017

Report Version : Rev. 01

Report Template No.: BU5-FGLTE Version 1.6



TABLE OF CONTENTS

REVISION HISTORY..... 3
SUMMARY OF TEST RESULT ..... 4
1 GENERAL DESCRIPTION ..... 6
1.1 Applicant ..... 6
1.2 Manufacturer ..... 6
1.3 Product Feature of Equipment Under Test..... 6
1.4 Product Specification of Equipment Under Test..... 7
1.5 Modification of EUT ..... 8
1.6 Emission Designator ..... 9
1.7 Testing Location ..... 12
1.8 Applicable Standards..... 12
2 TEST CONFIGURATION OF EQUIPMENT UNDER TEST ..... 13
2.1 Test Mode ..... 13
2.2 Connection Diagram of Test System ..... 17
2.3 Support Unit used in test configuration and system ..... 17
2.4 Measurement Results Explanation Example ..... 17
2.5 Frequency List of Low/Middle/High Channels ..... 18
3 CONDUCTED TEST ITEMS ..... 23
3.1 Measuring Instruments ..... 23
3.2 Test Setup ..... 23
3.3 Test Result of Conducted Test ..... 23
3.4 Conducted Output Power ..... 24
3.5 Peak-to-Average Ratio ..... 25
3.6 Occupied Bandwidth ..... 26
3.7 Conducted Band Edge ..... 27
3.8 Conducted Spurious Emission ..... 29
3.9 Frequency Stability ..... 30
4 RADIATED TEST ITEMS ..... 31
4.1 Measuring Instruments ..... 31
4.2 Test Setup ..... 31
4.3 Test Result of Radiated Test ..... 31
4.4 Effective Radiated Power and Effective Isotropic Radiated Power ..... 32
4.5 Radiated Spurious Emission ..... 34
5 LIST OF MEASURING EQUIPMENT ..... 35
6 UNCERTAINTY OF EVALUATION ..... 36
APPENDIX A. TEST RESULTS OF CONDUCTED TEST
APPENDIX B. TEST RESULTS OF ERP/EIRP AND RADIATED TEST



### REVISION HISTORY

REPORT NO.	VERSION	DESCRIPTION	ISSUED DATE
FG720310B	Rev. 01	Initial issue of report	Mar. 20, 2017



**SUMMARY OF TEST RESULT**

Report Section	FCC Rule	Description	Limit	Result	Remark
3.4	§2.1046	Conducted Output Power	Reporting Only	PASS	-
3.5	§24.232(d)	Peak-to-Average Ratio	<13 dB	PASS	-
3.6	§2.1049	Occupied Bandwidth	Reporting Only	PASS	-
3.7	§2.1051 §22.917(a) §24.238(a) §27.53(c)(2)(4) §27.53(g) §27.53(h)	Conducted Band Edge Measurement (Band 2) (Band 4) (Band 5) (Band 12) (Band 13) (Band 17) (Band 25) (Band 26) (Band 66)	< 43+10log <sub>10</sub> (P[Watts])	PASS	-
	§27.53(m)(4)	Conducted Band Edge Measurement (Band 7) (Band 38) (Band 41)	§27.53(m)(4)		
3.8	§2.1051 §22.917(a) §24.238(a) §27.53(c)(2) §27.53(g) §27.53(h)	Conducted Spurious Emission (Band 2) (Band 4) (Band 5) (Band 12) (Band 13) (Band 17) (Band 25) (Band 26) (Band 66)	< 43+10log <sub>10</sub> (P[Watts])	PASS	-
	§2.1051 §27.53(m)(4)	Conducted Spurious Emission (Band 7) (Band 38) (Band 41)	< 55+10log <sub>10</sub> (P[Watts])		
3.9	§2.1055 §22.355	Frequency Stability Temperature & Voltage	< 2.5 ppm for Part 22	PASS	-
	§2.1055 §24.235 §27.54		Within Authorized Band		



Report Section	FCC Rule	Description	Limit	Result	Remark
4.4	§22.913(a)(2)	Effective Radiated Power (Band 5) (Band 26)	ERP < 7 Watt	PASS	-
	§27.50(b)(10) §27.50(c)(10)	Effective Radiated Power (Band 12) (Band 13) (Band 17)	ERP < 3 Watt		
	§24.232(c) §27.50(h)(2)	Equivalent Isotropic Radiated Power (Band 2)(Band 25) (Band 7) (Band 38) (Band 41)	EIRP < 2Watt		
	§27.50(d)(4)	Equivalent Isotropic Radiated Power (Band 4) (Band 66)	EIRP < 1Watt		
4.5	§2.1053 §22.917(a) §24.238(a) §27.53(c)(2) §27.53(f) §27.53(g) §27.53(h)	Radiated Spurious Emission (Band 2) (Band 4) (Band 5) (Band 12) (Band 13) (Band 17) (Band 25) (Band 26) (Band 66)	< 43+10log <sub>10</sub> (P[Watts])	PASS	Under limit 0.34 dB at 5364.000 MHz
	§2.1053 §27.53(m)(4)	Radiated Spurious Emission (Band 7) (Band 38) (Band 41)	< 55+10log <sub>10</sub> (P[Watts])		



# 1 General Description

## 1.1 Applicant

**Motorola Mobility, LLC**

222 W Merchandise Mart Plaza, Suite 1800, Chicago, IL 60654, United States

## 1.2 Manufacturer

**Motorola Mobility, LLC**

222 W Merchandise Mart Plaza, Suite 1800, Chicago, IL 60654, United States

## 1.3 Product Feature of Equipment Under Test

Product Feature	
Equipment	Mobile Cellular Phone
Brand Name	Motorola
Model Name	9653
FCC ID	IHDT56WA1
IMEI Code	351884080020946 (for Radiation) 351884080020839 (for Conducted)
EUT supports Radios application	CDMA/EV-DO/GSM/EGPRS/WCDMA/HSPA/LTE/NFC/FM WLAN 11b/g/n HT20 WLAN 11a/n HT20/HT40 Bluetooth BR/EDR/LE
HW Version	DVT2
EUT Stage	Identical Prototype

Accessory List	
AC Adapter 1	Brand Name : Motorola
	Model Name : SPN5970A
AC Adapter 2	Brand Name : Motorola
	Model Name : SPN5993A
AC Adapter 3	Brand Name : Motorola
	Model Name : SPN5978A
Battery 1	Brand Name : Motorola
	Model Name : SNN5983A
Battery 2	Brand Name : Motorola
	Model Name : SNN5985A
Earphone	Brand Name : Motorola
	Model Name : SH38C16618
USB Cable	Brand Name : Motorola
	Model Name : SKN6473A



### 1.4 Product Specification of Equipment Under Test

Standards-related Product Specification	
<b>Tx Frequency</b>	LTE Band 2 : 1850.7 MHz ~ 1909.3 MHz LTE Band 4 : 1710.7 MHz ~ 1754.3 MHz LTE Band 5 : 824.7 MHz ~ 848.3 MHz LTE Band 7 : 2502.5 MHz ~ 2567.5 MHz LTE Band 12 : 699.7 MHz ~ 715.3 MHz LTE Band 13 : 779.5 MHz ~ 784.5 MHz LTE Band 17 : 706.5 MHz ~ 713.5 MHz LTE Band 25 : 1850.7MHz ~ 1914.3 MHz LTE Band 26 : 824.7MHz ~ 848.3 MHz LTE Band 38 : 2572.5MHz ~ 2617.5MHz LTE Band 41 : 2498.5 MHz ~ 2687.5 MHz LTE Band 66 : 1710.7 MHz ~ 1754.3 MHz
<b>Rx Frequency</b>	LTE Band 2 : 1930.7 MHz ~ 1989.3 MHz LTE Band 4 : 2110.7 MHz ~ 2154.3 MHz LTE Band 5 : 869.7 MHz ~ 893.3 MHz LTE Band 7 : 2622.5MHz ~ 2687.5 MHz LTE Band 12 : 729.7 MHz ~ 745.3 MHz LTE Band 13 : 748.5 MHz ~ 753.5 MHz LTE Band 17 : 736.5 MHz ~ 743.5 MHz LTE Band 25 : 1930.7MHz ~ 1994.3 MHz LTE Band 26 : 869.7MHz ~ 893.3MHz LTE Band 38 : 2572.5MHz ~ 2617.5MHz LTE Band 41 : 2498.5 MHz ~ 2687.5 MHz LTE Band 66 : 2110.7 MHz ~ 2154.3 MHz
<b>Bandwidth</b>	LTE Band 2 : 1.4MHz / 3MHz / 5MHz / 10MHz / 15MHz / 20MHz LTE Band 4 : 1.4MHz / 3MHz / 5MHz / 10MHz / 15MHz / 20MHz LTE Band 5 : 1.4MHz / 3MHz / 5MHz / 10MHz LTE Band 7 : 5MHz / 10MHz / 15MHz / 20MHz LTE Band 12 : 1.4MHz / 3MHz / 5MHz / 10MHz LTE Band 13 : 5MHz / 10MHz LTE Band 17 : 5MHz / 10MHz LTE Band 25 : 1.4MHz / 3MHz / 5MHz / 10MHz / 15MHz / 20MHz LTE Band 26 : 1.4MHz / 3MHz / 5MHz / 10MHz / 15MHz LTE Band 38 : 5MHz / 10MHz / 15MHz / 20MHz LTE Band 41 : 5MHz / 10MHz / 15MHz / 20MHz LTE Band 66 : 1.4MHz / 3MHz / 5MHz / 10MHz / 15MHz / 20MHz



Standards-related Product Specification	
<b>Maximum Output Power to Antenna</b>	LTE Band 2 : 22.55 dBm
	LTE Band 4 : 22.66 dBm
	LTE Band 5 : 22.85 dBm
	LTE Band 7 : 22.70 dBm
	LTE Band 13 : 23.00 dBm
	LTE Band 12 : 22.68 dBm
	LTE Band 17 : 22.77 dBm
	LTE Band 25 : 22.80 dBm
	LTE Band 26 : 23.19 dBm
	LTE Band 38 : 22.75 dBm
	LTE Band 41 : 22.79 dBm
LTE Band 66 : 23.48 dBm	
<b>Type of Modulation</b>	QPSK / 16QAM

### 1.5 Modification of EUT

No modifications are made to the EUT during all test items.



### 1.6 Emission Designator

LTE Band 2		QPSK			16QAM		
BW (MHz)	Frequency Range (MHz)	Emission Designator (99%OBW)	Frequency Tolerance (ppm)	Maximum EIRP(W)	Emission Designator (99%OBW)	Frequency Tolerance (ppm)	Maximum EIRP(W)
1.4	1850.7 ~ 1909.3	1M09G7D	-	0.2223	1M10W7D	-	0.1489
3	1851.5 ~ 1908.5	2M72G7D	-	0.2218	2M72W7D	-	0.1486
5	1852.5 ~ 1907.5	4M52G7D	-	0.2223	4M51W7D	-	0.1496
10	1855.0 ~ 1905.0	9M05G7D	0.0063	0.2667	9M05W7D	-	0.1416
15	1857.5 ~ 1902.5	13M5G7D	-	0.2339	13M5W7D	-	0.1327
20	1860.0 ~ 1900.0	18M5G7D	-	0.1982	18M5W7D	-	0.1236
LTE Band 25		QPSK			16QAM		
BW (MHz)	Frequency Range (MHz)	Emission Designator (99%OBW)	Frequency Tolerance (ppm)	Maximum EIRP(W)	Emission Designator (99%OBW)	Frequency Tolerance (ppm)	Maximum EIRP(W)
1.4	1850.7 ~ 1914.3	1M09G7D	-	0.2113	1M10W7D	-	0.1500
3	1851.5 ~ 1913.5	2M71G7D	-	0.2410	2M71W7D	-	0.1592
5	1852.5 ~ 1912.5	4M50G7D	-	0.2564	4M48W7D	-	0.1585
10	1855.0 ~ 1910.0	9M01G7D	0.0075	0.2366	8M97W7D	-	0.1542
15	1857.5 ~ 1907.5	13M4G7D	-	0.2366	13M5W7D	-	0.1422
20	1860.0 ~ 1905.0	18M6G7D	-	0.2754	18M5W7D	-	0.1334
LTE Band 4		QPSK			16QAM		
BW (MHz)	Frequency Range (MHz)	Emission Designator (99%OBW)	Frequency Tolerance (ppm)	Maximum EIRP(W)	Emission Designator (99%OBW)	Frequency Tolerance (ppm)	Maximum EIRP(W)
1.4	1710.7 ~ 1754.3	1M10G7D	-	0.2333	1M09W7D	-	0.1368
3	1711.5 ~ 1753.5	2M71G7D	-	0.2259	2M72W7D	-	0.1384
5	1712.5 ~ 1752.5	4M49G7D	-	0.2410	4M50W7D	-	0.1403
10	1715.0 ~ 1750.0	9M07G7D	0.0059	0.2661	9M07W7D	-	0.1648
15	1717.5 ~ 1747.5	13M5G7D	-	0.2259	13M5W7D	-	0.1476
20	1720.0 ~ 1745.0	18M3G7D	-	0.2606	18M5W7D	-	0.1507
LTE Band 5		QPSK			16QAM		
BW (MHz)	Frequency Range (MHz)	Emission Designator (99%OBW)	Frequency Tolerance (ppm)	Maximum ERP(W)	Emission Designator (99%OBW)	Frequency Tolerance (ppm)	Maximum ERP(W)
1.4	824.7 ~ 848.3	1M10G7D	-	0.1007	1M10W7D	-	0.0565
3	825.5 ~ 847.5	2M72G7D	-	0.0975	2M73W7D	-	0.0557
5	826.5 ~ 846.5	4M50G7D	-	0.0998	4M50W7D	-	0.0569
10	829.0 ~ 844.0	9M07G7D	0.0078	0.1086	9M01W7D	-	0.0628



LTE Band 7		QPSK			16QAM		
BW (MHz)	Frequency Range (MHz)	Emission Designator (99%OBW)	Frequency Tolerance (ppm)	Maximum EIRP(W)	Emission Designator (99%OBW)	Frequency Tolerance (ppm)	Maximum EIRP(W)
5	2502.5 ~ 2567.5	4M51G7D	-	0.1901	4M50W7D	-	0.1545
10	2505.0 ~ 2565.0	9M07G7D	0.0053	0.1914	9M03W7D	-	0.1535
15	2507.5 ~ 2562.5	13M5G7D	-	0.1841	13M5W7D	-	0.1542
20	2510.0 ~ 2560.0	18M5G7D	-	0.1750	18M5W7D	-	0.1589
LTE Band 12		QPSK			16QAM		
BW (MHz)	Frequency Range (MHz)	Emission Designator (99%OBW)	Frequency Tolerance (ppm)	Maximum ERP(W)	Emission Designator (99%OBW)	Frequency Tolerance (ppm)	Maximum ERP(W)
1.4	699.7 ~ 715.3	1M09G7D	-	0.0802	1M10W7D	-	0.0466
3	700.5 ~ 714.5	2M76G7D	-	0.0748	2M73W7D	-	0.0482
5	701.5 ~ 713.5	4M51G7D	-	0.0809	4M49W7D	-	0.0447
10	704.0 ~ 711.0	9M09G7D	0.0079	0.0721	9M07W7D	-	0.0441
LTE Band 13		QPSK			16QAM		
BW (MHz)	Frequency Range (MHz)	Emission Designator (99%OBW)	Frequency Tolerance (ppm)	Maximum ERP(W)	Emission Designator (99%OBW)	Frequency Tolerance (ppm)	Maximum ERP(W)
5	779.5 ~ 784.5	4M50G7D	-	0.1138	4M50W7D	-	0.0656
10	782.0	9M07G7D	0.0098	0.1178	8M93W7D	-	0.0618
LTE Band 17		QPSK			16QAM		
BW (MHz)	Frequency Range (MHz)	Emission Designator (99%OBW)	Frequency Tolerance (ppm)	Maximum ERP(W)	Emission Designator (99%OBW)	Frequency Tolerance (ppm)	Maximum ERP(W)
5	706.5 ~ 713.5	4M50G7D	-	0.0748	4M49W7D	-	0.0455
10	709.0 ~ 711.0	9M01G7D	0.0101	0.0782	8M97W7D	-	0.0480
LTE Band 26		QPSK			16QAM		
BW (MHz)	Frequency Range (MHz)	Emission Designator (99%OBW)	Frequency Tolerance (ppm)	Maximum EIRP(W)	Emission Designator (99%OBW)	Frequency Tolerance (ppm)	Maximum EIRP(W)
1.4	824.7 ~ 848.3	1M10G7D	-	0.0845	1M10W7D	-	0.0553
3	825.5 ~ 847.5	2M73G7D	-	0.0855	2M74W7D	-	0.0547
5	826.5 ~ 846.5	4M49G7D	-	0.0865	4M50W7D	-	0.0555
10	829.0 ~ 844.0	9M03G7D	0.0071	0.0912	9M03W7D	-	0.0611
15	831.5 ~ 841.5	13M5G7D	-	0.0946	13M5W7D	-	0.0586



LTE Band 38		QPSK			16QAM		
BW (MHz)	Frequency Range (MHz)	Emission Designator (99%OBW)	Frequency Tolerance (ppm)	Maximum EIRP(W)	Emission Designator (99%OBW)	Frequency Tolerance (ppm)	Maximum EIRP(W)
5	2572.5 ~ 2617.5	4M51G7D	-	0.1660	4M51W7D	-	0.1400
10	2575.0 ~ 2615.0	9M07G7D	0.0022	0.1702	9M05W7D	-	0.1358
15	2577.5 ~ 2612.5	13M5G7D	-	0.1694	13M5W7D	-	0.1476
20	2580.0 ~ 2610.0	18M4G7D	-	0.1656	18M5W7D	-	0.1268
LTE Band 41		QPSK			16QAM		
BW (MHz)	Frequency Range (MHz)	Emission Designator (99%OBW)	Frequency Tolerance (ppm)	Maximum EIRP(W)	Emission Designator (99%OBW)	Frequency Tolerance (ppm)	Maximum EIRP(W)
5	2498.5 ~ 2687.5	4M52G7D	-	0.1803	4M50W7D	-	0.1146
10	2501.0 ~ 2685.0	9M07G7D	0.0019	0.1762	9M05W7D	-	0.1459
15	2503.5 ~ 2682.5	13M5G7D	-	0.1667	13M4W7D	-	0.1318
20	2506.0 ~ 2680.0	18M4G7D	-	0.1706	18M4W7D	-	0.1483
LTE Band 66		QPSK			16QAM		
BW (MHz)	Frequency Range (MHz)	Emission Designator (99%OBW)	Frequency Tolerance (ppm)	Maximum EIRP(W)	Emission Designator (99%OBW)	Frequency Tolerance (ppm)	Maximum EIRP(W)
1.4	1710.7 ~ 1779.3	1M09G7D	-	0.1923	1M10W7D	-	0.1663
3	1711.5 ~ 1778.5	2M74G7D	-	0.1892	2M72W7D	-	0.1603
5	1712.5 ~ 1777.5	4M50G7D	-	0.2143	4M49W7D	-	0.1816
10	1715 ~ 1775	9M07G7D	0.0023	0.2512	9M03W7D	-	0.2056
15	1717.5 ~ 1772.5	13M4G7D	-	0.2133	13M4W7D	-	0.1770
20	1720.0 ~ 1770.0	18M5G7D	-	0.2333	18M4W7D	-	0.2000



### 1.7 Testing Location

Sporton Lab is accredited to ISO 17025 by Taiwan Accreditation Foundation (TAF code : 1190) and the FCC designation No. TW1190 under the FCC 2.948(e) by Mutual Recognition Agreement (MRA) in FCC Test.

<b>Test Site</b>	SPORTON INTERNATIONAL INC.	
<b>Test Site Location</b>	No. 52, Hwa Ya 1 <sup>st</sup> Rd., Hwa Ya Technology Park, Kwei-Shan District, Tao Yuan City, Taiwan, R.O.C. TEL: +886-3-327-3456 FAX: +886-3-328-4978	
<b>Test Site No.</b>	<b>Sporton Site No.</b>	
	TH05-HY	03CH07-HY

### 1.8 Applicable Standards

According to the specifications of the manufacturer, the EUT must comply with the requirements of the following standards:

- 47 CFR Part 2, 22(H), 24(E), 27
- ANSI / TIA / EIA-603-D-2010
- FCC KDB 971168 D01 Power Meas. License Digital Systems v02r02

**Remark:**

1. All test items were verified and recorded according to the standards and without any deviation during the test.
2. This EUT has also been tested and complied with the requirements of FCC Part 15, Subpart B, recorded in a separate test report.



## 2 Test Configuration of Equipment Under Test

### 2.1 Test Mode

Antenna port conducted and radiated test items listed below are performed according to KDB 971168 D01 Power Meas. License Digital Systems v02r02 with maximum output power.

Radiated measurements are performed by rotating the EUT in three different orthogonal test planes to find the maximum emission.

Test Items	Band	Bandwidth (MHz)						Modulation		RB #			Test Channel		
		1.4	3	5	10	15	20	QPSK	16QAM	1	Half	Full	L	M	H
Max. Output Power	2	✓	✓	✓	✓	✓	✓	✓	✓	✓	✓	✓	✓	✓	✓
	4	✓	✓	✓	✓	✓	✓	✓	✓	✓	✓	✓	✓	✓	✓
	5	✓	✓	✓	✓	-	-	✓	✓	✓	✓	✓	✓	✓	✓
	7	-	-	✓	✓	✓	✓	✓	✓	✓	✓	✓	✓	✓	✓
	12	✓	✓	✓	✓	-	-	✓	✓	✓	✓	✓	✓	✓	✓
	13	-	-	✓	✓	-	-	✓	✓	✓	✓	✓	✓	✓	✓
	17	-	-	✓	✓	-	-	✓	✓	✓	✓	✓	✓	✓	✓
	25	✓	✓	✓	✓	✓	✓	✓	✓	✓	✓	✓	✓	✓	✓
	26	✓	✓	✓	✓	✓	-	✓	✓	✓	✓	✓	✓	✓	✓
	38	-	-	✓	✓	✓	✓	✓	✓	✓	✓	✓	✓	✓	✓
	41	-	-	✓	✓	✓	✓	✓	✓	✓	✓	✓	✓	✓	✓
66	✓	✓	✓	✓	✓	✓	✓	✓	✓	✓	✓	✓	✓	✓	
Peak-to-Average Ratio	2						✓	✓	✓	✓		✓	✓	✓	
	4						✓	✓	✓	✓		✓	✓	✓	
	5				✓	-	-	✓	✓	✓		✓	✓	✓	
	7	-	-				✓	✓	✓	✓		✓	✓	✓	
	12				✓	-	-	✓	✓	✓		✓	✓	✓	
	13	-	-		✓	-	-	✓	✓	✓		✓	✓	✓	
	17	-	-		✓	-	-	✓	✓	✓		✓	✓	✓	
	25						✓	✓	✓	✓		✓	✓	✓	
	26				✓		-	✓	✓	✓		✓	✓	✓	
	38	-	-				✓	✓	✓	✓		✓	✓	✓	
	41	-	-				✓	✓	✓	✓		✓	✓	✓	
66						✓	✓	✓	✓		✓	✓	✓		



Test Items	Band	Bandwidth (MHz)						Modulation		RB #			Test Channel		
		1.4	3	5	10	15	20	QPSK	16QAM	1	Half	Full	L	M	H
26dB and 99% Bandwidth	2	v	v	v	v	v	v	v	v			v	v	v	v
	4	v	v	v	v	v	v	v	v			v	v	v	v
	5	v	v	v	v	-	-	v	v			v	v	v	v
	7	-	-	v	v	v	v	v	v			v	v	v	v
	12	v	v	v	v	-	-	v	v			v	v	v	v
	13	-	-	v	v	-	-	v	v			v	v	v	v
	17	-	-	v	v	-	-	v	v			v	v	v	v
	25	v	v	v	v	v	v	v	v			v	v	v	v
	26	v	v	v	v	v	-	v	v			v	v	v	v
	38	-	-	v	v	v	v	v	v			v	v	v	v
	41	-	-	v	v	v	v	v	v			v	v	v	v
66	v	v	v	v	v	v	v	v			v	v	v	v	
Conducted Band Edge	2	v	v	v	v	v	v	v	v	v		v	v		v
	4	v	v	v	v	v	v	v	v	v		v	v		v
	5	v	v	v	v	-	-	v	v	v		v	v		v
	7	-	-	v	v	v	v	v	v	v		v	v		v
	12	v	v	v	v	-	-	v	v	v		v	v		v
	13	-	-	v	v	-	-	v	v	v		v	v		v
	17	-	-	v	v	-	-	v	v	v		v	v		v
	25	v	v	v	v	v	v	v	v	v		v	v		v
	26	v	v	v	v	v	-	v	v	v		v	v		v
	38	-	-	v	v	v	v	v	v	v		v	v		v
	41	-	-	v	v	v	v	v	v	v		v	v		v
66	v	v	v	v	v	v	v	v	v		v	v		v	



Test Items	Band	Bandwidth (MHz)						Modulation		RB #			Test Channel		
		1.4	3	5	10	15	20	QPSK	16QAM	1	Half	Full	L	M	H
Conducted Spurious Emission	2	✓	✓	✓	✓	✓	✓	✓	✓	✓			✓	✓	✓
	4	✓	✓	✓	✓	✓	✓	✓	✓	✓			✓	✓	✓
	5	✓	✓	✓	✓	-	-	✓	✓	✓			✓	✓	✓
	7	-	-	✓	✓	✓	✓	✓	✓	✓			✓	✓	✓
	12	✓	✓	✓	✓	-	-	✓	✓	✓			✓	✓	✓
	13	-	-	✓	✓	-	-	✓	✓	✓			✓	✓	✓
	17	-	-	✓	✓	-	-	✓	✓	✓			✓	✓	✓
	25	✓	✓	✓	✓	✓	✓	✓	✓	✓			✓	✓	✓
	26	✓	✓	✓	✓	✓	-	✓	✓	✓			✓	✓	✓
	38	-	-	✓	✓	✓	✓	✓	✓	✓			✓	✓	✓
	41	-	-	✓	✓	✓	✓	✓	✓	✓			✓	✓	✓
66	✓	✓	✓	✓	✓	✓	✓	✓	✓			✓	✓	✓	
Frequency Stability	2				✓			✓				✓		✓	
	4				✓			✓				✓		✓	
	5				✓	-	-	✓				✓		✓	
	7	-	-		✓			✓				✓		✓	
	12				✓	-	-	✓				✓		✓	
	13	-	-		✓	-	-	✓				✓		✓	
	17	-	-		✓	-	-	✓				✓		✓	
	25				✓			✓				✓		✓	
	26				✓		-	✓				✓		✓	
	38	-	-		✓			✓				✓		✓	
	41	-	-		✓			✓				✓		✓	
66				✓			✓				✓		✓		



Test Items	Band	Bandwidth (MHz)						Modulation		RB #			Test Channel		
		1.4	3	5	10	15	20	QPSK	16QAM	1	Half	Full	L	M	H
E.R.P/ E.I.R.P.	2	√	√	√	√	√	√	√	√	√			√	√	√
	4	√	√	√	√	√	√	√	√	√			√	√	√
	5	√	√	√	√	-	-	√	√	√			√	√	√
	7	-	-	√	√	√	√	√	√	√			√	√	√
	12	√	√	√	√	√	√	√	√	√			√	√	√
	13	-	-	√	√	√	√	√	√	√			√	√	√
	17	-	-	√	√	-	-	√	√	√			√	√	√
	25	√	√	√	√	√	√	√	√	√			√	√	√
	26	√	√	√	√	√	-	√	√	√			√	√	√
	38	-	-	√	√	√	√	√	√	√			√	√	√
	41	-	-	√	√	√	√	√	√	√			√	√	√
	66	√	√	√	√	√	√	√	√	√			√	√	√
Radiated Spurious Emission	2	√	√	√	√	√	√	√		√			√	√	√
	4	√	√	√	√	√	√	√		√			√	√	√
	5	√	√	√	√	-	-	√		√			√	√	√
	7	-	-	√	√	√	√	√		√			√	√	√
	12	√	√	√	√	-	-	√		√			√	√	√
	13	-	-	√	√	-	-	√		√			√	√	√
	17	-	-	√	√	-	-	√		√			√	√	√
	25	√	√	√	√	√	√	√		√			√	√	√
	26	√	√	√	√	√	-	√		√			√	√	√
	38	-	-	√	√	√	√	√		√			√	√	√
	41	-	-	√	√	√	√	√		√			√	√	√
	66	√	√	√	√	√	√	√		√			√	√	√
Note	<ol style="list-style-type: none"> <li>The mark "√" means that this configuration is chosen for testing</li> <li>The mark "-" means that this bandwidth is not supported.</li> <li>The device is investigated from 30MHz to 10 times of fundamental signal for radiated spurious emission test under different RB size/offset and modulations in exploratory test. Subsequently, only the worst case emissions are reported.</li> <li>All the radiated test cases were performance with Adapter 1 and Battery 1.</li> </ol>														

## 2.2 Connection Diagram of Test System

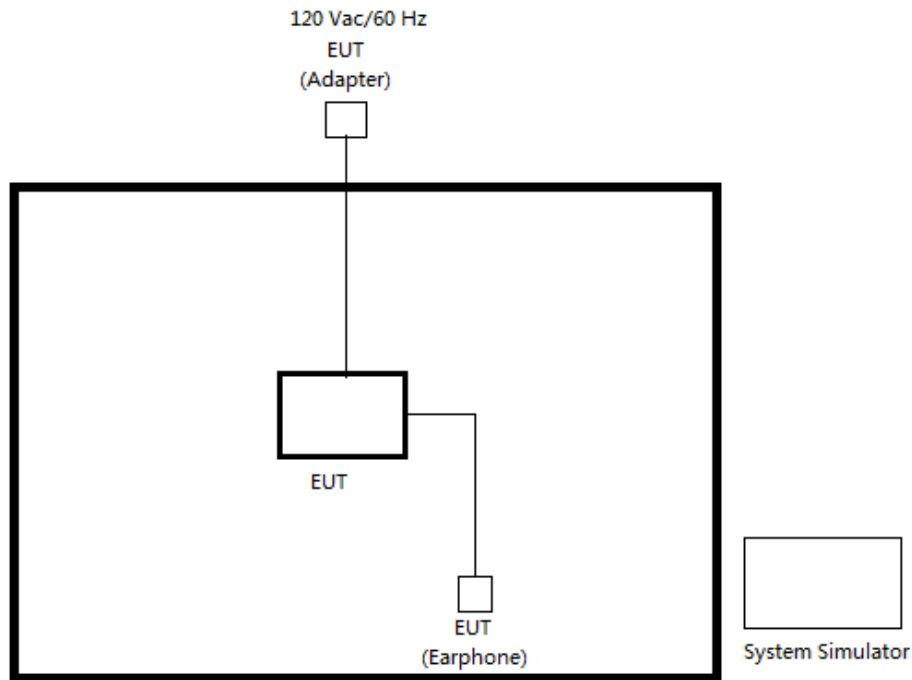

## 2.3 Support Unit used in test configuration and system

Item	Equipment	Trade Name	Model No.	FCC ID	Data Cable	Power Cord
1.	LTE Base Station	Anritsu	MT8820C	N/A	N/A	Unshielded, 1.8 m

## 2.4 Measurement Results Explanation Example

For all conducted test items:

The offset level is set in the spectrum analyzer to compensate the RF cable loss and attenuator factor between EUT conducted output port and spectrum analyzer. With the offset compensation, the spectrum analyzer reading level is exactly the EUT RF output level.

The spectrum analyzer offset is derived from RF cable loss and attenuator factor.

*Offset = RF cable loss + attenuator factor.*

Following shows an offset computation example with cable loss 4.2 dB and 10dB attenuator.

Example :

*Offset(dB) = RF cable loss(dB) + attenuator factor(dB).*

$$= 4.2 + 10 = 14.2 \text{ (dB)}$$



### 2.5 Frequency List of Low/Middle/High Channels

LTE Band 2 Channel and Frequency List				
BW [MHz]	Channel/Frequency(MHz)	Lowest	Middle	Highest
20	Channel	18700	18900	19100
	Frequency	1860	1880	1900
15	Channel	18675	18900	19125
	Frequency	1857.5	1880	1902.5
10	Channel	18650	18900	19150
	Frequency	1855	1880	1905
5	Channel	18625	18900	19175
	Frequency	1852.5	1880	1907.5
3	Channel	18615	18900	19185
	Frequency	1851.5	1880	1908.5
1.4	Channel	18607	18900	19193
	Frequency	1850.7	1880	1909.3

LTE Band 4 Channel and Frequency List				
BW [MHz]	Channel/Frequency(MHz)	Lowest	Middle	Highest
20	Channel	20050	20175	20300
	Frequency	1720	1732.5	1745
15	Channel	20025	20175	20325
	Frequency	1717.5	1732.5	1747.5
10	Channel	20000	20175	20350
	Frequency	1715	1732.5	1750
5	Channel	19975	20175	20375
	Frequency	1712.5	1732.5	1752.5
3	Channel	19965	20175	20385
	Frequency	1711.5	1732.5	1753.5
1.4	Channel	19957	20175	20393
	Frequency	1710.7	1732.5	1754.3



LTE Band 5 Channel and Frequency List				
BW [MHz]	Channel/Frequency(MHz)	Lowest	Middle	Highest
10	Channel	20450	20525	20600
	Frequency	829	836.5	844
5	Channel	20425	20525	20625
	Frequency	826.5	836.5	846.5
3	Channel	20415	20525	20635
	Frequency	825.5	836.5	847.5
1.4	Channel	20407	20525	20643
	Frequency	824.7	836.5	848.3

LTE Band 7 Channel and Frequency List				
BW [MHz]	Channel/Frequency(MHz)	Lowest	Middle	Highest
20	Channel	20850	21100	21350
	Frequency	2510	2535	2560
15	Channel	20825	21100	21375
	Frequency	2507.5	2535	2562.5
10	Channel	20800	21100	21400
	Frequency	2505	2535	2565
5	Channel	20775	21100	21425
	Frequency	2502.5	2535	2567.5

LTE Band 12 Channel and Frequency List				
BW [MHz]	Channel/Frequency(MHz)	Lowest	Middle	Highest
10	Channel	23060	23095	23130
	Frequency	704	707.5	711
5	Channel	23035	23095	23155
	Frequency	701.5	707.5	713.5
3	Channel	23025	23095	23165
	Frequency	700.5	707.5	714.5
1.4	Channel	23017	23095	23173
	Frequency	699.7	707.5	715.3



LTE Band 13 Channel and Frequency List				
BW [MHz]	Channel/Frequency(MHz)	Lowest	Middle	Highest
10	Channel	-	23230	-
	Frequency	-	782	-
5	Channel	23205	23230	23255
	Frequency	779.5	782	784.5

LTE Band 17 Channel and Frequency List				
BW [MHz]	Channel/Frequency(MHz)	Lowest	Middle	Highest
10	Channel	23780	23790	23800
	Frequency	709	710	711
5	Channel	23755	23790	23825
	Frequency	706.5	710	713.5

LTE Band 25 Channel and Frequency List				
BW [MHz]	Channel/Frequency(MHz)	Lowest	Middle	Highest
20	Channel	26140	26340	26590
	Frequency	1860	1880	1905
15	Channel	26115	26340	26615
	Frequency	1857.5	1880	1907.5
10	Channel	26090	26340	26640
	Frequency	1855	1880	1910
5	Channel	26065	26340	26665
	Frequency	1852.5	1880	1912.5
3	Channel	26055	26340	26675
	Frequency	1851.5	1880	1913.5
1.4	Channel	26047	26340	26683
	Frequency	1850.7	1880	1914.3



LTE Band 26 Channel and Frequency List				
BW [MHz]	Channel/Frequency(MHz)	Lowest	Middle	Highest
15	Channel	26865	26915	26965
	Frequency	831.5	836.5	841.5
10	Channel	26840	26915	26990
	Frequency	829	836.5	844
5	Channel	26815	26915	27015
	Frequency	826.5	836.5	846.5
3	Channel	26805	26915	27025
	Frequency	825.5	836.5	847.5
1.4	Channel	26797	26915	27033
	Frequency	824.7	836.5	848.3

LTE Band 38 Channel and Frequency List				
BW [MHz]	Channel/Frequency(MHz)	Lowest	Middle	Highest
20	Channel	37850	38000	38150
	Frequency	2580	2595	2610
15	Channel	37825	38000	38175
	Frequency	2577.5	2595	2612.5
10	Channel	37800	38000	38200
	Frequency	2575	2595	2615
5	Channel	37775	38000	38225
	Frequency	2572.5	2595	2617.5

LTE Band 41 Channel and Frequency List				
BW [MHz]	Channel/Frequency(MHz)	Lowest	Middle	Highest
20	Channel	39750	40620	41490
	Frequency	2506	2593	2680
15	Channel	39725	40620	41515
	Frequency	2503.5	2593	2682.5
10	Channel	39700	40620	41540
	Frequency	2501	2593	2685
5	Channel	39675	40620	41565
	Frequency	2498.5	2593	2687.5



LTE Band 66 Channel and Frequency List				
BW [MHz]	Channel/Frequency(MHz)	Lowest	Middle	Highest
20	Channel	132072	132322	132572
	Frequency	1720	1745	1770
15	Channel	132047	132322	132597
	Frequency	1717.5	1745	1772.5
10	Channel	132022	132322	132622
	Frequency	1715	1745	1775
5	Channel	131997	132322	132647
	Frequency	1712.5	1745	1777.5
3	Channel	131987	132322	132657
	Frequency	1711.5	1745	1778.5
1.4	Channel	131979	132322	132665
	Frequency	1710.7	1745	1779.3

### 3 Conducted Test Items

#### 3.1 Measuring Instruments

See list of measuring instruments of this test report.

#### 3.2 Test Setup

##### 3.2.1 Conducted Output Power

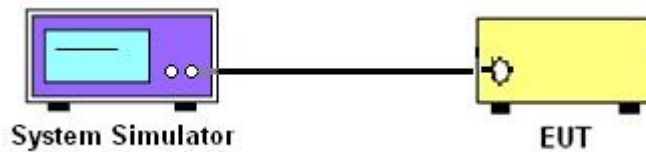

##### 3.2.2 Peak-to-Average Ratio, Occupied Bandwidth ,Conducted Band-Edge and Conducted Spurious Emission

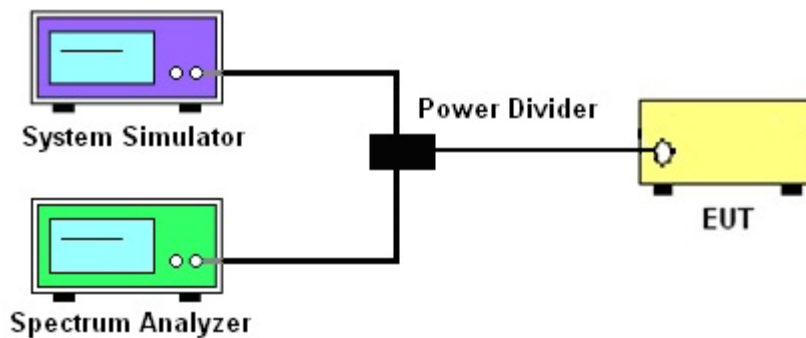

##### 3.2.3 Frequency Stability

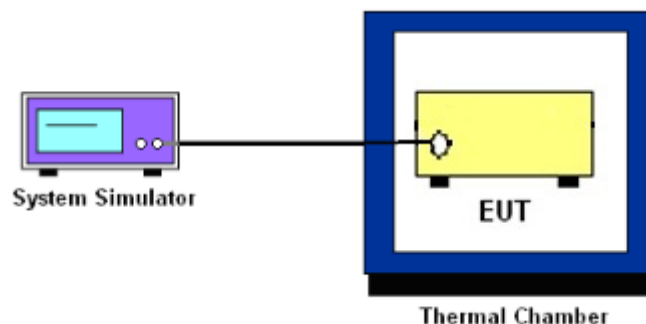

### 3.3 Test Result of Conducted Test

Please refer to Appendix A.



## **3.4 Conducted Output Power**

### **3.4.1 Description of the Conducted Output Power Measurement**

A system simulator was used to establish communication with the EUT. Its parameters were set to force the EUT transmitting at maximum output power. The measured power in the radio frequency on the transmitter output terminals shall be reported.

### **3.4.2 Test Procedures**

1. The transmitter output port was connected to the system simulator.
2. Set EUT at maximum power through the system simulator.
3. Select lowest, middle, and highest channels for each band and different modulation.
4. Measure and record the power level from the system simulator.



## **3.5 Peak-to-Average Ratio**

### **3.5.1 Description of the PAR Measurement**

Power Complementary Cumulative Distribution Function (CCDF) curves provide a means for characterizing the power peaks of a digitally modulated signal on a statistical basis. A CCDF curve depicts the probability of the peak signal amplitude exceeding the average power level. Most contemporary measurement instrumentation include the capability to produce CCDF curves for an input signal provided that the instrument's resolution bandwidth can be set wide enough to accommodate the entire input signal bandwidth. In measuring transmissions in this band using an average power technique, the peak-to-average ratio (PAR) of the transmission may not exceed 13 dB.

### **3.5.2 Test Procedures**

1. The testing follows FCC KDB 971168 v02r02 Section 5.7.1.
2. The EUT was connected to spectrum and system simulator via a power divider.
3. Set the CCDF (Complementary Cumulative Distribution Function) option in spectrum analyzer.
4. The highest RF powers were measured and recorded the maximum PAPR level associated with a probability of 0.1 %.
5. Record the deviation as Peak to Average Ratio.



## 3.6 Occupied Bandwidth

### 3.6.1 Description of Occupied Bandwidth Measurement

The occupied bandwidth is the width of a frequency band such that, below the lower and above the upper frequency limits, the mean powers emitted are each equal to a specified percentage 0.5% of the total mean transmitted power.

The 26 dB emission bandwidth is defined as the frequency range between two points, one above and one below the carrier frequency, at which the spectral density of the emission is attenuated 26 dB below the maximum in-band spectral density of the modulated signal. Spectral density (power per unit bandwidth) is to be measured with a detector of resolution bandwidth equal to approximately 1.0% of the emission bandwidth.

### 3.6.2 Test Procedures

1. The testing follows FCC KDB 971168 v02r02 Section 4.2.
2. The EUT was connected to spectrum analyzer and system simulator via a power divider.
3. The spectrum analyzer center frequency is set to the nominal EUT channel center frequency. The span range for the spectrum analyzer shall be between two and five times the anticipated OBW.
4. The nominal resolution bandwidth (RBW) shall be in the range of 1 to 5 % of the anticipated OBW, and the VBW shall be at least 3 times the RBW.
5. Set the detection mode to peak, and the trace mode to max hold.
6. Determine the reference value: Set the EUT to transmit a modulated signal. Allow the trace to stabilize. Set the spectrum analyzer marker to the highest level of the displayed trace.  
(this is the reference value)
7. Determine the “-26 dB down amplitude” as equal to (Reference Value – X).
8. Place two markers, one at the lowest and the other at the highest frequency of the envelope of the spectral display such that each marker is at or slightly below the “-X dB down amplitude” determined in step 6. If a marker is below this “-X dB down amplitude” value it shall be placed as close as possible to this value. The OBW is the positive frequency difference between the two markers.
9. Use the 99 % power bandwidth function of the spectrum analyzer and report the measured bandwidth.



### 3.7 Conducted Band Edge

#### 3.7.1 Description of Conducted Band Edge Measurement

22.917(a)

For operations in the 824 – 849 MHz band, the FCC limit is  $43 + 10\log_{10}(P[\text{Watts}])$  dB below the transmitter power  $P(\text{Watts})$  in a 100kHz bandwidth. However, in the 1MHz bands immediately outside and adjacent to the licensee's frequency block, a resolution bandwidth of at least one percent of the emission bandwidth of the fundamental emission of the transmitter may be employed.

24.238 (a)

For operations in the 1850-1910 and 1930-1990 MHz band, the FCC limit is  $43 + 10\log_{10}(P[\text{Watts}])$  dB below the transmitter power  $P(\text{Watts})$  in a 1MHz bandwidth. However, in the 1 MHz bands immediately outside and adjacent to the frequency block a resolution bandwidth of at least one percent of the emission bandwidth of the fundamental emission of the transmitter may be employed.

27.53 (c)

For operations in the 776-788 MHz band, the FCC limit is  $43 + 10\log_{10}(P[\text{Watts}])$  dB below the transmitter power  $P(\text{Watts})$  in a 100 kHz bandwidth. However, in the 100 kHz bands immediately outside and adjacent to the frequency block, a resolution bandwidth of at least 30 kHz may be employed. In addition, the power of any unwanted emissions in any 6.25 kHz bandwidth for all frequencies between 763-775 MHz and 793-806 MHz shall be attenuated below the transmitter power,  $P$  (dBW), by at least  $65 + 10 \log_{10} p(\text{watts})$ , dB, for mobile and portable equipment.

27.53 (g)

For operations in the 698 -746 MHz band, the FCC limit is  $43 + 10\log_{10}(P[\text{Watts}])$  dB below the transmitter power  $P(\text{Watts})$  in a 100 kHz bandwidth. However, in the 100 kilohertz bands immediately outside and adjacent to a licensee's frequency block, a resolution bandwidth of at least 30 kHz may be employed.

27.53 (h)

For operations in the 1710 – 1755 MHz band, the FCC limit is  $43 + 10\log_{10}(P[\text{Watts}])$  dB below the transmitter power  $P(\text{Watts})$  in a 1 MHz bandwidth. However, in the 1MHz bands immediately outside and adjacent to the licensee's frequency block, a resolution bandwidth of at least one percent of the emission bandwidth of the fundamental emission of the transmitter may be employed.



27.53(m)(4)

For mobile digital stations, the attenuation factor shall be not less than  $40 + 10 \log (P)$  dB on all frequencies between the channel edge and 5 megahertz from the channel edge,  $43 + 10 \log (P)$  dB on all frequencies between 5 megahertz and X megahertz from the channel edge, and  $55 + 10 \log (P)$  dB on all frequencies more than X megahertz from the channel edge, where X is the greater of 6 megahertz or the actual emission bandwidth as defined in paragraph (m)(6) of this section. In addition, the attenuation factor shall not be less that  $43 + 10 \log (P)$  dB on all frequencies between 2490.5 MHz and 2496 MHz and  $55 + 10 \log (P)$  dB at or below 2490.5 MHz. Mobile Satellite Service licensees operating on frequencies below 2495 MHz may also submit a documented interference complaint against BRS licensees operating on channel BRS Channel 1 on the same terms and conditions as adjacent channel BRS or EBS licensees.

**3.7.2 Test Procedures**

1. The testing follows FCC KDB 971168 v02r02 Section 6.0.
2. The EUT was connected to spectrum analyzer and system simulator via a power divider.
3. The band edges of low and high channels for the highest RF powers were measured.
4. Set RBW  $\geq 1\%$  EBW in the 1MHz band immediately outside and adjacent to the band edge.
5. Beyond the 1 MHz band from the band edge, RBW=1MHz was used.
6. Set spectrum analyzer with RMS detector.
7. The RF fundamental frequency should be excluded against the limit line in the operating frequency band.
8. Checked that all the results comply with the emission limit line.  
The limit line is derived from  $43 + 10\log(P)$ dB below the transmitter power P(Watts)
9. For LTE Band 7, 38, 41, the other 40 dB, and 55 dB have additionally applied same calculation above.



## 3.8 Conducted Spurious Emission

### 3.8.1 Description of Conducted Spurious Emission Measurement

The power of any emission outside of the authorized operating frequency ranges must be lower than the transmitter power (P) by a factor of at least  $43 + 10 \log (P)$  dB.

For Band 7,38,41:

The power of any emission outside of the authorized operating frequency ranges must be lower than the transmitter power (P) by a factor of at least  $55 + 10 \log (P)$  dB.

It is measured by means of a calibrated spectrum analyzer and scanned from 30 MHz up to a frequency including its 10<sup>th</sup> harmonic.

### 3.8.2 Test Procedures

1. The testing follows FCC KDB 971168 v02r02 Section 6.0.
2. The EUT was connected to spectrum analyzer and system simulator via a power divider.
3. The RF output of EUT was connected to the spectrum analyzer by RF cable and attenuator. The path loss was compensated to the results for each measurement.
4. The middle channel for the highest RF power within the transmitting frequency was measured.
5. The conducted spurious emission for the whole frequency range was taken.
6. Make the measurement with the spectrum analyzer's RBW = 1MHz, VBW = 3MHz.
7. Set spectrum analyzer with RMS detector.
8. Taking the record of maximum spurious emission.
9. The RF fundamental frequency should be excluded against the limit line in the operating frequency band.
10. The limit line is derived from  $43 + 10\log(P)$ dB below the transmitter power P(Watts)
11. For Band 7, 38, 41  
The limit line is derived from  $55 + 10\log(P)$ dB below the transmitter power P(Watts)



### 3.9 Frequency Stability

#### 3.9.1 Description of Frequency Stability Measurement

The frequency stability shall be measured by variation of ambient temperature and variation of primary supply voltage to ensure that the fundamental emission stays within the authorized frequency block. The frequency stability of the transmitter shall be maintained within  $\pm 0.00025\%$  ( $\pm 2.5\text{ppm}$ ) of the center frequency.

#### 3.9.2 Test Procedures for Temperature Variation

1. The testing follows FCC KDB 971168 v02r02 Section 9.0.
2. The EUT was set up in the thermal chamber and connected with the system simulator.
3. With power OFF, the temperature was decreased to  $-30^{\circ}\text{C}$  and the EUT was stabilized before testing. Power was applied and the maximum change in frequency was recorded within one minute.
4. With power OFF, the temperature was raised in  $10^{\circ}\text{C}$  step up to  $50^{\circ}\text{C}$ . The EUT was stabilized at each step for at least half an hour. Power was applied and the maximum frequency change was recorded within one minute.

#### 3.9.3 Test Procedures for Voltage Variation

1. The testing follows FCC KDB 971168 v02r02 Section 9.0.
2. The EUT was placed in a temperature chamber at  $20\pm 5^{\circ}\text{C}$  and connected with the system simulator.
3. The power supply voltage to the EUT was varied from 85% to 115% of the nominal value measured at the input to the EUT.
4. The variation in frequency was measured for the worst case.

## 4 Radiated Test Items

### 4.1 Measuring Instruments

See list of measuring instruments of this test report.

### 4.2 Test Setup

#### 4.2.1 For radiated test from 30MHz to 1GHz

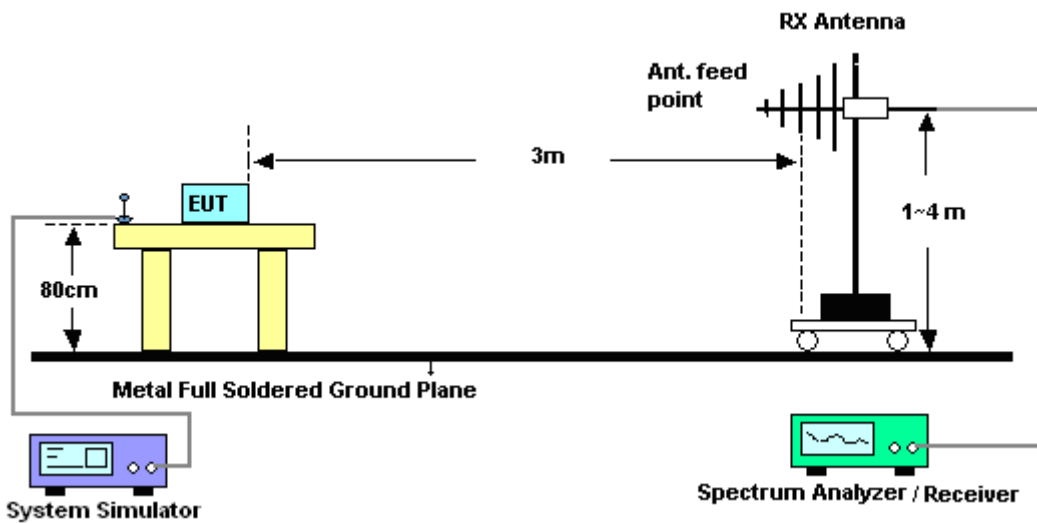

#### 4.2.2 For radiated test above 1GHz

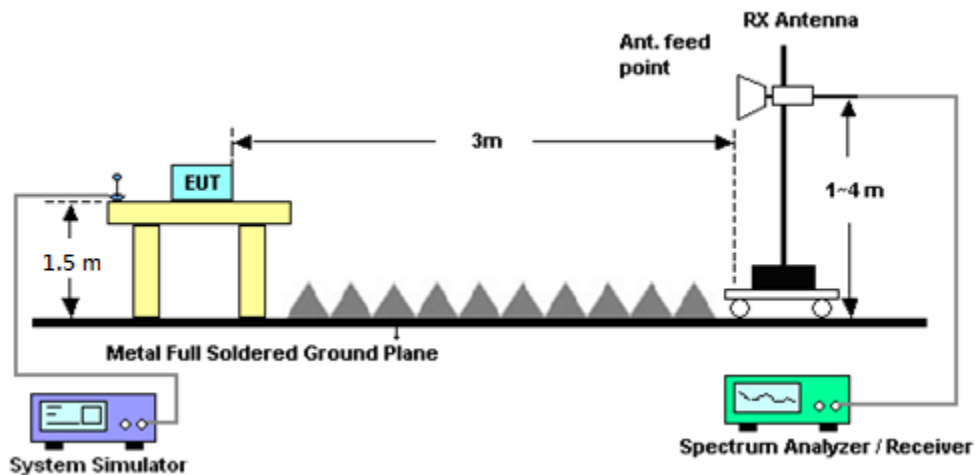

### 4.3 Test Result of Radiated Test

Please refer to Appendix B.



## **4.4 Effective Radiated Power and Effective Isotropic Radiated Power**

### **4.4.1 Description of the ERP/EIRP Measurement**

Effective radiated power output measurements by substitution method according to ANSI / TIA / EIA-603-D-2010, and the spectrum analyzer configuration follows KDB 971168 D01 Power Meas. License Digital Systems v02r02. Mobile and portable (hand-held) stations operating are limited to average ERP of 7 watts with LTE band 5 / 26 and 3 watts with LTE band 12 / 13 / 17.

Equivalent isotropic radiated power output measurements by substitution method according to ANSI / TIA / EIA-603-D-2010, and the spectrum analyzer configuration follows KDB 971168 D01 Power Meas. License Digital Systems v02r02. Mobile and portable (hand-held) stations operating are limited to average EIRP of 2 watts with LTE band 2 / 25 / 7 / 38 / 41 and 1 watt with LTE band 4 / 66.

### **4.4.2 Test Procedures**

1. The EUT was placed on a non-conductive rotating platform (0.8 meters for frequency below 1GHz and 1.5 meter for frequency above 1GHz) in a semi-anechoic chamber. The radiated emission at the fundamental frequency was measured at 3 m with a test antenna and a spectrum analyzer with RMS detector per section 5. of KDB 971168 D01.
2. During the measurement, the system simulator parameters were set to force the EUT transmitting at maximum output power. The maximum emission was recorded from analyzer power level (LVL) from the 360 degrees rotation of the turntable and the test antenna raised and lowered over a range from 1 to 4 meters in both horizontally and vertically polarized orientations.
3. Effective Isotropic Radiated Power (EIRP) was measured by substitution method according to TIA/EIA-603-D. The EUT was replaced by the substitution antenna at same location, and then a known power from S.G. was applied into the dipole antenna through a Tx cable, and then recorded the maximum Analyzer reading through raised and lowered the test antenna. The correction factor (in dB) = S.G. - Tx Cable loss + Substitution antenna gain - Analyzer reading. Then the EUT's EIRP was calculated with the correction factor,  $EIRP = LVL + \text{Correction factor}$  and  $ERP = EIRP - 2.15$ . Take the record of the output power at substitution antenna.



	LTE Average					
LTE BW	1.4M	3M	5M	10M	15M	20M
Span	3MHz	6MHz	10MHz	20MHz	30MHz	40MHz
RBW	30kHz	100kHz	100kHz	300kHz	300kHz	300kHz
VBW	100kHz	300kHz	300kHz	1MHz	1MHz	1MHz
Detector	RMS	RMS	RMS	RMS	RMS	RMS
Trace	Average	Average	Average	Average	Average	Average
Average Type	Power	Power	Power	Power	Power	Power
Sweep Count	100	100	100	100	100	100



## 4.5 Radiated Spurious Emission

### 4.5.1 Description of Radiated Spurious Emission

The radiated spurious emission was measured by substitution method according to ANSI / TIA / EIA-603-D-2010. The power of any emission outside of the authorized operating frequency ranges must be attenuated below the transmitter power (P) by a factor of at least  $43 + 10 \log (P)$  dB.

For Band 7, 38, 41

The power of any emission outside of the authorized operating frequency ranges must be attenuated below the transmitter power (P) by a factor of at least  $55 + 10 \log (P)$  dB.

For LTE Band 12,13,17

For operations in the 746-758 MHz, 775-788 MHz, and 805-806 MHz bands, emissions in the band 1559-1610 MHz shall be limited to  $-70$  dBW/MHz equivalent isotropically radiated power (EIRP) for wideband signals, and  $-80$  dBW EIRP for discrete emissions of less than 700 Hz bandwidth.

The spectrum is scanned from 30 MHz up to a frequency including its 10th harmonic.

### 4.5.2 Test Procedures

1. The testing follows FCC KDB 971168 v02r02 Section 5.8 and ANSI / TIA-603-D-2010 Section 2.2.12.
2. The EUT was placed on a turntable with 0.8 meter for frequency below 1GHz and 1.5 meter for frequency above 1GHz respectively above ground.
3. The EUT was set 3 meters from the receiving antenna, which was mounted on the antenna tower.
4. The table was rotated 360 degrees to determine the position of the highest spurious emission.
5. The height of the receiving antenna is varied between one meter and four meters to search the maximum spurious emission for both horizontal and vertical polarizations.
6. Make the measurement with the spectrum analyzer's RBW = 1MHz, VBW = 3MHz, taking the record of maximum spurious emission.
7. A horn antenna was substituted in place of the EUT and was driven by a signal generator.
8. Tune the output power of signal generator to the same emission level with EUT maximum spurious emission.
9. Taking the record of output power at antenna port.
10. Repeat step 7 to step 8 for another polarization.
11. The RF fundamental frequency should be excluded against the limit line in the operating frequency band.

The limit line is derived from  $43 + 10\log(P)$ dB below the transmitter power P(Watts)

12. For Band 7, 38, 41:

The limit line is derived from  $55 + 10\log(P)$ dB below the transmitter power P(Watts)

EIRP (dBm) = S.G. Power – Tx Cable Loss + Tx Antenna Gain

ERP (dBm) = EIRP - 2.15



## 5 List of Measuring Equipment

Instrument	Manufacturer	Model No.	Serial No.	Characteristics	Calibration Date	Test Date	Due Date	Remark
LTE Base Station	Anritsu	MT8820C	6201432821	GSM/GPRS /WCDMA/LTE	Oct. 11, 2016	Feb. 03, 2017 ~ Feb. 22, 2017	Oct. 10, 2017	Conducted (TH05-HY)
Spectrum Analyzer	Rohde & Schwarz	FSV40	101397	10Hz~40GHz	Nov. 04, 2016	Feb. 03, 2017 ~ Feb. 22, 2017	Nov. 03, 2017	Conducted (TH05-HY)
Temperature Chamber	ESPEC	SH-641	92013720	-30°C~70°C	Sep. 01, 2016	Feb. 03, 2017 ~ Feb. 22, 2017	Aug. 31, 2017	Conducted (TH05-HY)
Programmable Power Supply	GW Instek	PSS-2005	EL890001	1V~20V 0.5A~5A	Oct. 03, 2016	Feb. 03, 2017 ~ Feb. 22, 2017	Oct. 02, 2017	Conducted (TH05-HY)
Bilog Antenna	TESEQ	CBL 6111D&00800	35419&03	30MHz to 1GHz	Jan. 07, 2017	Feb. 08, 2017 ~ Feb. 17, 2017	Jan. 06, 2018	Radiation (03CH07-HY)
Double Ridge Horn Antenna	ESCO	3117	00075962	1GHz ~ 18GHz	Aug. 19, 2016	Feb. 08, 2017 ~ Feb. 17, 2017	Aug. 18, 2017	Radiation (03CH07-HY)
EMI Test Receiver	Keysight	N9038A(MXE)	MY54130085	20Hz ~ 8.4GHz	Oct. 26, 2016	Feb. 08, 2017 ~ Feb. 17, 2017	Oct. 25, 2017	Radiation (03CH07-HY)
Loop Antenna	Rohde & Schwarz	HFH2-Z2	100315	9 kHz~30 MHz	Sep. 02, 2015	Feb. 08, 2017 ~ Feb. 17, 2017	Sep. 01, 2017	Radiation (03CH07-HY)
Preamplifier	MITEQ	AMF-7D-0010 1800-30-10P	1590075	1GHz ~ 18GHz	Apr. 15, 2016	Feb. 08, 2017 ~ Feb. 17, 2017	Apr. 14, 2017	Radiation (03CH07-HY)
Preamplifier	COM-POWER	PA-103A	161241	10MHz-1GHz	Mar. 18, 2016	Feb. 08, 2017 ~ Feb. 17, 2017	Mar. 17, 2017	Radiation (03CH07-HY)
Spectrum Analyzer	Agilent	N9010A	MY53470118	10Hz~44GHz	Feb. 27, 2016	Feb. 08, 2017 ~ Feb. 17, 2017	Feb. 26, 2017	Radiation (03CH07-HY)
Antenna Mast	Max-Full	MFA520BS	N/A	1m~4m	N/A	Feb. 08, 2017 ~ Feb. 17, 2017	N/A	Radiation (03CH07-HY)
Turn Table	ChainTek	Chaintek 3000	N/A	0~360 Degree	N/A	Feb. 08, 2017 ~ Feb. 17, 2017	N/A	Radiation (03CH07-HY)
Preamplifier	MITEQ	JS44-1800400 0-33-8P	1840917	18GHz ~ 40GHz	Jun. 14, 2016	Feb. 08, 2017 ~ Feb. 17, 2017	Jun. 13, 2017	Radiation (03CH07-HY)
SHF-EHF Horn Antenna	SCHWARZBECK	BBHA 9170	BBHA9170584	18GHz- 40GHz	Nov. 08, 2016	Feb. 08, 2017 ~ Feb. 17, 2017	Nov. 07, 2017	Radiation (03CH07-HY)
Signal Generator	Anritsu	MG3694C	163401	0.1Hz~40GHz	Jan. 04, 2017	Feb. 08, 2017 ~ Feb. 17, 2017	Jan. 03, 2018	Radiation (03CH07-HY)



## 6 Uncertainty of Evaluation

### Uncertainty of Radiated Emission Measurement (30 MHz ~ 1000 MHz)

Measuring Uncertainty for a Level of Confidence of 95% ( $U = 2Uc(y)$ )	5.7
---	-----

### Uncertainty of Radiated Emission Measurement (1 GHz ~ 18 GHz)

Measuring Uncertainty for a Level of Confidence of 95% ( $U = 2Uc(y)$ )	5.5
---	-----

### Uncertainty of Radiated Emission Measurement (18 GHz ~ 40 GHz)

Measuring Uncertainty for a Level of Confidence of 95% ( $U = 2Uc(y)$ )	5.2
---	-----



## Appendix A. Test Results of Conducted Test

### Conducted Output Power(Average power)

LTE Band 2 Maximum Average Power [dBm]						
BW [MHz]	RB Size	RB Offset	Mod	Lowest	Middle	Highest
20	1	0	QPSK	22.33	22.55	22.47
20	1	49		22.24	22.38	22.44
20	1	99		22.09	22.14	22.28
20	50	0		21.35	21.48	21.55
20	50	24		21.28	21.45	21.50
20	50	50		21.34	21.47	21.48
20	100	0		21.31	21.52	21.41
20	1	0	16-QAM	21.47	21.65	21.69
20	1	49		21.54	21.59	21.67
20	1	99		21.48	21.58	21.61
20	50	0		20.31	20.43	20.47
20	50	24		20.31	20.44	20.51
20	50	50		20.34	20.43	20.46
20	100	0		20.29	20.42	20.51
15	1	0	QPSK	22.45	22.35	22.44
15	1	37		22.05	22.09	22.19
15	1	74		22.39	22.53	22.54
15	36	0		21.30	21.44	21.51
15	36	20		21.29	21.40	21.51
15	36	39		21.28	21.38	21.48
15	75	0		21.28	21.40	21.50
15	1	0	16-QAM	21.63	21.78	21.77
15	1	37		21.42	21.44	21.59
15	1	74		21.67	21.77	21.77
15	36	0		20.28	20.42	20.49
15	36	20		20.29	20.42	20.50
15	36	39		20.27	20.42	20.49
15	75	0		20.26	20.40	20.50



LTE Band 2 Maximum Average Power [dBm]						
BW [MHz]	RB Size	RB Offset	Mod	Lowest	Middle	Highest
10	1	0	QPSK	22.07	22.15	22.31
10	1	25		22.08	22.26	22.37
10	1	49		22.20	22.30	22.50
10	25	0		21.20	21.31	21.48
10	25	12		21.16	21.31	21.41
10	25	25		21.18	21.32	21.42
10	50	0		21.17	21.34	21.41
10	1	0	16-QAM	21.49	21.63	21.79
10	1	25		21.37	21.53	21.64
10	1	49		21.49	21.58	21.74
10	25	0		20.19	20.32	20.52
10	25	12		20.17	20.32	20.43
10	25	25		20.16	20.35	20.42
10	50	0		20.17	20.29	20.41
5	1	0	QPSK	22.24	22.13	22.17
5	1	12		22.06	22.24	22.20
5	1	24		22.10	22.28	22.39
5	12	0		21.22	21.40	21.61
5	12	7		21.18	21.32	21.45
5	12	13		21.15	21.29	21.47
5	25	0		21.24	21.38	21.47
5	1	0	16-QAM	21.45	21.65	21.72
5	1	12		21.25	21.49	21.61
5	1	24		21.35	21.56	21.63
5	12	0		20.26	20.42	20.55
5	12	7		20.23	20.35	20.52
5	12	13		20.21	20.32	20.48
5	25	0		20.19	20.33	20.48



LTE Band 2 Maximum Average Power [dBm]						
BW [MHz]	RB Size	RB Offset	Mod	Lowest	Middle	Highest
3	1	0	QPSK	22.16	22.00	22.12
3	1	8		22.09	22.22	22.41
3	1	14		22.03	22.13	22.35
3	8	0		21.16	21.30	21.46
3	8	4		21.16	21.31	21.47
3	8	7		21.12	21.25	21.47
3	15	0		21.18	21.31	21.44
3	1	0	16-QAM	21.38	21.56	21.69
3	1	8		21.36	21.50	21.66
3	1	14		21.29	21.42	21.59
3	8	0		20.22	20.39	20.52
3	8	4		20.22	20.39	20.53
3	8	7		20.19	20.33	20.50
3	15	0		20.21	20.32	20.45
1.4	1	0	QPSK	22.05	22.05	22.04
1.4	1	3		22.14	22.31	22.44
1.4	1	5		22.04	22.18	22.34
1.4	3	0		22.08	22.21	22.34
1.4	3	1		22.10	22.26	22.40
1.4	3	3		22.06	22.23	22.37
1.4	6	0		21.11	21.27	21.45
1.4	1	0	16-QAM	21.31	21.48	21.61
1.4	1	3		21.42	21.54	21.65
1.4	1	5		21.28	21.46	21.60
1.4	3	0		21.11	21.24	21.39
1.4	3	1		21.14	21.28	21.44
1.4	3	3		21.05	21.21	21.39
1.4	6	0		20.21	20.36	20.49



LTE Band 25 Maximum Average Power [dBm]						
BW [MHz]	RB Size	RB Offset	Mod	Lowest	Middle	Highest
20	1	0	QPSK	22.44	22.51	22.49
20	1	49		22.37	22.57	22.49
20	1	99		22.39	22.55	22.38
20	50	0		21.54	21.60	21.58
20	50	24		21.42	21.66	21.57
20	50	50		21.42	21.61	21.54
20	100	0		21.45	21.65	21.57
20	1	0	16-QAM	21.77	21.88	21.84
20	1	49		21.69	21.69	21.77
20	1	99		21.81	21.88	21.87
20	50	0		20.50	20.63	20.60
20	50	24		20.48	20.66	20.59
20	50	50		20.42	20.59	20.55
20	100	0		20.47	20.64	20.58
15	1	0	QPSK	22.56	22.69	22.70
15	1	37		22.30	22.42	22.39
15	1	74		22.56	22.76	22.71
15	36	0		21.52	21.70	21.70
15	36	20		21.54	21.69	21.68
15	36	39		21.62	21.68	21.70
15	75	0		21.55	21.73	21.73
15	1	0	16-QAM	21.76	21.87	21.85
15	1	37		21.58	21.90	21.90
15	1	74		21.81	22.01	21.74
15	36	0		20.58	20.70	20.71
15	36	20		20.49	20.71	20.67
15	36	39		20.63	20.70	20.65
15	75	0		20.49	20.71	20.73



LTE Band 25 Maximum Average Power [dBm]						
BW [MHz]	RB Size	RB Offset	Mod	Lowest	Middle	Highest
10	1	0	QPSK	22.62	22.61	22.78
10	1	25		22.39	22.32	22.72
10	1	49		22.56	22.56	<b>22.80</b>
10	25	0		21.48	21.40	21.66
10	25	12		21.46	21.42	21.65
10	25	25		21.46	21.47	21.75
10	50	0		21.43	21.40	21.67
10	1	0	16-QAM	21.83	21.86	22.09
10	1	25		21.66	21.60	21.84
10	1	49		21.87	21.84	22.03
10	25	0		20.43	20.41	20.66
10	25	12		20.45	20.42	20.66
10	25	25		20.42	20.45	20.66
10	50	0		20.42	20.46	20.68
5	1	0	QPSK	22.54	22.52	22.71
5	1	12		22.35	22.27	22.65
5	1	24		22.36	22.32	22.57
5	12	0		21.47	21.47	21.60
5	12	7		21.40	21.39	21.59
5	12	13		21.40	21.32	21.48
5	25	0		21.42	21.37	21.67
5	1	0	16-QAM	21.76	21.76	22.03
5	1	12		21.64	21.56	21.62
5	1	24		21.62	21.61	21.85
5	12	0		20.48	20.49	20.63
5	12	7		20.45	20.42	20.64
5	12	13		20.39	20.41	20.59
5	25	0		20.41	20.40	20.70



LTE Band 25 Maximum Average Power [dBm]						
BW [MHz]	RB Size	RB Offset	Mod	Lowest	Middle	Highest
3	1	0	QPSK	22.40	22.41	22.63
3	1	8		22.39	22.34	22.58
3	1	14		22.32	22.26	22.56
3	8	0		21.43	21.39	21.60
3	8	4		21.43	21.35	21.57
3	8	7		21.35	21.33	21.62
3	15	0		21.41	21.35	21.58
3	1	0	16-QAM	21.70	21.64	21.97
3	1	8		21.67	21.63	21.96
3	1	14		21.60	21.54	21.92
3	8	0		20.45	20.40	20.62
3	8	4		20.45	20.44	20.62
3	8	7		20.42	20.41	20.66
3	15	0		20.42	20.40	20.60
1.4	1	0	QPSK	22.35	22.34	22.59
1.4	1	3		22.40	22.39	22.64
1.4	1	5		22.33	22.29	22.61
1.4	3	0		22.39	22.31	22.60
1.4	3	1		22.40	22.37	22.60
1.4	3	3		22.36	22.35	22.60
1.4	6	0		21.36	21.35	21.61
1.4	1	0	16-QAM	21.64	21.58	22.08
1.4	1	3		21.67	21.61	21.98
1.4	1	5		21.60	21.58	21.87
1.4	3	0		21.38	21.33	21.59
1.4	3	1		21.42	21.39	21.59
1.4	3	3		21.37	21.31	21.54
1.4	6	0		20.42	20.38	20.77



LTE Band 4 Maximum Average Power [dBm]						
BW [MHz]	RB Size	RB Offset	Mod	Lowest	Middle	Highest
20	1	0	QPSK	22.17	22.19	22.03
20	1	49		22.28	22.32	22.40
20	1	99		22.34	22.39	22.40
20	50	0		21.37	21.44	21.44
20	50	24		21.41	21.44	21.51
20	50	50		21.37	21.46	21.39
20	100	0		21.37	21.41	21.48
20	1	0	16-QAM	21.41	21.41	21.46
20	1	49		21.54	21.46	21.55
20	1	99		21.55	21.45	21.62
20	50	0		20.37	20.46	20.44
20	50	24		20.41	20.46	20.55
20	50	50		20.38	20.49	20.41
20	100	0		20.40	20.43	20.52
15	1	0	QPSK	22.13	22.40	22.25
15	1	37		22.29	22.24	22.30
15	1	74		22.28	22.30	22.41
15	36	0		21.44	21.44	21.61
15	36	20		21.48	21.48	21.52
15	36	39		21.37	21.40	21.45
15	75	0		21.45	21.48	21.52
15	1	0	16-QAM	21.62	21.76	21.75
15	1	37		21.53	21.51	21.74
15	1	74		21.48	21.50	21.68
15	36	0		20.40	20.43	20.63
15	36	20		20.48	20.54	20.57
15	36	39		20.37	20.42	20.46
15	75	0		20.48	20.51	20.57



LTE Band 4 Maximum Average Power [dBm]						
BW [MHz]	RB Size	RB Offset	Mod	Lowest	Middle	Highest
10	1	0	QPSK	22.45	22.41	22.54
10	1	25		22.39	22.46	22.39
10	1	49		22.49	<b>22.66</b>	22.65
10	25	0		21.56	21.58	21.53
10	25	12		21.51	21.55	21.52
10	25	25		21.62	21.61	21.65
10	50	0		21.59	21.63	21.55
10	1	0	16-QAM	22.05	21.98	21.99
10	1	25		21.65	21.69	21.66
10	1	49		22.07	22.08	22.09
10	25	0		20.56	20.63	20.54
10	25	12		20.49	20.59	20.51
10	25	25		20.65	20.60	20.62
10	50	0		20.64	20.65	20.57
5	1	0	QPSK	22.21	22.32	22.22
5	1	12		22.38	22.44	22.38
5	1	24		22.43	22.37	22.37
5	12	0		21.61	21.53	21.59
5	12	7		21.49	21.53	21.51
5	12	13		21.42	21.49	21.51
5	25	0		21.49	21.56	21.54
5	1	0	16-QAM	21.84	21.74	21.79
5	1	12		21.71	21.72	21.66
5	1	24		21.69	21.58	21.64
5	12	0		20.56	20.58	20.60
5	12	7		20.50	20.60	20.52
5	12	13		20.47	20.51	20.55
5	25	0		20.56	20.58	20.49



LTE Band 4 Maximum Average Power [dBm]						
BW [MHz]	RB Size	RB Offset	Mod	Lowest	Middle	Highest
3	1	0	QPSK	22.45	22.31	22.40
3	1	8		22.46	22.46	22.30
3	1	14		22.37	22.34	22.32
3	8	0		21.49	21.43	21.46
3	8	4		21.55	21.54	21.52
3	8	7		21.44	21.50	21.48
3	15	0		21.49	21.51	21.40
3	1	0	16-QAM	21.73	21.68	21.67
3	1	8		21.70	21.68	21.71
3	1	14		21.65	21.47	21.57
3	8	0		20.56	20.49	20.54
3	8	4		20.56	20.61	20.59
3	8	7		20.48	20.56	20.54
3	15	0		20.51	20.55	20.42
1.4	1	0	QPSK	22.23	22.17	22.05
1.4	1	3		22.37	22.48	22.45
1.4	1	5		22.34	22.38	22.35
1.4	3	0		22.45	22.30	22.42
1.4	3	1		22.48	22.45	22.43
1.4	3	3		22.36	22.40	22.39
1.4	6	0		21.39	21.45	21.45
1.4	1	0	16-QAM	21.66	21.55	21.66
1.4	1	3		21.63	21.71	21.69
1.4	1	5		21.59	21.63	21.57
1.4	3	0		21.46	21.34	21.45
1.4	3	1		21.52	21.47	21.46
1.4	3	3		21.36	21.41	21.40
1.4	6	0		20.47	20.56	20.51



LTE Band 5 Maximum Average Power [dBm]						
BW [MHz]	RB Size	RB Offset	Mod	Lowest	Middle	Highest
10	1	0	QPSK	22.61	22.85	22.77
10	1	25		22.53	22.48	22.37
10	1	49		22.77	22.78	22.84
10	25	0		21.65	21.59	21.74
10	25	12		21.62	21.55	21.63
10	25	25		21.63	21.60	21.77
10	50	0		21.64	21.64	21.75
10	1	0	16-QAM	21.84	21.93	21.96
10	1	25		21.81	21.73	21.78
10	1	49		21.97	22.08	22.08
10	25	0		20.64	20.57	20.72
10	25	12		20.61	20.53	20.64
10	25	25		20.63	20.64	20.69
10	50	0		20.66	20.63	20.78
5	1	0	QPSK	22.61	22.52	22.57
5	1	12		22.54	22.57	22.36
5	1	24		22.53	22.55	22.51
5	12	0		21.57	21.57	21.61
5	12	7		21.63	21.66	21.58
5	12	13		21.59	21.62	21.72
5	25	0		21.66	21.67	21.60
5	1	0	16-QAM	21.87	21.81	21.83
5	1	12		21.85	21.83	21.73
5	1	24		21.81	21.77	21.71
5	12	0		20.62	20.61	20.61
5	12	7		20.67	20.59	20.63
5	12	13		20.59	20.55	20.63
5	25	0		20.69	20.59	20.55



LTE Band 5 Maximum Average Power [dBm]						
BW [MHz]	RB Size	RB Offset	Mod	Lowest	Middle	Highest
3	1	0	QPSK	22.38	22.56	22.56
3	1	8		22.51	22.48	22.47
3	1	14		22.48	22.41	22.39
3	8	0		21.55	21.54	21.49
3	8	4		21.54	21.55	21.56
3	8	7		21.48	21.48	21.50
3	15	0		21.50	21.58	21.49
3	1	0	16-QAM	21.79	21.70	21.71
3	1	8		21.79	21.78	21.72
3	1	14		21.73	21.68	21.72
3	8	0		20.61	20.62	20.64
3	8	4		20.62	20.61	20.67
3	8	7		20.57	20.54	20.59
3	15	0		20.54	20.61	20.51
1.4	1	0	QPSK	22.48	22.54	22.53
1.4	1	3		22.55	22.58	22.58
1.4	1	5		22.52	22.50	22.46
1.4	3	0		22.46	22.47	22.43
1.4	3	1		22.52	22.48	22.42
1.4	3	3		22.53	22.55	22.49
1.4	6	0		21.56	21.59	21.59
1.4	1	0	16-QAM	21.73	21.72	21.75
1.4	1	3		21.81	21.86	21.80
1.4	1	5		21.75	21.71	21.69
1.4	3	0		21.47	21.50	21.59
1.4	3	1		21.56	21.54	21.57
1.4	3	3		21.54	21.55	21.54
1.4	6	0		20.60	20.70	20.56



LTE Band 7 Maximum Average Power [dBm]						
BW [MHz]	RB Size	RB Offset	Mod	Lowest	Middle	Highest
20	1	0	QPSK	22.23	22.15	22.32
20	1	49		22.29	22.23	22.50
20	1	99		22.32	22.35	22.44
20	50	0		21.42	21.43	21.47
20	50	24		21.38	21.42	21.44
20	50	50		21.41	21.38	21.51
20	100	0		21.37	21.32	21.48
20	1	0	16-QAM	21.65	21.59	21.75
20	1	49		21.70	21.75	21.77
20	1	99		21.66	21.69	21.69
20	50	0		20.41	20.42	20.47
20	50	24		20.36	20.37	20.49
20	50	50		20.40	20.47	20.47
20	100	0		20.36	20.37	20.50
15	1	0	QPSK	22.24	22.16	22.31
15	1	37		22.36	22.39	22.06
15	1	74		22.34	22.47	22.40
15	36	0		21.43	21.39	21.52
15	36	20		21.45	21.41	21.57
15	36	39		21.39	21.50	21.49
15	75	0		21.39	21.38	21.47
15	1	0	16-QAM	21.58	21.53	21.66
15	1	37		21.63	21.63	21.64
15	1	74		21.62	21.66	21.71
15	36	0		20.40	20.39	20.51
15	36	20		20.45	20.45	20.62
15	36	39		20.37	20.48	20.49
15	75	0		20.39	20.40	20.48



LTE Band 7 Maximum Average Power [dBm]						
BW [MHz]	RB Size	RB Offset	Mod	Lowest	Middle	Highest
10	1	0	QPSK	22.56	22.56	22.64
10	1	25		22.37	22.36	22.56
10	1	49		22.60	22.54	<b>22.70</b>
10	25	0		21.47	21.51	21.56
10	25	12		21.54	21.43	21.57
10	25	25		21.42	21.53	21.58
10	50	0		21.44	21.48	21.51
10	1	0	16-QAM	21.83	21.96	22.01
10	1	25		21.62	21.63	21.80
10	1	49		21.80	21.82	21.87
10	25	0		20.49	20.51	20.60
10	25	12		20.55	20.46	20.58
10	25	25		20.42	20.51	20.61
10	50	0		20.48	20.48	20.55
5	1	0	QPSK	22.28	22.31	22.41
5	1	12		22.29	22.32	22.35
5	1	24		22.34	22.42	22.53
5	12	0		21.51	21.50	21.55
5	12	7		21.50	21.42	21.56
5	12	13		21.54	21.44	21.50
5	25	0		21.52	21.45	21.56
5	1	0	16-QAM	21.76	21.65	21.75
5	1	12		21.67	21.58	21.64
5	1	24		21.69	21.69	21.74
5	12	0		20.61	20.57	20.59
5	12	7		20.55	20.45	20.60
5	12	13		20.57	20.47	20.58
5	25	0		20.51	20.46	20.59



LTE Band 12 Maximum Average Power [dBm]						
BW [MHz]	RB Size	RB Offset	Mod	Lowest	Middle	Highest
10	1	0	QPSK	22.19	22.19	22.32
10	1	25		22.47	22.53	22.67
10	1	49		22.19	22.26	22.22
10	25	0		21.44	21.44	21.52
10	25	12		21.50	21.60	21.73
10	25	25		21.49	21.60	21.58
10	50	0		21.48	21.56	21.63
10	1	0	16-QAM	21.42	21.46	21.49
10	1	25		21.87	21.79	21.82
10	1	49		21.50	21.52	21.44
10	25	0		20.43	20.45	20.54
10	25	12		20.53	20.63	20.72
10	25	25		20.52	20.60	20.58
10	50	0		20.45	20.49	20.62
5	1	0	QPSK	22.48	22.62	22.66
5	1	12		22.17	22.29	22.43
5	1	24		22.37	22.66	22.45
5	12	0		21.36	21.65	21.56
5	12	7		21.43	21.65	21.58
5	12	13		21.42	21.65	21.55
5	25	0		21.40	21.65	21.60
5	1	0	16-QAM	21.55	21.80	21.77
5	1	12		21.55	21.78	21.73
5	1	24		21.65	21.96	21.81
5	12	0		20.36	20.63	20.56
5	12	7		20.45	20.64	20.52
5	12	13		20.44	20.69	20.57
5	25	0		20.43	20.65	20.58



LTE Band 12 Maximum Average Power [dBm]						
BW [MHz]	RB Size	RB Offset	Mod	Lowest	Middle	Highest
3	1	0	QPSK	22.44	22.68	22.62
3	1	8		22.35	22.59	22.45
3	1	14		22.37	22.54	22.40
3	8	0		21.41	21.68	21.54
3	8	4		21.39	21.61	21.58
3	8	7		21.40	21.58	21.55
3	15	0		21.38	21.58	21.55
3	1	0	16-QAM	21.54	21.80	21.73
3	1	8		21.58	21.94	21.68
3	1	14		21.62	21.85	21.69
3	8	0		20.46	20.71	20.61
3	8	4		20.39	20.70	20.60
3	8	7		20.45	20.70	20.61
3	15	0		20.36	20.64	20.55
1.4	1	0	QPSK	22.45	22.64	22.57
1.4	1	3		22.37	22.55	22.44
1.4	1	5		22.21	22.54	22.34
1.4	3	0		22.32	22.50	22.44
1.4	3	1		22.35	22.56	22.44
1.4	3	3		22.35	22.53	22.36
1.4	6	0		21.37	21.59	21.50
1.4	1	0	16-QAM	21.53	21.71	21.67
1.4	1	3		21.63	21.81	21.69
1.4	1	5		21.53	21.76	21.75
1.4	3	0		21.36	21.56	21.48
1.4	3	1		21.42	21.61	21.51
1.4	3	3		21.35	21.55	21.42
1.4	6	0		20.46	20.59	20.49



LTE Band 13 Maximum Average Power [dBm]						
BW [MHz]	RB Size	RB Offset	Mod	Lowest	Middle	Highest
10	1	0	QPSK		22.98	
10	1	25			22.80	
10	1	49			<b>23.00</b>	
10	25	0			21.97	
10	25	12			21.80	
10	25	25			21.90	
10	50	0			21.85	
10	1	0	16-QAM		22.12	
10	1	25			21.97	
10	1	49			22.12	
10	25	0			20.87	
10	25	12			20.81	
10	25	25			20.87	
10	50	0			20.96	
5	1	0	QPSK	22.69	22.90	22.87
5	1	12		22.47	22.77	22.75
5	1	24		22.58	22.81	22.69
5	12	0		21.65	21.86	21.87
5	12	7		21.69	21.87	21.94
5	12	13		21.65	21.87	21.82
5	25	0		21.64	21.90	21.88
5	1	0	16-QAM	21.78	22.05	22.00
5	1	12		21.79	22.00	21.94
5	1	24		21.84	22.00	21.88
5	12	0		20.69	20.89	20.79
5	12	7		20.68	20.91	20.87
5	12	13		20.68	20.87	20.79
5	25	0		20.69	20.89	20.83



LTE Band 17 Maximum Average Power [dBm]						
BW [MHz]	RB Size	RB Offset	Mod	Lowest	Middle	Highest
10	1	0	QPSK	22.22	22.31	22.42
10	1	25		22.54	22.66	22.60
10	1	49		22.37	22.39	22.36
10	25	0		21.62	21.42	21.48
10	25	12		21.69	21.71	21.71
10	25	25		21.58	21.62	21.65
10	50	0		21.55	21.52	21.54
10	1	0	16-QAM	21.45	21.46	21.39
10	1	25		21.84	21.87	21.84
10	1	49		21.47	21.45	21.46
10	25	0		20.56	20.49	20.50
10	25	12		20.69	20.73	20.72
10	25	25		20.57	20.54	20.57
10	50	0		20.60	20.59	20.57
5	1	0	QPSK	22.64	22.77	22.74
5	1	12		22.34	22.61	22.53
5	1	24		22.51	22.62	22.51
5	12	0		21.53	21.63	21.65
5	12	7		21.57	21.69	21.75
5	12	13		21.60	21.76	21.65
5	25	0		21.50	21.71	21.73
5	1	0	16-QAM	21.72	21.86	21.90
5	1	12		21.76	21.88	21.78
5	1	24		21.79	21.87	21.82
5	12	0		20.54	20.67	20.64
5	12	7		20.57	20.70	20.71
5	12	13		20.60	20.74	20.67
5	25	0		20.53	20.72	20.72



LTE Band 26 Maximum Average Power [dBm]						
BW [MHz]	RB Size	RB Offset	Mod	Lowest	Middle	Highest
15	1	0	QPSK	23.05	23.00	23.03
15	1	37		22.65	22.78	22.57
15	1	74		23.17	<b>23.19</b>	23.09
15	36	0		21.92	22.05	21.98
15	36	20		21.73	21.77	21.73
15	36	39		21.65	21.49	21.53
15	75	0		21.81	21.77	21.89
15	1	0	16-QAM	22.28	22.18	22.15
15	1	37		21.90	21.96	21.93
15	1	74		22.39	22.39	22.32
15	36	0		20.88	20.98	21.00
15	36	20		20.74	20.62	20.70
15	36	39		20.57	20.55	20.43
15	75	0		20.79	20.70	20.82
10	1	0	QPSK	22.47	22.32	22.51
10	1	25		22.62	22.64	22.68
10	1	49		22.83	22.88	22.92
10	25	0		21.73	21.71	21.87
10	25	12		21.71	21.75	21.80
10	25	25		21.79	21.77	21.94
10	50	0		21.75	21.76	21.86
10	1	0	16-QAM	22.31	22.16	22.30
10	1	25		21.91	21.92	22.00
10	1	49		22.10	22.09	22.19
10	25	0		20.80	20.79	20.85
10	25	12		20.71	20.77	20.80
10	25	25		20.75	20.77	20.79
10	50	0		20.79	20.78	20.87



LTE Band 26 Maximum Average Power [dBm]						
BW [MHz]	RB Size	RB Offset	Mod	Lowest	Middle	Highest
5	1	0	QPSK	22.80	22.77	22.85
5	1	12		22.56	22.58	22.65
5	1	24		22.56	22.64	22.59
5	12	0		21.72	21.69	21.72
5	12	7		21.67	21.71	21.75
5	12	13		21.65	21.68	21.76
5	25	0		21.71	21.71	21.80
5	1	0	16-QAM	21.93	21.93	21.96
5	1	12		21.87	21.89	21.98
5	1	24		21.84	21.86	21.95
5	12	0		20.73	20.72	20.75
5	12	7		20.71	20.63	20.72
5	12	13		20.69	20.59	20.79
5	25	0		20.71	20.62	20.73
3	1	0	QPSK	22.73	22.75	22.76
3	1	8		22.64	22.67	22.55
3	1	14		22.60	22.60	22.61
3	8	0		21.66	21.70	21.67
3	8	4		21.71	21.65	21.73
3	8	7		21.61	21.60	21.73
3	15	0		21.66	21.60	21.76
3	1	0	16-QAM	21.88	21.77	21.91
3	1	8		21.94	21.82	21.98
3	1	14		21.88	21.74	21.83
3	8	0		20.70	20.66	20.76
3	8	4		20.78	20.67	20.79
3	8	7		20.67	20.64	20.75
3	15	0		20.71	20.63	20.70



LTE Band 26 Maximum Average Power [dBm]						
BW [MHz]	RB Size	RB Offset	Mod	Lowest	Middle	Highest
1.4	1	0	QPSK	22.72	22.70	22.73
1.4	1	3		22.57	22.62	22.61
1.4	1	5		22.54	22.55	22.57
1.4	3	0		22.57	22.61	22.52
1.4	3	1		22.64	22.62	22.59
1.4	3	3		22.55	22.62	22.64
1.4	6	0		21.57	21.67	21.59
1.4	1	0	16-QAM	21.83	21.82	21.85
1.4	1	3		21.84	21.92	22.01
1.4	1	5		21.77	21.83	21.90
1.4	3	0		21.62	21.64	21.64
1.4	3	1		21.71	21.67	21.66
1.4	3	3		21.55	21.59	21.66
1.4	6	0		20.61	20.72	20.72



LTE Band 38 Maximum Average Power [dBm]						
BW [MHz]	RB Size	RB Offset	Mod	Lowest	Middle	Highest
20	1	0	QPSK	22.24	22.15	22.12
20	1	49		22.22	22.44	22.23
20	1	99		22.62	22.33	22.39
20	50	0		21.42	21.34	21.05
20	50	24		21.42	21.43	21.34
20	50	50		21.48	21.10	21.00
20	100	0		21.43	21.07	21.08
20	1	0	16-QAM	21.29	21.22	21.18
20	1	49		21.58	21.55	21.23
20	1	99		21.61	21.54	21.27
20	50	0		20.47	20.28	20.28
20	50	24		20.46	20.61	20.39
20	50	50		20.36	20.44	20.28
20	100	0		20.45	20.52	20.25
15	1	0	QPSK	22.15	22.20	22.12
15	1	37		22.29	22.32	22.16
15	1	74		22.55	22.59	22.27
15	36	0		21.30	21.19	21.16
15	36	20		21.53	21.49	21.32
15	36	39		21.47	21.38	21.32
15	75	0		21.28	21.35	21.23
15	1	0	16-QAM	21.30	21.19	21.10
15	1	37		21.47	21.59	21.06
15	1	74		21.76	21.97	21.61
15	36	0		20.18	20.20	20.19
15	36	20		20.39	20.44	20.29
15	36	39		20.38	20.43	20.34
15	75	0		20.42	20.45	20.24



LTE Band 38 Maximum Average Power [dBm]						
BW [MHz]	RB Size	RB Offset	Mod	Lowest	Middle	Highest
10	1	0	QPSK	22.41	22.27	22.49
10	1	25		22.44	22.54	22.50
10	1	49		<b>22.75</b>	22.68	22.64
10	25	0		21.61	21.55	21.52
10	25	12		21.64	21.60	21.48
10	25	25		21.74	21.56	21.47
10	50	0		21.60	21.63	21.55
10	1	0	16-QAM	21.89	21.58	21.53
10	1	25		21.69	21.69	21.49
10	1	49		22.08	21.85	21.70
10	25	0		20.63	20.65	20.37
10	25	12		20.54	20.68	20.40
10	25	25		20.70	20.62	20.40
10	50	0		20.65	20.73	20.44
5	1	0	QPSK	22.64	22.62	22.39
5	1	12		22.52	22.58	22.11
5	1	24		22.60	22.50	22.31
5	12	0		21.73	21.60	21.47
5	12	7		21.66	21.64	21.52
5	12	13		21.59	21.62	21.48
5	25	0		21.66	21.66	21.49
5	1	0	16-QAM	21.76	21.72	21.17
5	1	12		21.86	21.87	21.34
5	1	24		21.67	21.64	21.45
5	12	0		20.62	20.60	20.44
5	12	7		20.61	20.51	20.34
5	12	13		20.60	20.65	20.32
5	25	0		20.65	20.68	20.40



LTE Band 41 Maximum Average Power [dBm]						
BW [MHz]	RB Size	RB Offset	Mod	Lowest	Middle	Highest
20	1	0	QPSK	22.07	22.02	22.08
20	1	49		22.33	22.28	22.31
20	1	99		22.47	22.57	22.44
20	50	0		21.52	21.50	21.38
20	50	24		21.43	21.42	21.36
20	50	50		21.48	21.52	21.54
20	100	0		21.54	21.45	21.43
20	1	0	16-QAM	21.85	21.27	21.46
20	1	49		21.61	21.41	21.55
20	1	99		21.30	21.75	21.33
20	50	0		20.49	20.52	20.39
20	50	24		20.46	20.42	20.29
20	50	50		20.51	20.56	20.53
20	100	0		20.54	20.46	20.49
15	1	0	QPSK	22.42	22.32	22.25
15	1	37		22.63	22.32	22.04
15	1	74		22.51	22.64	22.52
15	36	0		21.46	21.51	21.37
15	36	20		21.51	21.47	21.27
15	36	39		21.49	21.19	21.32
15	75	0		21.52	21.10	21.32
15	1	0	16-QAM	22.00	21.29	21.47
15	1	37		21.93	21.11	21.23
15	1	74		21.65	21.75	21.87
15	36	0		20.44	20.50	20.36
15	36	20		20.46	20.35	20.20
15	36	39		20.45	20.51	20.37
15	75	0		20.57	20.52	20.41



LTE Band 41 Maximum Average Power [dBm]						
BW [MHz]	RB Size	RB Offset	Mod	Lowest	Middle	Highest
10	1	0	QPSK	22.47	22.49	22.33
10	1	25		22.46	22.41	22.29
10	1	49		22.62	<b>22.79</b>	22.55
10	25	0		21.66	21.53	21.43
10	25	12		21.63	21.46	21.39
10	25	25		21.62	21.64	21.45
10	50	0		21.58	21.40	21.37
10	1	0	16-QAM	21.71	21.75	21.60
10	1	25		21.54	21.51	21.47
10	1	49		21.67	21.63	21.83
10	25	0		20.60	20.52	20.47
10	25	12		20.59	20.51	20.28
10	25	25		20.57	20.34	20.45
10	50	0		20.54	20.53	20.40
5	1	0	QPSK	22.37	22.42	22.24
5	1	12		22.40	22.33	22.38
5	1	24		22.44	22.50	22.31
5	12	0		21.58	21.51	21.40
5	12	7		21.53	21.42	21.42
5	12	13		21.49	21.51	21.35
5	25	0		21.61	21.47	21.38
5	1	0	16-QAM	21.58	21.58	21.52
5	1	12		21.73	21.66	21.78
5	1	24		21.42	21.61	21.46
5	12	0		20.48	20.51	20.46
5	12	7		20.49	20.49	20.32
5	12	13		20.40	20.51	20.22
5	25	0		20.54	20.37	20.43



LTE Band 66 Maximum Average Power [dBm]						
BW [MHz]	RB Size	RB Offset	Mod	Lowest	Middle	Highest
20	1	0	QPSK	22.28	22.69	22.83
20	1	49		22.48	22.70	22.84
20	1	99		22.50	22.84	23.00
20	50	0		21.51	21.69	21.84
20	50	24		21.51	21.75	21.94
20	50	50		21.55	21.81	21.97
20	100	0		21.49	21.71	21.89
20	1	0	16-QAM	21.66	21.83	22.06
20	1	49		21.66	21.93	22.17
20	1	99		21.71	21.94	22.14
20	50	0		20.45	20.64	20.84
20	50	24		20.52	20.75	20.93
20	50	50		20.57	20.78	20.97
20	100	0		20.54	20.74	20.90
15	1	0	QPSK	22.87	23.13	23.31
15	1	37		22.48	22.82	23.28
15	1	74		22.82	23.01	23.07
15	36	0		21.63	21.86	22.04
15	36	20		21.52	21.78	21.94
15	36	39		21.54	21.76	21.94
15	75	0		21.55	21.77	21.97
15	1	0	16-QAM	22.08	22.25	22.54
15	1	37		21.71	21.89	22.14
15	1	74		21.96	22.16	22.34
15	36	0		20.58	20.84	21.02
15	36	20		20.53	20.76	20.97
15	36	39		20.52	20.75	20.87
15	75	0		20.53	20.82	20.98



LTE Band 66 Maximum Average Power [dBm]						
BW [MHz]	RB Size	RB Offset	Mod	Lowest	Middle	Highest
10	1	0	QPSK	22.13	22.41	22.66
10	1	25		22.70	23.10	23.15
10	1	49		23.23	<b>23.48</b>	23.17
10	25	0		21.60	21.86	22.06
10	25	12		21.71	22.00	22.18
10	25	25		21.78	22.05	22.24
10	50	0		21.72	21.96	22.14
10	1	0	16-QAM	21.32	21.57	21.81
10	1	25		21.85	22.12	22.34
10	1	49		22.36	22.59	22.76
10	25	0		20.63	20.85	21.05
10	25	12		20.73	20.97	21.16
10	25	25		20.75	21.00	21.20
10	50	0		20.71	20.95	21.16
5	1	0	QPSK	22.59	23.00	23.07
5	1	12		22.66	22.89	23.11
5	1	24		22.69	22.91	23.06
5	12	0		21.74	22.00	22.16
5	12	7		21.72	21.96	22.12
5	12	13		21.71	21.90	22.10
5	25	0		21.78	21.95	22.14
5	1	0	16-QAM	22.10	22.37	22.48
5	1	12		21.90	22.11	22.35
5	1	24		21.96	22.16	22.33
5	12	0		20.76	20.99	21.20
5	12	7		20.75	20.98	21.14
5	12	13		20.65	20.94	21.12
5	25	0		20.63	20.95	21.14



LTE Band 66 Maximum Average Power [dBm]						
BW [MHz]	RB Size	RB Offset	Mod	Lowest	Middle	Highest
3	1	0	QPSK	22.49	22.98	22.97
3	1	8		22.62	22.88	23.11
3	1	14		22.55	22.92	23.08
3	8	0		21.63	21.90	22.15
3	8	4		21.61	21.94	22.10
3	8	7		21.59	21.87	22.11
3	15	0		21.59	21.89	22.13
3	1	0	16-QAM	21.91	22.21	22.36
3	1	8		21.89	22.24	22.54
3	1	14		21.89	22.13	22.40
3	8	0		20.67	20.96	21.17
3	8	4		20.66	20.96	21.18
3	8	7		20.63	20.95	21.16
3	15	0		20.63	20.95	21.14
1.4	1	0	QPSK	22.61	22.92	23.12
1.4	1	3		22.65	22.98	23.20
1.4	1	5		22.57	22.90	23.17
1.4	3	0		22.56	22.88	23.12
1.4	3	1		22.62	22.94	23.14
1.4	3	3		22.58	22.88	23.12
1.4	6	0		21.58	21.86	22.09
1.4	1	0	16-QAM	21.80	22.15	22.42
1.4	1	3		21.88	22.26	22.40
1.4	1	5		21.82	22.13	22.45
1.4	3	0		21.57	21.87	22.10
1.4	3	1		21.62	21.90	22.13
1.4	3	3		21.55	21.86	22.08
1.4	6	0		20.62	20.97	21.16



## LTE Band 2

### Peak-to-Average Ratio

Mode	LTE Band 2 / 20MHz				
Mod.	QPSK		16QAM		Limit: 13dB
RB Size	1RB	Full RB	1RB	Full RB	Result
Lowest CH	3.45	4.78	4.55	5.88	<b>PASS</b>
Middle CH	3.39	5.01	4.38	6.03	
Highest CH	3.48	4.9	4.14	5.77	



LTE Band 2 / 20MHz / QPSK

Lowest Channel / 1RB

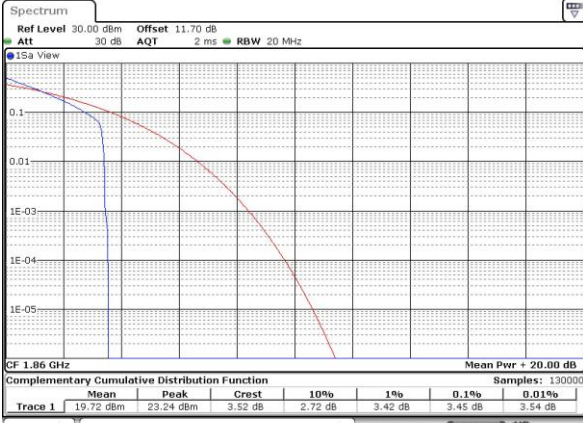

Date: 20 FEB 2017 11:01:01

Lowest Channel / Full RB

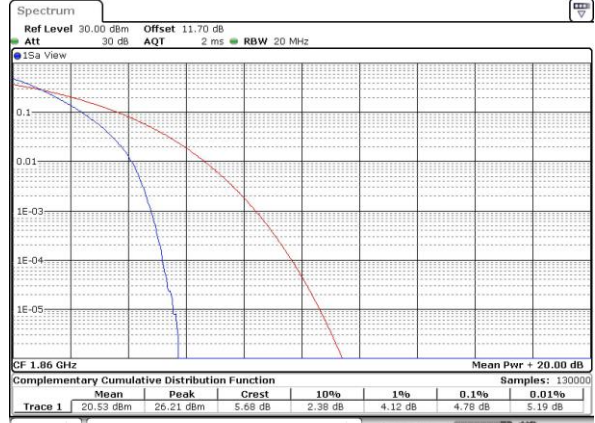

Date: 20 FEB 2017 11:01:10

Middle Channel / 1RB

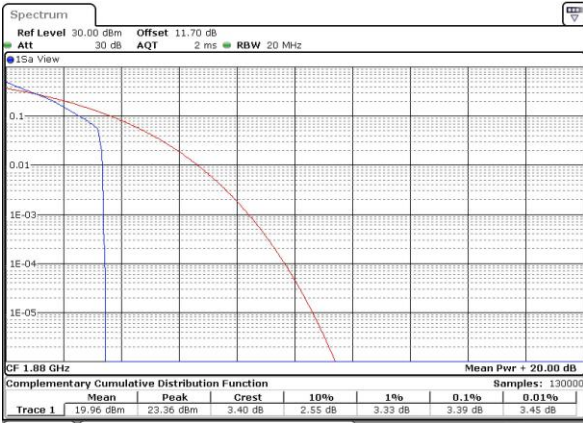

Date: 20 FEB 2017 11:01:20

Middle Channel / Full RB

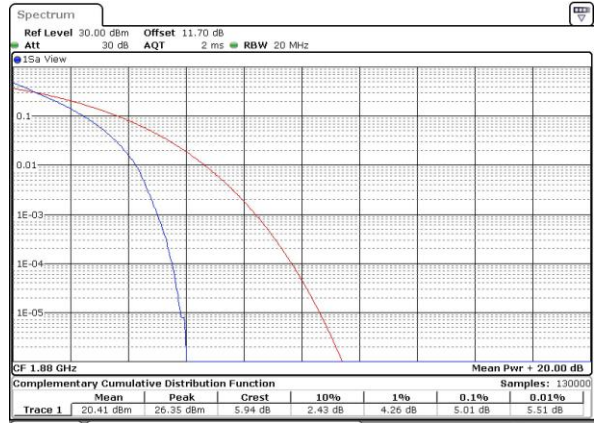

Date: 20 FEB 2017 11:01:29

Highest Channel / 1RB



Date: 20 FEB 2017 11:01:39

Highest Channel / Full RB

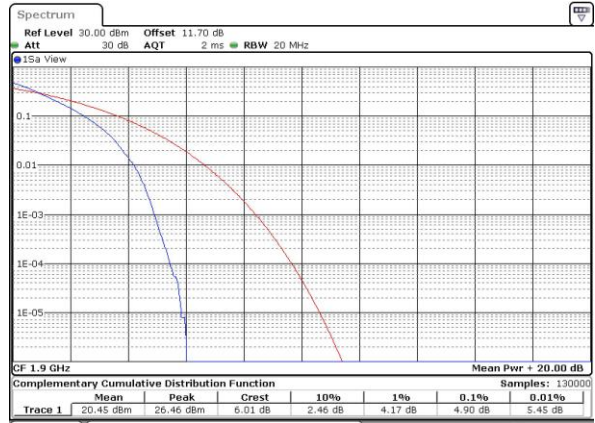

Date: 20 FEB 2017 11:01:52



LTE Band 2 / 20MHz / 16QAM

Lowest Channel / 1RB



Date: 20 FEB 2017 11:00:02

Lowest Channel / Full RB

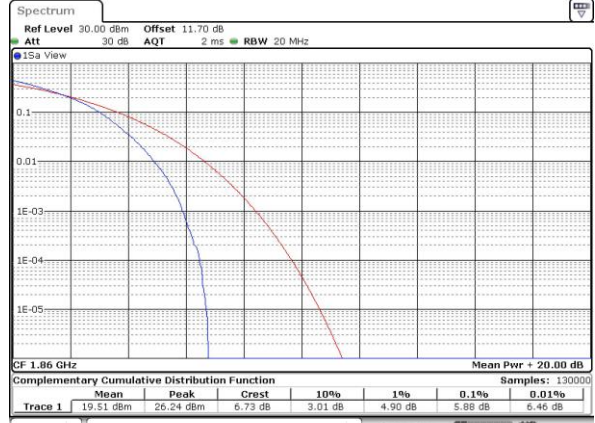

Date: 20 FEB 2017 11:00:13

Middle Channel / 1RB



Date: 20 FEB 2017 11:00:23

Middle Channel / Full RB

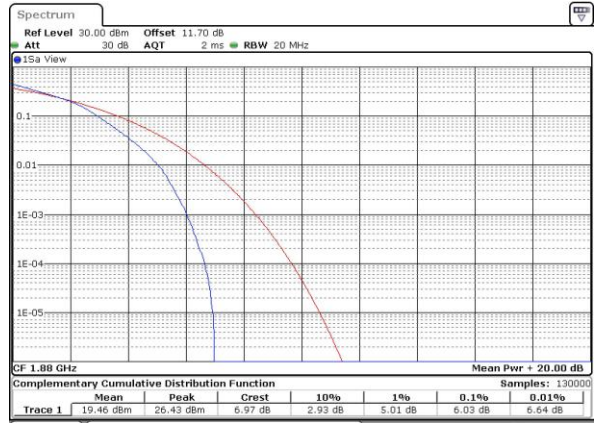

Date: 20 FEB 2017 11:00:33

Highest Channel / 1RB

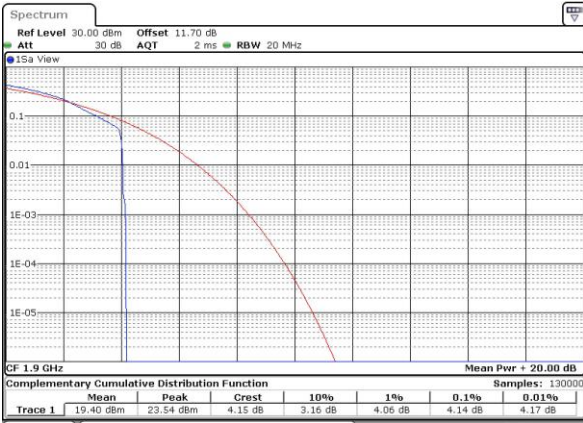

Date: 20 FEB 2017 11:00:43

Highest Channel / Full RB

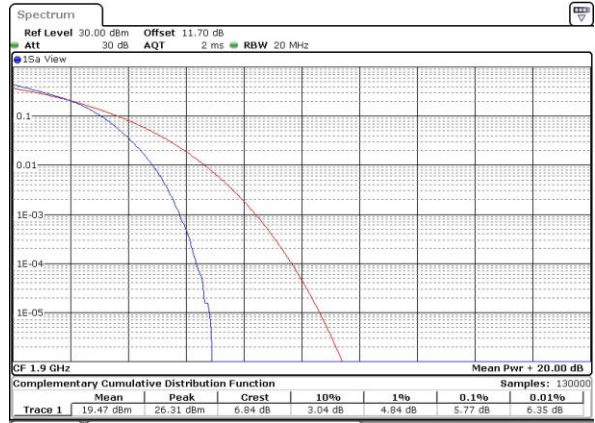

Date: 20 FEB 2017 11:00:52



**26dB Bandwidth**

Mode	LTE Band 2 : 26dB BW(MHz)											
	1.4MHz		3MHz		5MHz		10MHz		15MHz		20MHz	
BW												
Mod.	QPSK	16QAM	QPSK	16QAM	QPSK	16QAM	QPSK	16QAM	QPSK	16QAM	QPSK	16QAM
Lowest CH	1.28	1.30	3.00	3.05	4.90	4.93	9.93	9.99	14.57	14.66	20.06	20.18
Middle CH	1.29	1.28	3.02	3.00	4.99	4.89	9.71	9.83	14.30	14.66	20.34	20.42
Highest CH	1.29	1.28	3.02	2.99	4.93	4.85	9.93	9.91	14.15	14.42	20.26	20.10



LTE Band 2

Lowest Channel / 1.4MHz / QPSK

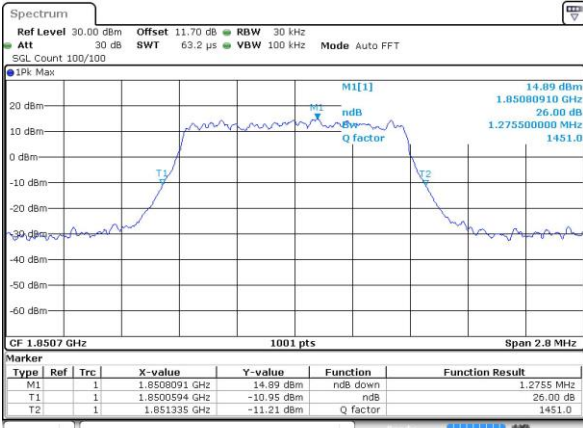

Date: 20 FEB 2017 10:42:39

Lowest Channel / 1.4MHz / 16QAM

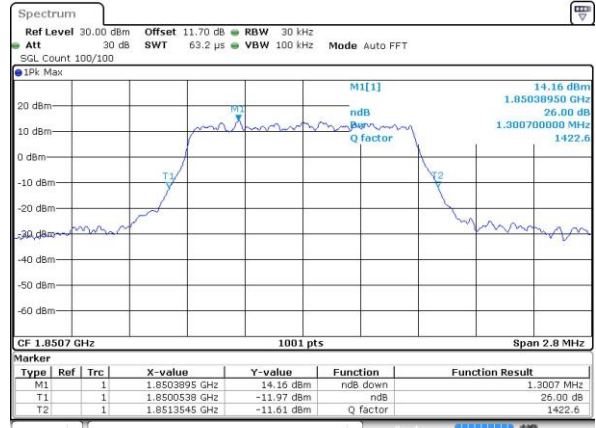

Date: 20 FEB 2017 10:42:50

Middle Channel / 1.4MHz / QPSK

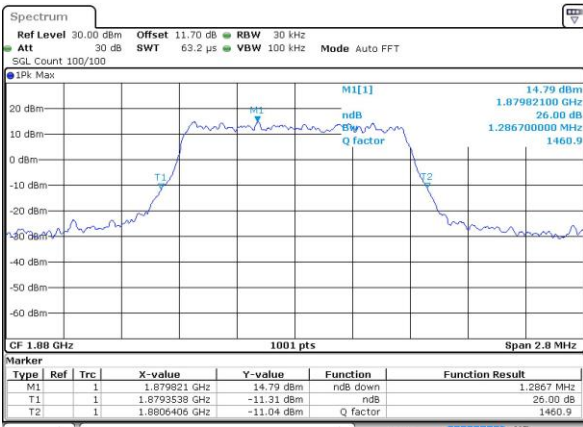

Date: 20 FEB 2017 10:49:47

Middle Channel / 1.4MHz / 16QAM

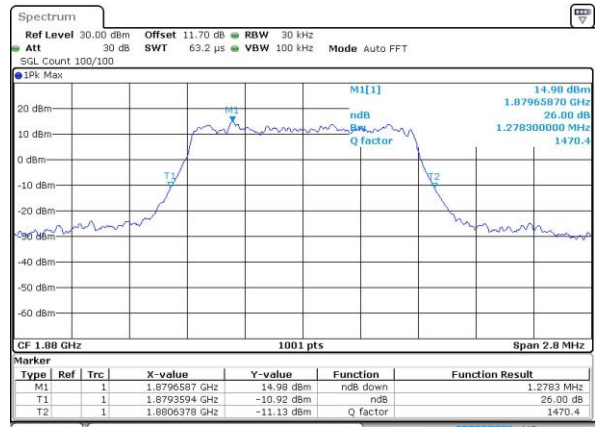

Date: 20 FEB 2017 10:49:57

Highest Channel / 1.4MHz / QPSK

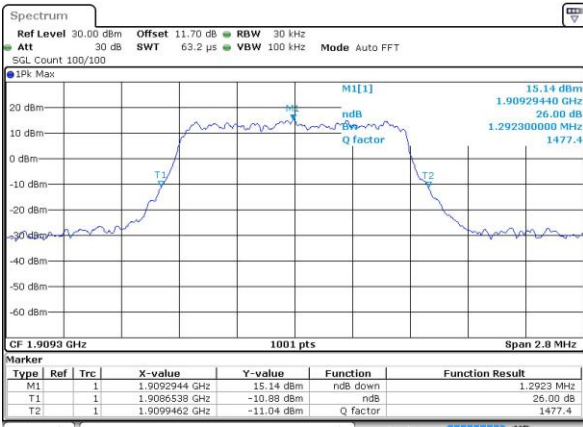

Date: 20 FEB 2017 10:52:17

Highest Channel / 1.4MHz / 16QAM

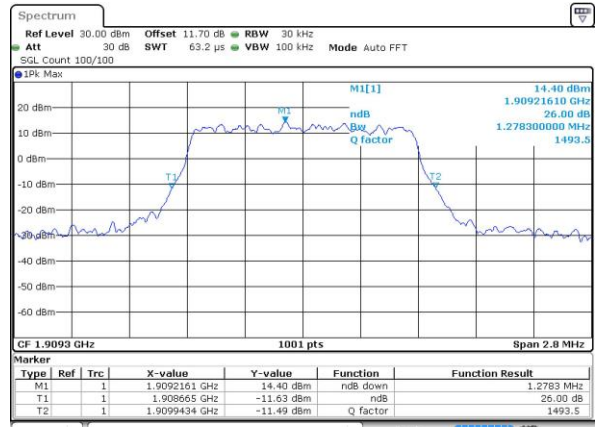

Date: 20 FEB 2017 10:52:27



LTE Band 2

Lowest Channel / 3MHz / QPSK

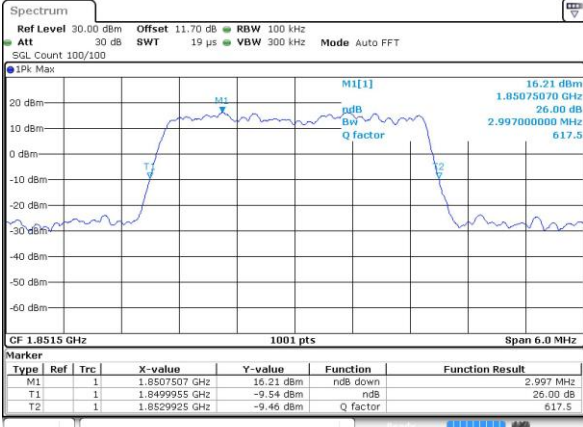

Date: 20 FEB 2017 09:13:14

Lowest Channel / 3MHz / 16QAM

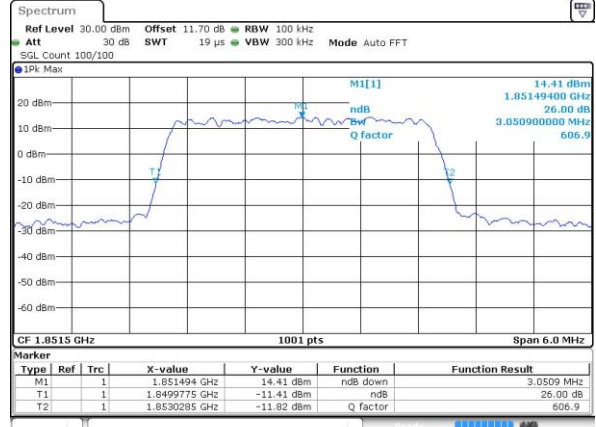

Date: 20 FEB 2017 09:13:25

Middle Channel / 3MHz / QPSK

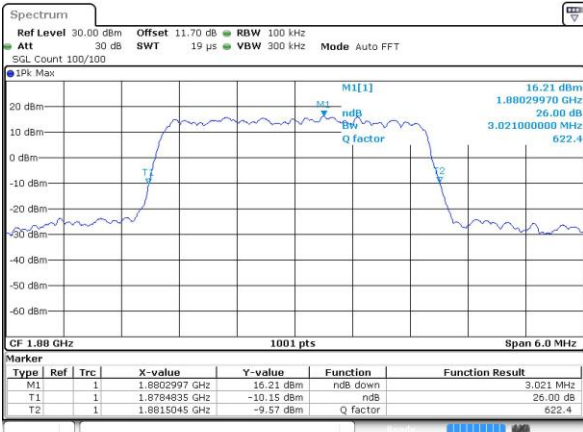

Date: 20 FEB 2017 09:20:22

Middle Channel / 3MHz / 16QAM

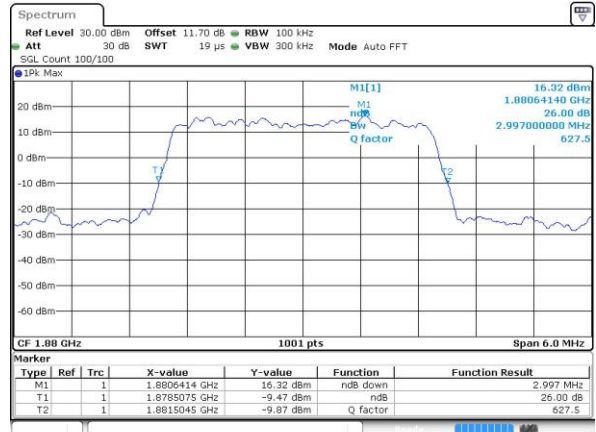

Date: 20 FEB 2017 09:20:32

Highest Channel / 3MHz / QPSK



Date: 20 FEB 2017 09:22:53

Highest Channel / 3MHz / 16QAM

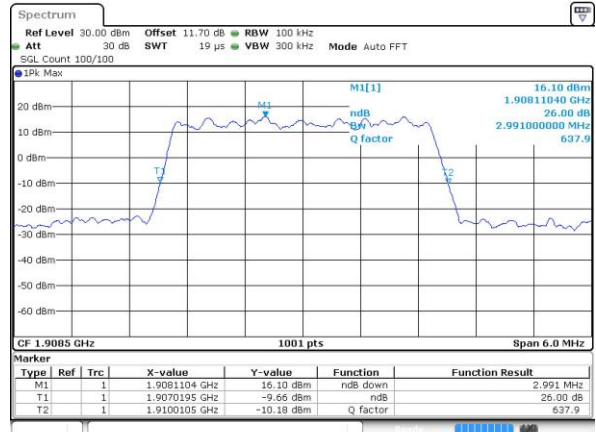

Date: 20 FEB 2017 09:23:03



LTE Band 2

Lowest Channel / 5MHz / QPSK

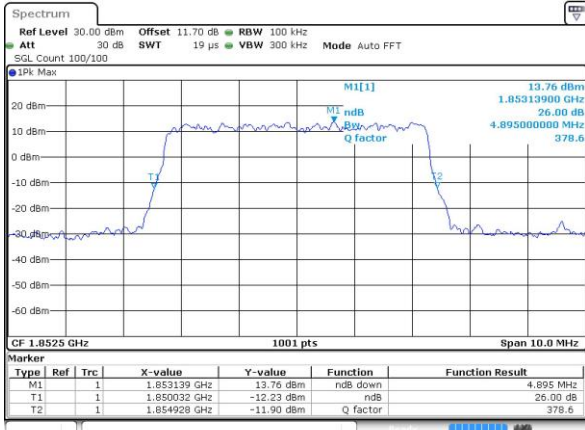

Date: 20 FEB 2017 09:30:04

Lowest Channel / 5MHz / 16QAM

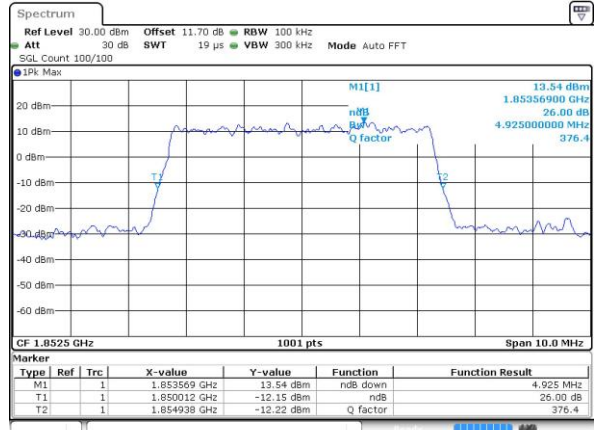

Date: 20 FEB 2017 09:30:15

Middle Channel / 5MHz / QPSK

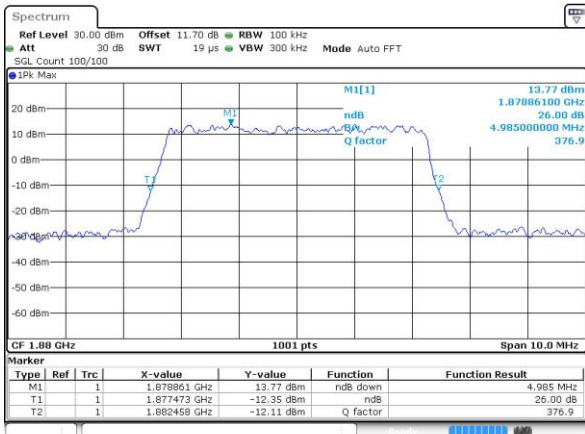

Date: 20 FEB 2017 09:37:17

Middle Channel / 5MHz / 16QAM

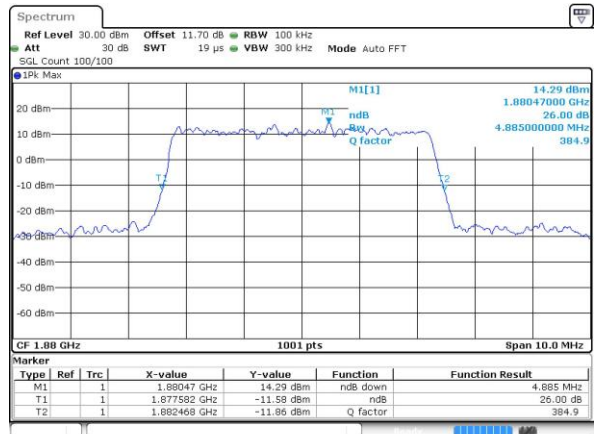

Date: 20 FEB 2017 09:37:27

Highest Channel / 5MHz / QPSK

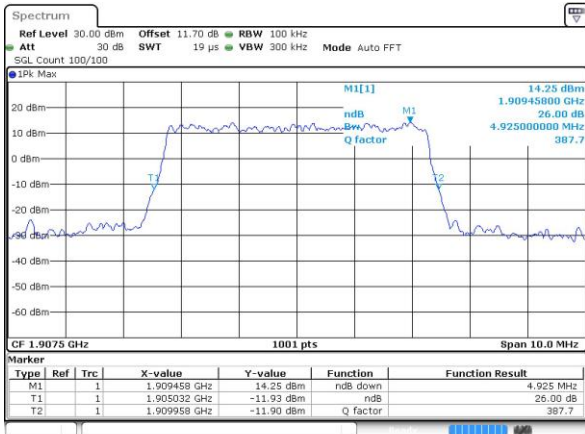

Date: 20 FEB 2017 09:39:51

Highest Channel / 5MHz / 16QAM

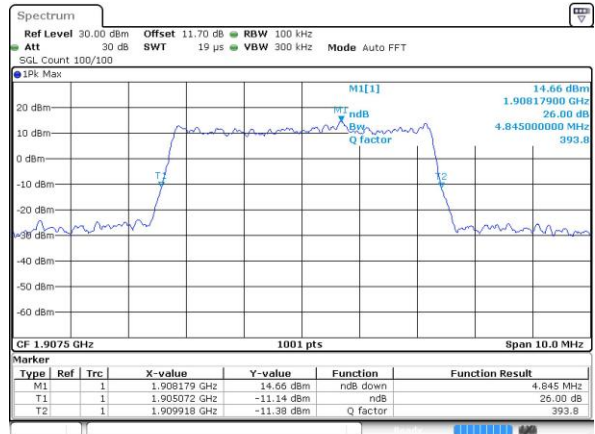

Date: 20 FEB 2017 09:40:02



LTE Band 2

Lowest Channel / 10MHz / QPSK

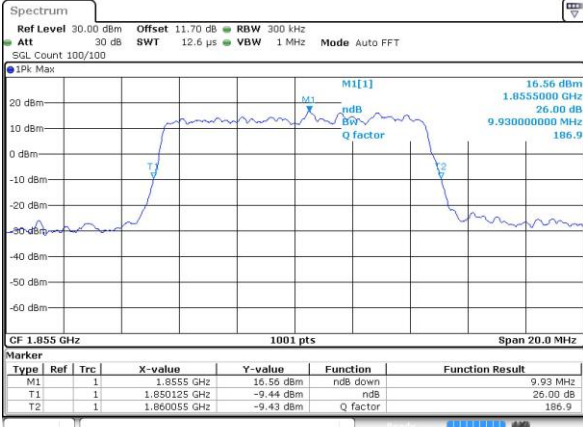

Date: 20 FEB 2017 09:46:58

Lowest Channel / 10MHz / 16QAM

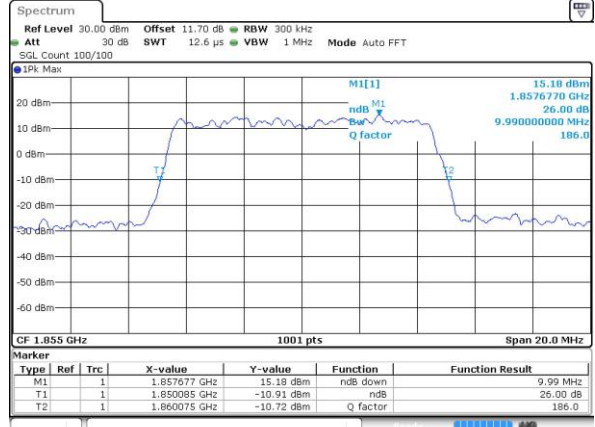

Date: 20 FEB 2017 09:47:09

Middle Channel / 10MHz / QPSK



Date: 20 FEB 2017 09:54:05

Middle Channel / 10MHz / 16QAM

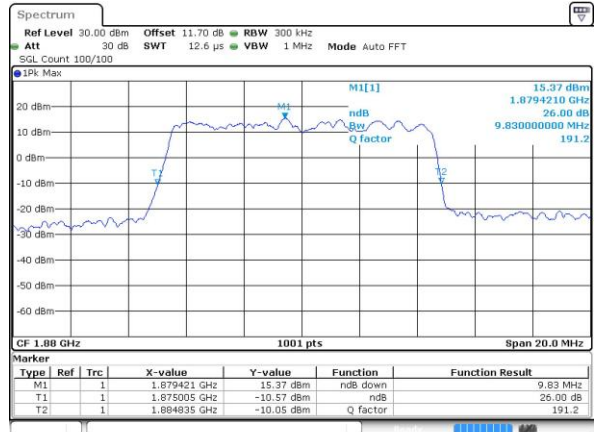

Date: 20 FEB 2017 09:54:16

Highest Channel / 10MHz / QPSK

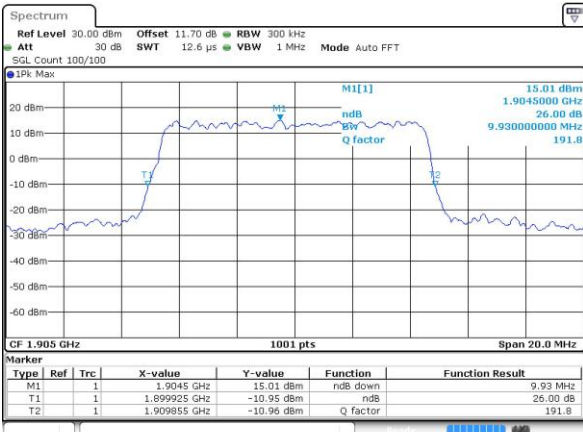

Date: 20 FEB 2017 09:56:36

Highest Channel / 10MHz / 16QAM

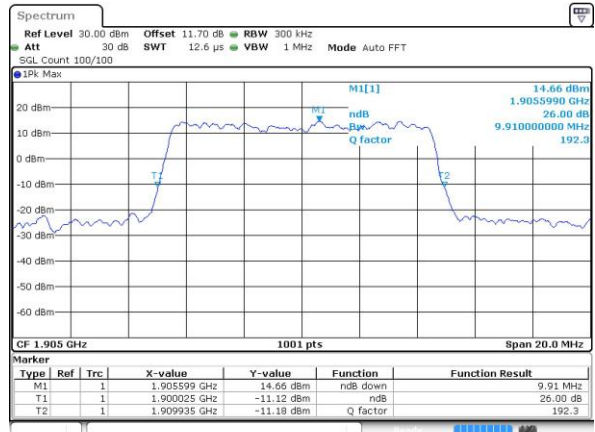

Date: 20 FEB 2017 09:56:46



LTE Band 2

Lowest Channel / 15MHz / QPSK

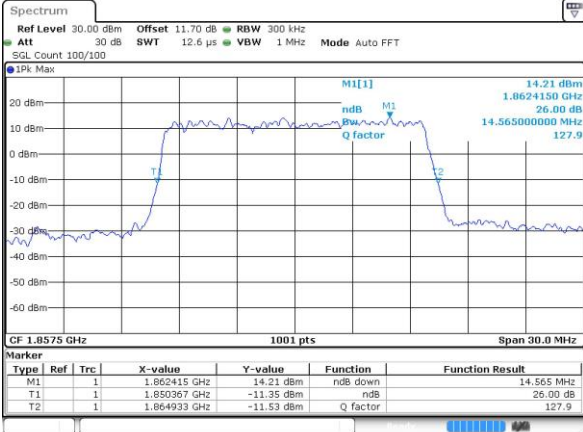

Date: 20 FEB 2017 10:03:50

Lowest Channel / 15MHz / 16QAM

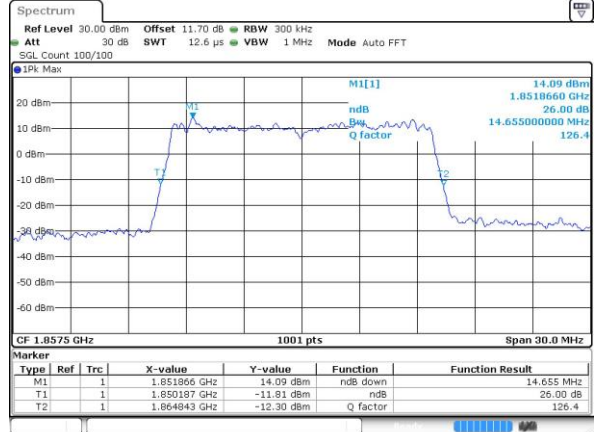

Date: 20 FEB 2017 10:04:01

Middle Channel / 15MHz / QPSK

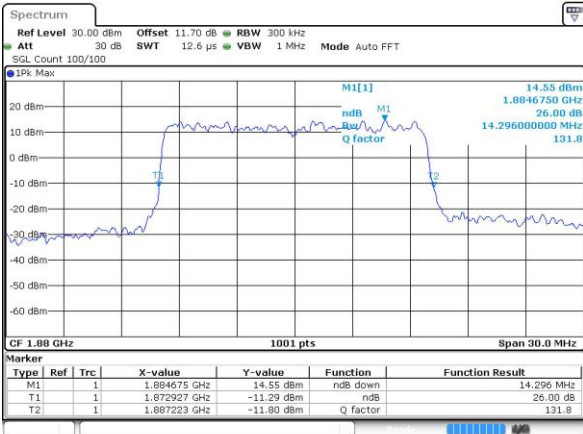

Date: 20 FEB 2017 10:11:01

Middle Channel / 15MHz / 16QAM

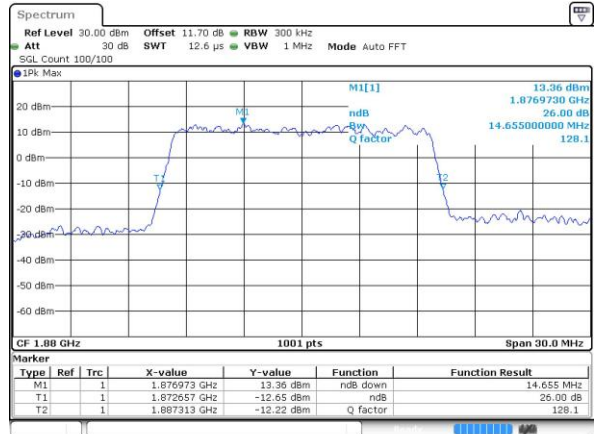

Date: 20 FEB 2017 10:11:11

Highest Channel / 15MHz / QPSK

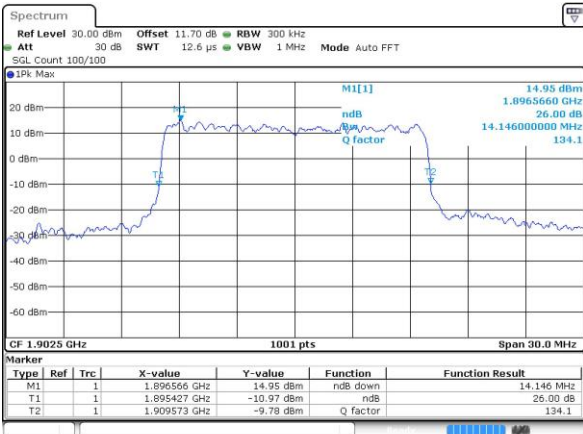

Date: 20 FEB 2017 10:13:31

Highest Channel / 15MHz / 16QAM

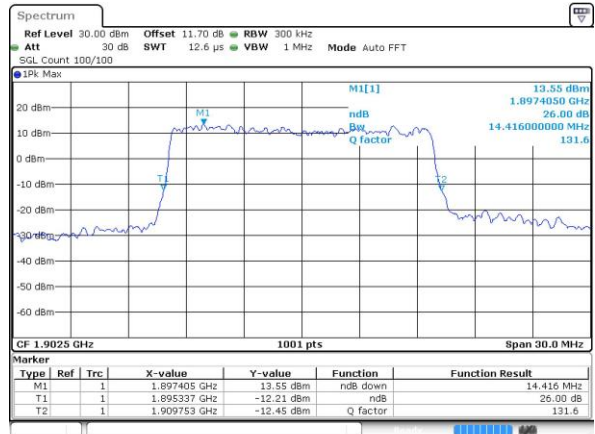

Date: 20 FEB 2017 10:13:42



LTE Band 2

Lowest Channel / 20MHz / QPSK

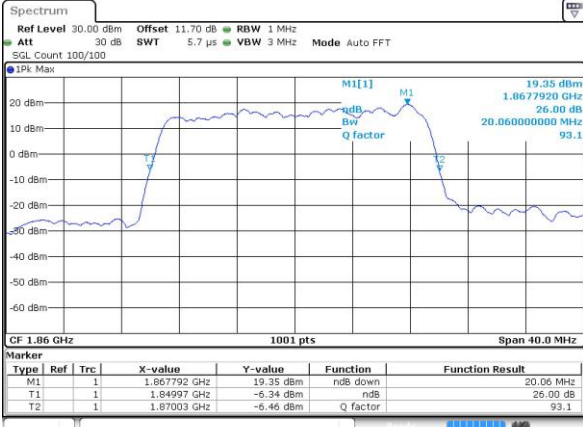

Date: 20 FEB 2017 10:20:39

Lowest Channel / 20MHz / 16QAM

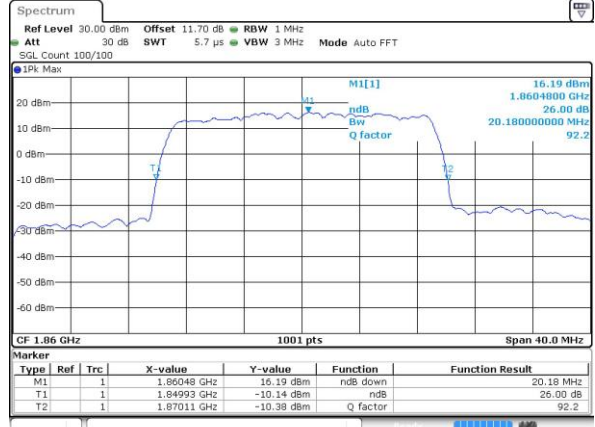

Date: 20 FEB 2017 10:20:50

Middle Channel / 20MHz / QPSK

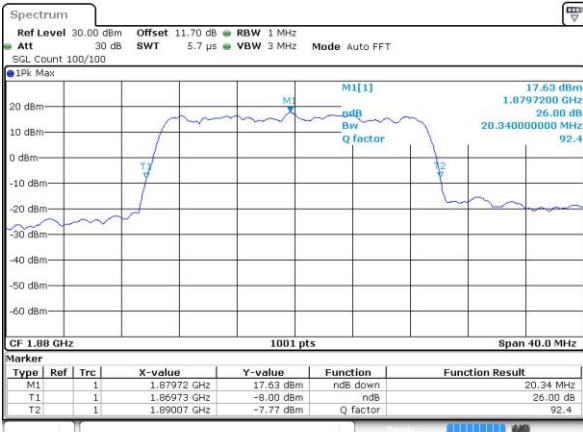

Date: 20 FEB 2017 10:27:48

Middle Channel / 20MHz / 16QAM

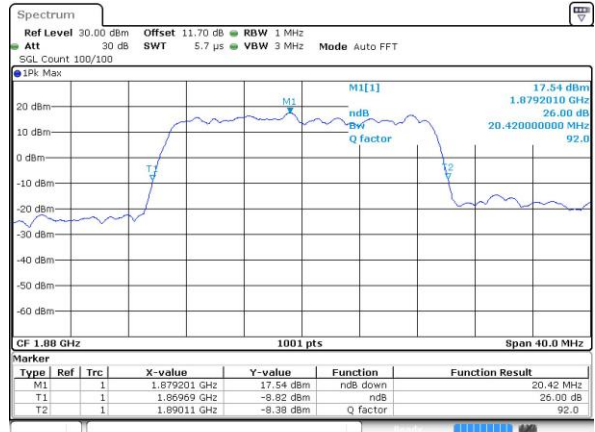

Date: 20 FEB 2017 10:27:57

Highest Channel / 20MHz / QPSK

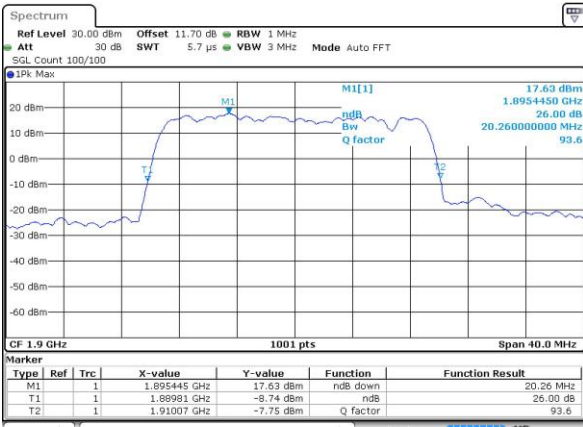

Date: 20 FEB 2017 10:30:17

Highest Channel / 20MHz / 16QAM

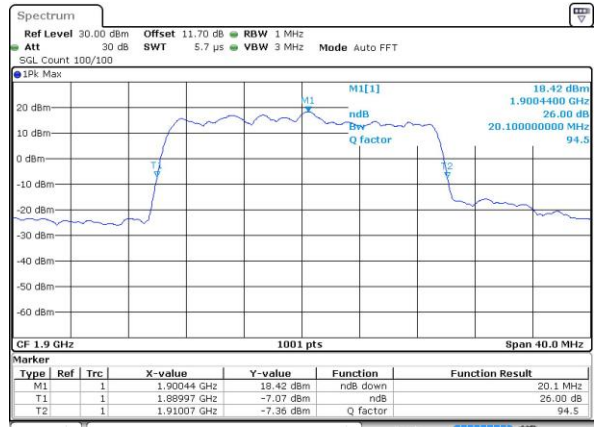

Date: 20 FEB 2017 10:30:27



### Occupied Bandwidth

Mode	LTE Band 2 : 99%OBW(MHz)											
	1.4MHz		3MHz		5MHz		10MHz		15MHz		20MHz	
BW	QPSK	16QAM	QPSK	16QAM	QPSK	16QAM	QPSK	16QAM	QPSK	16QAM	QPSK	16QAM
Lowest CH	1.09	1.1	2.71	2.72	4.52	4.48	9.05	9.03	13.49	13.49	18.26	18.46
Middle CH	1.09	1.1	2.72	2.71	4.5	4.51	9.01	9.03	13.43	13.46	18.46	18.54
Highest CH	1.09	1.09	2.71	2.71	4.52	4.5	9.07	9.05	13.4	13.49	18.34	18.5



LTE Band 2

Lowest Channel / 1.4MHz / QPSK

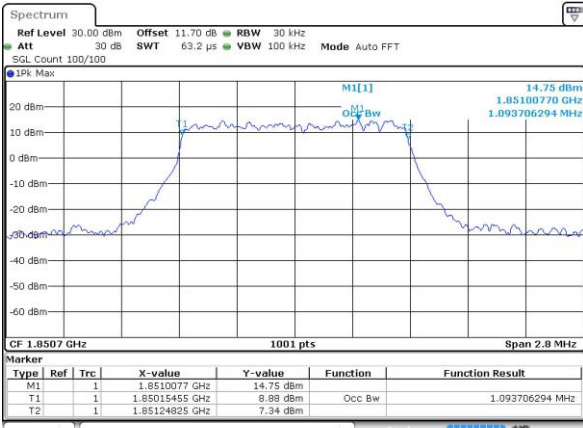

Date: 20 FEB 2017 10:42:19

Lowest Channel / 1.4MHz / 16QAM

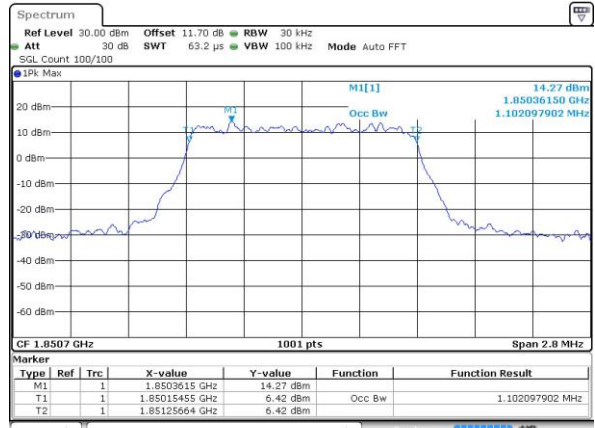

Date: 20 FEB 2017 10:42:29

Middle Channel / 1.4MHz / QPSK

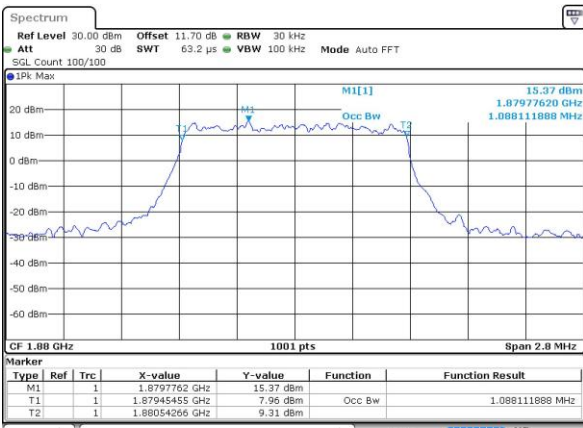

Date: 20 FEB 2017 10:49:28

Middle Channel / 1.4MHz / 16QAM

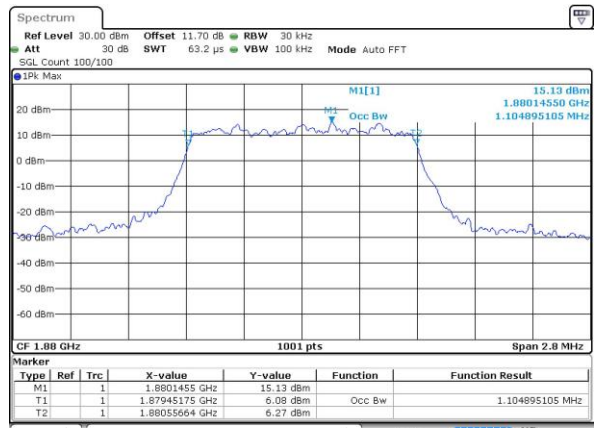

Date: 20 FEB 2017 10:49:38

Highest Channel / 1.4MHz / QPSK

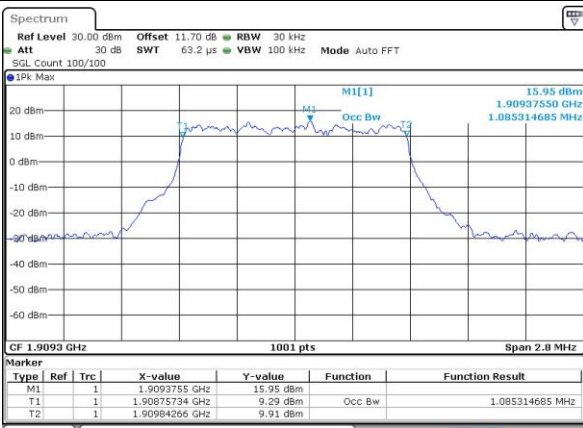

Date: 20 FEB 2017 10:51:56

Highest Channel / 1.4MHz / 16QAM

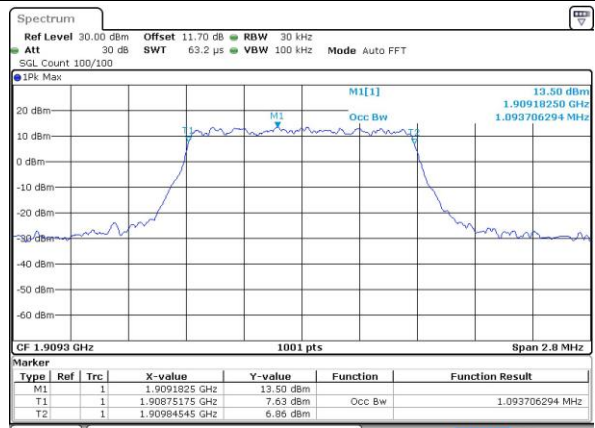

Date: 20 FEB 2017 10:52:07



LTE Band 2

Lowest Channel / 3MHz / QPSK

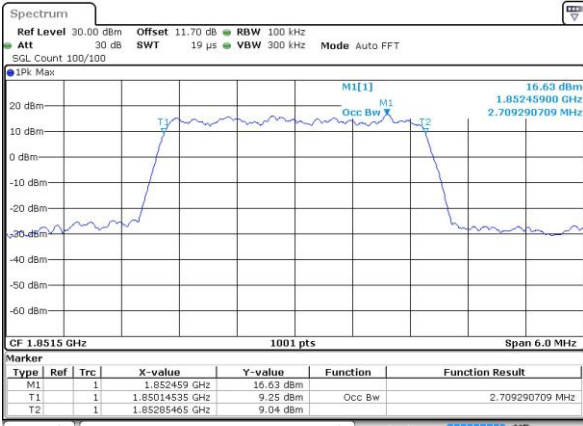

Date: 20 FEB 2017 09:12:53

Lowest Channel / 3MHz / 16QAM

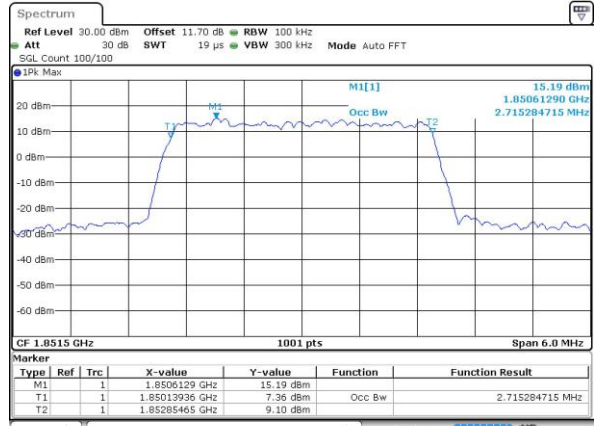

Date: 20 FEB 2017 09:13:04

Middle Channel / 3MHz / QPSK

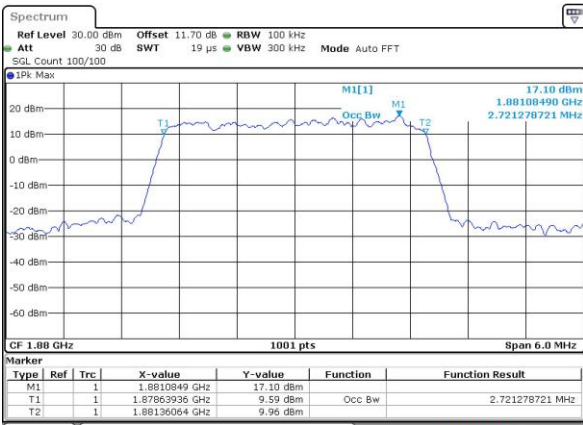

Date: 20 FEB 2017 09:20:01

Middle Channel / 3MHz / 16QAM

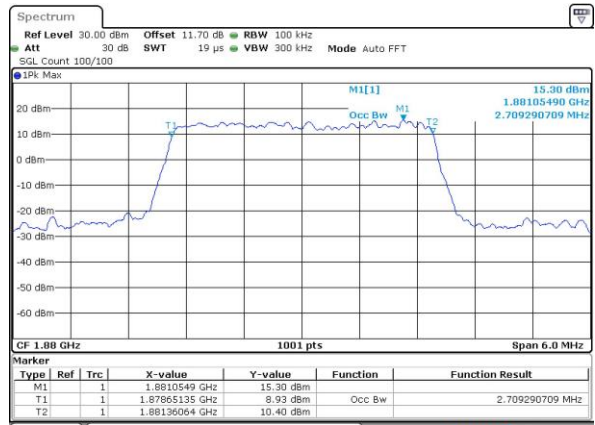

Date: 20 FEB 2017 09:20:12

Highest Channel / 3MHz / QPSK

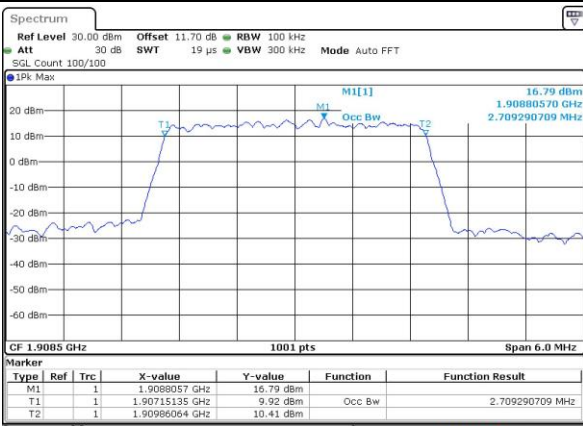

Date: 20 FEB 2017 09:22:32

Highest Channel / 3MHz / 16QAM

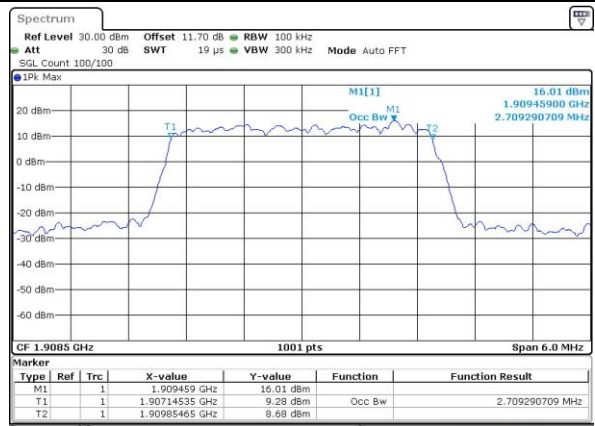

Date: 20 FEB 2017 09:22:42



LTE Band 2

Lowest Channel / 5MHz / QPSK

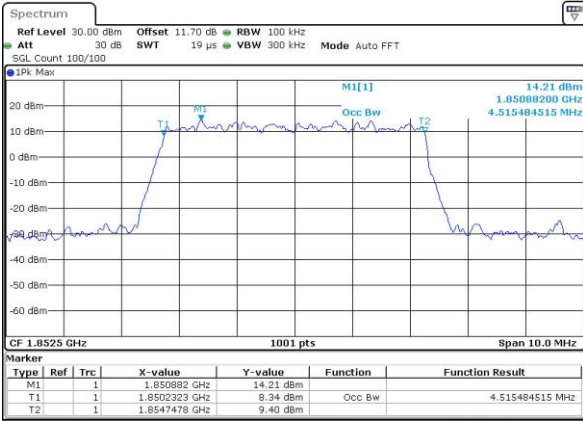

Date: 20 FEB 2017 09:29:43

Lowest Channel / 5MHz / 16QAM

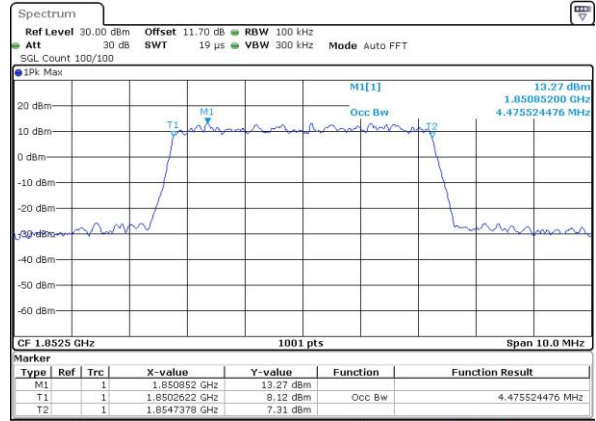

Date: 20 FEB 2017 09:29:54

Middle Channel / 5MHz / QPSK

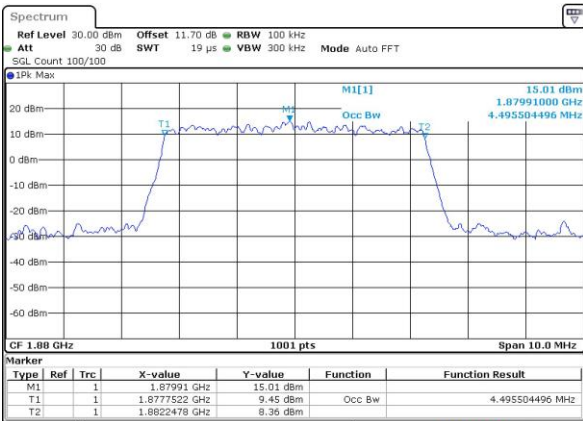

Date: 20 FEB 2017 09:36:55

Middle Channel / 5MHz / 16QAM

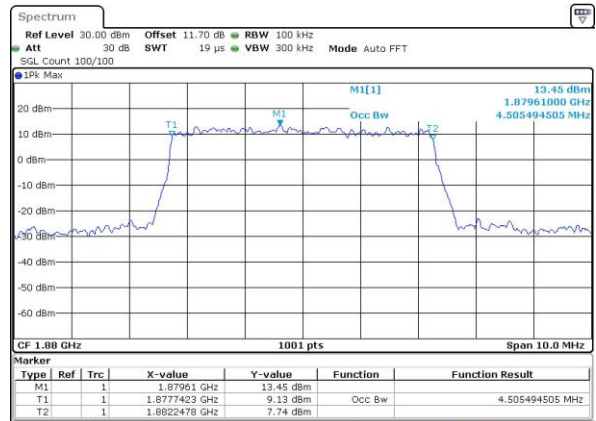

Date: 20 FEB 2017 09:37:06

Highest Channel / 5MHz / QPSK

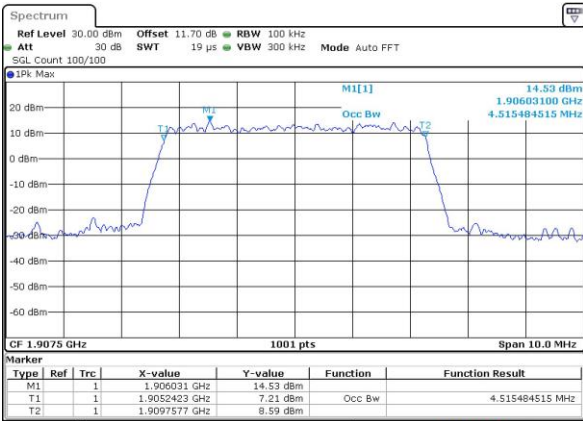

Date: 20 FEB 2017 09:39:30

Highest Channel / 5MHz / 16QAM

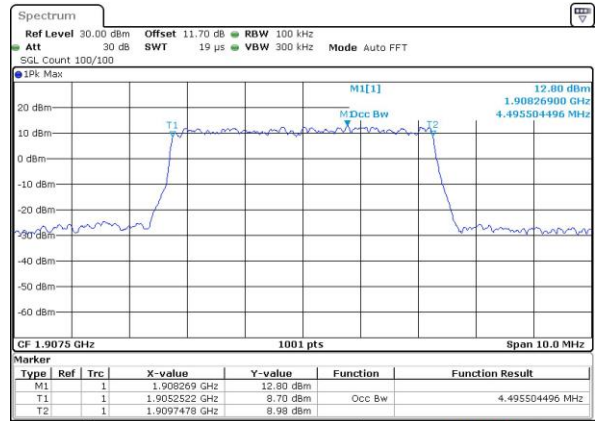

Date: 20 FEB 2017 09:39:40



LTE Band 2

Lowest Channel / 10MHz / QPSK

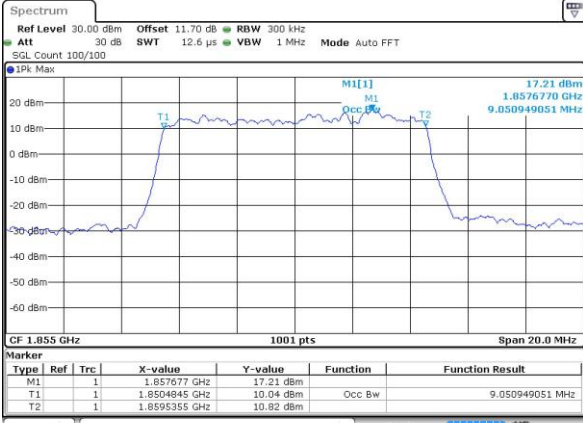

Date: 20 FEB 2017 09:46:38

Lowest Channel / 10MHz / 16QAM

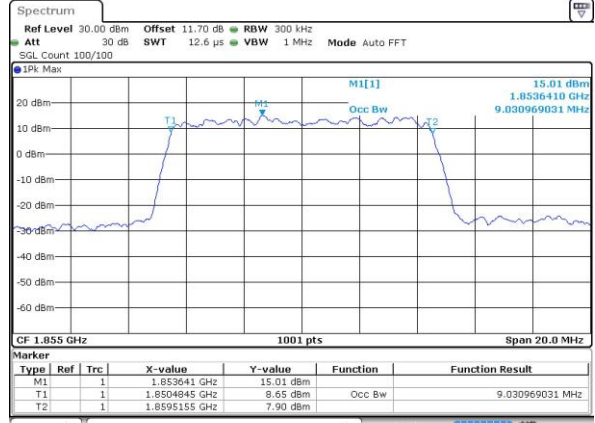

Date: 20 FEB 2017 09:46:48

Middle Channel / 10MHz / QPSK

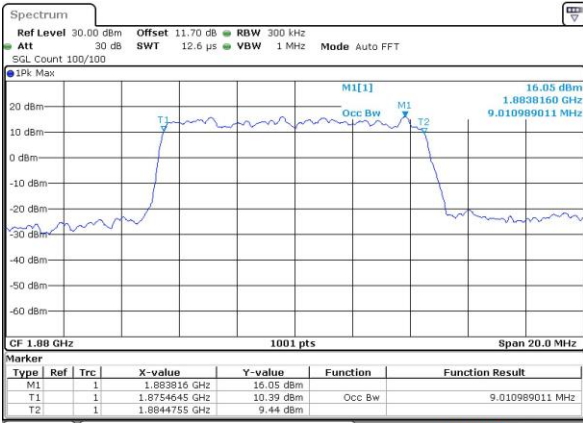

Date: 20 FEB 2017 09:53:45

Middle Channel / 10MHz / 16QAM

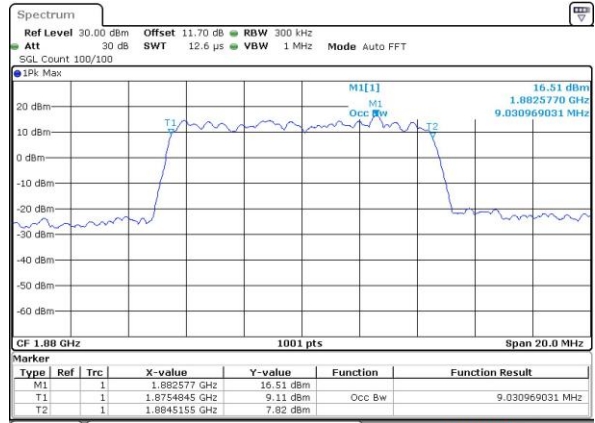

Date: 20 FEB 2017 09:53:55

Highest Channel / 10MHz / QPSK

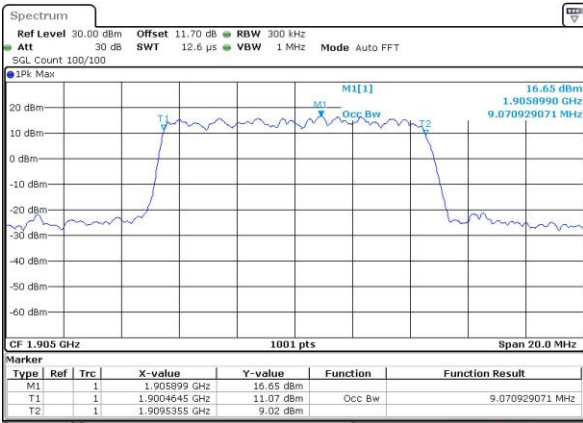

Date: 20 FEB 2017 09:56:15

Highest Channel / 10MHz / 16QAM

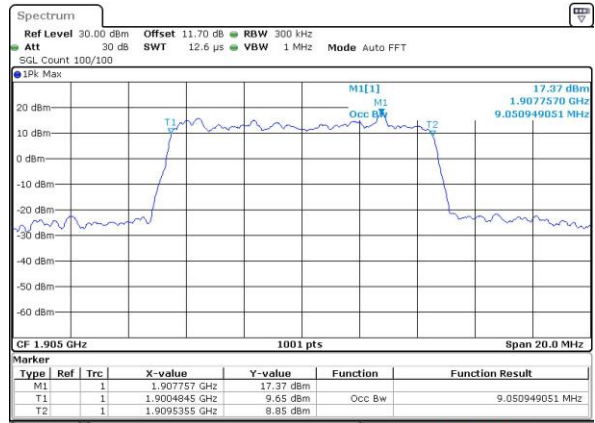

Date: 20 FEB 2017 09:56:26



LTE Band 2

Lowest Channel / 15MHz / QPSK

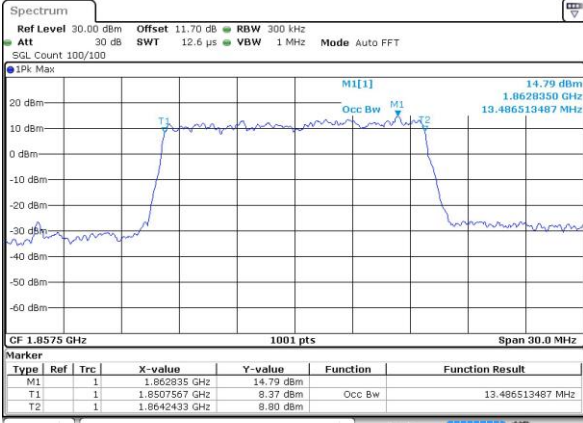

Date: 20 FEB 2017 10:03:27

Lowest Channel / 15MHz / 16QAM

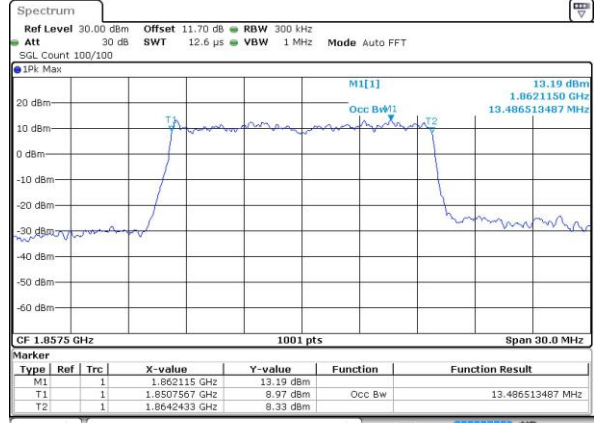

Date: 20 FEB 2017 10:03:38

Middle Channel / 15MHz / QPSK

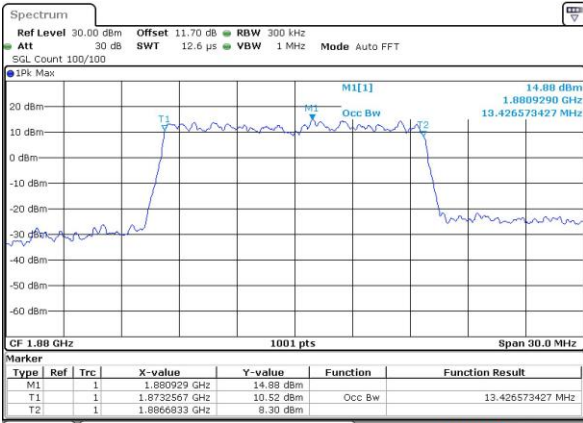

Date: 20 FEB 2017 10:10:40

Middle Channel / 15MHz / 16QAM

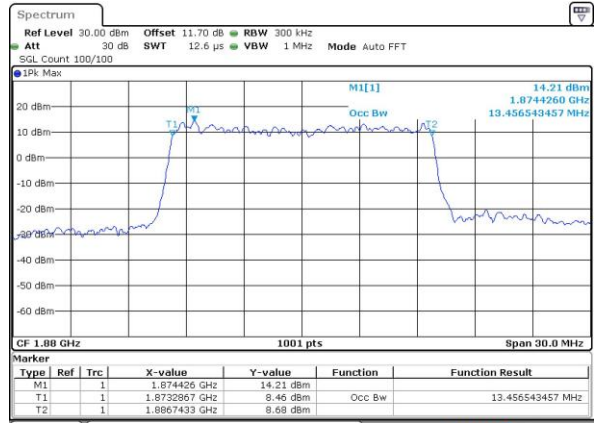

Date: 20 FEB 2017 10:10:50

Highest Channel / 15MHz / QPSK

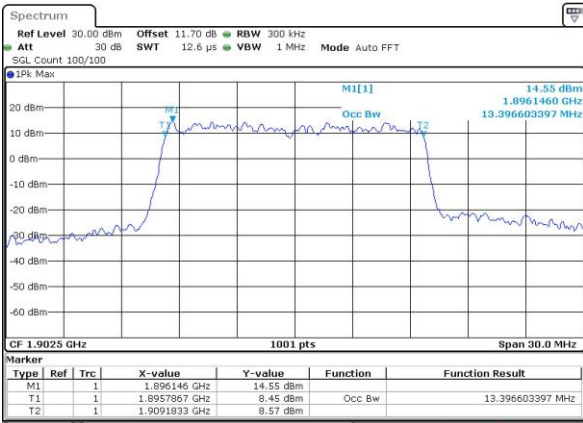

Date: 20 FEB 2017 10:13:11

Highest Channel / 15MHz / 16QAM

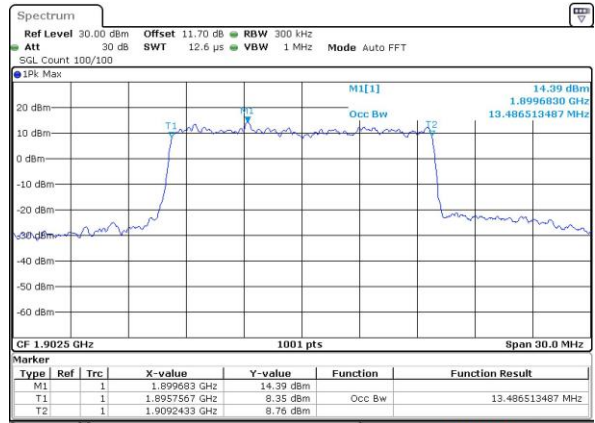

Date: 20 FEB 2017 10:13:21



LTE Band 2

Lowest Channel / 20MHz / QPSK

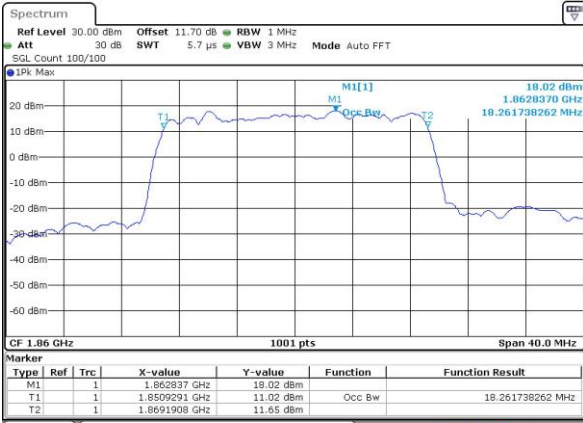

Date: 20 FEB 2017 10:20:19

Lowest Channel / 20MHz / 16QAM

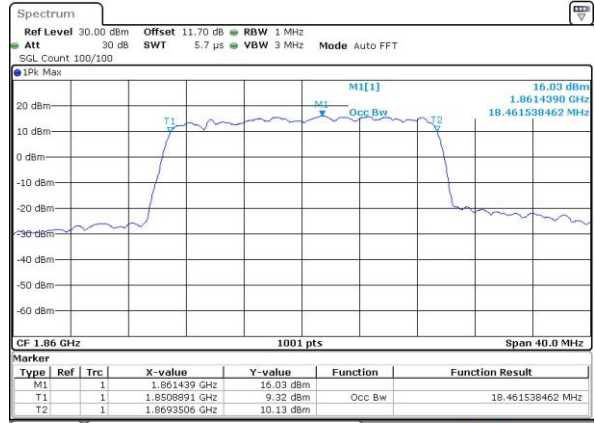

Date: 20 FEB 2017 10:20:29

Middle Channel / 20MHz / QPSK

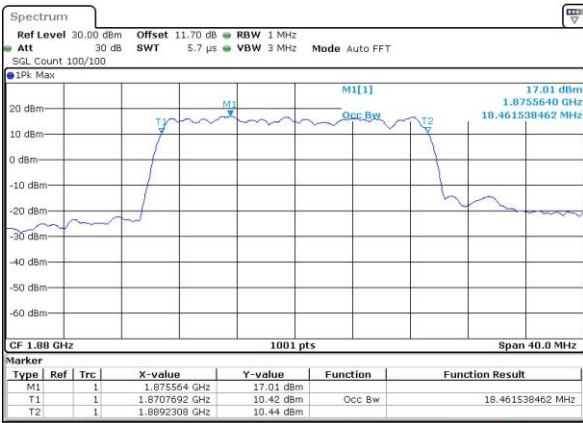

Date: 20 FEB 2017 10:27:28

Middle Channel / 20MHz / 16QAM

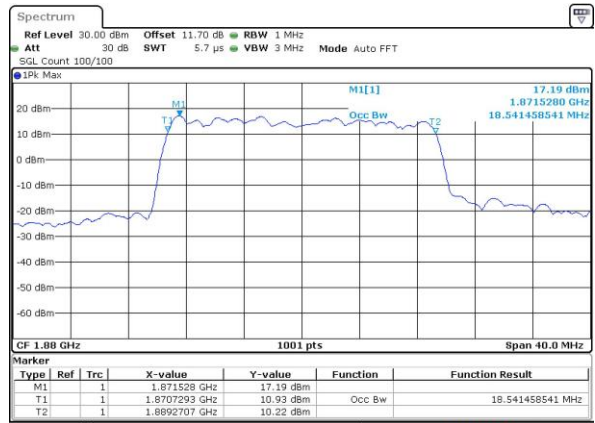

Date: 20 FEB 2017 10:27:36

Highest Channel / 20MHz / QPSK

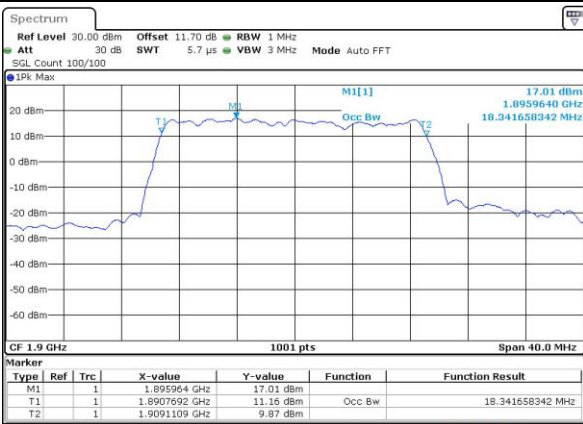

Date: 20 FEB 2017 10:29:56

Highest Channel / 20MHz / 16QAM

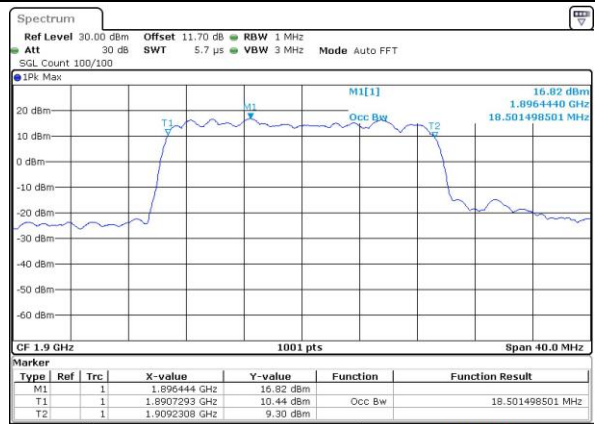

Date: 20 FEB 2017 10:30:06



**Conducted Band Edge**



LTE Band 2 / 1.4MHz / QPSK

Lowest Band Edge / 1RB

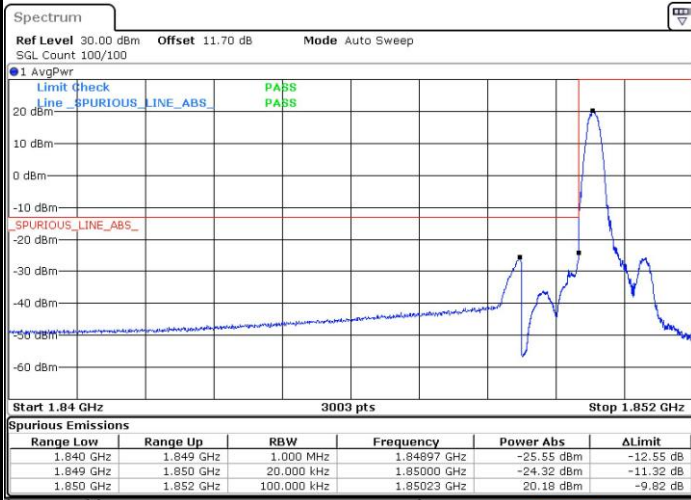

Date: 20.FEB.2017 10:43:58

Highest Band Edge / 1RB



Date: 20.FEB.2017 10:53:36

Lowest Band Edge / Full RB

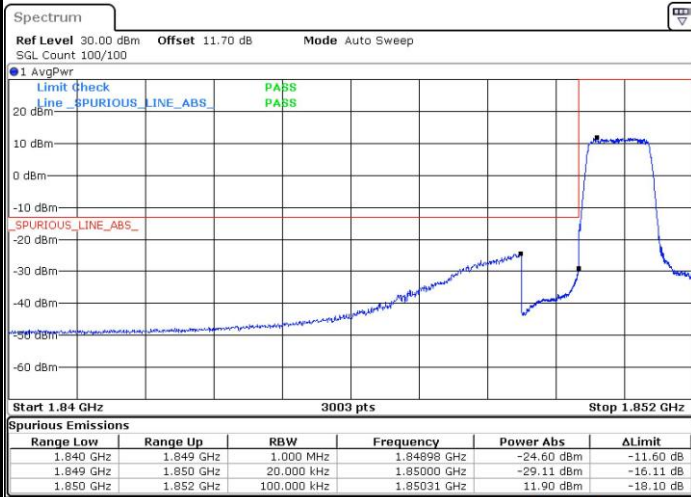

Date: 20.FEB.2017 10:46:17

Highest Band Edge / Full RB

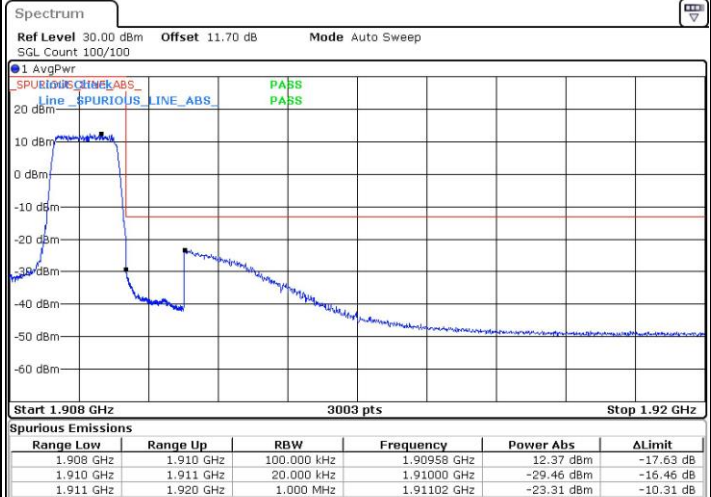

Date: 20.FEB.2017 10:55:54