



# FCC RF Test Report

**APPLICANT** : Motorola Mobility, LLC  
**EQUIPMENT** : Mobile Cellular Phone  
**BRAND NAME** : Motorola  
**MODEL NAME** : 10057  
**FCC ID** : IHDT56WA2  
**STANDARD** : FCC Part 15 Subpart C §15.247  
**CLASSIFICATION** : (DTS) Digital Transmission System

This is a variant report which is only valid together with the original test report. The product was received on Feb. 03, 2017 and testing was completed on Mar. 04, 2017. We, SPORTON INTERNATIONAL INC., would like to declare that the tested sample has been evaluated in accordance with the test procedures and has been in compliance with the applicable technical standards.

The test results in this report apply exclusively to the tested model / sample. Without written approval of SPORTON INTERNATIONAL INC., the test report shall not be reproduced except in full.

Reviewed by: Joseph Lin / Supervisor

Approved by: Jones Tsai / Manager



## **SPORTON INTERNATIONAL INC.**

**No. 52, Hwa Ya 1<sup>st</sup> Rd., Hwa Ya Technology Park, Kwei-Shan District, Tao Yuan City, Taiwan, R.O.C.**

SPORTON INTERNATIONAL INC.

TEL : 886-3-327-3456

FAX : 886-3-328-4978

FCC ID : IHDT56WA2

Page Number : 1 of 17

Report Issued Date : Mar. 20, 2017

Report Version : Rev. 01

Report Template No.: BU5-FR15CBT4.0 Version 1.3



# TABLE OF CONTENTS

**REVISION HISTORY..... 3**

**SUMMARY OF TEST RESULT ..... 4**

**1 GENERAL DESCRIPTION..... 5**

    1.1 Applicant ..... 5

    1.2 Manufacturer ..... 5

    1.3 Product Feature of Equipment Under Test..... 5

    1.4 Product Specification of Equipment Under Test..... 6

    1.5 Modification of EUT ..... 6

    1.6 Testing Location ..... 7

    1.7 Applicable Standards ..... 7

**2 TEST CONFIGURATION OF EQUIPMENT UNDER TEST..... 8**

    2.1 Carrier Frequency Channel ..... 8

    2.2 Descriptions of Test Mode ..... 9

    2.3 Test Mode ..... 9

    2.4 Connection Diagram of Test System ..... 10

    2.5 EUT Operation Test Setup ..... 10

**3 TEST RESULT ..... 11**

    3.1 Radiated Band Edges and Spurious Emission Measurement ..... 11

    3.2 Antenna Requirements ..... 15

**4 LIST OF MEASURING EQUIPMENT..... 16**

**5 UNCERTAINTY OF EVALUATION..... 17**

**APPENDIX A. RADIATED SPURIOUS EMISSION**

**APPENDIX B. RADIATED SPURIOUS EMISSION PLOTS**

**APPENDIX C. DUTY CYCLE PLOTS**

**APPENDIX D. ORIGINAL REPORT**





### SUMMARY OF TEST RESULT

Report Section	FCC Rule	Description	Limit	Result	Remark
3.1	15.247(d)	Radiated Band Edges and Spurious Emission	15.209(a) & 15.247(d)	Pass	Under limit 6.33 dB at 31.350 MHz
3.2	15.203 & 15.247(b)	Antenna Requirement	N/A	Pass	-



# 1 General Description

## 1.1 Applicant

**Motorola Mobility, LLC**

222 W Merchandise Mart Plaza, Suite 1800, Chicago, IL 60654, United States

## 1.2 Manufacturer

**Motorola Mobility, LLC**

222 W Merchandise Mart Plaza, Suite 1800, Chicago, IL 60654, United States

## 1.3 Product Feature of Equipment Under Test

Product Feature	
Equipment	Mobile Cellular Phone
Brand Name	Motorola
Model Name	10057
FCC ID	IHDT56WA2
IMEI Code	IMEI 1: 351889080007470 IMEI 2: 351889080007488
EUT supports Radios application	GSM/EGPRS/WCDMA/HSPA/LTE/NFC/FM WLAN 11b/g/n HT20 WLAN 11a/n HT20/HT40 Bluetooth BR/EDR/LE
HW Version	DVT2
EUT Stage	Identical Prototype

**Remark:**

1. The above EUT's information was declared by manufacturer. Please refer to the specifications or user's manual for more detailed description.
2. This is a variant report. All the test cases were performed on original report which can be referred to Sporton Report Number FR720310B.

Accessory List	
AC Adapter	Brand Name : Motorola
	Model Name : SPN5970A
Battery 1	Brand Name : Motorola
	Model Name : SNN5983A
Battery 2	Brand Name : Motorola
	Model Name : SNN5985A
Earphone	Brand Name : Motorola
	Model Name : SH38C16618
USB Cable	Brand Name : Motorola
	Model Name : SKN6473A



## 1.4 Product Specification of Equipment Under Test

Standards-related Product Specification	
Tx/Rx Frequency Range	2402 MHz ~ 2480 MHz
Number of Channels	40
Carrier Frequency of Each Channel	40 Channel(37 hopping + 3 advertising channel)
Maximum Output Power to Antenna	7.51 dBm (0.0056 W)
Antenna Type / Gain	Loop Antenna type with gain -0.50 dBi
Type of Modulation	Bluetooth LE : GFSK

## 1.5 Modification of EUT

No modifications are made to the EUT during all test items.



### 1.6 Testing Location

Sporton Lab is accredited to ISO 17025 by Taiwan Accreditation Foundation (TAF code : 1190) and the FCC designation No. TW0007 under the FCC 2.948(e) by Mutual Recognition Agreement (MRA) in FCC Test.

<b>Test Site</b>	SPORTON INTERNATIONAL INC.
<b>Test Site Location</b>	No. 52, Hwa Ya 1 <sup>st</sup> Rd., Hwa Ya Technology Park, Kwei-Shan District, Tao Yuan City, Taiwan, R.O.C. TEL: +886-3-327-3456 FAX: +886-3-328-4978
<b>Test Site No.</b>	<b>Sporton Site No.</b>
	TH05-HY

**Note:** The test site complies with ANSI C63.4 2014 requirement.

<b>Test Site</b>	SPORTON INTERNATIONAL INC.
<b>Test Site Location</b>	No.58, Aly. 75, Ln. 564, Wenhua 3rd Rd. Guishan Dist, Taoyuan City, Taiwan (R.O.C.) TEL: +886-3-327-0868 FAX: +886-3-327-0855
<b>Test Site No.</b>	<b>Sporton Site No.</b>
	03CH11-HY

**Note:** The test site complies with ANSI C63.4 2014 requirement.

### 1.7 Applicable Standards

According to the specifications of the manufacturer, the EUT must comply with the requirements of the following standards:

- ♦ FCC Part 15 Subpart C §15.247
- ♦ FCC KDB Publication No. 558074 D01 DTS Meas. Guidance v03r05
- ♦ ANSI C63.10-2013

**Remark:**

1. All test items were verified and recorded according to the standards and without any deviation during the test.
2. This EUT has also been tested and complied with the requirements of FCC Part 15, Subpart B, recorded in a separate test report.



## 2 Test Configuration of Equipment Under Test

### 2.1 Carrier Frequency Channel

Frequency Band	Channel	Freq. (MHz)	Channel	Freq. (MHz)
2400-2483.5 MHz	0	2402	21	2444
	1	2404	22	2446
	2	2406	23	2448
	3	2408	24	2450
	4	2410	25	2452
	5	2412	26	2454
	6	2414	27	2456
	7	2416	28	2458
	8	2418	29	2460
	9	2420	30	2462
	10	2422	31	2464
	11	2424	32	2466
	12	2426	33	2468
	13	2428	34	2470
	14	2430	35	2472
	15	2432	36	2474
	16	2434	37	2476
	17	2436	38	2478
	18	2438	39	2480
	19	2440	-	-
20	2442	-	-	



## 2.2 Descriptions of Test Mode

The RF output power was recorded in the following table:

Channel	Frequency	Bluetooth – LE RF Output Power
		Data Rate / Modulation
		GFSK
		1Mbps
Ch00	2402MHz	6.79 dBm
Ch19	2440MHz	7.51 dBm
Ch39	2480MHz	4.87 dBm

- a. The EUT has been associated with peripherals and configuration operated in a manner tended to maximize its emission characteristics in a typical application. Frequency range investigated: radiation (9 kHz to the 10th harmonic of the highest fundamental frequency or to 40 GHz, whichever is lower). Pre-scanned tests, X, Y, Z in three orthogonal panels to determine the final configuration (Z plane as worst plane) from all possible combinations.

## 2.3 Test Mode

The following summary table is showing all test modes to demonstrate in compliance with the standard.

Summary table of Test Cases	
Test Item	Data Rate / Modulation
	Bluetooth – LE / GFSK
Radiated TCs	Mode 1: Bluetooth Tx CH39_2480 MHz_1Mbps
<b>Remark:</b> All the radiated test cases were performance with Battery 1.	

## 2.4 Connection Diagram of Test System

<Bluetooth – LE Tx Mode>

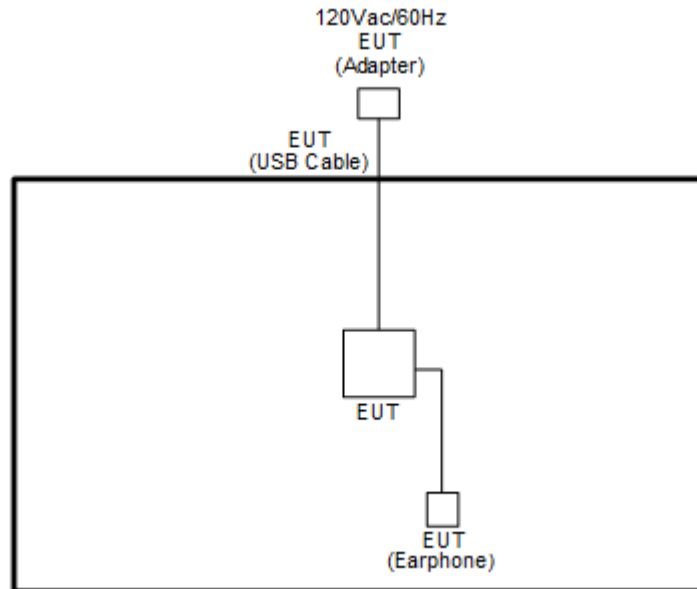

## 2.5 EUT Operation Test Setup

The RF test items, programmed RF utility, “QRCT” installed in the notebook make the EUT provide functions like channel selection and power level for continuous transmitting and receiving signals.



### 3 Test Result

#### 3.1 Radiated Band Edges and Spurious Emission Measurement

##### 3.1.1 Limit of Radiated Band Edges and Spurious Emission

In any 100 kHz bandwidth outside the intentional radiator frequency band, all harmonics/spurious must be at least 20 dB below the highest emission level within the authorized band. If the output power of this device was measured by spectrum analyzer, the attenuation under this paragraph shall be 30 dB instead of 20 dB. In addition, radiated emissions which fall in the restricted bands must also comply with the FCC section 15.209 limits as below.

Frequency (MHz)	Field Strength (microvolts/meter)	Measurement Distance (meters)
0.009 – 0.490	2400/F(kHz)	300
0.490 – 1.705	24000/F(kHz)	30
1.705 – 30.0	30	30
30 – 88	100	3
88 – 216	150	3
216 - 960	200	3
Above 960	500	3

##### 3.1.2 Measuring Instruments

The section 4.0 of List of Measuring Equipment of this test report is used for test.



### 3.1.3 Test Procedures

1. The testing follows FCC KDB Publication No. 558074 D01 DTS Meas. Guidance v03r05.
2. The EUT was arranged to its worst case and then tune the antenna tower (from 1 m to 4 m) and turntable (from 0 degree to 360 degrees) to find the maximum reading. A pre-amp and a high pass filter are used for the test in order to get better signal level.
3. The EUT was placed on a turntable with 0.8 meter for frequency below 1GHz and 1.5 meter for frequency above 1GHz respectively above ground.
4. The EUT was set 3 meters from the interference receiving antenna, which was mounted on the top of a variable height antenna tower.
5. Corrected Reading: Antenna Factor + Cable Loss + Read Level - Preamp Factor = Level
6. For measurement below 1GHz, If the emission level of the EUT measured by the peak detector is 3 dB lower than the applicable limit, the peak emission level will be reported. Otherwise, the emission measurement will be repeated using the quasi-peak detector and reported.
7. Use the following spectrum analyzer settings:
  - (1) Span shall wide enough to fully capture the emission being measured;
  - (2) Set RBW=100 kHz for  $f < 1$  GHz; VBW  $\geq$  RBW; Sweep = auto; Detector function = peak; Trace = max hold;
  - (3) Set RBW = 1 MHz, VBW= 3MHz for  $f \geq 1$  GHz for peak measurement.  
For average measurement:
    - VBW = 10 Hz, when duty cycle is no less than 98 percent.
    - VBW  $\geq 1/T$ , when duty cycle is less than 98 percent where T is the minimum transmission duration over which the transmitter is on and is transmitting at its maximum power control level for the tested mode of operation.

### 3.1.4 Test Setup

For radiated emissions below 30MHz

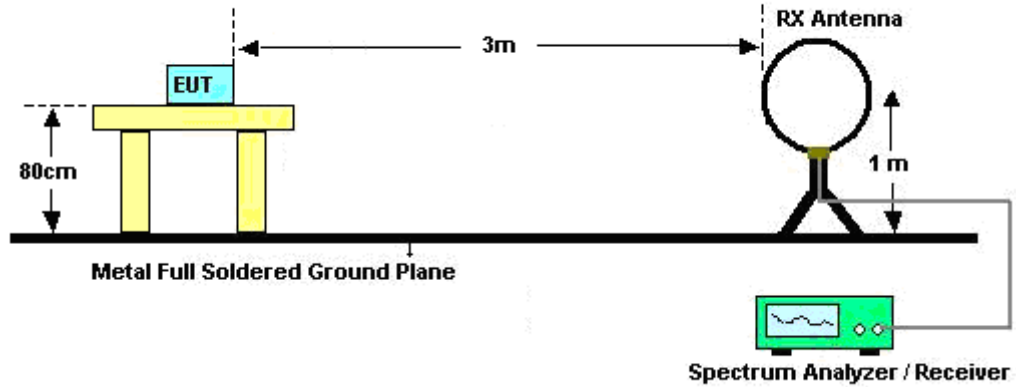

For radiated emissions from 30MHz to 1GHz

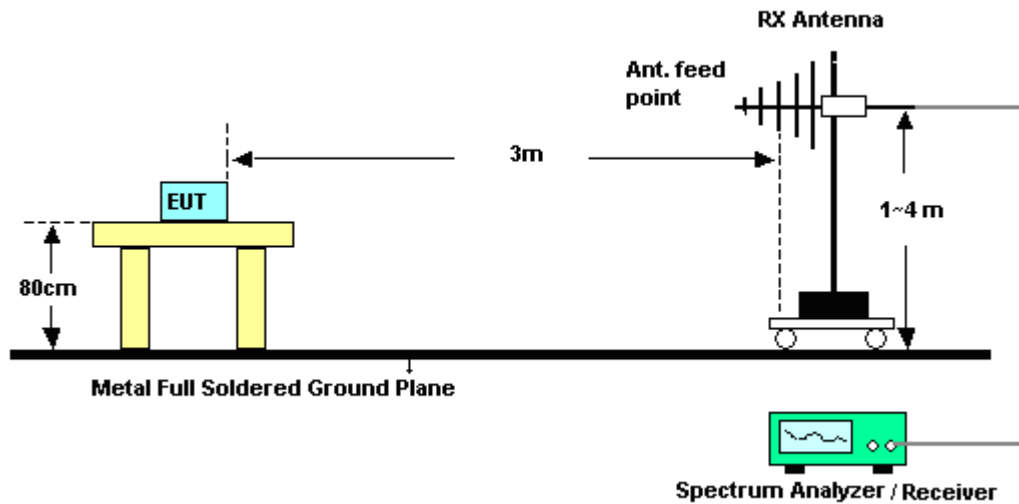

For radiated emissions above 1GHz

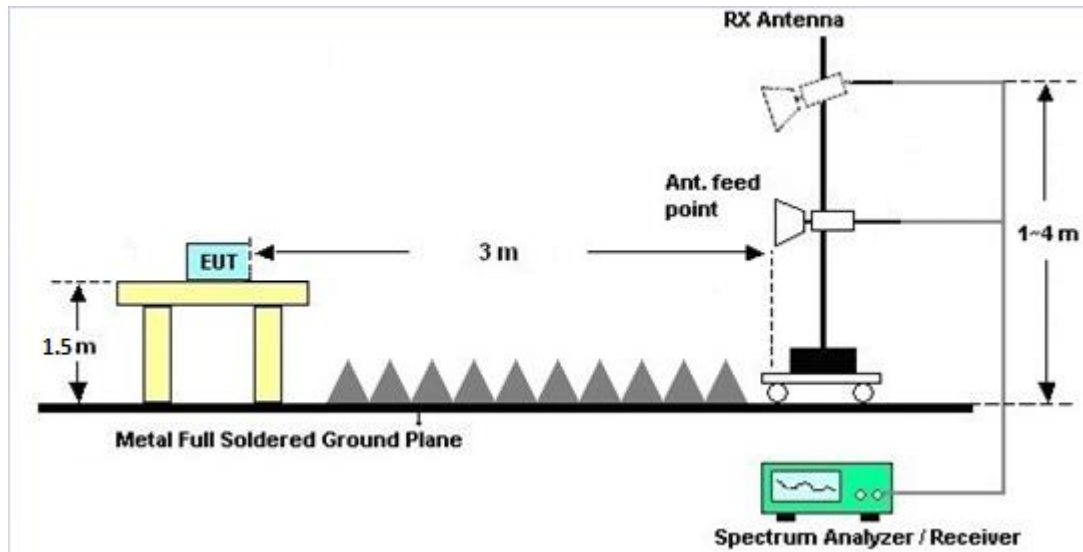

### 3.1.5 Test Results of Radiated Spurious Emissions (9 kHz ~ 30 MHz)

The low frequency, which started from 9 kHz to 30MHz, was pre-scanned and the result which was 20dB lower than the limit line per 15.31(o) was not reported.

### 3.1.6 Test Result of Radiated Spurious at Band Edges

Please refer to Appendix A and B.

### 3.1.7 Duty Cycle

Please refer to Appendix C.

### 3.1.8 Test Result of Radiated Spurious Emission (30MHz ~ 10th Harmonic)

Please refer to Appendix A and B.



## **3.2 Antenna Requirements**

### **3.2.1 Standard Applicable**

If directional gain of transmitting antennas is greater than 6dBi, the power shall be reduced by the same level in dB comparing to gain minus 6dBi. The use of a permanently attached antenna or of an antenna that uses a unique coupling to the intentional radiator shall be considered sufficient to comply with the FCC rule.

### **3.2.2 Antenna Anti-Replacement Construction**

An embedded-in antenna design is used.

### **3.2.3 Antenna Gain**

The antenna peak gain of EUT is less than 6 dBi. Therefore, it is not necessary to reduce maximum peak output power limit.



## 4 List of Measuring Equipment

Instrument	Manufacturer	Model No.	Serial No.	Characteristics	Calibration Date	Test Date	Due Date	Remark
Power Meter	Agilent	E4416A	GB412923 44	300MHz~40GHz	Dec. 26, 2016	Feb. 25, 2017	Dec. 25, 2017	Conducted (TH05-HY)
Power Sensor	Agilent	E9327A	US404415 48	300MHz~40GHz	Dec. 26, 2016	Feb. 25, 2017	Dec. 25, 2017	Conducted (TH05-HY)
Amplifier	SONOMA	310N	187312	9kHz~1GHz	Nov. 10, 2016	Mar. 03, 2017 ~ Mar. 04, 2017	Nov. 09, 2017	Radiation (03CH11-HY)
Loop Antenna	Rohde & Schwarz	HFH2-Z2	100315	9 kHz~30 MHz	Sep. 02, 2015	Mar. 03, 2017 ~ Mar. 04, 2017	Sep. 01, 2017	Radiation (03CH11-HY)
Bilog Antenna	TESEQ	CBL 6111D	35414	30MHz~1GHz	Oct. 15, 2016	Mar. 03, 2017 ~ Mar. 04, 2017	Oct. 14, 2017	Radiation (03CH11-HY)
Horn Antenna	SCHWARZBE CK	BBHA 9120 D	9120D-152 2	1GHz ~ 18GHz	Oct. 07, 2016	Mar. 03, 2017 ~ Mar. 04, 2017	Oct. 06, 2017	Radiation (03CH11-HY)
Preamplifier	Keysight	83017A	MY532700 80	1GHz~26.5GHz	Nov. 10, 2016	Mar. 03, 2017 ~ Mar. 04, 2017	Nov. 09, 2017	Radiation (03CH11-HY)
Spectrum Analyzer	Keysight	N9010A	MY523502 76	10Hz ~ 44GHz	Oct. 12, 2016	Mar. 03, 2017 ~ Mar. 04, 2017	Oct. 11, 2017	Radiation (03CH11-HY)
Antenna Mast	EMEC	AM-BS-4500- B	N/A	1~4m	N/A	Mar. 03, 2017 ~ Mar. 04, 2017	N/A	Radiation (03CH11-HY)
Turn Table	EMEC	TT 2000	N/A	0~360 Degree	N/A	Mar. 03, 2017 ~ Mar. 04, 2017	N/A	Radiation (03CH11-HY)
Preamplifier	MITEQ	AMF-7D-0010 1800	2025787	1GHz~18GHz	Feb. 13, 2017	Mar. 03, 2017 ~ Mar. 04, 2017	Feb. 12, 2018	Radiation (03CH11-HY)
SHF-EHF Horn Antenna	SCHWARZBE CK	BBHA 9170	BBHA9170 584	18GHz- 40GHz	Nov. 08, 2016	Mar. 03, 2017 ~ Mar. 04, 2017	Nov. 07, 2017	Radiation (03CH11-HY)
Preamplifier	MITEQ	JS44-180040 00-33-8P	1840917	18GHz ~ 40GHz	Jun.14, 2016	Mar. 03, 2017 ~ Mar. 04, 2017	Jun.13, 2017	Radiation (03CH11-HY)



## 5 Uncertainty of Evaluation

### Uncertainty of Radiated Emission Measurement (30 MHz ~ 1000 MHz)

Measuring Uncertainty for a Level of Confidence of 95% ( $U = 2Uc(y)$ )	5.2
---	-----

### Uncertainty of Radiated Emission Measurement (1000 MHz ~ 18000 MHz)

Measuring Uncertainty for a Level of Confidence of 95% ( $U = 2Uc(y)$ )	5.5
---	-----

### Uncertainty of Radiated Emission Measurement (18000 MHz ~ 40000 MHz)

Measuring Uncertainty for a Level of Confidence of 95% ( $U = 2Uc(y)$ )	5.2
---	-----



## Appendix A. Radiated Spurious Emission

Test Engineer :	JC Liao, Jacky Hung, and Ken Wu	Temperature :	20~24°C
		Relative Humidity :	50~54%

2.4GHz 2400~2483.5MHz

BLE (Band Edge @ 3m)

BLE	Note	Frequency ( MHz )	Level ( dBμV/m )	Over Limit ( dB )	Limit Line ( dBμV/m )	Read Level ( dBμV )	Antenna Factor ( dB/m )	Cable Loss ( dB )	Preamp Factor ( dB )	Ant Pos ( cm )	Table Pos ( deg )	Peak Avg. ( P/A )	Pol. ( H/V )	
BLE CH 39 2480MHz	*	2480	93.73	-	-	90.88	27.45	8.98	33.58	363	138	P	H	
	*	2480	92.89	-	-	90.04	27.45	8.98	33.58	363	138	A	H	
		2496.96	53.89	-20.11	74	50.98	27.5	8.98	33.57	363	138	P	H	
		2485.32	44.93	-9.07	54	42.08	27.45	8.98	33.58	363	138	A	H	
													H	
														H
	*	2480	98.35	-	-	95.5	27.45	8.98	33.58	130	126	P	V	
	*	2480	97.63	-	-	94.78	27.45	8.98	33.58	130	126	A	V	
		2487.4	54.53	-19.47	74	51.68	27.45	8.98	33.58	130	126	P	V	
		2496.4	45.06	-8.94	54	42.15	27.5	8.98	33.57	130	126	A	V	
														V
														V
Remark	1. No other spurious found. 2. All results are PASS against Peak and Average limit line.													



2.4GHz 2400~2483.5MHz

BLE (Harmonic @ 3m)

BLE	Note	Frequency ( MHz )	Level ( dBµV/m )	Over Limit ( dB )	Limit Line ( dBµV/m )	Read Level ( dBµV )	Antenna Factor ( dB/m )	Cable Loss ( dB )	Preamp Factor ( dB )	Ant Pos ( cm )	Table Pos ( deg )	Peak Avg. ( P/A )	Pol. ( H/V )
BLE CH 39 2480MHz		4960	38.49	-35.51	74	60.06	31.94	11.12	64.63	100	0	P	H
		7440	41.9	-32.1	74	56.46	37.44	12.88	64.88	100	0	P	H
													H
													H
		4960	37.1	-36.9	74	58.67	31.94	11.12	64.63	100	0	P	V
		7440	41.34	-32.66	74	55.9	37.44	12.88	64.88	100	0	P	V
													V
													V
Remark	1. No other spurious found. 2. All results are PASS against Peak and Average limit line.												



Emission below 1GHz

2.4GHz BLE (LF)

BLE	Note	Frequency	Level	Over	Limit	Read	Antenna	Cable	Preamp	Ant	Table	Peak	Pol.	
		( MHz )	( dBμV/m )	( dB )	( dBμV/m )	( dBμV )	( dB/m )	( dB )	( dB )	( cm )	( deg )	( P/A )	( H/V )	
2.4GHz BLE LF		42.69	24.19	-15.81	40	36.77	18.62	1.29	32.49	-	-	P	H	
		166.62	27.22	-16.28	43.5	41.77	16.2	2	32.75	-	-	P	H	
		198.21	29.92	-13.58	43.5	44.84	15.86	2.1	32.88	-	-	P	H	
		767.6	30.33	-15.67	46	30.6	27.91	4.09	32.27	-	-	P	H	
		881	32.4	-13.6	46	30.51	29.08	4.57	31.76	-	-	P	H	
		959.4	33.9	-12.1	46	29.75	30.58	4.69	31.12	100	15	P	H	
														H
														H
														H
														H
														H
														H
			31.35	33.67	-6.33	40	39.69	25.18	1.29	32.49	100	241	P	V
			81.57	24.88	-15.12	40	42.03	13.82	1.51	32.48	-	-	P	V
			195.51	27.58	-15.92	43.5	42.63	15.72	2.1	32.87	-	-	P	V
			793.5	31.35	-14.65	46	31.07	28.22	4.26	32.2	-	-	P	V
			846	32.06	-13.94	46	30.76	28.85	4.39	31.94	-	-	P	V
			948.9	33.58	-12.42	46	29.53	30.57	4.69	31.21	-	-	P	V
														V
														V
													V	
													V	
													V	
Remark	1. No other spurious found. 2. All results are PASS against limit line.													



**Note symbol**

*	<b>Fundamental Frequency</b> which can be ignored. However, the level of any unwanted emissions shall not exceed the level of the fundamental frequency.
!	Test result is <b>over limit</b> line.
P/A	<b>Peak</b> or <b>Average</b>
H/V	<b>Horizontal</b> or <b>Vertical</b>



A calculation example for radiated spurious emission is shown as below:

WIFI	Note	Frequency	Level	Over	Limit	Read	Antenna	Cable	Preamp	Ant	Table	Peak	Pol.
Ant.				Limit	Line	Level	Factor	Loss	Factor	Pos	Pos	Avg.	
1+2		( MHz )	( dBμV/m )	( dB )	( dBμV/m )	( dBμV )	( dB/m )	( dB )	( dB )	( cm )	( deg )	( P/A )	( H/V )
802.11b		2390	55.45	-18.55	74	54.51	32.22	4.58	35.86	103	308	P	H
CH 01													
2412MHz		2390	43.54	-10.46	54	42.6	32.22	4.58	35.86	103	308	A	H

- Level(dBμV/m) =  
Antenna Factor(dB/m) + Cable Loss(dB) + Read Level(dBμV) - Preamp Factor(dB)
- Over Limit(dB) = Level(dBμV/m) – Limit Line(dBμV/m)

**For Peak Limit @ 2390MHz:**

- Level(dBμV/m)  
= Antenna Factor(dB/m) + Cable Loss(dB) + Read Level(dBμV) - Preamp Factor(dB)  
= 32.22(dB/m) + 4.58(dB) + 54.51(dBμV) – 35.86 (dB)  
= 55.45 (dBμV/m)
- Over Limit(dB)  
= Level(dBμV/m) – Limit Line(dBμV/m)  
= 55.45(dBμV/m) – 74(dBμV/m)  
= -18.55(dB)

**For Average Limit @ 2390MHz:**

- Level(dBμV/m)  
= Antenna Factor(dB/m) + Cable Loss(dB) + Read Level(dBμV) - Preamp Factor(dB)  
= 32.22(dB/m) + 4.58(dB) + 42.6(dBμV) – 35.86 (dB)  
= 43.54 (dBμV/m)
- Over Limit(dB)  
= Level(dBμV/m) – Limit Line(dBμV/m)  
= 43.54(dBμV/m) – 54(dBμV/m)  
= -10.46(dB)

**Both peak and average measured complies with the limit line, so test result is “PASS”.**



## Appendix B. Radiated Spurious Emission Plots

<b>Test Engineer :</b>	JC Liao, Jacky Hung, and Ken Wu	<b>Temperature :</b>	20~24°C
		<b>Relative Humidity :</b>	50~54%



2.4GHz 2400~2483.5MHz

BLE (Band Edge @ 3m)

BLE	2.4GHz 2400~2483.5MHz Band Edge @ 3m	
ANT	BLE CH39 2480MHz	
1	Horizontal	Fundamental
Peak	<p>Site : 03CH11-HY Condition : PEAK BE 74 3m HORN 9120D-HF HORIZONTAL</p>	<p>Site : 03CH11-HY Condition : PEAK 74 3m HORN 9120D-HF HORIZONTAL</p>
Avg.	<p>Site : 03CH11-HY Condition : AVG BE 54 3m HORN 9120D-HF HORIZONTAL</p>	<p>Site : 03CH11-HY Condition : AVG 54 3m HORN 9120D-HF HORIZONTAL</p>



BLE	2.4GHz 2400~2483.5MHz Band Edge @ 3m	
ANT	BLE CH39 2480MHz	
1	Vertical	Fundamental
<p><b>Peak</b></p>	<p>Site : 03CHI1-HY Condition : PEAK BE 74 3m HORN 9120D-HF VERTICAL</p>	<p>Site : 03CHI1-HY Condition : PEAK 74 3m HORN 9120D-HF VERTICAL</p>
<p><b>Avg.</b></p>	<p>Site : 03CHI1-HY Condition : AVG BE 54 3m HORN 9120D-HF VERTICAL</p>	<p>Site : 03CHI1-HY Condition : AVG 54 3m HORN 9120D-HF VERTICAL</p>



2.4GHz 2400~2483.5MHz

BLE (Harmonic @ 3m)

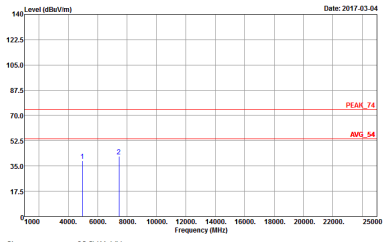
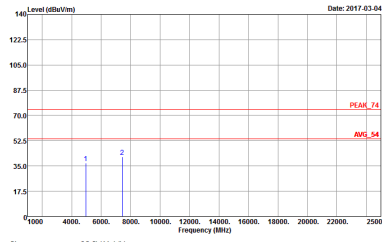
BLE	2.4GHz 2400~2483.5MHz Harmonic @ 3m	
ANT	BLE CH39 2480MHz	
1	Horizontal	Vertical
Peak	 <p>Site : 03CH11-HY Condition : PEAK 74 3m 9170 SHF HORN 150809 HORIZONTAL</p>	 <p>Site : 03CH11-HY Condition : PEAK 74 3m 9170 SHF HORN 150809 VERTICAL</p>



Emission below 1GHz

2.4GHz BLE (LF)

BLE	2.4GHz 2400~2483.5MHz	
ANT	BLE LF	
1	Horizontal	Vertical
QP / Peak	<p>Horizontal emission spectrum plot showing Level (dBuV/m) vs Frequency (MHz). The plot includes a red step function and a blue signal line. A peak is labeled 'QP' at approximately 2.4 GHz. The x-axis ranges from 50 to 1000 MHz, and the y-axis ranges from 0 to 80 dBuV/m. The date is 2017-03-04. Site: 03CH11-HY, Condition: QP 3m BE LOG 6111D-LF ETC HORIZONTAL.</p>	<p>Vertical emission spectrum plot showing Level (dBuV/m) vs Frequency (MHz). The plot includes a red step function and a blue signal line. A peak is labeled 'QP' at approximately 2.4 GHz. The x-axis ranges from 50 to 1000 MHz, and the y-axis ranges from 0 to 80 dBuV/m. The date is 2017-03-04. Site: 03CH11-HY, Condition: QP 3m BE LOG 6111D-LF ETC VERTICAL.</p>

## Appendix D. Duty Cycle Plots

Band	Duty Cycle(%)	T(us)	1/T(kHz)	VBW Setting
Bluetooth -LE	62.5	390	2.56	3kHz

### Bluetooth - LE

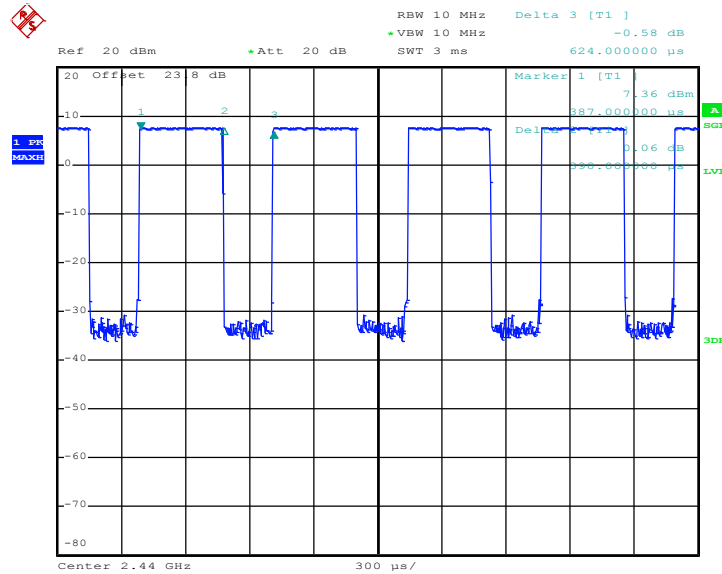

Date: 25.FEB.2017 14:21:08



## **Appendix D. Original Report**

Please refer to Sporton report number FR720310B.