



Variant FCC Test Report

APPLICANT : Motorola Mobility LLC
EQUIPMENT : Mobile Cellular Phone
BRAND NAME : Motorola
MODEL NAME : 9844
FCC ID : IHDT56VF5
STANDARD : FCC 47 CFR FCC Part 15 Subpart B
CLASSIFICATION : Certification

This is a variant report which is only valid together with the original report. The product was received on Dec. 13, 2016 and testing was completed on Dec. 21, 2016. We, SPORTON INTERNATIONAL (KUNSHAN) INC., would like to declare that the tested sample has been evaluated in accordance with the test procedures given in ANSI C63.4-2014 and has been in compliance with the applicable technical standards.

The test results in this report apply exclusively to the tested model / sample. Without written approval of SPORTON INTERNATIONAL (KUNSHAN) INC., the test report shall not be reproduced except in full.

Prepared by: James Huang / Manager



Approved by: Jones Tsai / Manager

SPORTON INTERNATIONAL (KUNSHAN) INC.

No. 3-2, PingXiang Road, Kunshan, Jiangsu Province, P. R. China



TABLE OF CONTENTS

REVISION HISTORY	3
SUMMARY OF TEST RESULT	4
1. GENERAL DESCRIPTION	5
1.1. Applicant.....	5
1.2. Manufacturer	5
1.3. Product Feature of Equipment Under Test	5
1.4. Product Specification of Equipment Under Test	6
1.5. Specification of Accessory	7
1.6. Modification of EUT	7
1.7. Test Location	8
1.8. Applicable Standards	8
2. TEST CONFIGURATION OF EQUIPMENT UNDER TEST	9
2.1. Test Mode	9
2.2. Connection Diagram of Test System	10
2.3. Support Unit used in test configuration and system	11
2.4. EUT Operation Test Setup	11
3. TEST RESULT	12
3.1. Test of AC Conducted Emission Measurement	12
3.2. Test of Radiated Emission Measurement	16
4. LIST OF MEASURING EQUIPMENT	20
5. UNCERTAINTY OF EVALUATION	21
APPENDIX A. SETUP PHOTOGRAPHS	
APPENDIX B. PRODUCT EQUALITY DECLARATION	
APPENDIX C. ORIGINAL REPORT	



SUMMARY OF TEST RESULT

Report Section	FCC Rule	Description	Limit	Result	Remark
3.1	15.107	AC Conducted Emission	< 15.107 limits	PASS	Under limit 11.10 dB at 0.476 MHz
3.2	15.109	Radiated Emission	< 15.109 limits	PASS	Under limit 12.13 dB at 596.480 MHz



1. General Description

1.1. Applicant

Motorola Mobility LLC
222 W, Merchandise Mart Plaza, Chicago IL 60654 USA

1.2. Manufacturer

Motorola Mobility LLC
222 W, Merchandise Mart Plaza, Chicago IL 60654 USA

1.3. Product Feature of Equipment Under Test

Product Feature	
Equipment	Mobile Cellular Phone
Brand Name	Motorola
Model Name	9844
FCC ID	IHDT56VF5
EUT supports Radios application	GSM/GPRS/EGPRS/WCDMA/HSPA/DC-HSDPA/ HSPA+ (16QAM uplink is not supported)/LTE WLAN 2.4GHz 802.11b/g/n HT20 WLAN 5GHz 802.11a/n HT20/HT40 Bluetooth v3.0+EDR Bluetooth v4.0 LE/Bluetooth v4.2 LE
IMEI Code	Conduction: 358222070013550/358222070013568 Radiation: N/A
HW Version	DVT2(V5.0)
SW Version	cedric-userdebug 7.0 NPP25.127 859 intcfg,test-keys
EUT Stage	Identical Prototype

Remark: The above EUT's information was declared by manufacturer. Please refer to the specifications or user's manual for more detailed description.



1.4. Product Specification of Equipment Under Test

Standards-related Product Specification	
Tx Frequency	GSM850: 824.2 MHz ~ 848.8 MHz GSM1900: 1850.2 MHz ~ 1909.8MHz WCDMA Band V: 826.4 MHz ~ 846.6 MHz LTE Band 5 : 824.7 MHz ~ 848.3 MHz 802.11b/g/n: 2412 MHz ~ 2462 MHz 802.11a/n: 5180 MHz ~ 5240 MHz; 5260 MHz ~ 5320 MHz; 5500 MHz ~ 5700 MHz; 5745 MHz ~ 5825 MHz Bluetooth: 2402 MHz ~ 2480 MHz
Rx Frequency	GSM850: 869.2 MHz ~ 893.8 MHz GSM1900: 1930.2 MHz ~ 1989.8 MHz WCDMA Band V: 871.4 MHz ~ 891.6 MHz LTE Band 5 : 869.7 MHz ~ 893.3 MHz 802.11b/g/n: 2412 MHz ~ 2462 MHz 802.11a/n: 5180 MHz ~ 5240 MHz; 5260 MHz ~ 5320 MHz; 5500 MHz ~ 5700 MHz; 5745 MHz ~ 5825 MHz Bluetooth: 2402 MHz ~ 2480 MHz GPS : 1.57542 GHz Glonass: 1602 MHz + n× 0.5625MHz (n=-7,-6,-5,...0,...,6) FM : 88 MHz ~ 108 MHz
Antenna Type	WWAN : PIFA Antenna WLAN : PIFA Antenna Bluetooth : PIFA Antenna GPS/Glonass: PIFA Antenna FM: External headset Antenna
Type of Modulation	GSM: GMSK GPRS: GMSK EDGE(MCS 0-4): GMSK / (MCS 5-9): 8PSK WCDMA : BPSK (Uplink) HSDPA/DC-HSDPA : QPSK (Uplink) HSUPA : QPSK (Uplink) HSPA+ : 16QAM (uplink is not supported) DC-HSDPA : 64QAM LTE: QPSK / 16QAM 802.11b : DSSS (DBPSK / DQPSK / CCK) 802.11a/g/n : OFDM (BPSK / QPSK / 16QAM / 64QAM) Bluetooth LE : GFSK Bluetooth (1Mbps) : GFSK Bluetooth (2Mbps) : $\pi/4$ -DQPSK Bluetooth (3Mbps) : 8-DPSK GPS/Glonass : BPSK FM

1.5. Specification of Accessory

Specification of Accessory				
AC Adapter 1	Brand Name	Motorola (Acbel)	Model Name	C-P49
	Power Rating	I/P: 100-240 Vac, 300mA, O/P: 5.2Vdc, 2000mA		
AC Adapter 2	Brand Name	Motorola (Salom)	Model Name	SSW-2919IN C-P49 SPN5946A
	Power Rating	I/P: 100-240 Vac, 300mA, O/P: 5.2Vdc, 2000mA		
AC Adapter 3	Brand Name	Motorola (Salom)	Model Name	SSW-2919EU C-P36 SPN5944A
	Power Rating	I/P: 100-240 Vac, 300mA, O/P: 5.2Vdc, 2000mA		
Battery 1	Brand Name	Motorola (ATL)	Model Name	GK40
	Power Rating	3.8Vdc, 2685/2800mAh (Min/Typ)	Type	Li-ion
Battery 2	Brand Name	Motorola (Sunwoda)	Model Name	GK40
	Power Rating	3.8Vdc, 2685/2800mAh (Min/Typ)	Type	Li-ion
Earphone	Brand Name	Motorola	Model Name	SJYN1181B
	Signal Line Type	1.2 meter, non-shielded cable, without ferrite core		
USB Cable 1	Brand Name	Motorola (Liqi)	Model Name	L25W-051000100AL
	Signal Line Type	1.0 meter, non-shielded cable, without ferrite core		
USB Cable 2	Brand Name	Motorola (Fukangyuan)	Model Name	F25W-051000100A
	Signal Line Type	1.0 meter, non-shielded cable, without ferrite core		

1.6. Modification of EUT

No modifications are made to the EUT during all test items.



1.7. Test Location

Test Site	SPORTON INTERNATIONAL (KUNSHAN) INC.		
Test Site Location	No. 3-2, PingXiang Road, Kunshan, Jiangsu Province, P. R. China TEL: +86-0512-5790-0158 FAX: +86-0512-5790-0958		
Test Site No.	Sporton Site No.		FCC Registration No.
	CO01-KS	03CH02-KS	418269

Note: The test site complies with ANSI C63.4 2014 requirement.

1.8. Applicable Standards

According to the specifications of the manufacturer, the EUT must comply with the requirements of the following standards:

- FCC 47 CFR FCC Part 15 Subpart B
- ANSI C63.4-2014

Remark:

1. All test items were verified and recorded according to the standards and without any deviation during the test.
2. For FCC 15 Subpart B - Unintentional Radiators, device supporting USB interface or similar peripherals (defined as the Section 15.3 (r) Peripheral device) acting as a peripheral for personal computers shall be authorized as “The Class B personal computers and peripherals” per the Section 15.101 (a) Equipment authorization of unintentional radiators.
3. For other Unintentional Radiators features of this EUT, test reports are be issued separately.
Per the Note of the Section 15.101, when device supports features (USB, FM Radio, digital devices...etc) more than one category of authorization, type of authorization shall be appropriately chosen for FCC 15B compliance rule, and the Section 15.101 (b), only those receivers that operate (tune) within the frequency range of 30-960 MHz, CB receivers and radar detectors are subject to the authorizations shown in paragraph (a) of the Section 15.101. However, receivers indicated as being subject to Declaration of Conformity that are contained within a transceiver, the transmitter portion of which is subject to certification, shall be authorized under the verification procedure.

2. Test Configuration of Equipment Under Test

2.1. Test Mode

The EUT has been associated with peripherals pursuant to ANSI C63.4-2014 and configuration operated in a manner tended to maximize its emission characteristics in a typical application.

Frequency range investigated: conduction (150 kHz to 30 MHz), radiation (30MHz to the 5th harmonic of the highest fundamental frequency or to 40 GHz, whichever is lower).

The following tables are showing the test modes as the worst cases and recorded in this report.

Item	EUT Configuration	Test Condition	
		EMI AC	EMI RE
1.	Data application transferred mode (EUT with notebook)	☒	☒

Abbreviations:

- EMI AC: AC conducted emissions
- EMI RE: EUT radiated emissions

Test Items	EUT Configure Mode	Function Type
AC Conducted Emission	1	Mode 1: LTE Band 5 Idle + Bluetooth Idle + WLAN Idle(2.4G) + Earphone + USB Cable(Data Link with Notebook) + GPS Rx + SIM 2
Radiated Emissions	1	Mode 1: LTE Band 5 Idle + Bluetooth Idle + WLAN Idle(2.4G) + Earphone + USB Cable(Data Link with Notebook) + GPS Rx + SIM 2

2.2. Connection Diagram of Test System

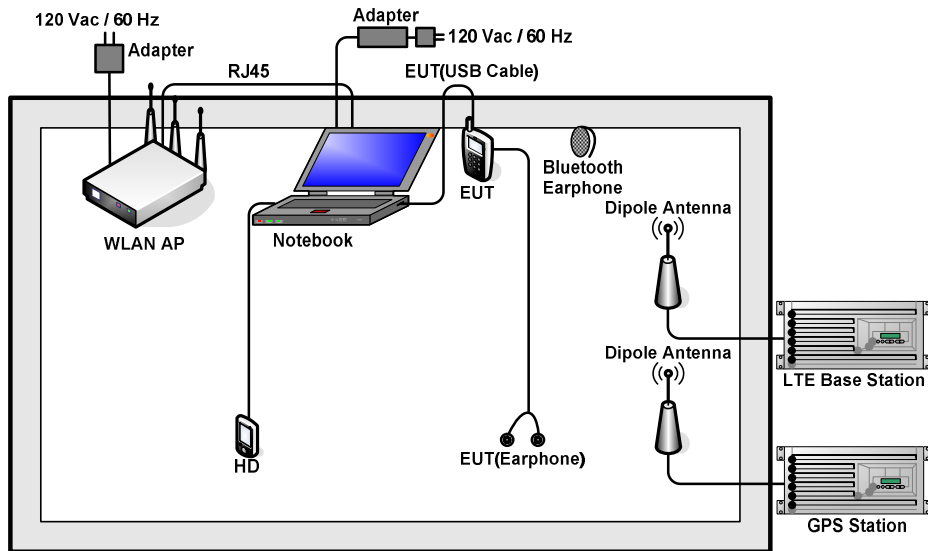

2.3. Support Unit used in test configuration and system

Item	Equipment	Trade Name	Model Name	FCC ID	Data Cable	Power Cord
1.	LTE Base Station	Anritsu	MT8820C	N/A	N/A	Unshielded, 1.8 m
2.	GPS Station	ADIVIC	MP9000	N/A	N/A	Unshielded, 1.8 m
3.	WLAN AP	LINKSYS	WRT600N	Q87-WRT600NV11	N/A	Unshielded, 1.8 m
4.	WLAN AP	TP-LINK	TL-WDR5600	N/A	N/A	Unshielded, 1.8 m
5.	Notebook	Lenovo	G480	N/A	N/A	AC I/P: Unshielded, 1.8 m DC O/P: Shielded, 1.8 m
6.	Notebook	Dell	Latitude3440	N/A	N/A	AC I/P: Unshielded, 1.8 m DC O/P: Shielded, 1.8 m
7.	Bluetooth Earphone	Lenovo	LBH308	N/A	N/A	N/A
8.	Bluetooth Earphone	Lenovo	LBH301	N/A	N/A	N/A
9.	Hard Disk	Lenovo	F310	FCC DoC	Shielded, 0.5 m	N/A
10.	SD Card	SanDisk	Uitra	N/A	N/A	N/A

2.4. EUT Operation Test Setup

The EUT was in LTE idle mode during the testing. The EUT was synchronized to the BCCH, and is in continuous receiving mode by setting system simulator's paging reorganization.

The EUT was attached to the Bluetooth earphone or WLAN AP, and the following programs installed in the EUT were programmed during the test.

1. Data application is transferred between notebook and EUT via USB cable.
2. Turn on GPS function to make the EUT receive continuous signals from GPS station.

3. Test Result

3.1. Test of AC Conducted Emission Measurement

3.1.1 Limits of AC Conducted Emission

For equipment that is designed to be connected to the public utility (AC) power line, the radio frequency voltage that is conducted back onto the AC power line on any frequency or frequencies within the band 150 kHz to 30 MHz shall not exceed the limits in the following table.

Frequency of emission (MHz)	Conducted limit (dBuV)	
	Quasi-peak	Average
0.15-0.5	66 to 56*	56 to 46*
0.5-5	56	46
5-30	60	50

*Decreases with the logarithm of the frequency.

3.1.2 Measuring Instruments

The measuring equipment is listed in the section 4 of this test report.

3.1.3 Test Procedure

1. The EUT was placed 0.4 meter from the conducting wall of the shielding room was kept at least 80 centimeters from any other grounded conducting surface.
2. Connect EUT to the power mains through a line impedance stabilization network (LISN).
3. All the support units are connecting to the other LISN.
4. The LISN provides 50 ohm coupling impedance for the measuring instrument.
5. The FCC states that a 50 ohm, 50 microhenry LISN should be used.
6. Both sides of AC line were checked for maximum conducted interference.
7. The frequency range from 150 kHz to 30 MHz was searched.
8. Set the test-receiver system to Peak Detect Function and specified bandwidth (IF Bandwidth = 9kHz) with Maximum Hold Mode. Then measurement is also conducted by Average Detector and Quasi-Peak Detector Function respectively.

3.1.4 Test Setup





3.1.5 Test Result of AC Conducted Emission

Test Mode :	Mode 1	Temperature :	20~22°C
Test Engineer :	Morris Li	Relative Humidity :	44~46%
Test Voltage :	120Vac / 60Hz	Phase :	Line
Function Type :	LTE Band 5 Idle + Bluetooth Idle + WLAN Idle(2.4G) + Earphone + USB Cable(Data Link with Notebook) + GPS Rx + SIM 2		

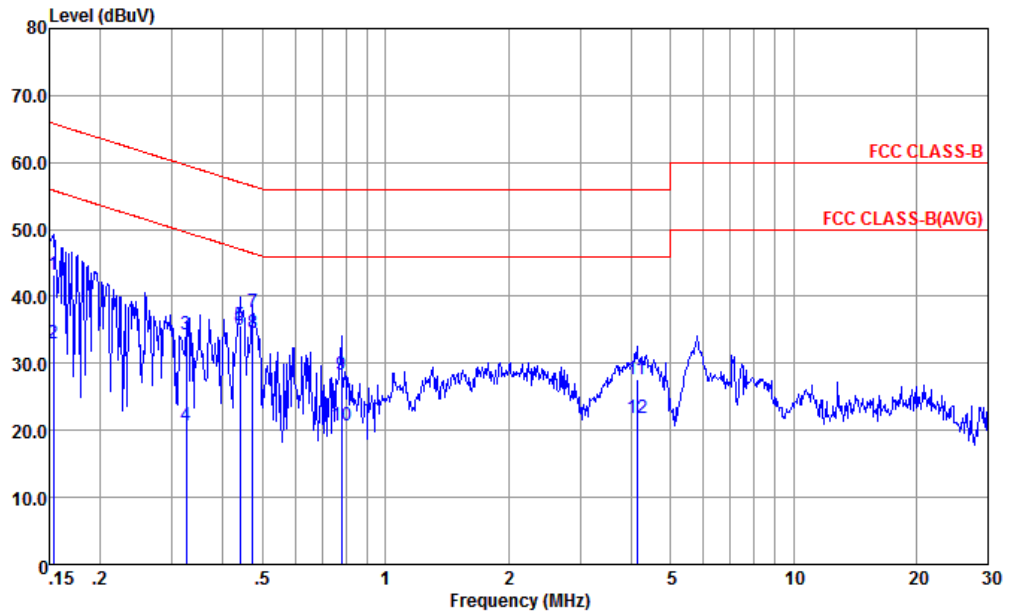

Site : CO01-KS
 Condition : FCC CLASS-B LISN-L-20151024 LINE
 Project : (FC) 6D1306
 mode : Mode 1
 IMEI : 358222070013550/358222070013568
 : #8

	Freq	Level	Over	Limit	Read	LISN	Cable	
	MHz	dBuV	Limit	Line	Level	Factor	Loss	Remark
			dB	dBuV	dBuV	dB	dB	
1	0.153	43.30	-22.52	65.82	32.40	0.51	10.39	QP
2	0.153	33.00	-22.82	55.82	22.10	0.51	10.39	Average
3	0.325	34.26	-25.31	59.57	23.79	0.23	10.24	QP
4	0.325	20.66	-28.91	49.57	10.19	0.23	10.24	Average
5	0.440	35.62	-21.45	57.07	25.20	0.23	10.19	QP
6	0.440	35.02	-12.05	47.07	24.60	0.23	10.19	Average
7	0.474	37.62	-18.83	56.45	27.20	0.23	10.19	QP
8 *	0.474	34.52	-11.93	46.45	24.10	0.23	10.19	Average
9	0.779	28.22	-27.78	56.00	17.81	0.24	10.17	QP
10	0.779	20.72	-25.28	46.00	10.31	0.24	10.17	Average
11	4.136	27.73	-28.27	56.00	17.30	0.19	10.24	QP
12	4.136	21.73	-24.27	46.00	11.30	0.19	10.24	Average



Test Mode :	Mode 1	Temperature :	20~22°C
Test Engineer :	Morris Li	Relative Humidity :	44~46%
Test Voltage :	120Vac / 60Hz	Phase :	Neutral
Function Type :	LTE Band 5 Idle + Bluetooth Idle + WLAN Idle(2.4G) + Earphone + USB Cable(Data Link with Notebook) + GPS Rx + SIM 2		

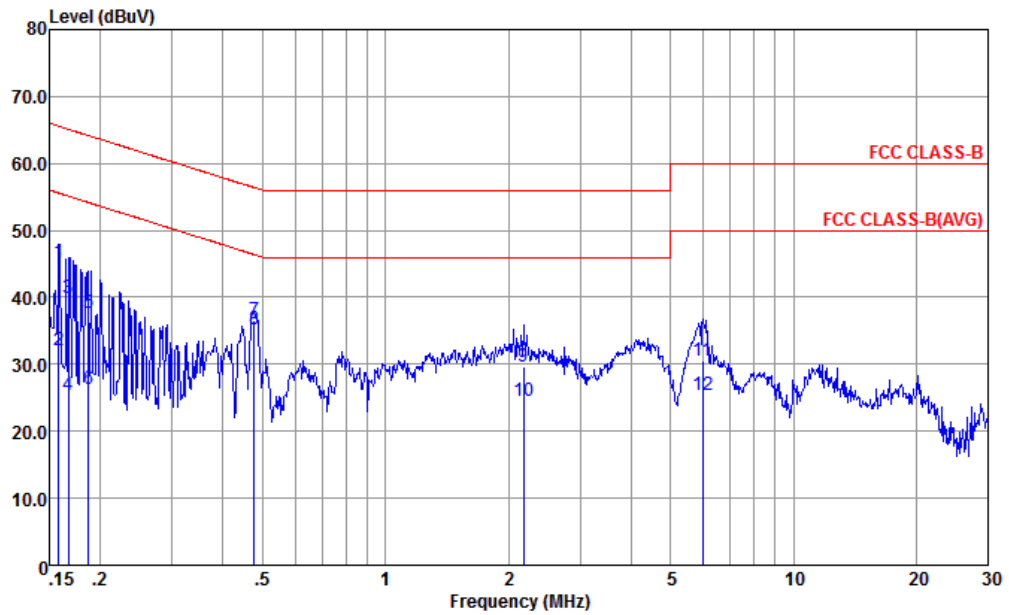

Site : CO01-KS
 Condition : FCC CLASS-B LISN-N-20151024 NEUTRAL
 Project : (FC) 6D1306
 mode : Mode 1
 IMEI : 358222070013550/358222070013568
 : #8

	Freq	Level	Over Limit	Limit Line	Read Level	LISN Factor	Cable Loss	Remark
	MHz	dBuV	dB	dBuV	dBuV	dB	dB	
1	0.158	45.18	-20.38	65.56	34.50	0.30	10.38	QP
2	0.158	32.18	-23.38	55.56	21.50	0.30	10.38	Average
3	0.167	39.98	-25.14	65.12	29.31	0.30	10.37	QP
4	0.167	25.48	-29.64	55.12	14.81	0.30	10.37	Average
5	0.187	37.75	-26.40	64.15	27.09	0.31	10.35	QP
6	0.187	26.35	-27.80	54.15	15.69	0.31	10.35	Average
7	0.476	36.51	-19.90	56.41	26.00	0.32	10.19	QP
8 *	0.476	35.31	-11.10	46.41	24.80	0.32	10.19	Average
9	2.178	29.67	-26.33	56.00	19.10	0.38	10.19	QP
10	2.178	24.47	-21.53	46.00	13.90	0.38	10.19	Average
11	5.993	30.48	-29.52	60.00	19.90	0.32	10.26	QP
12	5.993	25.38	-24.62	50.00	14.80	0.32	10.26	Average



3.2. Test of Radiated Emission Measurement

3.2.1. Limit of Radiated Emission

The emissions from an unintentional radiator shall not exceed the field strength levels specified in the following table:

Frequency (MHz)	Field Strength (microvolts/meter)	Measurement Distance (meters)
30 – 88	100	3
88 – 216	150	3
216 - 960	200	3
Above 960	500	3

3.2.2. Measuring Instruments

The measuring equipment is listed in the section 4 of this test report.

3.2.3. Test Procedures

1. The EUT was placed on a turntable with 0.8 meter above ground.
2. The EUT was set 3 meters from the interference receiving antenna, which was mounted on the top of a variable height antenna tower.
3. The table was rotated 360 degrees to determine the position of the highest radiation.
4. The antenna is a Bi-Log antenna and its height is adjusted between one to four meters above ground to find the maximum value of the field strength for both horizontal polarization and vertical polarization of the antenna.
5. For each suspected emission, the EUT was arranged to its worst case and then tune the antenna tower (from 1 m to 4 m) and turntable (from 0 degree to 360 degrees) to find the maximum reading.
6. Set the test-receiver system to Peak Detect Function and specified bandwidth with Maximum Hold Mode (RBW=120kHz/VBW=300kHz for frequency below 1GHz; RBW=1MHz VBW=3MHz (Peak), RBW=1MHz/VBW=10Hz (Average) for frequency above 1GHz).
7. If the emission level of the EUT in peak mode was 3 dB lower than the limit specified, peak values of EUT will be reported. Otherwise, the emission will be repeated by using the quasi-peak method and reported.
8. Emission level (dBµV/m) = 20 log Emission level (µV/m)
9. Corrected Reading: Antenna Factor + Cable Loss + Read Level - Preamp Factor = Level

3.2.4. Test Setup of Radiated Emission

For radiated emissions from 30MHz to 1GHz

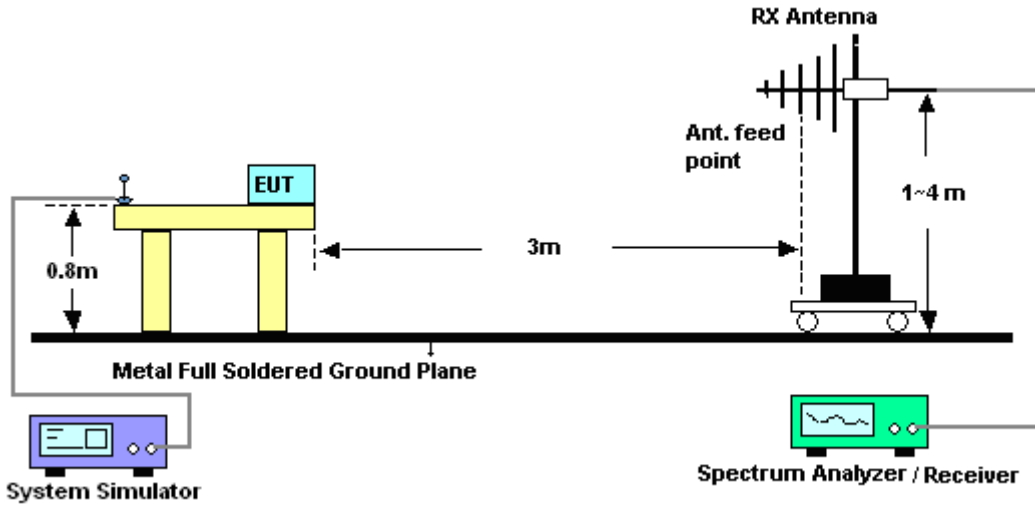

For radiated emissions above 1GHz

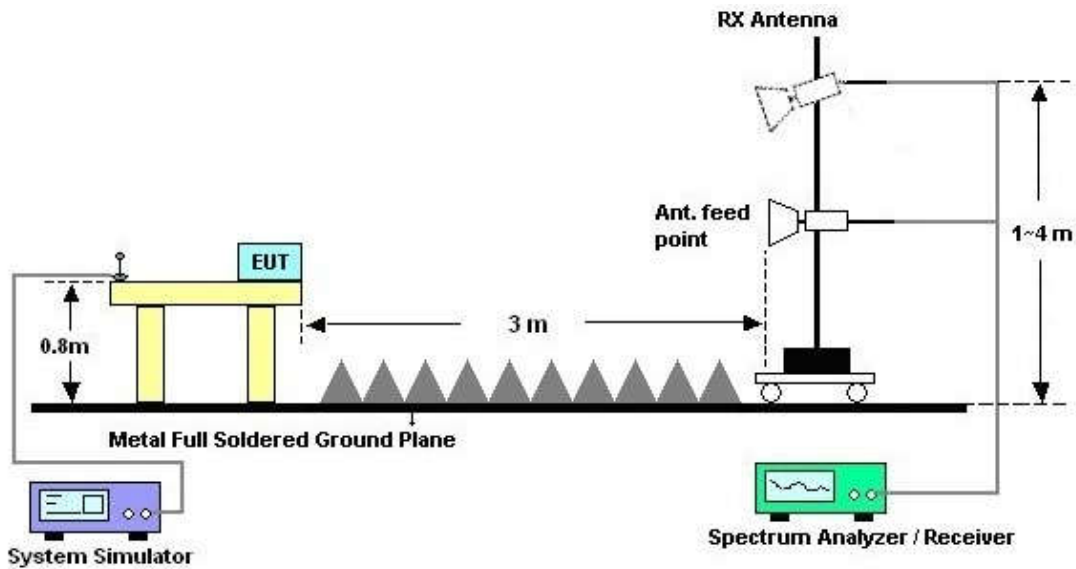



3.2.5. Test Result of Radiated Emission

Test Mode :	Mode 1	Temperature :	21~22°C
Test Engineer :	Jason Peng	Relative Humidity :	41~42%
Test Distance :	3m	Polarization :	Horizontal
Function Type :	LTE Band 5 Idle + Bluetooth Idle + WLAN Idle(2.4G) + Earphone + USB Cable(Data Link with Notebook) + GPS Rx + SIM 2		
Remark :	#7 is system simulator signal which can be ignored.		

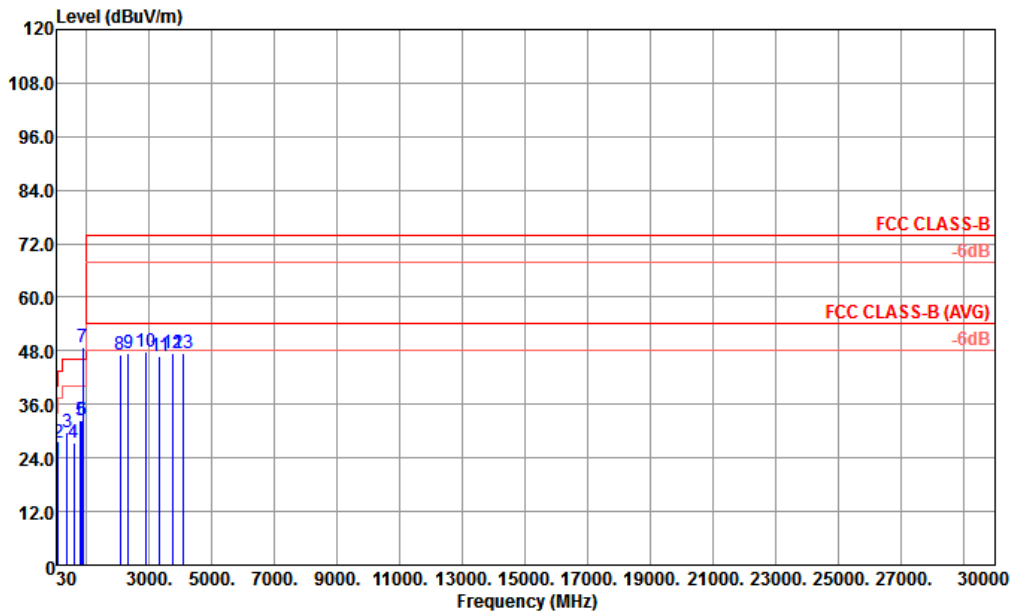

Site : 03CH02-KS
 Condition : FCC CLASS-B 3m 966-02 LF ANT HORIZONTAL
 Mode : 1

No.	Freq	Level	Over Limit		ReadAntenna		Cable Loss	Preamp Factor	A/Pos	T/Pos	Remark
			Limit	Line	Level	Factor					
	MHz	dBUV/m	dB	dBUV/m	dBuV	dB/m	dB	dB	cm	deg	
1	34.85	23.23	-16.77	40.00	30.29	24.55	0.12	31.73	---	---	Peak
2	88.20	27.36	-16.14	43.50	42.05	16.75	0.21	31.65	---	---	Peak
3	368.53	29.70	-16.30	46.00	37.32	22.13	0.80	30.55	---	---	Peak
4	596.48	27.51	-18.49	46.00	31.21	24.33	0.90	28.93	---	---	Peak
5	793.39	32.54	-13.46	46.00	32.39	26.55	1.45	27.85	---	---	Peak
6	862.26	32.56	-13.44	46.00	30.97	27.30	1.45	27.16	100	0	Peak
7 *	878.75	48.94			46.99	27.43	1.57	27.05	---	---	Peak
8	2076.00	47.10	-26.90	74.00	45.89	30.73	5.05	34.57	---	---	Peak
9	2332.00	47.31	-26.69	74.00	43.96	31.33	5.64	33.62	---	---	Peak
10	2878.00	47.85	-26.15	74.00	40.79	32.27	2.90	28.11	---	---	Peak
11	3336.00	46.86	-27.14	74.00	38.24	33.58	5.96	30.92	---	---	Peak
12	3747.00	47.52	-26.48	74.00	38.12	34.50	6.39	31.49	---	---	Peak
13	4092.00	47.60	-26.40	74.00	38.12	34.98	6.31	31.81	---	---	Peak



Test Mode :	Mode 1	Temperature :	21~22°C
Test Engineer :	Jason Peng	Relative Humidity :	41~42%
Test Distance :	3m	Polarization :	Vertical
Function Type :	LTE Band 5 Idle + Bluetooth Idle + WLAN Idle(2.4G) + Earphone + USB Cable(Data Link with Notebook) + GPS Rx + SIM 2		
Remark :	#7 is system simulator signal which can be ignored.		

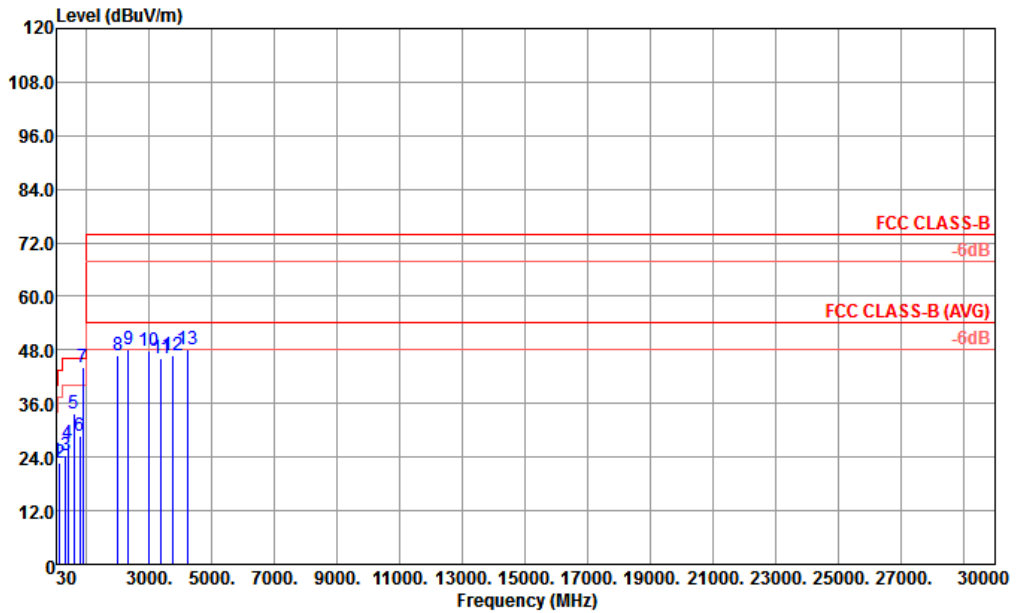

Site : 03CH02-KS
 Condition : FCC CLASS-B 3m 966-02 LF ANT VERTICAL
 Mode : 1

: EUT (SD) USB Data Link to PC/NB

	Freq	Level	Over Limit	Limit	ReadAntenna	Cable	Preamp	A/Pos	T/Pos	Remark	
	MHz	dBuV/m	dB	dBuV/m	dBuV	dB/m	dB	dB	cm	deg	
1	38.73	23.06	-16.94	40.00	32.25	22.50	0.12	31.81	---	---	Peak
2	145.43	22.88	-20.62	43.50	36.42	17.66	0.32	31.52	---	---	Peak
3	322.94	24.33	-21.67	46.00	35.30	19.00	0.65	30.62	---	---	Peak
4	398.60	27.03	-18.97	46.00	31.54	25.11	0.92	30.54	---	---	Peak
5	596.48	33.87	-12.13	46.00	37.57	24.33	0.90	28.93	100	0	Peak
6	784.66	28.63	-17.37	46.00	28.60	26.48	1.44	27.89	---	---	Peak
7 !	879.72	44.16			42.19	27.44	1.57	27.04	---	---	Peak
8	2000.00	46.86	-27.14	74.00	46.62	30.50	4.46	34.72	---	---	Peak
9	2324.00	48.02	-25.98	74.00	44.67	31.33	5.64	33.62	---	---	Peak
10	2994.00	47.90	-26.10	74.00	40.97	32.56	3.14	28.77	---	---	Peak
11	3381.00	46.29	-27.71	74.00	37.65	33.64	5.93	30.93	---	---	Peak
12	3762.00	46.78	-27.22	74.00	37.33	34.50	6.44	31.49	---	---	Peak
13	4224.00	48.21	-25.79	74.00	38.54	35.13	6.38	31.84	---	---	Peak



4. List of Measuring Equipment

Instrument	Manufacturer	Model No.	Serial No.	Characteristics	Calibration Date	Test Date	Due Date	Remark
EMI Receiver	R&S	ESC17	100768	9kHz~7GHz;	Apr. 29, 2016	Dec. 21, 2016	Apr. 28, 2017	Conduction (CO01-KS)
AC LISN	MessTec	AN3016	060103	9kHz~30MHz	Oct. 13, 2016	Dec. 21, 2016	Oct. 12, 2017	Conduction (CO01-KS)
AC LISN (for auxiliary equipment)	MessTec	AN3016	060105	9kHz~30MHz	Oct. 13, 2016	Dec. 21, 2016	Oct. 12, 2017	Conduction (CO01-KS)
AC Power Source	Chroma	61602	ABP000000811	AC 0V~300V, 45Hz~1000Hz	Oct. 13, 2016	Dec. 21, 2016	Oct. 12, 2017	Conduction (CO01-KS)
EMI Test Receiver	R&S	ESR7	101403	9kHz~7GHz; Max 30dBm	Aug. 09, 2016	Dec. 17, 2016	Aug. 08, 2017	Radiation (03CH02-KS)
EXA Spectrum Analyzer	Keysight	N9010A	MY55150208	10Hz~44GHz; Max 30dB	Apr. 22, 2016	Dec. 17, 2016	Apr. 21, 2017	Radiation (03CH02-KS)
Bilog Antenna	TeseQ	CBL6112D	37879	30MHz~2GHz	Aug. 20, 2016	Dec. 17, 2016	Aug. 19, 2017	Radiation (03CH02-KS)
Double Ridge Horn Antenna	ETS-Lindgren	3117	75957	1GHz~18GHz	Oct. 22, 2016	Dec. 17, 2016	Oct. 21, 2017	Radiation (03CH02-KS)
SHF-EHF Horn	Schwarzbeck	BBHA 9170	BBHA170249	15GHz~40GHz	Mar. 03, 2016	Dec. 17, 2016	Mar. 02, 2017	Radiation (03CH02-KS)
Amplifier	com-power	PA-103A	161069	1kHz~1000MHz / 32 dB	Apr. 22, 2016	Dec. 17, 2016	Apr. 21, 2017	Radiation (03CH02-KS)
Amplifier	Agilent	8449B	3008A02384	1~26.5GHz Gain 30dB	Oct. 13, 2016	Dec. 17, 2016	Oct. 12, 2017	Radiation (03CH02-KS)
Amplifier	MITEQ	TTA1840-35-H G	1887435	18GHz~40GHz	Jan. 20, 2016	Dec. 17, 2016	Jan. 19, 2017	Radiation (03CH02-KS)
AC Power Source	Chroma	61601	616010002473	N/A	NCR	Dec. 17, 2016	NCR	Radiation (03CH02-KS)
Turn Table	MF	MF7802	N/A	0~360 degree	NCR	Dec. 17, 2016	NCR	Radiation (03CH02-KS)
Antenna Mast	MF	MF7802	N/A	1 m~4 m	NCR	Dec. 17, 2016	NCR	Radiation (03CH02-KS)

NCR: No Calibration Required



5. Uncertainty of Evaluation

Uncertainty of Conducted Emission Measurement (150 kHz ~ 30 MHz)

Measuring Uncertainty for a Level of Confidence of 95% ($U = 2Uc(y)$)	2.3dB
---	-------

Uncertainty of Radiated Emission Measurement (30 MHz ~ 1000 MHz)

Measuring Uncertainty for a Level of Confidence of 95% ($U = 2Uc(y)$)	5.1dB
---	-------

Uncertainty of Radiated Emission Measurement (1GHz ~ 18GHz)

Measuring Uncertainty for a Level of Confidence of 95% ($U = 2Uc(y)$)	4.5dB
---	-------

Uncertainty of Radiated Emission Measurement (18MHz ~ 40MHz)

Measuring Uncertainty for a Level of Confidence of 95% ($U = 2Uc(y)$)	5.1dB
---	-------



Appendix B. Product Equality Declaration

Lenovo Mobile Communication Technology Ltd.

**No.999, Qishan North 2nd Road, Information & Optoelectronics Park, Torch Hi-tech
Industry Development Zone, Xiamen, P.R.China
Tel: 86-10-58866181; Fax: 86-10-56720293**

Date: January 13, 2017

Product Equality Declaration

We, Lenovo Mobile Communication Technology Ltd., declare on our sole responsibility for the product of **Dante-India SKU** as below:

The differences between **Dante- India SKU** and previous as below:

Object	1 st Source spec		2 nd Source spec	
	Specifications	Supplier	Specifications	Supplier
Battery	GK40	Ampere x	GK40	SUNWO DA
USB Cable	L25W-051000100AL	Liqi	F25W-051000100A	Fukangyu an
Charger	C-P36 (EU) C-P35 (US)	Acbel	SSW-2919EU C-P36 SPN5944A (EU) SSW-2919UMTJ C-P35 SPN5945A (US)	Salom

Except above, the others are all the same.

Should you have any questions or comments regarding this matter, please have my best attention.

Sincerely yours,

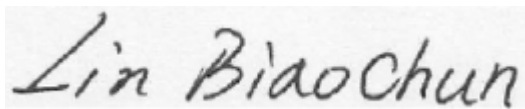

Contact Person: Lin Biaochun

COMPANY: Motorola Mobility LLC.

Tel:86- 18150396560

E-Mail: Linbc@lenovo.com



Appendix C. Original Report

Please refer to Sporton report number FC693004-04 which is issued separately.