

16_LTE Band 7_20M_QPSK_1RB_49Offset_Bottom Side_10mm_Ch21350

Communication System: UID 0, LTE (0); Frequency: 2560 MHz; Duty Cycle: 1:1
Medium: MSL_2600_161220 Medium parameters used: $f = 2560$ MHz; $\sigma = 2.156$ S/m; $\epsilon_r = 51.082$;
 $\rho = 1000$ kg/m³
Ambient Temperature : 23.4 °C; Liquid Temperature : 22.8 °C

DASY5 Configuration:

- Probe: EX3DV4 - SN3911; ConvF(7.38, 7.38, 7.38); Calibrated: 2016.09.29;
- Sensor-Surface: 2mm (Mechanical Surface Detection)
- Electronics: DAE4 Sn905; Calibrated: 2016.06.22
- Phantom: SAM (Front) with CRP v5.0; Type: QD000P40CD; Serial: TP:1795
- Measurement SW: DASY52, Version 52.8 (8); SEMCAD X Version 14.6.10 (7331)

Ch21350/Area Scan (41x81x1): Interpolated grid: dx=12mm, dy=12mm
Maximum value of SAR (interpolated) = 1.69 W/kg

Ch21350/Zoom Scan (7x7x7)/Cube 0: Measurement grid: dx=5mm, dy=5mm, dz=5mm
Reference Value = 6.614 V/m; Power Drift = 0.08 dB
Peak SAR (extrapolated) = 2.47 W/kg
SAR(1 g) = 0.926 W/kg; SAR(10 g) = 0.424 W/kg
Maximum value of SAR (measured) = 1.78 W/kg

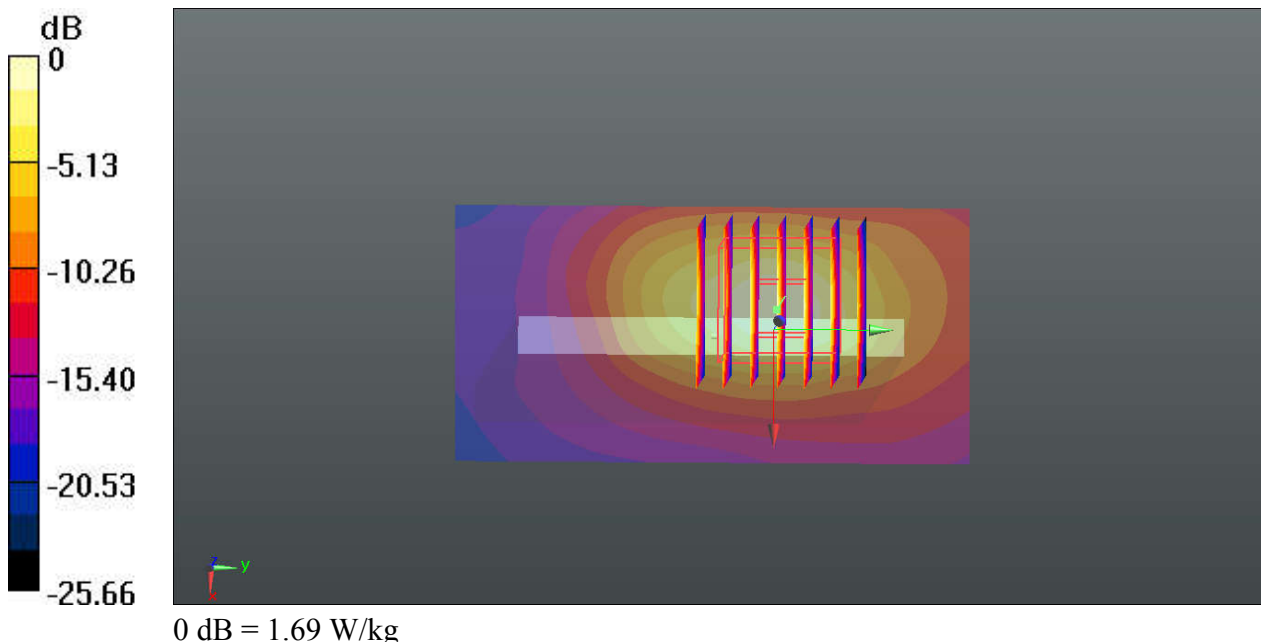

17_WLAN2.4GHz_802.11b 1Mbps_Back_10mm_Ch6

Communication System: UID 0, WIFI (0); Frequency: 2437 MHz; Duty Cycle: 1:1.021
Medium: MSL_2450_161220 Medium parameters used: $f = 2437$ MHz; $\sigma = 1.973$ S/m; $\epsilon_r = 52.403$;
 $\rho = 1000$ kg/m³
Ambient Temperature : 23.4 °C; Liquid Temperature : 22.7 °C

DASY5 Configuration:

- Probe: EX3DV4 - SN3911; ConvF(7.66, 7.66, 7.66); Calibrated: 2016.09.29;
- Sensor-Surface: 2mm (Mechanical Surface Detection)
- Electronics: DAE4 Sn905; Calibrated: 2016.06.22
- Phantom: SAM (Front) with CRP v5.0; Type: QD000P40CD; Serial: TP:1795
- Measurement SW: DASY52, Version 52.8 (8); SEMCAD X Version 14.6.10 (7331)

Ch6/Area Scan (81x61x1): Interpolated grid: dx=12mm, dy=12mm
Maximum value of SAR (interpolated) = 0.0532 W/kg

Ch6/Zoom Scan (7x7x7)/Cube 0: Measurement grid: dx=5mm, dy=5mm, dz=5mm
Reference Value = 0 V/m; Power Drift = 0.04 dB
Peak SAR (extrapolated) = 0.0630 W/kg
SAR(1 g) = 0.033 W/kg; SAR(10 g) = 0.013 W/kg
Maximum value of SAR (measured) = 0.0512 W/kg

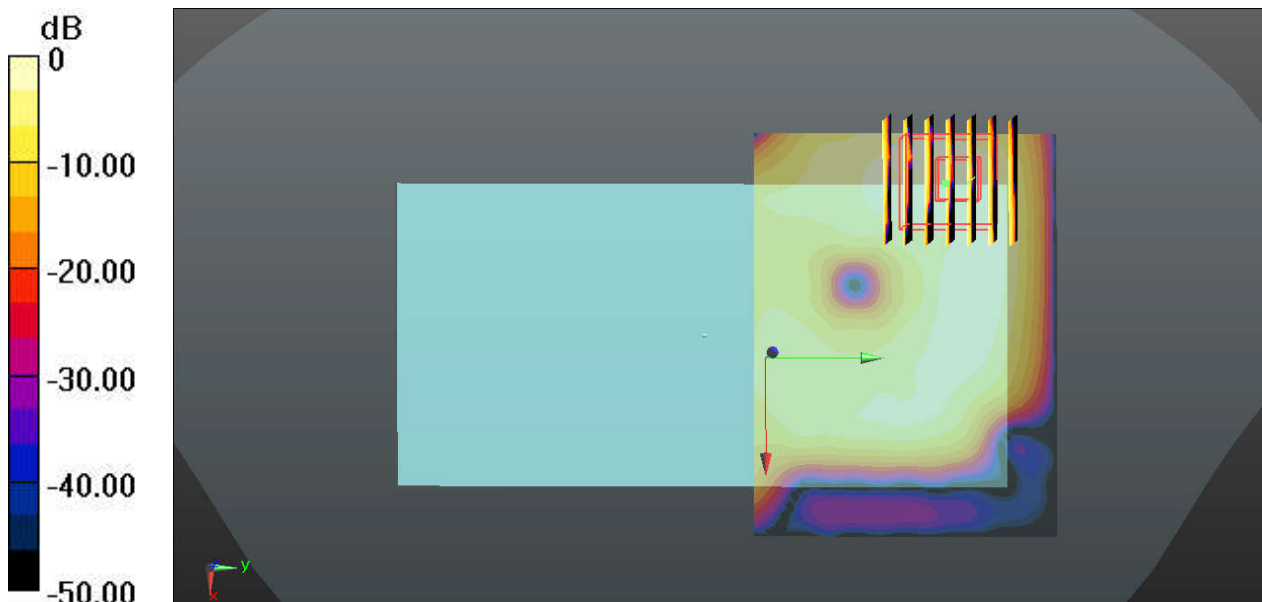

0 dB = 0.0532 W/kg

18_WLAN5.2GHz_802.11a 6Mbps_Top Side_10mm_Ch36

Communication System: UID 0, WIFI (0); Frequency: 5180 MHz; Duty Cycle: 1:1.149
Medium: MSL_5250_161223 Medium parameters used: $f = 5180$ MHz; $\sigma = 5.247$ S/m; $\epsilon_r = 49.12$; $\rho = 1000$ kg/m³
Ambient Temperature : 23.3 °C; Liquid Temperature : 22.6 °C

DASY5 Configuration:

- Probe: EX3DV4 - SN3911; ConvF(4.62, 4.62, 4.62); Calibrated: 2016.09.29;
- Sensor-Surface: 1.4mm (Mechanical Surface Detection)
- Electronics: DAE4 Sn905; Calibrated: 2016.06.22
- Phantom: SAM (Front) with CRP v5.0; Type: QD000P40CD; Serial: TP:1795
- Measurement SW: DASY52, Version 52.8 (8); SEMCAD X Version 14.6.10 (7331)

Ch36/Area Scan (41x91x1): Interpolated grid: dx=10mm, dy=10mm
Maximum value of SAR (interpolated) = 0.314 W/kg

Ch36/Zoom Scan (7x7x7)/Cube 0: Measurement grid: dx=4mm, dy=4mm, dz=1.4mm
Reference Value = 1.028 V/m; Power Drift = -0.01 dB
Peak SAR (extrapolated) = 0.528 W/kg
SAR(1 g) = 0.131 W/kg; SAR(10 g) = 0.036 W/kg
Maximum value of SAR (measured) = 0.335 W/kg

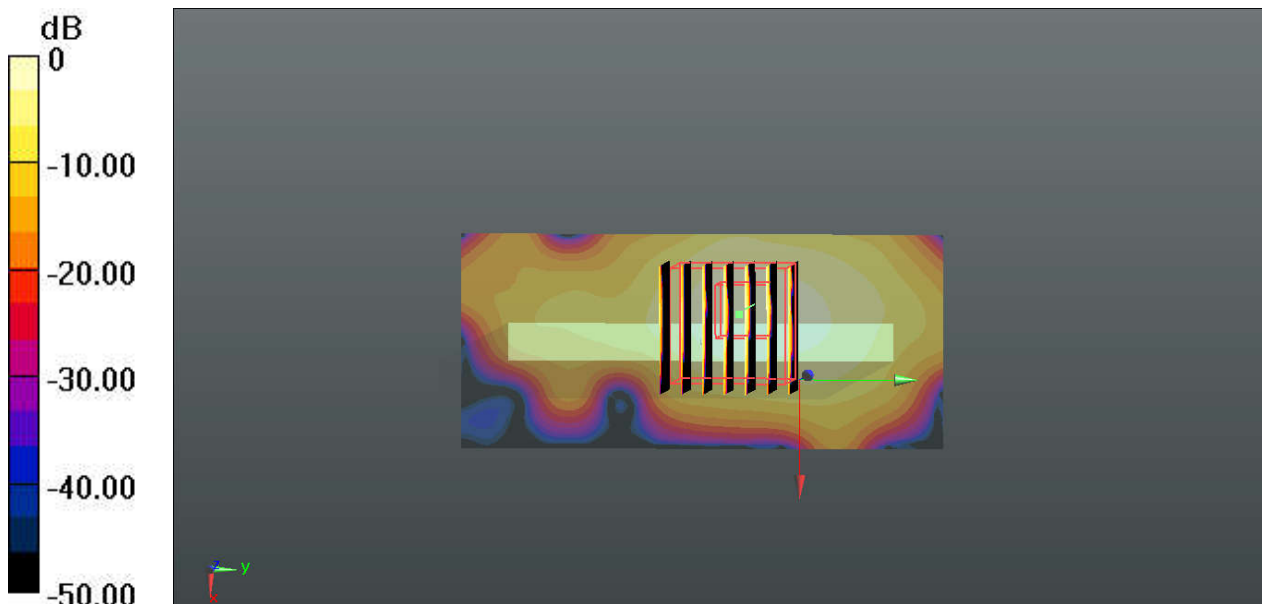

0 dB = 0.314 W/kg

19_WLAN5.8GHz_802.11a 6Mbps_Back_10mm_Ch165

Communication System: UID 0, WIFI (0); Frequency: 5825 MHz; Duty Cycle: 1:1.149
Medium: MSL_5750_161223 Medium parameters used: $f = 5825$ MHz; $\sigma = 6.2$ S/m; $\epsilon_r = 47.852$; $\rho = 1000$ kg/m³
Ambient Temperature : 23.3 °C; Liquid Temperature : 22.9 °C

DASY5 Configuration:

- Probe: EX3DV4 - SN3911; ConvF(3.95, 3.95, 3.95); Calibrated: 2016.09.29;
- Sensor-Surface: 1.4mm (Mechanical Surface Detection)
- Electronics: DAE4 Sn905; Calibrated: 2016.06.22
- Phantom: SAM (Front) with CRP v5.0; Type: QD000P40CD; Serial: TP:1795
- Measurement SW: DASY52, Version 52.8 (8); SEMCAD X Version 14.6.10 (7331)

Ch165/Area Scan (91x81x1): Interpolated grid: dx=10mm, dy=10mm

Maximum value of SAR (interpolated) = 0.116 W/kg

Ch165/Zoom Scan (7x7x7)/Cube 0: Measurement grid: dx=4mm, dy=4mm, dz=1.4mm

Reference Value = 0 V/m; Power Drift = 0.06 dB

Peak SAR (extrapolated) = 0.411 W/kg

SAR(1 g) = 0.024 W/kg; SAR(10 g) = 0.00519 W/kg

Maximum value of SAR (measured) = 0.0742 W/kg

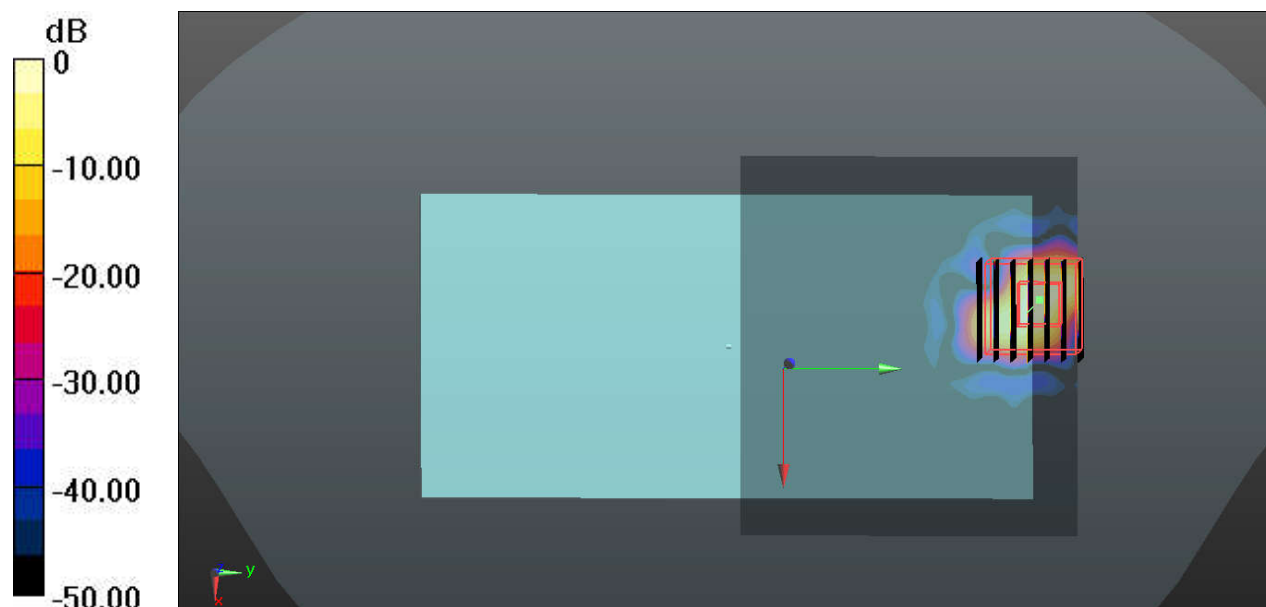

0 dB = 0.116 W/kg

20_LTE Band 7_20M_QPSK_1RB_49Offset_Front_10mm_Ch21100

Communication System: UID 0, LTE (0); Frequency: 2535 MHz; Duty Cycle: 1:1
Medium: MSL_2600_161220 Medium parameters used: $f = 2535$ MHz; $\sigma = 2.133$ S/m; $\epsilon_r = 51.194$;
 $\rho = 1000$ kg/m³
Ambient Temperature : 23.4 °C; Liquid Temperature : 22.8 °C

DASY5 Configuration:

- Probe: EX3DV4 - SN3911; ConvF(7.38, 7.38, 7.38); Calibrated: 2016.09.29;
- Sensor-Surface: 2mm (Mechanical Surface Detection)
- Electronics: DAE4 Sn905; Calibrated: 2016.06.22
- Phantom: SAM (Front) with CRP v5.0; Type: QD000P40CD; Serial: TP:1795
- Measurement SW: DASY52, Version 52.8 (8); SEMCAD X Version 14.6.10 (7331)

Ch21100/Area Scan (81x71x1): Interpolated grid: dx=12mm, dy=12mm
Maximum value of SAR (interpolated) = 1.10 W/kg

Ch21100/Zoom Scan (7x7x7)/Cube 0: Measurement grid: dx=5mm, dy=5mm, dz=5mm
Reference Value = 6.624 V/m; Power Drift = -0.03 dB
Peak SAR (extrapolated) = 1.77 W/kg
SAR(1 g) = 0.819 W/kg; SAR(10 g) = 0.361 W/kg
Maximum value of SAR (measured) = 1.26 W/kg

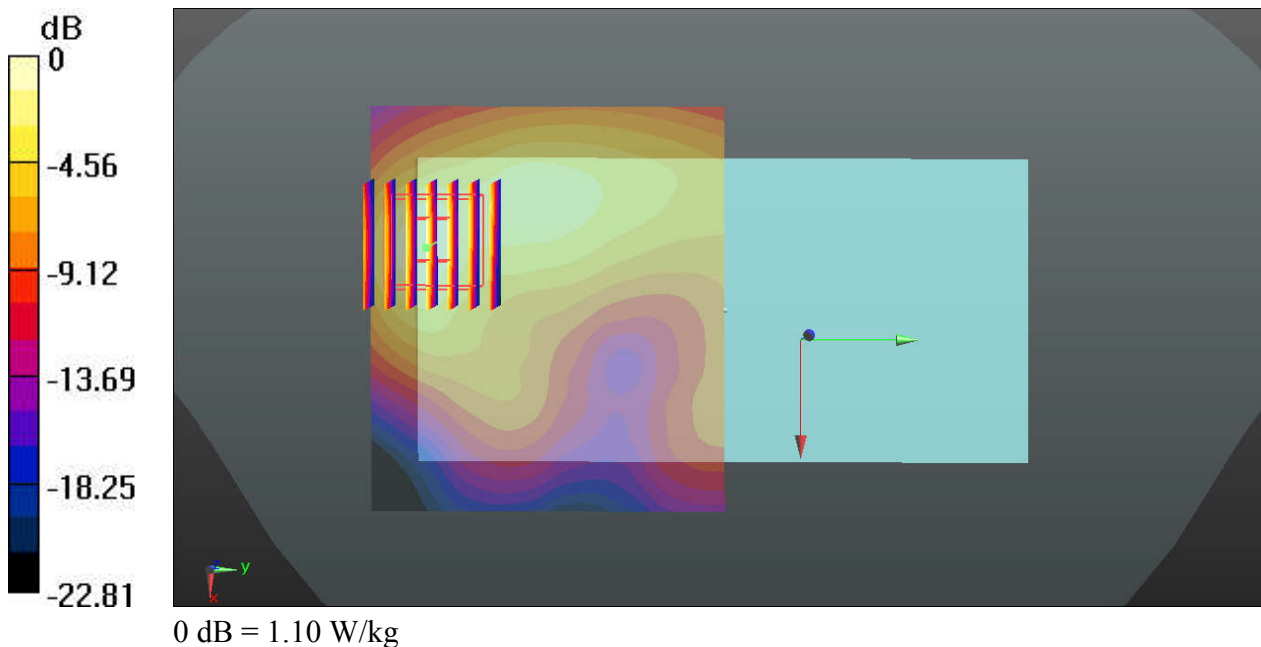

21_WLAN5.3GHz_802.11a_6Mbps_Back_10mm_Ch64

Communication System: UID 0, WIFI (0); Frequency: 5320 MHz; Duty Cycle: 1:1.149
Medium: MSL_5250_161223 Medium parameters used: $f = 5320$ MHz; $\sigma = 5.429$ S/m; $\epsilon_r = 48.73$; $\rho = 1000$ kg/m³
Ambient Temperature : 23.3 °C; Liquid Temperature : 22.6 °C

DASY5 Configuration:

- Probe: EX3DV4 - SN3911; ConvF(4.62, 4.62, 4.62); Calibrated: 2016.09.29;
- Sensor-Surface: 1.4mm (Mechanical Surface Detection)
- Electronics: DAE4 Sn905; Calibrated: 2016.06.22
- Phantom: SAM (Front) with CRP v5.0; Type: QD000P40CD; Serial: TP:1795
- Measurement SW: DASY52, Version 52.8 (8); SEMCAD X Version 14.6.10 (7331)

Ch64/Area Scan (91x81x1): Interpolated grid: dx=10mm, dy=10mm
Maximum value of SAR (interpolated) = 0.0888 W/kg

Ch64/Zoom Scan (7x7x7)/Cube 0: Measurement grid: dx=4mm, dy=4mm, dz=1.4mm
Reference Value = 0 V/m; Power Drift = 0.06 dB
Peak SAR (extrapolated) = 0.273 W/kg
SAR(1 g) = 0.026 W/kg; SAR(10 g) = 0.00759 W/kg
Maximum value of SAR (measured) = 0.0872 W/kg

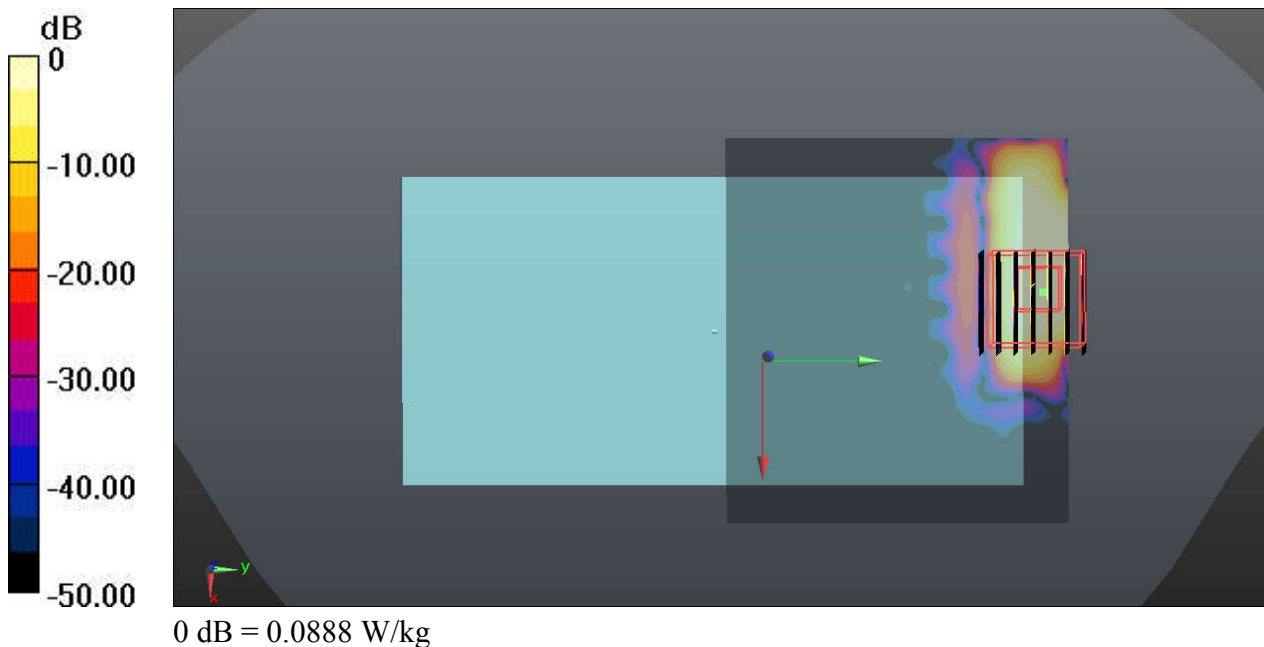

22_WLAN5.5GHz_802.11a 6Mbps_Back_10mm_Ch116

Communication System: UID 0, WIFI (0); Frequency: 5580 MHz; Duty Cycle: 1:1.141
Medium: MSL_5600_161223 Medium parameters used: $f = 5580$ MHz; $\sigma = 5.824$ S/m; $\epsilon_r = 48.215$;
 $\rho = 1000$ kg/m³
Ambient Temperature : 23.3 °C; Liquid Temperature : 22.8 °C

DASY5 Configuration:

- Probe: EX3DV4 - SN3911; ConvF(3.78, 3.78, 3.78); Calibrated: 2016.09.29;
- Sensor-Surface: 1.4mm (Mechanical Surface Detection)
- Electronics: DAE4 Sn905; Calibrated: 2016.06.22
- Phantom: SAM (Front) with CRP v5.0; Type: QD000P40CD; Serial: TP:1795
- Measurement SW: DASY52, Version 52.8 (8); SEMCAD X Version 14.6.10 (7331)

Ch116/Area Scan (91x81x1): Interpolated grid: dx=10mm, dy=10mm

Maximum value of SAR (interpolated) = 0.420 W/kg

Ch116/Zoom Scan (7x7x7)/Cube 0: Measurement grid: dx=4mm, dy=4mm, dz=1.4mm

Reference Value = 0 V/m; Power Drift = 0.04 dB

Peak SAR (extrapolated) = 0.566 W/kg

SAR(1 g) = 0.123 W/kg; SAR(10 g) = 0.034 W/kg

Maximum value of SAR (measured) = 0.358 W/kg

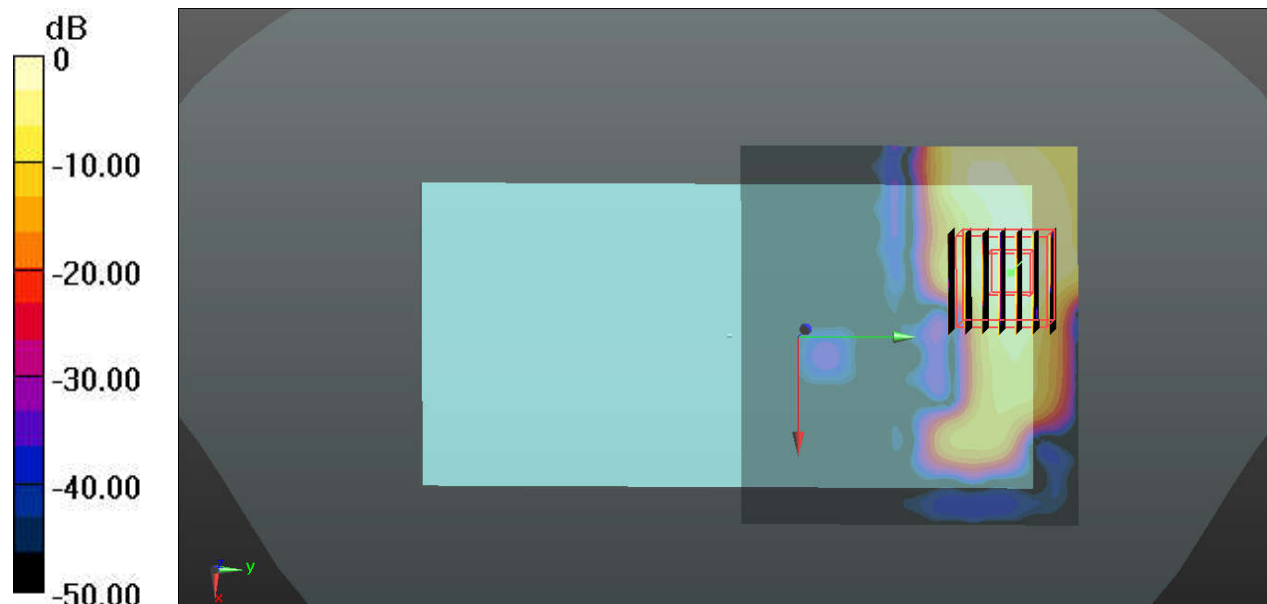

23_Bluetooth_1Mbps_Back_10mm_Ch39

Communication System: UID 0, Bluetooth (0); Frequency: 2441 MHz; Duty Cycle: 1:1.30
Medium: MSL_2450_161220 Medium parameters used: $f = 2441$ MHz; $\sigma = 1.978$ S/m; $\epsilon_r = 52.377$;
 $\rho = 1000$ kg/m³
Ambient Temperature : 23.4 °C; Liquid Temperature : 22.7 °C

DASY5 Configuration:

- Probe: EX3DV4 - SN3911; ConvF(7.66, 7.66, 7.66); Calibrated: 2016.09.29;
- Sensor-Surface: 2mm (Mechanical Surface Detection)
- Electronics: DAE4 Sn905; Calibrated: 2016.06.22
- Phantom: SAM (Front) with CRP v5.0; Type: QD000P40CD; Serial: TP:1795
- Measurement SW: DASY52, Version 52.8 (8); SEMCAD X Version 14.6.10 (7331)

Ch39/Area Scan (81x71x1): Interpolated grid: dx=12mm, dy=12mm
Maximum value of SAR (interpolated) = 0.0742 W/kg

Ch39/Zoom Scan (7x7x7)/Cube 0: Measurement grid: dx=5mm, dy=5mm, dz=5mm
Reference Value = 0 V/m; Power Drift = 0.05 dB
Peak SAR (extrapolated) = 0.0940 W/kg
SAR(1 g) = 0.044 W/kg; SAR(10 g) = 0.019 W/kg
Maximum value of SAR (measured) = 0.0682 W/kg

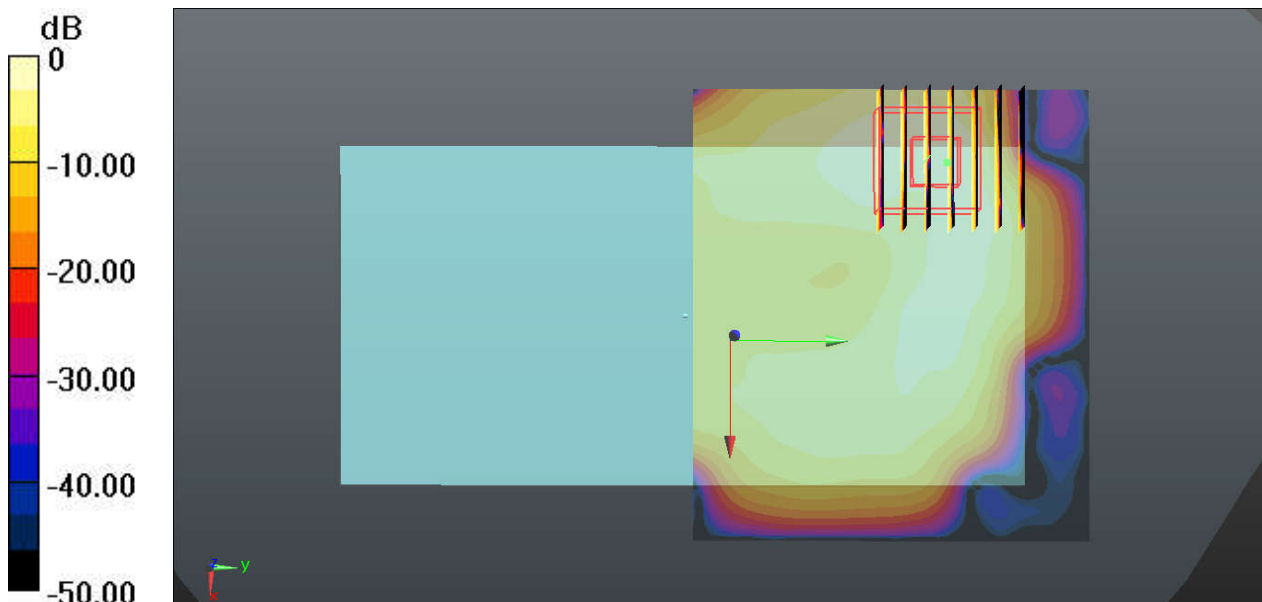

0 dB = 0.0742 W/kg



Appendix C. DASYS Calibration Certificate

The DASYS calibration certificates are shown as follows.



Accredited by the Swiss Accreditation Service (SAS)
The Swiss Accreditation Service is one of the signatories to the EA
Multilateral Agreement for the recognition of calibration certificates

Accreditation No.: **SCS 0108**

Client **Auden**

Certificate No: **D835V2-4d092_Jun16**

CALIBRATION CERTIFICATE

Object **D835V2 - SN:4d092**

Calibration procedure(s) **QA CAL-05.v9
Calibration procedure for dipole validation kits above 700 MHz**

Calibration date: **June 22, 2016**

This calibration certificate documents the traceability to national standards, which realize the physical units of measurements (SI).
The measurements and the uncertainties with confidence probability are given on the following pages and are part of the certificate.

All calibrations have been conducted in the closed laboratory facility: environment temperature (22 ± 3)°C and humidity < 70%.

Calibration Equipment used (M&TE critical for calibration)

Primary Standards	ID #	Cal Date (Certificate No.)	Scheduled Calibration
Power meter NRP	SN: 104778	06-Apr-16 (No. 217-02288/02289)	Apr-17
Power sensor NRP-Z91	SN: 103244	06-Apr-16 (No. 217-02288)	Apr-17
Power sensor NRP-Z91	SN: 103245	06-Apr-16 (No. 217-02289)	Apr-17
Reference 20 dB Attenuator	SN: 5058 (20k)	05-Apr-16 (No. 217-02292)	Apr-17
Type-N mismatch combination	SN: 5047.2 / 06327	05-Apr-16 (No. 217-02295)	Apr-17
Reference Probe EX3DV4	SN: 7349	15-Jun-16 (No. EX3-7349_Jun16)	Jun-17
DAE4	SN: 601	30-Dec-15 (No. DAE4-601_Dec15)	Dec-16
Secondary Standards	ID #	Check Date (in house)	Scheduled Check
Power meter EPM-442A	SN: GB37480704	07-Oct-15 (No. 217-02222)	In house check: Oct-16
Power sensor HP 8481A	SN: US37292783	07-Oct-15 (No. 217-02222)	In house check: Oct-16
Power sensor HP 8481A	SN: MY41092317	07-Oct-15 (No. 217-02223)	In house check: Oct-16
RF generator R&S SMT-06	SN: 100972	15-Jun-15 (in house check Jun-15)	In house check: Oct-16
Network Analyzer HP 8753E	SN: US37390585	18-Oct-01 (in house check Oct-15)	In house check: Oct-16

Calibrated by: **Claudio Leubler** Name: Claudio Leubler Function: Laboratory Technician

Approved by: **Katja Pokovic** Name: Katja Pokovic Function: Technical Manager

Signature

Issued: June 27, 2016

This calibration certificate shall not be reproduced except in full without written approval of the laboratory.



Accredited by the Swiss Accreditation Service (SAS)
The Swiss Accreditation Service is one of the signatories to the EA
Multilateral Agreement for the recognition of calibration certificates

Accreditation No.: **SCS 0108**

Glossary:

TSL	tissue simulating liquid
ConvF	sensitivity in TSL / NORM x,y,z
N/A	not applicable or not measured

Calibration is Performed According to the Following Standards:

- a) IEEE Std 1528-2013, "IEEE Recommended Practice for Determining the Peak Spatial-Averaged Specific Absorption Rate (SAR) in the Human Head from Wireless Communications Devices: Measurement Techniques", June 2013
- b) IEC 62209-1, "Procedure to measure the Specific Absorption Rate (SAR) for hand-held devices used in close proximity to the ear (frequency range of 300 MHz to 3 GHz)", February 2005
- c) IEC 62209-2, "Procedure to determine the Specific Absorption Rate (SAR) for wireless communication devices used in close proximity to the human body (frequency range of 30 MHz to 6 GHz)", March 2010
- d) KDB 865664, "SAR Measurement Requirements for 100 MHz to 6 GHz"

Additional Documentation:

- e) DASY4/5 System Handbook

Methods Applied and Interpretation of Parameters:

- *Measurement Conditions:* Further details are available from the Validation Report at the end of the certificate. All figures stated in the certificate are valid at the frequency indicated.
- *Antenna Parameters with TSL:* The dipole is mounted with the spacer to position its feed point exactly below the center marking of the flat phantom section, with the arms oriented parallel to the body axis.
- *Feed Point Impedance and Return Loss:* These parameters are measured with the dipole positioned under the liquid filled phantom. The impedance stated is transformed from the measurement at the SMA connector to the feed point. The Return Loss ensures low reflected power. No uncertainty required.
- *Electrical Delay:* One-way delay between the SMA connector and the antenna feed point. No uncertainty required.
- *SAR measured:* SAR measured at the stated antenna input power.
- *SAR normalized:* SAR as measured, normalized to an input power of 1 W at the antenna connector.
- *SAR for nominal TSL parameters:* The measured TSL parameters are used to calculate the nominal SAR result.

The reported uncertainty of measurement is stated as the standard uncertainty of measurement multiplied by the coverage factor $k=2$, which for a normal distribution corresponds to a coverage probability of approximately 95%.

Measurement Conditions

DASY system configuration, as far as not given on page 1.

DASY Version	DASY5	V52.8.8
Extrapolation	Advanced Extrapolation	
Phantom	Modular Flat Phantom	
Distance Dipole Center - TSL	15 mm	with Spacer
Zoom Scan Resolution	dx, dy, dz = 5 mm	
Frequency	835 MHz ± 1 MHz	

Head TSL parameters

The following parameters and calculations were applied.

	Temperature	Permittivity	Conductivity
Nominal Head TSL parameters	22.0 °C	41.5	0.90 mho/m
Measured Head TSL parameters	(22.0 ± 0.2) °C	41.0 ± 6 %	0.92 mho/m ± 6 %
Head TSL temperature change during test	< 0.5 °C	----	----

SAR result with Head TSL

SAR averaged over 1 cm³ (1 g) of Head TSL	Condition	
SAR measured	250 mW input power	2.40 W/kg
SAR for nominal Head TSL parameters	normalized to 1W	9.42 W/kg ± 17.0 % (k=2)

SAR averaged over 10 cm³ (10 g) of Head TSL	condition	
SAR measured	250 mW input power	1.55 W/kg
SAR for nominal Head TSL parameters	normalized to 1W	6.11 W/kg ± 16.5 % (k=2)

Body TSL parameters

The following parameters and calculations were applied.

	Temperature	Permittivity	Conductivity
Nominal Body TSL parameters	22.0 °C	55.2	0.97 mho/m
Measured Body TSL parameters	(22.0 ± 0.2) °C	54.4 ± 6 %	1.01 mho/m ± 6 %
Body TSL temperature change during test	< 0.5 °C	----	----

SAR result with Body TSL

SAR averaged over 1 cm³ (1 g) of Body TSL	Condition	
SAR measured	250 mW input power	2.48 W/kg
SAR for nominal Body TSL parameters	normalized to 1W	9.59 W/kg ± 17.0 % (k=2)

SAR averaged over 10 cm³ (10 g) of Body TSL	condition	
SAR measured	250 mW input power	1.61 W/kg
SAR for nominal Body TSL parameters	normalized to 1W	6.27 W/kg ± 16.5 % (k=2)

Appendix (Additional assessments outside the scope of SCS 0108)

Antenna Parameters with Head TSL

Impedance, transformed to feed point	51.7 Ω - 2.7 j Ω
Return Loss	- 30.1 dB

Antenna Parameters with Body TSL

Impedance, transformed to feed point	47.4 Ω - 4.5 j Ω
Return Loss	- 25.5 dB

General Antenna Parameters and Design

Electrical Delay (one direction)	1.390 ns
----------------------------------	----------

After long term use with 100W radiated power, only a slight warming of the dipole near the feedpoint can be measured.

The dipole is made of standard semirigid coaxial cable. The center conductor of the feeding line is directly connected to the second arm of the dipole. The antenna is therefore short-circuited for DC-signals. On some of the dipoles, small end caps are added to the dipole arms in order to improve matching when loaded according to the position as explained in the "Measurement Conditions" paragraph. The SAR data are not affected by this change. The overall dipole length is still according to the Standard.

No excessive force must be applied to the dipole arms, because they might bend or the soldered connections near the feedpoint may be damaged.

Additional EUT Data

Manufactured by	SPEAG
Manufactured on	September 15, 2009

DASY5 Validation Report for Head TSL

Date: 22.06.2016

Test Laboratory: SPEAG, Zurich, Switzerland

DUT: Dipole 835 MHz; Type: D835V2; Serial: D835V2 - SN:4d092

Communication System: UID 0 - CW; Frequency: 835 MHz

Medium parameters used: $f = 835$ MHz; $\sigma = 0.92$ S/m; $\epsilon_r = 41$; $\rho = 1000$ kg/m³

Phantom section: Flat Section

Measurement Standard: DASY5 (IEEE/IEC/ANSI C63.19-2011)

DASY52 Configuration:

- Probe: EX3DV4 - SN7349; ConvF(9.72, 9.72, 9.72); Calibrated: 15.06.2016;
- Sensor-Surface: 1.4mm (Mechanical Surface Detection)
- Electronics: DAE4 Sn601; Calibrated: 30.12.2015
- Phantom: Flat Phantom 4.9L; Type: QD000P49AA; Serial: 1001
- DASY52 52.8.8(1258); SEMCAD X 14.6.10(7372)

Dipole Calibration for Head Tissue/Pin=250 mW, d=15mm/Zoom Scan (7x7x7)/Cube 0:

Measurement grid: dx=5mm, dy=5mm, dz=5mm

Reference Value = 61.93 V/m; Power Drift = 0.02 dB

Peak SAR (extrapolated) = 3.61 W/kg

SAR(1 g) = 2.4 W/kg; SAR(10 g) = 1.55 W/kg

Maximum value of SAR (measured) = 3.19 W/kg

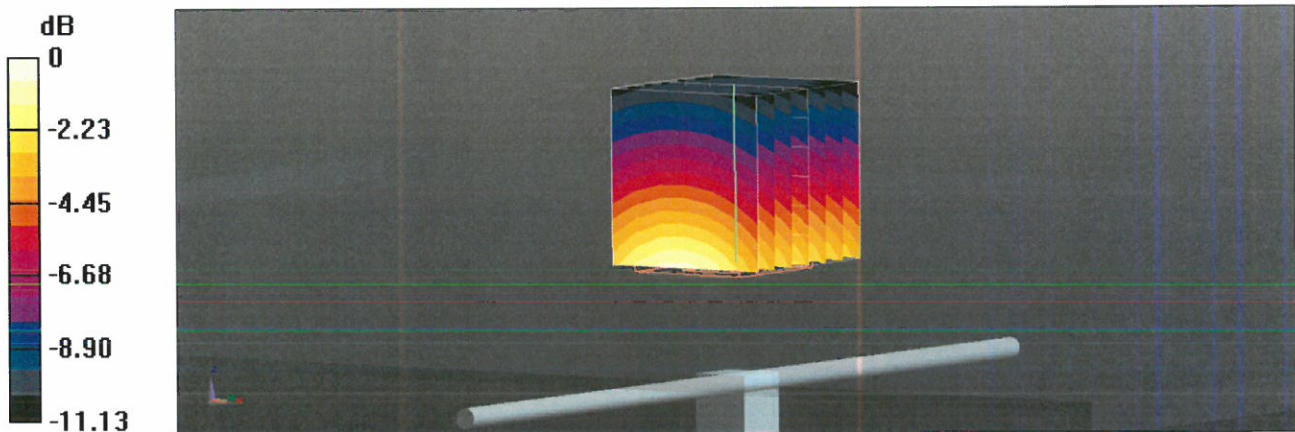

Impedance Measurement Plot for Head TSL

22 Jun 2016 12:13:11
[CH1] S11 1 U FS 1: 51.715 Ω -2.6543 Ω 71.810 pF 835.000 000 MHz

*
De1

Ca

Avg
16

H1d

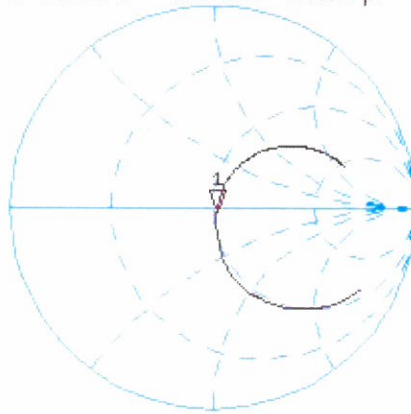

CH2 S11 LOG 5 dB/REF -20 dB 1:-30.051 dB 835.000 000 MHz

Ca

H1d

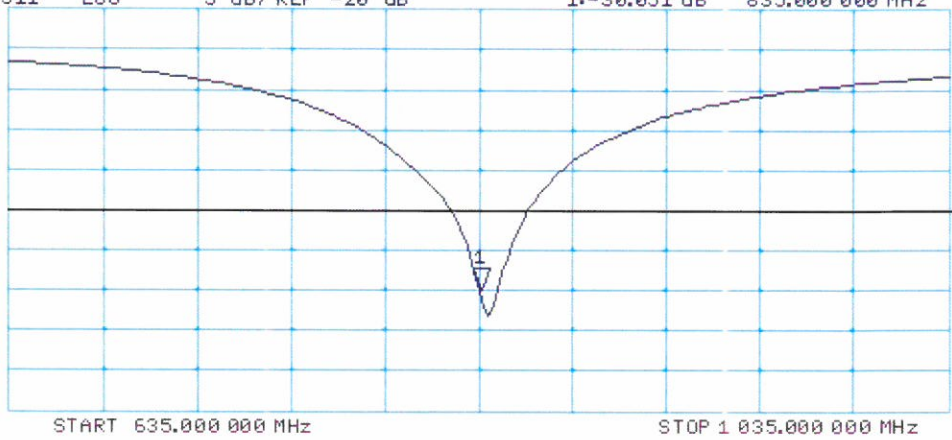

DASY5 Validation Report for Body TSL

Date: 22.06.2016

Test Laboratory: SPEAG, Zurich, Switzerland

DUT: Dipole 835 MHz; Type: D835V2; Serial: D835V2 - SN:4d092

Communication System: UID 0 - CW; Frequency: 835 MHz

Medium parameters used: $f = 835$ MHz; $\sigma = 1.01$ S/m; $\epsilon_r = 54.4$; $\rho = 1000$ kg/m³

Phantom section: Flat Section

Measurement Standard: DASY5 (IEEE/IEC/ANSI C63.19-2011)

DASY52 Configuration:

- Probe: EX3DV4 - SN7349; ConvF(9.73, 9.73, 9.73); Calibrated: 15.06.2016;
- Sensor-Surface: 1.4mm (Mechanical Surface Detection)
- Electronics: DAE4 Sn601; Calibrated: 30.12.2015
- Phantom: Flat Phantom 4.9L; Type: QD000P49AA; Serial: 1001
- DASY52 52.8.8(1258); SEMCAD X 14.6.10(7372)

Dipole Calibration for Body Tissue/ $P_{in}=250$ mW, $d=15$ mm/Zoom Scan (7x7x7)/Cube 0:

Measurement grid: $dx=5$ mm, $dy=5$ mm, $dz=5$ mm

Reference Value = 60.12 V/m; Power Drift = -0.01 dB

Peak SAR (extrapolated) = 3.63 W/kg

SAR(1 g) = 2.48 W/kg; SAR(10 g) = 1.61 W/kg

Maximum value of SAR (measured) = 3.26 W/kg

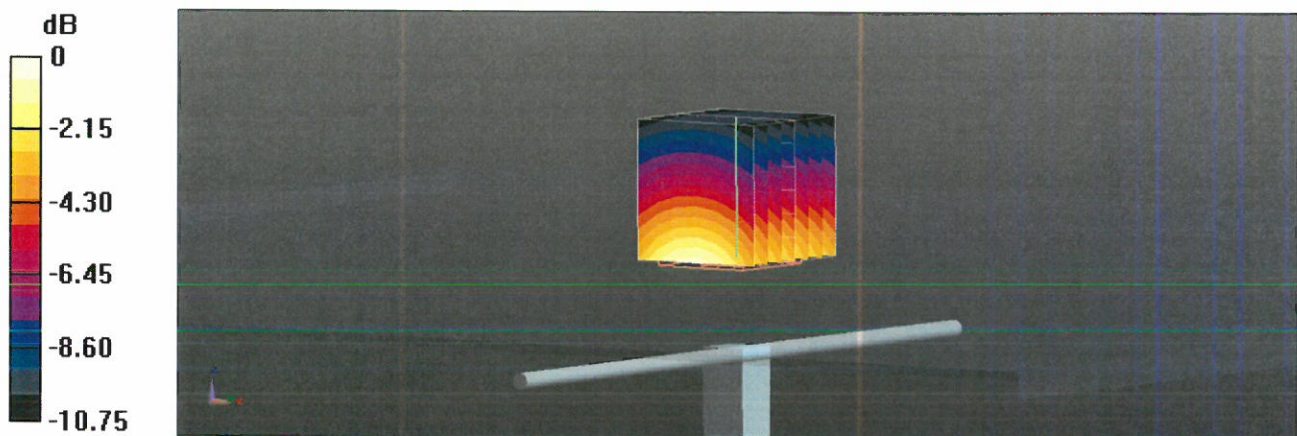

Impedance Measurement Plot for Body TSL

22 Jun 2016 11:22:12
CH1 S11 1 U FS 1: 47.447 Ω -4.4922 Ω 42.430 pF 835.000 000 MHz

*
De1

CA

Avg
16

H1 d

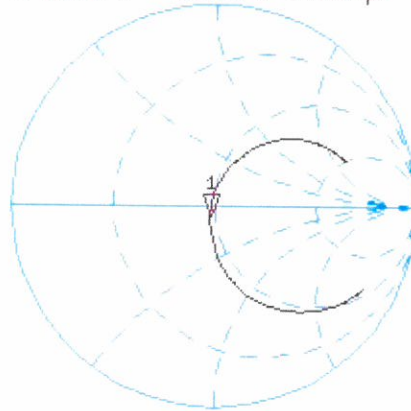

CH2 S11 LOG 5 dB/REF -20 dB 1:-25.500 dB 835.000 000 MHz

CA

H1 d

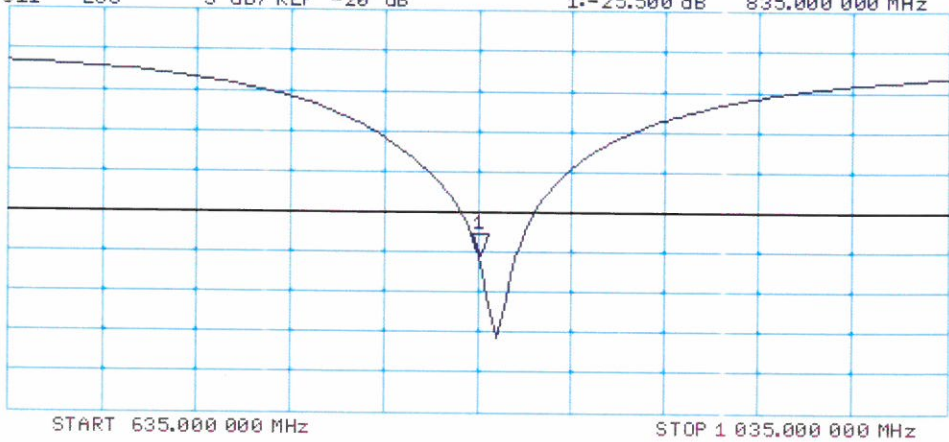



Accredited by the Swiss Accreditation Service (SAS)
The Swiss Accreditation Service is one of the signatories to the EA
Multilateral Agreement for the recognition of calibration certificates

Accreditation No.: **SCS 0108**

Client **Auden**

Certificate No: **D1900V2-5d018_Jun16**

CALIBRATION CERTIFICATE

Object: **D1900V2 - SN:5d018**

Calibration procedure(s): **QA CAL-05.v9
Calibration procedure for dipole validation kits above 700 MHz**

Calibration date: **June 21, 2016**

This calibration certificate documents the traceability to national standards, which realize the physical units of measurements (SI).
The measurements and the uncertainties with confidence probability are given on the following pages and are part of the certificate.

All calibrations have been conducted in the closed laboratory facility: environment temperature (22 ± 3)°C and humidity < 70%.

Calibration Equipment used (M&TE critical for calibration)

Primary Standards	ID #	Cal Date (Certificate No.)	Scheduled Calibration
Power meter NRP	SN: 104778	06-Apr-16 (No. 217-02288/02289)	Apr-17
Power sensor NRP-Z91	SN: 103244	06-Apr-16 (No. 217-02288)	Apr-17
Power sensor NRP-Z91	SN: 103245	06-Apr-16 (No. 217-02289)	Apr-17
Reference 20 dB Attenuator	SN: 5058 (20k)	05-Apr-16 (No. 217-02292)	Apr-17
Type-N mismatch combination	SN: 5047.2 / 06327	05-Apr-16 (No. 217-02295)	Apr-17
Reference Probe EX3DV4	SN: 7349	15-Jun-16 (No. EX3-7349_Jun16)	Jun-17
DAE4	SN: 601	30-Dec-15 (No. DAE4-601_Dec15)	Dec-16
Secondary Standards	ID #	Check Date (in house)	Scheduled Check
Power meter EPM-442A	SN: GB37480704	07-Oct-15 (No. 217-02222)	In house check: Oct-16
Power sensor HP 8481A	SN: US37292783	07-Oct-15 (No. 217-02222)	In house check: Oct-16
Power sensor HP 8481A	SN: MY41092317	07-Oct-15 (No. 217-02223)	In house check: Oct-16
RF generator R&S SMT-06	SN: 100972	15-Jun-15 (in house check Jun-15)	In house check: Oct-16
Network Analyzer HP 8753E	SN: US37390585	18-Oct-01 (in house check Oct-15)	In house check: Oct-16

Calibrated by: **Michael Weber** (Name), **Laboratory Technician** (Function), *[Signature]* (Signature)

Approved by: **Katja Pokovic** (Name), **Technical Manager** (Function), *[Signature]* (Signature)

Issued: June 28, 2016

This calibration certificate shall not be reproduced except in full without written approval of the laboratory.



Accredited by the Swiss Accreditation Service (SAS)
The Swiss Accreditation Service is one of the signatories to the EA
Multilateral Agreement for the recognition of calibration certificates

Accreditation No.: **SCS 0108**

Glossary:

TSL	tissue simulating liquid
ConvF	sensitivity in TSL / NORM x,y,z
N/A	not applicable or not measured

Calibration is Performed According to the Following Standards:

- a) IEEE Std 1528-2013, "IEEE Recommended Practice for Determining the Peak Spatial-Averaged Specific Absorption Rate (SAR) in the Human Head from Wireless Communications Devices: Measurement Techniques", June 2013
- b) IEC 62209-1, "Procedure to measure the Specific Absorption Rate (SAR) for hand-held devices used in close proximity to the ear (frequency range of 300 MHz to 3 GHz)", February 2005
- c) IEC 62209-2, "Procedure to determine the Specific Absorption Rate (SAR) for wireless communication devices used in close proximity to the human body (frequency range of 30 MHz to 6 GHz)", March 2010
- d) KDB 865664, "SAR Measurement Requirements for 100 MHz to 6 GHz"

Additional Documentation:

- e) DAS4/5 System Handbook

Methods Applied and Interpretation of Parameters:

- *Measurement Conditions:* Further details are available from the Validation Report at the end of the certificate. All figures stated in the certificate are valid at the frequency indicated.
- *Antenna Parameters with TSL:* The dipole is mounted with the spacer to position its feed point exactly below the center marking of the flat phantom section, with the arms oriented parallel to the body axis.
- *Feed Point Impedance and Return Loss:* These parameters are measured with the dipole positioned under the liquid filled phantom. The impedance stated is transformed from the measurement at the SMA connector to the feed point. The Return Loss ensures low reflected power. No uncertainty required.
- *Electrical Delay:* One-way delay between the SMA connector and the antenna feed point. No uncertainty required.
- *SAR measured:* SAR measured at the stated antenna input power.
- *SAR normalized:* SAR as measured, normalized to an input power of 1 W at the antenna connector.
- *SAR for nominal TSL parameters:* The measured TSL parameters are used to calculate the nominal SAR result.

The reported uncertainty of measurement is stated as the standard uncertainty of measurement multiplied by the coverage factor $k=2$, which for a normal distribution corresponds to a coverage probability of approximately 95%.

Measurement Conditions

DASY system configuration, as far as not given on page 1.

DASY Version	DASY5	V52.8.8
Extrapolation	Advanced Extrapolation	
Phantom	Modular Flat Phantom	
Distance Dipole Center - TSL	10 mm	with Spacer
Zoom Scan Resolution	dx, dy, dz = 5 mm	
Frequency	1900 MHz \pm 1 MHz	

Head TSL parameters

The following parameters and calculations were applied.

	Temperature	Permittivity	Conductivity
Nominal Head TSL parameters	22.0 °C	40.0	1.40 mho/m
Measured Head TSL parameters	(22.0 \pm 0.2) °C	40.1 \pm 6 %	1.39 mho/m \pm 6 %
Head TSL temperature change during test	< 0.5 °C	----	----

SAR result with Head TSL

SAR averaged over 1 cm³ (1 g) of Head TSL	Condition	
SAR measured	250 mW input power	9.96 W/kg
SAR for nominal Head TSL parameters	normalized to 1W	40.0 W/kg \pm 17.0 % (k=2)

SAR averaged over 10 cm³ (10 g) of Head TSL	condition	
SAR measured	250 mW input power	5.19 W/kg
SAR for nominal Head TSL parameters	normalized to 1W	20.8 W/kg \pm 16.5 % (k=2)

Body TSL parameters

The following parameters and calculations were applied.

	Temperature	Permittivity	Conductivity
Nominal Body TSL parameters	22.0 °C	53.3	1.52 mho/m
Measured Body TSL parameters	(22.0 \pm 0.2) °C	53.1 \pm 6 %	1.53 mho/m \pm 6 %
Body TSL temperature change during test	< 0.5 °C	----	----

SAR result with Body TSL

SAR averaged over 1 cm³ (1 g) of Body TSL	Condition	
SAR measured	250 mW input power	9.96 W/kg
SAR for nominal Body TSL parameters	normalized to 1W	39.7 W/kg \pm 17.0 % (k=2)

SAR averaged over 10 cm³ (10 g) of Body TSL	condition	
SAR measured	250 mW input power	5.27 W/kg
SAR for nominal Body TSL parameters	normalized to 1W	21.0 W/kg \pm 16.5 % (k=2)

Appendix (Additional assessments outside the scope of SCS 0108)

Antenna Parameters with Head TSL

Impedance, transformed to feed point	51.7 Ω + 1.8 j Ω
Return Loss	- 32.2 dB

Antenna Parameters with Body TSL

Impedance, transformed to feed point	48.3 Ω + 2.9 j Ω
Return Loss	- 29.3 dB

General Antenna Parameters and Design

Electrical Delay (one direction)	1.194 ns
----------------------------------	----------

After long term use with 100W radiated power, only a slight warming of the dipole near the feedpoint can be measured.

The dipole is made of standard semirigid coaxial cable. The center conductor of the feeding line is directly connected to the second arm of the dipole. The antenna is therefore short-circuited for DC-signals. On some of the dipoles, small end caps are added to the dipole arms in order to improve matching when loaded according to the position as explained in the "Measurement Conditions" paragraph. The SAR data are not affected by this change. The overall dipole length is still according to the Standard.

No excessive force must be applied to the dipole arms, because they might bend or the soldered connections near the feedpoint may be damaged.

Additional EUT Data

Manufactured by	SPEAG
Manufactured on	June 04, 2002

DASY5 Validation Report for Head TSL

Date: 21.06.2016

Test Laboratory: SPEAG, Zurich, Switzerland

DUT: Dipole 1900 MHz; Type: D1900V2; Serial: D1900V2 - SN: 5d018

Communication System: UID 0 - CW; Frequency: 1900 MHz

Medium parameters used: $f = 1900$ MHz; $\sigma = 1.39$ S/m; $\epsilon_r = 40.1$; $\rho = 1000$ kg/m³

Phantom section: Flat Section

Measurement Standard: DASY5 (IEEE/IEC/ANSI C63.19-2011)

DASY52 Configuration:

- Probe: EX3DV4 - SN7349; ConvF(8.12, 8.12, 8.12); Calibrated: 15.06.2016;
- Sensor-Surface: 1.4mm (Mechanical Surface Detection)
- Electronics: DAE4 Sn601; Calibrated: 30.12.2015
- Phantom: Flat Phantom 5.0 (front); Type: QD000P50AA; Serial: 1001
- DASY52 52.8.8(1222); SEMCAD X 14.6.10(7331)

Dipole Calibration for Head Tissue/Pin=250 mW, d=10mm/Zoom Scan (7x7x7)/Cube 0:

Measurement grid: dx=5mm, dy=5mm, dz=5mm

Reference Value = 107.6 V/m; Power Drift = -0.04 dB

Peak SAR (extrapolated) = 19.0 W/kg

SAR(1 g) = 9.96 W/kg; SAR(10 g) = 5.19 W/kg

Maximum value of SAR (measured) = 15.7 W/kg

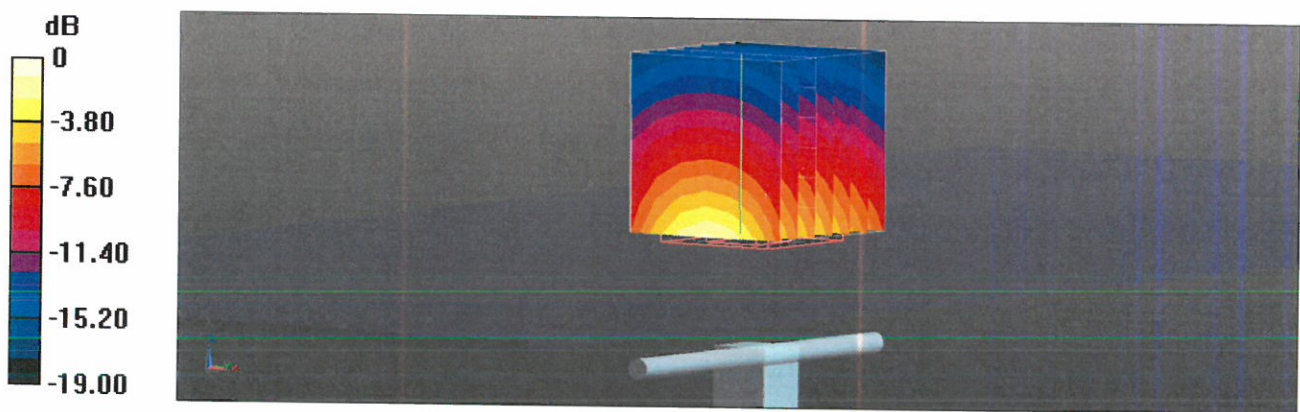

0 dB = 15.7 W/kg = 11.96 dBW/kg

Impedance Measurement Plot for Head TSL

21 Jun 2016 10:08:35
[CH1] S11 1 U FS 1: 51.672 Ω 1.8379 Ω 153.95 μ H 1 900.000 000 MHz

*
De1
Ca
Avg
16
H1d

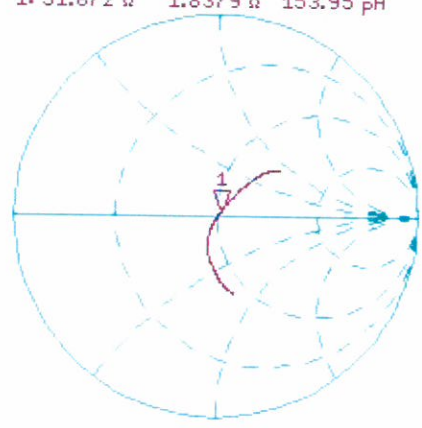

CH2 S11 LOG 5 dB/REF -20 dB 1:-32.229 dB 1 900.000 000 MHz

Ca
H1d

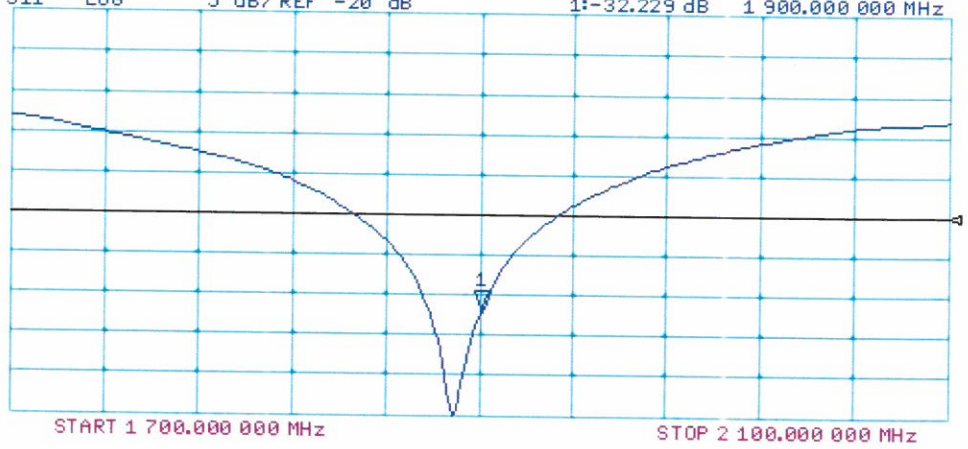

DASY5 Validation Report for Body TSL

Date: 21.06.2016

Test Laboratory: SPEAG, Zurich, Switzerland

DUT: Dipole 1900 MHz; Type: D1900V2; Serial: D1900V2 - SN: 5d018

Communication System: UID 0 - CW; Frequency: 1900 MHz

Medium parameters used: $f = 1900$ MHz; $\sigma = 1.53$ S/m; $\epsilon_r = 53.1$; $\rho = 1000$ kg/m³

Phantom section: Flat Section

Measurement Standard: DASY5 (IEEE/IEC/ANSI C63.19-2011)

DASY52 Configuration:

- Probe: EX3DV4 - SN7349; ConvF(8.03, 8.03, 8.03); Calibrated: 15.06.2016;
- Sensor-Surface: 1.4mm (Mechanical Surface Detection)
- Electronics: DAE4 Sn601; Calibrated: 30.12.2015
- Phantom: Flat Phantom 5.0 (back); Type: QD000P50AA; Serial: 1002
- DASY52 52.8.8(1222); SEMCAD X 14.6.10(7331)

Dipole Calibration for Body Tissue/Pin=250 mW, d=10mm/Zoom Scan (7x7x7)/Cube 0:

Measurement grid: dx=5mm, dy=5mm, dz=5mm

Reference Value = 103.5 V/m; Power Drift = -0.02 dB

Peak SAR (extrapolated) = 17.4 W/kg

SAR(1 g) = 9.96 W/kg; SAR(10 g) = 5.27 W/kg

Maximum value of SAR (measured) = 15.1 W/kg

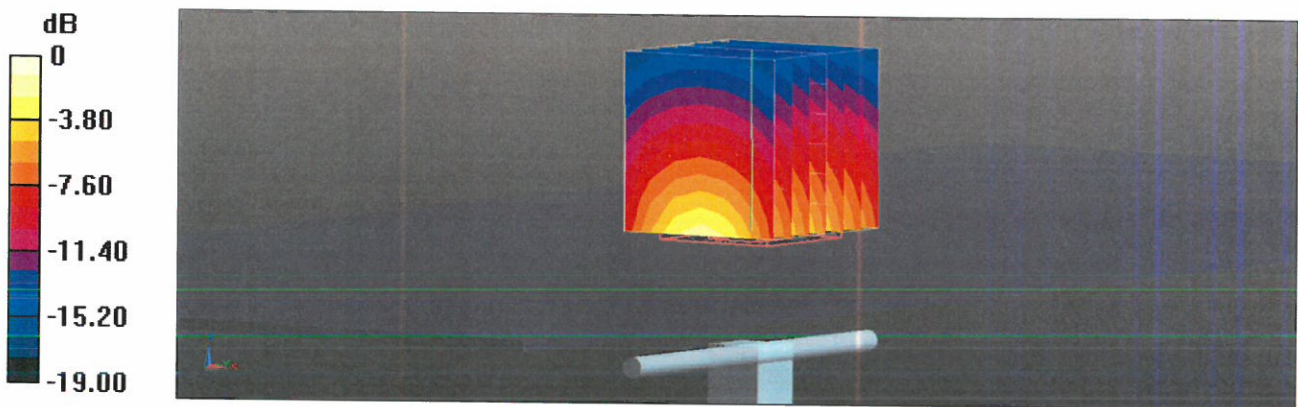

Impedance Measurement Plot for Body TSL

21 Jun 2016 10:07:34
[CH1] S11 1 U FS 1: 48.307 Ω 2.8848 Ω 241.64 μH 1 900.000 000 MHz

*
De1
Ca

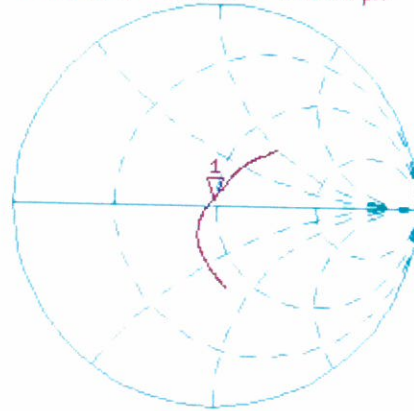

Avg
16

H1d

CH2 S11 LOG 5 dB/REF -20 dB 1: -29.320 dB 1 900.000 000 MHz

Ca

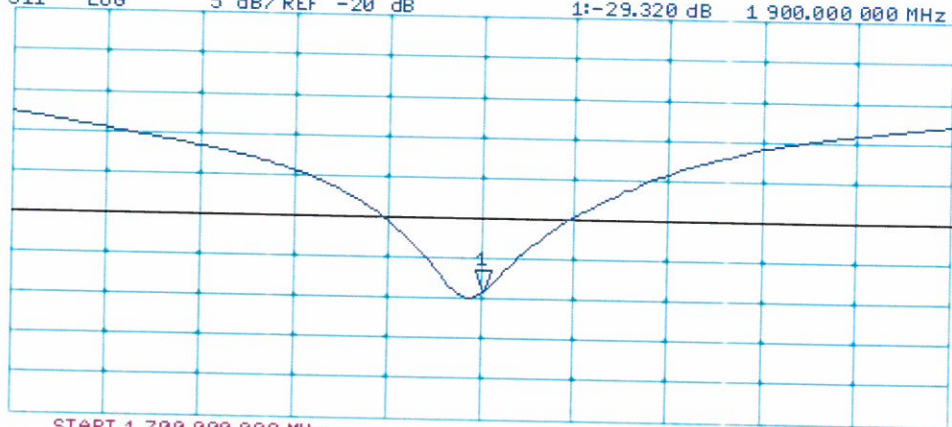

H1d