



FCC RF Test Report

APPLICANT : Motorola Mobility LLC
EQUIPMENT : Mobile Cellular Phone
BRAND NAME : Motorola
MODEL NAME : 9369, 9847
FCC ID : IHDT56VF2
STANDARD : FCC Part 15 Subpart E §15.407
CLASSIFICATION : (NII) Unlicensed National Information Infrastructure

The product was received on Sep. 30, 2016 and testing was completed on Oct. 26, 2016. We, SPORTON INTERNATIONAL (KUNSHAN) INC., would like to declare that the tested sample has been evaluated in accordance with the test procedures and has been in compliance with the applicable technical standards.

The test results in this report apply exclusively to the tested model / sample. Without written approval of SPORTON INTERNATIONAL (KUNSHAN) INC., the test report shall not be reproduced except in full.

Prepared by: James Huang / Manager



Approved by: Jones Tsai / Manager

SPORTON INTERNATIONAL (KUNSHAN) INC.
No. 3-2, PingXiang Road, Kunshan, Jiangsu Province, P. R. China



TABLE OF CONTENTS

REVISION HISTORY..... 3

SUMMARY OF TEST RESULT 4

1 GENERAL DESCRIPTION 5

 1.1 Applicant 5

 1.2 Manufacturer..... 5

 1.3 Product Feature of Equipment Under Test..... 5

 1.4 Product Specification of Equipment Under Test..... 6

 1.5 Specification of Accessory..... 6

 1.6 Modification of EUT 6

 1.7 Testing Location 7

 1.8 Applicable Standards..... 7

2 TEST CONFIGURATION OF EQUIPMENT UNDER TEST 8

 2.1 Carrier Frequency and Channel 8

 2.2 Test Mode..... 9

 2.3 Connection Diagram of Test System..... 10

 2.4 Support Unit used in test configuration and system..... 11

 2.5 EUT Operation Test Setup 12

 2.6 Measurement Results Explanation Example..... 12

3 TEST RESULT..... 13

 3.1 6dB and 26dB and 99% Occupied Bandwidth Measurement 13

 3.2 Maximum Conducted Output Power Measurement 16

 3.3 Power Spectral Density Measurement 17

 3.4 Unwanted Emissions Measurement..... 20

 3.5 AC Conducted Emission Measurement..... 25

 3.6 Frequency Stability Measurement..... 29

 3.7 Automatically Discontinue Transmission 30

 3.8 Antenna Requirements..... 31

4 LIST OF MEASURING EQUIPMENT 32

5 UNCERTAINTY OF EVALUATION 33

APPENDIX A. CONDUCTED TEST RESULTS

APPENDIX B. RADIATED SPURIOUS EMISSION

APPENDIX C. DUTY CYCLE PLOTS

APPENDIX D. SETUP PHOTOGRAPHS



REVISION HISTORY

REPORT NO.	VERSION	DESCRIPTION	ISSUED DATE
FR693004E	Rev. 01	Initial issue of report	Nov. 29, 2016



SUMMARY OF TEST RESULT

Report Section	FCC Rule	Description	Limit	Result	Remark
3.1	15.403(i)	6dB, 26dB and 99% Occupied Bandwidth	> 500kHz	Pass	-
3.2	15.407(a)	Maximum Conducted Output Power	≤ 30 dBm	Pass	-
3.3	15.407(a)	Power Spectral Density	≤ 30 dBm/500kHz	Pass	-
3.4	15.407(b)	Unwanted Emissions	15.407(b)(4)(i) & 15.209(a)	Pass	Under limit 5.54 dB at 71.710 MHz
3.5	15.207	AC Conducted Emission	15.207(a)	Pass	Under limit 9.28 dB at 0.552 MHz
3.6	15.407(g)	Frequency Stability	Within Operation Band	Pass	-
3.7	15.407(c)	Automatically Discontinue Transmission	Discontinue Transmission	Pass	-
3.8	15.203 & 15.407(a)	Antenna Requirement	N/A	Pass	-



1 General Description

1.1 Applicant

Motorola Mobility LLC
222 W, Merchandise Mart Plaza, Chicago IL 60654 USA

1.2 Manufacturer

Motorola Mobility LLC
222 W, Merchandise Mart Plaza, Chicago IL 60654 USA

1.3 Product Feature of Equipment Under Test

Product Feature	
Equipment	Mobile Cellular Phone
Brand Name	Motorola
Model Name	9369, 9847
FCC ID	IHDT56VF2
EUT supports Radios application	GSM/GPRS/EGPRS/WCDMA/HSPA/HSPA+(16QAM uplink is not supported)/DC-HSDPA/LTE WLAN2.4GHz 802.11b/g/n HT20 WLAN5GHz 802.11a/n HT20/HT40 Bluetooth v3.0 + EDR/Bluetooth v4.0 LE Bluetooth v4.2 LE
IMEI Code	Conducted: 351864080029279/351864080029287 Conduction: 351864080029238/351864080029246 Radiation: 351864080029311/351864080029329
HW Version	DVT2(V5.0)
SW Version	cedric-userdebug 7.0 NPP25.73 270 intcfg,test-keys
EUT Stage	Identical Prototype

Remark:

1. The above EUT's information was declared by manufacturer. Please refer to the specifications or user's manual for more detailed description.
2. There are two types of EUT sample 1 and sample 2, the differences between two samples are only for SIM slot, sample 1(Model name: 9369) is dual SIM slot, sample 2(Model name: 9847) is single SIM slot. According to the difference, the sample 1 to perform full test.

1.4 Product Specification of Equipment Under Test

Standards-related Product Specification	
Tx/Rx Channel Frequency Range	5745 MHz ~ 5825 MHz
Maximum Output Power	<5745 MHz ~ 5825 MHz> 802.11a : 14.94 dBm / 0.0312 W 802.11n HT20 : 14.34 dBm / 0.0274 W 802.11n HT40 : 8.80 dBm / 0.0076 W
99% Occupied Bandwidth	802.11a : 19.28 MHz 802.11n HT20 : 20.08 MHz 802.11n HT40 : 36.96 MHz
Type of Modulation	802.11a/n : OFDM (BPSK / QPSK / 16QAM / 64QAM)
Antenna Type / Gain	PIFA Antenna with gain 0.08 dBi

1.5 Specification of Accessory

Specification of Accessory				
AC Adapter	Brand Name	Motorola (Acbel)	Model Name	C-P35
	Power Rating	I/P: 100-240 Vac, 300mA, O/P: 5.2Vdc, 2000mA		
Battery	Brand Name	Motorola (ATL)	Model Name	GK40
	Power Rating	3.8Vdc, 2685/2800mAh (Min/Typ)	Type	Li-ion
Earphone	Brand Name	Motorola	Model Name	SJYN1181B
	Signal Line Type	1.2 meter, non-shielded cable, without ferrite core		
USB Cable	Brand Name	Motorola (Liqi)	Model Name	L25W-051000100AL
	Signal Line Type	1.0 meter, non-shielded cable, without ferrite core		

1.6 Modification of EUT

No modifications are made to the EUT during all test items.



1.7 Testing Location

Test Site	SPORTON INTERNATIONAL (KUNSHAN) INC.			
Test Site Location	No. 3-2, PingXiang Road, Kunshan, Jiangsu Province, P. R. China TEL: +86-0512-5790-0158 FAX: +86-0512-5790-0958			
Test Site No.	Sporton Site No.			FCC Registration No.
	TH01-KS	CO01-KS	03CH03-KS	306251

Note: The test site complies with ANSI C63.4 2014 requirement.

1.8 Applicable Standards

According to the specifications of the manufacturer, the EUT must comply with the requirements of the following standards:

- FCC Part 15 Subpart E
- FCC KDB 789033 D02 General UNII Test Procedures New Rules v01r03
- ANSI C63.10-2013

Remark:

1. All test items were verified and recorded according to the standards and without any deviation during the test.
2. This EUT has also been tested and complied with the requirements of FCC Part 15, Subpart B, recorded in a separate test report.



2 Test Configuration of Equipment Under Test

The EUT has been associated with peripherals and configuration operated in a manner tended to maximize its emission characteristics in a typical application. Frequency range investigated: conducted emission (150 kHz to 30 MHz) and radiated emission (9 kHz to the 10th harmonic of the highest fundamental frequency or to 40 GHz, whichever is lower). For radiated measurement, pre-scanned in three orthogonal panels, X, Y, Z. The worst cases were recorded in this report.

2.1 Carrier Frequency and Channel

Frequency Band	Channel	Freq. (MHz)	Channel	Freq. (MHz)
5745-5825 MHz Band 4 (U-NII-3)	149	5745	157	5785
	151*	5755	159*	5795
	153	5765	161	5805
	-	-	165	5825

Note:

1. The above Frequency and Channel in "*" were 802.11n HT40.



2.2 Test Mode

Final test mode of conducted test items and radiated spurious emissions are considering the modulation and worse data rates from the power table described in section 2.2.

Modulation	Data Rate
802.11a	6 Mbps
802.11n HT20	MCS0
802.11n HT40	MCS0

AC Conducted Emission	Mode 1 : GSM850 Idle + Bluetooth Link + WLAN Link (5G) + USB Cable (Charging from Adapter) + Earphone
------------------------------	---

Ch. #		Band IV : 5725-5850 MHz		
		802.11a	802.11n HT20	802.11n HT40
L	Low	149	149	151
M	Middle	157	157	-
H	High	165	165	159

2.3 Connection Diagram of Test System

<WLAN Tx Mode for WLAN5GHz 802.11a/n HT40>

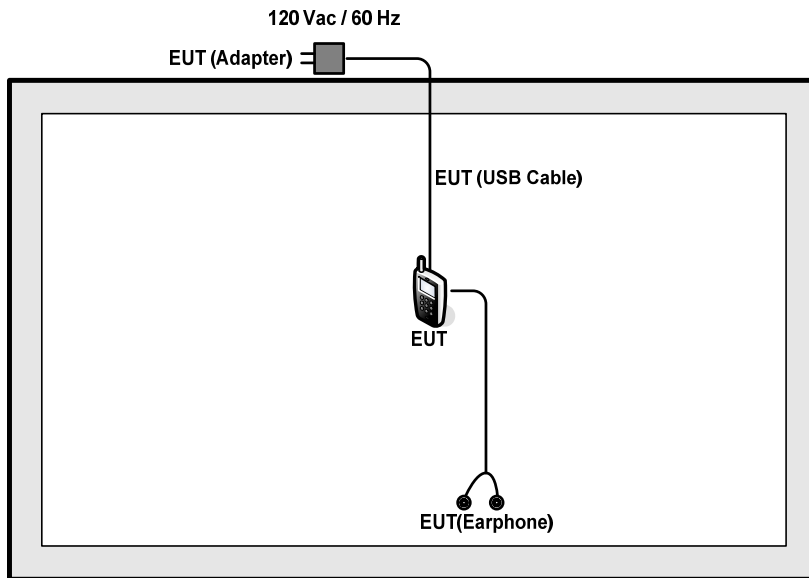

<WLAN Tx Mode for WLAN5GHz 802.11n HT20>



<AC Conducted Emission Mode>

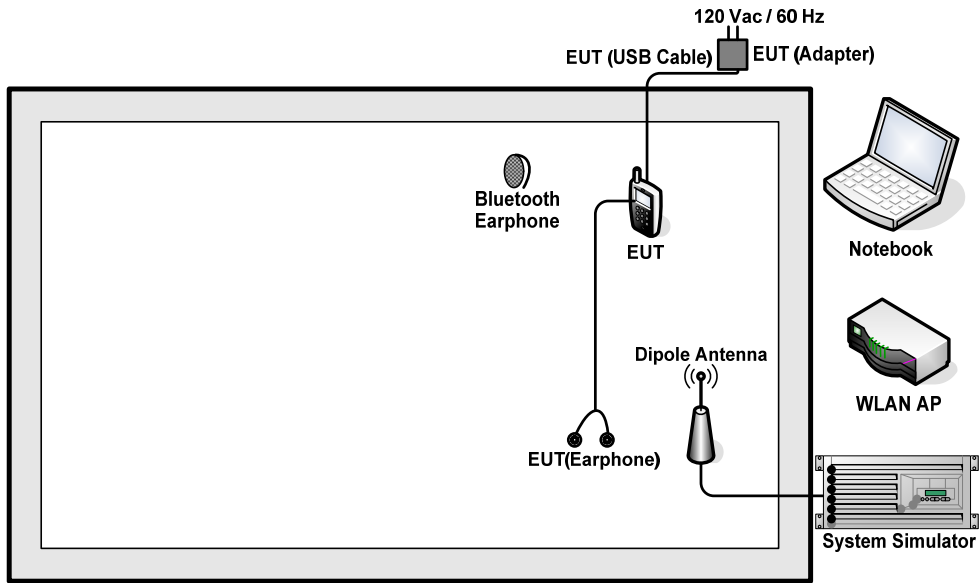

2.4 Support Unit used in test configuration and system

Item	Equipment	Trade Name	Model Name	FCC ID	Data Cable	Power Cord
1.	System Simulator	R&S	CMU 200	N/A	N/A	Unshielded, 1.8 m
2.	WLAN AP	D-link	DIR-855	KA2DIR855A2	N/A	Unshielded, 1.8 m
3.	Notebook	Lenovo	G480	N/A	N/A	AC I/P: Unshielded, 1.8 m DC O/P: Shielded, 1.8 m
4.	Bluetooth Earphone	Lenovo	LBH308	N/A	N/A	N/A



2.5 EUT Operation Test Setup

For WLAN RF test items, an engineering test program was provided and enabled to make EUT continuously transmit/receive.

For AC power line conducted emissions, the EUT was set to connect with the Notebook under large package sizes transmission.

2.6 Measurement Results Explanation Example

For all conducted test items:

The offset level is set in the spectrum analyzer to compensate the RF cable loss between EUT conducted output port and spectrum analyzer. With the offset compensation, the spectrum analyzer reading level is exactly the EUT RF output level.

Example :

The spectrum analyzer offset is derived from RF cable loss.

Offset = RF cable loss.

Following shows an offset computation example with cable loss 7.5dB.

$$\begin{aligned} \text{Offset}(dB) &= \text{RF cable loss}(dB). \\ &= 7.5 \text{ (dB)} \end{aligned}$$

3 Test Result

3.1 6dB and 26dB and 99% Occupied Bandwidth Measurement

3.1.1 Description of 6dB and 26dB and 99% Occupied Bandwidth

The minimum 6 dB bandwidth shall be at least 500 kHz.

26dB and 99% Occupied bandwidth are reporting only.

3.1.2 Measuring Instruments

The measuring equipment is listed in the section 4 of this test report.

3.1.3 Test Procedures

1. The testing follows FCC KDB 789033 D02 General UNII Test Procedures New Rules v01r03. Section C) Emission bandwidth for the band 5.725-5.85GHz
2. Set RBW = 100kHz.
3. Set the VBW $\geq 3 \times$ RBW.
4. Detector = Peak.
5. Trace mode = max hold
6. Measure the maximum width of the emission that is 6 dB down from the peak of the emission.
7. Measure and record the results in the test report.

3.1.4 Test Setup

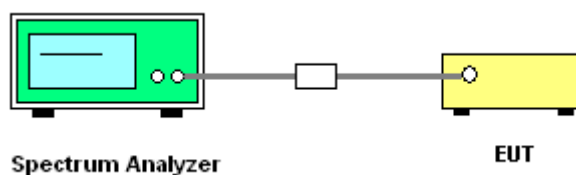



3.1.5 Test Result of 6dB Bandwidth

Please refer to Appendix A.

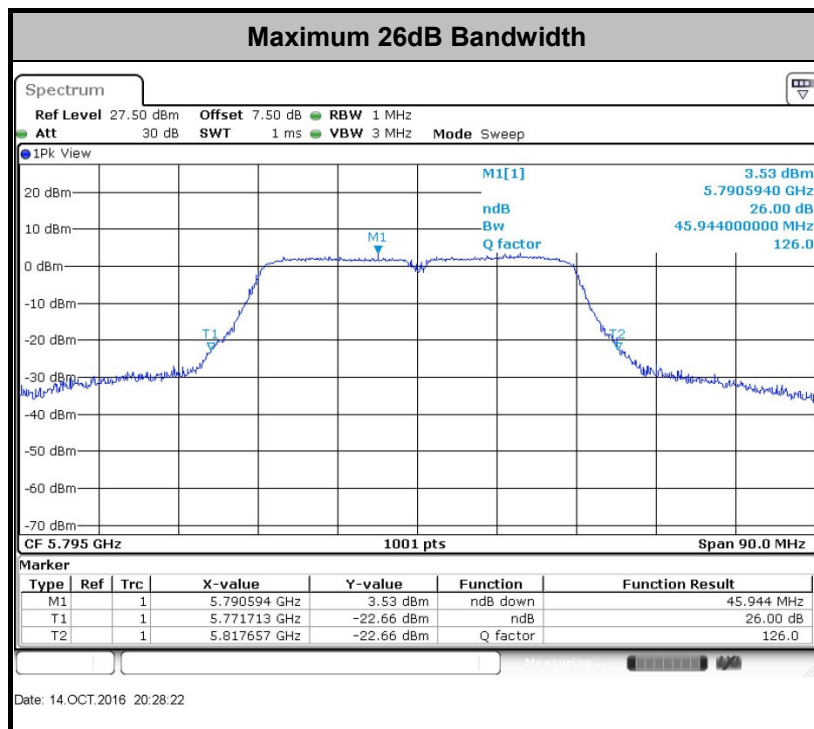
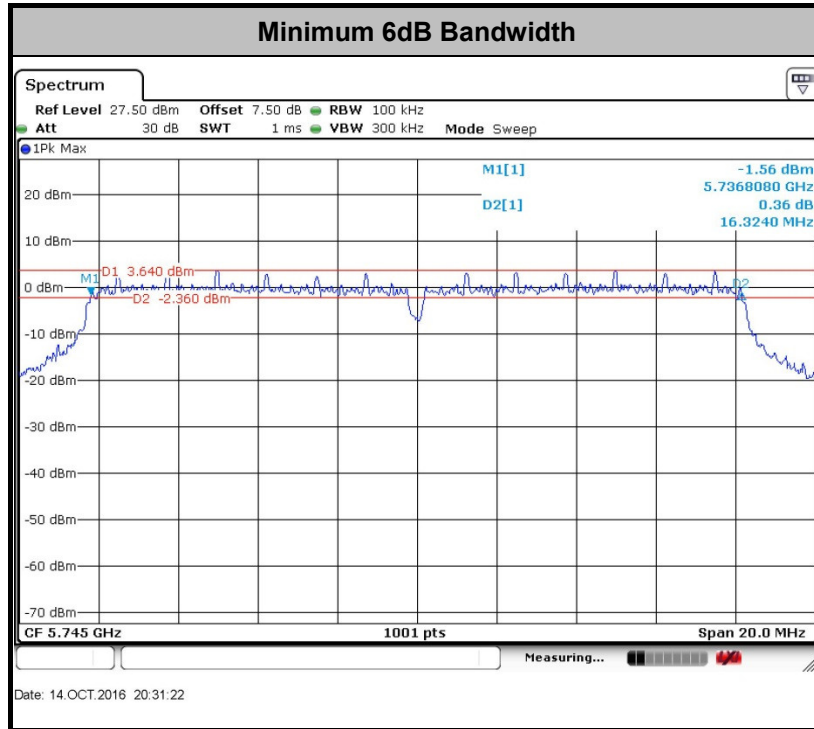

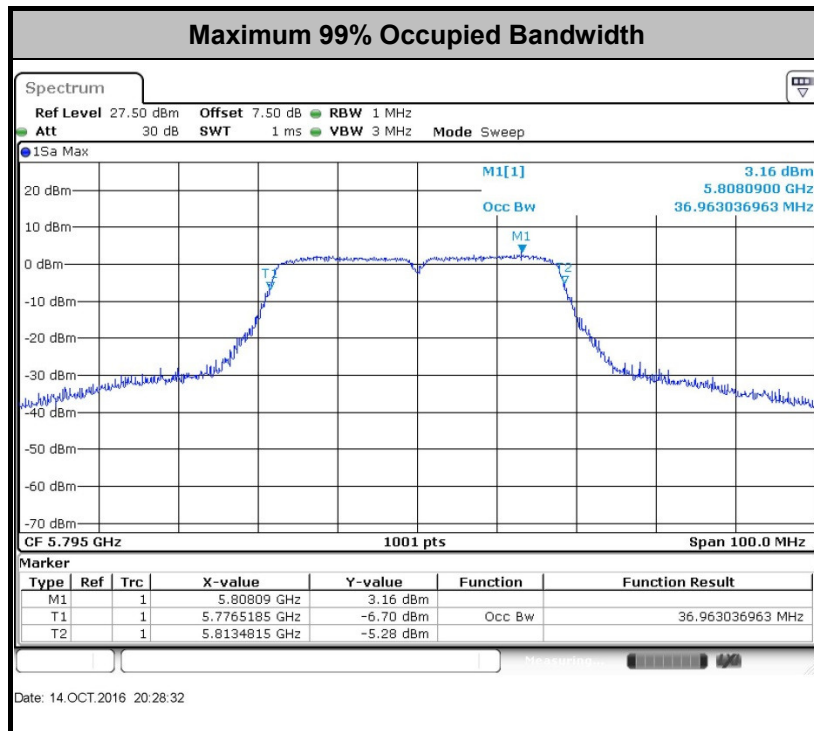

Note: The occupied channel bandwidth is maintained within the band of operation for all of the modulations.

3.2 Maximum Conducted Output Power Measurement

3.2.1 Limit of Maximum Conducted Output Power

For the band 5.725–5.85 GHz, the maximum conducted output power over the frequency band of operation shall not exceed 1 W.

If transmitting antennas of directional gain greater than 6 dBi are used, the peak output power shall be reduced by the amount in dB that the directional gain of the antenna exceeds 6 dBi.

3.2.2 Measuring Instruments

The measuring equipment is listed in the section 4 of this test report.

3.2.3 Test Procedures

The testing follows Method PM of FCC KDB 789033 D02 General UNII Test Procedures New Rules v01r03.

Method PM (Measurement using an RF average power meter):

1. Measurement is performed using a wideband RF power meter.
2. The EUT is configured to transmit continuously with a consistent duty cycle at its maximum power control level.
3. Measure the average power of the transmitter, and the average power is corrected with duty factor, $10 \log(1/x)$, where x is the duty cycle.

3.2.4 Test Setup

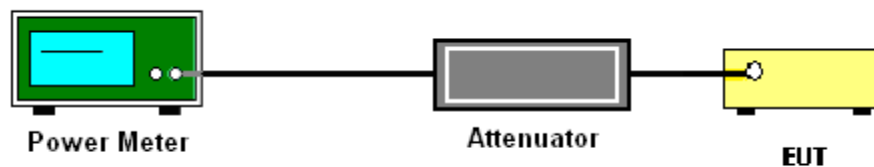

3.2.5 Test Result of Maximum Conducted Output Power

Please refer to Appendix A.



3.3 Power Spectral Density Measurement

3.3.1 Limit of Power Spectral Density

For the band 5.725–5.85 GHz, the maximum power spectral density shall not exceed 30 dBm in any 500-kHz band.

If transmitting antennas of directional gain greater than 6 dBi are used, the peak output power shall be reduced by the amount in dB that the directional gain of the antenna exceeds 6 dBi.

3.3.2 Measuring Instruments

The measuring equipment is listed in the section 4 of this test report.

3.3.3 Test Procedures

The testing follows FCC KDB 789033 D02 General UNII Test Procedures New Rules v01r03. Section F) Maximum power spectral density.

Method SA-2

(trace averaging across on and off times of the EUT transmissions, followed by duty cycle correction).

- Measure the duty cycle.
- Set span to encompass the entire emission bandwidth (EBW) of the signal.
- Set RBW = 300 kHz.
- Set VBW \geq 1 MHz.
- Number of points in sweep \geq 2 Span / RBW.
- Sweep time = auto.
- Detector = RMS
- Trace average at least 100 traces in power averaging mode.
- Add $10 \log(500\text{kHz}/\text{RBW})$ to the test result.
- Add $10 \log(1/x)$, where x is the duty cycle, to the measured power in order to compute the average power during the actual transmission times. For example, add $10 \log(1/0.25) = 6$ dB if the duty cycle is 25 percent.

1. The RF output of EUT was connected to the spectrum analyzer by a low loss cable.
2. Each plot has already offset with cable loss, and attenuator loss. Measure the PPSD and record it.

3.3.4 Test Setup

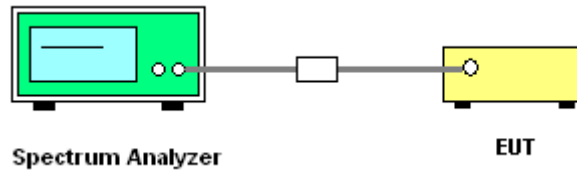



3.3.5 Test Result of Power Spectral Density

Please refer to Appendix A.

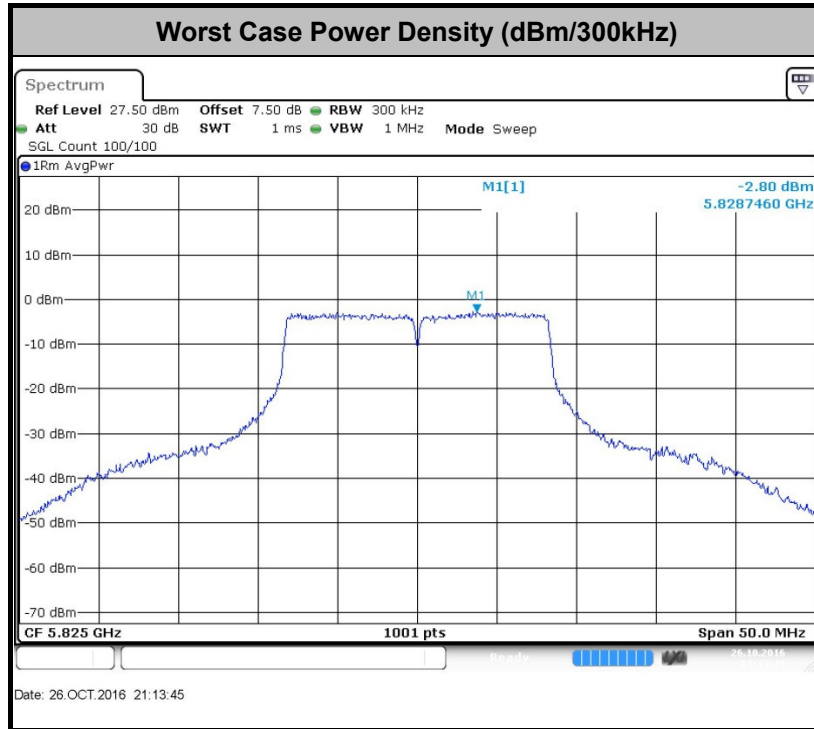



3.4 Unwanted Emissions Measurement

This section as specified in FCC Part 15.407(b) is to measure unwanted emissions through radiated measurement for band edge spurious emissions and out of band emissions measurement. The unwanted emissions shall comply with 15.407(b)(1) to (6), and restricted bands per FCC Part15.205.

3.4.1 Limit of Unwanted Emissions

(1) For transmitters operating in the 5.725-5.85 GHz band:

15.407(b)(4)(i) All emissions shall be limited to a level of -27 dBm/MHz at 75 MHz or more above or below the band edge increasing linearly to 10 dBm/MHz at 25 MHz above or below the band edge, and from 25 MHz above or below the band edge increasing linearly to a level of 15.6 dBm/MHz at 5 MHz above or below the band edge, and from 5 MHz above or below the band edge increasing linearly to a level of 27 dBm/MHz at the band edge.

(2) Unwanted spurious emissions fallen in restricted bands per FCC Part15.205 shall comply with the general field strength limits set forth in § 15.209 as below table,

Frequency (MHz)	Field Strength (microvolts/meter)	Measurement Distance (meters)
0.009 – 0.490	2400/F(kHz)	300
0.490 – 1.705	24000/F(kHz)	30
1.705 – 30.0	30	30
30 – 88	100	3
88 – 216	150	3
216 - 960	200	3
Above 960	500	3

Note: The following formula is used to convert the EIRP to field strength.

$$E = \frac{1000000\sqrt{30P}}{3} \mu\text{V/m, where P is the eirp (Watts)}$$



EIRP (dBm)	Field Strength at 3m (dBμV/m)
-17	78.3
- 27	68.3

(3) KDB 789033 D02 General UNII Test Procedures New Rules v01r03 G)2)c) As specified in 15.407(b), emissions above 1000 MHz that are outside of the restricted bands are subject to a peak emission limit of -27 dBm/MHz (or -17 dBm/MHz as specified in 15.407(b)(4)). However, an out-of-band emission that complies with both the average and peak limits of 15.209 is not required to satisfy the -27 dBm/MHz or -17 dBm/MHz peak emission limit.

3.4.2 Measuring Instruments

The measuring equipment is listed in the section 4 of this test report.

3.4.3 Test Procedures

1. The testing follows FCC KDB 789033 D02 General UNII Test Procedures New Rules v01r03. Section G) Unwanted emissions measurement.

(1) Procedure for Unwanted Emissions Measurements Below 1000MHz

- RBW = 120 kHz
- VBW = 300 kHz
- Detector = Peak
- Trace mode = max hold

(2) Procedure for Peak Unwanted Emissions Measurements Above 1000 MHz

- RBW = 1 MHz
- VBW ≥ 3 MHz
- Detector = Peak
- Sweep time = auto
- Trace mode = max hold

(3) Procedures for Average Unwanted Emissions Measurements Above 1000MHz

- RBW = 1 MHz
- VBW = 10 Hz, when duty cycle is no less than 98 percent.
- $VBW \geq 1/T$, when duty cycle is less than 98 percent where T is the minimum transmission duration over which the transmitter is on and is transmitting at its maximum power control level for the tested mode of operation.

2. The EUT was placed on a turntable with 0.8 meter for frequency below 1GHz and 1.5 meter for frequency above 1GHz respectively above ground.
3. The EUT was set 3 meters from the interference receiving antenna which was mounted on the top of a variable height antenna tower.
4. The antenna is a broadband antenna and its height is adjusted between one meter and four meters above ground to find the maximum value of the field strength for both horizontal polarization and vertical polarization of the antenna.
5. For each suspected emission, the EUT was arranged to its worst case and then adjust the antenna tower (from 1 m to 4 m) and turntable (from 0 degree to 360 degrees) to find the maximum reading.
6. For testing below 1GHz, if the emission level of the EUT in peak mode was 3 dB lower than the limit specified, then peak values of EUT will be reported, otherwise, the emissions will be repeated one by one using the CISPR quasi-peak method and reported.
7. For testing above 1GHz, the emission level of the EUT in peak mode was 20dB lower than average limit (that means the emission level in average mode also complies with the limit in average mode), then peak values of EUT will be reported, otherwise, the emissions will be measured in average mode again and reported.

3.4.4 Test Setup

For radiated emissions below 30MHz

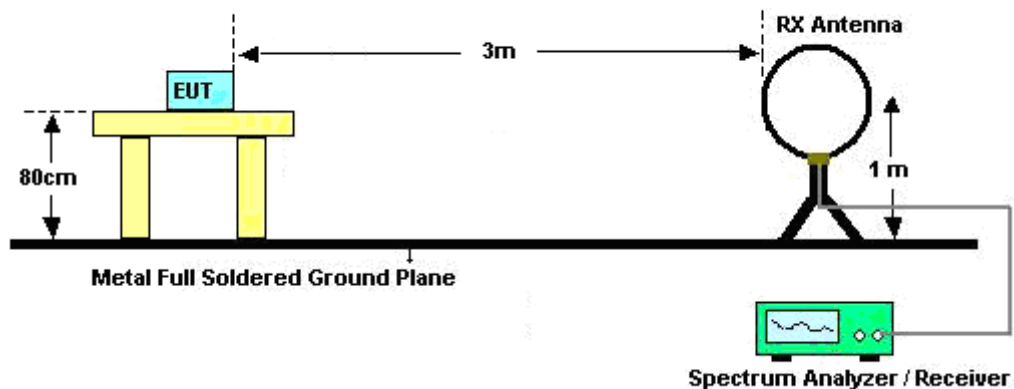

For radiated emissions from 30MHz to 1GHz

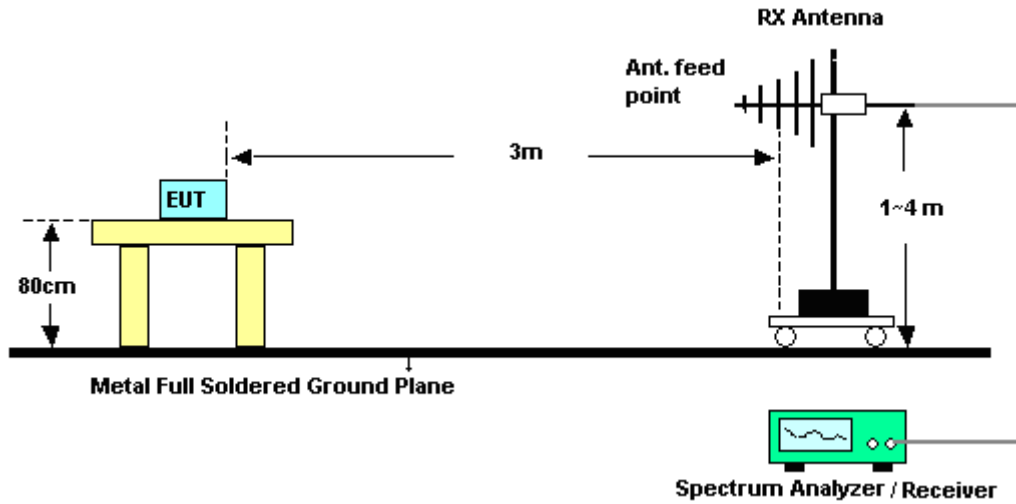

For radiated emissions above 1GHz

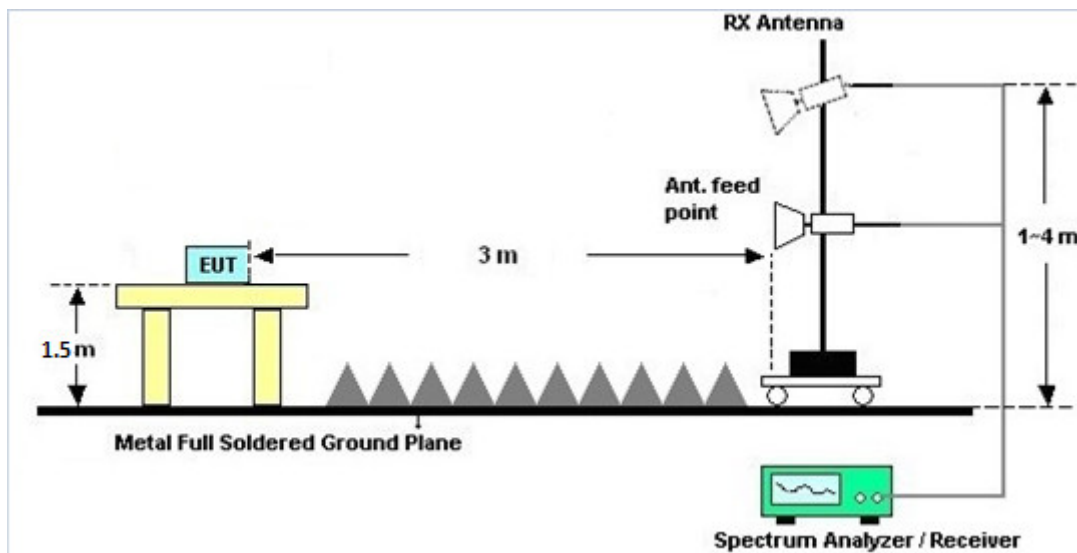



3.4.5 Test Results of Radiated Spurious Emissions (9 kHz ~ 30 MHz)

The low frequency, which started from 9 kHz to 30MHz, was pre-scanned and the result which was 20dB lower than the limit line per 15.31(o) was not reported.

3.4.6 Test Result of Radiated Spurious at Band Edges

Please refer to Appendix B.

3.4.7 Duty Cycle

Please refer to Appendix C.

3.4.8 Test Result of Radiated Spurious Emissions (30MHz ~ 10th Harmonic)

Please refer to Appendix B.



3.5 AC Conducted Emission Measurement

3.5.1 Limit of AC Conducted Emission

For equipment that is designed to be connected to the public utility (AC) power line, the radio frequency voltage that is conducted back onto the AC power line on any frequency or frequencies within the band 150 kHz to 30 MHz shall not exceed the limits in the following table.

Frequency of emission (MHz)	Conducted limit (dB μ V)	
	Quasi-peak	Average
0.15-0.5	66 to 56*	56 to 46*
0.5-5	56	46
5-30	60	50

*Decreases with the logarithm of the frequency.

3.5.2 Measuring Instruments

The measuring equipment is listed in the section 4 of this test report.

3.5.3 Test Procedures

1. The EUT was placed 0.4 meter from the conducting wall of the shielding room was kept at least 80 centimeters from any other grounded conducting surface.
2. Connect EUT to the power mains through a line impedance stabilization network (LISN).
3. All the support units are connecting to the other LISN.
4. The LISN provides 50 ohm coupling impedance for the measuring instrument.
5. The FCC states that a 50 ohm, 50 microhenry LISN should be used.
6. Both sides of AC line were checked for maximum conducted interference.
7. The frequency range from 150 kHz to 30 MHz was searched.
8. Set the test-receiver system to Peak Detect Function and specified bandwidth with Maximum Hold Mode.

3.5.4 Test Setup

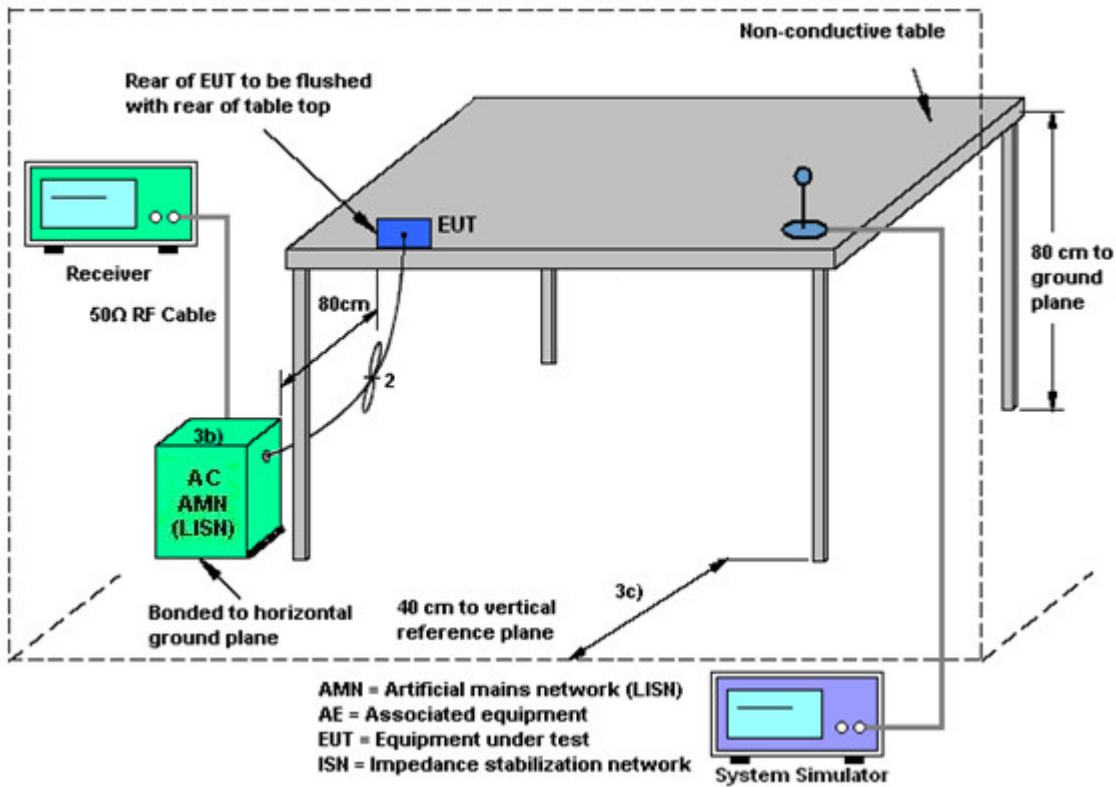



3.5.5 Test Result of AC Conducted Emission

Test Mode :	Mode 1	Temperature :	22~24°C
Test Engineer :	Amos Zhang	Relative Humidity :	43~47%
Test Voltage :	120Vac / 60Hz	Phase :	Line
Function Type :	GSM850 Idle + Bluetooth Link + WLAN Link (5G) + USB Cable (Charging from Adapter) + Earphone		

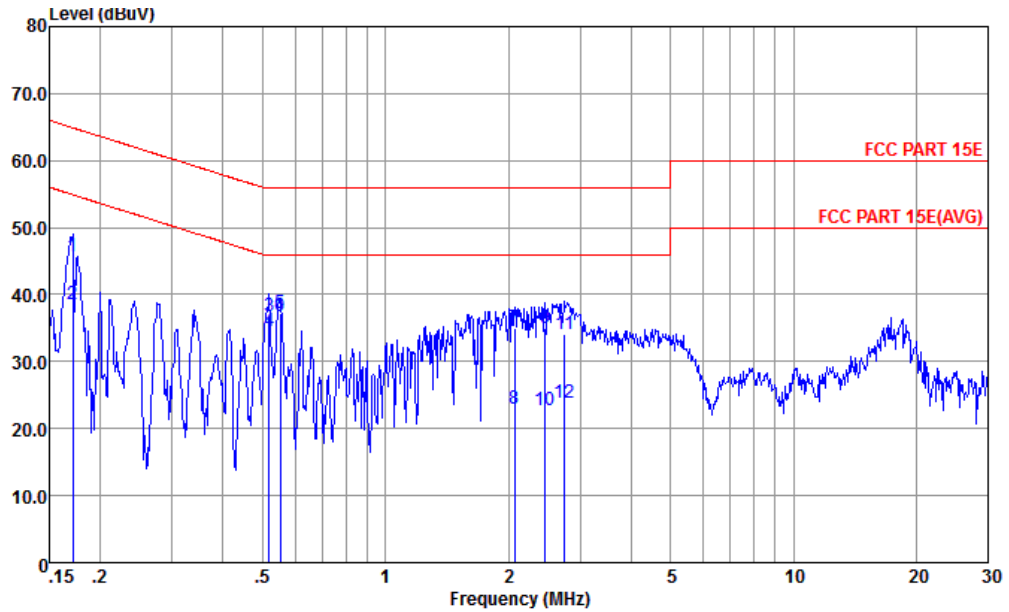

Site : CO01-KS
 Condition : FCC PART 15E LISN-L-20151024 LINE

mode : Mode 1
 : 351864080029238/351864080029246 #4

	Over	Limit	Read	LISN	Cable		
Freq	Level	Limit	Line	Level	Factor	Loss	Remark
MHz	dBuV	dB	dBuV	dBuV	dB	dB	
1	0.171	45.65	-19.25	64.90	34.89	0.39	10.37 QP
2	0.171	38.55	-16.35	54.90	27.79	0.39	10.37 Average
3	0.518	36.72	-19.28	56.00	26.30	0.23	10.19 QP
4	0.518	34.62	-11.38	46.00	24.20	0.23	10.19 Average
5	0.552	37.32	-18.68	56.00	26.91	0.23	10.18 QP
6 *	0.552	36.72	-9.28	46.00	26.31	0.23	10.18 Average
7	2.077	34.97	-21.03	56.00	24.60	0.18	10.19 QP
8	2.077	22.87	-23.13	46.00	12.50	0.18	10.19 Average
9	2.461	34.99	-21.01	56.00	24.61	0.18	10.20 QP
10	2.461	22.69	-23.31	46.00	12.31	0.18	10.20 Average
11	2.750	33.99	-22.01	56.00	23.60	0.18	10.21 QP
12	2.750	23.89	-22.11	46.00	13.50	0.18	10.21 Average



Test Mode :	Mode 1	Temperature :	22~24°C
Test Engineer :	Amos Zhang	Relative Humidity :	43~47%
Test Voltage :	120Vac / 60Hz	Phase :	Neutral
Function Type :	GSM850 Idle + Bluetooth Link + WLAN Link (5G) + USB Cable (Charging from Adapter) + Earphone		

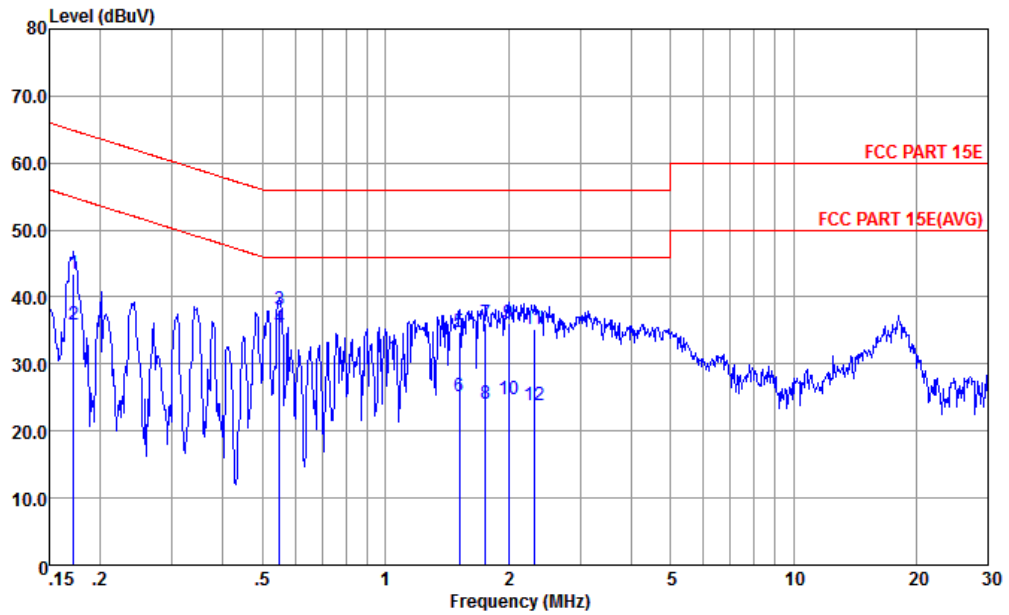

Site : CO01-KS
 Condition : FCC PART 15E LISN-N-20151024 NEUTRAL

mode : Mode 1
 : 351864080029238/351864080029246 #4

	Freq	Level	Over Limit	Limit Line	Read Level	LISN Factor	Cable Loss	Remark
	MHz	dBuV	dB	dBuV	dBuV	dB	dB	
1	0.172	43.47	-21.39	64.86	32.81	0.30	10.36	QP
2	0.172	35.97	-18.89	54.86	25.31	0.30	10.36	Average
3	0.549	38.11	-17.89	56.00	27.60	0.33	10.18	QP
4 *	0.549	35.41	-10.59	46.00	24.90	0.33	10.18	Average
5	1.519	34.86	-21.14	56.00	24.29	0.38	10.19	QP
6	1.519	25.16	-20.84	46.00	14.59	0.38	10.19	Average
7	1.762	36.07	-19.93	56.00	25.50	0.38	10.19	QP
8	1.762	24.17	-21.83	46.00	13.60	0.38	10.19	Average
9	2.001	36.17	-19.83	56.00	25.60	0.38	10.19	QP
10	2.001	24.77	-21.23	46.00	14.20	0.38	10.19	Average
11	2.309	35.17	-20.83	56.00	24.59	0.38	10.20	QP
12	2.309	23.87	-22.13	46.00	13.29	0.38	10.20	Average

3.6 Frequency Stability Measurement

3.6.1 Limit of Frequency Stability

Manufacturers of U-NII devices are responsible for ensuring frequency stability such that an emission is maintained within the band of operation under all conditions of normal operation as specified in the user's manual.

3.6.2 Measuring Instruments

The measuring equipment is listed in the section 4 of this test report.

3.6.3 Test Procedures

1. To ensure emission at the band edge is maintained within the authorized band, those values shall be measured by radiation emissions at upper and lower frequency points, and finally compensated by frequency deviation as procedures below.
2. The EUT was operated at the maximum output power, and connected to the spectrum analyzer, which is set to maximum hold function and peak detector. The peak value of the power envelope was measured and noted. The upper and lower frequency points were respectively measured relatively 10dB lower than the measured peak value.
3. The frequency deviation was calculated by adding the upper frequency point and the lower frequency point divided by two. Those detailed values of frequency deviation are provided in table below.

3.6.4 Test Setup

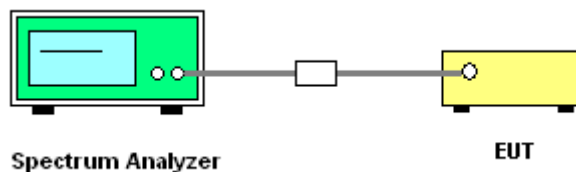

3.6.5 Test Result of Frequency Stability

Please refer to Appendix A.



3.7 Automatically Discontinue Transmission

3.7.1 Limit of Automatically Discontinue Transmission

The device shall automatically discontinue transmission in case of either absence of information to transmit or operational failure. These provisions are not intended to preclude the transmission of control or signaling information or the use of repetitive codes used by certain digital technologies to complete frame or burst intervals. Applicants shall include in their application for equipment authorization to describe how this requirement is met.

3.7.2 Measuring Instruments

The measuring equipment is listed in the section 4 of this test report.

3.7.3 Test Result of Automatically Discontinue Transmission

While the EUT is not transmitting any information, the EUT can automatically discontinue transmission and become standby mode for power saving. The EUT can detect the controlling signal of ACK message transmitting from remote device and verify whether it shall resend or discontinue transmission.



3.8 Antenna Requirements

3.8.1 Standard Applicable

According to FCC 47 CFR Section 15.407(a)(1)(2) ,if transmitting antenna directional gain is greater than 6 dBi, both the peak transmit power and the peak power spectral density shall be reduced by the amount in dB that the directional gain of the antenna exceeds 6 dBi.

3.8.2 Antenna Anti-Replacement Construction

An embedded-in antenna design is used.

3.8.3 Antenna Gain

The antenna gain is less than 6 dBi. Therefore, it is not necessary to reduce maximum peak output power limit.



4 List of Measuring Equipment

Instrument	Manufacturer	Model No.	Serial No.	Characteristics	Calibration Date	Test Date	Due Date	Remark
Spectrum Analyzer	R&S	FSV40	101040	10Hz~40GHz	Aug. 09, 2016	Oct. 09, 2016~ Oct. 26, 2016	Aug. 08, 2017	Conducted (TH01-KS)
Pulse Power Sensor	Anritsu	MA2411B	0917070	300MHz~40GHz	Jan. 20, 2016	Oct. 09, 2016~ Oct. 26, 2016	Jan. 19, 2017	Conducted (TH01-KS)
Power Meter	Anritsu	ML2495A	1005002	50MHz Bandwidth	Jan. 20, 2016	Oct. 09, 2016~ Oct. 26, 2016	Jan. 19, 2017	Conducted (TH01-KS)
EMI Receiver	R&S	ESC17	100768	9kHz~7GHz;	Apr. 29, 2016	Oct. 11, 2016	Apr. 28, 2017	Conduction (CO01-KS)
AC LISN	MessTec	AN3016	060103	9kHz~30MHz	Oct. 24, 2015	Oct. 11, 2016	Oct. 23, 2016	Conduction (CO01-KS)
AC LISN (for auxiliary equipment)	MessTec	AN3016	060105	9kHz~30MHz	Oct. 24, 2015	Oct. 11, 2016	Oct. 23, 2016	Conduction (CO01-KS)
AC Power Source	Chroma	61602	ABP0000008 11	AC 0V~300V, 45Hz~1000Hz	Oct. 24, 2015	Oct. 11, 2016	Oct. 23, 2016	Conduction (CO01-KS)
EMI Test Receiver	R&S	ESR7	101403	9kHz~7GHz; Max 30dBm	Aug. 09, 2016	Oct. 09, 2016~ Oct. 17, 2016	Aug. 08, 2017	Radiation (03CH03-KS)
EXA Spectrum Analyzer	Keysight	N9010A	MY55150244	10Hz~44GHz	Apr. 22, 2016	Oct. 09, 2016~ Oct. 17, 2016	Apr. 21, 2017	Radiation (03CH03-KS)
Loop Antenna	R&S	HFH2-Z2	100321	9kHz~30MHz	Nov. 07, 2015	Oct. 09, 2016~ Oct. 17, 2016	Nov. 06, 2016	Radiation (03CH03-KS)
Bilog Antenna	TeseQ	CBL6112D	35406	25MHz~2GHz	Apr. 16, 2016	Oct. 09, 2016~ Oct. 17, 2016	Apr. 15, 2017	Radiation (03CH03-KS)
Horn Antenna	Schwarzbeck	BBHA9120D	9120D-1356	1GHz~18GHz	Apr. 16, 2016	Oct. 09, 2016~ Oct. 17, 2016	Apr. 15, 2017	Radiation (03CH03-KS)
SHF-EHF Horn	Schwarzbeck	BBHA 9170	BBHA170249	15GHz ~40GHz	Mar. 03, 2016	Oct. 09, 2016~ Oct. 17, 2016	Mar. 02, 2017	Radiation (03CH03-KS)
Amplifier	SONOMA	310N	187289	9KHz-1GHz	Aug. 09, 2016	Oct. 09, 2016~ Oct. 17, 2016	Aug. 08, 2017	Radiation (03CH03-KS)
Amplifier	MITEQ	TTA1840-35-H G	1887435	18GHz~40GHz	Jan. 20, 2016	Oct. 09, 2016~ Oct. 17, 2016	Jan. 19, 2017	Radiation (03CH03-KS)
Amplifier	Agilent	8449B	3008A02370	1GHz~26.5GHz	Oct. 24, 2015	Oct. 09, 2016~ Oct. 17, 2016	Oct. 23, 2016	Radiation (03CH03-KS)
AC Power Source	Chroma	61601	F104090004	N/A	NCR	Oct. 09, 2016~ Oct. 17, 2016	NCR	Radiation (03CH03-KS)
Turn Table	ChamPro	EM 1000-T	060762-T	0~360 degree	NCR	Oct. 09, 2016~ Oct. 17, 2016	NCR	Radiation (03CH03-KS)
Antenna Mast	ChamPro	EM 1000-A	060762-A	1 m~4 m	NCR	Oct. 09, 2016~ Oct. 17, 2016	NCR	Radiation (03CH03-KS)

NCR: No Calibration Required



5 Uncertainty of Evaluation

Uncertainty of Conducted Emission Measurement (150kHz ~ 30MHz)

Measuring Uncertainty for a Level of Confidence of 95% ($U = 2Uc(y)$)	2.3 dB
---	--------

Uncertainty of Radiated Emission Measurement (30 MHz ~ 1000 MHz)

Measuring Uncertainty for a Level of Confidence of 95% ($U = 2Uc(y)$)	4.5dB
---	-------

Uncertainty of Radiated Emission Measurement (1GHz ~ 18GHz)

Measuring Uncertainty for a Level of Confidence of 95% ($U = 2Uc(y)$)	4.5dB
---	-------

Uncertainty of Radiated Emission Measurement (18GHz ~ 40GHz)

Measuring Uncertainty for a Level of Confidence of 95% ($U = 2Uc(y)$)	4.6dB
---	-------



Appendix A. Conducted Test Results

Test Engineer:	Ivan Zhang	Temperature:	24~25	°C
Test Date:	2016/10/9~2016/10/26	Relative Humidity:	54~55	%

TEST RESULTS DATA
6dB and 26dB EBW and 99% OBW

Band IV									
Mod.	Data Rate	N _{TX}	CH.	Freq. (MHz)	99% Bandwidth (MHz)	26 dB Bandwidth (MHz)	6 dB Bandwidth (MHz)	6dB Bandwidth min. Limit (MHz)	Pass/Fail
11a	6M bps	1	149	5745	19.03	25.87	16.32	0.5	Pass
11a	6Mbps	1	157	5785	19.28	25.97	16.32	0.5	Pass
11a	6Mbps	1	165	5825	18.88	25.23	16.34	0.5	Pass
HT20	MCS 0	1	149	5745	19.53	24.73	17.58	0.5	Pass
HT20	MCS 0	1	157	5785	20.08	28.97	17.56	0.5	Pass
HT20	MCS 0	1	165	5825	19.48	23.88	17.56	0.5	Pass
HT40	MCS 0	1	151	5755	36.56	45.32	35.13	0.5	Pass
HT40	MCS 0	1	159	5795	36.96	45.94	35.64	0.5	Pass

TEST RESULTS DATA
Average Power Table

Band IV										
Mod.	Data Rate	N _{TX}	CH.	Freq. (MHz)	Duty Factor (dB)	Average Conducted Power (dBm)	FCC Conducted Power Limit (dBm)	DG (dBi)		Pass/Fail
11a	6M bps	1	149	5745	0.60	14.69	30.00	0.08		Pass
11a	6Mbps	1	157	5785	0.60	14.24	30.00	0.08		Pass
11a	6Mbps	1	165	5825	0.60	14.94	30.00	0.08		Pass
HT20	MCS 0	1	149	5745	0.63	13.57	30.00	0.08		Pass
HT20	MCS 0	1	157	5785	0.63	14.34	30.00	0.08		Pass
HT20	MCS 0	1	165	5825	0.63	13.77	30.00	0.08		Pass
HT40	MCS 0	1	151	5755	0.66	8.63	30.00	0.08		Pass
HT40	MCS 0	1	159	5795	0.66	8.80	30.00	0.08		Pass

TEST RESULTS DATA
Power Spectral Density

Band IV										
Mod.	Data Rate	NTX	CH.	Freq. (MHz)	Duty Factor (dB)	10log (500kHz /RBW) Factor (dB)	Average Power Density (dBm/500kHz)	Average PSD Limit (dBm/500kHz)	DG (dBi)	Pass/Fail
11a	6M bps	1	149	5745	0.60	2.22	-0.34	30.00	0.08	Pass
11a	6Mbps	1	157	5785	0.60	2.22	-0.60	30.00	0.08	Pass
11a	6Mbps	1	165	5825	0.60	2.22	0.02	30.00	0.08	Pass
HT20	MCS 0	1	149	5745	0.63	2.22	-1.49	30.00	0.08	Pass
HT20	MCS 0	1	157	5785	0.63	2.22	-0.90	30.00	0.08	Pass
HT20	MCS 0	1	165	5825	0.63	2.22	-1.32	30.00	0.08	Pass
HT40	MCS 0	1	151	5755	0.66	2.22	-8.94	30.00	0.08	Pass
HT40	MCS 0	1	159	5795	0.66	2.22	-9.42	30.00	0.08	Pass

TEST RESULTS DATA
Frequency Stability

Band IV										
Mod.	Data Rate	NTX	CH.	Freq. (MHz)	Center Frequency (MHz)	Frequency Deviation (MHz)	Frequency Stability (ppm)	Temperature (°C)	Voltage (V)	Note
11a	6M bps	1	149	5745	5744.950	-0.050	-8.70	50	3.8	
11a	6M bps	1	149	5745	5745.000	0.000	0.00	-30	3.8	
11a	6M bps	1	149	5745	5744.950	-0.050	-8.70	20	4.35	
11a	6M bps	1	149	5745	5744.950	-0.050	-8.70	20	3.4	
11a	6M bps	1	149	5745	5744.950	-0.050	-8.70	20	3.8	



Appendix B. Radiated Spurious Emission

Band 4 - 5725~5850MHz WIFI 802.11a (Band Edge @ 3m)

WIFI Ant.	Note	Frequency	Level	Over Limit	Limit Line	Read Level	Antenna Factor	Cable Loss	Preamp Factor	Ant Pos	Table Pos	Peak Avg.	Pol.
1		(MHz)	(dBμV/m)	(dB)	(dBμV/m)	(dBμV)	(dB/m)	(dB)	(dB)	(cm)	(deg)	(P/A)	(H/V)
802.11a CH 149 5745MHz		5692.7	54.94	-44.98	99.92	50.92	32.02	8.25	36.25	100	324	P	H
		5717.3	67.39	-42.76	110.15	63.35	32.03	8.28	36.27	100	324	P	H
		5724.6	78.43	-42.96	121.39	74.36	32.04	8.31	36.28	100	324	P	H
	*	5738	103.86	-	-	99.76	32.05	8.34	36.29	100	324	P	H
	*	5738	96.68	-	-	92.58	32.05	8.34	36.29	100	324	A	H
		5691.4	53.53	-45.43	98.96	49.51	32.02	8.25	36.25	351	48	P	V
		5714.8	65	-44.45	109.45	60.96	32.03	8.28	36.27	351	48	P	V
		5723.5	77.04	-41.84	118.88	72.97	32.04	8.31	36.28	351	48	P	V
	*	5738	102.4	-	-	98.3	32.05	8.34	36.29	351	48	P	V
	*	5738	95.31	-	-	91.21	32.05	8.34	36.29	351	48	A	V
802.11a CH 157 5785MHz		5690.2	52.93	-45.14	98.07	48.91	32.02	8.25	36.25	100	329	P	H
		5704.5	53.83	-52.73	106.56	49.79	32.03	8.28	36.27	100	329	P	H
		5725	51.07	-71.23	122.3	47	32.04	8.31	36.28	100	329	P	H
		5854.66	51.95	-59.72	111.67	47.71	32.1	8.51	36.37	100	329	P	H
		5863.02	52.5	-56.15	108.65	48.26	32.1	8.51	36.37	100	329	P	H
		5880.69	52.15	-48.92	101.07	47.9	32.1	8.53	36.38	100	329	P	H
	*	5782	104.07	-	-	99.92	32.06	8.4	36.31	100	329	P	H
	*	5782	96.46	-	-	92.31	32.06	8.4	36.31	100	329	A	H
		5689.2	52.47	-44.87	97.34	48.45	32.02	8.25	36.25	331	57	P	V
		5719.7	52.36	-58.46	110.82	48.29	32.04	8.31	36.28	331	57	P	V
		5722.7	51.61	-65.45	117.06	47.54	32.04	8.31	36.28	331	57	P	V
		5852.95	51.21	-64.36	115.57	46.99	32.09	8.49	36.36	331	57	P	V
		5868.53	52.1	-55.01	107.11	47.86	32.1	8.51	36.37	331	57	P	V
		5877.65	52.74	-50.59	103.33	48.49	32.1	8.53	36.38	331	57	P	V
	*	5792	101.81	-	-	97.63	32.07	8.43	36.32	331	57	P	V
*	5792	94.45	-	-	90.27	32.07	8.43	36.32	331	57	A	V	



WIFI Ant. 1	Note	Frequency (MHz)	Level (dBμV/m)	Over Limit (dB)	Limit Line (dBμV/m)	Read Level (dBμV)	Antenna Factor (dB/m)	Cable Loss (dB)	Preamp Factor (dB)	Ant Pos (cm)	Table Pos (deg)	Peak Avg. (P/A)	Pol. (H/V)
802.11a CH 165 5825MHz		5850.48	62.71	-58.5	121.21	58.49	32.09	8.49	36.36	100	327	P	H
		5855.42	59.03	-51.75	110.78	54.79	32.1	8.51	36.37	100	327	P	H
		5877.84	53.95	-49.24	103.19	49.7	32.1	8.53	36.38	100	327	P	H
	*	5820	103.59	-	-	99.39	32.08	8.47	36.35	100	327	P	H
	*	5820	96.19	-	-	91.99	32.08	8.47	36.35	100	327	A	H
		5850	58.54	-63.76	122.3	54.32	32.09	8.49	36.36	314	100	P	V
		5856.56	55.87	-54.59	110.46	51.63	32.1	8.51	36.37	314	100	P	V
		5878.41	53.28	-49.49	102.77	49.03	32.1	8.53	36.38	314	100	P	V
	*	5830	100.77	-	-	96.57	32.08	8.47	36.35	314	100	P	V
	*	5830	93.46	-	-	89.26	32.08	8.47	36.35	314	100	A	V
Remark	1. No other spurious found. 2. All results are PASS against Peak and Average limit line.												



Band 4 5725~5850MHz

WIFI 802.11a (Harmonic @ 3m)

WIFI Ant. 1	Note	Frequency (MHz)	Level (dBμV/m)	Over Limit (dB)	Limit Line (dBμV/m)	Read Level (dBμV)	Antenna Factor (dB/m)	Cable Loss (dB)	Preamp Factor (dB)	Ant Pos (cm)	Table Pos (deg)	Peak Avg. (P/A)	Pol. (H/V)
802.11a		11490	47.19	-26.81	74	53.01	38.59	12.57	56.98	160	360	P	H
CH 149		11490	46.36	-27.64	74	52.18	38.59	12.57	56.98	160	360	P	V
5745MHz													
802.11a		11570	42.5	-31.5	74	48.27	38.75	12.63	57.15	160	360	P	H
CH 157		11570	47.1	-26.9	74	52.87	38.75	12.63	57.15	160	360	P	V
5785MHz													
802.11a		11650	43.84	-30.16	74	49.56	38.9	12.67	57.29	160	360	P	H
CH 165		11650	47	-27	74	52.72	38.9	12.67	57.29	160	360	P	V
5825MHz													
Remark	1. No other spurious found. 2. All results are PASS against Peak and Average limit line.												



Band 4 5725~5850MHz
WIFI 802.11n HT20 (Band Edge @ 3m)

WIFI Ant. 1	Note	Frequency (MHz)	Level (dBμV/m)	Over Limit (dB)	Limit Line (dBμV/m)	Read Level (dBμV)	Antenna Factor (dB/m)	Cable Loss (dB)	Preamp Factor (dB)	Ant Pos (cm)	Table Pos (deg)	Peak Avg. (P/A)	Pol. (H/V)
802.11n HT20 CH 149 5745MHz		5691.9	54.08	-45.25	99.33	50.06	32.02	8.25	36.25	100	321	P	H
		5719.4	66.86	-43.87	110.73	62.79	32.04	8.31	36.28	100	321	P	H
		5724.3	78.31	-42.39	120.7	74.24	32.04	8.31	36.28	100	321	P	H
	*	5750	103.14	-	-	99.04	32.05	8.34	36.29	100	321	P	H
	*	5750	95.62	-	-	91.52	32.05	8.34	36.29	100	321	A	H
		5689.1	52.42	-44.84	97.26	48.4	32.02	8.25	36.25	338	53	P	V
		5719.6	64.23	-46.56	110.79	60.16	32.04	8.31	36.28	338	53	P	V
		5723.4	75.19	-43.46	118.65	71.12	32.04	8.31	36.28	338	53	P	V
	*	5742	100.99	-	-	96.89	32.05	8.34	36.29	338	53	P	V
	*	5742	93.39	-	-	89.29	32.05	8.34	36.29	338	53	A	V
802.11n HT20 CH 157 5785MHz		5685.4	52.29	-42.24	94.53	48.27	32.02	8.25	36.25	100	230	P	H
		5718.2	52.93	-57.47	110.4	48.86	32.04	8.31	36.28	100	230	P	H
		5720.4	52.16	-59.65	111.81	48.09	32.04	8.31	36.28	100	230	P	H
		5850.29	52.38	-69.26	121.64	48.16	32.09	8.49	36.36	100	230	P	H
		5866.44	52.41	-55.28	107.69	48.17	32.1	8.51	36.37	100	230	P	H
		5883.16	52.86	-46.38	99.24	48.61	32.1	8.53	36.38	100	230	P	H
	*	5778	98.28	-	-	94.13	32.06	8.4	36.31	100	230	P	H
	*	5778	90.98	-	-	86.83	32.06	8.4	36.31	100	230	A	H
		5695.5	52.72	-49.26	101.98	48.7	32.02	8.25	36.25	371	56	P	V
		5707.7	52.29	-55.17	107.46	48.25	32.03	8.28	36.27	371	56	P	V
		5724.3	51.74	-68.96	120.7	47.67	32.04	8.31	36.28	371	56	P	V
		5853.71	53.77	-60.07	113.84	49.53	32.1	8.51	36.37	371	56	P	V
		5867.39	52.91	-54.52	107.43	48.67	32.1	8.51	36.37	371	56	P	V
		5875.56	52.06	-52.82	104.88	47.81	32.1	8.53	36.38	371	56	P	V
*	5784	95.8	-	-	91.65	32.06	8.4	36.31	371	56	P	V	
*	5784	88.48	-	-	84.33	32.06	8.4	36.31	371	56	A	V	



WIFI Ant. 1	Note	Frequency (MHz)	Level (dBμV/m)	Over Limit (dB)	Limit Line (dBμV/m)	Read Level (dBμV)	Antenna Factor (dB/m)	Cable Loss (dB)	Preamp Factor (dB)	Ant Pos (cm)	Table Pos (deg)	Peak Avg. (P/A)	Pol. (H/V)
802.11n HT20 CH 165 5825MHz		5850.86	57.62	-62.72	120.34	53.4	32.09	8.49	36.36	100	220	P	H
		5856.18	54.39	-56.18	110.57	50.15	32.1	8.51	36.37	100	220	P	H
		5881.26	53.24	-47.41	100.65	48.99	32.1	8.53	36.38	100	220	P	H
	*	5828	96.06	-	-	91.86	32.08	8.47	36.35	100	220	P	H
	*	5828	96.06	-	-	91.86	32.08	8.47	36.35	100	220	A	H
		5850.67	54.73	-66.04	120.77	50.51	32.09	8.49	36.36	350	55	P	V
		5859.03	54.11	-55.66	109.77	49.87	32.1	8.51	36.37	350	55	P	V
		5886.77	53.01	-43.55	96.56	48.76	32.1	8.53	36.38	350	55	P	V
	*	5818	94.56	-	-	90.36	32.08	8.45	36.33	350	55	P	V
*	5818	87.05	-	-	82.85	32.08	8.45	36.33	350	55	A	V	
Remark	<ol style="list-style-type: none"> No other spurious found. All results are PASS against Peak and Average limit line. 												



Band 4 5725~5850MHz
WIFI 802.11n HT20 (Harmonic @ 3m)

WIFI Ant. 1	Note	Frequency (MHz)	Level (dBμV/m)	Over Limit (dB)	Limit Line (dBμV/m)	Read Level (dBμV)	Antenna Factor (dB/m)	Cable Loss (dB)	Preamp Factor (dB)	Ant Pos (cm)	Table Pos (deg)	Peak Avg. (P/A)	Pol. (H/V)
802.11n HT20 CH 149 5745MHz		11490	42.31	-31.69	74	48.13	38.59	12.57	56.98	160	360	P	H
		11490	45.21	-28.79	74	51.03	38.59	12.57	56.98	160	360	P	V
802.11n HT20 CH 157 5785MHz		11570	43.34	-30.66	74	49.11	38.75	12.63	57.15	160	360	P	H
		11570	47.09	-26.91	74	52.86	38.75	12.63	57.15	160	360	P	V
802.11n HT20 CH 165 5825MHz		11650	43.02	-30.98	74	48.74	38.9	12.67	57.29	160	0	P	H
		11650	46.15	-27.85	74	51.87	38.9	12.67	57.29	160	360	P	V
Remark	1. No other spurious found. 2. All results are PASS against Peak and Average limit line.												



Band 4 5725~5850MHz
WIFI 802.11n HT40 (Band Edge @ 3m)

Table with 14 columns: WIFI Ant. 1, Note, Frequency (MHz), Level (dBµV/m), Over Limit (dB), Limit Line (dBµV/m), Read Level (dBµV), Antenna Factor (dB/m), Cable Loss (dB), Preamp Factor (dB), Ant Pos (cm), Table Pos (deg), Peak Avg. (P/A), Pol. (H/V). Rows include frequencies from 5690.7 to 5889.24 MHz and two rows marked with asterisks at 5750 MHz and 5742 MHz.



WIFI Ant. 1	Note	Frequency (MHz)	Level (dBμV/m)	Over Limit (dB)	Limit Line (dBμV/m)	Read Level (dBμV)	Antenna Factor (dB/m)	Cable Loss (dB)	Preamp Factor (dB)	Ant Pos (cm)	Table Pos (deg)	Peak Avg. (P/A)	Pol. (H/V)
802.11n HT40 CH 159 5795MHz		5685.4	52.57	-41.96	94.53	48.55	32.02	8.25	36.25	100	334	P	H
		5707.8	52.36	-55.13	107.49	48.32	32.03	8.28	36.27	100	334	P	H
		5722.1	51.73	-63.96	115.69	47.66	32.04	8.31	36.28	100	334	P	H
		5852.76	52.93	-63.08	116.01	48.71	32.09	8.49	36.36	100	334	P	H
		5861.88	52.34	-56.63	108.97	48.1	32.1	8.51	36.37	100	334	P	H
		5879.36	53.05	-49.01	102.06	48.8	32.1	8.53	36.38	100	334	P	H
	*	5808	94.21	-	-	90.01	32.08	8.45	36.33	100	334	P	H
	*	5808	86.87	-	-	82.67	32.08	8.45	36.33	100	334	A	H
		5691.8	52.4	-46.85	99.25	48.38	32.02	8.25	36.25	285	332	P	V
		5700.8	52.84	-52.68	105.52	48.8	32.03	8.28	36.27	285	332	P	V
		5721.1	51.83	-61.58	113.41	47.76	32.04	8.31	36.28	285	332	P	V
		5850	52.25	-70.05	122.3	48.03	32.09	8.49	36.36	285	332	P	V
		5859.41	53.27	-56.39	109.66	49.03	32.1	8.51	36.37	285	332	P	V
		5889.43	52.44	-42.15	94.59	48.18	32.11	8.55	36.4	285	332	P	V
		*	5784	94.16	-	-	90.01	32.06	8.4	36.31	285	332	P
	*	5784	86.53	-	-	82.38	32.06	8.4	36.31	285	332	A	V
Remark	1. No other spurious found. 2. All results are PASS against Peak and Average limit line.												



Band 4 5725~5850MHz
WIFI 802.11n HT40 (Harmonic @ 3m)

Table with 14 columns: WIFI Ant. 1, Note, Frequency (MHz), Level (dBµV/m), Over Limit (dB), Limit Line (dBµV/m), Read Level (dBµV), Antenna Factor (dB/m), Cable Loss (dB), Preamp Factor (dB), Ant Pos (cm), Table Pos (deg), Peak Avg. (P/A), Pol. (H/V). Rows include data for 802.11n HT40 CH 151 and CH 159 at 5755MHz and 5795MHz, and a Remark section.



Band 4 5725~5850MHz

Emission below 1GHz

5GHz WIFI 802.11a (LF @ 3m)

WIFI Ant.	Note	Frequency	Level	Over Limit	Limit Line	Read Level	Antenna Factor	Cable Loss	Preamp Factor	Ant Pos	Table Pos	Peak Avg.	Pol.
1		(MHz)	(dBμV/m)	(dB)	(dBμV/m)	(dBμV)	(dB/m)	(dB)	(dB)	(cm)	(deg)	(P/A)	(H/V)
5GHz 802.11a LF		31.94	27.16	-12.84	40	31.26	26.52	0.68	31.3	-	-	P	H
		44.55	27.1	-12.9	40	38.24	19.45	0.83	31.42	-	-	P	H
		64.92	23.83	-16.17	40	41.04	13.3	0.97	31.48	-	-	P	H
		80.44	27.74	-12.26	40	42.47	15.67	1.09	31.49	100	26	P	H
		783.69	29.42	-16.58	46	29.18	27.7	3.55	31.01	-	-	P	H
		978.66	32.09	-21.91	54	29.22	29.5	4.05	30.68	-	-	P	H
		30.97	32.27	-7.73	40	36.04	26.86	0.66	31.29	-	-	P	V
		44.55	29.42	-10.58	40	40.56	19.45	0.83	31.42	-	-	P	V
		63.95	33.02	-6.98	40	50.3	13.24	0.95	31.47	-	-	P	V
		71.71	34.46	-5.54	40	50.78	14.18	1.01	31.51	300	125	P	V
		80.44	26.65	-13.35	40	41.38	15.67	1.09	31.49	-	-	P	V
	882.63	30.71	-15.29	46	29.11	28.67	3.8	30.87	-	-	P	V	
Remark	1. No other spurious found. 2. All results are PASS against limit line.												



Note symbol

*	Fundamental Frequency which can be ignored. However, the level of any unwanted emissions shall not exceed the level of the fundamental frequency.
!	Test result is over limit line.
P/A	Peak or Average
H/V	Horizontal or Vertical



A calculation example for radiated spurious emission is shown as below:

WIFI	Note	Frequency	Level	Over	Limit	Read	Antenna	Cable	Preamp	Ant	Table	Peak	Pol.
Ant.				Limit	Line	Level	Factor	Loss	Factor	Pos	Pos	Avg.	
1		(MHz)	(dBμV/m)	(dB)	(dBμV/m)	(dBμV)	(dB/m)	(dB)	(dB)	(cm)	(deg)	(P/A)	(H/V)
802.11b		2390	55.45	-18.55	74	54.51	32.22	4.58	35.86	103	308	P	H
CH 01													
2412MHz		2390	43.54	-10.46	54	42.6	32.22	4.58	35.86	103	308	A	H

- Level(dBμV/m) =
Antenna Factor(dB/m) + Cable Loss(dB) + Read Level(dBμV) - Preamp Factor(dB)
- Over Limit(dB) = Level(dBμV/m) – Limit Line(dBμV/m)

For Peak Limit @ 2390MHz:

- Level(dBμV/m)
= Antenna Factor(dB/m) + Cable Loss(dB) + Read Level(dBμV) - Preamp Factor(dB)
= 32.22(dB/m) + 4.58(dB) + 54.51(dBμV) – 35.86 (dB)
= 55.45 (dBμV/m)
- Over Limit(dB)
= Level(dBμV/m) – Limit Line(dBμV/m)
= 55.45(dBμV/m) – 74(dBμV/m)
= -18.55(dB)

For Average Limit @ 2390MHz:

- Level(dBμV/m)
= Antenna Factor(dB/m) + Cable Loss(dB) + Read Level(dBμV) - Preamp Factor(dB)
= 32.22(dB/m) + 4.58(dB) + 42.6(dBμV) – 35.86 (dB)
= 43.54 (dBμV/m)
- Over Limit(dB)
= Level(dBμV/m) – Limit Line(dBμV/m)
= 43.54(dBμV/m) – 54(dBμV/m)
= -10.46(dB)

Both peak and average measured complies with the limit line, so test result is “PASS”.



Appendix C. Duty Cycle Plots

Band	Duty Cycle(%)	T(ms)	1/T(kHz)	VBW Setting
802.11a	87.04	1.36	0.73	1KHz
802.11n HT20	86.52	1.27	0.78	1KHz
802.11n HT40	85.93	1.22	0.82	1KHz

802.11a

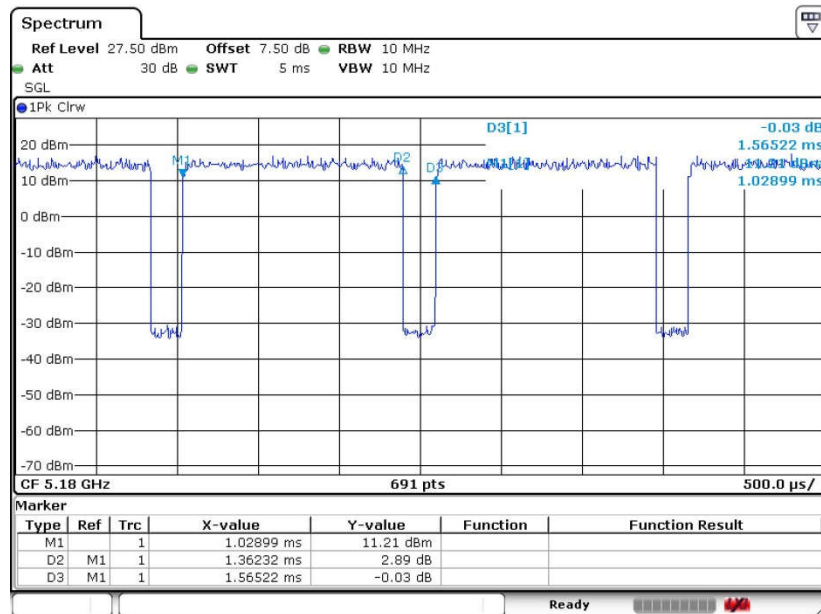

Date: 9.OCT.2016 15:04:43



802.11n HT20

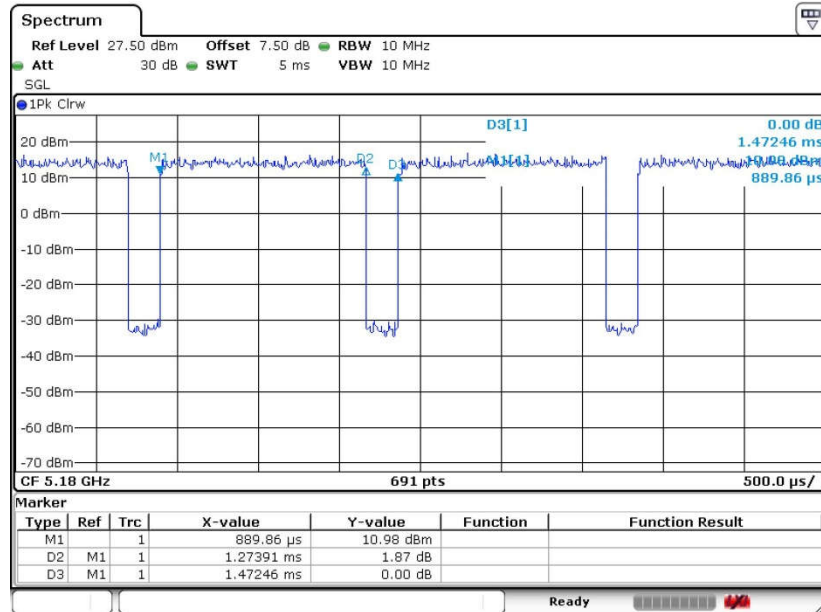

Date: 9.OCT.2016 16:16:53

802.11n HT40

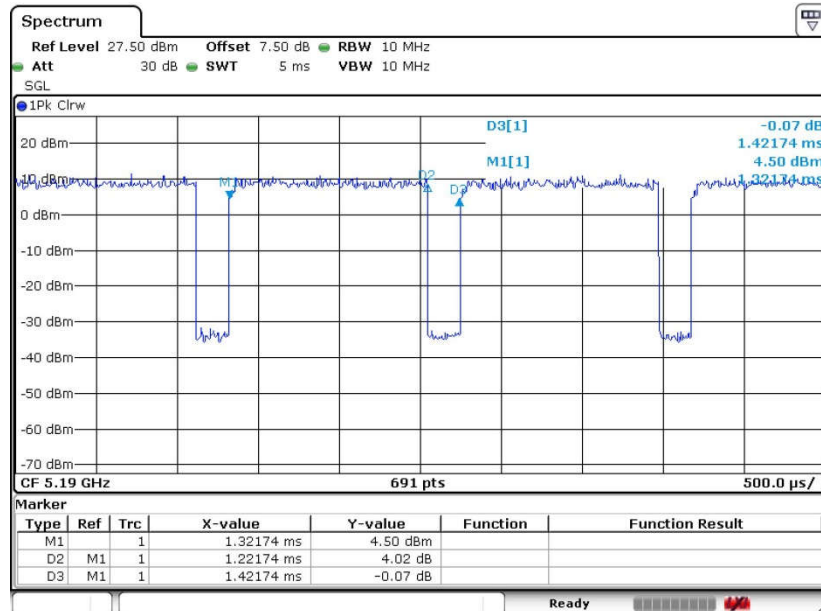

Date: 9.OCT.2016 16:49:58