



FCC RF Test Report

APPLICANT : Motorola Mobility, LLC
EQUIPMENT : Mobile Cellular Phone
BRAND NAME : Motorola
MODEL NAME : 6576
FCC ID : IHDT56VB4
STANDARD : 47 CFR Part 2, 22(H), 24(E), 27
CLASSIFICATION : PCS Licensed Transmitter Held to Ear (PCE)

This is a variant report which is only valid together with the original test report. The product was received on Mar. 21, 2016 and completely tested on May 27, 2016. We, SPORTON INTERNATIONAL INC., would like to declare that the tested sample has been evaluated in accordance with the test procedures given in ANSI / TIA / EIA-603-D-2010 and the testing has shown the tested sample to be in compliance with the applicable technical standards. The test results in this report apply exclusively to the tested model / sample. Without written approval of SPORTON INTERNATIONAL INC., the test report shall not be reproduced except in full.

Reviewed by: Joseph Lin / Supervisor

Approved by: Jones Tsai / Manager



SPORTON INTERNATIONAL INC.

No. 52, Hwa Ya 1st Rd., Hwa Ya Technology Park, Kwei-Shan District, Tao Yuan City, Taiwan, R.O.C.

SPORTON INTERNATIONAL INC.

TEL : 886-3-327-3456

FAX : 886-3-328-4978

FCC ID : IHDT56VB4

Page Number : 1 of 28

Report Issued Date : Jun. 16, 2016

Report Version : Rev. 01

Report Template No.: BU5-FGLTE Version 1.5



TABLE OF CONTENTS

REVISION HISTORY.....3
SUMMARY OF TEST RESULT4
1 GENERAL DESCRIPTION5
1.1 Applicant5
1.2 Manufacturer5
1.3 Product Feature of Equipment Under Test.....5
1.4 Re-use of Measured Data6
1.5 Modification of EUT6
1.6 Emission Designator7
1.7 Testing Location8
1.8 Applicable Standards.....8
2 TEST CONFIGURATION OF EQUIPMENT UNDER TEST9
2.1 Test Mode9
2.2 Connection Diagram of Test System11
2.3 Support Unit used in test configuration and system11
2.4 Measurement Results Explanation Example11
2.5 Frequency List of Low/Middle/High Channels12
3 CONDUCTED TEST ITEMS14
3.1 Measuring Instruments14
3.2 Test Setup14
3.3 Test Result of Conducted Test14
3.4 Conducted Output Power15
3.5 Peak-to-Average Ratio16
3.6 Occupied Bandwidth17
3.7 Conducted Band Edge18
3.8 Conducted Spurious Emission20
3.9 Frequency Stability21
4 RADIATED TEST ITEMS22
4.1 Measuring Instruments22
4.2 Test Setup22
4.3 Test Result of Radiated Test22
4.4 Effective Radiated Power and Effective Isotropic Radiated Power23
4.5 Radiated Spurious Emission25
5 LIST OF MEASURING EQUIPMENT27
6 UNCERTAINTY OF EVALUATION28
APPENDIX A. TEST RESULTS OF CONDUCTED TEST
APPENDIX B. TEST RESULTS OF RADIATED TEST
APPENDIX C. ORIGINAL REPORT



SUMMARY OF TEST RESULT

Report Section	FCC Rule	Description	Limit	Result	Remark
3.4	§2.1046	Conducted Output Power	Reporting Only	PASS	-
3.5	§24.232(d)	Peak-to-Average Ratio	<13 dB	PASS	-
3.6	§2.1049	Occupied Bandwidth	Reporting Only	PASS	-
3.7	§2.1051 §22.917(a) §24.238(a) §27.53(g) §27.53(h)	Conducted Band Edge Measurement (Band 2) (Band 4) (Band 5) (Band 12) (Band 17) (Band 25)	< 43+10log ₁₀ (P[Watts])	PASS	-
	§27.53(m)(4)	Conducted Band Edge Measurement (Band 7) (Band 38)	§27.53(m)(4)		
3.8	§2.1051 §22.917(a) §24.238(a) §27.53(g) §27.53(h)	Conducted Spurious Emission (Band 2) (Band 4) (Band 5) (Band 12) (Band 17) (Band 25)	< 43+10log ₁₀ (P[Watts])	PASS	-
	§2.1051 §27.53(m)(4)	Conducted Spurious Emission (Band 7) (Band 38)	< 55+10log ₁₀ (P[Watts])		
3.9	§2.1055 §22.355	Frequency Stability Temperature & Voltage	< 2.5 ppm for Part 22	PASS	-
	§2.1055 §24.235 §27.54		Within Authorized Band		
4.4	§22.913(a)(2)	Effective Radiated Power (Band 5)	ERP < 7 Watt	PASS	-
	§27.50(c)(10)	Effective Radiated Power (Band 12) (Band 17)	ERP < 3 Watt		
	§24.232(c) §27.50(h)(2)	Equivalent Isotropic Radiated Power (Band 2) (Band 25) (Band 7) (Band 38)	EIRP < 2Watt		
	§27.50(d)(4)	Equivalent Isotropic Radiated Power (Band 4)	EIRP < 1Watt		
4.5	§2.1053 §22.917(a) §24.238(a) §27.53(g) §27.53(h)	Radiated Spurious Emission (Band 2) (Band 4) (Band 5) (Band 12) (Band 17) (Band 25)	< 43+10log ₁₀ (P[Watts])	PASS	Under limit 12.70 dB at 5202.00 MHz
	§2.1053 §27.53(m)(4)	Radiated Spurious Emission (Band 7) (Band 38)	< 55+10log ₁₀ (P[Watts])		



1 General Description

1.1 Applicant

Motorola Mobility, LLC

222 W Merchandise Mart Plaza, Suite 1800, Chicago, IL 60654, United States

1.2 Manufacturer

Motorola Mobility, LLC

222 W Merchandise Mart Plaza, Suite 1800, Chicago, IL 60654, United States

1.3 Product Feature of Equipment Under Test

Product Feature	
Equipment	Mobile Cellular Phone
Brand Name	Motorola
Model Name	6576
FCC ID	IHDT56VB4
IMEI Code	IMEI 1: 354110070072730 IMEI 2: 354110070072748
EUT supports Radios application	GSM/EGPRS/WCDMA/HSPA/LTE/NFC WLAN 11b/g/n HT20/VHT20 WLAN 11a/n HT20/HT40 WLAN 11ac VHT20/VHT40/VHT80 Bluetooth v3.0 EDR Bluetooth v4.2 LE
HW Version	DVT2
EUT Stage	Identical Prototype

Accessory List	
AC Adapter	Brand Name : Motorola
	Model Name : SPN5913A



1.4 Re-use of Measured Data

1.4.1 Introduction Section

This application re-uses data collected on a similar device. The subject device of this application (Model 6576, FCC ID IHDT56VB4) is electrically identical to the reference device (Model 4237, FCC ID IHDT56VB1) for the portions of the circuitry corresponding to the data being re-used, as treated by KDB Publication 178919 D01.

1.4.2 Difference Section

For details concerning the similarity with respect to component placement, mechanical/electrical design etc., please refer to the Operational Description.

The re-used RF data includes the following bands provided in Appendix C (Sporton RF Report No. FG631828B for the reference device Model 4237, FCC ID IHDT56VB1):

- LTE Band 2
- LTE Band 4
- LTE Band 5
- LTE Band 7

1.4.3 Spot Check Verification Data Section

In order to confirm hardware similarity of the subject device with the reference device, spot check measurements were performed on the subject device for radiated spurious emission, the test result were consistent with FCC ID IHDT56VB1.

Assertions concerning the similarity of these devices are based on representations by the applicant. The applicant accepts full responsibility for the validity of the similarity claim, and for the determination that verification test data are sufficient to support it.

1.4.4 Reference detail Section:

Equipment Class	Reference FCC ID	Folder Test/RF Exposure	Report Title/Section
PCE	IHDT56VB1	Part22H.24E.27(FG631828B)	All sections applicable

1.5 Modification of EUT

No modifications are made to the EUT during all test items.



1.6 Emission Designator

LTE Band 25		QPSK			16QAM		
BW(MHz)	Emission Designator (99%OBW)	Frequency Tolerance (ppm)	Maximum EIRP(W)	Emission Designator (99%OBW)	Frequency Tolerance (ppm)	Maximum EIRP(W)	
1.4	1M10G7D	-	0.1786	1M09W7D	-	0.1449	
3	2M73G7D	-	0.1560	2M72W7D	-	0.1346	
5	4M51G7D	-	0.1710	4M50W7D	-	0.1393	
10	9M05G7D	0.0094	0.1750	9M01W7D	-	0.1416	
15	13M5G7D	-	0.1950	13M5W7D	-	0.1603	
20	18M5G7D	-	0.1950	18M4W7D	-	0.1614	
LTE Band 12		QPSK			16QAM		
BW(MHz)	Emission Designator (99%OBW)	Frequency Tolerance (ppm)	Maximum ERP(W)	Emission Designator (99%OBW)	Frequency Tolerance (ppm)	Maximum ERP(W)	
1.4	1M09G7D	-	0.0535	1M09W7D	-	0.0401	
3	2M74G7D	-	0.0598	2M74W7D	-	0.0377	
5	4M50G7D	-	0.0537	4M50W7D	-	0.0394	
10	9M03G7D	0.0220	0.0456	9M05W7D	-	0.0324	
LTE Band 17		QPSK			16QAM		
BW(MHz)	Emission Designator (99%OBW)	Frequency Tolerance (ppm)	Maximum ERP(W)	Emission Designator (99%OBW)	Frequency Tolerance (ppm)	Maximum ERP(W)	
5	4M51G7D	-	0.0568	4M49W7D	-	0.0537	
10	8M97G7D	0.0158	0.0473	9M01W7D	-	0.0332	
LTE Band 38		QPSK			16QAM		
BW(MHz)	Emission Designator (99%OBW)	Frequency Tolerance (ppm)	Maximum EIRP(W)	Emission Designator (99%OBW)	Frequency Tolerance (ppm)	Maximum EIRP(W)	
5	4M48G7D	-	0.1679	4M51W7D	-	0.1114	
10	9M07G7D	-	0.1718	9M01W7D	-	0.1156	
15	13M5G7D	-	0.1746	13M5W7D	-	0.1161	
20	18M4G7D	0.0112	0.1734	18M6W7D	-	0.1189	



1.7 Testing Location

Sporton Lab is accredited to ISO 17025 by Taiwan Accreditation Foundation (TAF code : 1190) and the FCC designation No. TW1022 under the FCC 2.948(e) by Mutual Recognition Agreement (MRA) in FCC Test.

Test Site	SPORTON INTERNATIONAL INC.
Test Site Location	No. 52, Hwa Ya 1 st Rd., Hwa Ya Technology Park, Kwei-Shan District, Tao Yuan City, Taiwan, R.O.C. TEL: +886-3-327-3456 FAX: +886-3-328-4978
Test Site No.	Sporton Site No.
	TH02-HY

Test Site	SPORTON INTERNATIONAL INC.
Test Site Location	No.58, Aly. 75, Ln. 564, Wenhua 3rd Rd. Guishan Dist, Taoyuan City, Taiwan (R.O.C.) TEL: +886-3-327-0868 FAX: +886-3-327-0855
Test Site No.	Sporton Site No.
	03CH12-HY

1.8 Applicable Standards

According to the specifications of the manufacturer, the EUT must comply with the requirements of the following standards:

- ♦ 47 CFR Part 2, 22(H), 24(E), 27
- ♦ ANSI / TIA / EIA-603-D-2010
- ♦ FCC KDB 971168 D01 Power Meas. License Digital Systems v02r02

Remark:

1. All test items were verified and recorded according to the standards and without any deviation during the test.
2. This EUT has also been tested and complied with the requirements of FCC Part 15, Subpart B, recorded in a separate test report.



2 Test Configuration of Equipment Under Test

2.1 Test Mode

Antenna port conducted and radiated test items listed below are performed according to KDB 971168 D01 Power Meas. License Digital Systems v02r02 with maximum output power.

Radiated measurements are performed by rotating the EUT in three different orthogonal test planes to find the maximum emission.

Test Items	Band	Bandwidth (MHz)						Modulation		RB #			Test Channel		
		1.4	3	5	10	15	20	QPSK	16QAM	1	Half	Full	L	M	H
Max. Output Power	12	Y	Y	Y	Y	-	-	Y	Y	Y	Y	Y	Y	Y	Y
	17	-	-	Y	Y	-	-	Y	Y	Y	Y	Y	Y	Y	Y
	25	Y	Y	Y	Y	Y	Y	Y	Y	Y	Y	Y	Y	Y	Y
	38	-	-	Y	Y	Y	Y	Y	Y	Y	Y	Y	Y	Y	Y
Peak-to-Average Ratio	12				Y	-	-	Y	Y	Y		Y	Y	Y	Y
	17	-	-		Y	-	-	Y	Y	Y		Y	Y	Y	Y
	25						Y	Y	Y	Y		Y	Y	Y	Y
	38	-	-				Y	Y	Y	Y		Y	Y	Y	Y
26dB and 99% Bandwidth	12	Y	Y	Y	Y	-	-	Y	Y			Y	Y	Y	Y
	17	-	-	Y	Y	-	-	Y	Y			Y	Y	Y	Y
	25	Y	Y	Y	Y	Y	Y	Y	Y			Y	Y	Y	Y
	38	-	-	Y	Y	Y	Y	Y	Y			Y	Y	Y	Y
Conducted Band Edge	12	Y	Y	Y	Y	-	-	Y	Y	Y		Y	Y		Y
	17	-	-	Y	Y	-	-	Y	Y	Y		Y	Y		Y
	25	Y	Y	Y	Y	Y	Y	Y	Y	Y		Y	Y		Y
	38	-	-	Y	Y	Y	Y	Y	Y	Y		Y	Y		Y



Test Items	Band	Bandwidth (MHz)						Modulation		RB #			Test Channel		
		1.4	3	5	10	15	20	QPSK	16QAM	1	Half	Full	L	M	H
Conducted Spurious Emission	12	√	√	√	√	-	-	√	√	√			√	√	√
	17	-	-	√	√	-	-	√	√	√			√	√	√
	25	√	√	√	√	√	√	√	√	√			√	√	√
	38	-	-	√	√	√	√	√	√	√			√	√	√
Frequency Stability	12				√	-	-	√				√		√	
	17	-	-		√	-	-	√				√		√	
	25				√			√				√		√	
	38	-	-		√			√				√		√	
E.R.P./ E.I.R.P.	12	√	√	√	√	√	√	√	√	√			√	√	√
	17	-	-	√	√	-	-	√	√	√			√	√	√
	25	√	√	√	√	√	√	√	√	√			√	√	√
	38	-	-	√	√	√	√	√	√	√			√	√	√
Radiated Spurious Emission	12	√	√	√	√	-	-	√		√			√	√	√
	17	-	-	√	√	-	-	√		√			√	√	√
	25	√	√	√	√	√	√	√		√			√	√	√
	38	-	-	√	√	√	√	√		√			√	√	√
Note	<p>1. The mark "√" means that this configuration is chosen for testing</p> <p>2. The mark "-" means that this bandwidth is not supported.</p> <p>3. The device is investigated from 30MHz to 10 times of fundamental signal for radiated spurious emission test under different RB size/offset and modulations in exploratory test. Subsequently, only the worst case emissions are reported.</p>														

2.2 Connection Diagram of Test System

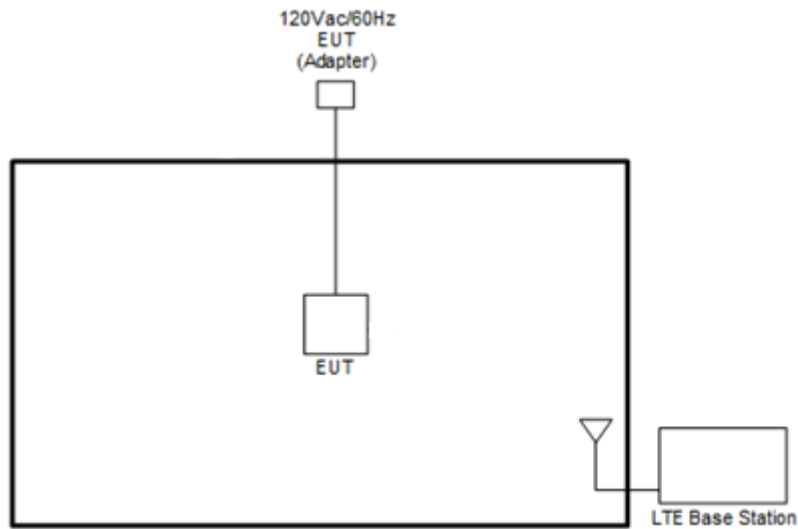

2.3 Support Unit used in test configuration and system

Item	Equipment	Trade Name	Model No.	FCC ID	Data Cable	Power Cord
1.	LTE Base Station	Anritsu	MT8820C	N/A	N/A	Unshielded, 1.8 m

2.4 Measurement Results Explanation Example

For all conducted test items:

The offset level is set in the spectrum analyzer to compensate the RF cable loss and attenuator factor between EUT conducted output port and spectrum analyzer. With the offset compensation, the spectrum analyzer reading level is exactly the EUT RF output level.

The spectrum analyzer offset is derived from RF cable loss and attenuator factor.

Offset = RF cable loss + attenuator factor.

Following shows an offset computation example with cable loss 4.2 dB and 10dB attenuator.

Example :

$$\begin{aligned} \text{Offset(dB)} &= \text{RF cable loss(dB)} + \text{attenuator factor(dB)}. \\ &= 4.2 + 10 = 14.2 \text{ (dB)} \end{aligned}$$



2.5 Frequency List of Low/Middle/High Channels

LTE Band 12 Channel and Frequency List				
BW [MHz]	Channel/Frequency(MHz)	Lowest	Middle	Highest
10	Channel	23060	23095	23130
	Frequency	704	707.5	711
5	Channel	23035	23095	23155
	Frequency	701.5	707.5	713.5
3	Channel	23025	23095	23165
	Frequency	700.5	707.5	714.5
1.4	Channel	23017	23095	23173
	Frequency	699.7	707.5	715.3

LTE Band 17 Channel and Frequency List				
BW [MHz]	Channel/Frequency(MHz)	Lowest	Middle	Highest
10	Channel	23780	23790	23800
	Frequency	709	710	711
5	Channel	23755	23790	23825
	Frequency	706.5	710	713.5

LTE Band 25 Channel and Frequency List				
BW [MHz]	Channel/Frequency(MHz)	Lowest	Middle	Highest
20	Channel	26140	26340	26590
	Frequency	1860	1880	1905
15	Channel	26115	26340	26615
	Frequency	1857.5	1880	1907.5
10	Channel	26090	26340	26640
	Frequency	1855	1880	1910
5	Channel	26065	26340	26665
	Frequency	1852.5	1880	1912.5
3	Channel	26055	26340	26675
	Frequency	1851.5	1880	1913.5
1.4	Channel	26047	26340	26683
	Frequency	1850.7	1880	1914.3



LTE Band 38 Channel and Frequency List				
BW [MHz]	Channel/Frequency(MHz)	Lowest	Middle	Highest
20	Channel	37850	38000	38150
	Frequency	2580	2595	2610
15	Channel	37825	38000	38175
	Frequency	2577.5	2595	2612.5
10	Channel	37800	38000	38200
	Frequency	2575	2595	2615
5	Channel	37775	38000	38225
	Frequency	2572.5	2595	2617.5

3 Conducted Test Items

3.1 Measuring Instruments

See list of measuring instruments of this test report.

3.2 Test Setup

3.2.1 Conducted Output Power

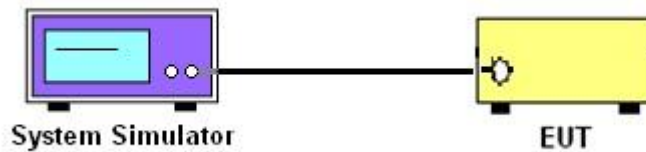

3.2.2 Peak-to-Average Ratio, Occupied Bandwidth, Conducted Band-Edge and Conducted Spurious Emission

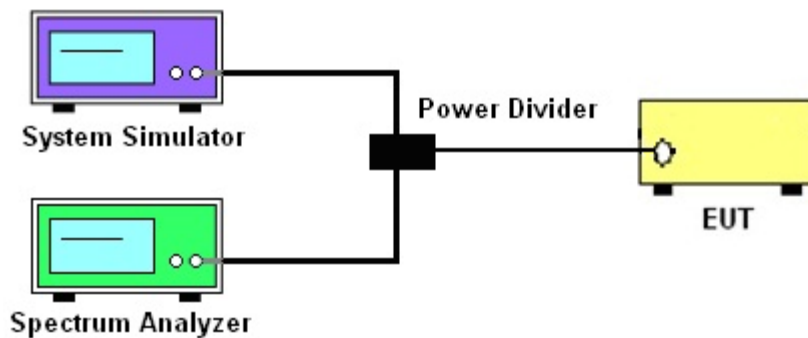

3.2.3 Frequency Stability

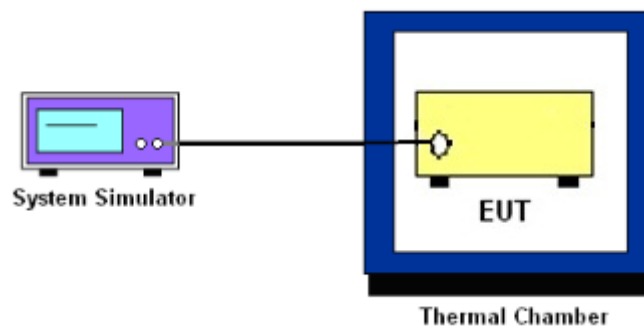

3.3 Test Result of Conducted Test

Please refer to Appendix A.



3.4 Conducted Output Power

3.4.1 Description of the Conducted Output Power Measurement

A system simulator was used to establish communication with the EUT. Its parameters were set to force the EUT transmitting at maximum output power. The measured power in the radio frequency on the transmitter output terminals shall be reported.

3.4.2 Test Procedures

1. The transmitter output port was connected to the system simulator.
2. Set EUT at maximum power through the system simulator.
3. Select lowest, middle, and highest channels for each band and different modulation.
4. Measure and record the power level from the system simulator.



3.5 Peak-to-Average Ratio

3.5.1 Description of the PAR Measurement

Power Complementary Cumulative Distribution Function (CCDF) curves provide a means for characterizing the power peaks of a digitally modulated signal on a statistical basis. A CCDF curve depicts the probability of the peak signal amplitude exceeding the average power level. Most contemporary measurement instrumentation include the capability to produce CCDF curves for an input signal provided that the instrument's resolution bandwidth can be set wide enough to accommodate the entire input signal bandwidth. In measuring transmissions in this band using an average power technique, the peak-to-average ratio (PAR) of the transmission may not exceed 13 dB.

3.5.2 Test Procedures

1. The testing follows FCC KDB 971168 v02r02 Section 5.7.1.
2. The EUT was connected to spectrum and system simulator via a power divider.
3. Set the CCDF (Complementary Cumulative Distribution Function) option in spectrum analyzer.
4. The highest RF powers were measured and recorded the maximum PAPR level associated with a probability of 0.1 %.
5. Record the deviation as Peak to Average Ratio.



3.6 Occupied Bandwidth

3.6.1 Description of Occupied Bandwidth Measurement

The occupied bandwidth is the width of a frequency band such that, below the lower and above the upper frequency limits, the mean powers emitted are each equal to a specified percentage 0.5% of the total mean transmitted power.

The 26 dB emission bandwidth is defined as the frequency range between two points, one above and one below the carrier frequency, at which the spectral density of the emission is attenuated 26 dB below the maximum in-band spectral density of the modulated signal. Spectral density (power per unit bandwidth) is to be measured with a detector of resolution bandwidth equal to approximately 1.0% of the emission bandwidth.

3.6.2 Test Procedures

1. The testing follows FCC KDB 971168 v02r02 Section 4.2.
2. The EUT was connected to spectrum analyzer and system simulator via a power divider.
3. The spectrum analyzer center frequency is set to the nominal EUT channel center frequency. The span range for the spectrum analyzer shall be between two and five times the anticipated OBW.
4. The nominal resolution bandwidth (RBW) shall be in the range of 1 to 5 % of the anticipated OBW, and the VBW shall be at least 3 times the RBW.
5. Set the detection mode to peak, and the trace mode to max hold.
6. Determine the reference value: Set the EUT to transmit a modulated signal. Allow the trace to stabilize. Set the spectrum analyzer marker to the highest level of the displayed trace.
(this is the reference value)
7. Determine the “-26 dB down amplitude” as equal to (Reference Value – X).
8. Place two markers, one at the lowest and the other at the highest frequency of the envelope of the spectral display such that each marker is at or slightly below the “-X dB down amplitude” determined in step 6. If a marker is below this “-X dB down amplitude” value it shall be placed as close as possible to this value. The OBW is the positive frequency difference between the two markers.
9. Use the 99 % power bandwidth function of the spectrum analyzer and report the measured bandwidth.



3.7 Conducted Band Edge

3.7.1 Description of Conducted Band Edge Measurement

24.238 (a) for Band 25

For operations in the 1850-1910 and 1930-1990 MHz band, the FCC limit is $43 + 10\log_{10}(P[\text{Watts}])$ dB below the transmitter power $P(\text{Watts})$ in a 1MHz bandwidth. However, in the 1 MHz bands immediately outside and adjacent to the frequency block a resolution bandwidth of at least one percent of the emission bandwidth of the fundamental emission of the transmitter may be employed.

27.53 (g) for Band 12,17

For operations in the 698 -746 MHz band, the FCC limit is $43 + 10\log_{10}(P[\text{Watts}])$ dB below the transmitter power $P(\text{Watts})$ in a 100 kHz bandwidth. However, in the 100 kilohertz bands immediately outside and adjacent to a licensee's frequency block, a resolution bandwidth of at least 30 kHz may be employed.

27.53(m)(4) for Band 38:

For mobile digital stations, the attenuation factor shall be not less than $40 + 10 \log (P)$ dB on all frequencies between the channel edge and 5 megahertz from the channel edge, $43 + 10 \log (P)$ dB on all frequencies between 5 megahertz and X megahertz from the channel edge, and $55 + 10 \log (P)$ dB on all frequencies more than X megahertz from the channel edge, where X is the greater of 6 megahertz or the actual emission bandwidth as defined in paragraph (m)(6) of this section. In addition, the attenuation factor shall not be less that $43 + 10 \log (P)$ dB on all frequencies between 2490.5 MHz and 2496 MHz and $55 + 10 \log (P)$ dB at or below 2490.5 MHz. Mobile Satellite Service licensees operating on frequencies below 2495 MHz may also submit a documented interference complaint against BRS licensees operating on channel BRS Channel 1 on the same terms and conditions as adjacent channel BRS or EBS licensees.



3.7.2 Test Procedures

1. The testing follows FCC KDB 971168 v02r02 Section 6.0.
2. The EUT was connected to spectrum analyzer and system simulator via a power divider.
3. The band edges of low and high channels for the highest RF powers were measured.
4. Set RBW \geq 1% EBW in the 1MHz band immediately outside and adjacent to the band edge.
5. Beyond the 1 MHz band from the band edge, RBW=1MHz was used.
6. Set spectrum analyzer with RMS detector.
7. The RF fundamental frequency should be excluded against the limit line in the operating frequency band.
8. Checked that all the results comply with the emission limit line.

Example:

The limit line is derived from $43 + 10\log(P)$ dB below the transmitter power P(Watts)

$$= P(W) - [43 + 10\log(P)] \text{ (dB)}$$

$$= [30 + 10\log(P)] \text{ (dBm)} - [43 + 10\log(P)] \text{ (dB)} = -13\text{dBm}.$$

9. For LTE Band 38, the other 40 dB and 55 dB have additionally applied same calculation above.



3.8 Conducted Spurious Emission

3.8.1 Description of Conducted Spurious Emission Measurement

The power of any emission outside of the authorized operating frequency ranges must be lower than the transmitter power (P) by a factor of at least $43 + 10 \log (P)$ dB.

For Band 38:

The power of any emission outside of the authorized operating frequency ranges must be lower than the transmitter power (P) by a factor of at least $55 + 10 \log (P)$ dB.

It is measured by means of a calibrated spectrum analyzer and scanned from 30 MHz up to a frequency including its 10th harmonic.

3.8.2 Test Procedures

1. The testing follows FCC KDB 971168 v02r02 Section 6.0.
2. The EUT was connected to spectrum analyzer and system simulator via a power divider.
3. The RF output of EUT was connected to the spectrum analyzer by RF cable and attenuator. The path loss was compensated to the results for each measurement.
4. The middle channel for the highest RF power within the transmitting frequency was measured.
5. The conducted spurious emission for the whole frequency range was taken.
6. Make the measurement with the spectrum analyzer's RBW = 1MHz, VBW = 3MHz.
7. Set spectrum analyzer with RMS detector.
8. Taking the record of maximum spurious emission.
9. The RF fundamental frequency should be excluded against the limit line in the operating frequency band.
10. The limit line is derived from $43 + 10\log(P)$ dB below the transmitter power P(Watts)
= $P(W) - [43 + 10\log(P)]$ (dB)
= $[30 + 10\log(P)]$ (dBm) - $[43 + 10\log(P)]$ (dB)
= -13dBm.
11. For Band 38
The limit line is derived from $55 + 10\log(P)$ dB below the transmitter power P(Watts)
= $P(W) - [55 + 10\log(P)]$ (dB)
= $[30 + 10\log(P)]$ (dBm) - $[55 + 10\log(P)]$ (dB)
= -25dBm.



3.9 Frequency Stability

3.9.1 Description of Frequency Stability Measurement

The frequency stability shall be measured by variation of ambient temperature and variation of primary supply voltage to ensure that the fundamental emission stays within the authorized frequency block. The frequency stability of the transmitter shall be maintained within $\pm 0.00025\%$ ($\pm 2.5\text{ppm}$) of the center frequency.

3.9.2 Test Procedures for Temperature Variation

1. The testing follows FCC KDB 971168 v02r02 Section 9.0.
2. The EUT was set up in the thermal chamber and connected with the system simulator.
3. With power OFF, the temperature was decreased to -30°C and the EUT was stabilized before testing. Power was applied and the maximum change in frequency was recorded within one minute.
4. With power OFF, the temperature was raised in 10°C step up to 50°C . The EUT was stabilized at each step for at least half an hour. Power was applied and the maximum frequency change was recorded within one minute.

3.9.3 Test Procedures for Voltage Variation

1. The testing follows FCC KDB 971168 v02r02 Section 9.0.
2. The EUT was placed in a temperature chamber at $25\pm 5^{\circ}\text{C}$ and connected with the system simulator.
3. The power supply voltage to the EUT was varied from 85% to 115% of the nominal value measured at the input to the EUT.
4. The variation in frequency was measured for the worst case.

4 Radiated Test Items

4.1 Measuring Instruments

See list of measuring instruments of this test report.

4.2 Test Setup

4.2.1 For radiated test from 30MHz to 1GHz

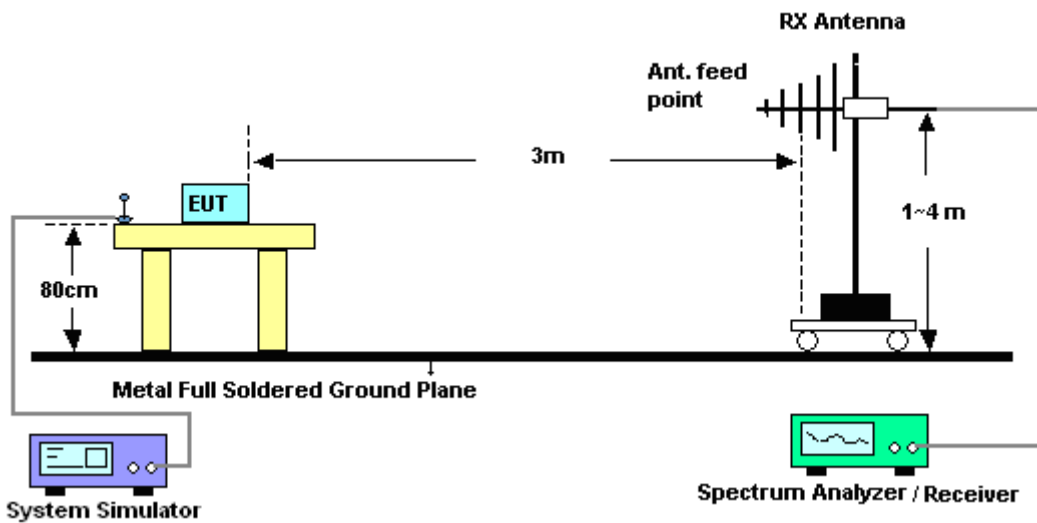

4.2.2 For radiated test above 1GHz

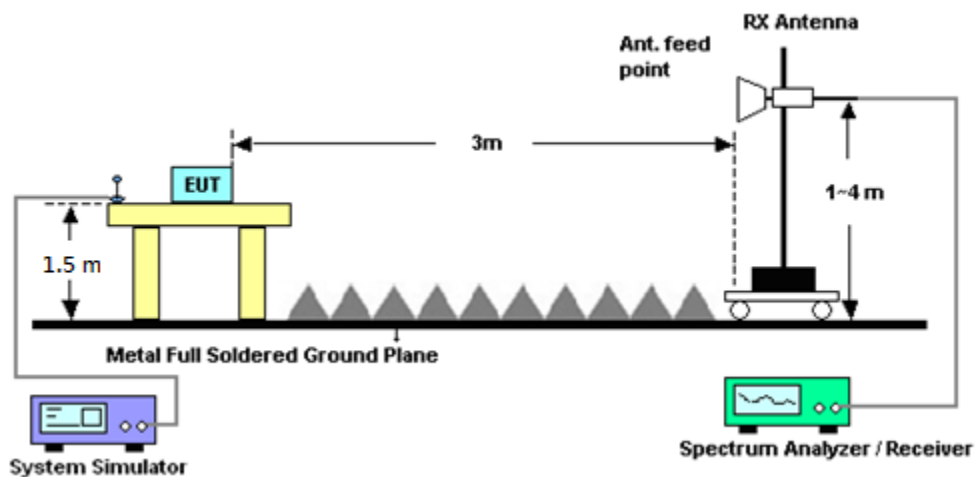

4.3 Test Result of Radiated Test

Please refer to Appendix B.



4.4 Effective Radiated Power and Effective Isotropic Radiated Power

4.4.1 Description of the ERP/EIRP Measurement

Effective radiated power output measurements by substitution method according to ANSI / TIA / EIA-603-D-2010, and the spectrum analyzer configuration follows KDB 971168 D01 Power Meas. License Digital Systems v02r02. Mobile and portable (hand-held) stations operating are limited to average ERP of 3 watts with LTE band 12 / 17.

Equivalent isotropic radiated power output measurements by substitution method according to ANSI / TIA / EIA-603-D-2010, and the spectrum analyzer configuration follows KDB 971168 D01 Power Meas. License Digital Systems v02r02. Mobile and portable (hand-held) stations operating are limited to average EIRP of 2 watts with LTE band 25 / 38.

4.4.2 Test Procedures

1. The EUT was placed on a non-conductive rotating platform (0.8 meters for frequency below 1GHz and 1.5 meter for frequency above 1GHz) in a semi-anechoic chamber. The radiated emission at the fundamental frequency was measured at 3 m with a test antenna and a spectrum analyzer with RMS detector per section 5. of KDB 971168 D01.
2. During the measurement, the system simulator parameters were set to force the EUT transmitting at maximum output power. The maximum emission was recorded from analyzer power level (LVL) from the 360 degrees rotation of the turntable and the test antenna raised and lowered over a range from 1 to 4 meters in both horizontally and vertically polarized orientations.
3. Effective Isotropic Radiated Power (EIRP) was measured by substitution method according to TIA/EIA-603-D. The EUT was replaced by the substitution antenna at same location, and then a known power from S.G. was applied into the dipole antenna through a Tx cable, and then recorded the maximum Analyzer reading through raised and lowered the test antenna. The correction factor (in dB) = S.G. - Tx Cable loss + Substitution antenna gain - Analyzer reading. Then the EUT's EIRP was calculated with the correction factor, $EIRP = LVL + \text{Correction factor}$ and $ERP = EIRP - 2.15$. Take the record of the output power at substitution antenna.



	LTE Average					
LTE BW	1.4M	3M	5M	10M	15M	20M
Span	3MHz	6MHz	10MHz	20MHz	30MHz	40MHz
RBW	30kHz	100kHz	100kHz	300kHz	300kHz	300kHz
VBW	100kHz	300kHz	300kHz	1MHz	1MHz	1MHz
Detector	RMS	RMS	RMS	RMS	RMS	RMS
Trace	Average	Average	Average	Average	Average	Average
Average Type	Power	Power	Power	Power	Power	Power
Sweep Count	100	100	100	100	100	100



4.5 Radiated Spurious Emission

4.5.1 Description of Radiated Spurious Emission

The radiated spurious emission was measured by substitution method according to ANSI / TIA / EIA-603-D-2010. The power of any emission outside of the authorized operating frequency ranges must be attenuated below the transmitter power (P) by a factor of at least $43 + 10 \log (P)$ dB.

For Band 38

The power of any emission outside of the authorized operating frequency ranges must be attenuated below the transmitter power (P) by a factor of at least $55 + 10 \log (P)$ dB.

For LTE Band 12 and 17

For operations in the 746-758 MHz, 775-788 MHz, and 805-806 MHz bands, emissions in the band 1559-1610 MHz shall be limited to -70 dBW/MHz equivalent isotropically radiated power (EIRP) for wideband signals, and -80 dBW EIRP for discrete emissions of less than 700 Hz bandwidth.

The spectrum is scanned from 30 MHz up to a frequency including its 10th harmonic.



4.5.2 Test Procedures

1. The testing follows FCC KDB 971168 v02r02 Section 5.8 and ANSI / TIA-603-D-2010 Section 2.2.12.
2. The EUT was placed on a turntable with 0.8 meter for frequency below 1GHz and 1.5 meter for frequency above 1GHz respectively above ground.
3. The EUT was set 3 meters from the receiving antenna, which was mounted on the antenna tower.
4. The table was rotated 360 degrees to determine the position of the highest spurious emission.
5. The height of the receiving antenna is varied between one meter and four meters to search the maximum spurious emission for both horizontal and vertical polarizations.
6. Make the measurement with the spectrum analyzer's RBW = 1MHz, VBW = 3MHz, taking the record of maximum spurious emission.
7. A horn antenna was substituted in place of the EUT and was driven by a signal generator.
8. Tune the output power of signal generator to the same emission level with EUT maximum spurious emission.
9. Taking the record of output power at antenna port.
10. Repeat step 7 to step 8 for another polarization.
11. The RF fundamental frequency should be excluded against the limit line in the operating frequency band.

The limit line is derived from $43 + 10\log(P)$ dB below the transmitter power P(Watts)
 $= P(W) - [43 + 10\log(P)]$ (dB)
 $= [30 + 10\log(P)]$ (dBm) - $[43 + 10\log(P)]$ (dB)
 $= -13$ dBm.

12. For Band 38:

The limit line is derived from $55 + 10\log(P)$ dB below the transmitter power P(Watts)
 $EIRP$ (dBm) = S.G. Power – Tx Cable Loss + Tx Antenna Gain
 ERP (dBm) = $EIRP - 2.15$



5 List of Measuring Equipment

Instrument	Manufacturer	Model No.	Serial No.	Characteristics	Calibration Date	Test Date	Due Date	Remark
LTE Base Station	Anritsu	MT8820C	620143282 1	GSM/GPRS /WCDMA/LTE	Oct. 16, 2015	May 07, 2016 ~ May 15, 2016	Oct. 15, 2016	Conducted (TH05-HY)
Spectrum Analyzer	Rohde & Schwarz	FSV40	101397	10Hz~40GHz	Sep. 11, 2015	May 07, 2016 ~ May 15, 2016	Sep. 10, 2016	Conducted (TH05-HY)
EMI Test Receiver	Keysight	N9038A (MXE)	MY541300 85	20Hz ~ 8.4GHz	Nov. 04, 2015	May 07, 2016 ~ May 15, 2016	Nov. 03, 2016	Conducted (TH05-HY)
Temperature Chamber	ESPEC	SH-641	92013720	-30°C~70°C	Sep. 08, 2015	May 07, 2016 ~ May 15, 2016	Sep. 07, 2016	Conducted (TH05-HY)
Programmable Power Supply	GW Instek	PSS-2005	EL890089	1V~20V 0.5A~5A	Jan. 18, 2016	May 07, 2016 ~ May 15, 2016	Jan. 17, 2017	Conducted (TH05-HY)
Amplifier	SONOMA	310N	187312	9kHz~1GHz	Nov. 20, 2015	May 06, 2016 ~ May 27, 2016	Nov. 19, 2016	Radiation (03CH12-HY)
Bilog Antenna	TESEQ	CBL 6111D	35414	30MHz~1GHz	Nov. 17, 2015	May 06, 2016 ~ May 27, 2016	Nov. 16, 2016	Radiation (03CH12-HY)
Horn Antenna	SCHWARZBE CK	BBHA 9120 D	9120D-132 6	1GHz ~ 18GHz	Oct. 08, 2015	May 06, 2016 ~ May 27, 2016	Oct. 07, 2016	Radiation (03CH12-HY)
Spectrum Analyzer	Keysight	N9010A	MY542004 86	10Hz ~ 44GHZ	Sep. 24, 2015	May 06, 2016 ~ May 27, 2016	Sep. 23, 2016	Radiation (03CH12-HY)
Bilog Antenna	TESEQ	CBL 6111D	37059	30MHz~1GHz	Dec. 29, 2015	May 06, 2016 ~ May 27, 2016	Dec. 28, 2016	Radiation (03CH12-HY)
EMI Test Receiver	Rohde & Schwarz	ESU26	100390	20Hz~26.5GHz	Dec. 21, 2015	May 06, 2016 ~ May 27, 2016	Dec. 20, 2016	Radiation (03CH12-HY)
Horn Antenna	SCHWARZBE CK	BBHA 9120D	9120D-132 8	1GHz ~ 18GHz	Nov. 02, 2015	May 06, 2016 ~ May 27, 2016	Nov. 01, 2016	Radiation (03CH12-HY)
Preamplifier	MITEQ	AMF-7D-0010 1800-30-10P	1815698	1GHz~18GHz	Dec. 14, 2015	May 06, 2016 ~ May 27, 2016	Dec. 13, 2016	Radiation (03CH12-HY)
Antenna Mast	EMEC	AM-BS-4500- B	N/A	1m~4m	N/A	May 06, 2016 ~ May 27, 2016	N/A	Radiation (03CH12-HY)
Turn Table	EMEC	TT2000	N/A	0~360 Degree	N/A	May 06, 2016 ~ May 27, 2016	N/A	Radiation (03CH12-HY)
SHF-EHF Horn Antenna	SCHWARZBE CK	BBHA 9170	BBHA9170 576	18GHz ~ 40GHz	Apr. 15, 2016	May 06, 2016 ~ May 27, 2016	Apr. 14, 2017	Radiation (03CH12-HY)
Preamplifier	MITEQ	JS44-180040 00-33-8P	1840917	18GHz ~ 40GHz	Jun. 02, 2015	May 06, 2016 ~ May 27, 2016	Jun. 01, 2016	Radiation (03CH12-HY)
SHF-EHF Horn Antenna	SCHWARZBE CK	BBHA 9170	BBHA9170 584	18GHz- 40GHz	Nov. 02, 2015	May 06, 2016 ~ May 27, 2016	Nov. 01, 2016	Radiation (03CH12-HY)
Signal Generator	Rohde & Schwarz	SMF100A	101107	100kHz~40GHz	May 22, 2015	May 06, 2016 ~ May 18, 2016	May 21, 2016	Radiation (03CH12-HY)
Signal Generator	Rohde & Schwarz	SMF100A	101107	100kHz~40GHz	May 19, 2016	May 19, 2016 ~ May 27, 2016	May 18, 2017	Radiation (03CH12-HY)



6 Uncertainty of Evaluation

Uncertainty of Radiated Emission Measurement (30 MHz ~ 1000 MHz)

Measuring Uncertainty for a Level of Confidence of 95% ($U = 2Uc(y)$)	5.40
---	------



Appendix A. Test Results of Conducted Test

Conducted Output Power(Average power)

LTE Band 25 Maximum Average Power [dBm]						
BW [MHz]	RB Size	RB Offset	Mod	Lowest	Middle	Highest
20	1	0	QPSK	22.96	23.20	23.19
20	1	49		22.23	22.36	22.33
20	1	99		22.39	22.55	22.40
20	50	0		21.62	21.77	21.76
20	50	24		21.37	21.48	21.48
20	50	50		21.37	21.46	21.47
20	100	0		21.52	21.68	21.67
20	1	0	16-QAM	22.25	22.35	22.44
20	1	49		21.46	21.56	21.56
20	1	99		21.60	21.76	21.74
20	50	0		20.64	20.72	20.76
20	50	24		20.37	20.48	20.48
20	50	50		20.35	20.44	20.46
20	100	0		20.48	20.57	20.63
15	1	0	QPSK	22.76	22.91	22.95
15	1	37		22.27	22.48	22.48
15	1	74		22.36	22.49	22.54
15	36	0		21.53	21.68	21.71
15	36	20		21.35	21.50	21.51
15	36	39		21.33	21.46	21.48
15	75	0		21.43	21.58	21.62
15	1	0	16-QAM	21.99	22.13	22.15
15	1	37		21.43	21.58	21.55
15	1	74		21.58	21.69	21.69
15	36	0		20.51	20.63	20.65
15	36	20		20.33	20.48	20.49
15	36	39		20.29	20.43	20.43
15	75	0		20.39	20.53	20.55



LTE Band 25 Maximum Average Power [dBm]						
BW [MHz]	RB Size	RB Offset	Mod	Lowest	Middle	Highest
10	1	0	QPSK	22.48	22.69	22.63
10	1	25		22.29	22.45	22.37
10	1	49		22.27	22.37	22.21
10	25	0		21.47	21.63	21.60
10	25	12		21.41	21.55	21.50
10	25	25		21.35	21.47	21.44
10	50	0		21.40	21.57	21.52
10	1	0	16-QAM	21.73	21.90	21.89
10	1	25		21.49	21.65	21.61
10	1	49		21.47	21.59	21.57
10	25	0		20.46	20.59	20.57
10	25	12		20.40	20.53	20.50
10	25	25		20.34	20.46	20.46
10	50	0		20.39	20.53	20.51
5	1	0	QPSK	22.33	22.56	22.47
5	1	12		22.27	22.45	22.33
5	1	24		22.26	22.42	22.23
5	12	0		21.35	21.54	21.52
5	12	7		21.35	21.52	21.52
5	12	13		21.32	21.47	21.47
5	25	0		21.31	21.48	21.44
5	1	0	16-QAM	21.55	21.73	21.72
5	1	12		21.50	21.68	21.62
5	1	24		21.42	21.59	21.55
5	12	0		20.39	20.54	20.54
5	12	7		20.36	20.52	20.52
5	12	13		20.33	20.50	20.48
5	25	0		20.34	20.49	20.50



LTE Band 25 Maximum Average Power [dBm]						
BW [MHz]	RB Size	RB Offset	Mod	Lowest	Middle	Highest
3	1	0	QPSK	22.26	22.49	22.35
3	1	8		22.35	22.54	22.39
3	1	14		22.18	22.38	22.19
3	8	0		21.33	21.50	21.48
3	8	4		21.34	21.52	21.50
3	8	7		21.32	21.49	21.47
3	15	0		21.31	21.49	21.46
3	1	0	16-QAM	21.48	21.67	21.62
3	1	8		21.57	21.76	21.68
3	1	14		21.41	21.57	21.50
3	8	0		20.40	20.55	20.58
3	8	4		20.42	20.58	20.61
3	8	7		20.36	20.52	20.58
3	15	0		20.34	20.52	20.50
1.4	1	0	QPSK	22.24	22.42	22.31
1.4	1	3		22.29	22.50	22.38
1.4	1	5		22.18	22.39	22.26
1.4	3	0		22.28	22.46	22.38
1.4	3	1		22.31	22.50	22.42
1.4	3	3		22.30	22.50	22.43
1.4	6	0		21.26	21.44	21.45
1.4	1	0	16-QAM	21.41	21.63	21.52
1.4	1	3		21.50	21.70	21.60
1.4	1	5		21.40	21.60	21.47
1.4	3	0		21.30	21.49	21.40
1.4	3	1		21.35	21.54	21.45
1.4	3	3		21.33	21.53	21.45
1.4	6	0		20.34	20.51	20.49



LTE Band 12 Maximum Average Power [dBm]						
BW [MHz]	RB Size	RB Offset	Mod	Lowest	Middle	Highest
10	1	0	QPSK	22.62	22.63	22.61
10	1	25		22.61	22.52	22.47
10	1	49		22.42	22.45	22.59
10	25	0		21.72	21.73	21.68
10	25	12		21.62	21.62	21.61
10	25	25		21.64	21.62	21.65
10	50	0		21.71	21.72	21.70
10	1	0	16-QAM	21.79	21.72	21.73
10	1	25		21.88	21.78	21.76
10	1	49		21.67	21.73	21.85
10	25	0		20.66	20.56	20.51
10	25	12		20.58	20.60	20.59
10	25	25		20.61	20.61	20.73
10	50	0		20.64	20.62	20.68
5	1	0	QPSK	22.38	22.34	22.34
5	1	12		22.59	22.41	22.59
5	1	24		22.58	22.42	22.68
5	12	0		21.61	21.55	21.62
5	12	7		21.71	21.47	21.74
5	12	13		21.72	21.46	21.68
5	25	0		21.66	21.55	21.68
5	1	0	16-QAM	21.82	21.73	21.78
5	1	12		21.84	21.70	21.88
5	1	24		21.80	21.68	21.93
5	12	0		20.61	20.63	20.61
5	12	7		20.69	20.57	20.70
5	12	13		20.70	20.59	20.68
5	25	0		20.66	20.54	20.69



LTE Band 12 Maximum Average Power [dBm]						
BW [MHz]	RB Size	RB Offset	Mod	Lowest	Middle	Highest
3	1	0	QPSK	22.37	22.35	22.38
3	1	8		22.62	22.49	22.67
3	1	14		22.55	22.35	22.61
3	8	0		21.68	21.65	21.66
3	8	4		21.65	21.47	21.69
3	8	7		21.64	21.54	21.76
3	15	0		21.61	21.53	21.64
3	1	0	16-QAM	21.79	21.73	21.82
3	1	8		21.89	21.79	21.95
3	1	14		21.81	21.63	21.88
3	8	0		20.71	20.60	20.68
3	8	4		20.67	20.62	20.72
3	8	7		20.68	20.57	20.78
3	15	0		20.66	20.56	20.69
1.4	1	0	QPSK	22.56	22.27	22.38
1.4	1	3		22.65	22.55	22.75
1.4	1	5		22.52	22.49	22.64
1.4	3	0		22.62	22.50	22.69
1.4	3	1		22.67	22.55	22.74
1.4	3	3		22.69	22.53	22.74
1.4	6	0		21.62	21.49	21.71
1.4	1	0	16-QAM	21.82	21.74	21.81
1.4	1	3		21.86	21.77	21.95
1.4	1	5		21.73	21.73	21.89
1.4	3	0		21.62	21.49	21.71
1.4	3	1		21.68	21.58	21.77
1.4	3	3		21.69	21.56	21.76
1.4	6	0		20.70	20.59	20.77



LTE Band 17 Maximum Average Power [dBm]						
BW [MHz]	RB Size	RB Offset	Mod	Lowest	Middle	Highest
10	1	0	QPSK	22.58	22.61	22.59
10	1	25		22.56	22.55	22.54
10	1	49		22.45	22.48	22.48
10	25	0		21.68	21.81	21.79
10	25	12		21.67	21.66	21.77
10	25	25		21.61	21.63	21.76
10	50	0		21.69	21.73	21.70
10	1	0	16-QAM	21.74	21.65	21.67
10	1	25		21.84	21.80	21.80
10	1	49		21.77	21.84	21.82
10	25	0		20.54	20.61	20.54
10	25	12		20.63	20.63	20.65
10	25	25		20.61	20.63	20.74
10	50	0		20.69	20.63	20.63
5	1	0	QPSK	22.17	22.27	22.38
5	1	12		22.40	22.51	22.60
5	1	24		22.48	22.50	22.64
5	12	0		21.43	21.56	21.64
5	12	7		21.43	21.63	21.74
5	12	13		21.41	21.62	21.73
5	25	0		21.43	21.57	21.67
5	1	0	16-QAM	21.57	21.70	21.80
5	1	12		21.66	21.80	21.92
5	1	24		21.68	21.72	21.87
5	12	0		20.45	20.59	20.66
5	12	7		20.48	20.65	20.72
5	12	13		20.46	20.63	20.73
5	25	0		20.42	20.58	20.68



LTE Band 38 Maximum Average Power [dBm]						
BW [MHz]	RB Size	RB Offset	Mod	Lowest	Middle	Highest
20	1	0	QPSK	23.21	22.99	23.16
20	1	49		22.88	22.76	22.90
20	1	99		22.96	22.91	22.95
20	50	0		21.33	21.18	21.13
20	50	24		21.14	21.00	21.03
20	50	50		21.15	21.05	21.08
20	100	0		21.22	21.08	21.13
20	1	0	16-QAM	21.69	21.53	21.63
20	1	49		21.18	21.05	21.11
20	1	99		21.20	21.10	21.18
20	50	0		20.38	20.19	20.16
20	50	24		20.18	20.00	20.04
20	50	50		20.14	20.01	20.06
20	100	0		20.20	20.04	20.11
15	1	0	QPSK	23.30	23.15	23.04
15	1	37		23.15	23.10	23.10
15	1	74		23.09	22.90	23.07
15	36	0		21.29	21.07	21.09
15	36	20		21.17	21.04	21.05
15	36	39		21.15	21.05	21.09
15	75	0		21.23	21.03	21.11
15	1	0	16-QAM	21.50	21.45	21.41
15	1	37		21.07	21.02	21.08
15	1	74		21.15	21.09	21.10
15	36	0		20.26	20.02	20.06
15	36	20		20.17	20.03	20.06
15	36	39		20.11	20.01	20.06
15	75	0		20.18	20.04	20.07



LTE Band 38 Maximum Average Power [dBm]						
BW [MHz]	RB Size	RB Offset	Mod	Lowest	Middle	Highest
10	1	0	QPSK	22.76	22.68	22.71
10	1	25		22.97	22.75	22.90
10	1	49		22.89	22.85	22.90
10	25	0		21.14	21.03	21.08
10	25	12		21.17	21.00	21.08
10	25	25		21.15	21.01	21.06
10	50	0		21.17	21.02	21.14
10	1	0	16-QAM	21.35	21.22	21.29
10	1	25		21.29	21.05	21.22
10	1	49		21.19	21.03	21.13
10	25	0		20.18	20.05	20.11
10	25	12		20.22	20.00	20.11
10	25	25		20.12	20.01	20.05
10	50	0		20.23	20.05	20.11
5	1	0	QPSK	22.66	22.49	22.67
5	1	12		22.87	22.74	22.97
5	1	24		22.84	22.75	22.96
5	12	0		21.16	21.05	21.12
5	12	7		21.11	21.06	21.12
5	12	13		21.12	21.08	21.11
5	25	0		21.05	21.00	21.04
5	1	0	16-QAM	21.24	21.07	21.25
5	1	12		21.23	21.06	21.25
5	1	24		21.19	21.05	21.20
5	12	0		20.22	20.09	20.18
5	12	7		20.15	20.10	20.14
5	12	13		20.18	20.08	20.16
5	25	0		20.13	20.06	20.14



LTE Band 12

Peak-to-Average Ratio

Mode	LTE Band 12 / 10MHz				
Mod.	QPSK		16QAM		Limit: 13dB
RB Size	1RB	Full RB	1RB	Full RB	Result
Lowest CH	3.80	5.30	4.87	6.14	PASS
Middle CH	3.86	5.13	4.55	6.29	
Highest CH	3.94	4.90	4.99	6.03	



LTE Band 12 / 10MHz / QPSK

Lowest Channel / 1RB

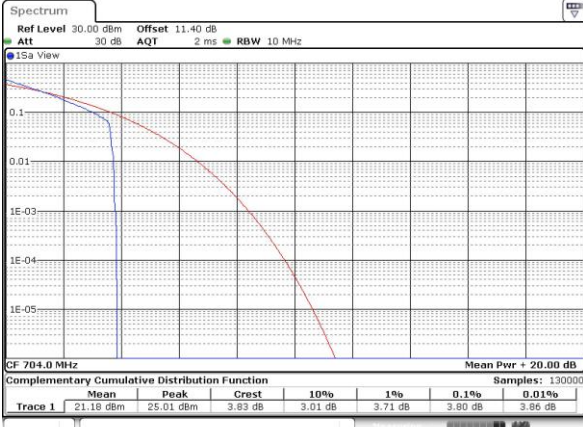

Date: 13.MAY.2016 12:00:24

Lowest Channel / Full RB

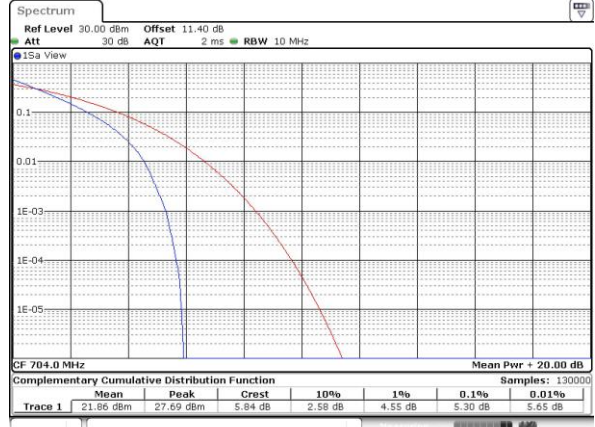

Date: 13.MAY.2016 12:00:13

Middle Channel / 1RB

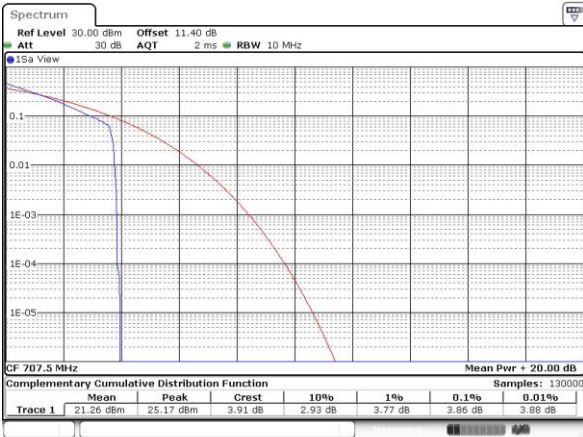

Date: 13.MAY.2016 12:00:46

Middle Channel / Full RB

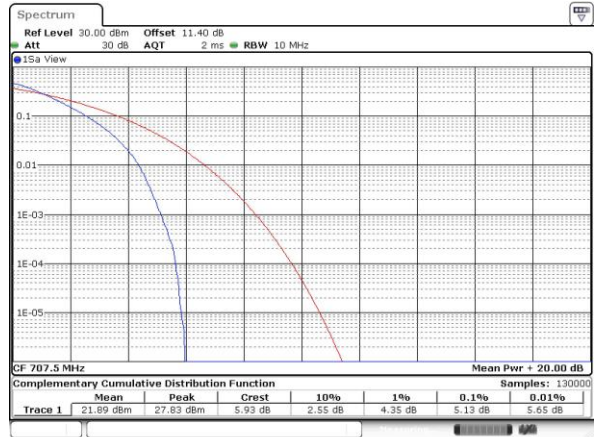

Date: 13.MAY.2016 12:00:59

Highest Channel / 1RB

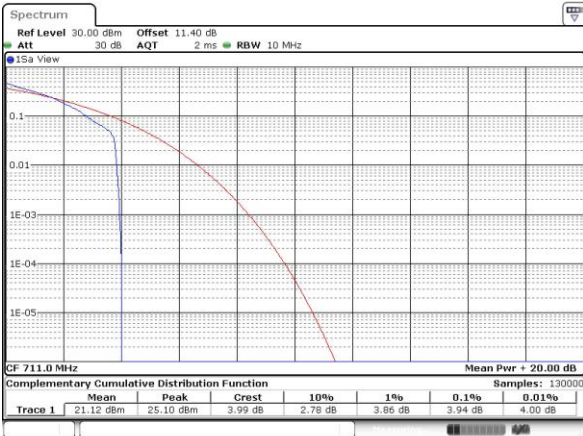

Date: 13.MAY.2016 12:01:40

Highest Channel / Full RB

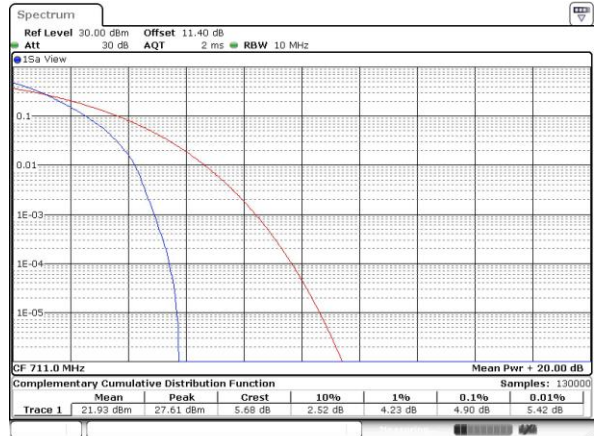

Date: 13.MAY.2016 12:01:29



LTE Band 12 / 10MHz / 16QAM

Lowest Channel / 1RB

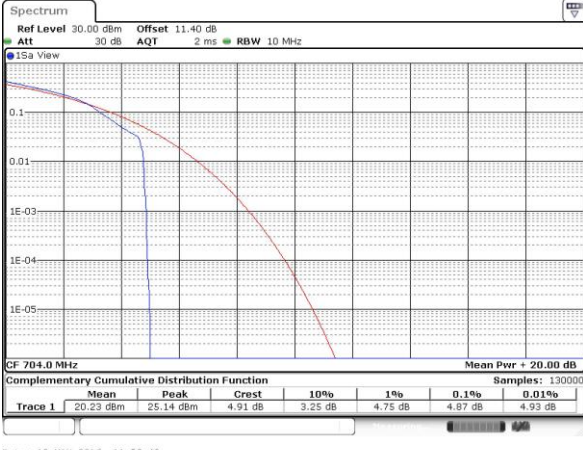

Date: 13.MAY.2016 11:58:43

Lowest Channel / Full RB

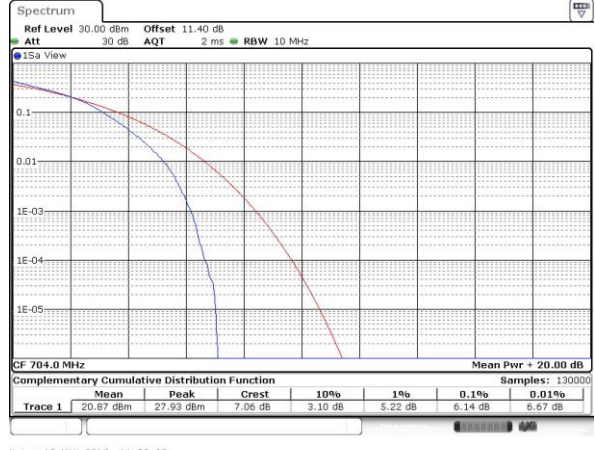

Date: 13.MAY.2016 11:58:22

Middle Channel / 1RB

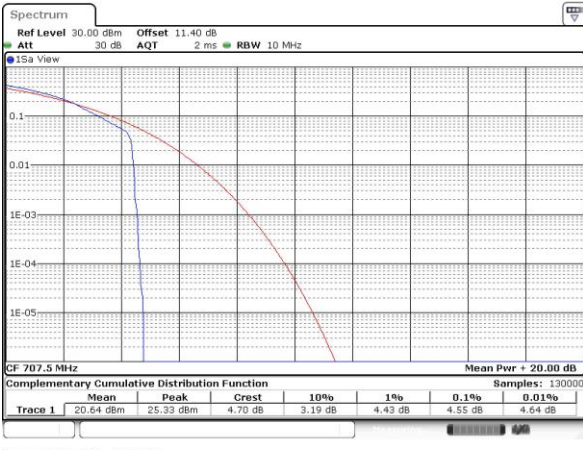

Date: 13.MAY.2016 11:58:54

Middle Channel / Full RB

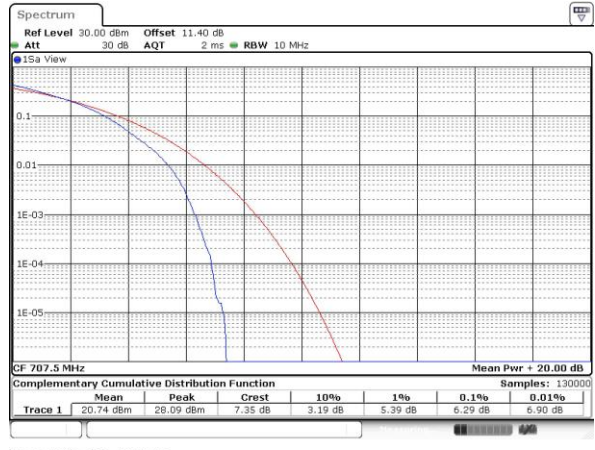

Date: 13.MAY.2016 11:59:05

Highest Channel / 1RB

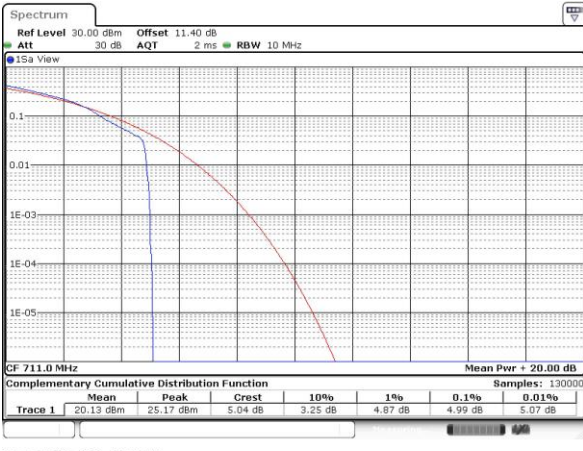

Date: 13.MAY.2016 11:59:34

Highest Channel / Full RB

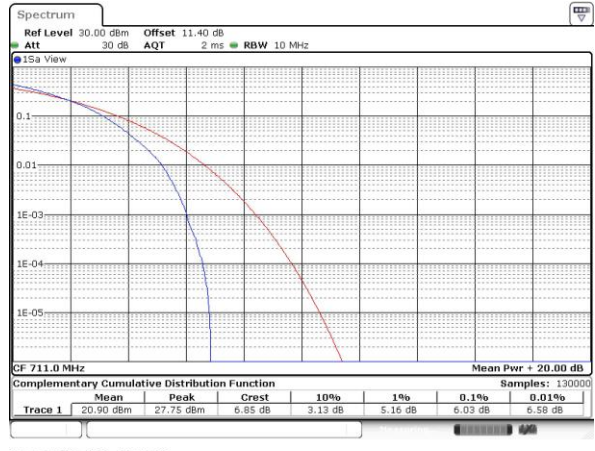

Date: 13.MAY.2016 11:59:16



26dB Bandwidth

Mode	LTE Band 12 : 26dB BW(MHz)											
	1.4MHz		3MHz		5MHz		10MHz		15MHz		20MHz	
BW	QPSK	16QAM	QPSK	16QAM	QPSK	16QAM	QPSK	16QAM	QPSK	16QAM	QPSK	16QAM
Mod.	QPSK	16QAM	QPSK	16QAM	QPSK	16QAM	QPSK	16QAM	QPSK	16QAM	QPSK	16QAM
Lowest CH	1.24	1.21	2.93	2.98	4.92	4.91	9.83	9.79	-	-	-	-
Middle CH	1.23	1.23	3.01	3.05	4.97	4.85	9.83	9.71	-	-	-	-
Highest CH	1.22	1.22	3.02	2.98	4.91	4.92	9.63	9.65	-	-	-	-



LTE Band 12

Lowest Channel / 1.4MHz / QPSK

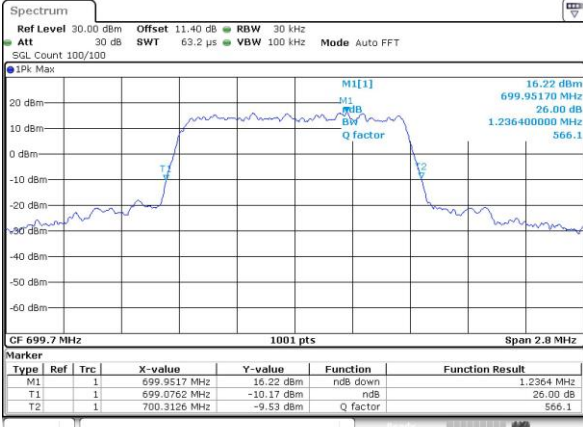

Date: 13.MAY.2016 11:25:00

Lowest Channel / 1.4MHz / 16QAM

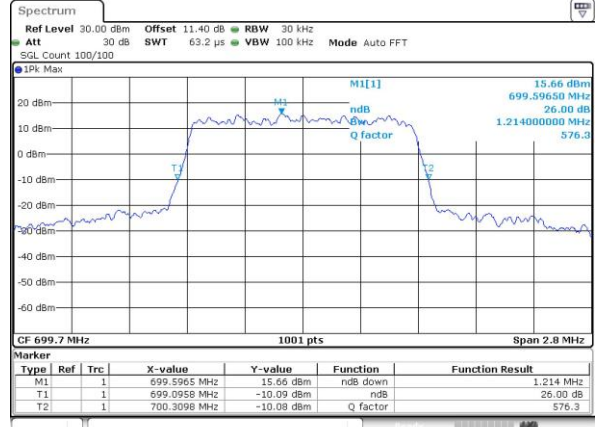

Date: 13.MAY.2016 11:24:48

Middle Channel / 1.4MHz / QPSK

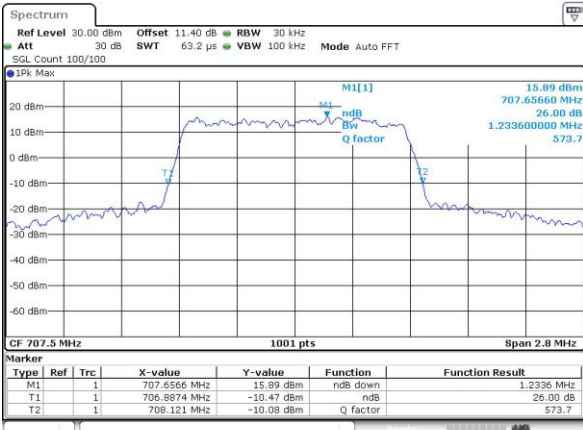

Date: 13.MAY.2016 11:35:41

Middle Channel / 1.4MHz / 16QAM

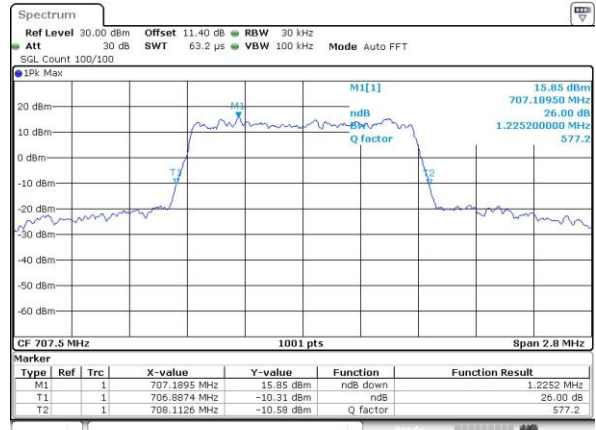

Date: 13.MAY.2016 11:35:53

Highest Channel / 1.4MHz / QPSK

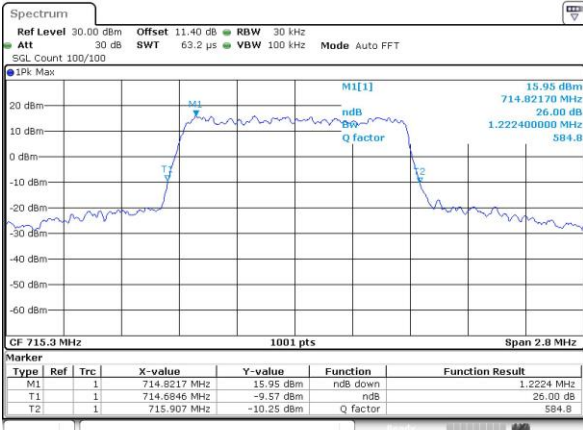

Date: 13.MAY.2016 11:38:36

Highest Channel / 1.4MHz / 16QAM

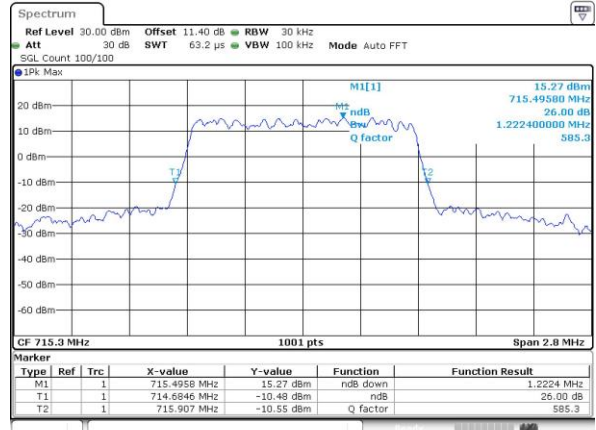

Date: 13.MAY.2016 11:38:24



LTE Band 12

Lowest Channel / 3MHz / QPSK

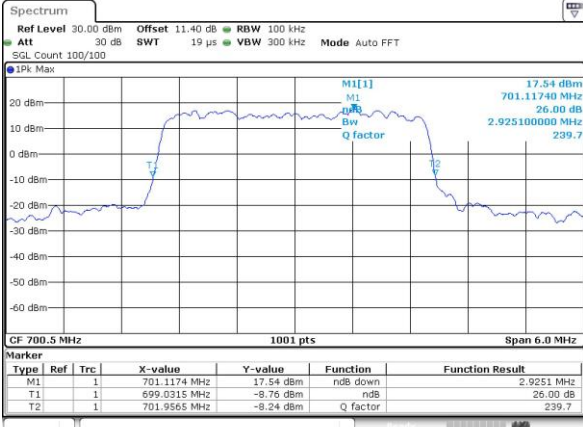

Date: 13.MAY.2016 10:09:18

Lowest Channel / 3MHz / 16QAM

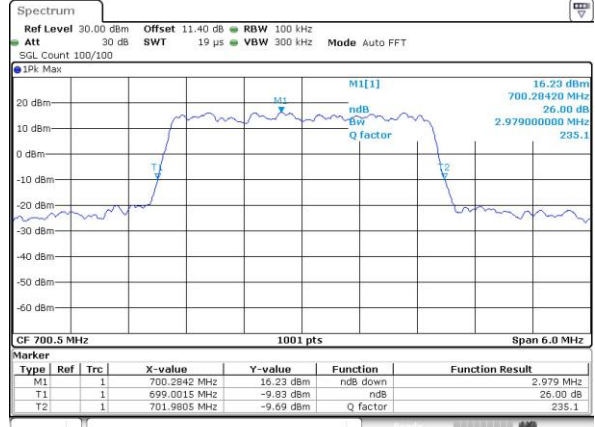

Date: 13.MAY.2016 10:09:06

Middle Channel / 3MHz / QPSK

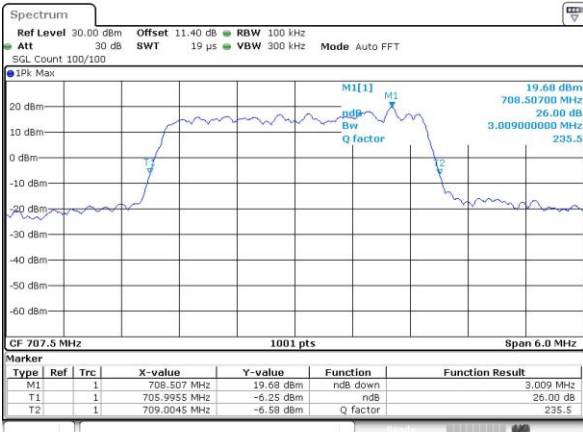

Date: 13.MAY.2016 10:21:07

Middle Channel / 3MHz / 16QAM

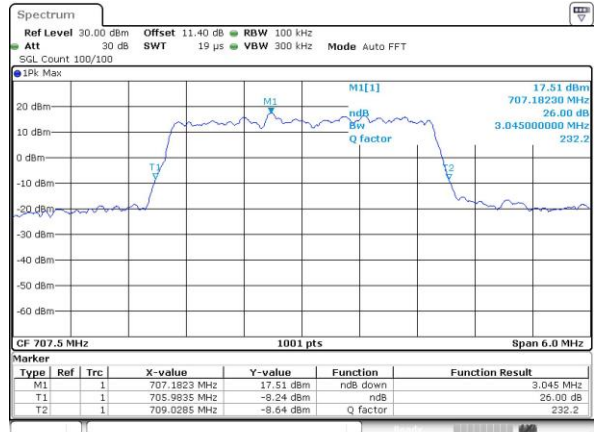

Date: 13.MAY.2016 10:21:19

Highest Channel / 3MHz / QPSK

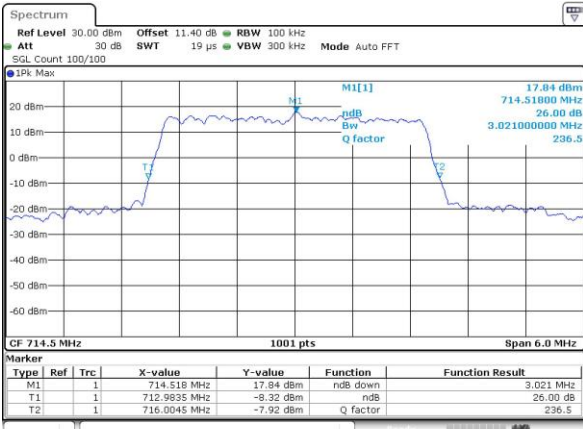

Date: 13.MAY.2016 10:24:56

Highest Channel / 3MHz / 16QAM

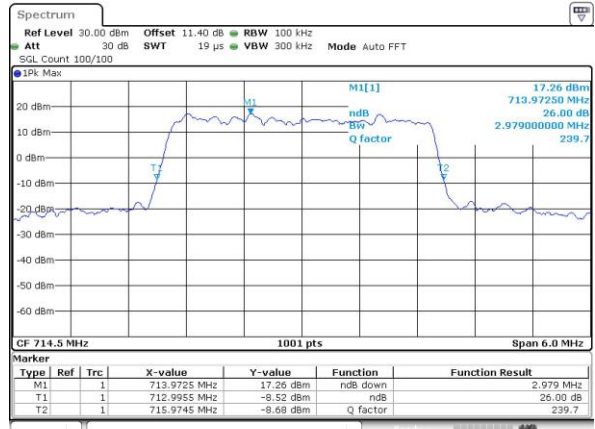

Date: 13.MAY.2016 10:24:44



LTE Band 12

Lowest Channel / 5MHz / QPSK

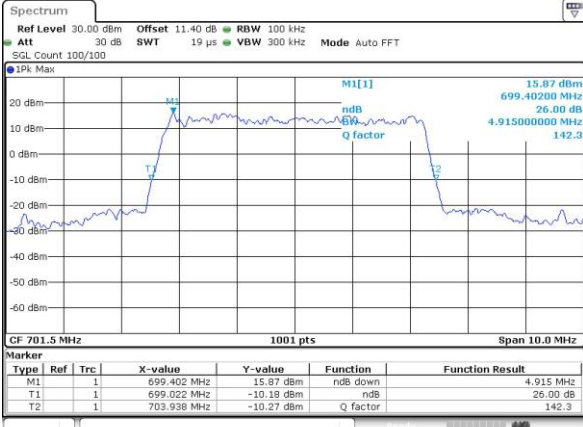

Date: 13.MAY.2016 10:35:53

Lowest Channel / 5MHz / 16QAM

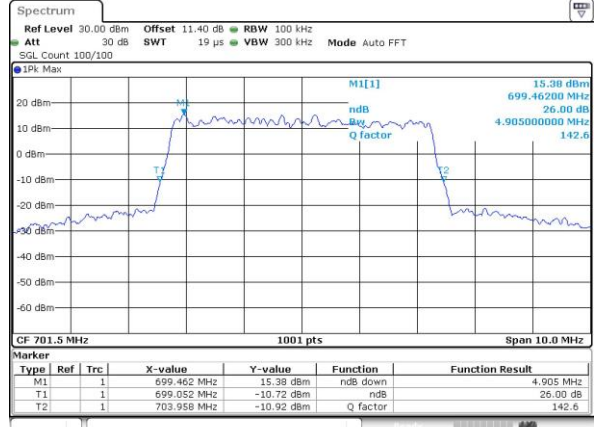

Date: 13.MAY.2016 10:35:41

Middle Channel / 5MHz / QPSK

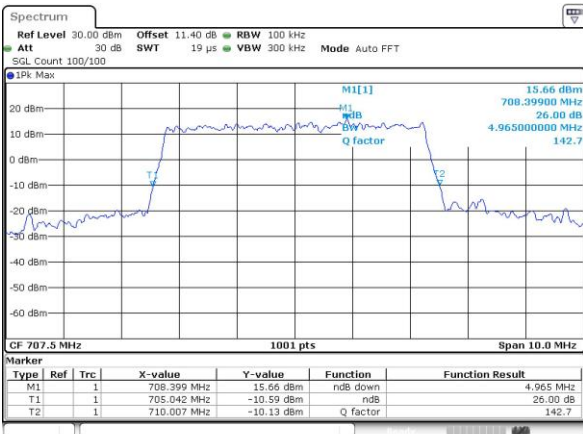

Date: 13.MAY.2016 10:46:05

Middle Channel / 5MHz / 16QAM

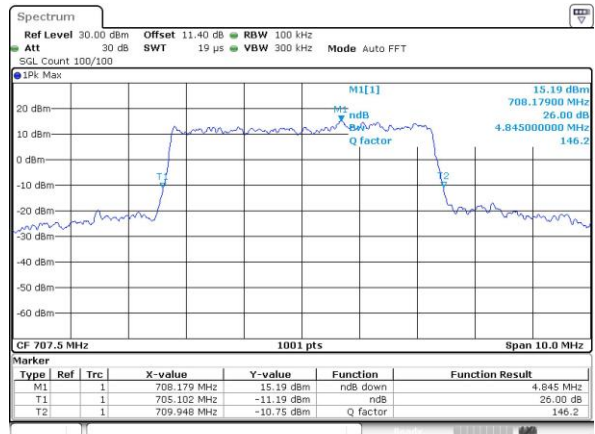

Date: 13.MAY.2016 10:46:47

Highest Channel / 5MHz / QPSK

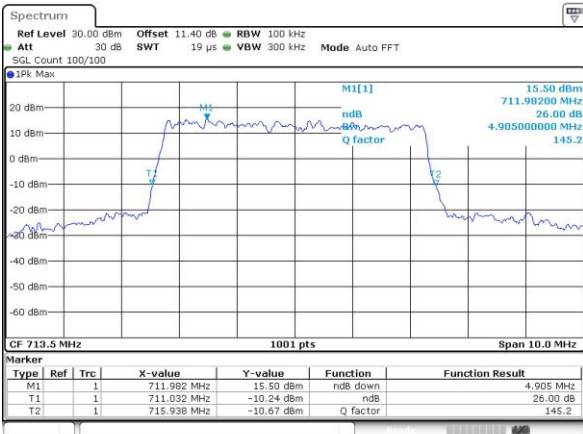

Date: 13.MAY.2016 10:49:30

Highest Channel / 5MHz / 16QAM

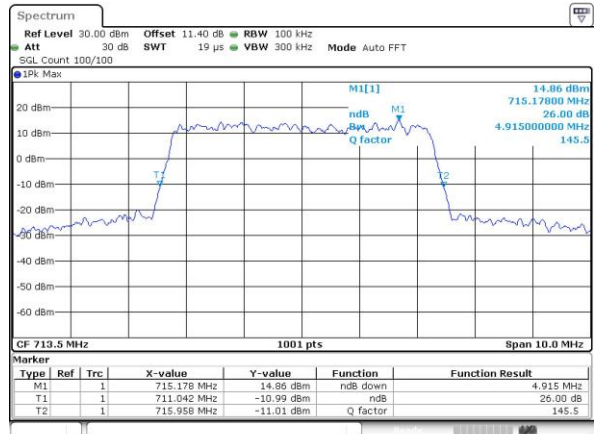

Date: 13.MAY.2016 10:49:18



LTE Band 12

Lowest Channel / 10MHz / QPSK

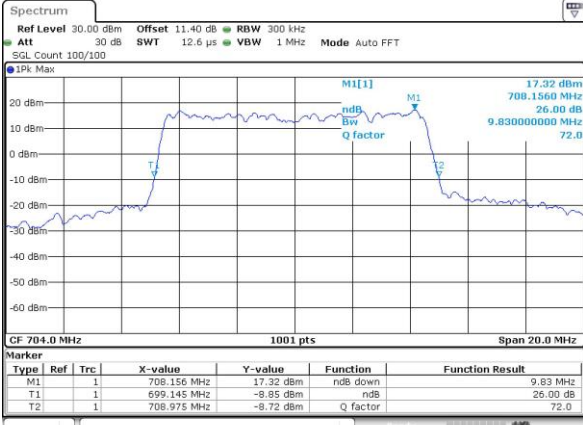

Date: 13.MAY.2016 11:00:27

Lowest Channel / 10MHz / 16QAM

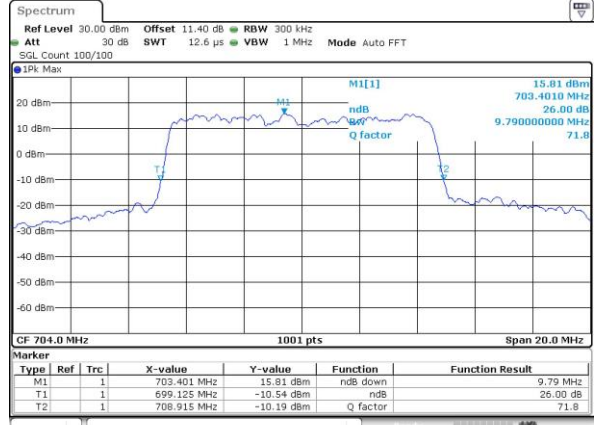

Date: 13.MAY.2016 11:00:15

Middle Channel / 10MHz / QPSK

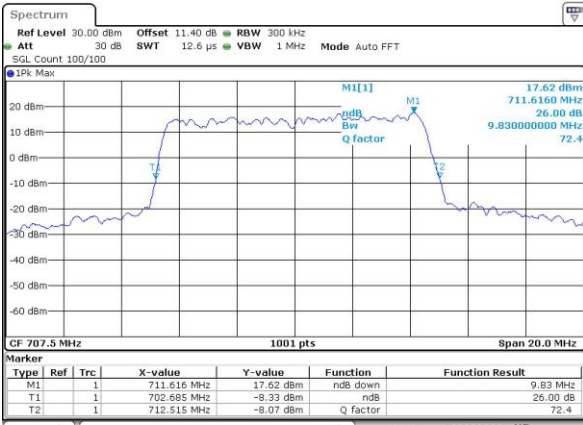

Date: 13.MAY.2016 11:11:08

Middle Channel / 10MHz / 16QAM

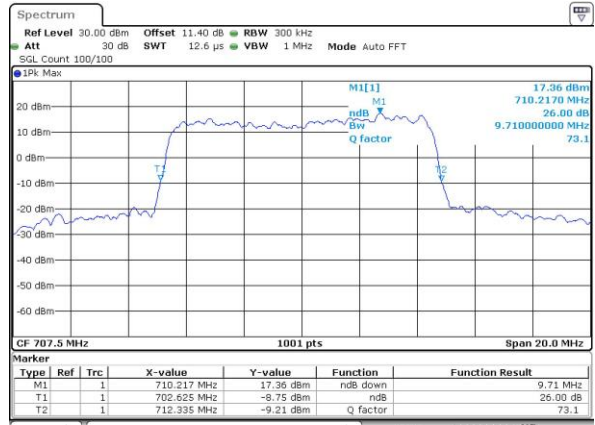

Date: 13.MAY.2016 11:11:20

Highest Channel / 10MHz / QPSK

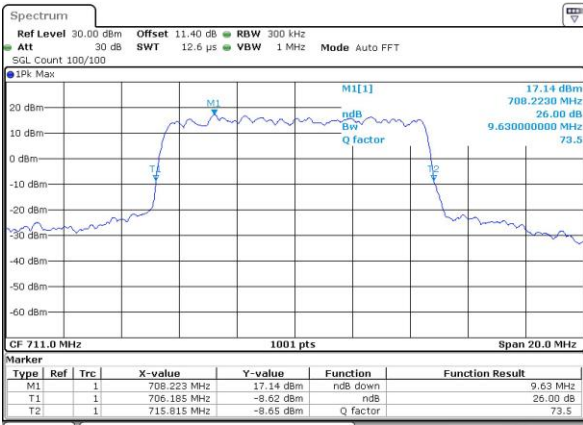

Date: 13.MAY.2016 11:14:03

Highest Channel / 10MHz / 16QAM

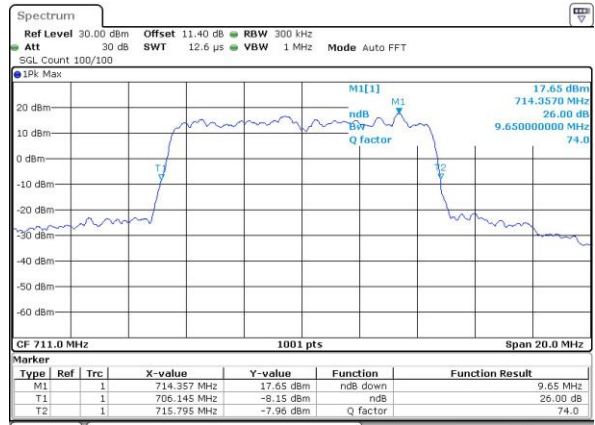

Date: 13.MAY.2016 11:13:52



Occupied Bandwidth

Mode	LTE Band 12 : 99%OBW(MHz)											
	1.4MHz		3MHz		5MHz		10MHz		15MHz		20MHz	
BW	QPSK	16QAM	QPSK	16QAM	QPSK	16QAM	QPSK	16QAM	QPSK	16QAM	QPSK	16QAM
Lowest CH	1.09	1.09	2.71	2.72	4.48	4.49	9.03	9.03	-	-	-	-
Middle CH	1.09	1.09	2.73	2.74	4.47	4.50	8.99	9.05	-	-	-	-
Highest CH	1.09	1.09	2.74	2.73	4.50	4.48	9.03	8.95	-	-	-	-



LTE Band 12

Lowest Channel / 1.4MHz / QPSK

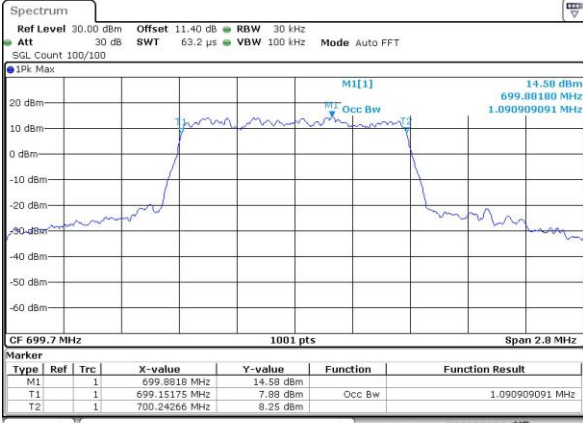

Date: 13.MAY.2016 11:24:25

Lowest Channel / 1.4MHz / 16QAM

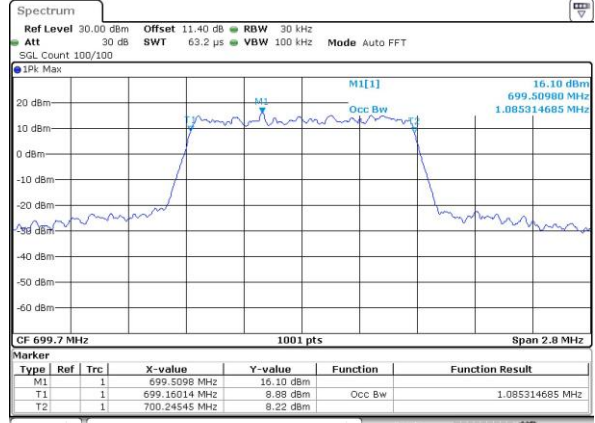

Date: 13.MAY.2016 11:24:37

Middle Channel / 1.4MHz / QPSK

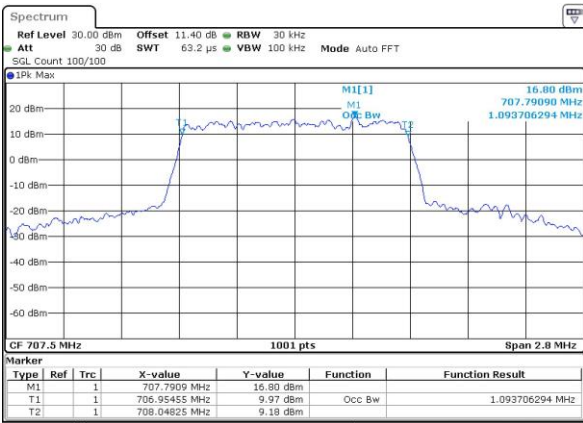

Date: 13.MAY.2016 11:35:29

Middle Channel / 1.4MHz / 16QAM

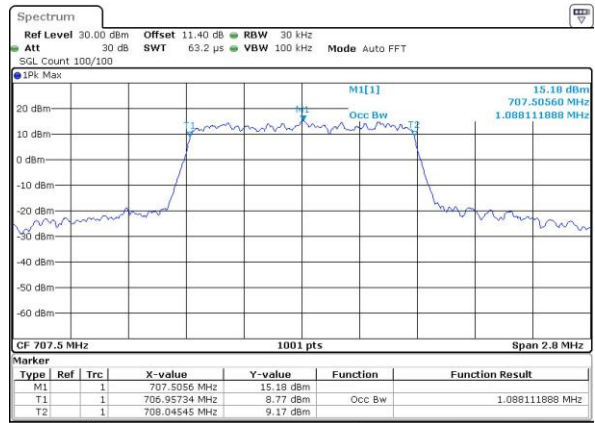

Date: 13.MAY.2016 11:35:18

Highest Channel / 1.4MHz / QPSK

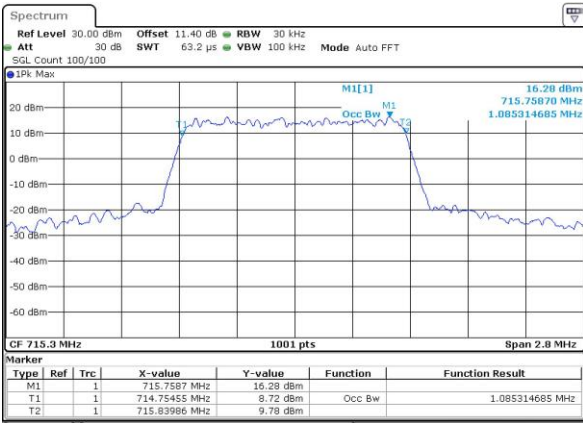

Date: 13.MAY.2016 11:38:01

Highest Channel / 1.4MHz / 16QAM

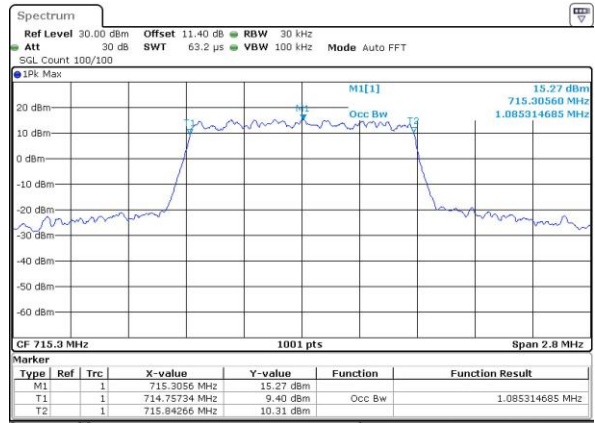

Date: 13.MAY.2016 11:38:12



LTE Band 12

Lowest Channel / 3MHz / QPSK

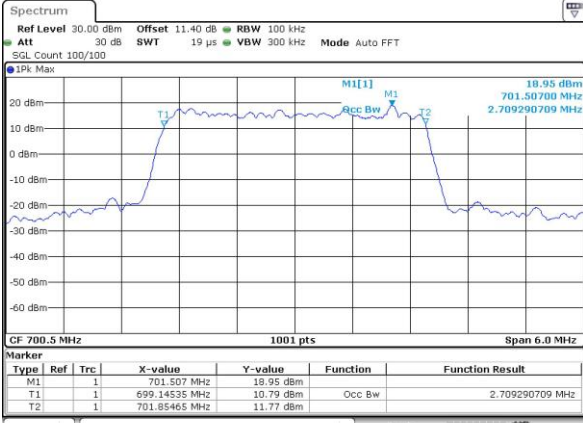

Date: 13.MAY.2016 10:08:43

Lowest Channel / 3MHz / 16QAM

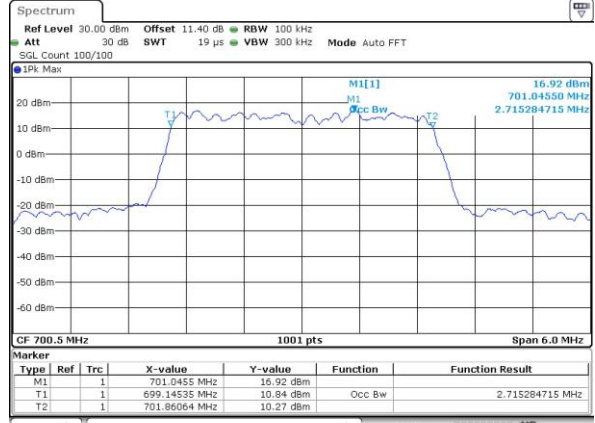

Date: 13.MAY.2016 10:08:54

Middle Channel / 3MHz / QPSK

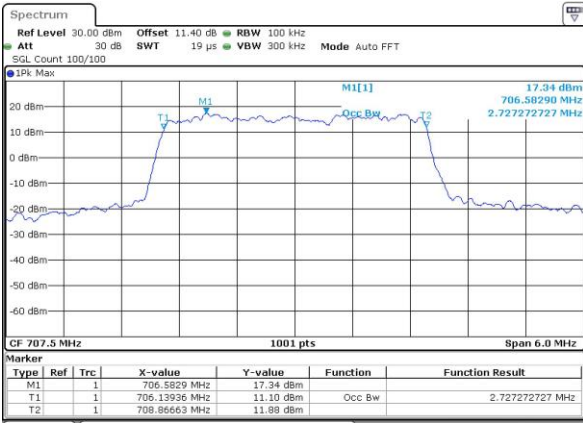

Date: 13.MAY.2016 10:19:48

Middle Channel / 3MHz / 16QAM

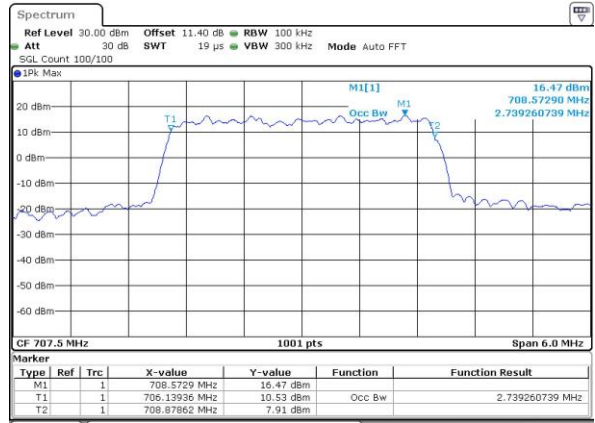

Date: 13.MAY.2016 10:19:36

Highest Channel / 3MHz / QPSK

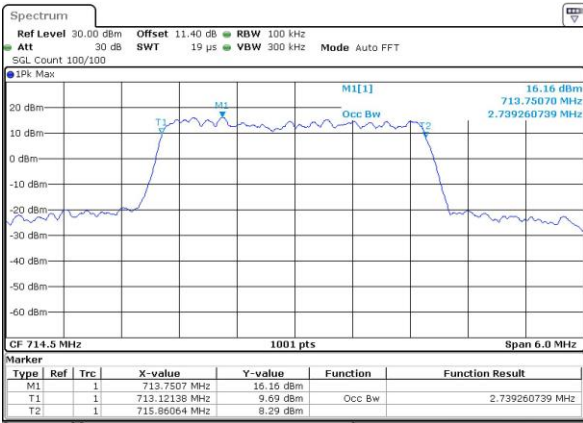

Date: 13.MAY.2016 12:03:19

Highest Channel / 3MHz / 16QAM

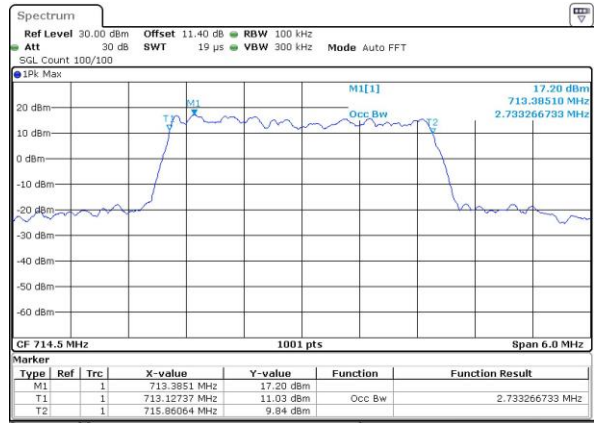

Date: 13.MAY.2016 12:04:02



LTE Band 12

Lowest Channel / 5MHz / QPSK

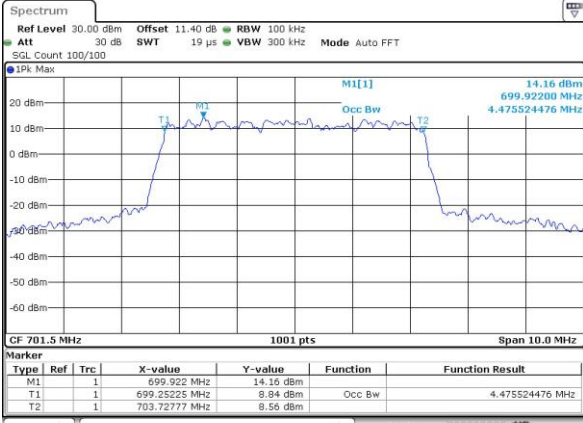

Date: 13.MAY.2016 10:35:18

Lowest Channel / 5MHz / 16QAM

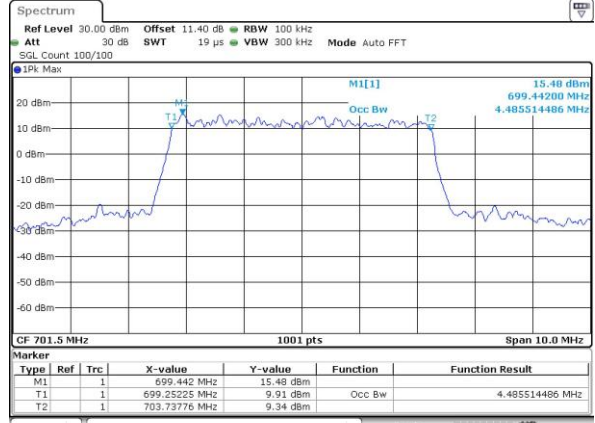

Date: 13.MAY.2016 10:35:30

Middle Channel / 5MHz / QPSK

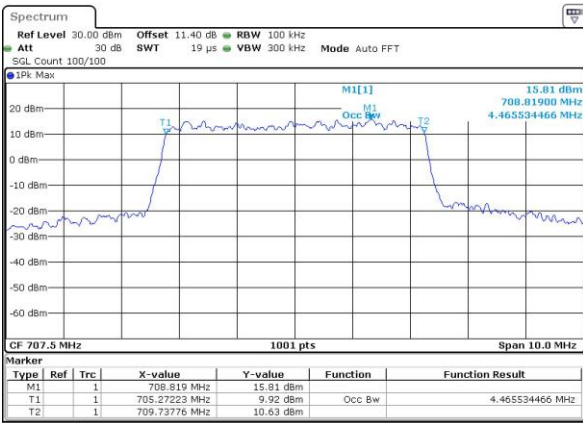

Date: 13.MAY.2016 10:46:23

Middle Channel / 5MHz / 16QAM

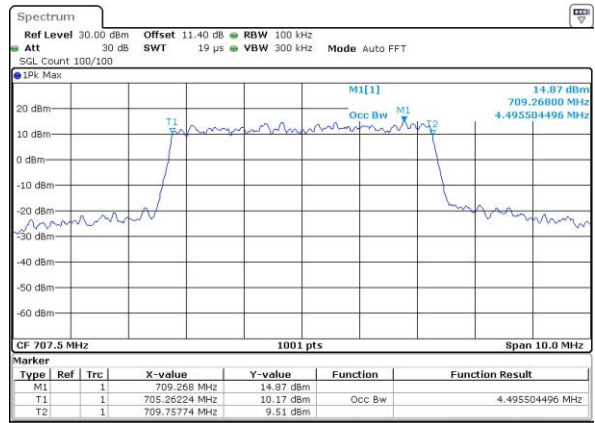

Date: 13.MAY.2016 10:46:11

Highest Channel / 5MHz / QPSK

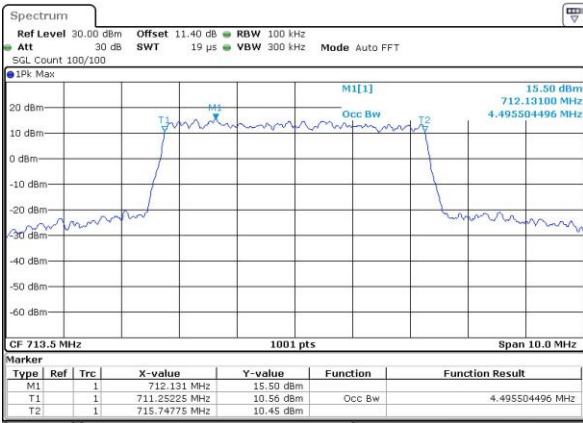

Date: 13.MAY.2016 10:48:55

Highest Channel / 5MHz / 16QAM

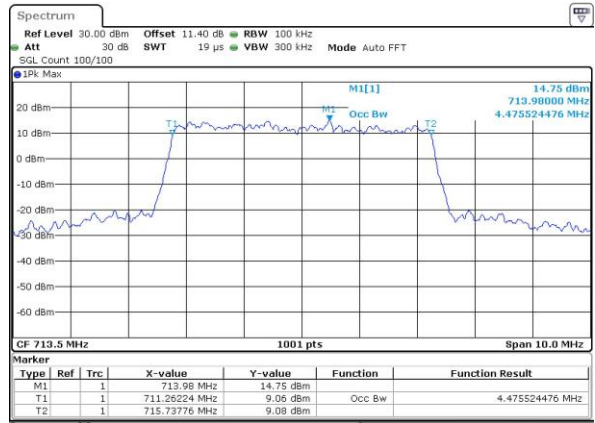

Date: 13.MAY.2016 10:49:06



LTE Band 12

Lowest Channel / 10MHz / QPSK

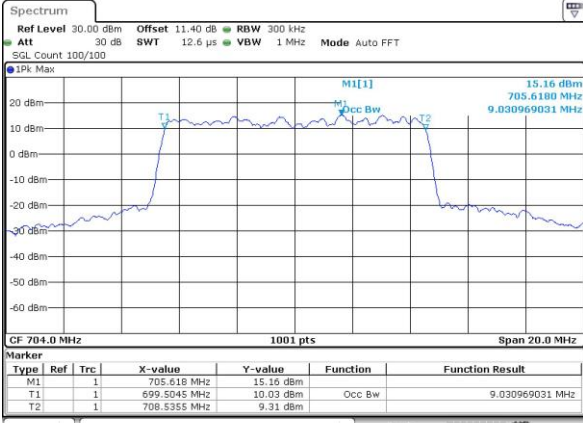

Lowest Channel / 10MHz / 16QAM

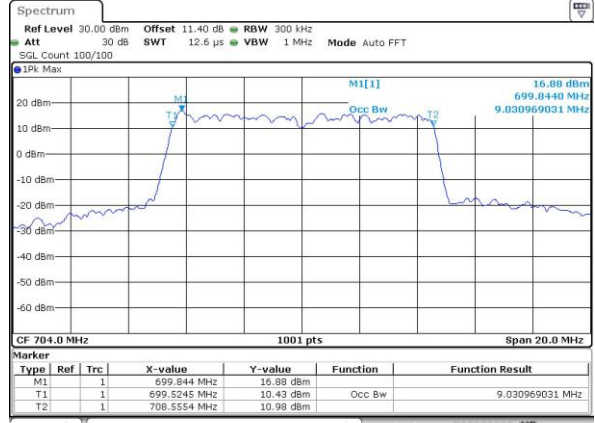

Middle Channel / 10MHz / QPSK

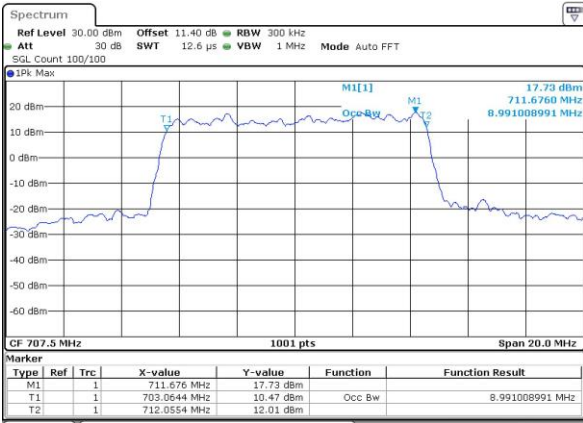

Middle Channel / 10MHz / 16QAM

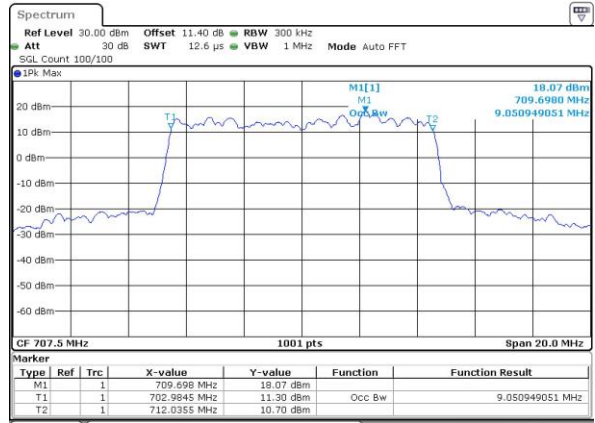

Highest Channel / 10MHz / QPSK

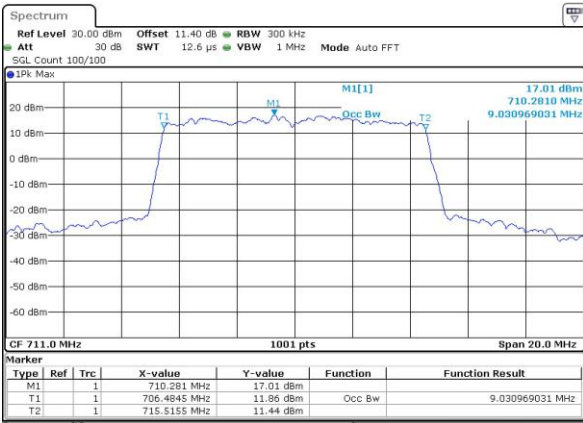

Highest Channel / 10MHz / 16QAM

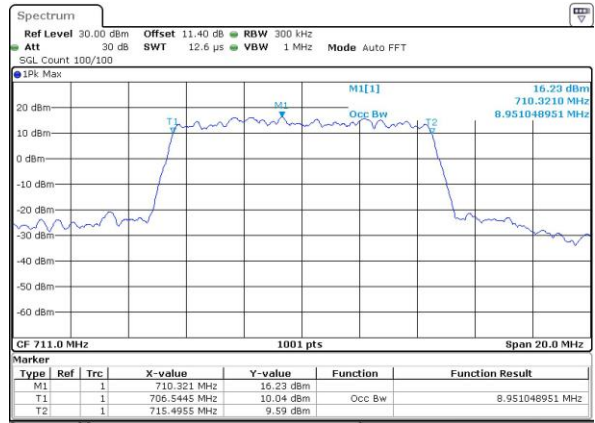



Conducted Band Edge

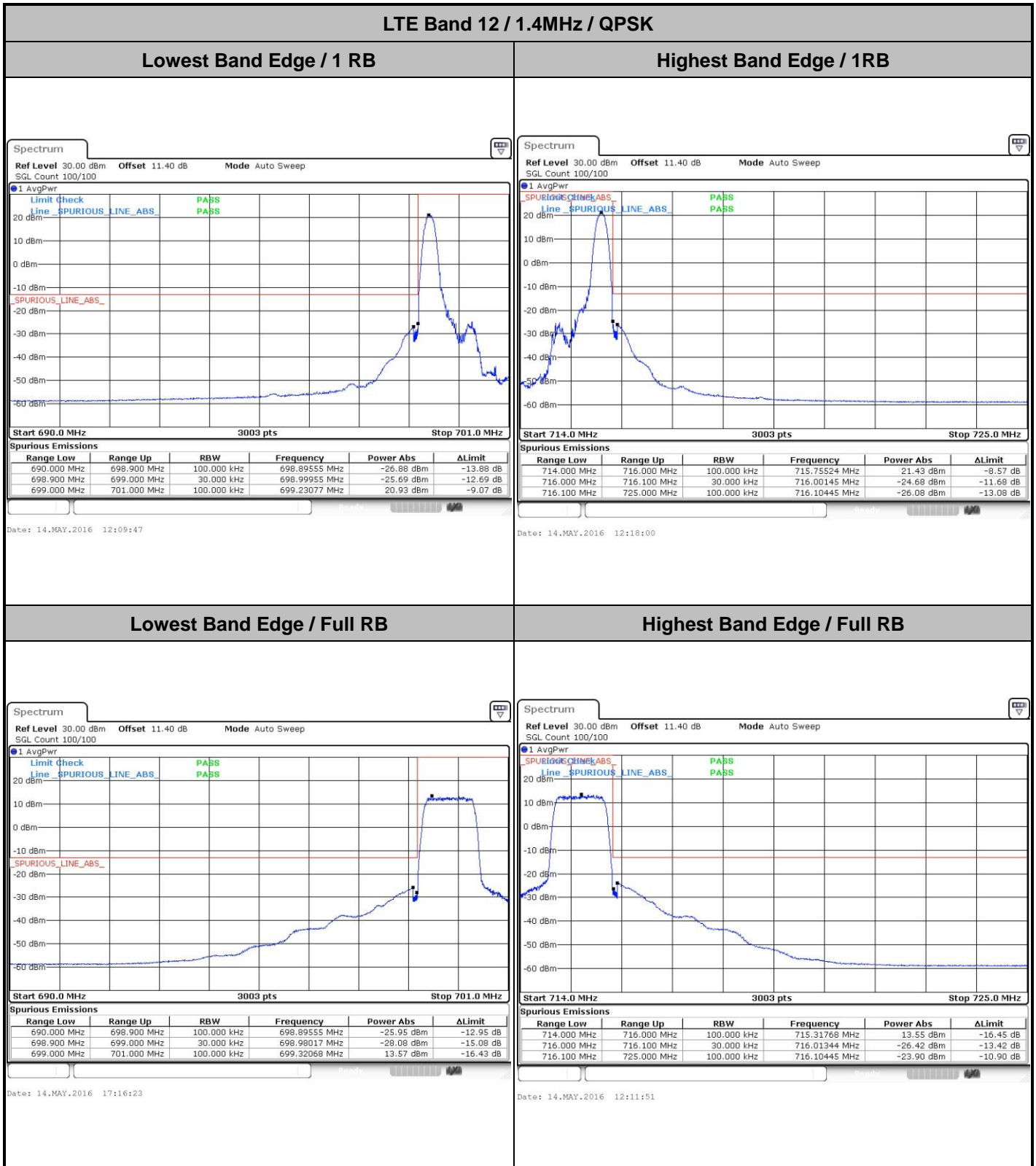



LTE Band 12 / 1.4MHz / 16QAM

Lowest Band Edge / 1 RB

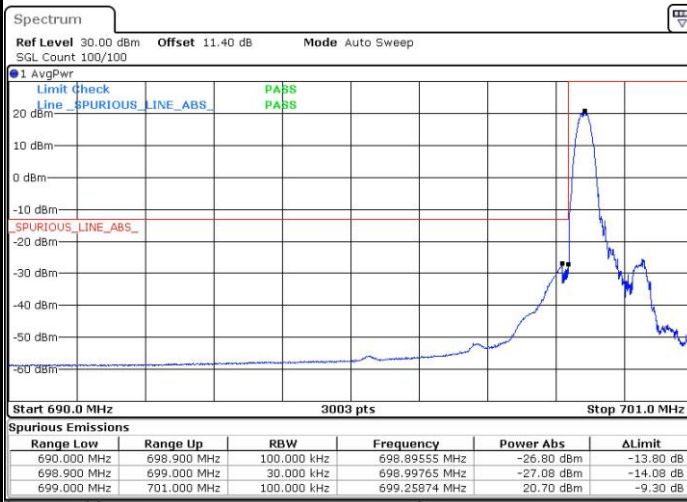

Date: 14.MAY.2016 12:07:44

Highest Band Edge / 1 RB



Date: 14.MAY.2016 12:15:57

Lowest Band Edge / Full RB

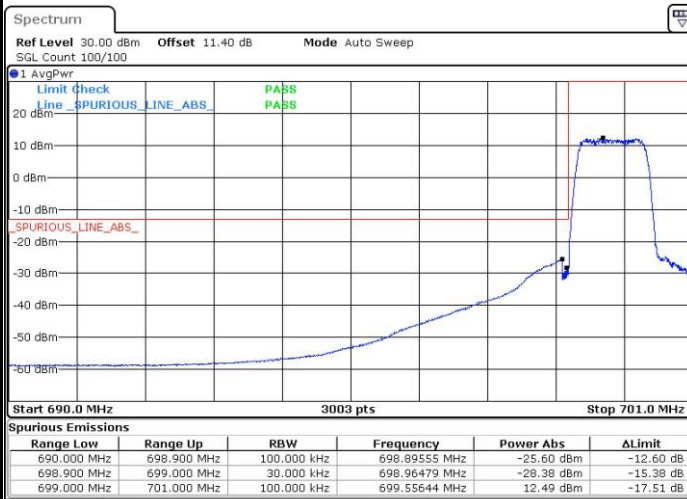

Date: 14.MAY.2016 12:05:41

Highest Band Edge / Full RB



Date: 14.MAY.2016 12:13:54