



# FCC RF Test Report

**APPLICANT** : Motorola Mobility, LLC  
**EQUIPMENT** : Mobile Cellular Phone  
**BRAND NAME** : Motorola  
**MODEL NAME** : 4237  
**FCC ID** : IHDT56VB1  
**STANDARD** : FCC Part 15 Subpart E §15.407  
**CLASSIFICATION** : (NII) Unlicensed National Information Infrastructure

The product was received on Mar. 18, 2016 and testing was completed on Apr. 25, 2016. We, SPORTON INTERNATIONAL INC., would like to declare that the tested sample has been evaluated in accordance with the test procedures and has been in compliance with the applicable technical standards.

The test results in this report apply exclusively to the tested model / sample. Without written approval of SPORTON INTERNATIONAL INC., the test report shall not be reproduced except in full.

Reviewed by: Joseph Lin / Supervisor

Approved by: Jones Tsai / Manager



## SPORTON INTERNATIONAL INC.

No. 52, Hwa Ya 1<sup>st</sup> Rd., Hwa Ya Technology Park, Kwei-Shan District, Tao Yuan City, Taiwan, R.O.C.

SPORTON INTERNATIONAL INC.

TEL : 886-3-327-3456

FAX : 886-3-328-4978

FCC ID : IHDT56VB1

Page Number : 1 of 35

Report Issued Date : May 10, 2016

Report Version : Rev. 01

Report Template No.: BU5-FR15EWLB4 AC MA Version 1.3



# TABLE OF CONTENTS

**REVISION HISTORY ..... 3**

**SUMMARY OF TEST RESULT ..... 4**

**1 GENERAL DESCRIPTION ..... 5**

    1.1 Applicant ..... 5

    1.2 Manufacturer ..... 5

    1.3 Product Feature of Equipment Under Test ..... 5

    1.4 Product Specification of Equipment Under Test ..... 6

    1.5 Modification of EUT ..... 6

    1.6 Testing Location ..... 7

    1.7 Applicable Standards ..... 8

**2 TEST CONFIGURATION OF EQUIPMENT UNDER TEST ..... 9**

    2.1 Carrier Frequency and Channel ..... 9

    2.2 Pre-Scanned RF Power ..... 10

    2.3 Test Mode ..... 13

    2.4 Connection Diagram of Test System ..... 14

    2.5 Support Unit used in test configuration and system ..... 15

    2.6 EUT Operation Test Setup ..... 15

    2.7 Measurement Results Explanation Example ..... 15

**3 TEST RESULT ..... 16**

    3.1 6dB and 26dB and 99% Occupied Bandwidth Measurement ..... 16

    3.2 Maximum Conducted Output Power Measurement ..... 19

    3.3 Power Spectral Density Measurement ..... 20

    3.4 Unwanted Emissions Measurement ..... 22

    3.5 AC Conducted Emission Measurement ..... 26

    3.6 Frequency Stability Measurement ..... 31

    3.7 Automatically Discontinue Transmission ..... 32

    3.8 Antenna Requirements ..... 33

**4 LIST OF MEASURING EQUIPMENT ..... 34**

**5 UNCERTAINTY OF EVALUATION ..... 35**

**APPENDIX A. CONDUCTED TEST RESULTS**

**APPENDIX B. RADIATED SPURIOUS EMISSION**

**APPENDIX C. RADIATED SPURIOUS EMISSION PLOTS**

**APPENDIX D. DUTY CYCLE PLOTS**





### SUMMARY OF TEST RESULT

Report Section	FCC Rule	Description	Limit	Result	Remark
3.1	15.403(i)	6dB, 26dB and 99% Occupied Bandwidth	> 500kHz	Pass	-
3.2	15.407(a)	Maximum Conducted Output Power	≤ 30 dBm	Pass	-
3.3	15.407(a)	Power Spectral Density	≤ 30 dBm/500kHz	Pass	-
3.4	15.407(b)	Unwanted Emissions	≤ -17, -27 dBm/MHz & 15.209(a)	Pass	Under limit 0.66 dB at 5703.400 MHz
3.5	15.207	AC Conducted Emission	15.207(a)	Pass	Under limit 21.80 dB at 0.726 MHz
3.6	15.407(g)	Frequency Stability	Within Operation Band	Pass	-
3.7	15.407(c)	Automatically Discontinue Transmission	Discontinue Transmission	Pass	-
3.8	15.203 & 15.407(a)	Antenna Requirement	N/A	Pass	-



# 1 General Description

## 1.1 Applicant

**Motorola Mobility, LLC**

222 W Merchandise Mart Plaza, Suite 1800, Chicago, IL 60654, United States

## 1.2 Manufacturer

**Motorola Mobility, LLC**

222 W Merchandise Mart Plaza, Suite 1800, Chicago, IL 60654, United States

## 1.3 Product Feature of Equipment Under Test

Product Feature	
<b>Equipment</b>	Mobile Cellular Phone
<b>Brand Name</b>	Motorola
<b>Model Name</b>	4237
<b>IMEI Code</b>	354107070048983 (for Radiation) 354107070048744 (for Conduction)
<b>FCC ID</b>	IHDT56VB1
<b>EUT supports Radios application</b>	CDMA/EV-DO/GSM/EGPRS/WCDMA/HSPA/LTE 2.4GHz WLAN 11b/g/n HT20 WLAN 11ac VHT20 5GHz WLAN 11a/n HT20/HT40 WLAN 11ac VHT20/VHT40/VHT80 Bluetooth v3.0 EDR Bluetooth v4.2 LE
<b>HW Version</b>	DVT2
<b>EUT Stage</b>	Identical Prototype

**Remark:** The above EUT's information was declared by manufacturer. Please refer to the specifications or user's manual for more detailed description.

Accessory List	
<b>AC Adapter</b>	Brand Name : Motorola
	Model Name : SPN5913A



### 1.4 Product Specification of Equipment Under Test

Standards-related Product Specification										
<b>Tx/Rx Channel Frequency Range</b>	5745 MHz ~ 5825 MHz									
<b>Maximum Output Power</b>	<p><b>SISO &lt;Ant. 1&gt;</b>            802.11a : 16.37 dBm / 0.0434 W            802.11n HT20 : 16.13 dBm / 0.0410 W            802.11n HT40 : 14.94 dBm / 0.0312 W            802.11ac VHT20: 16.17 dBm / 0.0414 W            802.11ac VHT40: 14.67 dBm / 0.0293 W            802.11ac VHT80: 13.93 dBm / 0.0247 W</p> <p><b>SISO &lt;Ant. 2&gt;</b>            802.11a : 16.22 dBm / 0.0419 W            802.11n HT20 : 16.02 dBm / 0.0400 W            802.11n HT40 : 14.44 dBm / 0.0278 W            802.11ac VHT20: 15.74 dBm / 0.0375 W            802.11ac VHT40: 14.43 dBm / 0.0277 W            802.11ac VHT80: 13.81 dBm / 0.0240 W</p> <p><b>MIMO &lt;Ant. 1 + 2&gt;</b>            802.11a : 18.62 dBm / 0.0728 W            802.11n HT20 : 18.39 dBm / 0.0690 W            802.11n HT40 : 16.98 dBm / 0.0499 W            802.11ac VHT20: 18.37 dBm / 0.0687 W            802.11ac VHT40: 17.09 dBm / 0.0512 W            802.11ac VHT80: 16.31 dBm / 0.0428 W</p>									
<b>99% Occupied Bandwidth</b>	802.11a : 17.50 MHz 802.11n HT20 : 18.45 MHz 802.11n HT40 : 36.40 MHz 802.11ac VHT20 : 18.95 MHz 802.11ac VHT40 : 36.40 MHz 802.11ac VHT80 : 75.72 MHz									
<b>Type of Modulation</b>	802.11a/n : OFDM (BPSK / QPSK / 16QAM / 64QAM) 802.11ac : OFDM (BPSK / QPSK / 16QAM / 64QAM / 256QAM)									
<b>Antenna Type</b>	Fixed Internal Antenna type (The antenna peak gain of EUT is less than 6 dBi)									
<b>Antenna Function Description</b>	<table border="1"> <thead> <tr> <th></th> <th>Ant.1</th> <th>Ant.2</th> </tr> </thead> <tbody> <tr> <td>802.11 a/a/n/ac SISO</td> <td>V</td> <td>V</td> </tr> <tr> <td>802.11 a/n/ac MIMO</td> <td>V</td> <td>V</td> </tr> </tbody> </table>		Ant.1	Ant.2	802.11 a/a/n/ac SISO	V	V	802.11 a/n/ac MIMO	V	V
	Ant.1	Ant.2								
802.11 a/a/n/ac SISO	V	V								
802.11 a/n/ac MIMO	V	V								

### 1.5 Modification of EUT

No modifications are made to the EUT during all test items.



### 1.6 Testing Location

Sporton Lab is accredited to ISO 17025 by Taiwan Accreditation Foundation (TAF code : 1190) and the FCC designation No. TW1022 under the FCC 2.948(e) by Mutual Recognition Agreement (MRA) in FCC Test.

<b>Test Site</b>	SPORTON INTERNATIONAL INC.	
<b>Test Site Location</b>	No. 52, Hwa Ya 1 <sup>st</sup> Rd., Hwa Ya Technology Park, Kwei-Shan District, Tao Yuan City, Taiwan, R.O.C. TEL: +886-3-327-3456 FAX: +886-3-328-4978	
<b>Test Site No.</b>	<b>Sporton Site No.</b>	
	TH02-HY	CO05-HY

**Note:** The test site complies with ANSI C63.4 2014 requirement.

<b>Test Site</b>	SPORTON INTERNATIONAL INC.	
<b>Test Site Location</b>	No.58, Aly. 75, Ln. 564, Wenhua 3rd Rd. Guishan Dist, Taoyuan City, Taiwan (R.O.C.) TEL: +886-3-327-0868 FAX: +886-3-327-0855	
<b>Test Site No.</b>	<b>Sporton Site No.</b>	
	03CH11-HY	

**Note:** The test site complies with ANSI C63.4 2014 requirement.



## 1.7 Applicable Standards

According to the specifications of the manufacturer, the EUT must comply with the requirements of the following standards:

- ♦ FCC Part 15 Subpart E
- ♦ FCC KDB 789033 D02 General UNII Test Procedures New Rules v01r02
- ♦ FCC KDB 662911 D01 Multiple Transmitter Output v02r01.
- ♦ FCC KDB 644545 D03 Guidance for IEEE 802.11ac New Rules v01.
- ♦ ANSI C63.10-2013

**Remark:**

1. All test items were verified and recorded according to the standards and without any deviation during the test.
2. This EUT has also been tested and complied with the requirements of FCC Part 15, Subpart B, recorded in a separate test report.



## 2 Test Configuration of Equipment Under Test

The EUT has been associated with peripherals and configuration operated in a manner tended to maximize its emission characteristics in a typical application. Frequency range investigated: conducted emission (150 kHz to 30 MHz) and radiated emission (9 kHz to the 10th harmonic of the highest fundamental frequency or to 40 GHz, whichever is lower). For radiated measurement, pre-scanned in three orthogonal panels, X, Y, Z. The worst cases (X plane) were recorded in this report.

The final configuration from all the combinations and the worst-case data rates were investigated by measuring the maximum power across all the data rates and modulation modes under section 2.2.

Based on the worst configuration found above, the RF power setting is set individually to meet FCC compliance limit for the final conducted and radiated tests shown in section 2.3.

### 2.1 Carrier Frequency and Channel

Frequency Band	Channel	Freq. (MHz)	Channel	Freq. (MHz)
5725-5850 MHz Band 4 (U-NII-3)	149	5745	157	5785
	<b>151</b>	<b>5755</b>	<b>159</b>	<b>5795</b>
	153	5765	161	5805
	155	5775	165	5825

**Note:** The above Frequency and Channel in boldface were 802.11n HT40.



## 2.2 Pre-Scanned RF Power

Preliminary tests were performed in different data rate and data rate associated with the highest power were chosen for full test in the following tables.

### SISO <Ant. Port 1>

Channel	Frequency	5GHz 802.11a Average Power (dBm)							
		Data Rate							
		6 Mbps	9 Mbps	12 Mbps	18 Mbps	24 Mbps	36 Mbps	48 Mbps	54 Mbps
CH 149	5745 MHz	16.37	16.35	16.33	16.34	16.16	15.06	14.96	13.59
CH 157	5785 MHz	15.85	15.81	15.82	15.79	15.65	14.50	14.31	13.17
CH 165	5825 MHz	15.96	15.91	15.93	15.94	15.87	14.81	14.41	13.20

Channel	Frequency	5GHz 802.11n HT20 Average Power (dBm)							
		Data Rate							
		MCS0	MCS1	MCS2	MCS3	MCS4	MCS5	MCS6	MCS7
CH 149	5745 MHz	16.13	16.11	16.08	15.56	15.67	14.79	13.68	12.76
CH 157	5785 MHz	15.90	15.71	15.88	15.24	15.07	14.35	13.22	12.36
CH 165	5825 MHz	15.72	15.70	15.69	15.11	15.18	14.40	13.11	12.20

Channel	Frequency	5GHz 802.11n HT40 Average Power (dBm)							
		Data Rate							
		MCS0	MCS1	MCS2	MCS3	MCS4	MCS5	MCS6	MCS7
CH 151	5755 MHz	14.94	14.86	14.80	13.96	14.01	14.05	13.65	12.81
CH 159	5795 MHz	14.45	14.40	14.43	13.44	13.53	13.65	13.32	12.49

Channel	Frequency	5GHz 802.11ac VHT20 Average Power (dBm)								
		Data Rate								
		MCS0	MCS1	MCS2	MCS3	MCS4	MCS5	MCS6	MCS7	MCS8
CH 149	5745 MHz	16.17	16.15	16.13	15.47	15.67	14.78	13.72	13.04	10.26
CH 157	5785 MHz	15.81	15.78	15.79	15.07	15.04	14.39	13.29	12.41	9.67
CH 165	5825 MHz	15.78	15.72	15.76	15.15	15.15	14.54	13.15	12.35	9.20

Channel	Frequency	5GHz 802.11ac VHT40 Average Power (dBm)									
		Data Rate									
		MCS0	MCS1	MCS2	MCS3	MCS4	MCS5	MCS6	MCS7	MCS8	MCS9
CH 151	5755 MHz	14.67	14.65	14.64	13.90	13.98	13.83	13.49	12.84	10.00	9.53
CH 159	5795 MHz	14.57	14.47	14.12	13.48	13.68	13.59	13.25	12.40	9.48	9.11

Channel	Frequency	5GHz 802.11ac VHT80 Average Power (dBm)									
		Data Rate									
		MCS0	MCS1	MCS2	MCS3	MCS4	MCS5	MCS6	MCS7	MCS8	MCS9
CH 155	5775 MHz	13.93	13.90	13.88	13.91	13.92	13.65	12.77	11.96	9.64	7.41



SISO <Ant. Port 2>

Channel	Frequency	5GHz 802.11a Average Power (dBm)							
		Data Rate							
		6 Mbps	9 Mbps	12 Mbps	18 Mbps	24 Mbps	36 Mbps	48 Mbps	54 Mbps
CH 149	5745 MHz	16.22	16.16	16.20	16.21	15.98	14.95	14.67	13.51
CH 157	5785 MHz	15.81	15.74	15.78	15.78	15.68	14.75	14.22	12.84
CH 165	5825 MHz	15.89	15.85	15.77	15.84	15.47	14.43	13.97	12.63

Channel	Frequency	5GHz 802.11n HT20 Average Power (dBm)							
		Data Rate							
		MCS0	MCS1	MCS2	MCS3	MCS4	MCS5	MCS6	MCS7
CH 149	5745 MHz	16.02	15.97	16.01	15.23	15.32	14.69	13.77	12.58
CH 157	5785 MHz	15.88	15.78	15.82	15.02	15.07	14.26	13.10	13.04
CH 165	5825 MHz	15.55	15.46	15.49	14.73	14.85	14.05	12.69	11.68

Channel	Frequency	5GHz 802.11n HT40 Average Power (dBm)							
		Data Rate							
		MCS0	MCS1	MCS2	MCS3	MCS4	MCS5	MCS6	MCS7
CH 151	5755 MHz	14.44	14.36	14.43	13.66	13.58	13.80	13.71	12.74
CH 159	5795 MHz	14.08	14.01	14.03	13.47	13.30	13.50	13.26	12.15

Channel	Frequency	5GHz 802.11ac VHT20 Average Power (dBm)								
		Data Rate								
		MCS0	MCS1	MCS2	MCS3	MCS4	MCS5	MCS6	MCS7	MCS8
CH 149	5745 MHz	15.63	15.60	15.57	14.94	15.06	14.25	13.14	12.30	9.27
CH 157	5785 MHz	15.74	15.70	15.73	14.92	14.92	14.17	12.89	12.06	9.71
CH 165	5825 MHz	15.55	15.52	15.53	14.90	14.81	13.89	12.46	11.61	9.18

Channel	Frequency	5GHz 802.11ac VHT40 Average Power (dBm)									
		Data Rate									
		MCS0	MCS1	MCS2	MCS3	MCS4	MCS5	MCS6	MCS7	MCS8	MCS9
CH 151	5755 MHz	14.43	14.38	14.23	13.31	13.73	13.69	13.05	12.08	9.02	8.62
CH 159	5795 MHz	14.12	14.10	14.11	13.22	13.34	13.43	13.12	12.04	8.89	8.58

Channel	Frequency	5GHz 802.11ac VHT80 Average Power (dBm)									
		Data Rate									
		MCS0	MCS1	MCS2	MCS3	MCS4	MCS5	MCS6	MCS7	MCS8	MCS9
CH 155	5775 MHz	13.81	13.75	13.78	13.76	13.77	13.36	12.35	11.40	9.15	7.32



MIMO <Ant. 1+2>

Channel	Frequency	5GHz 802.11a Average Power (dBm)							
		Data Rate							
		6 Mbps	9 Mbps	12 Mbps	18 Mbps	24 Mbps	36 Mbps	48 Mbps	54 Mbps
CH 149	5745 MHz	18.62	18.58	18.52	18.59	18.33	17.65	17.31	16.41
CH 157	5785 MHz	18.03	18.00	17.95	18.01	17.83	17.09	16.79	15.79
CH 165	5825 MHz	17.88	17.82	17.86	17.85	17.67	16.65	16.53	15.55

Channel	Frequency	5GHz 802.11n HT20 Average Power (dBm)							
		Data Rate							
		MCS0	MCS1	MCS2	MCS3	MCS4	MCS5	MCS6	MCS7
CH 149	5745 MHz	18.39	18.34	18.13	17.81	17.84	17.16	16.49	15.55
CH 157	5785 MHz	18.02	17.98	17.94	17.32	17.30	16.76	15.84	14.95
CH 165	5825 MHz	17.92	17.89	17.91	17.24	17.36	16.46	15.77	14.66

Channel	Frequency	5GHz 802.11n HT40 Average Power (dBm)							
		Data Rate							
		MCS0	MCS1	MCS2	MCS3	MCS4	MCS5	MCS6	MCS7
CH 151	5755 MHz	16.98	16.94	16.95	16.13	16.33	16.51	16.43	15.57
CH 159	5795 MHz	16.66	16.61	16.63	15.84	16.03	16.16	15.96	15.19

Channel	Frequency	5GHz 802.11ac VHT20 Average Power (dBm)								
		Data Rate								
		MCS0	MCS1	MCS2	MCS3	MCS4	MCS5	MCS6	MCS7	MCS8
CH 149	5745 MHz	18.37	18.35	18.33	17.46	17.69	17.09	16.36	15.56	13.08
CH 157	5785 MHz	18.08	18.03	18.07	17.27	17.45	16.96	16.16	15.36	13.06
CH 165	5825 MHz	17.95	17.89	17.93	17.08	17.31	16.78	16.00	15.28	12.94

Channel	Frequency	5GHz 802.11ac VHT40 Average Power (dBm)									
		Data Rate									
		MCS0	MCS1	MCS2	MCS3	MCS4	MCS5	MCS6	MCS7	MCS8	MCS9
CH 151	5755 MHz	17.09	17.03	17.02	16.18	16.25	16.44	16.54	15.58	13.22	12.44
CH 159	5795 MHz	16.60	16.49	16.55	15.84	16.05	16.17	16.01	15.07	12.58	11.96

Channel	Frequency	5GHz 802.11ac VHT80 Average Power (dBm)									
		Data Rate									
		MCS0	MCS1	MCS2	MCS3	MCS4	MCS5	MCS6	MCS7	MCS8	MCS9
CH 155	5775 MHz	16.31	16.26	16.30	15.95	16.27	16.29	15.45	14.81	12.21	10.32

Note: MIMO Ant. 1+2 is a calculated result from sum of the power MIMO Ant. 1 and MIMO Ant. 2.



### 2.3 Test Mode

Final test mode of conducted test items and radiated spurious emissions are considering the modulation and worse data rates from the power table described in section 2.2.

Modulation	Data Rate
802.11a	6 Mbps
802.11n HT20	MCS0
802.11n HT40	MCS0
802.11ac VHT20	MCS0
802.11ac VHT40	MCS0
802.11ac VHT80	MCS0

AC Conducted Emission	Mode 1 : GSM850 Idle + Bluetooth Link + WLAN (5GHz) Link + Adapter + MP3
-----------------------	--

Ch. #		Band IV : 5725-5850 MHz		
		802.11a	802.11n HT20	802.11n HT40
L	Low	149	149	151
M	Middle	157	157	-
H	High	165	165	159

Ch. #		Band IV : 5725-5850 MHz		
		802.11ac VHT20	802.11ac VHT40	802.11ac VHT80
L	Low	149	151	-
M	Middle	157	-	155
H	High	165	159	-

## 2.4 Connection Diagram of Test System

<WLAN Tx Mode>

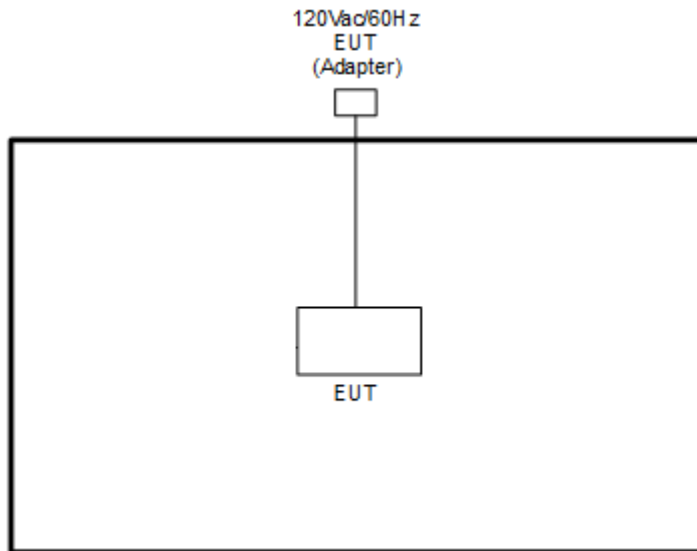

<AC Conducted Emission Mode>

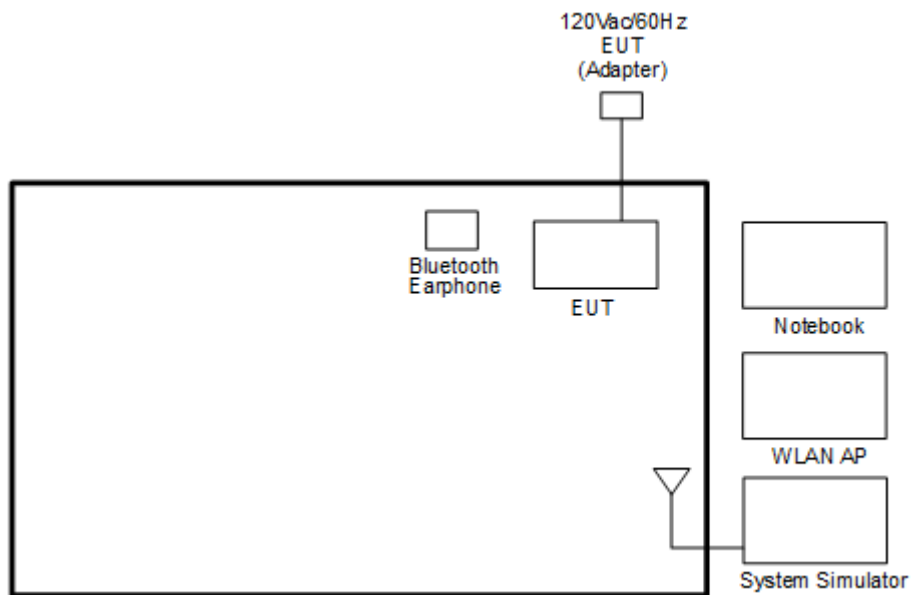



## 2.5 Support Unit used in test configuration and system

Item	Equipment	Trade Name	Model Name	FCC ID	Data Cable	Power Cord
1.	System Simulator	Anritsu	MT8820C	N/A	N/A	Unshielded, 1.8 m
2.	Bluetooth Earphone	Sony Ericsson	MW600	PY7DDA-2029	N/A	N/A
3.	Notebook	DELL	Latitude E6320	FCC DoC/ Contains FCC ID: QDS-BRCM1054	N/A	AC I/P: Unshielded, 1.2 m DC O/P: Shielded, 1.8 m
4.	SD Card	SanDisk	MicroSD HC	FCC DoC	N/A	N/A

## 2.6 EUT Operation Test Setup

For WLAN function, programmed RF utility, "QRCT" installed in the notebook make the EUT provide functions like channel selection and power level for continuous transmitting and receiving signals.

## 2.7 Measurement Results Explanation Example

For all conducted test items:

The offset level is set in the spectrum analyzer to compensate the RF cable loss and attenuator factor between EUT conducted output port and spectrum analyzer. With the offset compensation, the spectrum analyzer reading level is exactly the EUT RF output level.

Example :

The spectrum analyzer offset is derived from RF cable loss and attenuator factor.

*Offset = RF cable loss + attenuator factor.*

Following shows an offset computation example with cable loss 4.2 dB and 10dB attenuator.

$$\begin{aligned} \text{Offset(dB)} &= \text{RF cable loss(dB)} + \text{attenuator factor(dB)}. \\ &= 4.2 + 10 = 14.2 \text{ (dB)} \end{aligned}$$

### 3 Test Result

#### 3.1 6dB and 26dB and 99% Occupied Bandwidth Measurement

##### 3.1.1 Description of 6dB and 26dB and 99% Occupied Bandwidth

The minimum 6 dB bandwidth shall be at least 500 kHz.

26dB and 99% Occupied bandwidth are reporting only.

##### 3.1.2 Measuring Instruments

The measuring equipment is listed in the section 4 of this test report.

##### 3.1.3 Test Procedures

1. The testing follows FCC KDB 789033 D02 General UNII Test Procedures New Rules v01r02.  
Section C) Emission bandwidth for the band 5.725-5.85GHz
2. Set RBW = 100kHz.
3. Set the VBW  $\geq 3 \times$  RBW.
4. Detector = Peak.
5. Trace mode = max hold
6. Measure the maximum width of the emission that is 6 dB down from the peak of the emission.
7. Measure and record the results in the test report.

##### 3.1.4 Test Setup

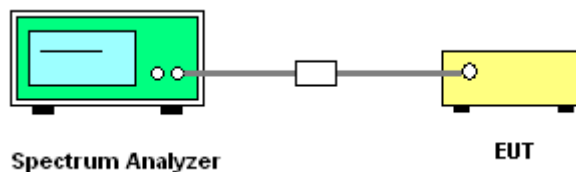



### 3.1.5 Test Result of 6dB Bandwidth

Please refer to Appendix A.

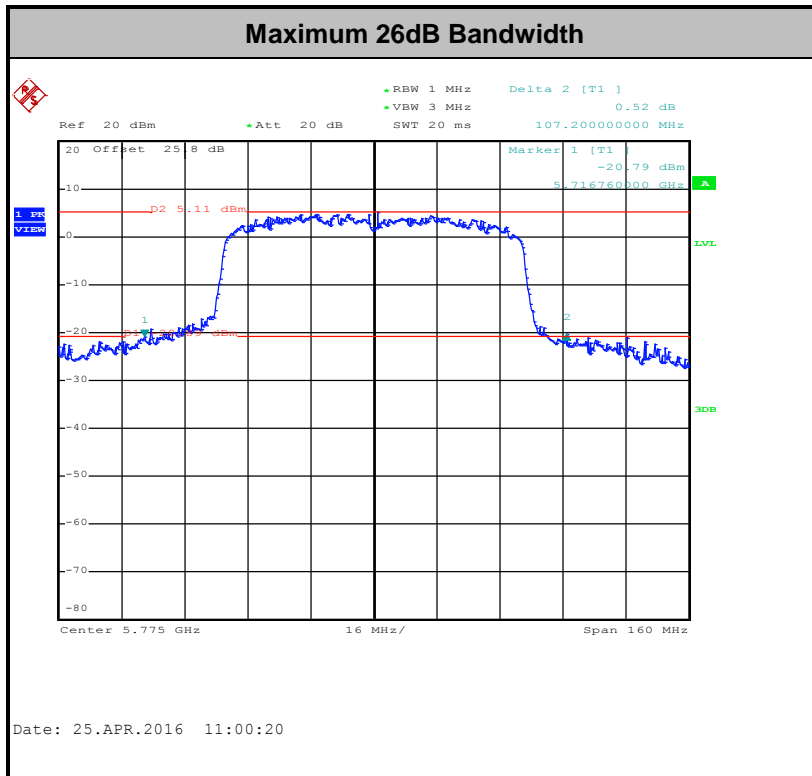
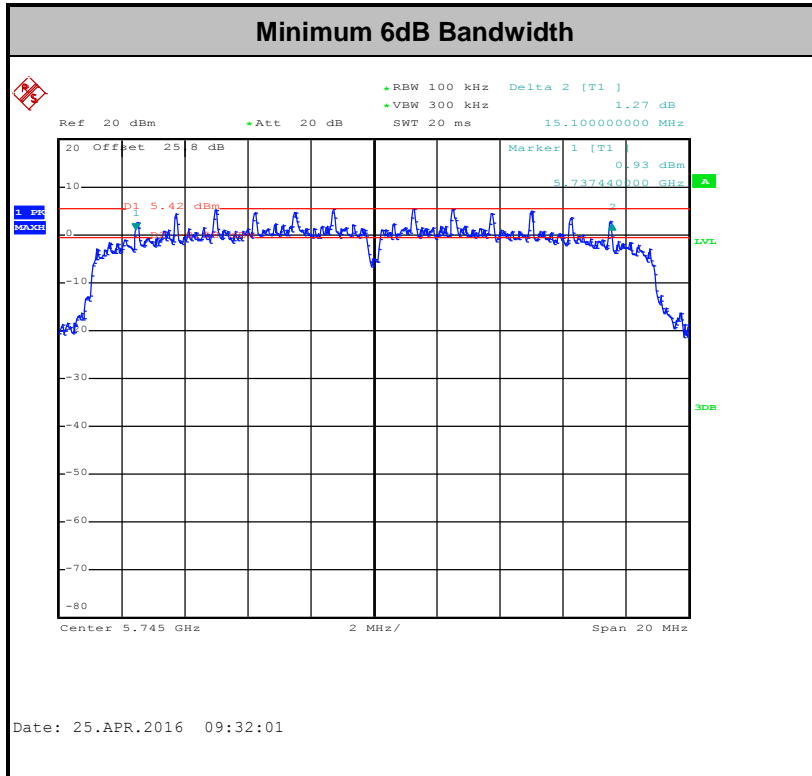

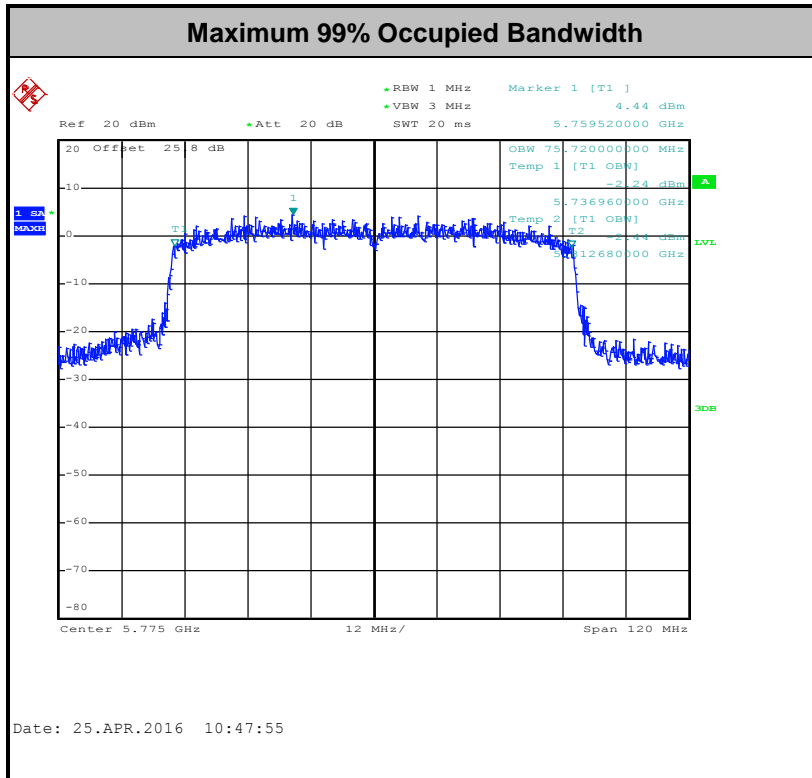

**Note:** The occupied channel bandwidth is maintained within the band of operation for all of the modulations.

## 3.2 Maximum Conducted Output Power Measurement

### 3.2.1 Limit of Maximum Conducted Output Power

For the band 5.725–5.85 GHz, the maximum conducted output power over the frequency band of operation shall not exceed 1 W.

If transmitting antennas of directional gain greater than 6 dBi are used, the peak output power shall be reduced by the amount in dB that the directional gain of the antenna exceeds 6 dBi.

### 3.2.2 Measuring Instruments

The measuring equipment is listed in the section 4 of this test report.

### 3.2.3 Test Procedures

The testing follows Method PM of FCC KDB 789033 D02 General UNII Test Procedures New Rules v01r02.

Method PM (Measurement using an RF average power meter):

1. Measurement is performed using a wideband RF power meter.
2. The EUT is configured to transmit continuously with a consistent duty cycle at its maximum power control level.
3. Measure the average power of the transmitter, and the average power is corrected with duty factor,  $10 \log(1/x)$ , where  $x$  is the duty cycle.

### 3.2.4 Test Setup

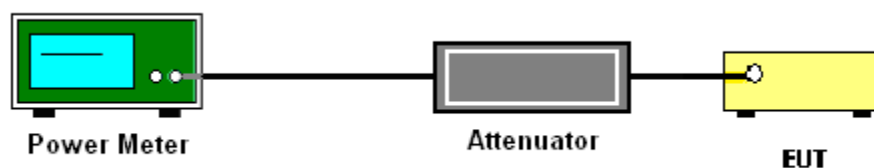

### 3.2.5 Test Result of Maximum Conducted Output Power

Please refer to Appendix A.



### 3.3 Power Spectral Density Measurement

#### 3.3.1 Limit of Power Spectral Density

For the band 5.725–5.85 GHz, the maximum power spectral density shall not exceed 30 dBm in any 500-kHz band.

If transmitting antennas of directional gain greater than 6 dBi are used, the peak output power shall be reduced by the amount in dB that the directional gain of the antenna exceeds 6 dBi.

#### 3.3.2 Measuring Instruments

The measuring equipment is listed in the section 4 of this test report.

#### 3.3.3 Test Procedures

The testing follows FCC KDB 789033 D02 General UNII Test Procedures New Rules v01r02. Section F) Maximum power spectral density.

##### # Method SA-2 #

(trace averaging across on and off times of the EUT transmissions, followed by duty cycle correction).

1. The testing follows Method SA-2 of FCC KDB 789033 D02 General UNII Test Procedures New Rules v01r02.
  - Measure the duty cycle.
  - Set span to encompass the entire emission bandwidth (EBW) of the signal.
  - Set RBW = 300 kHz.
  - Set VBW  $\geq$  1 MHz.
  - Number of points in sweep  $\geq$  2 Span / RBW.
  - Sweep time = auto.
  - Detector = RMS
  - Trace average at least 100 traces in power averaging mode.
  - Add  $10 \log(500\text{kHz}/\text{RBW})$  to the test result.
  - Add  $10 \log(1/x)$ , where x is the duty cycle, to the measured power in order to compute the average power during the actual transmission times. For example, add  $10 \log(1/0.25) = 6$  dB if the duty cycle is 25 percent.

2. The RF output of EUT was connected to the spectrum analyzer by a low loss cable.
3. Each plot has already offset with cable loss, and attenuator loss. Measure the PPSD and record it.
4. For MIMO mode, calculation method follows FCC KDB 662911 D01 Multiple Transmitter Output v02r01.

Method (a): Measure and sum the spectra across the outputs.

The total final Power Spectral Density is from a device with 2 transmitter outputs. The spectrum measurements of the individual outputs are all performed with the same span and number of points, the spectrum value in the first spectral bin of output 1 is summed with that in the first spectral bin of output 2 to obtain the value for the first frequency bin of the summed spectrum.

### 3.3.4 Test Setup

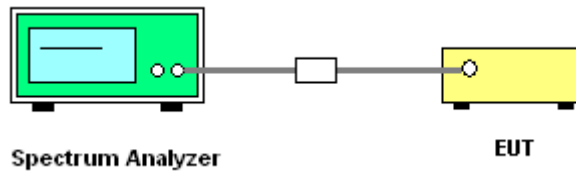

### 3.3.5 Test Result of Power Spectral Density

Please refer to Appendix A.

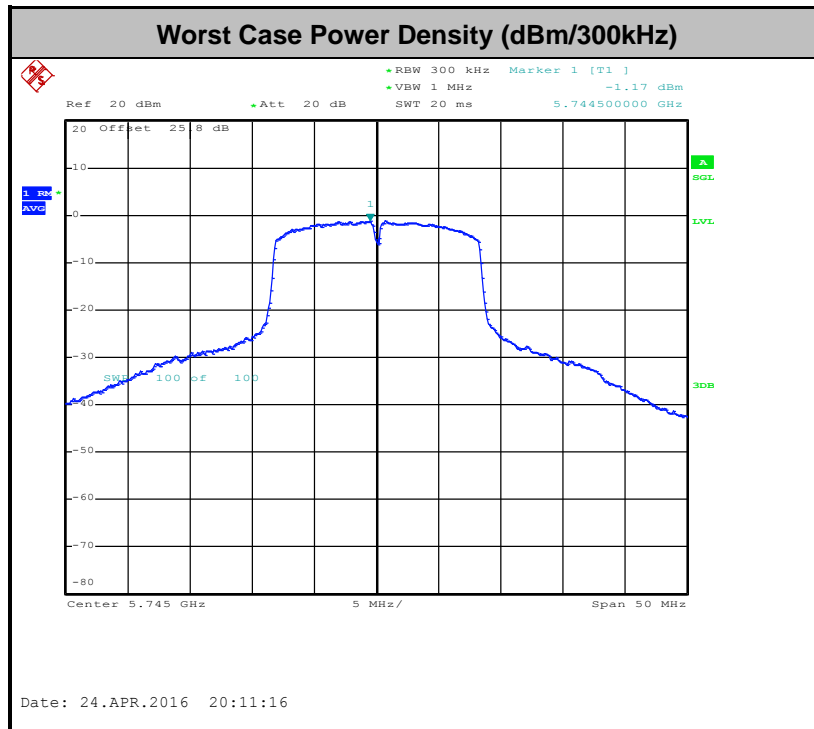



### 3.4 Unwanted Emissions Measurement

This section as specified in FCC Part 15.407(b) is to measure unwanted emissions through radiated measurement for band edge spurious emissions and out of band emissions measurement. The unwanted emissions shall comply with 15.407(b)(1) to (6), and restricted bands per FCC Part15.205.

#### 3.4.1 Limit of Unwanted Emissions

- (1) For transmitters operating in the 5725-5850 MHz band: all emissions within the frequency range from the band edge to 10 MHz above or below the band edge shall not exceed an EIRP of -17 dBm/MHz (78.3dBμV/m); for frequencies 10 MHz or greater above or below the band edge, emissions shall not exceed an EIRP of -27 dBm/MHz (68.3dBμV/m).
- (2) Unwanted spurious emissions fallen in restricted bands per FCC Part15.205 shall comply with the general field strength limits set forth in § 15.209 as below table,

Frequency (MHz)	Field Strength (microvolts/meter)	Measurement Distance (meters)
0.009 – 0.490	2400/F(kHz)	300
0.490 – 1.705	24000/F(kHz)	30
1.705 – 30.0	30	30
30 – 88	100	3
88 – 216	150	3
216 - 960	200	3
Above 960	500	3

**Note:** The following formula is used to convert the EIRP to field strength.

$$E = \frac{1000000\sqrt{30P}}{3} \mu\text{V/m, where P is the eirp (Watts)}$$

EIRP (dBm)	Field Strength at 3m (dBμV/m)
-17	78.3
- 27	68.3

- (3) KDB 789033 D02 General UNII Test Procedures New Rules v01r02 G)2)c) As specified in 15.407(b), emissions above 1000 MHz that are outside of the restricted bands are subject to a peak emission limit of -27 dBm/MHz (or -17 dBm/MHz as specified in 15.407(b)(4)). However, an out-of-band emission that complies with both the average and peak limits of 15.209 is not required to satisfy the -27 dBm/MHz or -17 dBm/MHz peak emission limit.



### 3.4.2 Measuring Instruments

The measuring equipment is listed in the section 4 of this test report.

### 3.4.3 Test Procedures

1. The testing follows FCC KDB 789033 D02 General UNII Test Procedures New Rules v01r02. Section G) Unwanted emissions measurement.
  - (1) Procedure for Unwanted Emissions Measurements Below 1000MHz
    - RBW = 120 kHz
    - VBW = 300 kHz
    - Detector = Peak
    - Trace mode = max hold
  - (2) Procedure for Peak Unwanted Emissions Measurements Above 1000 MHz
    - RBW = 1 MHz
    - VBW  $\geq$  3 MHz
    - Detector = Peak
    - Sweep time = auto
    - Trace mode = max hold
  - (3) Procedures for Average Unwanted Emissions Measurements Above 1000MHz
    - RBW = 1 MHz
    - VBW = 10 Hz, when duty cycle is no less than 98 percent.
    - VBW  $\geq$  1/T, when duty cycle is less than 98 percent where T is the minimum transmission duration over which the transmitter is on and is transmitting at its maximum power control level for the tested mode of operation.
2. The EUT was placed on a turntable with 0.8 meter for frequency below 1GHz and 1.5 meter for frequency above 1GHz respectively above ground.
3. The EUT was set 3 meters from the interference receiving antenna which was mounted on the top of a variable height antenna tower.
4. The antenna is a broadband antenna and its height is adjusted between one meter and four meters above ground to find the maximum value of the field strength for both horizontal polarization and vertical polarization of the antenna.
5. For each suspected emission, the EUT was arranged to its worst case and then adjust the antenna tower (from 1 m to 4 m) and turntable (from 0 degree to 360 degrees) to find the maximum reading.
6. For testing below 1GHz, if the emission level of the EUT in peak mode was 3 dB lower than the limit specified, then peak values of EUT will be reported, otherwise, the emissions will be repeated one by one using the CISPR quasi-peak method and reported.

- 7. For testing above 1GHz, the emission level of the EUT in peak mode was 20dB lower than average limit (that means the emission level in average mode also complies with the limit in average mode), then peak values of EUT will be reported, otherwise, the emissions will be measured in average mode again and reported.

### 3.4.4 Test Setup

For radiated emissions below 30MHz

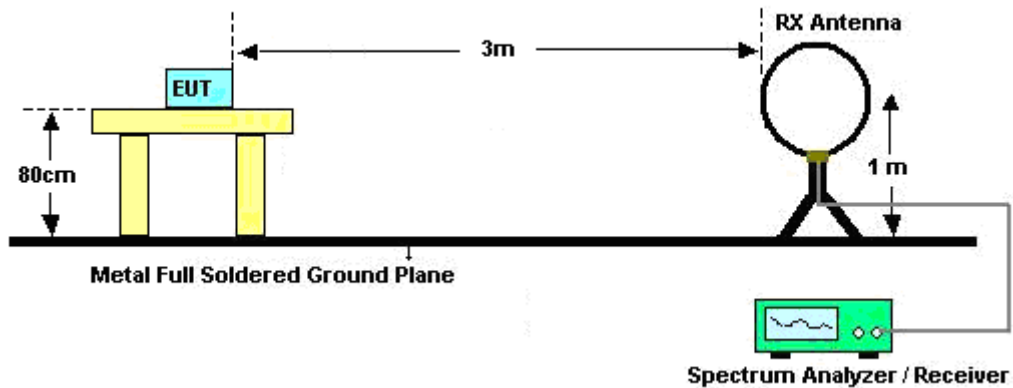

For radiated emissions from 30MHz to 1GHz

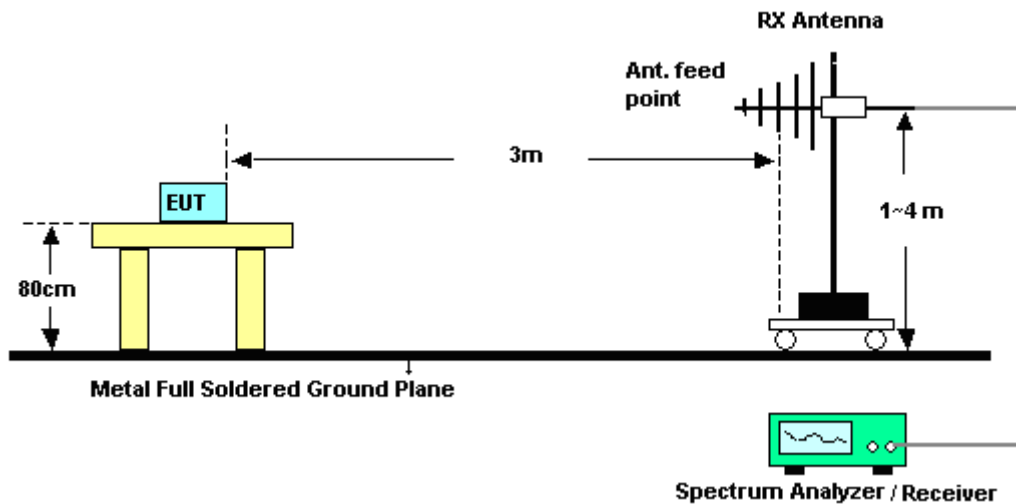

For radiated emissions above 1GHz

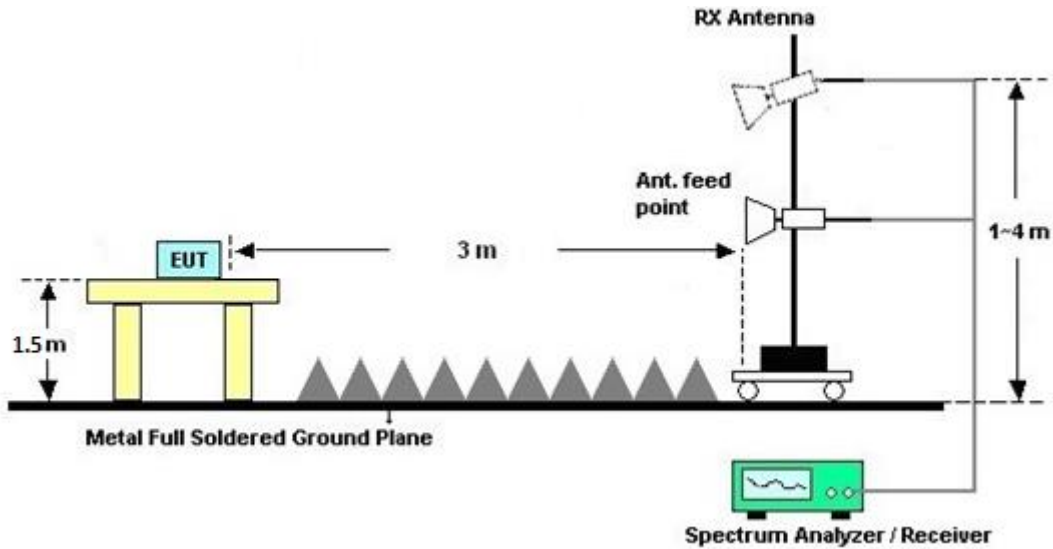

### 3.4.5 Test Results of Radiated Emissions (9 kHz ~ 30 MHz)

The low frequency, which started from 9 kHz to 30MHz, was pre-scanned and the result which was 20dB lower than the limit line per 15.31(o) was not reported.

### 3.4.6 Test Result of Radiated Band Edges

Please refer to Appendix B and C

### 3.4.7 Duty Cycle

Please refer to Appendix D.

### 3.4.8 Test Result of Unwanted Radiated Emission (30MHz ~ 10th Harmonic)

Please refer to Appendix B and C



### 3.5 AC Conducted Emission Measurement

#### 3.5.1 Limit of AC Conducted Emission

For equipment that is designed to be connected to the public utility (AC) power line, the radio frequency voltage that is conducted back onto the AC power line on any frequency or frequencies within the band 150 kHz to 30 MHz shall not exceed the limits in the following table.

Frequency of emission (MHz)	Conducted limit (dB $\mu$ V)	
	Quasi-peak	Average
0.15-0.5	66 to 56*	56 to 46*
0.5-5	56	46
5-30	60	50

\*Decreases with the logarithm of the frequency.

#### 3.5.2 Measuring Instruments

The measuring equipment is listed in the section 4 of this test report.

#### 3.5.3 Test Procedures

1. The EUT was placed 0.4 meter from the conducting wall of the shielding room was kept at least 80 centimeters from any other grounded conducting surface.
2. Connect EUT to the power mains through a line impedance stabilization network (LISN).
3. All the support units are connecting to the other LISN.
4. The LISN provides 50 ohm coupling impedance for the measuring instrument.
5. The FCC states that a 50 ohm, 50 microhenry LISN should be used.
6. Both sides of AC line were checked for maximum conducted interference.
7. The frequency range from 150 kHz to 30 MHz was searched.
8. Set the test-receiver system to Peak Detect Function and specified bandwidth with Maximum Hold Mode.

### 3.5.4 Test Setup

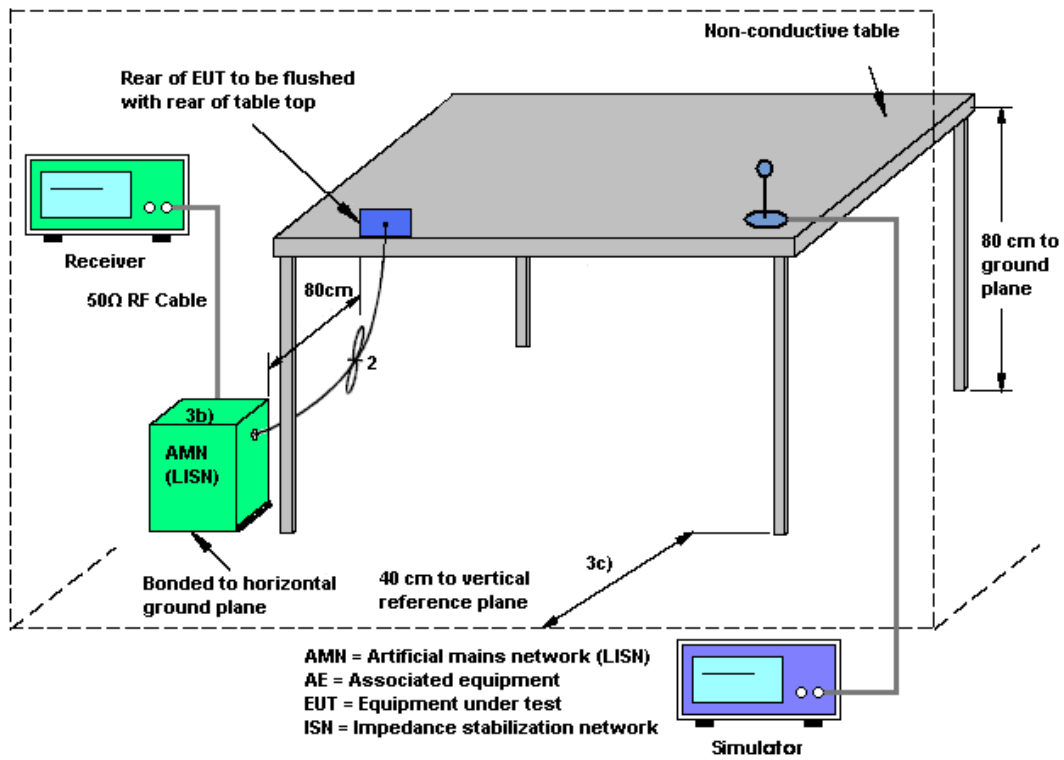



### 3.5.5 Test Result of AC Conducted Emission

Test Mode :	Mode 1	Temperature :	21~22°C
Test Engineer :	Derreck Chen	Relative Humidity :	47~48%
Test Voltage :	120Vac / 60Hz	Phase :	Line
Function Type :	GSM850 Idle + Bluetooth Link + WLAN (5GHz) Link + Adapter + MP3		

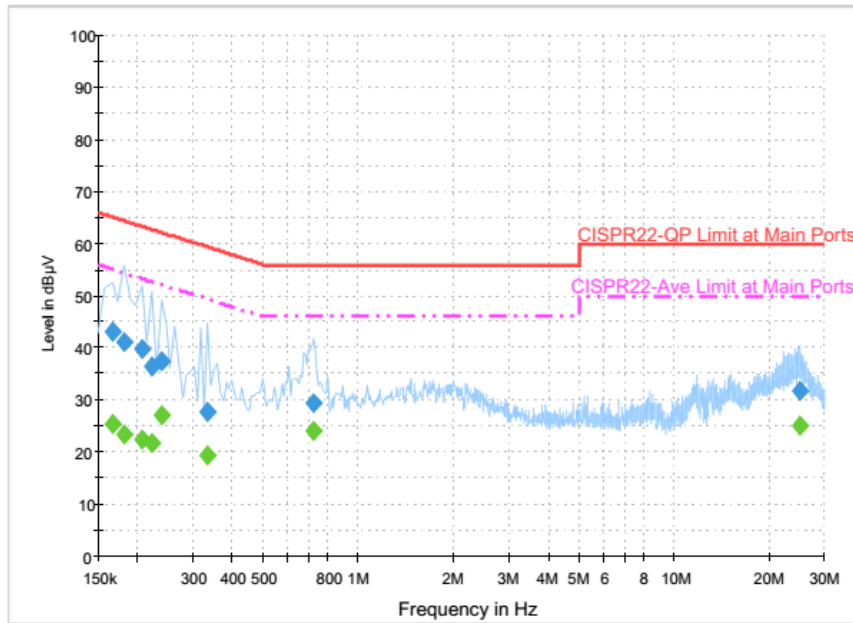

**Final Result : QuasiPeak**

Frequency (MHz)	QuasiPeak (dBµV)	Filter	Line	Corr. (dB)	Margin (dB)	Limit (dBµV)
0.166000	43.3	Off	L1	19.6	21.9	65.2
0.182000	41.0	Off	L1	19.6	23.4	64.4
0.206000	39.9	Off	L1	19.6	23.5	63.4
0.222000	36.3	Off	L1	19.6	26.4	62.7
0.238000	37.5	Off	L1	19.6	24.7	62.2
0.334000	27.9	Off	L1	19.6	31.5	59.4
0.726000	29.4	Off	L1	19.6	26.6	56.0
25.134000	31.7	Off	L1	19.9	28.3	60.0

**Final Result : Average**

Frequency (MHz)	Average (dBµV)	Filter	Line	Corr. (dB)	Margin (dB)	Limit (dBµV)
0.166000	25.3	Off	L1	19.6	29.9	55.2
0.182000	23.6	Off	L1	19.6	30.8	54.4
0.206000	22.3	Off	L1	19.6	31.1	53.4
0.222000	21.8	Off	L1	19.6	30.9	52.7
0.238000	27.3	Off	L1	19.6	24.9	52.2
0.334000	19.5	Off	L1	19.6	29.9	49.4
0.726000	24.2	Off	L1	19.6	21.8	46.0
25.134000	25.1	Off	L1	19.9	24.9	50.0



Test Mode :	Mode 1	Temperature :	21~22°C
Test Engineer :	Derreck Chen	Relative Humidity :	47~48%
Test Voltage :	120Vac / 60Hz	Phase :	Neutral
Function Type :	GSM850 Idle + Bluetooth Link + WLAN (5GHz) Link + Adapter + MP3		

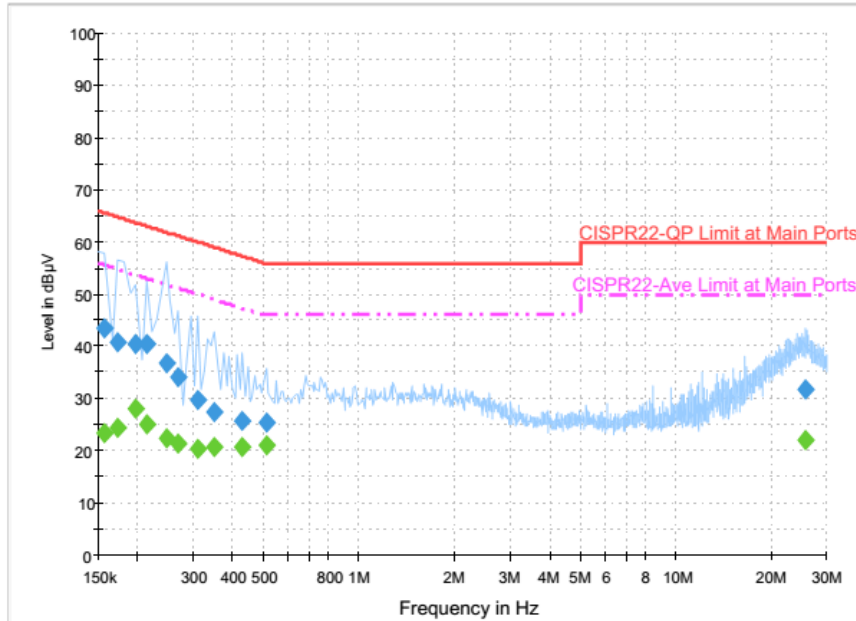

Final Result : QuasiPeak

Frequency (MHz)	QuasiPeak (dBµV)	Filter	Line	Corr. (dB)	Margin (dB)	Limit (dBµV)
0.158000	43.6	Off	N	19.6	22.0	65.6
0.174000	40.9	Off	N	19.6	23.9	64.8
0.198000	40.4	Off	N	19.6	23.3	63.7
0.214000	40.6	Off	N	19.6	22.4	63.0
0.246000	36.8	Off	N	19.6	25.1	61.9
0.270000	34.0	Off	N	19.6	27.1	61.1
0.310000	29.9	Off	N	19.6	30.1	60.0
0.350000	27.4	Off	N	19.6	31.6	59.0
0.430000	25.8	Off	N	19.6	31.5	57.3
0.510000	25.3	Off	N	19.6	30.7	56.0
25.702000	31.8	Off	N	20.0	28.2	60.0



Test Mode :	Mode 1	Temperature :	21~22°C
Test Engineer :	Derreck Chen	Relative Humidity :	47~48%
Test Voltage :	120Vac / 60Hz	Phase :	Neutral
Function Type :	GSM850 Idle + Bluetooth Link + WLAN (5GHz) Link + Adapter + MP3		

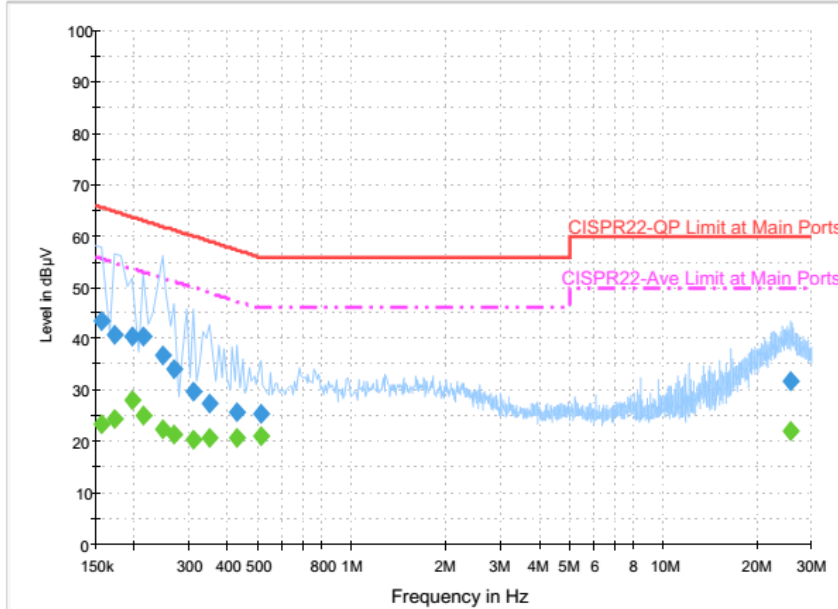

Final Result : Average

Frequency (MHz)	Average (dBµV)	Filter	Line	Corr. (dB)	Margin (dB)	Limit (dBµV)
0.158000	23.4	Off	N	19.6	32.2	55.6
0.174000	24.3	Off	N	19.6	30.5	54.8
0.198000	28.2	Off	N	19.6	25.5	53.7
0.214000	24.9	Off	N	19.6	28.1	53.0
0.246000	22.5	Off	N	19.6	29.4	51.9
0.270000	21.3	Off	N	19.6	29.8	51.1
0.310000	20.4	Off	N	19.6	29.6	50.0
0.350000	20.6	Off	N	19.6	28.4	49.0
0.430000	20.8	Off	N	19.6	26.5	47.3
0.510000	20.9	Off	N	19.6	25.1	46.0
25.702000	21.9	Off	N	20.0	28.1	50.0

### 3.6 Frequency Stability Measurement

#### 3.6.1 Limit of Frequency Stability

Manufacturers of U-NII devices are responsible for ensuring frequency stability such that an emission is maintained within the band of operation under all conditions of normal operation as specified in the user's manual.

#### 3.6.2 Measuring Instruments

The measuring equipment is listed in the section 4 of this test report.

#### 3.6.3 Test Procedures

1. To ensure emission at the band edge is maintained within the authorized band, those values shall be measured by radiation emissions at upper and lower frequency points, and finally compensated by frequency deviation as procedures below.
2. The EUT was operated at the maximum output power, and connected to the spectrum analyzer, which is set to maximum hold function and peak detector. The peak value of the power envelope was measured and noted. The upper and lower frequency points were respectively measured relatively 10dB lower than the measured peak value.
3. The frequency deviation was calculated by adding the upper frequency point and the lower frequency point divided by two. Those detailed values of frequency deviation are provided in table below.

#### 3.6.4 Test Setup

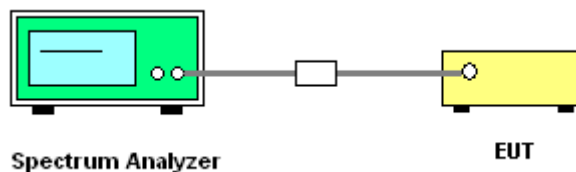

#### 3.6.5 Test Result of Frequency Stability

Please refer to Appendix A.



## **3.7 Automatically Discontinue Transmission**

### **3.7.1 Limit of Automatically Discontinue Transmission**

The device shall automatically discontinue transmission in case of either absence of information to transmit or operational failure. These provisions are not intended to preclude the transmission of control or signaling information or the use of repetitive codes used by certain digital technologies to complete frame or burst intervals. Applicants shall include in their application for equipment authorization to describe how this requirement is met.

### **3.7.2 Measuring Instruments**

The measuring equipment is listed in the section 4 of this test report.

### **3.7.3 Test Result of Automatically Discontinue Transmission**

While the EUT is not transmitting any information, the EUT can automatically discontinue transmission and become standby mode for power saving. The EUT can detect the controlling signal of ACK message transmitting from remote device and verify whether it shall resend or discontinue transmission.



### 3.8 Antenna Requirements

#### 3.8.1 Standard Applicable

According to FCC 47 CFR Section 15.407(a)(1)(2) ,if transmitting antenna directional gain is greater than 6 dBi, both the peak transmit power and the peak power spectral density shall be reduced by the amount in dB that the directional gain of the antenna exceeds 6 dBi.

#### 3.8.2 Antenna Anti-Replacement Construction

An embedded-in antenna design is used.

#### 3.8.3 Antenna Gain

FCC KDB 662911 D01 Multiple Transmitter Output v02r01

For CDD transmissions, directional gain is calculated as

Directional gain =  $G_{ANT}$  + Array Gain, where Array Gain is as follows.

For power spectral density (PSD) measurements on all devices,

Array Gain =  $10 \log(N_{ANT}/N_{SS}=1)$  dB.

For power measurements on IEEE 802.11 devices,

Array Gain = 0 dB (i.e., no array gain) for  $N_{ANT} \leq 4$ .

The EUT supports CDD mode.

The power and PSD limit should be modified if the directional gain of EUT is over 6 dBi,

The directional gain “DG” is calculated as following table.

			DG	DG	Power	PSD
			for	for	Limit	Limit
	Ant 1	Ant 2	Power	PSD	Reduction	Reduction
	(dBi)	(dBi)	(dBi)	(dBi)	(dB)	(dB)
Band IV	-1.00	-6.00	-1.00	-0.13	0.00	0.00

Power limit reduction = Composite gain – 6dBi, ( min = 0 )

PSD limit reduction = Composite gain + PSD Array gain – 6dBi, ( min = 0 )



## 4 List of Measuring Equipment

Instrument	Manufacturer	Model No.	Serial No.	Characteristics	Calibration Date	Test Date	Due Date	Remark
DC Power Supply	TOPWARD	3303D	740889	N/A	May 27, 2015	Apr. 01, 2016 ~ Apr. 25, 2016	May 26, 2016	Conducted (TH02-HY)
Power Meter	Anritsu	ML2495A	1036004	300MHz~40GHz	Jul. 29, 2015	Apr. 01, 2016 ~ Apr. 25, 2016	Jul. 28, 2016	Conducted (TH02-HY)
Power Sensor	Anritsu	MA2411B	1027253	300MHz~40GHz	Jul. 29, 2015	Apr. 01, 2016 ~ Apr. 25, 2016	Jul. 28, 2016	Conducted (TH02-HY)
Spectrum Analyzer	Rohde & Schwarz	FSP40	100055	9kHz~40GHz	Jun. 18, 2015	Apr. 01, 2016 ~ Apr. 25, 2016	Jun. 17, 2016	Conducted (TH02-HY)
Thermal Chamber	Ten Billion	TTH-D3SP	TBN-930701	N/A	Jul. 16, 2015	Apr. 01, 2016 ~ Apr. 25, 2016	Jul. 15, 2016	Conducted (TH02-HY)
AC Power Source	ChainTek	APC-1000W	N/A	N/A	N/A	Apr. 06, 2016	N/A	Conduction (CO05-HY)
EMI Test Receiver	Rohde & Schwarz	ESCI 7	100724	9kHz~7GHz	Aug. 26, 2015	Apr. 06, 2016	Aug. 25, 2016	Conduction (CO05-HY)
LISN	Rohde & Schwarz	ENV216	100080	9kHz~30MHz	Dec. 02, 2015	Apr. 06, 2016	Dec. 01, 2016	Conduction (CO05-HY)
Loop Antenna	Rohde & Schwarz	HFH2-Z2	100315	9 kHz~30 MHz	Sep. 02, 2015	Apr. 11, 2016 ~ Apr. 14, 2016	Sep. 01, 2016	Radiation (03CH11-HY)
Amplifier	SONOMA	310N	187312	9kHz~1GHz	Nov. 20, 2015	Apr. 11, 2016 ~ Apr. 14, 2016	Nov. 19, 2016	Radiation (03CH11-HY)
Bilog Antenna	TESEQ	CBL 6111D	35414	30MHz~1GHz	Nov. 17, 2015	Apr. 11, 2016 ~ Apr. 14, 2016	Nov. 16, 2016	Radiation (03CH11-HY)
Horn Antenna	SCHWARZBECK	BBHA 9120 D	9120D-1326	1GHz ~ 18GHz	Oct. 08, 2015	Apr. 11, 2016 ~ Apr. 14, 2016	Oct. 07, 2016	Radiation (03CH11-HY)
Preamplifier	Keysight	83017A	MY53270080	1GHz~26.5GHz	Nov. 19, 2015	Apr. 11, 2016 ~ Apr. 14, 2016	Nov. 18, 2016	Radiation (03CH11-HY)
Preamplifier	MITEQ	AMF-7D-0010 1800-30-10P	1902247	1GHz~18GHz	Jul. 01, 2015	Apr. 11, 2016 ~ Apr. 14, 2016	Jun. 30, 2016	Radiation (03CH11-HY)
Spectrum Analyzer	Keysight	N9010A	MY54200486	10Hz ~ 44GHZ	Sep. 24, 2015	Apr. 11, 2016 ~ Apr. 14, 2016	Sep. 23, 2016	Radiation (03CH11-HY)
Controller	EMEC	EM 1000	N/A	Control Turn table & Ant Mast	N/A	Apr. 11, 2016 ~ Apr. 14, 2016	N/A	Radiation (03CH11-HY)
Antenna Mast	EMEC	AM-BS-4500-B	N/A	1~4m	N/A	Apr. 11, 2016 ~ Apr. 14, 2016	N/A	Radiation (03CH11-HY)
Turn Table	EMEC	TT 2000	N/A	0~360 Degree	N/A	Apr. 11, 2016 ~ Apr. 14, 2016	N/A	Radiation (03CH11-HY)
SHF-EHF Horn Antenna	SCHWARZBECK	BBHA 9170	BBHA917058 4	18GHz- 40GHz	Nov. 02, 2015	Apr. 11, 2016 ~ Apr. 14, 2016	Nov. 01, 2016	Radiation (03CH11-HY)



## 5 Uncertainty of Evaluation

### Uncertainty of Conducted Emission Measurement (150kHz ~ 30MHz)

Measuring Uncertainty for a Level of Confidence of 95% ( $U = 2Uc(y)$ )	2.26
---	------

### Uncertainty of Radiated Emission Measurement (30 MHz ~ 1000 MHz)

Measuring Uncertainty for a Level of Confidence of 95% ( $U = 2Uc(y)$ )	4.9
---	-----



## Appendix A. Conducted Test Results

Test Engineer:	AC Chang	Temperature:	21~25	°C
Test Date:	2016/04/01 ~ 2016/04/25	Relative Humidity:	51~54	%

**TEST RESULTS DATA**  
**6dB and 26dB EBW and 99% OBW**

Band IV													
Mod.	Data Rate	NTX	CH.	Freq. (MHz)	99% Bandwidth (MHz)		26dB Bandwidth (MHz)		6 dB Bandwidth (MHz)		6 dB Bandwidth Min. Limit (MHz)		Pass/Fail
					Ant 1	Ant 2	Ant 1	Ant 2	Ant 1	Ant 2	Ant 1	Ant 2	
11a	6Mbps	1	149	5745	17.50	17.05	33.50	27.20	15.12	15.16	0.5	0.5	Pass
11a	6Mbps	1	157	5785	17.40	17.00	32.00	26.90	15.12	15.16	0.5	0.5	Pass
11a	6Mbps	1	165	5825	17.30	17.00	32.10	25.80	15.16	15.12	0.5	0.5	Pass
HT20	MCS0	1	149	5745	18.25	18.00	32.10	25.70	15.16	15.16	0.5	0.5	Pass
HT20	MCS0	1	157	5785	18.45	17.90	32.70	27.50	15.12	15.12	0.5	0.5	Pass
HT20	MCS0	1	165	5825	18.35	17.90	32.50	24.10	15.12	15.12	0.5	0.5	Pass
HT40	MCS0	1	151	5755	36.40	36.20	54.36	46.62	35.08	35.08	0.5	0.5	Pass
HT40	MCS0	1	159	5795	36.30	36.10	47.52	44.46	35.08	35.08	0.5	0.5	Pass
VHT20	MCS0	1	149	5745	18.20	18.00	32.00	25.30	15.10	15.10	0.5	0.5	Pass
VHT20	MCS0	1	157	5785	18.25	18.00	32.10	26.10	15.14	15.10	0.5	0.5	Pass
VHT20	MCS0	1	165	5825	18.20	18.00	31.50	24.30	15.10	15.14	0.5	0.5	Pass
VHT40	MCS0	1	151	5755	36.40	36.20	49.14	45.54	35.08	35.08	0.5	0.5	Pass
VHT40	MCS0	1	159	5795	36.30	36.20	48.78	45.36	35.08	35.08	0.5	0.5	Pass
VHT80	MCS0	1	155	5775	75.72	75.12	84.80	83.52	75.12	75.20	0.5	0.5	Pass
11a	6Mbps	2	149	5745	17.45	17.25	33.80	27.50	15.16	15.12	0.5		Pass
11a	6Mbps	2	157	5785	17.35	17.10	34.30	33.60	15.12	15.12	0.5		Pass
11a	6Mbps	2	165	5825	17.45	17.00	34.70	23.70	15.16	15.16	0.5		Pass
HT20	MCS0	2	149	5745	18.25	18.20	33.90	28.20	15.12	15.16	0.5		Pass
HT20	MCS0	2	157	5785	18.25	18.05	32.40	24.90	15.16	15.12	0.5		Pass
HT20	MCS0	2	165	5825	18.20	18.10	31.60	27.20	15.13	15.12	0.5		Pass
HT40	MCS0	2	151	5755	36.30	36.20	51.66	45.36	35.08	35.04	0.5		Pass
HT40	MCS0	2	159	5795	36.30	36.20	47.16	52.02	35.08	35.12	0.5		Pass
VHT20	MCS0	2	149	5745	18.35	18.05	34.80	25.30	15.12	15.12	0.5		Pass
VHT20	MCS0	2	157	5785	18.95	18.10	35.80	24.80	15.12	15.10	0.5		Pass
VHT20	MCS0	2	165	5825	18.60	18.00	32.50	26.90	15.12	15.14	0.5		Pass
VHT40	MCS0	2	151	5755	36.30	36.10	45.36	55.08	35.08	35.08	0.5		Pass
VHT40	MCS0	2	159	5795	36.30	36.20	53.82	50.22	35.08	35.12	0.5		Pass
VHT80	MCS0	2	155	5775	75.60	75.36	107.20	90.24	75.12	74.96	0.5		Pass

**TEST RESULTS DATA**  
**Average Power Table**

Band IV														
Mod.	Data Rate	NTX	CH.	Freq. (MHz)	Duty Factor (dB)		Average Conducted Power (dBm)			FCC Conducted Power Limit (dBm)		DG (dBi)		Pass/Fail
					Ant 1	Ant 2	Ant 1	Ant 2	SUM	Ant 1	Ant 2	Ant 1	Ant 2	
11a	6Mbps	1	149	5745	0.22	0.20	16.37	16.22		30.00	30.00	-1.00	-6.00	Pass
11a	6Mbps	1	157	5785	0.22	0.20	15.85	15.81		30.00	30.00	-1.00	-6.00	Pass
11a	6Mbps	1	165	5825	0.22	0.20	15.96	15.89		30.00	30.00	-1.00	-6.00	Pass
HT20	MCS0	1	149	5745	0.22	0.24	16.13	16.02		30.00	30.00	-1.00	-6.00	Pass
HT20	MCS0	1	157	5785	0.22	0.24	15.90	15.88		30.00	30.00	-1.00	-6.00	Pass
HT20	MCS0	1	165	5825	0.22	0.24	15.72	15.55		30.00	30.00	-1.00	-6.00	Pass
HT40	MCS0	1	151	5755	0.43	0.48	14.94	14.44		30.00	30.00	-1.00	-6.00	Pass
HT40	MCS0	1	159	5795	0.43	0.48	14.45	14.08		30.00	30.00	-1.00	-6.00	Pass
VHT20	MCS0	1	149	5745	0.22	0.22	16.17	15.63		30.00	30.00	-1.00	-6.00	Pass
VHT20	MCS0	1	157	5785	0.22	0.22	15.81	15.74		30.00	30.00	-1.00	-6.00	Pass
VHT20	MCS0	1	165	5825	0.22	0.22	15.78	15.55		30.00	30.00	-1.00	-6.00	Pass
VHT40	MCS0	1	151	5755	0.48	0.46	14.67	14.43		30.00	30.00	-1.00	-6.00	Pass
VHT40	MCS0	1	159	5795	0.48	0.46	14.57	14.12		30.00	30.00	-1.00	-6.00	Pass
VHT80	MCS0	1	155	5775	0.85	0.85	13.93	13.81		30.00	30.00	-1.00	-6.00	Pass
11a	6Mbps	2	149	5745	0.22	0.22	15.60	15.61	18.62	30.00		-1.00		Pass
11a	6Mbps	2	157	5785	0.22	0.22	14.98	15.04	18.03	30.00		-1.00		Pass
11a	6Mbps	2	165	5825	0.22	0.22	15.00	14.73	17.88	30.00		-1.00		Pass
HT20	MCS0	2	149	5745	0.23	0.22	15.41	15.34	18.39	30.00		-1.00		Pass
HT20	MCS0	2	157	5785	0.23	0.22	14.95	15.07	18.02	30.00		-1.00		Pass
HT20	MCS0	2	165	5825	0.23	0.22	15.05	14.77	17.92	30.00		-1.00		Pass
HT40	MCS0	2	151	5755	0.43	0.48	14.01	13.92	16.98	30.00		-1.00		Pass
HT40	MCS0	2	159	5795	0.43	0.48	13.66	13.63	16.66	30.00		-1.00		Pass
VHT20	MCS0	2	149	5745	0.22	0.24	15.37	15.35	18.37	30.00		-1.00		Pass
VHT20	MCS0	2	157	5785	0.22	0.24	15.05	15.09	18.08	30.00		-1.00		Pass
VHT20	MCS0	2	165	5825	0.22	0.24	14.98	14.91	17.95	30.00		-1.00		Pass
VHT40	MCS0	2	151	5755	0.43	0.43	14.09	14.07	17.09	30.00		-1.00		Pass
VHT40	MCS0	2	159	5795	0.43	0.43	13.78	13.38	16.60	30.00		-1.00		Pass
VHT80	MCS0	2	155	5775	0.85	0.85	13.37	13.22	16.31	30.00		-1.00		Pass

**TEST RESULTS DATA**  
**Power Spectral Density**

Band IV																
Mod.	Data Rate	NTX	CH.	Freq. (MHz)	Duty Factor (dB)		10log (500kHz /RBW) Factor (dB)		Average Power Density (dBm/500kHz)			Average PSD Limit (dBm/500kHz)		DG (dBi)		Pass /Fail
					Ant 1	Ant 2	Ant 1	Ant 2	Ant 1	Ant 2	SUM	Ant 1	Ant 2	Ant 1	Ant 2	
11a	6Mbps	1	149	5745	0.22	0.20	2.22	2.22	1.52	1.39		30.00	30.00	-1.00	-6.00	Pass
11a	6Mbps	1	157	5785	0.22	0.20	2.22	2.22	0.94	1.22		30.00	30.00	-1.00	-6.00	Pass
11a	6Mbps	1	165	5825	0.22	0.20	2.22	2.22	1.00	0.89		30.00	30.00	-1.00	-6.00	Pass
HT20	MCS0	1	149	5745	0.22	0.24	2.22	2.22	1.23	1.28		30.00	30.00	-1.00	-6.00	Pass
HT20	MCS0	1	157	5785	0.22	0.24	2.22	2.22	0.74	0.69		30.00	30.00	-1.00	-6.00	Pass
HT20	MCS0	1	165	5825	0.22	0.24	2.22	2.22	0.78	0.46		30.00	30.00	-1.00	-6.00	Pass
HT40	MCS0	1	151	5755	0.43	0.48	2.22	2.22	-2.62	-2.79		30.00	30.00	-1.00	-6.00	Pass
HT40	MCS0	1	159	5795	0.43	0.48	2.22	2.22	-3.22	-3.24		30.00	30.00	-1.00	-6.00	Pass
VHT20	MCS0	1	149	5745	0.22	0.22	2.22	2.22	1.97	1.96		30.00	30.00	-1.00	-6.00	Pass
VHT20	MCS0	1	157	5785	0.22	0.22	2.22	2.22	1.35	1.45		30.00	30.00	-1.00	-6.00	Pass
VHT20	MCS0	1	165	5825	0.22	0.22	2.22	2.22	1.26	1.04		30.00	30.00	-1.00	-6.00	Pass
VHT40	MCS0	1	151	5755	0.48	0.46	2.22	2.22	-2.81	-3.09		30.00	30.00	-1.00	-6.00	Pass
VHT40	MCS0	1	159	5795	0.48	0.46	2.22	2.22	-3.25	-3.33		30.00	30.00	-1.00	-6.00	Pass
VHT80	MCS0	1	155	5775	0.85	0.85	2.22	2.22	-6.53	-6.49		30.00	30.00	-1.00	-6.00	Pass
11a	6Mbps	2	149	5745	0.22	0.22	2.22				4.28	30.00		-0.13	Pass	
11a	6Mbps	2	157	5785	0.22	0.22	2.22				3.55	30.00		-0.13	Pass	
11a	6Mbps	2	165	5825	0.22	0.22	2.22				3.32	30.00		-0.13	Pass	
HT20	MCS0	2	149	5745	0.23	0.22	2.22				3.45	30.00		-0.13	Pass	
HT20	MCS0	2	157	5785	0.23	0.22	2.22				3.08	30.00		-0.13	Pass	
HT20	MCS0	2	165	5825	0.23	0.22	2.22				3.36	30.00		-0.13	Pass	
HT40	MCS0	2	151	5755	0.43	0.48	2.22				-0.53	30.00		-0.13	Pass	
HT40	MCS0	2	159	5795	0.43	0.48	2.22				-0.68	30.00		-0.13	Pass	
VHT20	MCS0	2	149	5745	0.22	0.24	2.22				4.20	30.00		-0.13	Pass	
VHT20	MCS0	2	157	5785	0.22	0.24	2.22				3.47	30.00		-0.13	Pass	
VHT20	MCS0	2	165	5825	0.22	0.24	2.22				3.79	30.00		-0.13	Pass	
VHT40	MCS0	2	151	5755	0.43	0.43	2.22				-0.61	30.00		-0.13	Pass	
VHT40	MCS0	2	159	5795	0.43	0.43	2.22				-1.17	30.00		-0.13	Pass	
VHT80	MCS0	2	155	5775	0.85	0.85	2.22				-3.64	30.00		-0.13	Pass	

**TEST RESULTS DATA**  
**Frequency Stability**

Band IV										
Mod.	Data Rate	NTX	CH.	Freq. (MHz)	Center Frequency (MHz)	Frequency Deviation (MHz)	Frequency Stability (ppm)	Temperature (°C)	Voltage (V)	Note
11a	6Mbps	1	149	5745	5745.000	0.000	0.00	20	3.4	
11a	6Mbps	1	149	5745	5745.000	0.000	0.00	20	4.35	
11a	6Mbps	1	149	5745	5745.000	0.000	0.00	20	3.8	
11a	6Mbps	1	149	5745	5745.050	0.050	8.70	-30	3.8	
11a	6Mbps	1	149	5745	5745.025	0.025	4.35	50	3.8	



## Appendix B. Radiated Spurious Emission

Test Engineer :	J.C. Liang, Bill Chang, and Ken Wu	Temperature :	19~21°C
		Relative Humidity :	50~55%

### Band 4 - 5725~5850MHz

#### WIFI 802.11a (Band Edge @ 3m)

WIFI Ant. 1+2	Note	Frequency ( MHz )	Level ( dBμV/m )	Over Limit ( dB )	Limit Line ( dBμV/m )	Read Level ( dBμV )	Antenna Factor ( dB/m )	Cable Loss ( dB )	Preamp Factor ( dB )	Ant Pos ( cm )	Table Pos ( deg )	Peak Avg. ( P/A )	Pol. ( H/V )	
802.11a CH 149 5745MHz		5713.48	59.17	-14.83	74	49.8	32.29	10.65	33.57	100	211	P	H	
		5724.92	69.03	-9.27	78.3	59.64	32.31	10.65	33.57	100	211	P	H	
		5713.88	52.18	-1.82	54	42.81	32.29	10.65	33.57	100	211	A	H	
	*	5744	104.87	-	-	95.47	32.34	10.63	33.57	100	211	P	H	
	*	5744	96.65	-	-	87.25	32.34	10.63	33.57	100	211	A	H	
														H
														H
														H
			5714.04	61.83	-12.17	74	52.46	32.29	10.65	33.57	357	95	P	V
			5724.92	70.33	-7.97	78.3	60.94	32.31	10.65	33.57	357	95	P	V
			5714.76	52.75	-1.25	54	43.38	32.29	10.65	33.57	357	95	A	V
	*		5745	105.36	-	-	95.96	32.34	10.63	33.57	357	95	P	V
	*		5745	97.64	-	-	88.24	32.34	10.63	33.57	357	95	A	V
														V
														V
													V	



WiFi Ant. 1+2	Note	Frequency ( MHz )	Level ( dBμV/m )	Over Limit ( dB )	Limit Line ( dBμV/m )	Read Level ( dBμV )	Antenna Factor ( dB/m )	Cable Loss ( dB )	Preamp Factor ( dB )	Ant Pos ( cm )	Table Pos ( deg )	Peak Avg. ( P/A )	Pol. ( H/V )
802.11a CH 157 5785MHz		5693.08	48.39	-25.61	74	39.01	32.27	10.67	33.56	100	210	P	H
		5722.76	48.08	-30.22	78.3	38.69	32.31	10.65	33.57	100	210	P	H
		5714.92	39.81	-14.19	54	30.44	32.29	10.65	33.57	100	210	A	H
	*	5785	104.65	-	-	95.24	32.39	10.61	33.59	100	210	P	H
	*	5785	96.65	-	-	87.24	32.39	10.61	33.59	100	210	A	H
		5859.44	48.7	-29.6	78.3	39.03	32.51	10.78	33.62	100	210	P	H
		5872.48	48.86	-25.14	74	39.01	32.53	10.94	33.62	100	210	P	H
		5860.88	40.68	-13.32	54	30.85	32.51	10.94	33.62	100	210	A	H
		5703	48.01	-25.99	74	38.63	32.29	10.65	33.56	336	98	P	V
		5724.12	47.76	-30.54	78.3	38.37	32.31	10.65	33.57	336	98	P	V
		5691.72	39.73	-14.27	54	30.35	32.27	10.67	33.56	336	98	A	V
	*	5785	105.92	-	-	96.51	32.39	10.61	33.59	336	98	P	V
	*	5785	97.75	-	-	88.34	32.39	10.61	33.59	336	98	A	V
		5852	47.55	-30.75	78.3	37.9	32.48	10.78	33.61	336	98	P	V
		5874	49.71	-24.29	74	39.86	32.53	10.94	33.62	336	98	P	V
		5864.16	40.46	-13.54	54	30.63	32.51	10.94	33.62	336	98	A	V



WiFi Ant. 1+2	Note	Frequency ( MHz )	Level ( dBµV/m )	Over Limit ( dB )	Limit Line ( dBµV/m )	Read Level ( dBµV )	Antenna Factor ( dB/m )	Cable Loss ( dB )	Preamp Factor ( dB )	Ant Pos ( cm )	Table Pos ( deg )	Peak Avg. ( P/A )	Pol. ( H/V )	
802.11a CH 165 5825MHz	*	5825	103.48	-	-	93.84	32.46	10.78	33.6	100	212	P	H	
	*	5825	96.13	-	-	86.49	32.46	10.78	33.6	100	212	A	H	
		5850.48	63.41	-14.89	78.3	53.76	32.48	10.78	33.61	100	212	P	H	
		5863.44	53.79	-20.21	74	43.96	32.51	10.94	33.62	100	212	P	H	
		5861.6	47.22	-6.78	54	37.39	32.51	10.94	33.62	100	212	A	H	
														H
														H
														H
	*	5825	104.93	-	-	95.29	32.46	10.78	33.6	347	99	P	V	
	*	5825	97.59	-	-	87.95	32.46	10.78	33.6	347	99	A	V	
		5852.96	66.32	-11.98	78.3	56.67	32.48	10.78	33.61	347	99	P	V	
		5860.72	55.96	-18.04	74	46.13	32.51	10.94	33.62	347	99	P	V	
		5860	49.62	-4.38	54	39.95	32.51	10.78	33.62	347	99	A	V	
														V
														V
														V
														V
<b>Remark</b>	1. No other spurious found. 2. All results are PASS against Peak and Average limit line.													



Band 4 5725~5850MHz

WIFI 802.11a (Harmonic @ 3m)

WIFI Ant. 1+2	Note	Frequency ( MHz )	Level ( dBμV/m )	Over Limit ( dB )	Limit Line ( dBμV/m )	Read Level ( dBμV )	Antenna Factor ( dB/m )	Cable Loss ( dB )	Preamp Factor ( dB )	Ant Pos ( cm )	Table Pos ( deg )	Peak Avg. (P/A)	Pol. (H/V)	
802.11a CH 149 5745MHz		11490	47.38	-26.62	74	57.62	39.91	15.59	65.74	100	0	P	H	
		17235	41.28	-32.72	74	45.76	41	18.6	64.08	100	0	P	H	
													H	
													H	
			11490	49.45	-24.55	74	59.69	39.91	15.59	65.74	100	0	P	V
			17235	42.72	-31.28	74	47.2	41	18.6	64.08	100	0	P	V
														V
802.11a CH 157 5785MHz		11570	46.26	-27.74	74	56.52	39.76	15.64	65.66	100	0	P	H	
		17355	41.53	-32.47	74	45.75	41.35	18.65	64.22	100	0	P	H	
													H	
													H	
			11570	48.34	-25.66	74	58.6	39.76	15.64	65.66	100	0	P	V
			17355	41.65	-32.35	74	45.87	41.35	18.65	64.22	100	0	P	V
														V
802.11a CH 165 5825MHz		11650	48.78	-25.22	74	59.09	39.62	15.69	65.62	100	0	P	H	
		17475	40.74	-33.26	74	44.7	41.7	18.7	64.36	100	0	P	H	
													H	
													H	
			11650	51.5	-22.5	74	61.81	39.62	15.69	65.62	100	0	P	V
			17475	40.49	-33.51	74	44.45	41.7	18.7	64.36	100	0	P	V
														V
Remark	1. No other spurious found.													
	2. All results are PASS against Peak and Average limit line.													





WIFI Ant. 1+2	Note	Frequency ( MHz )	Level ( dBμV/m )	Over Limit ( dB )	Limit Line ( dBμV/m )	Read Level ( dBμV )	Antenna Factor ( dB/m )	Cable Loss ( dB )	Preamp Factor ( dB )	Ant Pos ( cm )	Table Pos ( deg )	Peak Avg. ( P/A )	Pol. ( H/V )
802.11n HT20 CH 157 5785MHz		5700.28	48.2	-25.8	74	38.84	32.27	10.65	33.56	100	230	P	H
		5725	47.74	-30.56	78.3	38.35	32.31	10.65	33.57	100	230	P	H
		5690.76	39.72	-14.28	54	30.34	32.27	10.67	33.56	100	230	A	H
	*	5785	104.45	-	-	95.04	32.39	10.61	33.59	100	230	P	H
	*	5785	96.88	-	-	87.47	32.39	10.61	33.59	100	230	A	H
		5859.52	48.8	-29.5	78.3	39.13	32.51	10.78	33.62	100	230	P	H
		5881.12	48.93	-25.07	74	39.08	32.53	10.94	33.62	100	230	P	H
		5877.28	40.4	-13.6	54	30.55	32.53	10.94	33.62	100	230	A	H
		5694.2	48.53	-25.47	74	39.15	32.27	10.67	33.56	336	105	P	V
		5720.52	47.64	-30.66	78.3	38.25	32.31	10.65	33.57	336	105	P	V
		5688.2	39.63	-14.37	54	30.25	32.27	10.67	33.56	336	105	A	V
	*	5785	105.35	-	-	95.94	32.39	10.61	33.59	336	105	P	V
	*	5785	97.87	-	-	88.46	32.39	10.61	33.59	336	105	A	V
		5857.92	49.47	-28.83	78.3	39.8	32.51	10.78	33.62	336	105	P	V
		5864.64	49.27	-24.73	74	39.44	32.51	10.94	33.62	336	105	P	V
	5871.92	40.75	-13.25	54	30.9	32.53	10.94	33.62	336	105	A	V	



WIFI Ant. 1+2	Note	Frequency ( MHz )	Level ( dBμV/m )	Over Limit ( dB )	Limit Line ( dBμV/m )	Read Level ( dBμV )	Antenna Factor ( dB/m )	Cable Loss ( dB )	Preamp Factor ( dB )	Ant Pos ( cm )	Table Pos ( deg )	Peak Avg. ( P/A )	Pol. ( H/V )	
802.11n HT20 CH 165 5825MHz	*	5825	103.38	-	-	93.74	32.46	10.78	33.6	100	227	P	H	
	*	5825	96.37	-	-	86.73	32.46	10.78	33.6	100	227	A	H	
		5853.12	63.67	-14.63	78.3	54.02	32.48	10.78	33.61	100	227	P	H	
		5860.32	56.26	-17.74	74	46.43	32.51	10.94	33.62	100	227	P	H	
		5860.24	48.91	-5.09	54	39.08	32.51	10.94	33.62	100	227	A	H	
														H
														H
														H
	*	5825	104.36	-	-	94.72	32.46	10.78	33.6	348	100	P	V	
	*	5825	97.3	-	-	87.66	32.46	10.78	33.6	348	100	A	V	
		5851.12	65.53	-12.77	78.3	55.88	32.48	10.78	33.61	348	100	P	V	
		5860.24	58.33	-15.67	74	48.5	32.51	10.94	33.62	348	100	P	V	
		5860.56	50.02	-3.98	54	40.19	32.51	10.94	33.62	348	100	A	V	
														V
														V
													V	
Remark	1. No other spurious found. 2. All results are PASS against Peak and Average limit line.													



Band 4 5725~5850MHz

WIFI 802.11n HT20 (Harmonic @ 3m)

WIFI Ant. 1+2	Note	Frequency ( MHz )	Level ( dBμV/m )	Over Limit ( dB )	Limit Line ( dBμV/m )	Read Level ( dBμV )	Antenna Factor ( dB/m )	Cable Loss ( dB )	Preamp Factor ( dB )	Ant Pos ( cm )	Table Pos ( deg )	Peak Avg. ( P/A )	Pol. ( H/V )	
802.11n HT20 CH 149 5745MHz		11490	47.51	-26.49	74	57.75	39.91	15.59	65.74	100	0	P	H	
		17235	42.02	-26.28	68.3	46.5	41	18.6	64.08	100	0	P	H	
													H	
													H	
			11490	49.29	-24.71	74	59.53	39.91	15.59	65.74	100	0	P	V
			17235	42.32	-25.98	68.3	46.8	41	18.6	64.08	100	0	P	V
														V
802.11n HT20 CH 157 5785MHz		11570	47.55	-26.45	74	57.81	39.76	15.64	65.66	100	0	P	H	
		17355	41.88	-32.12	74	46.1	41.35	18.65	64.22	100	0	P	H	
													H	
													H	
			11570	48.77	-25.23	74	59.03	39.76	15.64	65.66	100	0	P	V
			17355	42.7	-31.3	74	46.92	41.35	18.65	64.22	100	0	P	V
														V
802.11n HT20 CH 165 5825MHz		11650	48.14	-25.86	74	58.45	39.62	15.69	65.62	100	0	P	H	
		17475	40.33	-33.67	74	44.29	41.7	18.7	64.36	100	0	P	H	
													H	
													H	
			11650	54.57	-19.43	74	64.88	39.62	15.69	65.62	360	43	P	V
			11650	43.17	-10.83	54	53.48	39.62	15.69	65.62	360	43	A	V
			17475	40.24	-33.76	74	44.2	41.7	18.7	64.36	100	0	P	V
													V	
Remark	1. No other spurious found. 2. All results are PASS against Peak and Average limit line.													



Band 4 5725~5850MHz

WIFI 802.11n HT40 (Band Edge @ 3m)

WIFI Ant. 1+2	Note	Frequency ( MHz )	Level ( dBμV/m )	Over Limit ( dB )	Limit Line ( dBμV/m )	Read Level ( dBμV )	Antenna Factor ( dB/m )	Cable Loss ( dB )	Preamp Factor ( dB )	Ant Pos ( cm )	Table Pos ( deg )	Peak Avg. (P/A)	Pol. (H/V)	
802.11n HT40 CH 151 5755MHz		5713.8	64.92	-3.38	68.3	55.55	32.29	10.65	33.57	100	229	P	H	
		5723.48	69.72	-8.58	78.3	60.33	32.31	10.65	33.57	100	229	P	H	
	*	5755	99.7	-	-	90.28	32.36	10.63	33.57	100	229	P	H	
	*	5755	92.16	-	-	82.74	32.36	10.63	33.57	100	229	A	H	
		5850.4	50.21	-28.09	78.3	40.56	32.48	10.78	33.61	100	229	P	H	
		5866.64	49.34	-18.96	68.3	39.51	32.51	10.94	33.62	100	229	P	H	
														H
														H
			5714.6	65.51	-2.79	68.3	56.14	32.29	10.65	33.57	356	100	P	V
			5723.96	70.51	-7.79	78.3	61.12	32.31	10.65	33.57	356	100	P	V
	*		5755	101.7	-	-	92.28	32.36	10.63	33.57	356	100	P	V
	*		5755	93.58	-	-	84.16	32.36	10.63	33.57	356	100	A	V
			5856.32	51.02	-27.28	78.3	41.34	32.51	10.78	33.61	356	100	P	V
			5864.08	50.33	-17.97	68.3	40.5	32.51	10.94	33.62	356	100	P	V
														V
														V



WIFI Ant. 1+2	Note	Frequency ( MHz )	Level ( dBμV/m )	Over Limit ( dB )	Limit Line ( dBμV/m )	Read Level ( dBμV )	Antenna Factor ( dB/m )	Cable Loss ( dB )	Preamp Factor ( dB )	Ant Pos ( cm )	Table Pos ( deg )	Peak Avg. ( P/A )	Pol. ( H/V )
802.11n HT40 CH 159 5795MHz		5711.72	51.55	-22.45	74	42.18	32.29	10.65	33.57	100	233	P	H
		5724.84	50.92	-27.38	78.3	41.53	32.31	10.65	33.57	100	233	P	H
		5704.92	40.98	-13.02	54	31.61	32.29	10.65	33.57	100	233	A	H
	*	5795	99.71	-	-	90.28	32.41	10.61	33.59	100	233	P	H
	*	5795	91.87	-	-	82.44	32.41	10.61	33.59	100	233	A	H
		5859.04	53.55	-24.75	78.3	43.88	32.51	10.78	33.62	100	233	P	H
		5860.08	53.04	-20.96	74	43.21	32.51	10.94	33.62	100	233	P	H
		5862.48	45.46	-8.54	54	35.63	32.51	10.94	33.62	100	233	A	H
		5710.6	49.06	-24.94	74	39.69	32.29	10.65	33.57	354	100	P	V
		5723.96	48.35	-29.95	78.3	38.96	32.31	10.65	33.57	354	100	P	V
		5706.76	41.21	-12.79	54	31.84	32.29	10.65	33.57	354	100	A	V
	*	5795	100.81	-	-	91.38	32.41	10.61	33.59	354	100	P	V
	*	5795	93.35	-	-	83.92	32.41	10.61	33.59	354	100	A	V
		5859.04	53.83	-24.47	78.3	44.16	32.51	10.78	33.62	354	100	P	V
		5874.4	53.87	-20.13	74	44.02	32.53	10.94	33.62	354	100	P	V
	5862.56	46.71	-7.29	54	36.88	32.51	10.94	33.62	354	100	A	V	
Remark	1. No other spurious found. 2. All results are PASS against Peak and Average limit line.												



Band 4 5725~5850MHz

WIFI 802.11n HT40 (Harmonic @ 3m)

WIFI Ant. 1+2	Note	Frequency ( MHz )	Level ( dBμV/m )	Over Limit ( dB )	Limit Line ( dBμV/m )	Read Level ( dBμV )	Antenna Factor ( dB/m )	Cable Loss ( dB )	Preamp Factor ( dB )	Ant Pos ( cm )	Table Pos ( deg )	Peak Avg. ( P/A )	Pol. ( H/V )	
802.11n HT40 CH 151 5755MHz		11510	45.03	-28.97	74	55.22	39.9	15.61	65.7	100	0	P	H	
		17265	41.58	-26.72	68.3	45.98	41.1	18.62	64.12	100	0	P	H	
													H	
													H	
			11510	45.37	-28.63	74	55.56	39.9	15.61	65.7	100	0	P	V
			17265	41.5	-26.8	68.3	45.9	41.1	18.62	64.12	100	0	P	V
														V
802.11n HT40 CH 159 5795MHz		11590	44.86	-29.14	74	55.12	39.73	15.66	65.65	100	0	P	H	
		17385	42.31	-31.69	74	46.46	41.45	18.66	64.26	100	0	P	H	
													H	
													H	
			11590	47.41	-26.59	74	57.67	39.73	15.66	65.65	100	0	P	V
			17385	42	-32	74	46.15	41.45	18.66	64.26	100	0	P	V
														V
Remark	1. No other spurious found.													
	2. All results are PASS against Peak and Average limit line.													



Band 4 5725~5850MHz

WIFI 802.11ac VHT20 (Band Edge @ 3m)

WIFI Ant. 1+2	Note	Frequency ( MHz )	Level ( dBμV/m )	Over Limit ( dB )	Limit Line ( dBμV/m )	Read Level ( dBμV )	Antenna Factor ( dB/m )	Cable Loss ( dB )	Preamp Factor ( dB )	Ant Pos ( cm )	Table Pos ( deg )	Peak Avg. (P/A)	Pol. (H/V)	
802.11ac VHT20 CH 149 5745MHz		5712.36	59.58	-8.72	68.3	50.21	32.29	10.65	33.57	100	230	P	H	
		5725	70.2	-8.1	78.3	60.81	32.31	10.65	33.57	100	230	P	H	
	*	5745	104.17	-	-	94.77	32.34	10.63	33.57	100	230	P	H	
	*	5745	97	-	-	87.6	32.34	10.63	33.57	100	230	A	H	
													H	
														H
														H
														H
			5713	62.9	-5.4	68.3	53.53	32.29	10.65	33.57	361	99	P	V
			5725	73.15	-5.15	78.3	63.76	32.31	10.65	33.57	361	99	P	V
	*		5745	105.81	-	-	96.41	32.34	10.63	33.57	361	99	P	V
	*		5745	97.87	-	-	88.47	32.34	10.63	33.57	361	99	A	V
														V
														V



WIFI Ant. 1+2	Note	Frequency ( MHz )	Level ( dBμV/m )	Over Limit ( dB )	Limit Line ( dBμV/m )	Read Level ( dBμV )	Antenna Factor ( dB/m )	Cable Loss ( dB )	Preamp Factor ( dB )	Ant Pos ( cm )	Table Pos ( deg )	Peak Avg. ( P/A )	Pol. ( H/V )
802.11ac VHT20 CH 157 5785MHz		5696.44	48	-26	74	38.62	32.27	10.67	33.56	100	230	P	H
		5715.16	48.05	-30.25	78.3	38.68	32.29	10.65	33.57	100	230	P	H
		5697.56	39.7	-14.3	54	30.32	32.27	10.67	33.56	100	230	A	H
	*	5785	104.32	-	-	94.91	32.39	10.61	33.59	100	230	P	H
	*	5785	96.93	-	-	87.52	32.39	10.61	33.59	100	230	A	H
		5850.72	48.68	-29.62	78.3	39.03	32.48	10.78	33.61	100	230	P	H
		5862.72	48.54	-25.46	74	38.71	32.51	10.94	33.62	100	230	P	H
		5871.2	40.4	-13.6	54	30.55	32.53	10.94	33.62	100	230	A	H
		5711.24	48.26	-25.74	74	38.89	32.29	10.65	33.57	336	105	P	V
		5720.6	47.22	-31.08	78.3	37.83	32.31	10.65	33.57	336	105	P	V
		5688.36	39.76	-14.24	54	30.38	32.27	10.67	33.56	336	105	A	V
	*	5785	105.02	-	-	95.61	32.39	10.61	33.59	336	105	P	V
	*	5785	97.31	-	-	87.9	32.39	10.61	33.59	336	105	A	V
		5859.84	48.79	-29.51	78.3	39.12	32.51	10.78	33.62	336	105	P	V
		5875.12	49.72	-24.28	74	39.87	32.53	10.94	33.62	336	105	P	V
	5880.08	40.49	-13.51	54	30.64	32.53	10.94	33.62	336	105	A	V	



WIFI Ant. 1+2	Note	Frequency ( MHz )	Level ( dBμV/m )	Over Limit ( dB )	Limit Line ( dBμV/m )	Read Level ( dBμV )	Antenna Factor ( dB/m )	Cable Loss ( dB )	Preamp Factor ( dB )	Ant Pos ( cm )	Table Pos ( deg )	Peak Avg. ( P/A )	Pol. ( H/V )	
802.11ac VHT20 CH 165 5825MHz	*	5825	103.95	-	-	94.31	32.46	10.78	33.6	100	227	P	H	
	*	5825	96.29	-	-	86.65	32.46	10.78	33.6	100	227	A	H	
		5850.24	64.53	-13.77	78.3	54.88	32.48	10.78	33.61	100	227	P	H	
		5862.16	58.46	-15.54	74	48.63	32.51	10.94	33.62	100	227	P	H	
		5860	47.06	-6.94	54	37.39	32.51	10.78	33.62	100	227	A	H	
														H
														H
														H
	*	5825	105.25	-	-	95.61	32.46	10.78	33.6	348	100	P	V	
	*	5825	97.21	-	-	87.57	32.46	10.78	33.6	348	100	A	V	
		5852.16	67.1	-11.2	78.3	57.45	32.48	10.78	33.61	348	100	P	V	
		5862.72	61.69	-12.31	74	51.86	32.51	10.94	33.62	348	100	P	V	
		5860.08	48.37	-5.63	54	38.54	32.51	10.94	33.62	348	100	A	V	
														V
														V
													V	
Remark	1. No other spurious found. 2. All results are PASS against Peak and Average limit line.													



Band 4 5725~5850MHz

WIFI 802.11ac VHT20 (Harmonic @ 3m)

WIFI Ant. 1+2	Note	Frequency ( MHz )	Level ( dBμV/m )	Over Limit ( dB )	Limit Line ( dBμV/m )	Read Level ( dBμV )	Antenna Factor ( dB/m )	Cable Loss ( dB )	Preamp Factor ( dB )	Ant Pos ( cm )	Table Pos ( deg )	Peak Avg. (P/A)	Pol. (H/V)	
802.11ac VHT20 CH 149 5745MHz		11490	48.29	-25.71	74	58.53	39.91	15.59	65.74	100	0	P	H	
		17235	41.7	-26.6	68.3	46.18	41	18.6	64.08	100	0	P	H	
													H	
													H	
			11490	49.96	-24.04	74	60.2	39.91	15.59	65.74	100	0	P	V
			17235	41.76	-26.54	68.3	46.24	41	18.6	64.08	100	0	P	V
														V
802.11ac VHT20 CH 157 5785MHz		11570	48.77	-25.23	74	59.03	39.76	15.64	65.66	100	0	P	H	
		17355	40.58	-33.42	74	44.8	41.35	18.65	64.22	100	0	P	H	
													H	
													H	
			11570	49.98	-24.02	74	60.24	39.76	15.64	65.66	100	0	P	V
			17355	41.54	-32.46	74	45.76	41.35	18.65	64.22	100	0	P	V
														V
802.11ac VHT20 CH 165 5825MHz		11650	48.46	-25.54	74	58.77	39.62	15.69	65.62	100	0	P	H	
		17475	40.1	-33.9	74	44.06	41.7	18.7	64.36	100	0	P	H	
													H	
													H	
			11650	55.15	-18.85	74	65.46	39.62	15.69	65.62	361	87	P	V
			11650	43.54	-10.46	54	53.85	39.62	15.69	65.62	361	87	A	V
			17475	41.41	-32.59	74	45.37	41.7	18.7	64.36	100	0	P	V
													V	
Remark	1. No other spurious found. 2. All results are PASS against Peak and Average limit line.													



Band 4 5725~5850MHz

WIFI 802.11ac VHT40 (Band Edge @ 3m)

WIFI Ant. 1+2	Note	Frequency ( MHz )	Level ( dBμV/m )	Over Limit ( dB )	Limit Line ( dBμV/m )	Read Level ( dBμV )	Antenna Factor ( dB/m )	Cable Loss ( dB )	Preamp Factor ( dB )	Ant Pos ( cm )	Table Pos ( deg )	Peak Avg. (P/A)	Pol. (H/V)	
802.11ac VHT40 CH 151 5755MHz		5712.76	64.33	-3.97	68.3	54.96	32.29	10.65	33.57	100	229	P	H	
		5723.16	70.72	-7.58	78.3	61.33	32.31	10.65	33.57	100	229	P	H	
	*	5755	100.2	-	-	90.78	32.36	10.63	33.57	100	229	P	H	
	*	5755	92.45	-	-	83.03	32.36	10.63	33.57	100	229	A	H	
		5857.12	50.18	-28.12	78.3	40.5	32.51	10.78	33.61	100	229	P	H	
		5878.72	48.62	-19.68	68.3	38.77	32.53	10.94	33.62	100	229	P	H	
														H
														H
			5713.56	65.53	-2.77	68.3	56.16	32.29	10.65	33.57	356	100	P	V
			5722.68	69.95	-8.35	78.3	60.56	32.31	10.65	33.57	356	100	P	V
	*		5755	101.18	-	-	91.76	32.36	10.63	33.57	356	100	P	V
	*		5755	93.26	-	-	83.84	32.36	10.63	33.57	356	100	A	V
			5851.52	50.63	-27.67	78.3	40.98	32.48	10.78	33.61	356	100	P	V
			5882.4	48.94	-19.36	68.3	39.09	32.53	10.94	33.62	356	100	P	V
														V
													V	



WIFI Ant. 1+2	Note	Frequency ( MHz )	Level ( dBμV/m )	Over Limit ( dB )	Limit Line ( dBμV/m )	Read Level ( dBμV )	Antenna Factor ( dB/m )	Cable Loss ( dB )	Preamp Factor ( dB )	Ant Pos ( cm )	Table Pos ( deg )	Peak Avg. ( P/A )	Pol. ( H/V )
802.11ac VHT40 CH 159 5795MHz		5712.12	50.01	-23.99	74	40.64	32.29	10.65	33.57	100	233	P	H
		5722.76	49.55	-28.75	78.3	40.16	32.31	10.65	33.57	100	233	P	H
		5706.6	41.24	-12.76	54	31.87	32.29	10.65	33.57	100	233	A	H
	*	5795	99.63	-	-	90.2	32.41	10.61	33.59	100	233	P	H
	*	5795	91.93	-	-	82.5	32.41	10.61	33.59	100	233	A	H
		5850.08	54.42	-23.88	78.3	44.77	32.48	10.78	33.61	100	233	P	H
		5860.96	53.37	-20.63	74	43.54	32.51	10.94	33.62	100	233	P	H
		5862.4	45.78	-8.22	54	35.95	32.51	10.94	33.62	100	233	A	H
		5710.52	49.76	-24.24	74	40.39	32.29	10.65	33.57	354	100	P	V
		5721.08	50.69	-27.61	78.3	41.3	32.31	10.65	33.57	354	100	P	V
		5695.08	41.16	-12.84	54	31.78	32.27	10.67	33.56	354	100	A	V
	*	5795	100.81	-	-	91.38	32.41	10.61	33.59	354	100	P	V
	*	5795	93	-	-	83.57	32.41	10.61	33.59	354	100	A	V
		5858.4	53.83	-24.47	78.3	44.16	32.51	10.78	33.62	354	100	P	V
		5868.08	53.37	-20.63	74	43.54	32.51	10.94	33.62	354	100	P	V
	5863.6	46.4	-7.6	54	36.57	32.51	10.94	33.62	354	100	A	V	
Remark	1. No other spurious found. 2. All results are PASS against Peak and Average limit line.												



Band 4 5725~5850MHz

WIFI 802.11ac VHT40 (Harmonic @ 3m)

WIFI Ant. 1+2	Note	Frequency ( MHz )	Level ( dBμV/m )	Over Limit ( dB )	Limit Line ( dBμV/m )	Read Level ( dBμV )	Antenna Factor ( dB/m )	Cable Loss ( dB )	Preamp Factor ( dB )	Ant Pos ( cm )	Table Pos ( deg )	Peak Avg. ( P/A )	Pol. ( H/V )	
802.11ac VHT40 CH 151 5755MHz		11510	44.63	-29.37	74	54.82	39.9	15.61	65.7	100	0	P	H	
		17265	40.91	-27.39	68.3	45.31	41.1	18.62	64.12	100	0	P	H	
													H	
													H	
			11510	45.47	-28.53	74	55.66	39.9	15.61	65.7	100	0	P	V
			17265	41.59	-26.71	68.3	45.99	41.1	18.62	64.12	100	0	P	V
														V
802.11ac VHT40 CH 159 5795MHz		11590	45.59	-28.41	74	55.85	39.73	15.66	65.65	100	0	P	H	
		17385	41.86	-32.14	74	46.01	41.45	18.66	64.26	100	0	P	H	
													H	
													H	
			11590	46.32	-27.68	74	56.58	39.73	15.66	65.65	100	0	P	V
			17385	41.49	-32.51	74	45.64	41.45	18.66	64.26	100	0	P	V
														V
Remark	1. No other spurious found.													
	2. All results are PASS against Peak and Average limit line.													



Band 4 5725~5850MHz

WIFI 802.11ac VHT80 (Band Edge @ 3m)

WIFI Ant. 1+2	Note	Frequency ( MHz )	Level ( dBμV/m )	Over Limit ( dB )	Limit Line ( dBμV/m )	Read Level ( dBμV )	Antenna Factor ( dB/m )	Cable Loss ( dB )	Preamp Factor ( dB )	Ant Pos ( cm )	Table Pos ( deg )	Peak Avg. (P/A)	Pol. (H/V)	
802.11ac VHT80 CH 155 5775MHz		5703.72	66.08	-2.22	68.3	56.7	32.29	10.65	33.56	100	228	P	H	
		5722.52	67.94	-10.36	78.3	58.55	32.31	10.65	33.57	100	228	P	H	
	*	5775	96.86	-	-	87.42	32.39	10.63	33.58	100	228	P	H	
	*	5775	88.96	-	-	79.52	32.39	10.63	33.58	100	228	A	H	
		5850.16	60.74	-17.56	78.3	51.09	32.48	10.78	33.61	100	228	P	H	
		5864.16	58.65	-9.65	68.3	48.82	32.51	10.94	33.62	100	228	P	H	
														H
														H
			5703.4	67.64	-0.66	68.3	58.26	32.29	10.65	33.56	360	98	P	V
			5723.8	70.27	-8.03	78.3	60.88	32.31	10.65	33.57	360	98	P	V
	*		5775	97.7	-	-	88.26	32.39	10.63	33.58	360	98	P	V
	*		5775	89.96	-	-	80.52	32.39	10.63	33.58	360	98	A	V
			5854.56	61.02	-17.28	78.3	51.34	32.51	10.78	33.61	360	98	P	V
			5861.12	58.73	-9.57	68.3	48.9	32.51	10.94	33.62	360	98	P	V
														V
													V	
Remark	1. No other spurious found. 2. All results are PASS against Peak and Average limit line.													



**Band 4 5725~5850MHz**

**WIFI 802.11ac VHT80 (Harmonic @ 3m)**

WIFI Ant. 1+2	Note	Frequency ( MHz )	Level ( dBμV/m )	Over Limit ( dB )	Limit Line ( dBμV/m )	Read Level ( dBμV )	Antenna Factor ( dB/m )	Cable Loss ( dB )	Preamp Factor ( dB )	Ant Pos ( cm )	Table Pos ( deg )	Peak Avg. ( P/A )	Pol. ( H/V )	
802.11ac VHT80 CH 155 5775MHz		11550	42.28	-31.72	74	52.51	39.8	15.64	65.67	100	0	P	H	
		17325	41.65	-26.65	68.3	45.95	41.25	18.63	64.18	100	0	P	H	
													H	
													H	
			11550	44.02	-29.98	74	54.25	39.8	15.64	65.67	100	0	P	V
			17325	40.95	-27.35	68.3	45.25	41.25	18.63	64.18	100	0	P	V
														V
														V
<b>Remark</b>	1. No other spurious found. 2. All results are PASS against Peak and Average limit line.													



Emission below 1GHz

WIFI 802.11ac VHT80 (LF @ 3m)

WIFI Ant. 1+2	Note	Frequency ( MHz )	Level ( dBμV/m )	Over Limit ( dB )	Limit Line ( dBμV/m )	Read Level (dBμV)	Antenna Factor ( dB/m )	Cable Loss ( dB )	Preamp Factor ( dB )	Ant Pos ( cm )	Table Pos ( deg )	Peak Avg. (P/A)	Pol. (H/V)	
5GHz 11ac VHT80 LF		123.15	37.62	-5.88	43.5	50.13	17.79	1.48	31.78	217	341	P	H	
		205.5	28.18	-15.32	43.5	42.11	16.11	1.74	31.78	-	-	P	H	
		274.08	30.57	-15.43	46	40.96	19.25	2.13	31.77	-	-	P	H	
		367.9	25.61	-20.39	46	33.5	21.56	2.34	31.79	-	-	P	H	
		622	27.45	-18.55	46	30.21	25.92	3.36	32.04	-	-	P	H	
		773.9	30.97	-15.03	46	31.31	27.99	3.62	31.95	-	-	P	H	
														H
														H
														H
														H
														H
														H
			44.58	35.69	-4.31	40	49.07	17.5	0.93	31.81	274	71	P	V
			80.76	31.57	-8.43	40	48.49	13.7	1.17	31.79	-	-	P	V
			203.07	34.11	-9.39	43.5	48.1	16.05	1.74	31.78	-	-	P	V
			434.4	25.47	-20.53	46	30.6	23.02	3.68	31.83	-	-	P	V
			812.4	31.02	-14.98	46	30.73	28.45	3.7	31.86	-	-	P	V
			906.2	32.44	-13.56	46	30.6	29.36	3.86	31.38	-	-	P	V
														V
														V
													V	
													V	
													V	
													V	
Remark	1. No other spurious found. 2. All results are PASS against limit line.													



**Note symbol**

*	<b>Fundamental Frequency</b> which can be ignored. However, the level of any unwanted emissions shall not exceed the level of the fundamental frequency.
!	Test result is <b>over limit</b> line.
P/A	<b>Peak</b> or <b>Average</b>
H/V	<b>Horizontal</b> or <b>Vertical</b>



A calculation example for radiated spurious emission is shown as below:

WIFI	Note	Frequency	Level	Over	Limit	Read	Antenna	Cable	Preamp	Ant	Table	Peak	Pol.
Ant.				Limit	Line	Level	Factor	Loss	Factor	Pos	Pos	Avg.	
1+2		( MHz )	( dBμV/m )	( dB )	( dBμV/m )	( dBμV )	( dB/m )	( dB )	( dB )	( cm )	( deg )	( P/A )	( H/V )
802.11b		2390	55.45	-18.55	74	54.51	32.22	4.58	35.86	103	308	P	H
CH 01													
2412MHz		2390	43.54	-10.46	54	42.6	32.22	4.58	35.86	103	308	A	H

- Level(dBμV/m) =  
Antenna Factor(dB/m) + Cable Loss(dB) + Read Level(dBμV) - Preamp Factor(dB)
- Over Limit(dB) = Level(dBμV/m) – Limit Line(dBμV/m)

**For Peak Limit @ 2390MHz:**

- Level(dBμV/m)  
= Antenna Factor(dB/m) + Cable Loss(dB) + Read Level(dBμV) - Preamp Factor(dB)  
= 32.22(dB/m) + 4.58(dB) + 54.51(dBμV) – 35.86 (dB)  
= 55.45 (dBμV/m)
- Over Limit(dB)  
= Level(dBμV/m) – Limit Line(dBμV/m)  
= 55.45(dBμV/m) – 74(dBμV/m)  
= -18.55(dB)

**For Average Limit @ 2390MHz:**

- Level(dBμV/m)  
= Antenna Factor(dB/m) + Cable Loss(dB) + Read Level(dBμV) - Preamp Factor(dB)  
= 32.22(dB/m) + 4.58(dB) + 42.6(dBμV) – 35.86 (dB)  
= 43.54 (dBμV/m)
- Over Limit(dB)  
= Level(dBμV/m) – Limit Line(dBμV/m)  
= 43.54(dBμV/m) – 54(dBμV/m)  
= -10.46(dB)

Both peak and average measured complies with the limit line, so test result is “PASS”.



## Appendix C. Radiated Spurious Emission Plots

Test Engineer :	J.C. Liang, Bill Chang, and Ken Wu	Temperature :	19~21°C
		Relative Humidity :	50~55%

Note symbol

-L	Low channel location
-R	High channel location

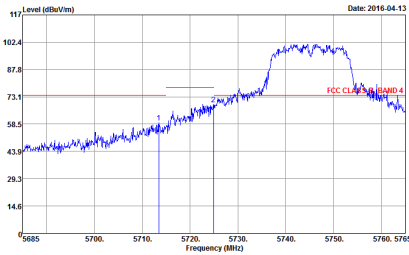
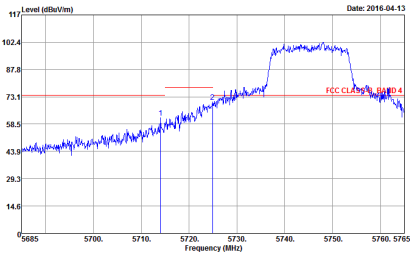
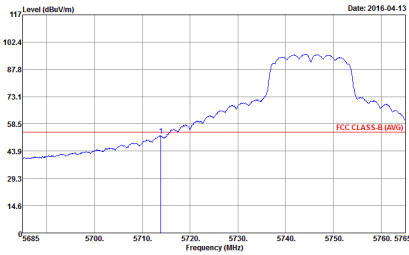
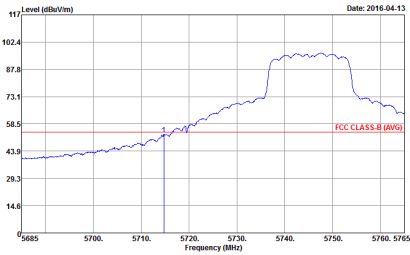

**Band 4 - 5725~5850MHz**  
**WIFI 802.11a (Band Edge @ 3m)**

WIFI	Band 4 5725~5850MHz Band Edge @ 3m	
ANT	802.11a CH149 5745MHz	
1+2	Horizontal	Vertical
<b>Peak</b>	 <p>Site : 03CH11-HY            Condition : FCC CLASS-B_BAND 4 3m HORN 9120D-HF HORIZONTAL            RBW:1000.000KHz VBW:3000.000KHz SWT:Auto            Detector : Peak            Project : 631828            Mode : 47</p>	 <p>Site : 03CH11-HY            Condition : FCC CLASS-B_BAND 4 3m HORN 9120D-HF VERTICAL            RBW:1000.000KHz VBW:3000.000KHz SWT:Auto            Detector : Peak            Project : 631828            Mode : 47</p>
<b>Avg.</b>	 <p>Site : 03CH11-HY            Condition : FCC CLASS-B (AVG) 3m HORN 9120D-HF HORIZONTAL            RBW:1000.000KHz VBW:1000KHz SWT:Auto            Detector : Peak            Project : 631828            Mode : 47</p>	 <p>Site : 03CH11-HY            Condition : FCC CLASS-B (AVG) 3m HORN 9120D-HF VERTICAL            RBW:1000.000KHz VBW:1000KHz SWT:Auto            Detector : Peak            Project : 631828            Mode : 47</p>

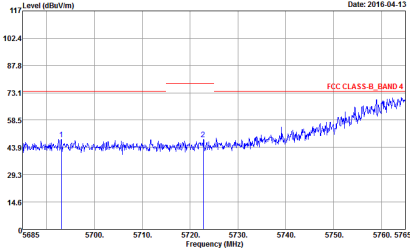
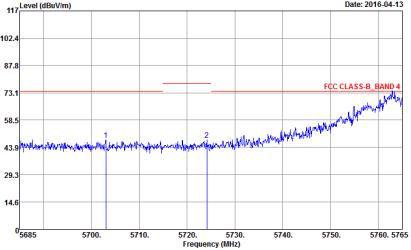
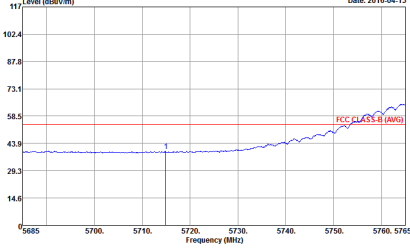
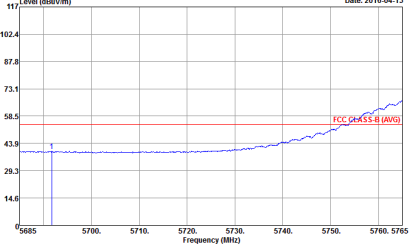

WIFI	Band 4 5725~5850MHz Band Edge @ 3m	
ANT	802.11a CH157 5785MHz - L	
1+2	Horizontal	Vertical
Peak	 <p>Site : 03CH11-HY            Condition : FCC CLASS-B_BAND 4 3m HORN 9120D-HF HORIZONTAL            RBW:1000.000KHz VBW:3000.000KHz SWT:Auto            Detector : Peak            Project : 631828            Mode : 4B</p>	 <p>Site : 03CH11-HY            Condition : FCC CLASS-B_BAND 4 3m HORN 9120D-HF VERTICAL            RBW:1000.000KHz VBW:3000.000KHz SWT:Auto            Detector : Peak            Project : 631828            Mode : 4B</p>
Avg.	 <p>Site : 03CH11-HY            Condition : FCC CLASS-B (AVG) 3m HORN 9120D-HF HORIZONTAL            RBW:1000.000KHz VBW:1000KHz SWT:Auto            Detector : Peak            Project : 631828            Mode : 4B</p>	 <p>Site : 03CH11-HY            Condition : FCC CLASS-B (AVG) 3m HORN 9120D-HF VERTICAL            RBW:1000.000KHz VBW:1000KHz SWT:Auto            Detector : Peak            Project : 631828            Mode : 4B</p>

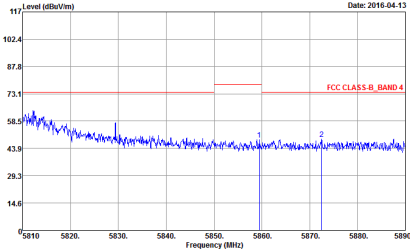
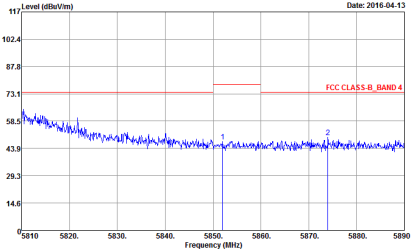
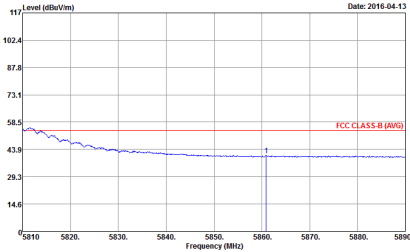
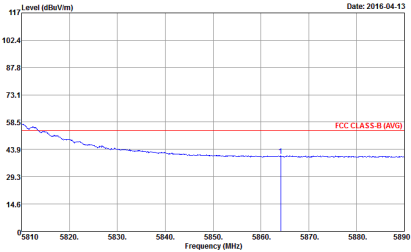

WIFI	Band 4 5725~5850MHz Band Edge @ 3m	
ANT	802.11a CH157 5785MHz - R	
1+2	Horizontal	Vertical
<p><b>Peak</b></p>	 <p>Site : 03CH11-HY            Condition : FCC CLASS-B_BAND 4 3m HORN 9120D-HF HORIZONTAL            Detector : Peak            Project : 631828            Mode : 48</p>	 <p>Site : 03CH11-HY            Condition : FCC CLASS-B_BAND 4 3m HORN 9120D-HF VERTICAL            Detector : Peak            Project : 631828            Mode : 48</p>
<p><b>Avg.</b></p>	 <p>Site : 03CH11-HY            Condition : FCC CLASS-B (AVG) 3m HORN 9120D-HF HORIZONTAL            Detector : Peak            Project : 631828            Mode : 48</p>	 <p>Site : 03CH11-HY            Condition : FCC CLASS-B (AVG) 3m HORN 9120D-HF VERTICAL            Detector : Peak            Project : 631828            Mode : 48</p>

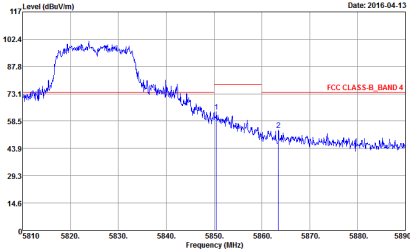
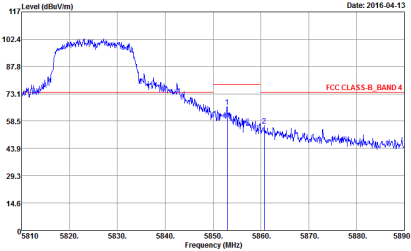
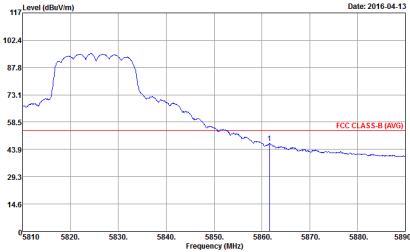
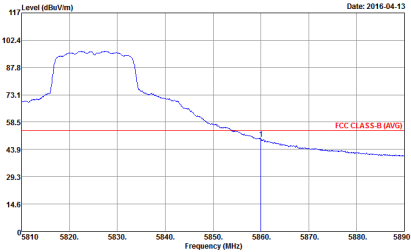

WIFI	Band 4 5725~5850MHz Band Edge @ 3m	
ANT	802.11a CH165 5825MHz	
1+2	Horizontal	Vertical
Peak	 <p>Site : 03CH11-HY            Condition : FCC CLASS-B_BAND 4 3m HORN 9120D-HF HORIZONTAL            RBW:1000.000KHz VBW:3000.000KHz SWT:Auto            Detector : Peak            Project : 631828            Mode : 49</p>	 <p>Site : 03CH11-HY            Condition : FCC CLASS-B_BAND 4 3m HORN 9120D-HF VERTICAL            RBW:1000.000KHz VBW:3000.000KHz SWT:Auto            Detector : Peak            Project : 631828            Mode : 49</p>
Avg.	 <p>Site : 03CH11-HY            Condition : FCC CLASS-B (AVG) 3m HORN 9120D-HF HORIZONTAL            RBW:1000.000KHz VBW:1.000KHz SWT:Auto            Detector : Peak            Project : 631828            Mode : 49</p>	 <p>Site : 03CH11-HY            Condition : FCC CLASS-B (AVG) 3m HORN 9120D-HF VERTICAL            RBW:1000.000KHz VBW:1.000KHz SWT:Auto            Detector : Peak            Project : 631828            Mode : 49</p>



Band 4 5725~5850MHz
WIFI 802.11n HT20 (Band Edge @ 3m)

Table with 2 columns: Horizontal and Vertical. Each column contains a spectral plot of Level (dBuV/m) vs Frequency (MHz) and associated test parameters like Site, Condition, Detector, Project, and Mode.

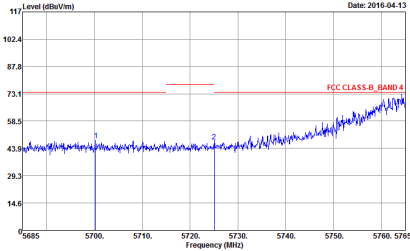
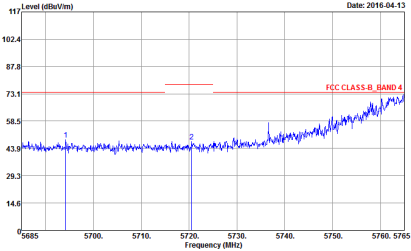
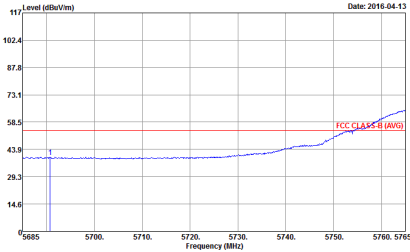
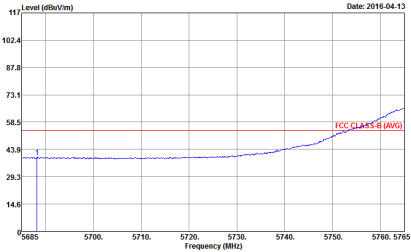

WIFI	Band 4 5725~5850MHz Band Edge @ 3m	
ANT	802.11n HT20 CH157 5785MHz - L	
1+2	Horizontal	Vertical
Peak	 <p>Date: 2016-04-13</p> <p>Site : 03CH11-HY            Condition : FCC CLASS-B_BAND 4 3m HORN 9120D-HF HORIZONTAL            RBW:1000.000KHz VBW:3000.000KHz SWT:Auto            Detector : Peak            Project : 631828            Mode : 51</p>	 <p>Date: 2016-04-13</p> <p>Site : 03CH11-HY            Condition : FCC CLASS-B_BAND 4 3m HORN 9120D-HF VERTICAL            RBW:1000.000KHz VBW:3000.000KHz SWT:Auto            Detector : Peak            Project : 631828            Mode : 51</p>
Avg.	 <p>Date: 2016-04-13</p> <p>Site : 03CH11-HY            Condition : FCC CLASS-B (AVG) 3m HORN 9120D-HF HORIZONTAL            RBW:1000.000KHz VBW:1000KHz SWT:Auto            Detector : Peak            Project : 631828            Mode : 51</p>	 <p>Date: 2016-04-13</p> <p>Site : 03CH11-HY            Condition : FCC CLASS-B (AVG) 3m HORN 9120D-HF VERTICAL            RBW:1000.000KHz VBW:1000KHz SWT:Auto            Detector : Peak            Project : 631828            Mode : 51</p>

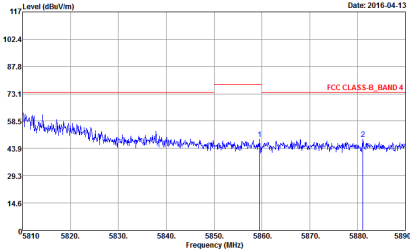
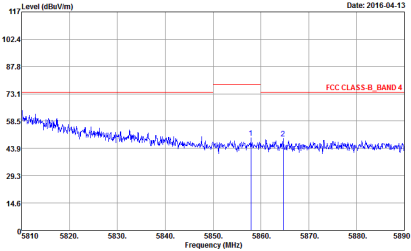
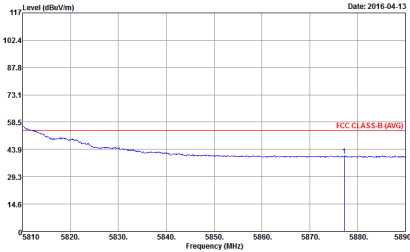
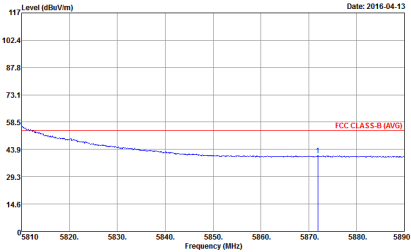

WIFI	Band 4 5725~5850MHz Band Edge @ 3m	
ANT	802.11n HT20 CH157 5785MHz - R	
1+2	Horizontal	Vertical
<p><b>Peak</b></p>	 <p>Site : 03CH11-HY            Condition : FCC CLASS-B_BAND 4 3m HORN 9120D-HF HORIZONTAL            RBW:1000.000KHz VBW:3000.000KHz SWT:Auto            Detector : Peak            Project : 631828            Mode : 51</p>	 <p>Site : 03CH11-HY            Condition : FCC CLASS-B_BAND 4 3m HORN 9120D-HF VERTICAL            RBW:1000.000KHz VBW:3000.000KHz SWT:Auto            Detector : Peak            Project : 631828            Mode : 51</p>
<p><b>Avg.</b></p>	 <p>Site : 03CH11-HY            Condition : FCC CLASS-B (AVG) 3m HORN 9120D-HF HORIZONTAL            RBW:1000.000KHz VBW:1000KHz SWT:Auto            Detector : Peak            Project : 631828            Mode : 51</p>	 <p>Site : 03CH11-HY            Condition : FCC CLASS-B (AVG) 3m HORN 9120D-HF VERTICAL            RBW:1000.000KHz VBW:1000KHz SWT:Auto            Detector : Peak            Project : 631828            Mode : 51</p>

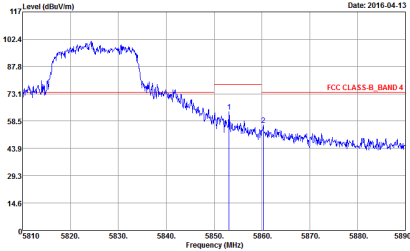
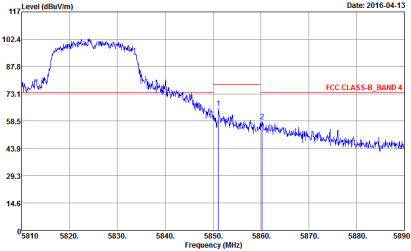
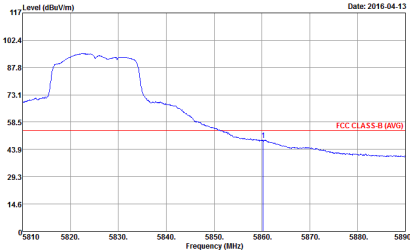
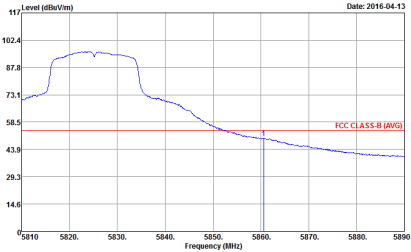

WIFI	Band 4 5725~5850MHz Band Edge @ 3m	
ANT	802.11n HT20 CH165 5825MHz	
1+2	Horizontal	Vertical
<p><b>Peak</b></p>	 <p>Site : 03CH11-HY            Condition : FCC CLASS-B_BAND 4 3m HORN 9120D-HF HORIZONTAL            RBW:1000.000KHz VBW:3000.000KHz SWT:Auto            Detector : Peak            Project : 631828            Mode : 52</p>	 <p>Site : 03CH11-HY            Condition : FCC CLASS-B_BAND 4 3m HORN 9120D-HF VERTICAL            RBW:1000.000KHz VBW:3000.000KHz SWT:Auto            Detector : Peak            Project : 631828            Mode : 52</p>
<p><b>Avg.</b></p>	 <p>Site : 03CH11-HY            Condition : FCC CLASS-B (AVG) 3m HORN 9120D-HF HORIZONTAL            RBW:1000.000KHz VBW:1000KHz SWT:Auto            Detector : Peak            Project : 631828            Mode : 52</p>	 <p>Site : 03CH11-HY            Condition : FCC CLASS-B (AVG) 3m HORN 9120D-HF VERTICAL            RBW:1000.000KHz VBW:1000KHz SWT:Auto            Detector : Peak            Project : 631828            Mode : 52</p>



Band 4 5725~5850MHz
WIFI 802.11n HT40 (Band Edge @ 3m)

Table with 2 main columns: Horizontal and Vertical. Each column contains a spectral plot of Level (dBuV/m) vs Frequency (MHz) and associated test parameters like Site, Condition, Detector, Project, and Mode.

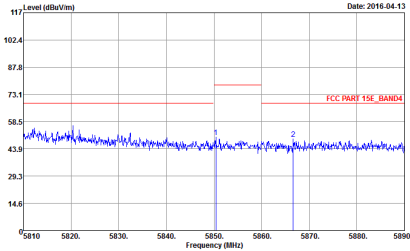
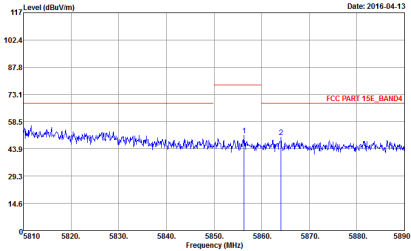

WIFI	<b>Band 4 5725~5850MHz Band Edge @ 3m</b>	
ANT	<b>802.11n HT40 CH151 5755MHz - R</b>	
1+2	<b>Horizontal</b>	<b>Vertical</b>
<b>Peak</b>	 <p style="font-size: small;">Date: 2016-04-13</p> <p>Site : 03CH11-HY          Condition : FCC PART 15E_BAND4 3m HORN 9120D-HF HORIZONTAL          Detector : Peak          Project : 631828          Mode : 53</p>	 <p style="font-size: small;">Date: 2016-04-13</p> <p>Site : 03CH11-HY          Condition : FCC PART 15E_BAND4 3m HORN 9120D-HF VERTICAL          Detector : Peak          Project : 631828          Mode : 53</p>

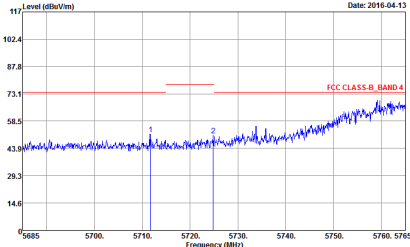
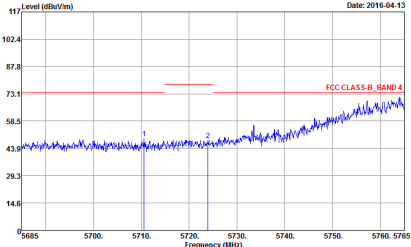
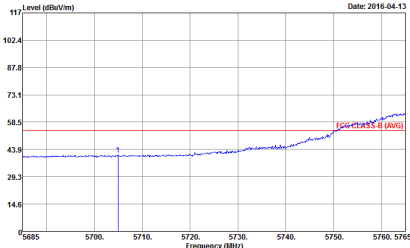
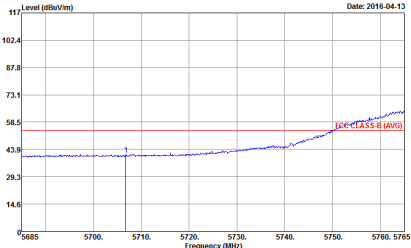

WIFI	Band 4 5725~5850MHz Band Edge @ 3m	
ANT	802.11n HT40 CH159 5795MHz - L	
1+2	Horizontal	Vertical
Peak	 <p>Site : 03CH11-HY            Condition : FCC CLASS-B_BAND 4 3m HORN 9120D-HF HORIZONTAL            RBW:1000.000KHz VBW:3000.000KHz SWT:Auto            Detector : Peak            Project : 631828            Mode : 54</p>	 <p>Site : 03CH11-HY            Condition : FCC CLASS-B_BAND 4 3m HORN 9120D-HF VERTICAL            RBW:1000.000KHz VBW:3000.000KHz SWT:Auto            Detector : Peak            Project : 631828            Mode : 54</p>
Avg.	 <p>Site : 03CH11-HY            Condition : FCC CLASS-B (AVG) 3m HORN 9120D-HF HORIZONTAL            RBW:1000.000KHz VBW:3.000KHz SWT:Auto            Detector : Peak            Project : 631828            Mode : 54</p>	 <p>Site : 03CH11-HY            Condition : FCC CLASS-B (AVG) 3m HORN 9120D-HF VERTICAL            RBW:1000.000KHz VBW:3.000KHz SWT:Auto            Detector : Peak            Project : 631828            Mode : 54</p>

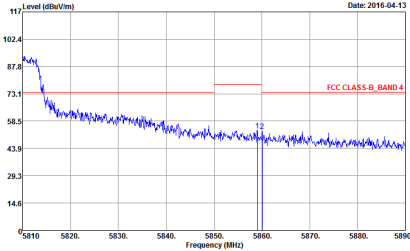
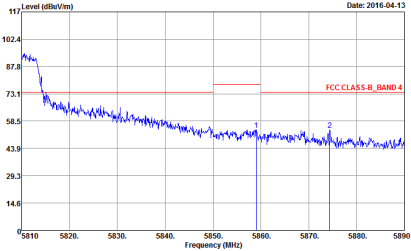
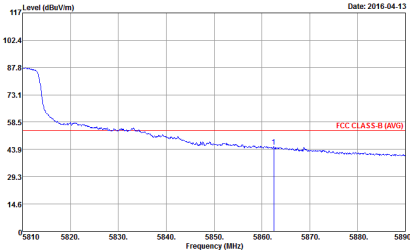
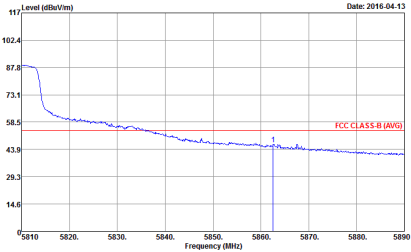

WIFI	Band 4 5725~5850MHz Band Edge @ 3m	
ANT	802.11n HT40 CH159 5795MHz - R	
1+2	Horizontal	Vertical
<p><b>Peak</b></p>	 <p>Site : 03CH11-HY            Condition : FCC CLASS-B_BAND 4 3m HORN 9120D-HF HORIZONTAL            RBW:1000.000KHz VBW:3000.000KHz SWT:Auto            Detector : Peak            Project : 631828            Mode : 54</p>	 <p>Site : 03CH11-HY            Condition : FCC CLASS-B_BAND 4 3m HORN 9120D-HF VERTICAL            RBW:1000.000KHz VBW:3000.000KHz SWT:Auto            Detector : Peak            Project : 631828            Mode : 54</p>
<p><b>Avg.</b></p>	 <p>Site : 03CH11-HY            Condition : FCC CLASS-B (AVG) 3m HORN 9120D-HF HORIZONTAL            RBW:1000.000KHz VBW:3.000KHz SWT:Auto            Detector : Peak            Project : 631828            Mode : 54</p>	 <p>Site : 03CH11-HY            Condition : FCC CLASS-B (AVG) 3m HORN 9120D-HF VERTICAL            RBW:1000.000KHz VBW:3.000KHz SWT:Auto            Detector : Peak            Project : 631828            Mode : 54</p>

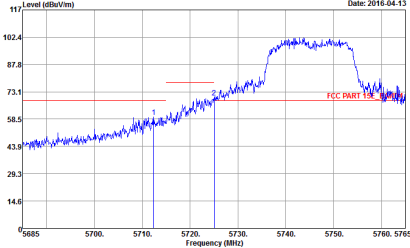
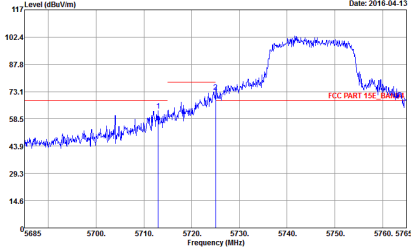

**Band 4 5725~5850MHz  
WIFI 802.11ac VHT20 (Band Edge @ 3m)**

WIFI	Band 4 5725~5850MHz Band Edge @ 3m	
ANT	802.11ac VHT20 CH149 5745MHz	
1+2	Horizontal	Vertical
<p><b>Peak</b></p>	 <p>Site : 03CH11-HY Condition : FCC PART 15E_BAND4 3m HORN 9120D-HF HORIZONTAL RBW:1000.000KHz VBW:3000.000KHz SWT:Auto Detector : Peak Project : 631828 Mode : 55</p>	 <p>Site : 03CH11-HY Condition : FCC PART 15E_BAND4 3m HORN 9120D-HF VERTICAL RBW:1000.000KHz VBW:3000.000KHz SWT:Auto Detector : Peak Project : 631828 Mode : 55</p>

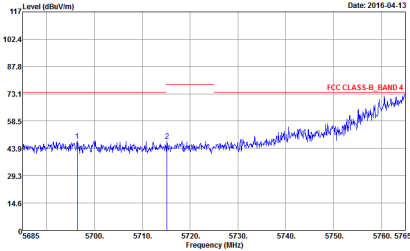
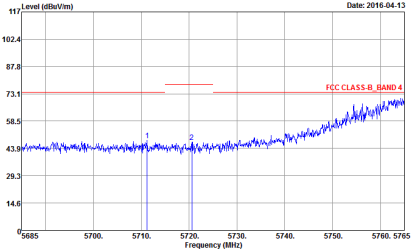
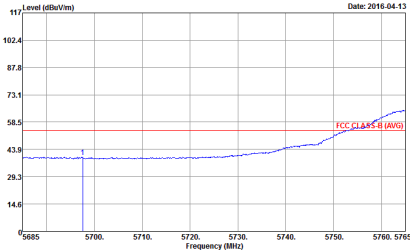
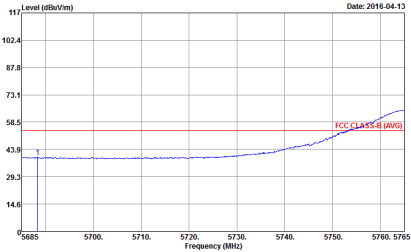

WIFI	Band 4 5725~5850MHz Band Edge @ 3m	
ANT	802.11ac VHT20 CH157 5785MHz - L	
1+2	Horizontal	Vertical
Peak	 <p>Date: 2016-04-13</p> <p>Site : 03CH11-HY            Condition : FCC CLASS-B_BAND 4 3m HORN 9120D-HF HORIZONTAL            RBW:1000.000KHz VBW:3000.000KHz SWT:Auto            Detector : Peak            Project : 631828            Mode : 56</p>	 <p>Date: 2016-04-13</p> <p>Site : 03CH11-HY            Condition : FCC CLASS-B_BAND 4 3m HORN 9120D-HF VERTICAL            RBW:1000.000KHz VBW:3000.000KHz SWT:Auto            Detector : Peak            Project : 631828            Mode : 56</p>
Avg.	 <p>Date: 2016-04-13</p> <p>Site : 03CH11-HY            Condition : FCC CLASS-B (AVG) 3m HORN 9120D-HF HORIZONTAL            RBW:1000.000KHz VBW:1000KHz SWT:Auto            Detector : Peak            Project : 631828            Mode : 56</p>	 <p>Date: 2016-04-13</p> <p>Site : 03CH11-HY            Condition : FCC CLASS-B (AVG) 3m HORN 9120D-HF VERTICAL            RBW:1000.000KHz VBW:1000KHz SWT:Auto            Detector : Peak            Project : 631828            Mode : 56</p>

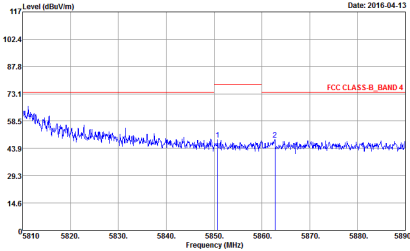
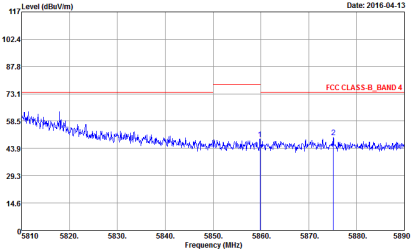
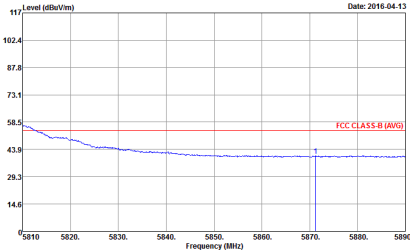
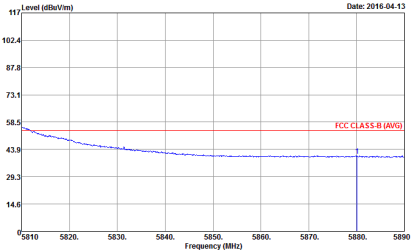

WIFI	Band 4 5725~5850MHz Band Edge @ 3m	
ANT	802.11ac VHT20 CH157 5785MHz - R	
1+2	Horizontal	Vertical
Peak	 <p>Site : 03CH11-HY            Condition : FCC CLASS-B_BAND 4 3m HORN 9120D-HF HORIZONTAL            RBW:1000.000KHz VBW:3000.000KHz SWT:Auto            Detector : Peak            Project : 631828            Mode : 56</p>	 <p>Site : 03CH11-HY            Condition : FCC CLASS-B_BAND 4 3m HORN 9120D-HF VERTICAL            RBW:1000.000KHz VBW:3000.000KHz SWT:Auto            Detector : Peak            Project : 631828            Mode : 56</p>
Avg.	 <p>Site : 03CH11-HY            Condition : FCC CLASS-B (AVG) 3m HORN 9120D-HF HORIZONTAL            RBW:1000.000KHz VBW:1.000KHz SWT:Auto            Detector : Peak            Project : 631828            Mode : 56</p>	 <p>Site : 03CH11-HY            Condition : FCC CLASS-B (AVG) 3m HORN 9120D-HF VERTICAL            RBW:1000.000KHz VBW:1.000KHz SWT:Auto            Detector : Peak            Project : 631828            Mode : 56</p>

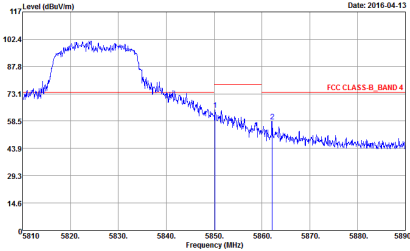
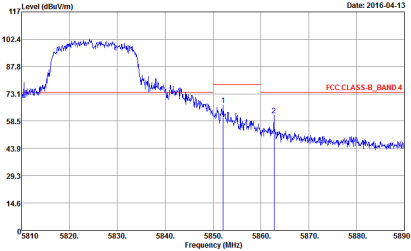
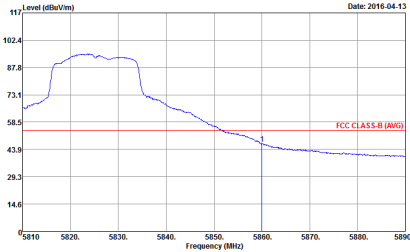
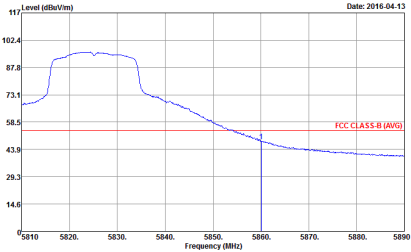

WIFI	Band 4 5725~5850MHz Band Edge @ 3m	
ANT	802.11ac VHT20 CH165 5825MHz	
1+2	Horizontal	Vertical
Peak	 <p>Site : 03CH11-HY            Condition : FCC CLASS-B_BAND 4 3m HORN 9120D-HF HORIZONTAL            RBW:1000.000KHz VBW:3000.000KHz SWT:Auto            Detector : Peak            Project : 631828            Mode : 57</p>	 <p>Site : 03CH11-HY            Condition : FCC CLASS-B_BAND 4 3m HORN 9120D-HF VERTICAL            RBW:1000.000KHz VBW:3000.000KHz SWT:Auto            Detector : Peak            Project : 631828            Mode : 57</p>
Avg.	 <p>Site : 03CH11-HY            Condition : FCC CLASS-B (AVG) 3m HORN 9120D-HF HORIZONTAL            RBW:1000.000KHz VBW:1.000KHz SWT:Auto            Detector : Peak            Project : 631828            Mode : 57</p>	 <p>Site : 03CH11-HY            Condition : FCC CLASS-B (AVG) 3m HORN 9120D-HF VERTICAL            RBW:1000.000KHz VBW:1.000KHz SWT:Auto            Detector : Peak            Project : 631828            Mode : 57</p>

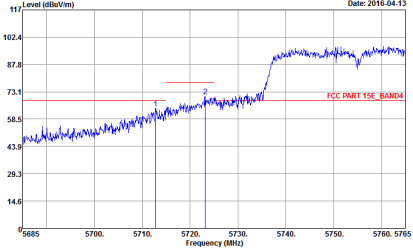
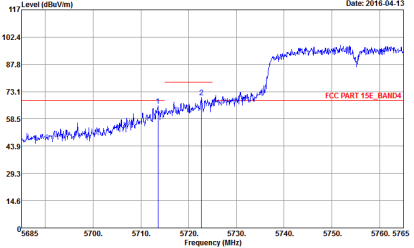

**Band 4 5725~5850MHz  
WIFI 802.11ac VHT40 (Band Edge @ 3m)**

WIFI	Band 4 5725~5850MHz Band Edge @ 3m	
ANT	802.11ac VHT40 CH151 5755MHz	
1+2	Horizontal	Vertical
<p><b>Peak</b></p>	 <p>Date: 2016-04-13</p> <pre> Site      : 03CH11-HY Condition : FCC PART 15E_BAND4 3m HORN 9120D-HF HORIZONTAL RBW      : 1000.000KHz VBW:3000.000KHz SWT:Auto Detector  : Peak Project   : 631828 Mode      : 58           </pre>	 <p>Date: 2016-04-13</p> <pre> Site      : 03CH11-HY Condition : FCC PART 15E_BAND4 3m HORN 9120D-HF VERTICAL RBW      : 1000.000KHz VBW:3000.000KHz SWT:Auto Detector  : Peak Project   : 631828 Mode      : 58           </pre>



WIFI	Band 4 5725~5850MHz Band Edge @ 3m	
ANT	802.11ac VHT40 CH151 5755MHz	
1+2	Horizontal	Vertical
Peak	<p>Site : 03CH11-HY Condition : FCC PART 15E_BAND4 3m HORN 9120D-HF HORIZONTAL RBW:1000.000KHz VBW:3000.000KHz SWT:Auto Detector : Peak Project : 631828 Mode : 58</p>	<p>Site : 03CH11-HY Condition : FCC PART 15E_BAND4 3m HORN 9120D-HF VERTICAL RBW:1000.000KHz VBW:3000.000KHz SWT:Auto Detector : Peak Project : 631828 Mode : 58</p>

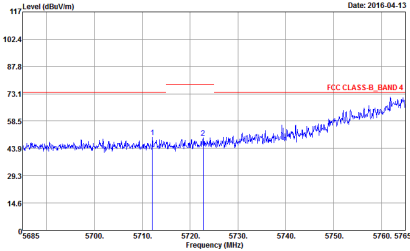
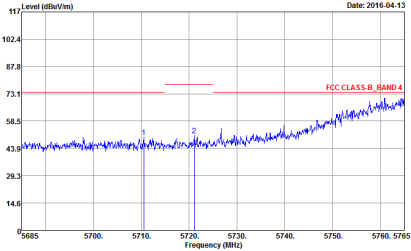
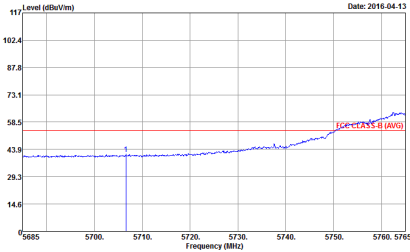
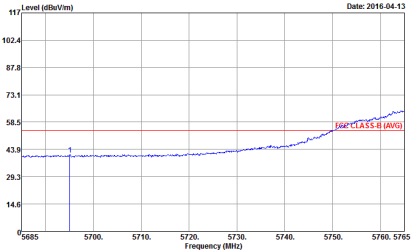

WIFI	Band 4 5725~5850MHz Band Edge @ 3m	
ANT	802.11ac VHT40 CH159 5795MHz	
1+2	Horizontal	Vertical
Peak	 <p>Date: 2016-04-13</p> <p>Site : 03CH11-HY            Condition : FCC CLASS-B_BAND 4 3m HORN 9120D-HF HORIZONTAL            RBW:1000.000KHz VBW:3000.000KHz SWT:Auto            Detector : Peak            Project : 631828            Mode : 59</p>	 <p>Date: 2016-04-13</p> <p>Site : 03CH11-HY            Condition : FCC CLASS-B_BAND 4 3m HORN 9120D-HF VERTICAL            RBW:1000.000KHz VBW:3000.000KHz SWT:Auto            Detector : Peak            Project : 631828            Mode : 59</p>
Avg.	 <p>Date: 2016-04-13</p> <p>Site : 03CH11-HY            Condition : FCC CLASS-B (AVG) 3m HORN 9120D-HF HORIZONTAL            RBW:1000.000KHz VBW:3.000KHz SWT:Auto            Detector : Peak            Project : 631828            Mode : 59</p>	 <p>Date: 2016-04-13</p> <p>Site : 03CH11-HY            Condition : FCC CLASS-B (AVG) 3m HORN 9120D-HF VERTICAL            RBW:1000.000KHz VBW:3.000KHz SWT:Auto            Detector : Peak            Project : 631828            Mode : 59</p>

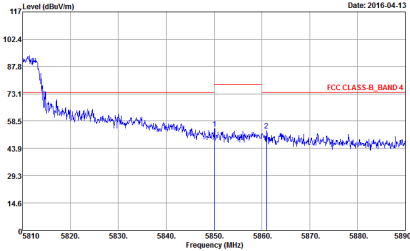
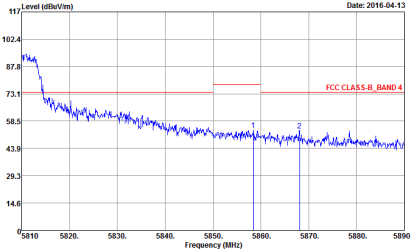
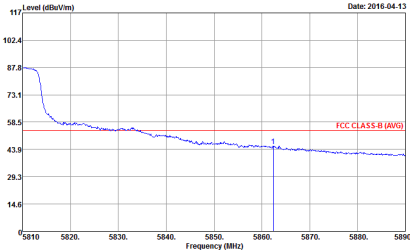
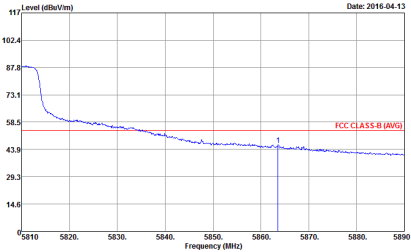

WIFI	Band 4 5725~5850MHz Band Edge @ 3m	
ANT	802.11ac VHT40 CH159 5795MHz	
1+2	Horizontal	Vertical
<p><b>Peak</b></p>	 <p>Site : 03CH11-HY            Condition : FCC CLASS-B_BAND 4 3m HORN 9120D-HF HORIZONTAL            RBW:1000.000KHz VBW:3000.000KHz SWT:Auto            Detector : Peak            Project : 631828            Mode : 59</p>	 <p>Site : 03CH11-HY            Condition : FCC CLASS-B_BAND 4 3m HORN 9120D-HF VERTICAL            RBW:1000.000KHz VBW:3000.000KHz SWT:Auto            Detector : Peak            Project : 631828            Mode : 59</p>
<p><b>Avg.</b></p>	 <p>Site : 03CH11-HY            Condition : FCC CLASS-B (AVG) 3m HORN 9120D-HF HORIZONTAL            RBW:1000.000KHz VBW:3.000KHz SWT:Auto            Detector : Peak            Project : 631828            Mode : 59</p>	 <p>Site : 03CH11-HY            Condition : FCC CLASS-B (AVG) 3m HORN 9120D-HF VERTICAL            RBW:1000.000KHz VBW:3.000KHz SWT:Auto            Detector : Peak            Project : 631828            Mode : 59</p>

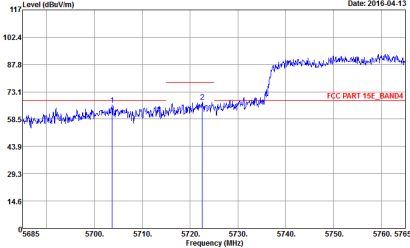
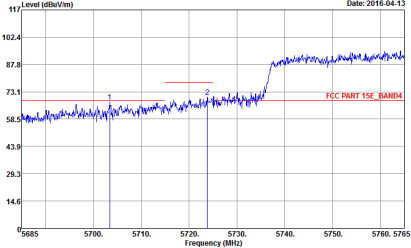

**Band 4 5725~5850MHz  
WIFI 802.11ac VHT80 (Band Edge @ 3m)**

WIFI	Band 4 5725~5850MHz Band Edge @ 3m	
ANT	802.11ac VHT80 CH155 5775MHz - L	
1+2	Horizontal	Vertical
<p><b>Peak</b></p>	 <p>Date: 2016-04-13</p> <pre> Site      : 03CH11-HY Condition : FCC PART 15E_BAND4 3m HORN 9120D-HF HORIZONTAL RBW      : 1000.000KHz VBW:3000.000KHz SWT:Auto Detector  : Peak Project   : 631828 Mode      : 60 Setting   : 14.5            : 68.3           </pre>	 <p>Date: 2016-04-13</p> <pre> Site      : 03CH11-HY Condition : FCC PART 15E_BAND4 3m HORN 9120D-HF VERTICAL RBW      : 1000.000KHz VBW:3000.000KHz SWT:Auto Detector  : Peak Project   : 631828 Mode      : 60 Setting   : 14.5            : 68.3           </pre>

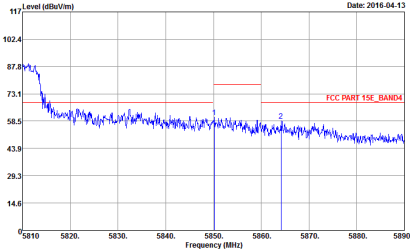
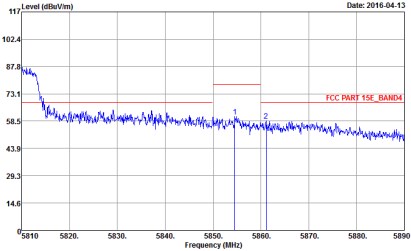

WIFI	Band 4 5725~5850MHz Band Edge @ 3m	
ANT	802.11ac VHT80 CH155 5775MHz - R	
1+2	Horizontal	Vertical
Peak	 <p>Date: 2016-04-13</p> <p>Site : 03CH11-HY  Condition : FCC PART 15E_BAND4 3m HORN 9120D-HF HORIZONTAL  RBW:1000.000KHz VBW:3000.000KHz SWT:Auto  Detector : Peak  Project : 631828  Mode : 60  Setting : 14.5 : 68.3</p>	 <p>Date: 2016-04-13</p> <p>Site : 03CH11-HY  Condition : FCC PART 15E_BAND4 3m HORN 9120D-HF VERTICAL  RBW:1000.000KHz VBW:3000.000KHz SWT:Auto  Detector : Peak  Project : 631828  Mode : 60  Setting : 14.5 : 68.3</p>



Band 4 - 5725~5850MHz
WIFI 802.11a (Harmonic @ 3m)

Table with 2 main columns: Horizontal and Vertical. Each column contains a graph of Level (dBuV/m) vs Frequency (MHz) with two peaks labeled 1 and 2. Includes metadata like Site, Condition, Detector, Project, and Mode.

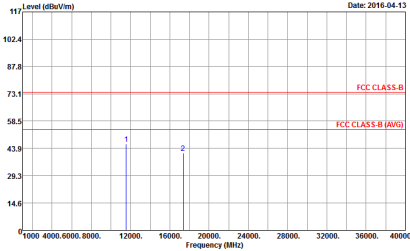
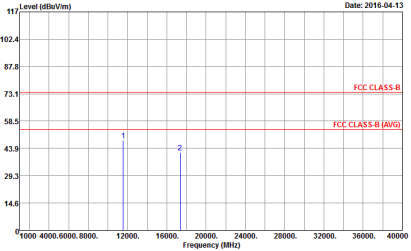

WIFI	Band 4 5725-5850MHz Harmonic @ 3m	
ANT	802.11a CH157 5785MHz	
1+2	Horizontal	Vertical
Peak Avg.	 <p>Site : 03CH11-HY Condition : FCC CLASS-B 3m 9170 SHF HORM_150809 HORIZONTAL Detector : Peak Project : 631828 Mode : 48</p>	 <p>Site : 03CH11-HY Condition : FCC CLASS-B 3m 9170 SHF HORM_150809 VERTICAL Detector : Peak Project : 631828 Mode : 48</p>

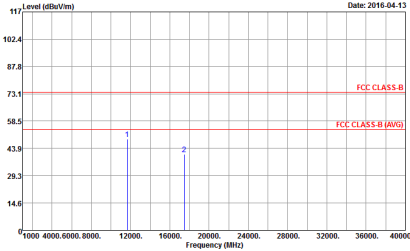
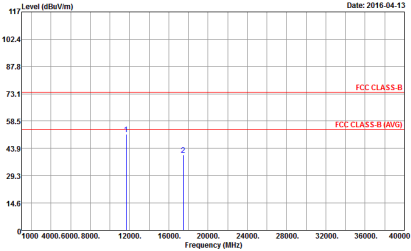

WIFI	Band 4 5725-5850MHz Harmonic @ 3m	
ANT	802.11a CH165 5825MHz	
1+2	Horizontal	Vertical
Peak Avg.	 <p>Site : 03CH11-HY Condition : FCC CLASS-B 3m 9170 SHF HORM_150809 HORIZONTAL Detector : Peak Project : 631828 Mode : 49</p>	 <p>Site : 03CH11-HY Condition : FCC CLASS-B 3m 9170 SHF HORM_150809 VERTICAL Detector : Peak Project : 631828 Mode : 49</p>

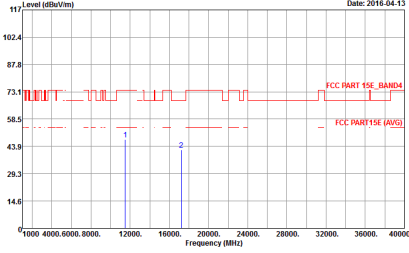
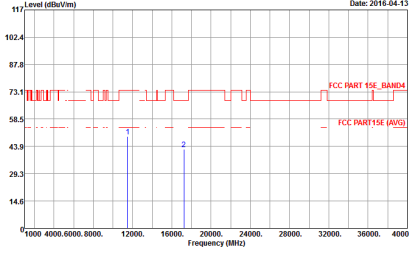

**Band 4 5725~5850MHz  
WIFI 802.11n HT20 (Harmonic @ 3m)**

WIFI	Band 4 5725~5850MHz Harmonic @ 3m	
ANT	802.11n HT20 CH149 5745MHz	
1+2	Horizontal	Vertical
<p><b>Peak</b> <b>Avg.</b></p>	 <p>Site : 03CH11-HY Condition : FCC PART 15E_BAND4 3m 9170 SHF HORM_150809 HORIZONTAL Detector : Peak Project : 631828 Mode : 50</p>	 <p>Site : 03CH11-HY Condition : FCC PART 15E_BAND4 3m 9170 SHF HORM_150809 VERTICAL Detector : Peak Project : 631828 Mode : 50</p>



WIFI	Band 4 5725-5850MHz Harmonic @ 3m	
ANT	802.11n HT20 CH157 5785MHz	
1+2	Horizontal	Vertical
Peak Avg.	<p>Site : 03CH11-HY Condition : FCC CLASS-B 3m 9170 SHF HORM_150809 HORIZONTAL Detector : Peak Project : 631828 Mode : 51</p>	<p>Site : 03CH11-HY Condition : FCC CLASS-B 3m 9170 SHF HORM_150809 VERTICAL Detector : Peak Project : 631828 Mode : 51</p>

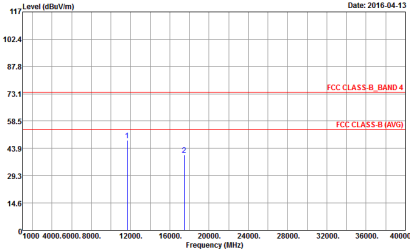
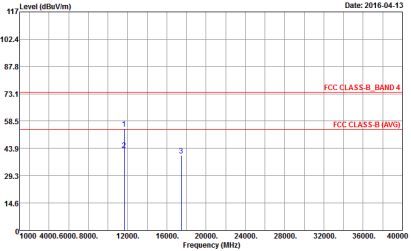

WIFI	Band 4 5725-5850MHz Harmonic @ 3m	
ANT	802.11n HT20 CH165 5825MHz	
1+2	Horizontal	Vertical
Peak Avg.	 <p>Site : 03CH11-HY Condition : FCC CLASS-B_BAND 4 3m 9170 SHF HORM_150809 HORIZONTAL Detector : Peak Project : 631828 Mode : 52</p>	 <p>Site : 03CH11-HY Condition : FCC CLASS-B_BAND 4 3m 9170 SHF HORM_150809 VERTICAL Detector : Peak Project : 631828 Mode : 52</p>

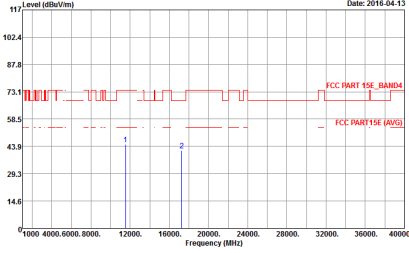
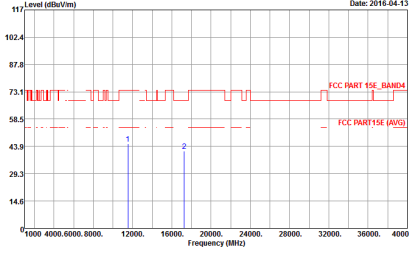

**Band 4 5725~5850MHz  
WIFI 802.11n HT40 (Harmonic @ 3m)**

WIFI	Band 4 5725~5850MHz Harmonic @ 3m	
ANT	802.11n HT40 CH151 5755MHz	
1+2	Horizontal	Vertical
<p><b>Peak</b></p> <p><b>Avg.</b></p>	 <p>Site : 03CH11-HY Condition : FCC PART 15E_BAND4 3m 9170 SHF HORM_150809 HORIZONTAL Detector : Peak Project : 631828 Mode : 53</p>	 <p>Site : 03CH11-HY Condition : FCC PART 15E_BAND4 3m 9170 SHF HORM_150809 VERTICAL Detector : Peak Project : 631828 Mode : 53</p>

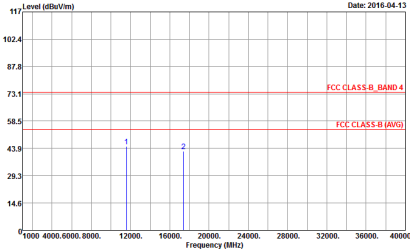
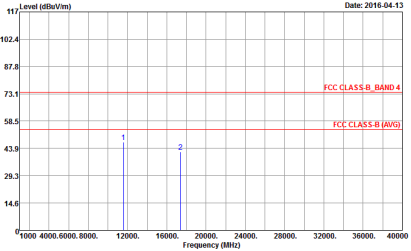

<b>WIFI</b>	<b>Band 4 5725-5850MHz Harmonic @ 3m</b>	
<b>ANT</b>	<b>802.11n HT40 CH159 5795MHz</b>	
<b>1+2</b>	<b>Horizontal</b>	<b>Vertical</b>
<b>Peak Avg.</b>	 <p>Site : 03CH11-HY          Condition : FCC CLASS-B_BAND 4 3m 9170 SHF HORM_150809 HORIZONTAL          Detector : Peak          Project : 631828          Mode : 54</p>	 <p>Site : 03CH11-HY          Condition : FCC CLASS-B_BAND 4 3m 9170 SHF HORM_150809 VERTICAL          Detector : Peak          Project : 631828          Mode : 54</p>

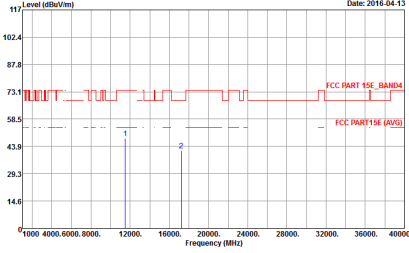
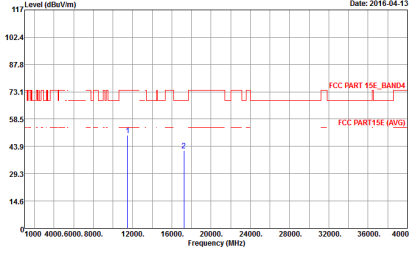

**Band 4 5725~5850MHz  
WIFI 802.11ac VHT20 (Harmonic @ 3m)**

WIFI	Band 4 5725~5850MHz Harmonic @ 3m	
ANT	802.11ac VHT20 CH149 5745MHz	
1+2	Horizontal	Vertical
<p><b>Peak</b></p> <p><b>Avg.</b></p>	 <p>Site : 03CH11-HY Condition : FCC PART 15E_BAND4 3m 9170 SHF HORM_150809 HORIZONTAL Detector : Peak Project : 631828 Mode : 55</p>	 <p>Site : 03CH11-HY Condition : FCC PART 15E_BAND4 3m 9170 SHF HORM_150809 VERTICAL Detector : Peak Project : 631828 Mode : 55</p>

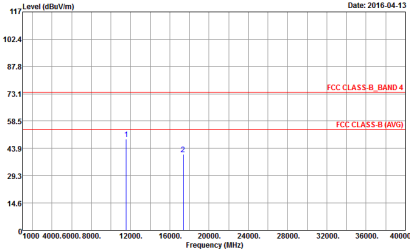
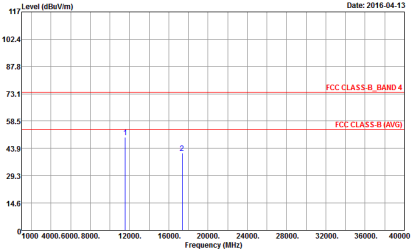

WIFI	Band 4 5725-5850MHz Harmonic @ 3m	
ANT	802.11ac VHT20 CH157 5785MHz	
1+2	Horizontal	Vertical
Peak Avg.	 <p>Site : 03CH11-HY Condition : FCC CLASS-B_BAND 4 3m 9170 SHF HORM_150809 HORIZONTAL Detector : Peak Project : 631828 Mode : 56</p>	 <p>Site : 03CH11-HY Condition : FCC CLASS-B_BAND 4 3m 9170 SHF HORM_150809 VERTICAL Detector : Peak Project : 631828 Mode : 56</p>



WIFI	Band 4 5725-5850MHz Harmonic @ 3m	
ANT	802.11ac VHT20 CH165 5825MHz	
1+2	Horizontal	Vertical
Peak Avg.	<p>Site : 03CH11-HY Condition : FCC CLASS-B_BAND 4 3m 9170 SHF HORM_150809 HORIZONTAL Detector : Peak Project : 631828 Mode : 57</p>	<p>Site : 03CH11-HY Condition : FCC CLASS-B_BAND 4 3m 9170 SHF HORM_150809 VERTICAL Detector : Peak Project : 631828 Mode : 57</p>



Band 4 5725~5850MHz
WIFI 802.11ac VHT40 (Harmonic @ 3m)

Table with 2 main columns: Horizontal and Vertical. Each column contains a spectral plot of Level (dBuV/m) vs Frequency (MHz) and associated test parameters like Site, Condition, Detector, Project, and Mode.



WIFI	Band 4 5725-5850MHz Harmonic @ 3m	
ANT	802.11ac VHT40 CH159 5795MHz	
1+2	Horizontal	Vertical
Peak Avg.	<p>Site : 03CH11-HY Condition : FCC CLASS-B 3m 9170 SHF HORM_150809 HORIZONTAL Detector : Peak Project : 631828 Mode : 59</p>	<p>Site : 03CH11-HY Condition : FCC CLASS-B 3m 9170 SHF HORM_150809 VERTICAL Detector : Peak Project : 631828 Mode : 59</p>

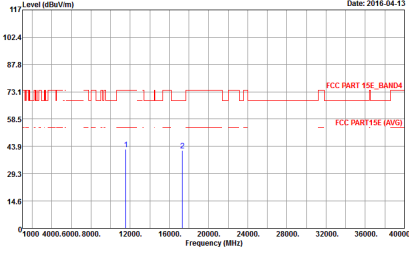
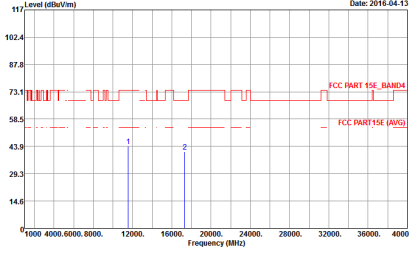

**Band 4 5725~5850MHz  
WIFI 802.11ac VHT80 (Harmonic @ 3m)**

WIFI	Band 4 5725~5850MHz Harmonic @ 3m	
ANT	802.11ac VHT80 CH155 5775MHz	
1+2	Horizontal	Vertical
<p><b>Peak</b> <b>Avg.</b></p>	 <p>Site : 03CH11-HY Condition : FCC PART 15E_BAND4 3m 9170 SHF HORM_150809 HORIZONTAL Detector : Peak Project : 631828 Mode : 60</p>	 <p>Site : 03CH11-HY Condition : FCC PART 15E_BAND4 3m 9170 SHF HORM_150809 VERTICAL Detector : Peak Project : 631828 Mode : 60</p>

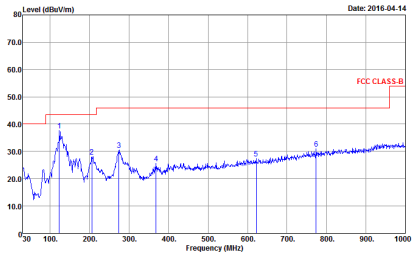
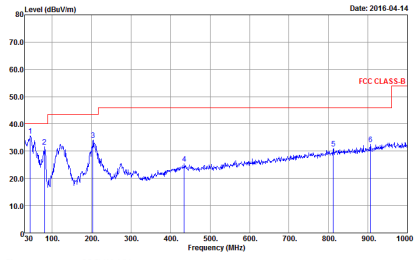

Emission below 1GHz  
5GHz WIFI 802.11ac VHT80 (LF)

WIFI	5GHz 5725~5850MHz	
ANT	802.11ac VHT80 LF	
1+2	Horizontal	Vertical
QP / Peak	 <p>Site : 03CH11-HY Condition : FCC CLASS-B 3m BI-LOG 6111D-LF_ETC HORIZONTAL Detector : Peak Project : 631828 Mode : 61</p>	 <p>Site : 03CH11-HY Condition : FCC CLASS-B 3m BI-LOG 6111D-LF_ETC VERTICAL Detector : Peak Project : 631828 Mode : 61</p>



## Appendix D. Duty Cycle Plots

Antenna	Band	Duty Cycle(%)	T(us)	1/T(kHz)	VBW Setting
1+2	5GHz 802.11a for Ant 1	94.95	2070	0.483091787	1kHz
1+2	5GHz 802.11a for Ant 2	94.95	2070	0.483091787	1kHz
1+2	5GHz 802.11n HT20 for Ant 1	94.94	2065	0.484261501	1kHz
1+2	5GHz 802.11n HT20 for Ant 2	94.95	2070	0.483091787	1kHz
1+2	5GHz 802.11n HT40 for Ant 1	90.48	950	1.052631579	3kHz
1+2	5GHz 802.11n HT40 for Ant 2	89.62	950	1.052631579	3kHz
1+2	5GHz 802.11ac VHT20 for Ant 1	95.09	1935	0.516795866	1kHz
1+2	5GHz 802.11ac VHT20 for Ant 2	94.63	1940	0.515463918	1kHz
1+2	5GHz 802.11ac VHT40 for Ant 1	90.52	955	1.047120419	3kHz
1+2	5GHz 802.11ac VHT40 for Ant 2	94.48	950	1.052631579	3kHz
1+2	5GHz 802.11ac VHT80 for Ant 1	82.14	460	2.173913043	3kHz
1+2	5GHz 802.11ac VHT80 for Ant 2	82.14	460	2.173913043	3kHz

### MIMO <Ant. 1+2(1)>

#### 802.11a

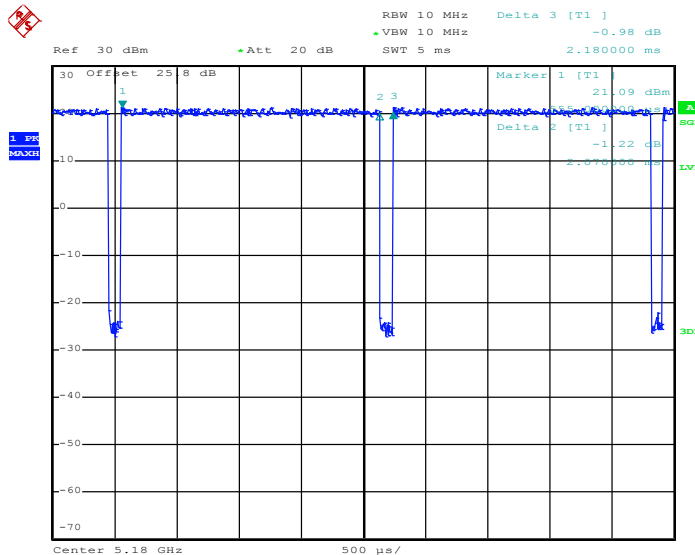

Date: 7.APR.2016 21:07:55



802.11n HT20

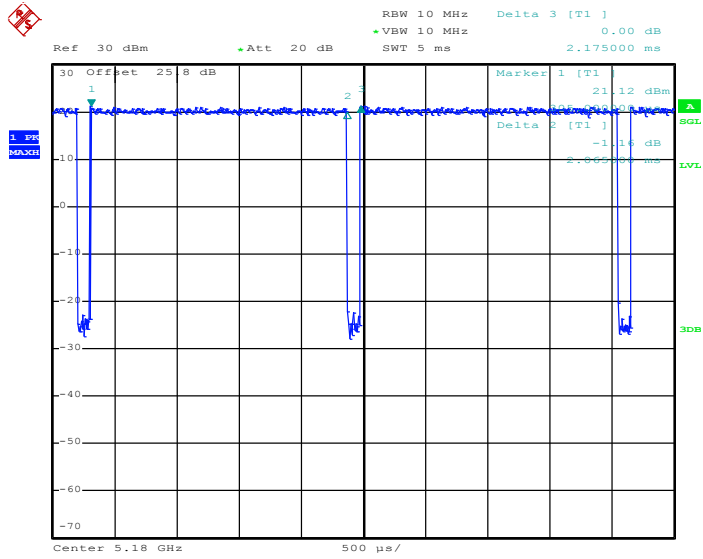

Date: 7.APR.2016 21:12:49

802.11n HT40

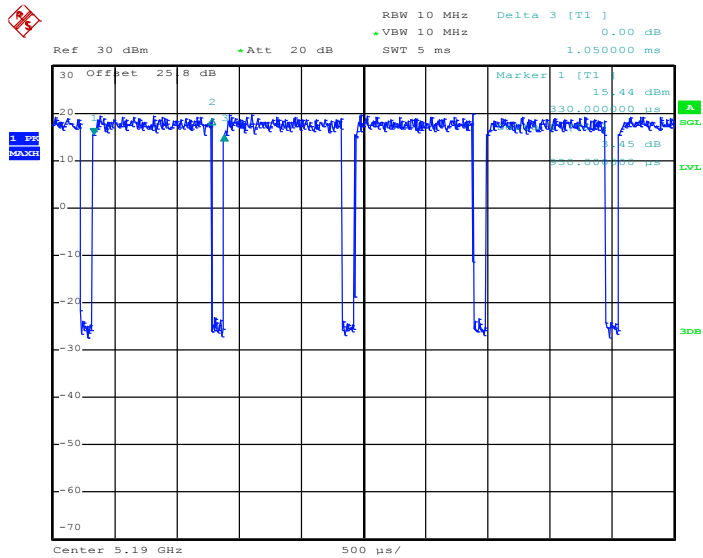

Date: 7.APR.2016 21:16:44





802.11ac VHT80

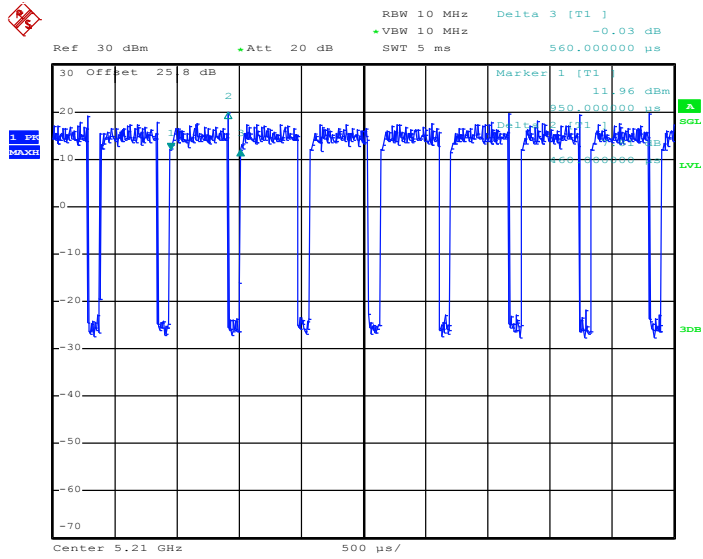

Date: 7.APR.2016 21:44:40



MIMO <Ant. 1+2(2)>

802.11a

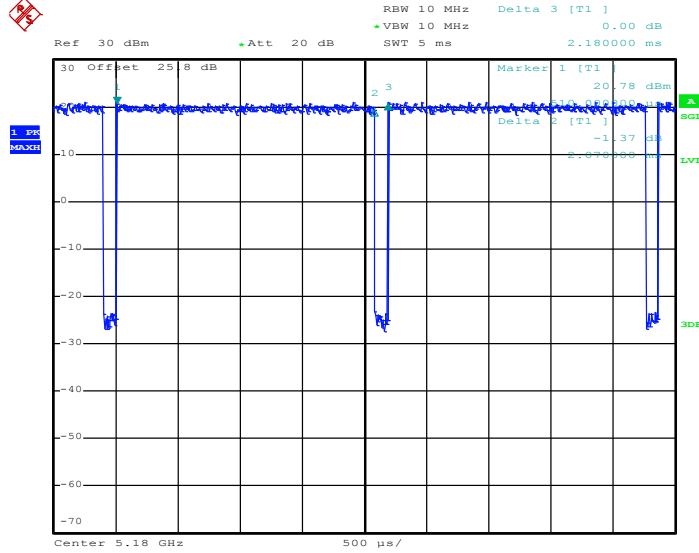

Date: 7.APR.2016 21:08:56

802.11n HT20

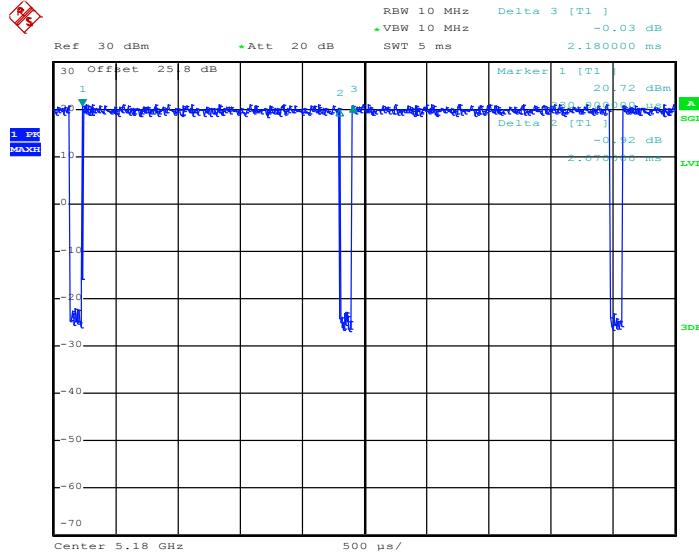

Date: 7.APR.2016 21:13:44



802.11n HT40

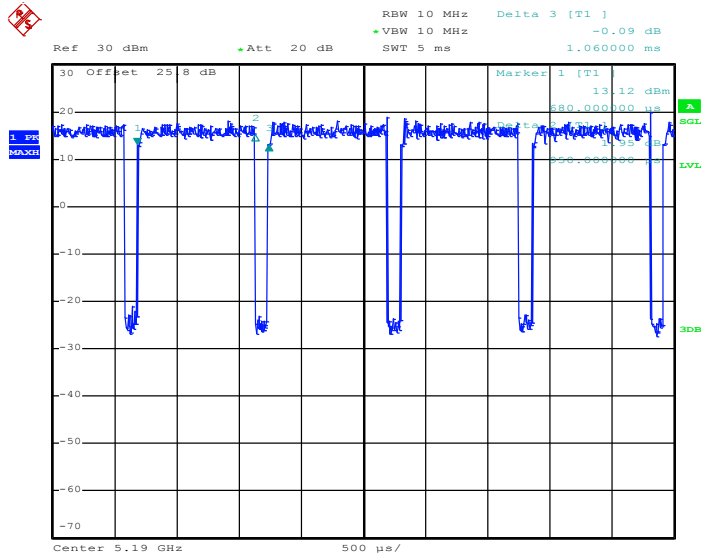

Date: 7.APR.2016 21:17:37

802.11ac VHT20

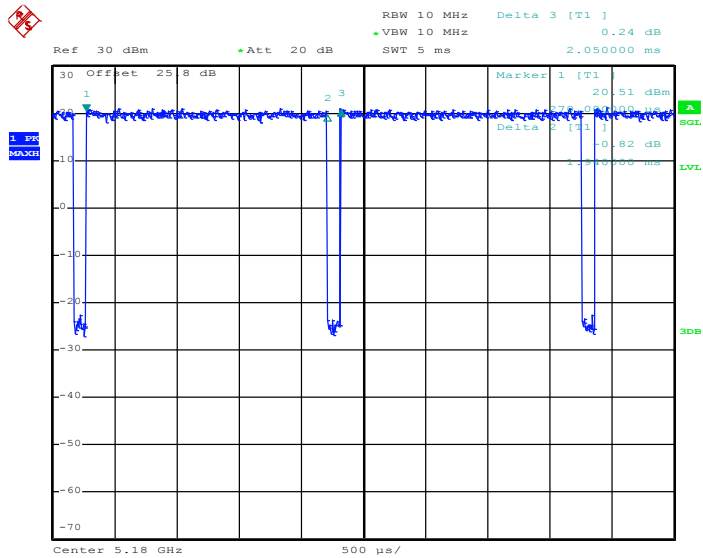

Date: 7.APR.2016 21:21:51



802.11ac VHT40

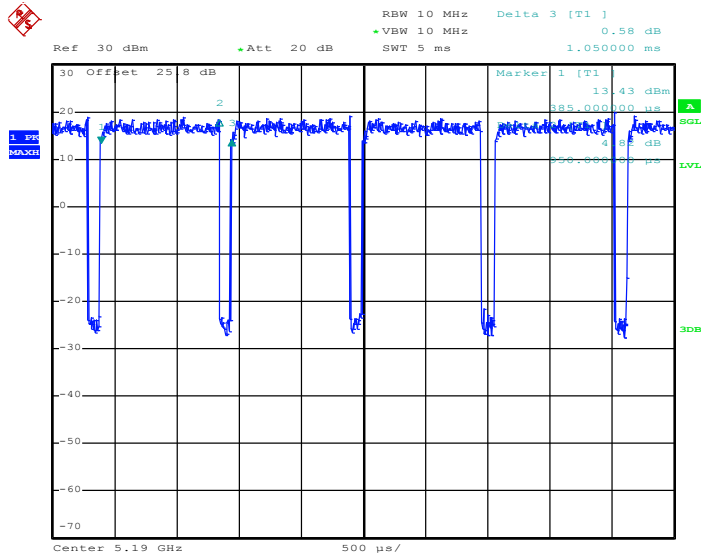

Date: 7.APR.2016 21:29:43

802.11ac VHT80

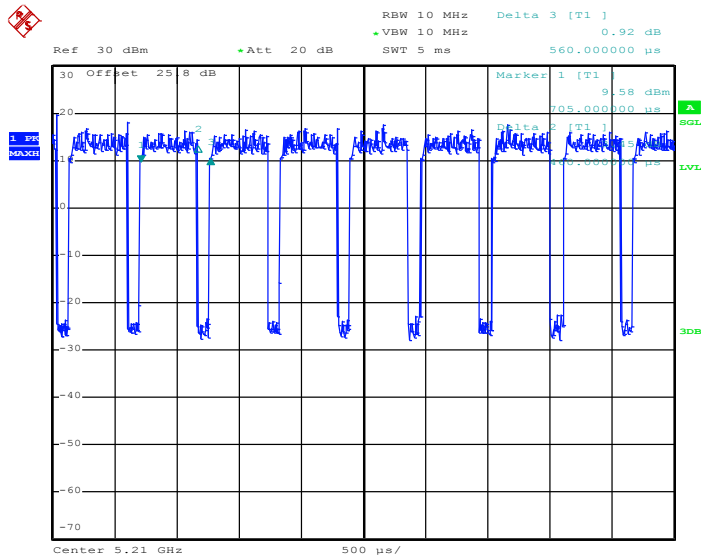

Date: 7.APR.2016 21:43:57