



FCC RF Test Report

APPLICANT : Motorola Mobility, LLC
EQUIPMENT : Mobile Cellular Phone
BRAND NAME : Motorola
MODEL NAME : 4237
FCC ID : IHDT56VB1
STANDARD : FCC 47 CFR Part 2, 22(H), 24(E)
CLASSIFICATION : PCS Licensed Transmitter Held to Ear (PCE)

This is a variant report which is only valid together with the original test report. The product was received on May 17, 2016 and testing was completed on May 19, 2016. We, SPORTON INTERNATIONAL INC., would like to declare that the tested sample has been evaluated in accordance with the test procedures given in ANSI / TIA / EIA-603-D-2010 and has been in compliance with the applicable technical standards.

The test results in this report apply exclusively to the tested model / sample. Without written approval of SPORTON INTERNATIONAL INC., the test report shall not be reproduced except in full.

Reviewed by: Joseph Lin / Supervisor

Approved by: Jones Tsai / Manager



SPORTON INTERNATIONAL INC.

No. 52, Hwa Ya 1st Rd., Hwa Ya Technology Park, Kwei-Shan District, Tao Yuan City, Taiwan, R.O.C.



TABLE OF CONTENTS

REVISION HISTORY..... 3

SUMMARY OF TEST RESULT 4

1 GENERAL DESCRIPTION 5

 1.1 Applicant..... 5

 1.2 Manufacturer 5

 1.3 Product Feature of Equipment Under Test 5

 1.4 Product Specification of Equipment Under Test 6

 1.5 Modification of EUT 6

 1.6 Testing Location 7

 1.7 Applicable Standards 7

2 TEST CONFIGURATION OF EQUIPMENT UNDER TEST 8

 2.1 Test Mode..... 8

 2.2 Connection Diagram of Test System 9

 2.3 Support Unit used in test configuration 10

3 RADIATED TEST ITEMS 11

 3.1 Measuring Instruments..... 11

 3.2 Test Setup 11

 3.3 Test Result of Radiated Test..... 11

 3.4 Field Strength of Spurious Radiation Measurement 12

4 LIST OF MEASURING EQUIPMENT 13

5 UNCERTAINTY OF EVALUATION 14

APPENDIX A. TEST RESULTS OF RADIATED TEST

APPENDIX B. ORIGINAL REPORT



SUMMARY OF TEST RESULT

Report Section	FCC Rule	Description	Limit	Result	Remark
3.4	§2.1053 §22.917(a)	Field Strength of Spurious Radiation	$< 43+10\log_{10}(P[\text{Watts}])$	PASS	Under limit 37.94 dB at 2476.000 MHz



1 General Description

1.1 Applicant

Motorola Mobility, LLC

222 W Merchandise Mart Plaza, Suite 1800, Chicago, IL 60654, United States

1.2 Manufacturer

Motorola Mobility, LLC

222 W Merchandise Mart Plaza, Suite 1800, Chicago, IL 60654, United States

1.3 Product Feature of Equipment Under Test

Product Feature	
Equipment	Mobile Cellular Phone
Brand Name	Motorola
Model Name	4237
FCC ID	IHDT56VB1
IMEI Code	354107070048645
EUT supports Radios application	CDMA/EV-DO/GSM/EGPRS/WCDMA/HSPA/LTE/NFC WLAN 11b/g/n HT20/VHT20 WLAN 11a/n HT20/HT40 WLAN 11ac VHT20/VHT40/VHT80 Bluetooth v3.0 EDR Bluetooth v4.2 LE
HW Version	DVT2
EUT Stage	Identical Prototype

Remark: The above EUT's information was declared by manufacturer. Please refer to the specifications or user's manual for more detailed description.

Accessory List	
WPC Cover	Brand Name : INCIPIO
	Model Name : MT-043-CASE



1.4 Product Specification of Equipment Under Test

Standards-related Product Specification	
Tx Frequency	GSM/GPRS/EDGE: 850: 824.2 MHz ~ 848.8 MHz 1900: 1850.2 MHz ~ 1909.8MHz WCDMA: Band V: 826.4 MHz ~ 846.6 MHz Band II: 1852.4 MHz ~ 1907.6 MHz CDMA2000: BC0: 824.70 MHz ~ 848.31 MHz BC1: 1851.25 MHz ~ 1908.75 MHz
Rx Frequency	GSM/GPRS/EDGE: 850: 869.2 MHz ~ 893.8 MHz 1900: 1930.2 MHz ~ 1989.8 MHz WCDMA: Band V: 871.4 MHz ~ 891.6 MHz Band II: 1932.4 MHz ~ 1987.6 MHz CDMA2000: BC0: 869.70 MHz ~ 893.31 MHz BC1: 1931.25 MHz ~ 1988.75 MHz
Antenna Type	Fixed Internal Antenna
Type of Modulation	GSM: GMSK GPRS: GMSK EDGE: GMSK / 8PSK WCDMA: QPSK (Uplink) HSDPA: QPSK (Uplink) HSUPA: QPSK (Uplink) CDMA2000 1xRTT: QPSK CDMA2000 1xEV-DO: QPSK/8PSK

1.5 Modification of EUT

No modifications are made to the EUT during all test items.



1.6 Testing Location

Sporton Lab is accredited to ISO 17025 by Taiwan Accreditation Foundation (TAF code : 1190) and the FCC designation No. TW1022 under the FCC 2.948(e) by Mutual Recognition Agreement (MRA) in FCC Test.

Test Site	SPORTON INTERNATIONAL INC.
Test Site Location	No. 52, Hwa Ya 1 st Rd., Hwa Ya Technology Park, Kwei-Shan District, Tao Yuan City, Taiwan, R.O.C. TEL: +886-3-327-3456 FAX: +886-3-328-4978
Test Site No.	Sporton Site No. 03CH07-HY

1.7 Applicable Standards

According to the specifications of the manufacturer, the EUT must comply with the requirements of the following standards:

- ♦ 47 CFR Part 2, 22(H), 24(E)
- ♦ ANSI / TIA / EIA-603-D-2010
- ♦ FCC KDB 971168 D01 Power Meas. License Digital Systems v02r02
- ♦ KDB 648474 D03 Handset Wireless Chargers Battery Covers v01r04

Remark:

1. All test items were verified and recorded according to the standards and without any deviation during the test.
2. This EUT has also been tested and complied with the requirements of FCC Part 15, Subpart B, recorded in a separate test report.



2 Test Configuration of Equipment Under Test

2.1 Test Mode

Antenna port conducted and radiated test items were performed according to KDB 971168 D01 Power Meas. License Digital Systems v02r02 with maximum output power.

Radiated measurements were performed with rotating EUT in different three orthogonal test planes to find the maximum emission.

Radiated emissions were investigated as following frequency range:

1. 30 MHz to 9000 MHz for GSM850.

All modes and data rates and positions were investigated.

Test modes are chosen to be reported as the worst case configuration below:

Test Modes	
Band	Radiated TCs
GSM 850	■ GPRS class 8 Link with WPC Charging
	■ GPRS class 8 Link with PMA Charging

2.2 Connection Diagram of Test System

<WPC Charging Mode>

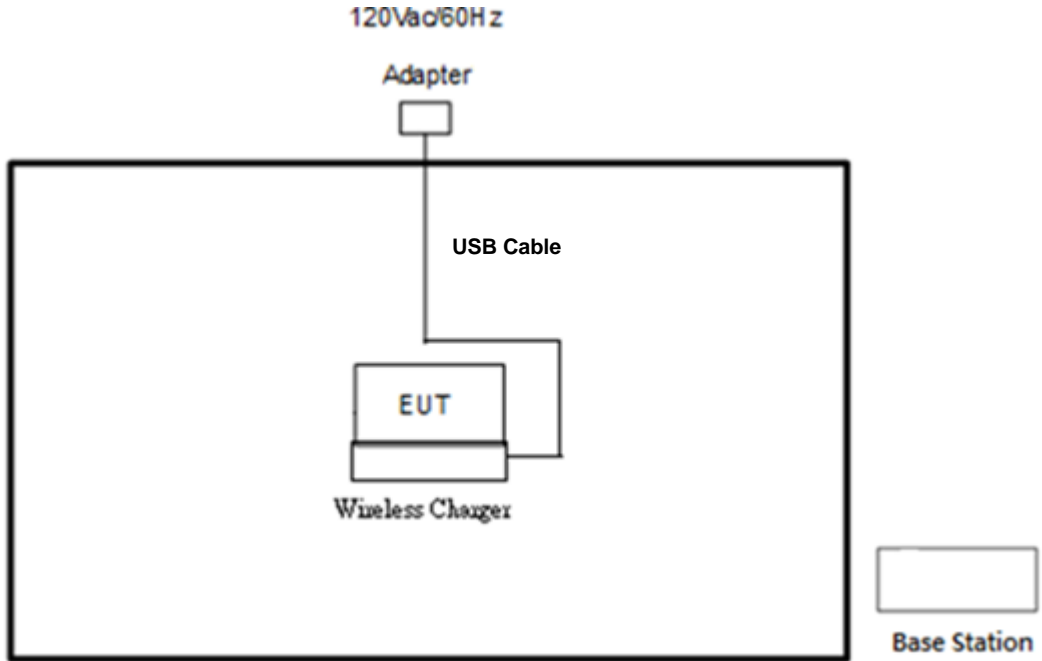

<PMA Charging Mode>

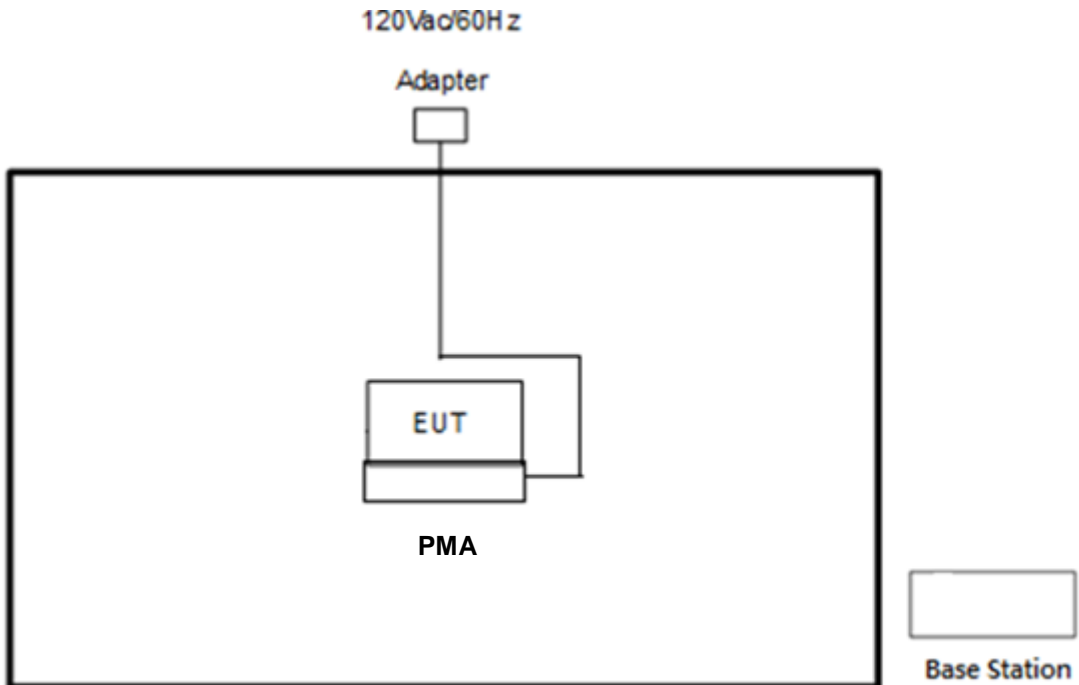



2.3 Support Unit used in test configuration

Item	Equipment	Trade Name	Model No.	FCC ID	Data Cable	Power Cord
1.	System Simulator	R&S	CMU 200	N/A	N/A	Unshielded, 1.8 m
2.	Wireless Charger	LG	WCD-100	FCC DoC	N/A	N/A
3.	PMA	DURACELL	M-018B-518A	FCC DoC	N/A	N/A
4.	USB Cable	Motorola	SKN6461A	N/A	Unshielded, 1.0 m	N/A
5.	Adapter	Motorola	SPN5865A	N/A	N/A	N/A

3 Radiated Test Items

3.1 Measuring Instruments

See list of measuring instruments of this test report.

3.2 Test Setup

3.2.1 For radiated test from 30MHz to 1GHz

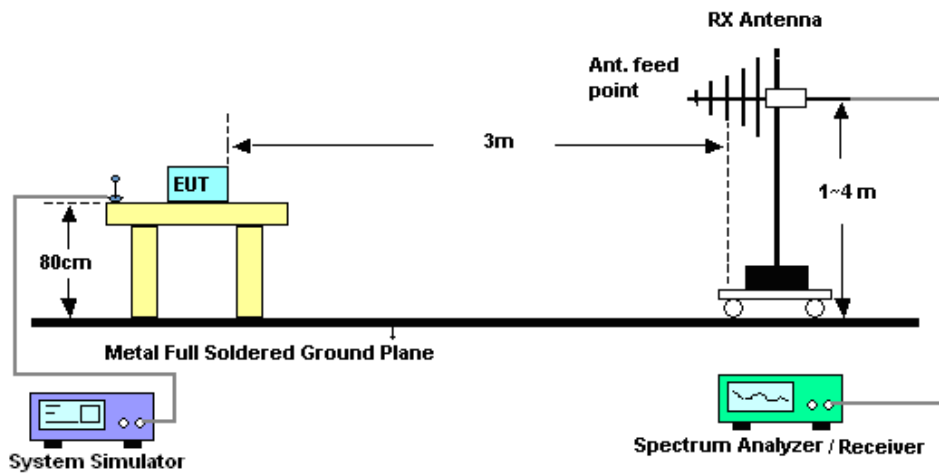

3.2.2 For radiated test above 1GHz

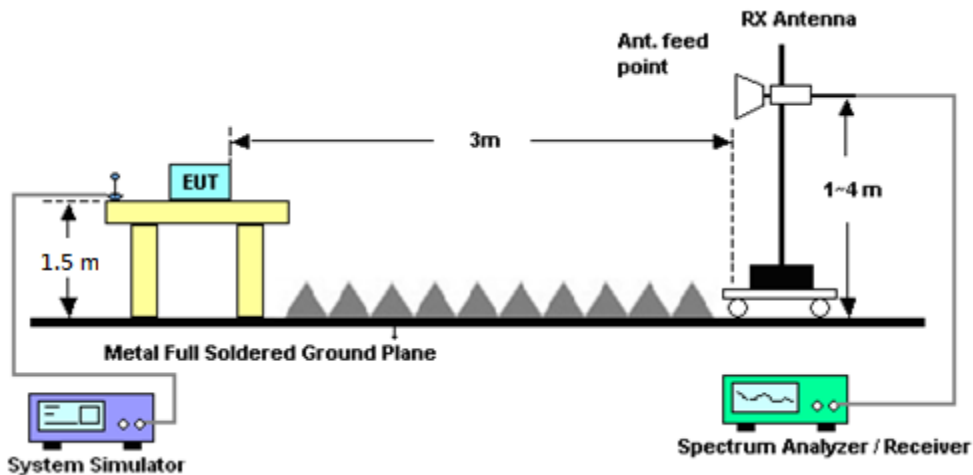

3.3 Test Result of Radiated Test

Please refer to Appendix A.



3.4 Field Strength of Spurious Radiation Measurement

3.4.1 Description of Field Strength of Spurious Radiated Measurement

The power of any emission outside of the authorized operating frequency ranges must be attenuated below the transmitter power (P) by a factor of at least $43 + 10 \log (P)$ dB. The spectrum is scanned from 30 MHz up to a frequency including its 10th harmonic.

3.4.2 Test Procedures

1. The testing follows FCC KDB 971168 D01 v02r02 Section 5.8 and ANSI / TIA-603-D-2010 Section 2.2.12.
2. The EUT was placed on a rotatable wooden table 0.8 meters for frequency below 1GHz and 1.5 meter for frequency above 1GHz above the ground.
3. The EUT was set 3 meters from the receiving antenna, which was mounted on the antenna tower.
4. The table was rotated 360 degrees to determine the position of the highest spurious emission.
5. The height of the receiving antenna is varied between one meter and four meters to search for the maximum spurious emission for both horizontal and vertical polarizations.
6. Make the measurement with the spectrum analyzer's RBW = 1MHz, VBW = 3MHz, taking record of maximum spurious emission.
7. A horn antenna was substituted in place of the EUT and was driven by a signal generator.
8. Tune the output power of signal generator to the same emission level with EUT maximum spurious emission.
9. Taking the record of output power at antenna port.
10. Repeat step 7 to step 8 for another polarization.
11. $EIRP \text{ (dBm)} = S.G. \text{ Power} - Tx \text{ Cable Loss} + Tx \text{ Antenna Gain}$
12. $ERP \text{ (dBm)} = EIRP - 2.15$
13. The RF fundamental frequency should be excluded against the limit line in the operating frequency band.
14. The limit line is derived from $43 + 10\log(P)$ dB below the transmitter power P(Watts)
 $= P(W) - [43 + 10\log(P)] \text{ (dB)}$
 $= [30 + 10\log(P)] \text{ (dBm)} - [43 + 10\log(P)] \text{ (dB)}$
 $= -13\text{dBm}.$



4 List of Measuring Equipment

Instrument	Manufacturer	Model No.	Serial No.	Characteristics	Calibration Date	Test Date	Due Date	Remark
Bilog Antenna	TESEQ	CBL 6111D	35419	30MHz to 1GHz	Jan. 13, 2016	May 19, 2016	Jan. 12, 2017	Radiation (03CH07-HY)
Double Ridge Horn Antenna	ESCO	3117	00075962	1GHz ~ 18GHz	Aug. 21, 2015	May 19, 2016	Aug. 20, 2016	Radiation (03CH07-HY)
EMI Test Receiver	Keysight	N9038A(MXE)	MY54130085	20Hz ~ 8.4GHz	Nov. 04, 2015	May 19, 2016	Nov. 03, 2016	Radiation (03CH07-HY)
Preamplifier	MITEQ	AMF-7D-00101800-30-1	1590075	1GHz ~ 18GHz	Apr. 15, 2016	May 19, 2016	Apr. 14, 2017	Radiation (03CH07-HY)
Preamplifier	COM-POWER	PA-103A	161241	10MHz-1GHz	Mar. 18, 2016	May 19, 2016	Mar. 17, 2017	Radiation (03CH07-HY)
Spectrum Analyzer	Agilent	N9010A	MY53470118	10Hz~44GHz	Feb. 27, 2016	May 19, 2016	Feb. 26, 2017	Radiation (03CH07-HY)
Antenna Mast	Max-Full	MFA520BS	N/A	1m~4m	N/A	May 19, 2016	N/A	Radiation (03CH07-HY)
Turn Table	ChainTek	Chaintek 3000	N/A	0~360 Degree	N/A	May 19, 2016	N/A	Radiation (03CH07-HY)
Horn Antenna	SCHWARZBECK	BBHA 9120D	9120D-1328	1GHz ~ 18GHz	Nov. 02, 2015	May 19, 2016	Nov. 01, 2016	Radiation (03CH07-HY)
Preamplifier	MITEQ	JS44-18004000-33-8P	1840917	18GHz ~ 40GHz	Jun. 02, 2015	May 19, 2016	Jun. 01, 2016	Radiation (03CH07-HY)
SHF-EHF Horn Antenna	SCHWARZBECK	BBHA 9170	BBHA9170584	18GHz- 40GHz	Nov. 02, 2015	May 19, 2016	Nov. 01, 2016	Radiation (03CH07-HY)
Signal Generator	Rohde & Schwarz	SMF100A	101107	100kHz~40GHz	May 22, 2015	May 19, 2016	May 21, 2016	Radiation (03CH07-HY)



5 Uncertainty of Evaluation

Uncertainty of Radiated Emission Measurement (30 MHz ~ 1000 MHz)

Measuring Uncertainty for a Level of Confidence of 95% ($U = 2Uc(y)$)	5.60
---	------



Appendix A. Test Results of Radiated Test

Radiated Spurious Emission

<PMA Charging Mode>

GSM850 (GPRS class 8)									
Channel	Frequency (MHz)	ERP (dBm)	Limit (dBm)	Over Limit (dB)	SPA Reading (dBm)	S.G. Power (dBm)	TX Cable loss (dB)	TX Antenna Gain (dBi)	Polarization (H/V)
Lowest	1651	-58.11	-13	-45.11	-45.69	-59.86	0.98	4.88	H
	2476	-54.34	-13	-41.34	-47.37	-56.23	1.28	5.33	H
	3301	-62.27	-13	-49.27	-57.32	-65.7	1.54	7.12	H
									H
	1651	-61.89	-13	-48.89	-49.88	-63.64	0.98	4.88	V
	2476	-54.92	-13	-41.92	-48.35	-56.81	1.28	5.33	V
	3301	-59.46	-13	-46.46	-54.84	-62.89	1.54	7.12	V
									V

Remark: Spurious emissions within 30-1000MHz were found more than 20dB below limit line.

<WPC Charging Mode>

GSM850 (GPRS class 8)									
Channel	Frequency (MHz)	ERP (dBm)	Limit (dBm)	Over Limit (dB)	SPA Reading (dBm)	S.G. Power (dBm)	TX Cable loss (dB)	TX Antenna Gain (dBi)	Polarization (H/V)
Lowest	1651	-57.56	-13	-44.56	-45.12	-59.31	0.98	4.88	H
	2476	-56.84	-13	-43.84	-49.87	-58.73	1.28	5.33	H
	3301	-61.44	-13	-48.44	-56.48	-64.87	1.54	7.12	H
									H
	1651	-51.86	-13	-38.86	-39.88	-53.61	0.98	4.88	V
	2476	-50.94	-13	-37.94	-44.37	-52.83	1.28	5.33	V
	3301	-63.09	-13	-50.09	-58.48	-66.52	1.54	7.12	V
									V

Remark: Spurious emissions within 30-1000MHz were found more than 20dB below limit line.



Appendix B. Original Report

Please refer to Sporton report number FG631828A as below.



FCC RF Test Report

APPLICANT : Motorola Mobility, LLC
EQUIPMENT : Mobile Cellular Phone
BRAND NAME : Motorola
MODEL NAME : 4237
FCC ID : IHDT56VB1
STANDARD : FCC 47 CFR Part 2, 22(H), 24(E)
CLASSIFICATION : PCS Licensed Transmitter Held to Ear (PCE)

The product was received on Mar. 18, 2016 and testing was completed on Apr. 13, 2016. We, SPORTON INTERNATIONAL INC., would like to declare that the tested sample has been evaluated in accordance with the test procedures given in ANSI / TIA / EIA-603-D-2010 and has been in compliance with the applicable technical standards.

The test results in this report apply exclusively to the tested model / sample. Without written approval of SPORTON INTERNATIONAL INC., the test report shall not be reproduced except in full.

Reviewed by: Joseph Lin / Supervisor

Approved by: Jones Tsai / Manager



SPORTON INTERNATIONAL INC.

No. 52, Hwa Ya 1st Rd., Hwa Ya Technology Park, Kwei-Shan District, Tao Yuan City, Taiwan, R.O.C.



TABLE OF CONTENTS

REVISION HISTORY..... 3

SUMMARY OF TEST RESULT 4

1 GENERAL DESCRIPTION 5

 1.1 Applicant..... 5

 1.2 Manufacturer 5

 1.3 Product Feature of Equipment Under Test 5

 1.4 Product Specification of Equipment Under Test 6

 1.5 Modification of EUT 6

 1.6 Maximum ERP/EIRP Power, Frequency Tolerance, and Emission Designator 7

 1.7 Testing Location 8

 1.8 Applicable Standards 8

2 TEST CONFIGURATION OF EQUIPMENT UNDER TEST 9

 2.1 Test Mode..... 9

 2.2 Connection Diagram of Test System 10

 2.3 Support Unit used in test configuration 10

 2.4 Measurement Results Explanation Example 10

3 CONDUCTED TEST RESULT..... 11

 3.1 Measuring Instruments..... 11

 3.2 Test Setup 11

 3.3 Test Result of Conducted Test..... 11

 3.4 Conducted Output Power 12

 3.5 Peak-to-Average Ratio 13

 3.6 99% Occupied Bandwidth and 26dB Bandwidth Measurement..... 14

 3.7 Conducted Band Edge 15

 3.8 Conducted Spurious Emission 16

 3.9 Frequency Stability..... 17

4 RADIATED TEST ITEMS 18

 4.1 Measuring Instruments..... 18

 4.2 Test Setup 18

 4.3 Test Result of Radiated Test..... 18

 4.4 Effective Radiated Power and Effective Isotropic Radiated Power Measurement 19

 4.5 Field Strength of Spurious Radiation Measurement 21

5 LIST OF MEASURING EQUIPMENT 22

6 UNCERTAINTY OF EVALUATION 23

APPENDIX A. TEST RESULTS OF CONDUCTED TEST

APPENDIX B. TEST RESULTS OF RADIATED TEST



SUMMARY OF TEST RESULT

Report Section	FCC Rule	Description	Limit	Result	Remark
3.4	§2.1046	Conducted Output Power	Reporting Only	PASS	-
3.5	§24.232(d)	Peak-to-Average Ratio	< 13 dB	PASS	-
3.6	§2.1049 §22.917(b) §24.238(b)	Occupied Bandwidth	Reporting Only	PASS	-
3.7	§2.1051 §22.917(a) §24.238(a)	Band Edge Measurement	< 43+10log10(P[Watts])	PASS	-
3.8	§2.1051 §22.917(a) §24.238(a)	Conducted Emission	< 43+10log10(P[Watts])	PASS	-
3.9	§2.1055 §22.355	Frequency Stability for Temperature & Voltage	< 2.5 ppm for Part 22	PASS	-
	§2.1055 §24.235		Within Authorized Band		
4.4	§22.913(a)(2)	Effective Radiated Power	< 7 Watts	PASS	-
	§24.232(c)	Equivalent Isotropic Radiated Power	< 2 Watts	PASS	-
4.5	§2.1053 §22.917(a) §24.238(a)	Field Strength of Spurious Radiation	< 43+10log10(P[Watts])	PASS	Under limit 18.04 dB at 1648.000 MHz



1 General Description

1.1 Applicant

Motorola Mobility, LLC

222 W Merchandise Mart Plaza, Suite 1800, Chicago, IL 60654, United States

1.2 Manufacturer

Motorola Mobility, LLC

222 W Merchandise Mart Plaza, Suite 1800, Chicago, IL 60654, United States

1.3 Product Feature of Equipment Under Test

Product Feature	
Equipment	Mobile Cellular Phone
Brand Name	Motorola
Model Name	4237
FCC ID	IHDT56VB1
IMEI Code	354107070048645 for Radiation 354107070048777 for Conducted
EUT supports Radios application	CDMA/EV-DO/GSM/EGPRS/WCDMA/HSPA/LTE/NFC WLAN 11b/g/n HT20/VHT20 WLAN 11a/n HT20/HT40 WLAN 11ac VHT20/VHT40/VHT80 Bluetooth v3.0 EDR Bluetooth v4.2 LE
HW Version	DVT2
EUT Stage	Identical Prototype

Remark: The above EUT's information was declared by manufacturer. Please refer to the specifications or user's manual for more detailed description.

Accessory List	
AC Adapter	Brand Name : Motorola
	Model Name : SPN5913A
Earphone	Brand Name : Motorola
	Model Name : SJYN1305A



1.4 Product Specification of Equipment Under Test

Standards-related Product Specification	
Tx Frequency	GSM/GPRS/EDGE: 850: 824.2 MHz ~ 848.8 MHz 1900: 1850.2 MHz ~ 1909.8MHz WCDMA: Band V: 826.4 MHz ~ 846.6 MHz Band II: 1852.4 MHz ~ 1907.6 MHz CDMA2000: BC0: 824.70 MHz ~ 848.31 MHz BC1: 1851.25 MHz ~ 1908.75 MHz
Rx Frequency	GSM/GPRS/EDGE: 850: 869.2 MHz ~ 893.8 MHz 1900: 1930.2 MHz ~ 1989.8 MHz WCDMA: Band V: 871.4 MHz ~ 891.6 MHz Band II: 1932.4 MHz ~ 1987.6 MHz CDMA2000: BC0: 869.70 MHz ~ 893.31 MHz BC1: 1931.25 MHz ~ 1988.75 MHz
Antenna Type	Fixed Internal Antenna
Type of Modulation	GSM: GMSK GPRS: GMSK EDGE: GMSK / 8PSK WCDMA: QPSK (Uplink) HSDPA: QPSK (Uplink) HSUPA: QPSK (Uplink) CDMA2000 1xRTT: QPSK CDMA2000 1xEV-DO: QPSK/8PSK

1.5 Modification of EUT

No modifications are made to the EUT during all test items.



1.6 Maximum ERP/EIRP Power, Frequency Tolerance, and Emission Designator

FCC Rule	System	Type of Modulation	Maximum ERP/EIRP (W)	Frequency Tolerance (ppm)	Emission Designator
Part 22	GSM850 GPRS class 8	GMSK	1.0593	0.0897 ppm	249KGXW
Part 22	GSM850 EDGE class 8	8PSK	0.1603	0.0992 ppm	246KG7W
Part 22	WCDMA Band V RMC 12.2Kbps	QPSK	0.1007	0.0155 ppm	4M14F9W
Part 22	CDMA2000 BC0 1xRTT	QPSK	0.0902	0.0203 ppm	1M28F9W
Part 22	CDMA2000 BC0 1xEV-DO Rev. 0	QPSK	0.0726	0.0215 ppm	1M28F9W
Part 24	GSM1900 GPRS class 8	GMSK	1.0940	0.0372 ppm	246KGXW
Part 24	GSM1900 EDGE class 8	8PSK	0.3508	0.0101 ppm	248KG7W
Part 24	WCDMA Band II RMC 12.2Kbps	QPSK	0.2427	0.0021 ppm	4M16F9W
Part 24	CDMA2000 BC1 1xRTT	QPSK	0.2244	0.0106 ppm	1M28F9W
Part 24	CDMA2000 BC1 1xEV-DO Rev. 0	QPSK	0.2547	0.0053 ppm	1M29F9W

1.7 Testing Location

Sporton Lab is accredited to ISO 17025 by Taiwan Accreditation Foundation (TAF code : 1190) and the FCC designation No. TW1022 under the FCC 2.948(e) by Mutual Recognition Agreement (MRA) in FCC Test.

Test Site	SPORTON INTERNATIONAL INC.
Test Site Location	No. 52, Hwa Ya 1 st Rd., Hwa Ya Technology Park, Kwei-Shan District, Tao Yuan City, Taiwan, R.O.C. TEL: +886-3-327-3456 FAX: +886-3-328-4978
Test Site No.	Sporton Site No.
	TH03-HY

Test Site	SPORTON INTERNATIONAL INC.
Test Site Location	No.58, Aly. 75, Ln. 564, Wenhua 3rd Rd. Guishan Dist, Taoyuan City, Taiwan (R.O.C.) TEL: +886-3-327-0868 FAX: +886-3-327-0855
Test Site No.	Sporton Site No.
	03CH12-HY

1.8 Applicable Standards

According to the specifications of the manufacturer, the EUT must comply with the requirements of the following standards:

- 47 CFR Part 2, 22(H), 24(E)
- ANSI / TIA / EIA-603-D-2010
- FCC KDB 971168 D01 Power Meas. License Digital Systems v02r02

Remark:

1. All test items were verified and recorded according to the standards and without any deviation during the test.
2. This EUT has also been tested and complied with the requirements of FCC Part 15, Subpart B, recorded in a separate test report.



2 Test Configuration of Equipment Under Test

2.1 Test Mode

Antenna port conducted and radiated test items were performed according to KDB 971168 D01 Power Meas. License Digital Systems v02r02 with maximum output power.

Radiated measurements were performed with rotating EUT in different three orthogonal test planes to find the maximum emission.

Radiated emissions were investigated as following frequency range:

1. 30 MHz to 9000 MHz for GSM850 and WCDMA Band V and CDMA BC0.
2. 30 MHz to 19000 MHz for GSM1900 and WCDMA Band II and CDMA BC1.

All modes and data rates and positions were investigated.

Test modes are chosen to be reported as the worst case configuration below:

Test Modes		
Band	Radiated TCs	Conducted TCs
GSM 850	<ul style="list-style-type: none"> ■ GPRS class 8 Link ■ EDGE class 8 Link 	<ul style="list-style-type: none"> ■ GPRS class 8 Link ■ EDGE class 8 Link
GSM 1900	<ul style="list-style-type: none"> ■ GPRS class 8 Link ■ EDGE class 8 Link 	<ul style="list-style-type: none"> ■ GPRS class 8 Link ■ EDGE class 8 Link
WCDMA Band V	<ul style="list-style-type: none"> ■ RMC 12.2Kbps Link 	<ul style="list-style-type: none"> ■ RMC 12.2Kbps Link
WCDMA Band II	<ul style="list-style-type: none"> ■ RMC 12.2Kbps Link 	<ul style="list-style-type: none"> ■ RMC 12.2Kbps Link
CDMA BC0	<ul style="list-style-type: none"> ■ 1xRTT Link ■ 1xEV-DO Rev. 0 Link 	<ul style="list-style-type: none"> ■ 1xRTT Link ■ 1xEV-DO Rev. 0 Link
CDMA BC1	<ul style="list-style-type: none"> ■ 1xRTT Link ■ 1xEV-DO Rev. 0 Link 	<ul style="list-style-type: none"> ■ 1xRTT Link ■ 1xEV-DO Rev. 0 Link

2.2 Connection Diagram of Test System

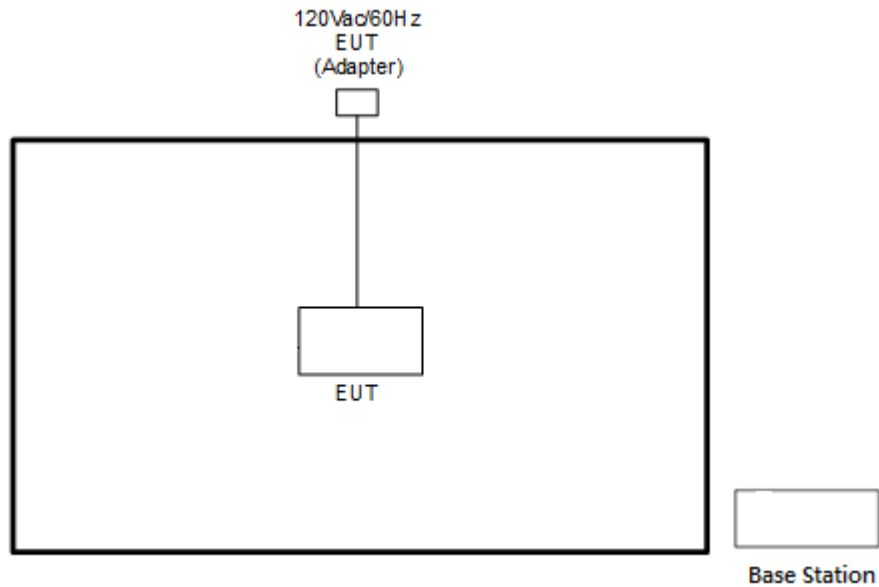

2.3 Support Unit used in test configuration

Item	Equipment	Trade Name	Model No.	FCC ID	Data Cable	Power Cord
1.	System Simulator	R&S	CMU 200	N/A	N/A	Unshielded, 1.8 m

2.4 Measurement Results Explanation Example

For all conducted test items:

The offset level is set in the spectrum analyzer to compensate the RF cable loss and attenuator factor between RF conducted output port and spectrum analyzer. With the offset compensation, the spectrum analyzer reading level will be exactly the RF output level.

The spectrum analyzer offset is derived from RF cable loss and attenuator factor.

Offset = RF cable loss + attenuator factor.

The following shows an offset computation example with RF cable loss 4.2 dB and a 10dB attenuator.

Example :

$$\begin{aligned} \text{Offset(dB)} &= \text{RF cable loss(dB)} + \text{attenuator factor(dB)} \\ &= 4.2 + 10 = 14.2 \text{ (dB)} \end{aligned}$$

3 Conducted Test Result

3.1 Measuring Instruments

See list of measuring instruments of this test report.

3.2 Test Setup

3.2.1 Conducted Output Power

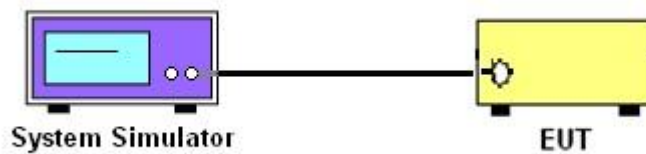

3.2.2 Peak-to-Average Ratio, Occupied Bandwidth, Conducted Band-Edge and Conducted Spurious Emission

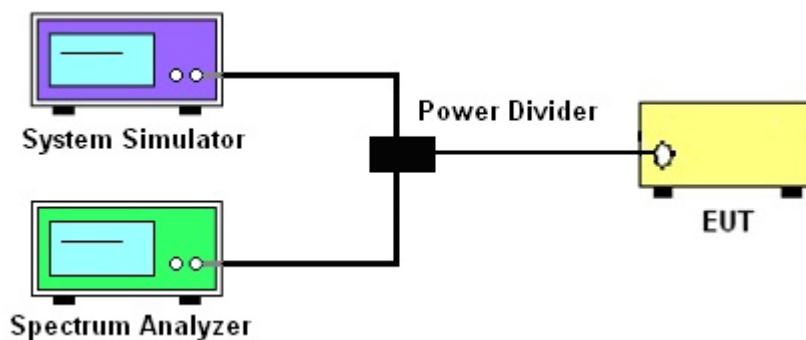

3.2.3 Frequency Stability

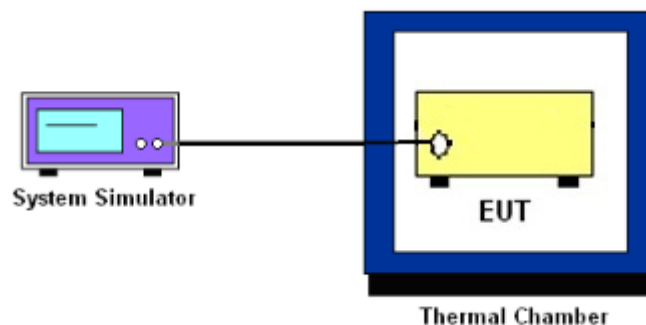

3.3 Test Result of Conducted Test

Please refer to Appendix A.



3.4 Conducted Output Power

3.4.1 Description of the Conducted Output Power

A system simulator was used to establish communication with the EUT. Its parameters were set to enforce EUT transmitting at the maximum power. The measured power in the radio frequency on the transmitter output terminals shall be reported.

3.4.2 Test Procedures

1. The transmitter output port was connected to the system simulator.
2. Set EUT at maximum power through system simulator.
3. Select lowest, middle, and highest channels for each band and different modulation.
4. Measure the maximum burst average power for GSM and maximum average power for other modulation signal.



3.5 Peak-to-Average Ratio

3.5.1 Description of the PAR Measurement

The peak-to-average ratio (PAR) of the transmission may not exceed 13 dB.

3.5.2 Test Procedures

1. The testing follows FCC KDB 971168 D01 v02r02 Section 5.7.1.
2. The EUT was connected to spectrum analyzer and system simulator via a power divider.
3. Set EUT to transmit at maximum output power.
4. When the duty cycle is less than 98%, then signal gating will be implemented on the spectrum analyzer by triggering from the system simulator.
5. Set the CCDF (Complementary Cumulative Distribution Function) option of the spectrum analyzer.
Record the maximum PAPR level associated with a probability of 0.1%.



3.6 99% Occupied Bandwidth and 26dB Bandwidth Measurement

3.6.1 Description of 99% Occupied Bandwidth and 26dB Bandwidth Measurement

The occupied bandwidth is the width of a frequency band such that, below the lower and above the upper frequency limits, the mean powers emitted are each equal to a specified percentage 0.5% of the total mean transmitted power.

The 26 dB emission bandwidth is defined as the frequency range between two points, one above and one below the carrier frequency, at which the spectral density of the emission is attenuated 26 dB below the maximum in-band spectral density of the modulated signal. Spectral density (power per unit bandwidth) is to be measured with a detector of resolution bandwidth equal to approximately 1.0% of the emission bandwidth.

3.6.2 Test Procedures

1. The testing follows FCC KDB 971168 v02r02 Section 4.2.
2. The EUT was connected to spectrum analyzer and system simulator via a power divider.
3. The spectrum analyzer center frequency is set to the nominal EUT channel center frequency. The span range for the spectrum analyzer shall be between two and five times the anticipated OBW.
4. The nominal resolution bandwidth (RBW) shall be in the range of 1 to 5 % of the anticipated OBW, and the VBW shall be at least 3 times the RBW.
5. Set the detection mode to peak, and the trace mode to max hold.
6. Determine the reference value: Set the EUT to transmit a modulated signal. Allow the trace to stabilize. Set the spectrum analyzer marker to the highest level of the displayed trace.
(this is the reference value)
7. Determine the “-26 dB down amplitude” as equal to (Reference Value – X).
8. Place two markers, one at the lowest and the other at the highest frequency of the envelope of the spectral display such that each marker is at or slightly below the “-X dB down amplitude” determined in step 6. If a marker is below this “-X dB down amplitude” value it shall be placed as close as possible to this value. The OBW is the positive frequency difference between the two markers.
9. Use the 99 % power bandwidth function of the spectrum analyzer and report the measured bandwidth.



3.7 Conducted Band Edge

3.7.1 Description of Conducted Band Edge Measurement

The power of any emission outside of the authorized operating frequency ranges must be lower than the transmitter power (P) by a factor of at least $43 + 10 \log (P)$ dB.

3.7.2 Test Procedures

1. The testing follows FCC KDB 971168 D01 v02r02 Section 6.0.
2. The EUT was connected to the spectrum analyzer and system simulator via a power divider.
3. The RF output of EUT was connected to the spectrum analyzer by an RF cable and attenuator. The path loss was compensated to the results for each measurement.
4. The band edges of low and high channels for the highest RF powers were measured.
5. The RF fundamental frequency should be excluded against the limit line in the operating frequency band.
6. The limit line is derived from $43 + 10\log(P)$ dB below the transmitter power P(Watts)
= $P(W) - [43 + 10\log(P)]$ (dB)
= $[30 + 10\log(P)]$ (dBm) - $[43 + 10\log(P)]$ (dB)
= -13dBm.



3.8 Conducted Spurious Emission

3.8.1 Description of Conducted Spurious Emission Measurement

The power of any emission outside of the authorized operating frequency ranges must be lower than the transmitter power (P) by a factor of at least $43 + 10 \log (P)$ dB.

It is measured by means of a calibrated spectrum analyzer and scanned from 30 MHz up to a frequency including its 10th harmonic.

3.8.2 Test Procedures

1. The testing follows FCC KDB 971168 D01 v02r02 Section 6.0.
2. The EUT was connected to the spectrum analyzer and system simulator via a power divider.
3. The RF output of EUT was connected to the spectrum analyzer by an RF cable and attenuator. The path loss was compensated to the results for each measurement.
4. The middle channel for the highest RF power within the transmitting frequency was measured.
5. The conducted spurious emission for the whole frequency range was taken.
6. The RF fundamental frequency should be excluded against the limit line in the operating frequency band.
7. The limit line is derived from $43 + 10\log(P)$ dB below the transmitter power P(Watts)
= $P(W) - [43 + 10\log(P)]$ (dB)
= $[30 + 10\log(P)]$ (dBm) - $[43 + 10\log(P)]$ (dB)
= -13dBm.



3.9 Frequency Stability

3.9.1 Description of Frequency Stability Measurement

The frequency stability shall be measured by variation of ambient temperature and variation of primary supply voltage to ensure that the fundamental emission stays within the authorized frequency block. The frequency stability of the transmitter shall be maintained within $\pm 0.00025\%$ ($\pm 2.5\text{ppm}$) of the center frequency.

3.9.2 Test Procedures for Temperature Variation

1. The testing follows FCC KDB 971168 D01 v02r02 Section 9.0.
2. The EUT was set up in the thermal chamber and connected with the system simulator.
3. With power OFF, the temperature was decreased to -30°C and the EUT was stabilized before testing. Power was applied and the maximum change in frequency was recorded within one minute.
4. With power OFF, the temperature was raised in 10°C steps up to 50°C . The EUT was stabilized at each step for at least half an hour. Power was applied and the maximum frequency change was recorded within one minute.

3.9.3 Test Procedures for Voltage Variation

1. The testing follows FCC KDB 971168 D01 v02r02 Section 9.0.
2. The EUT was placed in a temperature chamber at $25\pm 5^{\circ}\text{C}$ and connected with the system simulator.
3. The power supply voltage to the EUT was varied from 85% to 115% of the nominal value measured at the input to the EUT.
4. The variation in frequency was measured for the worst case.

4 Radiated Test Items

4.1 Measuring Instruments

See list of measuring instruments of this test report.

4.2 Test Setup

4.2.1 For radiated test from 30MHz to 1GHz

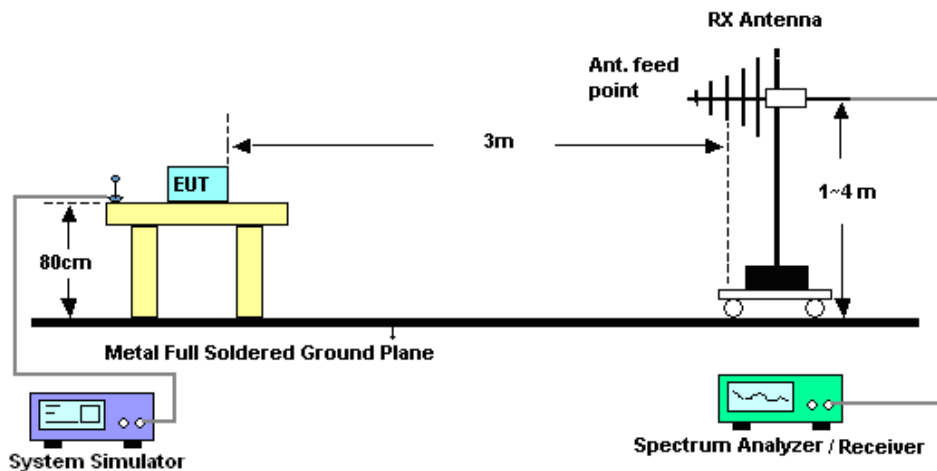

4.2.2 For radiated test above 1GHz

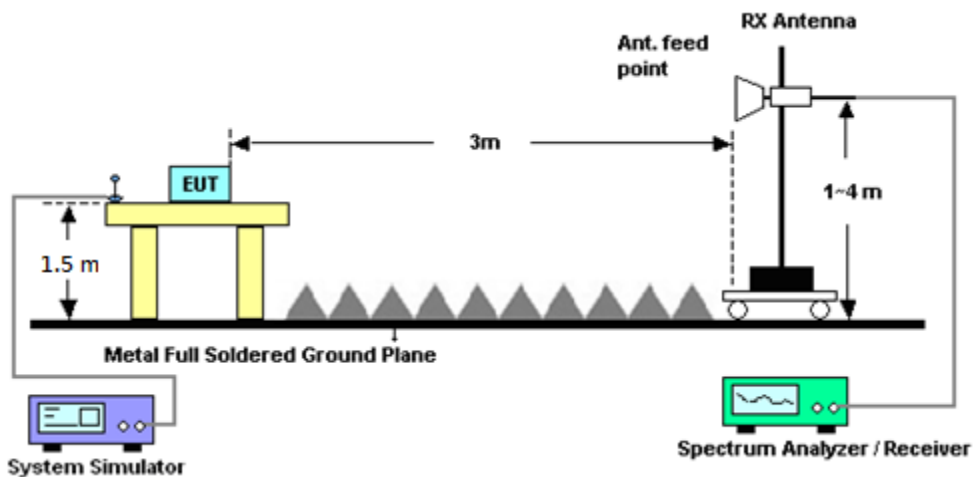

4.3 Test Result of Radiated Test

Please refer to Appendix B.



4.4 Effective Radiated Power and Effective Isotropic Radiated Power Measurement

4.4.1 Description of the ERP/EIRP Measurement

The substitution method, in ANSI / TIA / EIA-603-D-2010, was used for ERP/EIRP measurement, and the spectrum analyzer configuration follows KDB 971168 D01 Power Meas. License Digital Systems v02r02. The ERP of mobile transmitters must not exceed 7 Watts (Cellular Band) and the EIRP of mobile transmitters are limited to 2 Watts (PCS Band).

4.4.2 Test Procedures

1. The testing follows FCC KDB 971168 D01 v02r02 Section 5.2.1. (for CDMA/WCDMA), Section 5.2.2.2 (for GSM/GPRS/EDGE) and ANSI / TIA-603-D-2010 Section 2.2.17.
2. The EUT was placed on a non-conductive rotating platform (0.8 meters for frequency below 1GHz and 1.5 meter for frequency above 1GHz) in a semi-anechoic chamber. The radiated emission at the fundamental frequency was measured at 3 m with a test antenna and a spectrum analyzer with RMS detector per section 5. of KDB 971168 D01.
3. During the measurement, the system simulator parameters were set to force the EUT transmitting at maximum output power. The maximum emission was recorded from analyzer power level (LVL) from the 360 degrees rotation of the turntable and the test antenna raised and lowered over a range from 1 to 4 meters in both horizontally and vertically polarized orientations.
4. Effective Isotropic Radiated Power (EIRP) was measured by substitution method according to TIA/EIA-603-D. The EUT was replaced by the substitution antenna at same location, and then a known power from S.G. was applied into the dipole antenna through a Tx cable, and then recorded the maximum Analyzer reading through raised and lowered the test antenna. The correction factor (in dB) = S.G. - Tx Cable loss + Substitution antenna gain - Analyzer reading. Then the EUT's EIRP was calculated with the correction factor, $EIRP = LVL + \text{Correction factor}$ and $ERP = EIRP - 2.15$. Take the record of the output power at substitution antenna.



	GSM/GPRS/EDGE	WCDMA/HSPA
SPAN	500kHz	10MHz
RBW	10kHz	100kHz
VBW	30kHz	300kHz
Detector	RMS	RMS
Trace	Average	Average
Average Type	Power	Power
Sweep Count	100	100



4.5 Field Strength of Spurious Radiation Measurement

4.5.1 Description of Field Strength of Spurious Radiated Measurement

The power of any emission outside of the authorized operating frequency ranges must be attenuated below the transmitter power (P) by a factor of at least $43 + 10 \log (P)$ dB. The spectrum is scanned from 30 MHz up to a frequency including its 10th harmonic.

4.5.2 Test Procedures

1. The testing follows FCC KDB 971168 D01 v02r02 Section 5.8 and ANSI / TIA-603-D-2010 Section 2.2.12.
2. The EUT was placed on a rotatable wooden table 0.8 meters for frequency below 1GHz and 1.5 meter for frequency above 1GHz above the ground.
3. The EUT was set 3 meters from the receiving antenna, which was mounted on the antenna tower.
4. The table was rotated 360 degrees to determine the position of the highest spurious emission.
5. The height of the receiving antenna is varied between one meter and four meters to search for the maximum spurious emission for both horizontal and vertical polarizations.
6. Make the measurement with the spectrum analyzer's RBW = 1MHz, VBW = 3MHz, taking record of maximum spurious emission.
7. A horn antenna was substituted in place of the EUT and was driven by a signal generator.
8. Tune the output power of signal generator to the same emission level with EUT maximum spurious emission.
9. Taking the record of output power at antenna port.
10. Repeat step 7 to step 8 for another polarization.
11. $EIRP \text{ (dBm)} = S.G. \text{ Power} - Tx \text{ Cable Loss} + Tx \text{ Antenna Gain}$
12. $ERP \text{ (dBm)} = EIRP - 2.15$
13. The RF fundamental frequency should be excluded against the limit line in the operating frequency band.
14. The limit line is derived from $43 + 10\log(P)$ dB below the transmitter power P(Watts)
= $P(W) - [43 + 10\log(P)] \text{ (dB)}$
= $[30 + 10\log(P)] \text{ (dBm)} - [43 + 10\log(P)] \text{ (dB)}$
= -13dBm.



5 List of Measuring Equipment

Instrument	Manufacturer	Model No.	Serial No.	Characteristics	Calibration Date	Test Date	Due Date	Remark
Spectrum Analyzer	Rohde & Schwarz	FSP30	101329	9kHz~30GHz	Jun. 24, 2015	Apr. 10, 2016 ~ Apr. 11, 2016	Jun. 23, 2016	Conducted (TH03-HY)
Temperature Chamber	ESPEC	SU-641	92013721	-30°C ~70°C	Nov. 20, 2015	Apr. 10, 2016 ~ Apr. 11, 2016	Nov. 19, 2016	Conducted (TH03-HY)
Base Station(Measu	Rohde & Schwarz	CMU200	117995	GSM / GPRS / WCDMA / CDMA	Jul. 26, 2015	Apr. 10, 2016 ~ Apr. 11, 2016	Jul. 25, 2016	Conducted (TH03-HY)
Bilog Antenna	TESEQ	CBL 6111D	37059	30MHz~1GHz	Dec. 29, 2015	Apr. 06, 2016 ~ Apr. 13, 2016	Dec. 28, 2016	Radiation (03CH12-HY)
Horn Antenna	SCHWARZBECK	BBHA 9120D	9120D-1328	1GHz ~ 18GHz	Nov. 02, 2015	Apr. 06, 2016 ~ Apr. 13, 2016	Nov. 01, 2016	Radiation (03CH12-HY)
SHF-EHF Horn Antenna	SCHWARZBECK	BBHA 9170	BBHA9170584	18GHz- 40GHz	Nov. 02, 2015	Apr. 06, 2016 ~ Apr. 13, 2016	Nov. 01, 2016	Radiation (03CH12-HY)
EMI Test Receiver	Rohde & Schwarz	ESU26	100390	20Hz~26.5GHz	Dec. 21, 2015	Apr. 06, 2016 ~ Apr. 13, 2016	Dec. 20, 2016	Radiation (03CH12-HY)
Preamplifier	COM-POWER	PA-103	161075	10MHz~1GHz	Apr. 01, 2016	Apr. 06, 2016 ~ Apr. 13, 2016	Mar. 31, 2017	Radiation (03CH12-HY)
Preamplifier	MITEQ	AMF-7D-00 101800-30-1	1815698	1GHz~18GHz	Dec. 14, 2015	Apr. 06, 2016 ~ Apr. 13, 2016	Dec. 13, 2016	Radiation (03CH12-HY)
Preamplifier	MITEQ	JS44-18004 000-33-8P	1840917	18GHz ~ 40GHz	Jun. 02, 2015	Apr. 06, 2016 ~ Apr. 13, 2016	Jun. 01, 2016	Radiation (03CH12-HY)
Controller	EMEC	EM1000	N/A	Control Turn table & Ant Mast	N/A	Apr. 06, 2016 ~ Apr. 13, 2016	N/A	Radiation (03CH12-HY)
Antenna Mast	EMEC	AM-BS-450 0-B	N/A	1m~4m	N/A	Apr. 06, 2016 ~ Apr. 13, 2016	N/A	Radiation (03CH12-HY)
Turn Table	EMEC	TT2000	N/A	0~360 Degree	N/A	Apr. 06, 2016 ~ Apr. 13, 2016	N/A	Radiation (03CH12-HY)
Horn Antenna	SCHWARZBECK	BBHA 9120 D	9120D-1241	1GHz ~ 18GHz	Apr. 22, 2015	Apr. 06, 2016 ~ Apr. 13, 2016	Apr. 21, 2016	Radiation (03CH12-HY)
SHF-EHF Horn Antenna	SCHWARZBECK	BBHA 9170	BBHA9170251	18GHz- 40GHz	Oct. 12, 2015	Apr. 06, 2016 ~ Apr. 13, 2016	Oct. 11, 2016	Radiation (03CH12-HY)
Signal Generator	Rohde & Schwarz	SMF100A	101107	100kHz~40GHz	May 22, 2015	Apr. 06, 2016 ~ Apr. 13, 2016	May 21, 2016	Radiation (03CH12-HY)
Horn Antenna	SCHWARZBECK	BBHA 9120 D	9120D-1522	1G~18GHz	Mar. 31, 2016	Apr. 06, 2016 ~ Apr. 13, 2016	Mar. 30, 2016	Radiation (03CH12-HY)
Horn Antenna	ESCO	3117	00066584	1GHz~18GHz	Sep. 02, 2015	Apr. 06, 2016 ~ Apr. 13, 2016	Sep. 01, 2016	Radiation (03CH12-HY)



6 Uncertainty of Evaluation

Uncertainty of Radiated Emission Measurement (30 MHz ~ 1000 MHz)

Measuring Uncertainty for a Level of Confidence of 95% ($U = 2Uc(y)$)	5.40
---	------



Appendix A. Test Results of Conducted Test

Conducted Output Power(Average power)

Conducted Power (*Unit: dBm)						
Band	GSM850			GSM1900		
Channel	128	189	251	512	661	810
Frequency	824.2	836.4	848.8	1850.2	1880.0	1909.8
GSM	33.48	33.24	33.00	29.65	29.96	30.24
GPRS class 8	33.53	33.23	33.04	29.72	29.85	30.25
GPRS class 10	29.40	29.47	29.12	26.44	26.44	26.87
GPRS class 11	27.30	27.30	27.11	24.40	24.47	24.73
GPRS class 12	25.76	25.86	25.53	23.80	23.58	23.83
EGPRS class 8	26.46	26.61	26.51	25.24	25.37	25.59
EGPRS class 10	26.40	26.38	26.26	24.94	24.96	25.42
EGPRS class 11	25.93	26.02	25.91	24.67	24.65	25.11
EGPRS class 12	24.59	24.55	24.50	23.14	23.25	23.72

Conducted Power (*Unit: dBm)						
Band	WCDMA Band V			WCDMA Band II		
Channel	4132	4182	4233	9262	9400	9538
Frequency	826.4	836.4	846.6	1852.4	1880	1907.6
RMC 12.2K	22.82	22.98	22.95	23.10	22.99	22.98
HSDPA Subtest-1	21.76	21.94	21.92	22.05	21.93	21.99
HSDPA Subtest-2	21.77	21.92	21.91	21.99	21.92	21.97
HSDPA Subtest-3	21.27	21.45	21.45	21.59	21.47	21.49
HSDPA Subtest-4	21.30	21.46	21.43	21.57	21.45	21.48
HSUPA Subtest-1	21.82	21.91	21.81	22.05	21.97	21.96
HSUPA Subtest-2	19.79	19.94	19.92	20.09	19.94	20.00
HSUPA Subtest-3	20.80	20.92	20.96	21.10	21.01	20.98
HSUPA Subtest-4	19.80	19.94	19.95	20.08	19.96	20.01
HSUPA Subtest-5	21.80	22.01	21.99	22.16	22.07	21.96



Conducted Power (*Unit: dBm)						
Band	CDMA 2000 BC0			CDMA 2000 BC1		
Channel	1013	384	777	25	600	1175
Frequency	824.7	836.52	848.31	1851.25	1880	1908.75
1xRTT RC1 SO55	23.71	23.85	23.70	24.12	24.14	24.09
1xRTT RC3 SO55	23.65	23.97	23.79	23.98	24.03	24.05
1xRTT RC3 SO32 (+ F-SCH)	23.66	23.89	23.70	24.09	24.03	23.96
1xRTT RC3 SO32 (+SCH)	23.69	23.98	23.74	24.05	23.94	23.97
1xEVDO RTAP 153.6Kbps	23.74	24.05	23.77	23.88	23.83	23.64
1xEVDO RETAP 4096Bits	23.51	23.78	23.37	23.87	23.82	23.63



A1. GSM

Peak-to-Average Ratio

Mode	GSM850		Limit: 13dB
Mod.	GPRS class 8	EDGE class 8	Result
Lowest CH	0.32	3.28	PASS
Middle CH	0.36	3.36	
Highest CH	0.32	3.36	

Mode	GSM1900		Limit: 13dB
Mod.	GPRS class 8	EDGE class 8	Result
Lowest CH	0.36	3.28	PASS
Middle CH	0.40	3.32	
Highest CH	0.32	3.32	



GSM850 (GPRS class 8)	GSM850 (EDGE class 8)
<p align="center">Lowest Channel</p> <p>Center 824.2 MHz 2 dB/ Mean Pwr + 20 dB</p> <p>Complementary Cumulative Distribution Function (100000 samples)</p> <p>Trace 1</p> <p>Mean 32.68 dBm Peak 32.99 dBm Crest 0.32 dB</p> <p>10 % 0.20 dB 1 % 0.28 dB .1 % 0.32 dB .01 % 0.32 dB</p> <p>Date: 8.APR.2016 17:01:24</p>	<p align="center">Lowest Channel</p> <p>Center 824.2 MHz 2 dB/ Mean Pwr + 20 dB</p> <p>Complementary Cumulative Distribution Function (100000 samples)</p> <p>Trace 1</p> <p>Mean 26.12 dBm Peak 29.47 dBm Crest 3.35 dB</p> <p>10 % 2.68 dB 1 % 3.20 dB .1 % 3.28 dB .01 % 3.36 dB</p> <p>Date: 8.APR.2016 17:23:45</p>
<p align="center">Middle Channel</p> <p>Center 836.4 MHz 2 dB/ Mean Pwr + 20 dB</p> <p>Complementary Cumulative Distribution Function (100000 samples)</p> <p>Trace 1</p> <p>Mean 33.01 dBm Peak 33.35 dBm Crest 0.34 dB</p> <p>10 % 0.24 dB 1 % 0.28 dB .1 % 0.36 dB .01 % 0.36 dB</p> <p>Date: 8.APR.2016 17:01:45</p>	<p align="center">Middle Channel</p> <p>Center 836.4 MHz 2 dB/ Mean Pwr + 20 dB</p> <p>Complementary Cumulative Distribution Function (100000 samples)</p> <p>Trace 1</p> <p>Mean 26.12 dBm Peak 29.54 dBm Crest 3.42 dB</p> <p>10 % 2.64 dB 1 % 3.24 dB .1 % 3.36 dB .01 % 3.44 dB</p> <p>Date: 8.APR.2016 17:24:03</p>
<p align="center">Highest Channel</p> <p>Center 848.6 MHz 2 dB/ Mean Pwr + 20 dB</p> <p>Complementary Cumulative Distribution Function (100000 samples)</p> <p>Trace 1</p> <p>Mean 33.05 dBm Peak 33.35 dBm Crest 0.30 dB</p> <p>10 % 0.24 dB 1 % 0.28 dB .1 % 0.32 dB .01 % 0.32 dB</p> <p>Date: 8.APR.2016 17:02:01</p>	<p align="center">Highest Channel</p> <p>Center 848.6 MHz 2 dB/ Mean Pwr + 20 dB</p> <p>Complementary Cumulative Distribution Function (100000 samples)</p> <p>Trace 1</p> <p>Mean 26.51 dBm Peak 29.96 dBm Crest 3.45 dB</p> <p>10 % 2.72 dB 1 % 3.28 dB .1 % 3.36 dB .01 % 3.40 dB</p> <p>Date: 8.APR.2016 17:24:32</p>

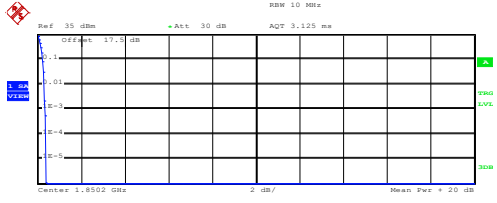
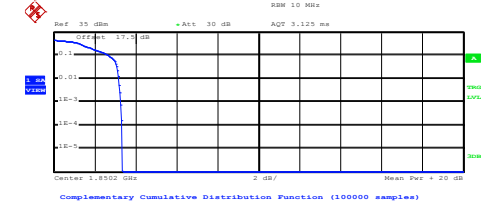
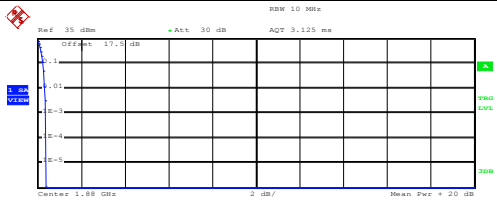
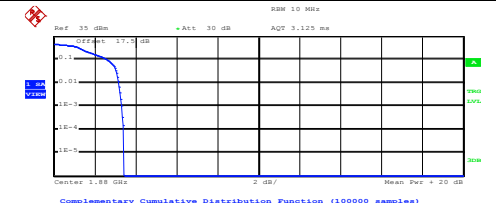
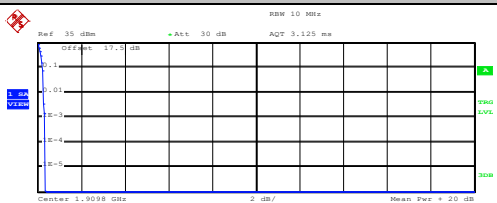
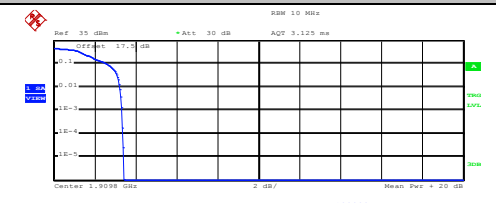

GSM1900 (GPRS class 8)	GSM1900 (EDGE class 8)
<p style="text-align: center;">Lowest Channel</p>  <p>Center 1.8502 GHz 2 dB/ Mean Pwr + 20 dB</p> <p>Complementary Cumulative Distribution Function (100000 samples)</p> <p>Trace 1</p> <p>Mean 29.52 dBm Peak 29.89 dBm Crest 0.37 dB</p> <p>10 % 0.24 dB 1 % 0.32 dB .1 % 0.36 dB .01 % 0.40 dB</p> <p>Date: 8.APR.2016 17:56:14</p>	<p style="text-align: center;">Lowest Channel</p>  <p>Center 1.8502 GHz 2 dB/ Mean Pwr + 20 dB</p> <p>Complementary Cumulative Distribution Function (100000 samples)</p> <p>Trace 1</p> <p>Mean 25.08 dBm Peak 28.41 dBm Crest 3.32 dB</p> <p>10 % 2.68 dB 1 % 3.16 dB .1 % 3.28 dB .01 % 3.32 dB</p> <p>Date: 8.APR.2016 18:18:29</p>
<p style="text-align: center;">Middle Channel</p>  <p>Center 1.88 GHz 2 dB/ Mean Pwr + 20 dB</p> <p>Complementary Cumulative Distribution Function (100000 samples)</p> <p>Trace 1</p> <p>Mean 29.45 dBm Peak 29.82 dBm Crest 0.37 dB</p> <p>10 % 0.24 dB 1 % 0.32 dB .1 % 0.40 dB .01 % 0.40 dB</p> <p>Date: 8.APR.2016 17:56:31</p>	<p style="text-align: center;">Middle Channel</p>  <p>Center 1.88 GHz 2 dB/ Mean Pwr + 20 dB</p> <p>Complementary Cumulative Distribution Function (100000 samples)</p> <p>Trace 1</p> <p>Mean 24.98 dBm Peak 28.41 dBm Crest 3.42 dB</p> <p>10 % 2.64 dB 1 % 3.16 dB .1 % 3.32 dB .01 % 3.40 dB</p> <p>Date: 8.APR.2016 18:18:52</p>
<p style="text-align: center;">Highest Channel</p>  <p>Center 1.9098 GHz 2 dB/ Mean Pwr + 20 dB</p> <p>Complementary Cumulative Distribution Function (100000 samples)</p> <p>Trace 1</p> <p>Mean 30.04 dBm Peak 30.38 dBm Crest 0.35 dB</p> <p>10 % 0.24 dB 1 % 0.28 dB .1 % 0.32 dB .01 % 0.36 dB</p> <p>Date: 8.APR.2016 17:56:50</p>	<p style="text-align: center;">Highest Channel</p>  <p>Center 1.9098 GHz 2 dB/ Mean Pwr + 20 dB</p> <p>Complementary Cumulative Distribution Function (100000 samples)</p> <p>Trace 1</p> <p>Mean 25.43 dBm Peak 28.83 dBm Crest 3.40 dB</p> <p>10 % 2.60 dB 1 % 3.24 dB .1 % 3.32 dB .01 % 3.40 dB</p> <p>Date: 8.APR.2016 18:19:15</p>



26dB Bandwidth

Mode	GSM850	
Mod.	GPRS class 8	EDGE class 8
Lowest CH	0.311	0.292
Middle CH	0.304	0.305
Highest CH	0.313	0.292

Mode	GSM1900	
Mod.	GPRS class 8	EDGE class 8
Lowest CH	0.306	0.305
Middle CH	0.312	0.299
Highest CH	0.308	0.303

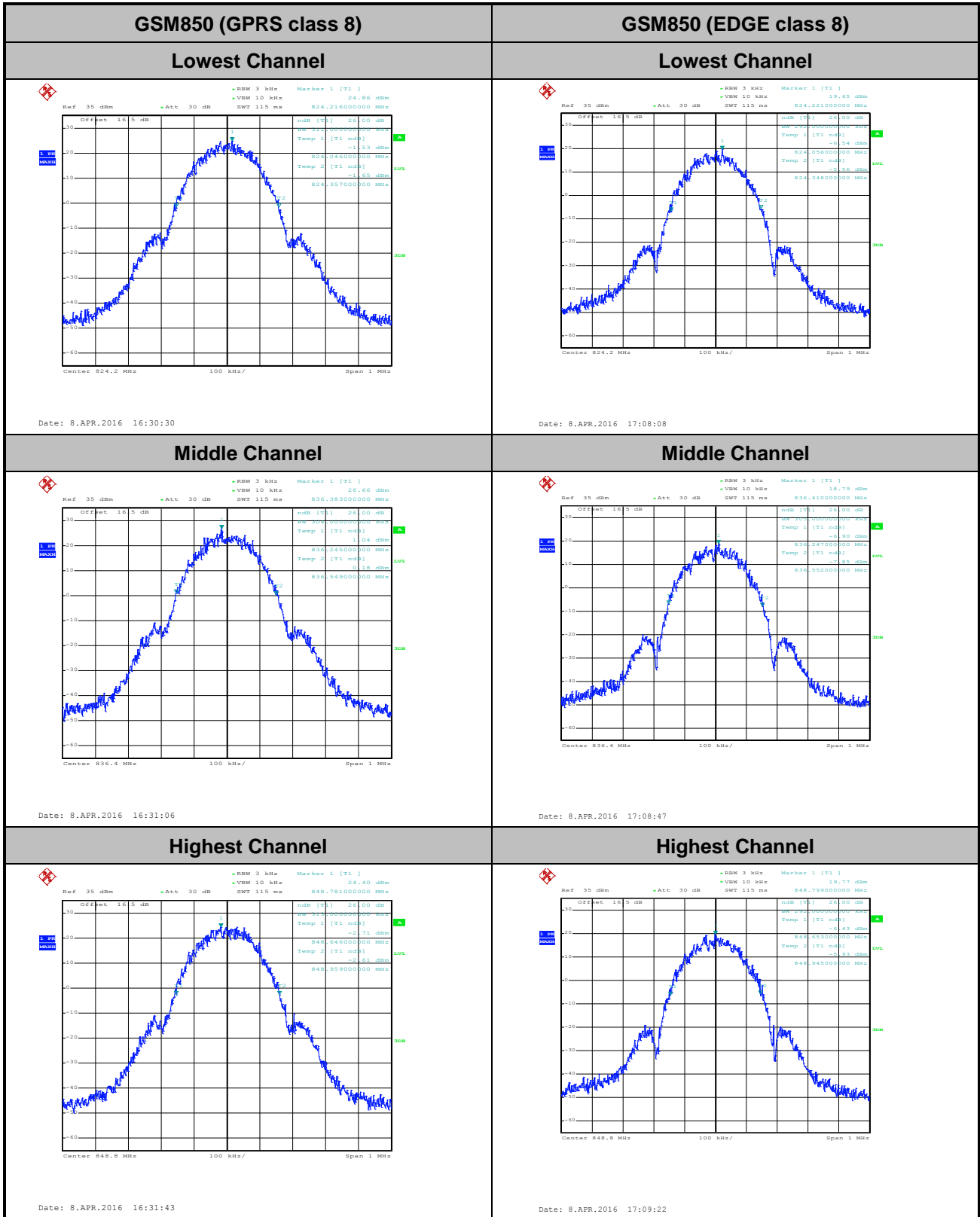

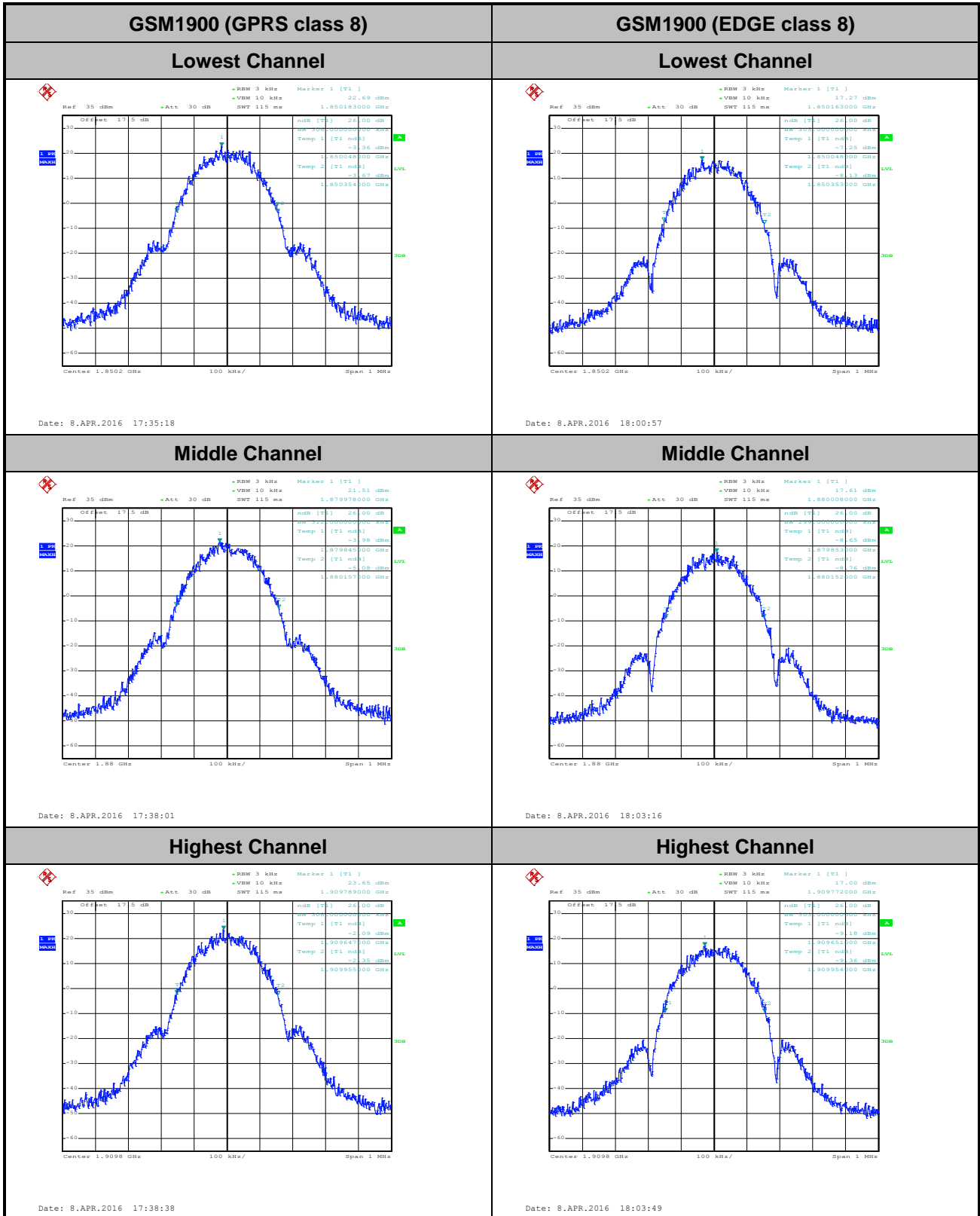



Occupied Bandwidth

Mode	GSM850	
Mod.	GPRS class 8	EDGE class 8
Lowest CH	0.247	0.242
Middle CH	0.245	0.246
Highest CH	0.249	0.243

Mode	GSM1900	
Mod.	GPRS class 8	EDGE class 8
Lowest CH	0.246	0.242
Middle CH	0.245	0.246
Highest CH	0.244	0.248

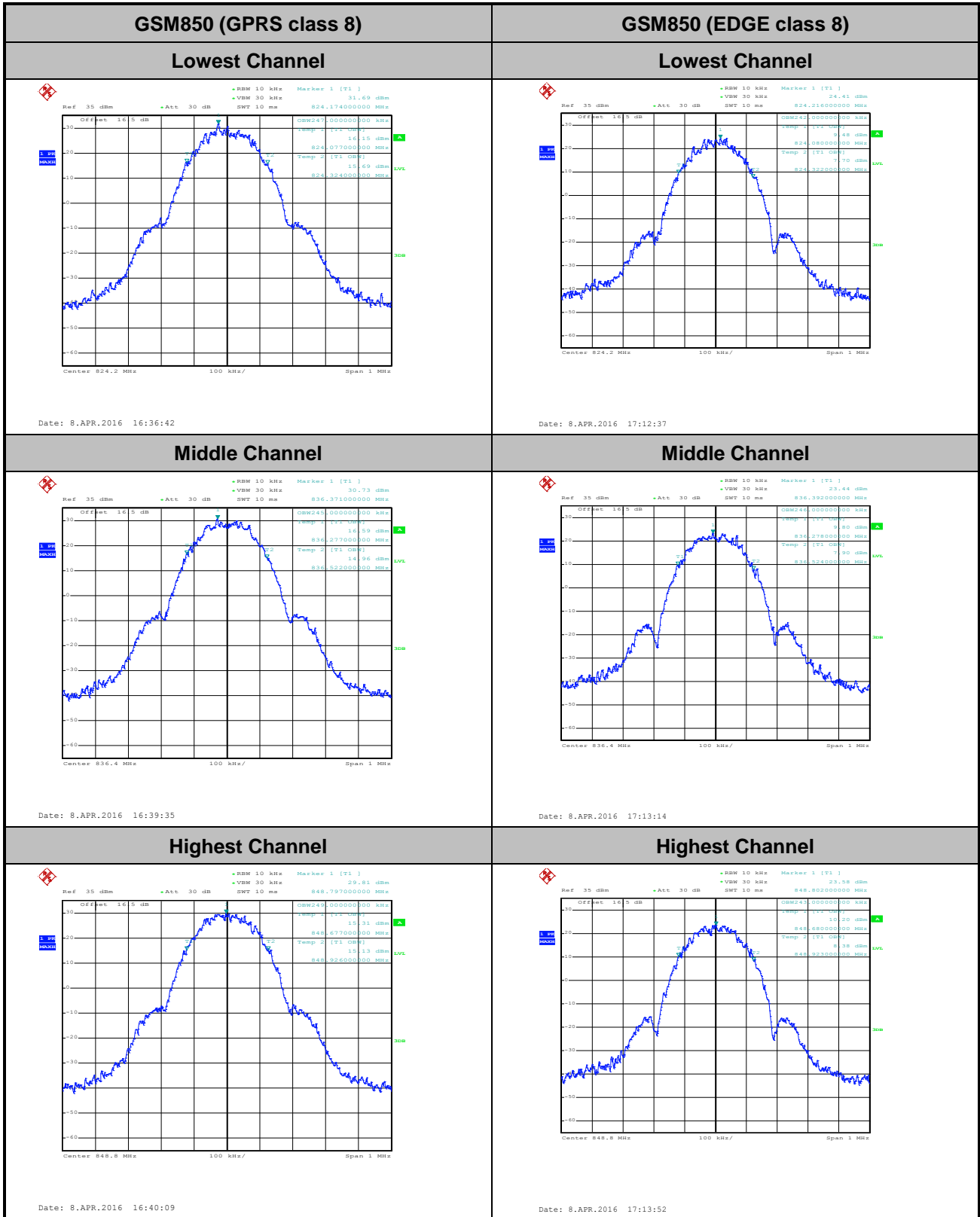



GSM1900 (GPRS class 8)

GSM1900 (EDGE class 8)

Lowest Channel

Lowest Channel

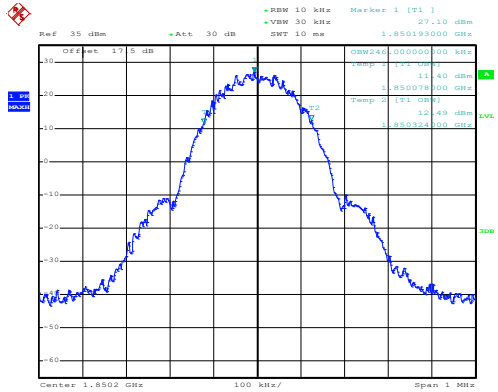

Date: 8.APR.2016 17:39:57

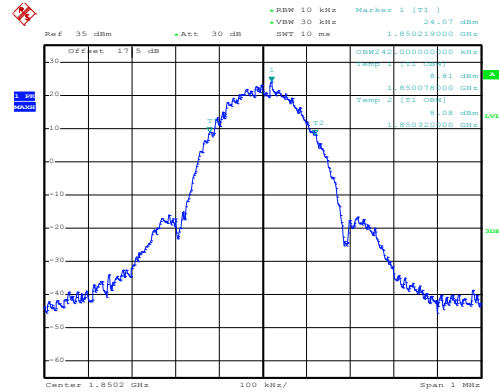

Date: 8.APR.2016 18:05:24

Middle Channel

Middle Channel

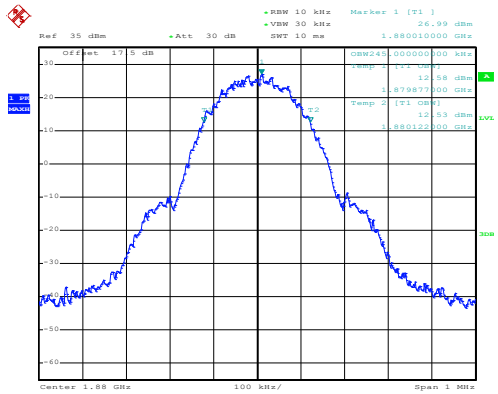

Date: 8.APR.2016 17:41:46

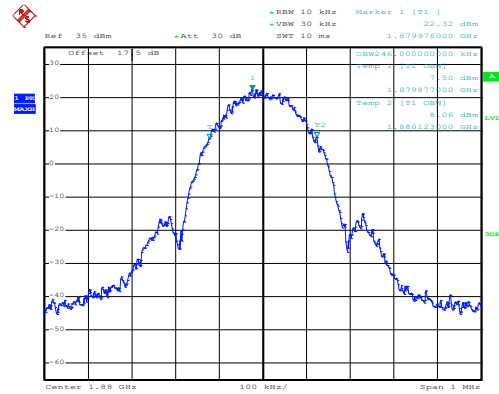

Date: 8.APR.2016 18:06:56

Highest Channel

Highest Channel

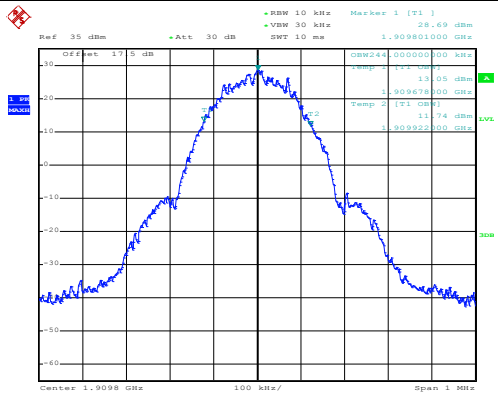

Date: 8.APR.2016 17:42:49

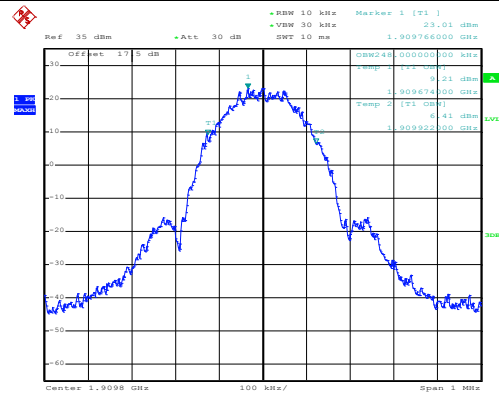

Date: 8.APR.2016 18:09:54



Conducted Band Edge

GSM850 (GPRS class 8)

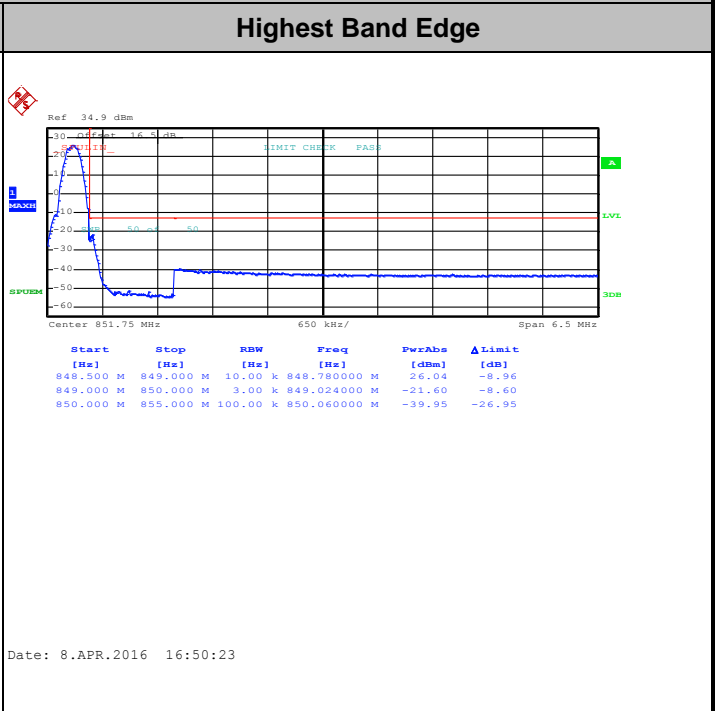
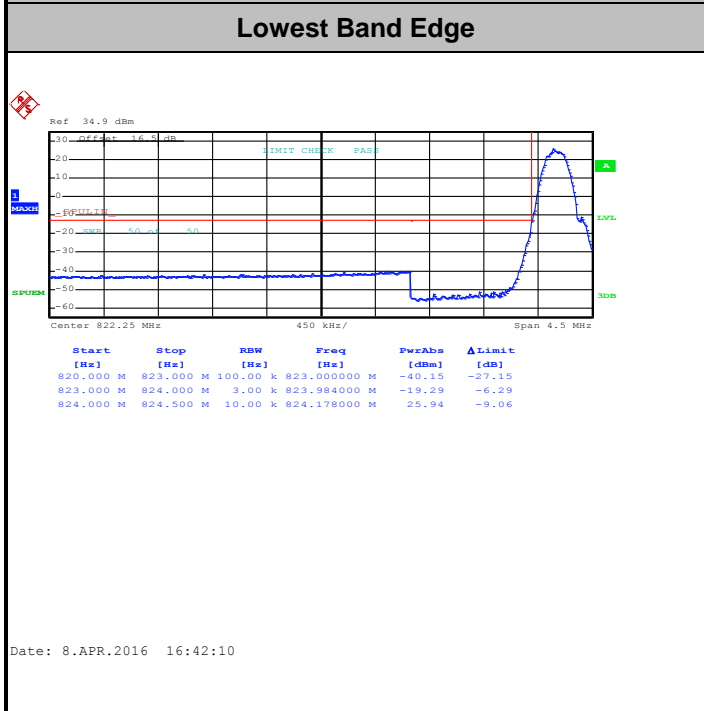

GSM850 (EDGE class 8)

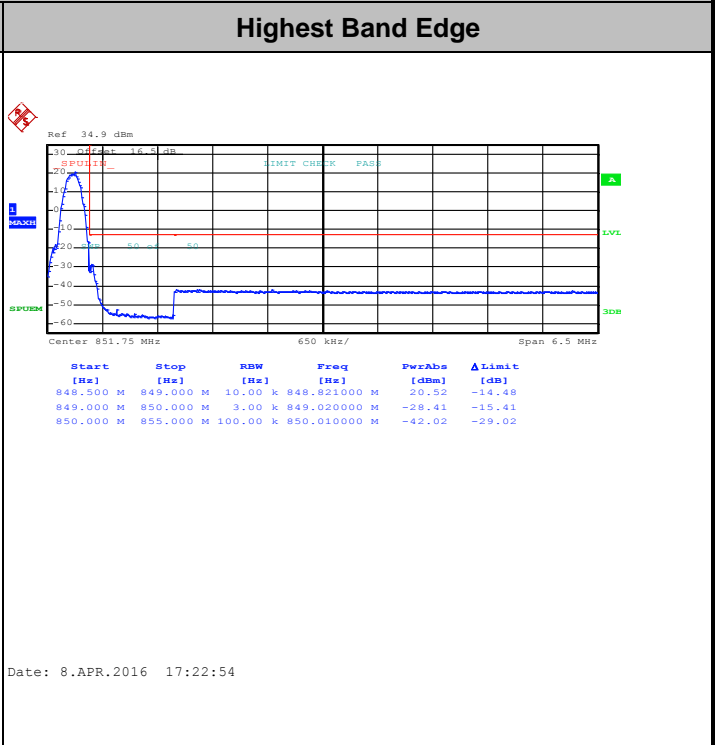
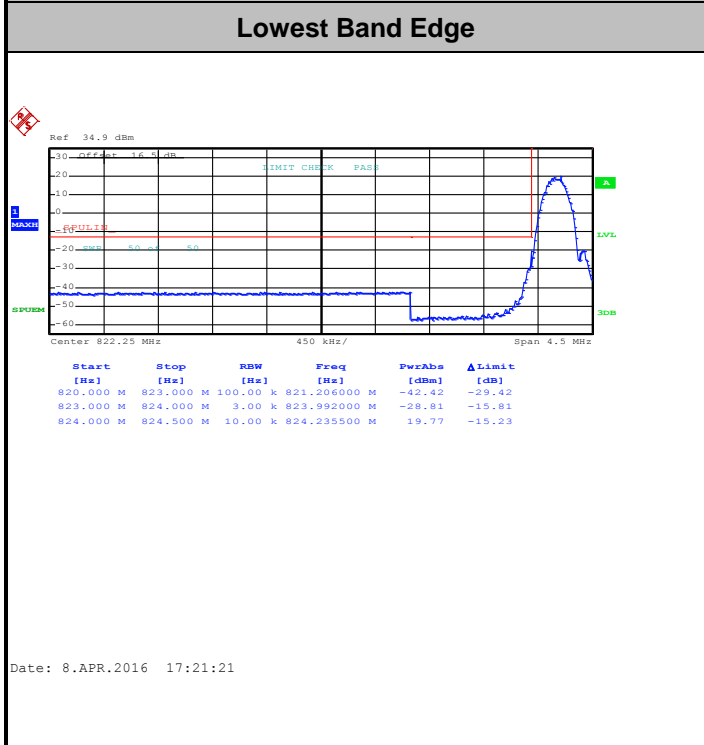



GSM1900 (GPRS class 8)

Lowest Band Edge

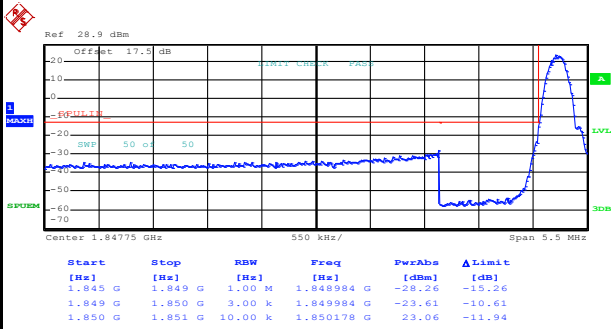

Date: 8.APR.2016 17:50:35

Highest Band Edge

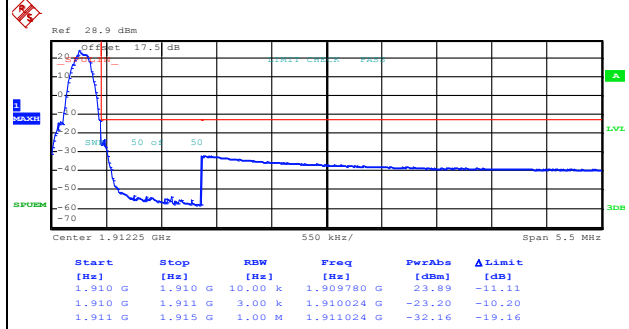

Date: 8.APR.2016 17:53:23

GSM1900 (EDGE class 8)

Lowest Band Edge

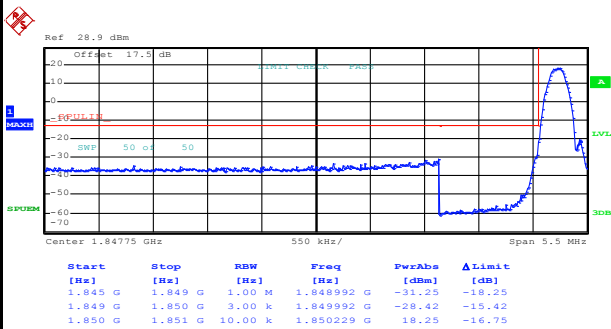

Date: 8.APR.2016 18:12:37

Highest Band Edge

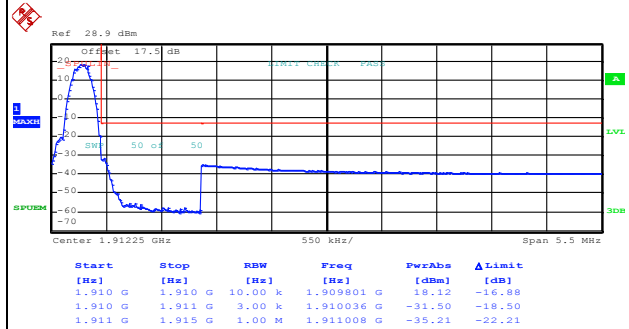

Date: 8.APR.2016 18:14:11



Conducted Spurious Emission

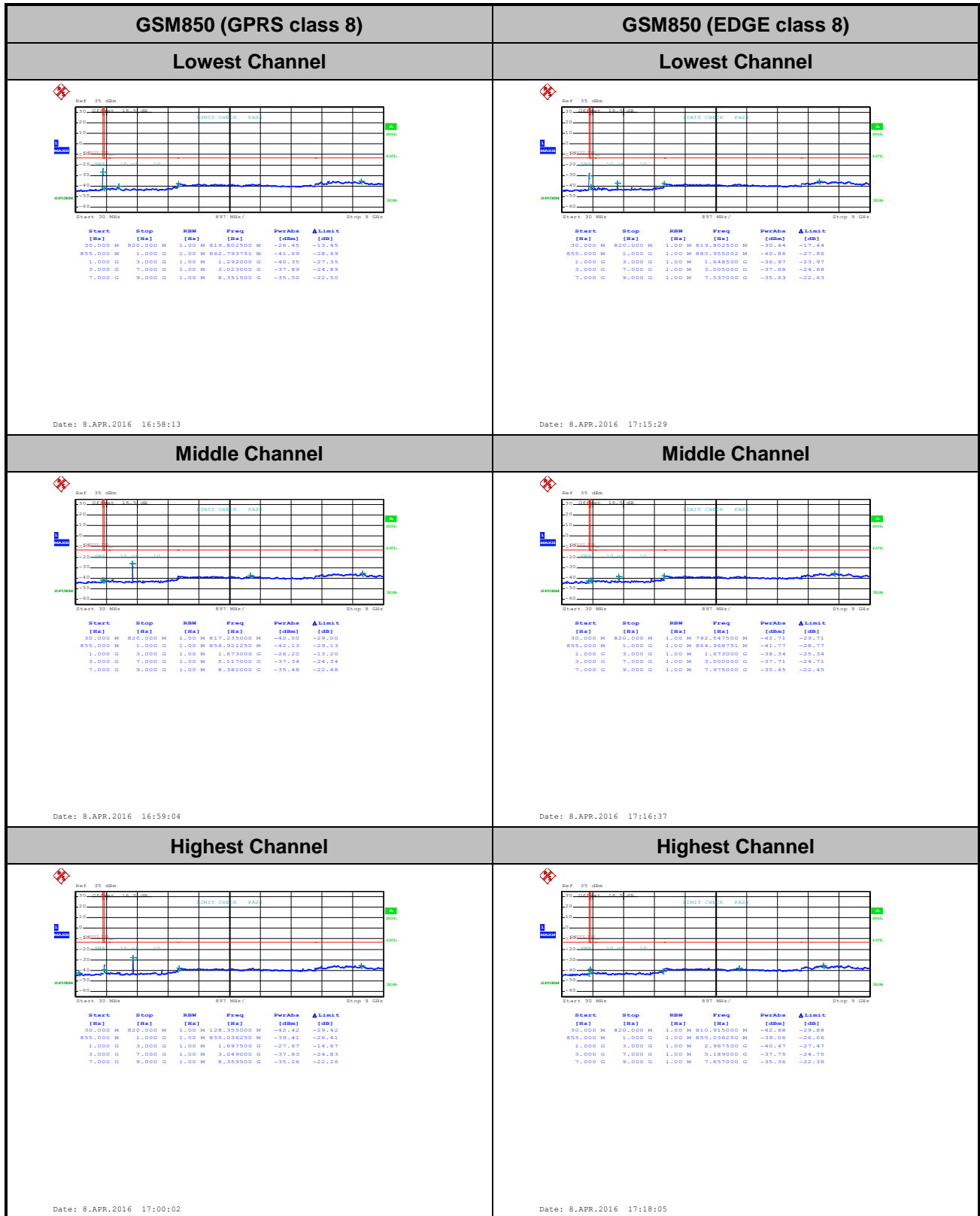

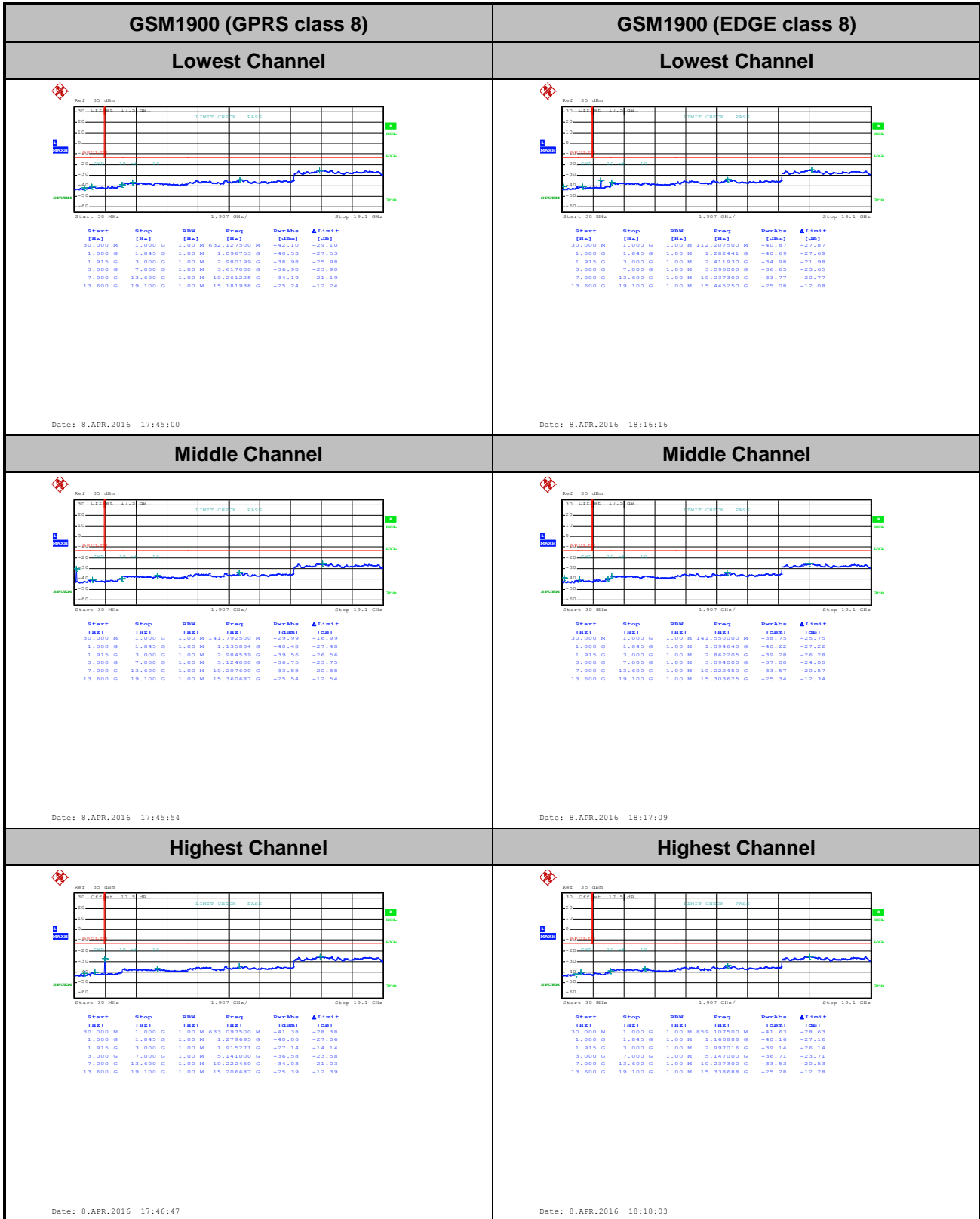



Frequency Stability

Test Conditions Temperature (°C)	Middle Channel Voltage (Volt)	GSM850 (GPRS class 8)	GSM850 (EDGE class 8)	Limit 2.5ppm
		Deviation (ppm)		Result
50	Normal Voltage	0.0897	0.0921	PASS
40	Normal Voltage	0.0801	0.0072	
30	Normal Voltage	0.0012	0.0084	
20(Ref.)	Normal Voltage	0.0000	0.0000	
10	Normal Voltage	0.0036	0.0012	
0	Normal Voltage	0.0012	0.0060	
-10	Normal Voltage	0.0048	0.0024	
-20	Normal Voltage	0.0084	0.0956	
-30	Normal Voltage	0.0060	0.0992	
20	Maximum Voltage	0.0717	0.0024	
20	Normal Voltage	0.0012	0.0968	
20	Battery End Point	0.0741	0.0048	

Note:

1. Normal Voltage = 3.8V. ; Battery End Point (BEP) = 3.4 V. ; Maximum Voltage =4.35 V
2. The frequency fundamental emissions stay within the authorized frequency block.



Test Conditions Temperature (°C)	Middle Channel Voltage (Volt)	GSM1900 (GPRS class 8)	GSM1900 (EDGE class 8)	Limit Note 2.
		Deviation (ppm)		Result
50	Normal Voltage	0.0027	0.0048	PASS
40	Normal Voltage	0.0016	0.0005	
30	Normal Voltage	0.0011	0.0005	
20(Ref.)	Normal Voltage	0.0000	0.0000	
10	Normal Voltage	0.0005	0.0016	
0	Normal Voltage	0.0021	0.0032	
-10	Normal Voltage	0.0011	0.0059	
-20	Normal Voltage	0.0021	0.0043	
-30	Normal Voltage	0.0032	0.0064	
20	Maximum Voltage	0.0372	0.0059	
20	Normal Voltage	0.0032	0.0048	
20	Battery End Point	0.0356	0.0101	

Note:

- 1. Normal Voltage = 3.8V. ; Battery End Point (BEP) = 3.4 V. ; Maximum Voltage =4.35 V
- 2. The frequency fundamental emissions stay within the authorized frequency block.



A2. WCDMA

Peak-to-Average Ratio

Mode	WCDMA Band V	WCDMA Band II	Limit: 13dB
Mod.	RMC 12.2Kbps	RMC 12.2Kbps	Result
Lowest CH	3.20	3.00	PASS
Middle CH	3.32	3.08	
Highest CH	3.32	3.16	

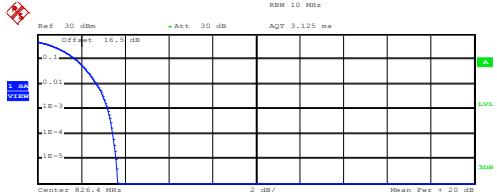
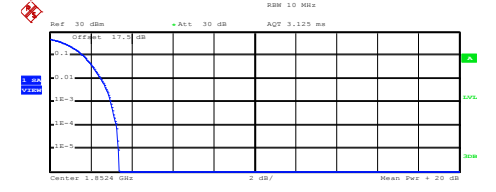
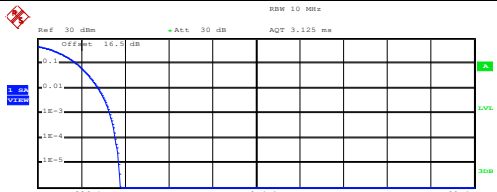
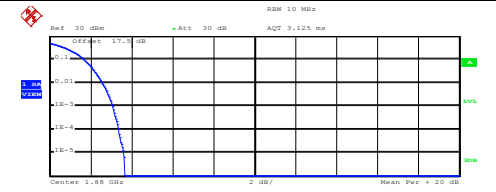
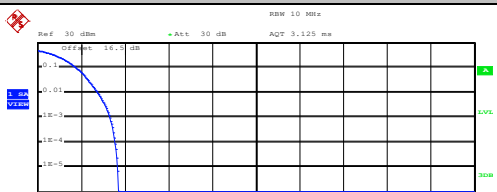
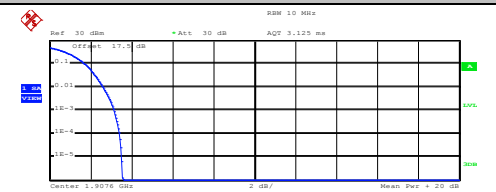

WCDMA Band V (RMC 12.2Kbps)	WCDMA Band II (RMC 12.2Kbps)																												
<p align="center">Lowest Channel</p>  <p>Center 826.4 MHz 2 dB/ Mean Pwr + 20 dB</p> <p>Complementary Cumulative Distribution Function (100000 samples)</p> <p>Trace 1</p> <table border="0"> <tr><td>Mean</td><td>19.82 dBm</td></tr> <tr><td>Peak</td><td>23.48 dBm</td></tr> <tr><td>Crest</td><td>3.66 dB</td></tr> </table> <table border="0"> <tr><td>10 %</td><td>1.76 dB</td></tr> <tr><td>1 %</td><td>2.72 dB</td></tr> <tr><td>.1 %</td><td>3.20 dB</td></tr> <tr><td>.01 %</td><td>3.44 dB</td></tr> </table> <p>Date: 10.APR.2016 09:45:02</p>	Mean	19.82 dBm	Peak	23.48 dBm	Crest	3.66 dB	10 %	1.76 dB	1 %	2.72 dB	.1 %	3.20 dB	.01 %	3.44 dB	<p align="center">Lowest Channel</p>  <p>Center 1.8524 GHz 2 dB/ Mean Pwr + 20 dB</p> <p>Complementary Cumulative Distribution Function (100000 samples)</p> <p>Trace 1</p> <table border="0"> <tr><td>Mean</td><td>19.25 dBm</td></tr> <tr><td>Peak</td><td>22.63 dBm</td></tr> <tr><td>Crest</td><td>3.39 dB</td></tr> </table> <table border="0"> <tr><td>10 %</td><td>1.64 dB</td></tr> <tr><td>1 %</td><td>2.52 dB</td></tr> <tr><td>.1 %</td><td>3.00 dB</td></tr> <tr><td>.01 %</td><td>3.24 dB</td></tr> </table> <p>Date: 10.APR.2016 10:39:12</p>	Mean	19.25 dBm	Peak	22.63 dBm	Crest	3.39 dB	10 %	1.64 dB	1 %	2.52 dB	.1 %	3.00 dB	.01 %	3.24 dB
Mean	19.82 dBm																												
Peak	23.48 dBm																												
Crest	3.66 dB																												
10 %	1.76 dB																												
1 %	2.72 dB																												
.1 %	3.20 dB																												
.01 %	3.44 dB																												
Mean	19.25 dBm																												
Peak	22.63 dBm																												
Crest	3.39 dB																												
10 %	1.64 dB																												
1 %	2.52 dB																												
.1 %	3.00 dB																												
.01 %	3.24 dB																												
<p align="center">Middle Channel</p>  <p>Center 836.4 MHz 2 dB/ Mean Pwr + 20 dB</p> <p>Complementary Cumulative Distribution Function (100000 samples)</p> <p>Trace 1</p> <table border="0"> <tr><td>Mean</td><td>19.84 dBm</td></tr> <tr><td>Peak</td><td>23.62 dBm</td></tr> <tr><td>Crest</td><td>3.78 dB</td></tr> </table> <table border="0"> <tr><td>10 %</td><td>1.80 dB</td></tr> <tr><td>1 %</td><td>2.76 dB</td></tr> <tr><td>.1 %</td><td>3.32 dB</td></tr> <tr><td>.01 %</td><td>3.56 dB</td></tr> </table> <p>Date: 10.APR.2016 09:45:16</p>	Mean	19.84 dBm	Peak	23.62 dBm	Crest	3.78 dB	10 %	1.80 dB	1 %	2.76 dB	.1 %	3.32 dB	.01 %	3.56 dB	<p align="center">Middle Channel</p>  <p>Center 1.88 GHz 2 dB/ Mean Pwr + 20 dB</p> <p>Complementary Cumulative Distribution Function (100000 samples)</p> <p>Trace 1</p> <table border="0"> <tr><td>Mean</td><td>19.87 dBm</td></tr> <tr><td>Peak</td><td>23.55 dBm</td></tr> <tr><td>Crest</td><td>3.68 dB</td></tr> </table> <table border="0"> <tr><td>10 %</td><td>1.68 dB</td></tr> <tr><td>1 %</td><td>2.56 dB</td></tr> <tr><td>.1 %</td><td>3.08 dB</td></tr> <tr><td>.01 %</td><td>3.36 dB</td></tr> </table> <p>Date: 10.APR.2016 10:40:11</p>	Mean	19.87 dBm	Peak	23.55 dBm	Crest	3.68 dB	10 %	1.68 dB	1 %	2.56 dB	.1 %	3.08 dB	.01 %	3.36 dB
Mean	19.84 dBm																												
Peak	23.62 dBm																												
Crest	3.78 dB																												
10 %	1.80 dB																												
1 %	2.76 dB																												
.1 %	3.32 dB																												
.01 %	3.56 dB																												
Mean	19.87 dBm																												
Peak	23.55 dBm																												
Crest	3.68 dB																												
10 %	1.68 dB																												
1 %	2.56 dB																												
.1 %	3.08 dB																												
.01 %	3.36 dB																												
<p align="center">Highest Channel</p>  <p>Center 846.4 MHz 2 dB/ Mean Pwr + 20 dB</p> <p>Complementary Cumulative Distribution Function (100000 samples)</p> <p>Trace 1</p> <table border="0"> <tr><td>Mean</td><td>19.72 dBm</td></tr> <tr><td>Peak</td><td>23.41 dBm</td></tr> <tr><td>Crest</td><td>3.69 dB</td></tr> </table> <table border="0"> <tr><td>10 %</td><td>1.76 dB</td></tr> <tr><td>1 %</td><td>2.76 dB</td></tr> <tr><td>.1 %</td><td>3.32 dB</td></tr> <tr><td>.01 %</td><td>3.56 dB</td></tr> </table> <p>Date: 10.APR.2016 09:45:47</p>	Mean	19.72 dBm	Peak	23.41 dBm	Crest	3.69 dB	10 %	1.76 dB	1 %	2.76 dB	.1 %	3.32 dB	.01 %	3.56 dB	<p align="center">Highest Channel</p>  <p>Center 1.9076 GHz 2 dB/ Mean Pwr + 20 dB</p> <p>Complementary Cumulative Distribution Function (100000 samples)</p> <p>Trace 1</p> <table border="0"> <tr><td>Mean</td><td>19.57 dBm</td></tr> <tr><td>Peak</td><td>23.13 dBm</td></tr> <tr><td>Crest</td><td>3.56 dB</td></tr> </table> <table border="0"> <tr><td>10 %</td><td>1.72 dB</td></tr> <tr><td>1 %</td><td>2.60 dB</td></tr> <tr><td>.1 %</td><td>3.16 dB</td></tr> <tr><td>.01 %</td><td>3.40 dB</td></tr> </table> <p>Date: 10.APR.2016 10:38:21</p>	Mean	19.57 dBm	Peak	23.13 dBm	Crest	3.56 dB	10 %	1.72 dB	1 %	2.60 dB	.1 %	3.16 dB	.01 %	3.40 dB
Mean	19.72 dBm																												
Peak	23.41 dBm																												
Crest	3.69 dB																												
10 %	1.76 dB																												
1 %	2.76 dB																												
.1 %	3.32 dB																												
.01 %	3.56 dB																												
Mean	19.57 dBm																												
Peak	23.13 dBm																												
Crest	3.56 dB																												
10 %	1.72 dB																												
1 %	2.60 dB																												
.1 %	3.16 dB																												
.01 %	3.40 dB																												



26dB Bandwidth

Mode	WCDMA Band V	WCDMA Band II
Mod.	RMC 12.2Kbps	RMC 12.2Kbps
Lowest CH	4.67	4.73
Middle CH	4.69	4.73
Highest CH	4.69	4.74



Occupied Bandwidth

Mode	WCDMA Band V	WCDMA Band II
Mod.	RMC 12.2Kbps	RMC 12.2Kbps
Lowest CH	4.12	4.16
Middle CH	4.13	4.16
Highest CH	4.14	4.15

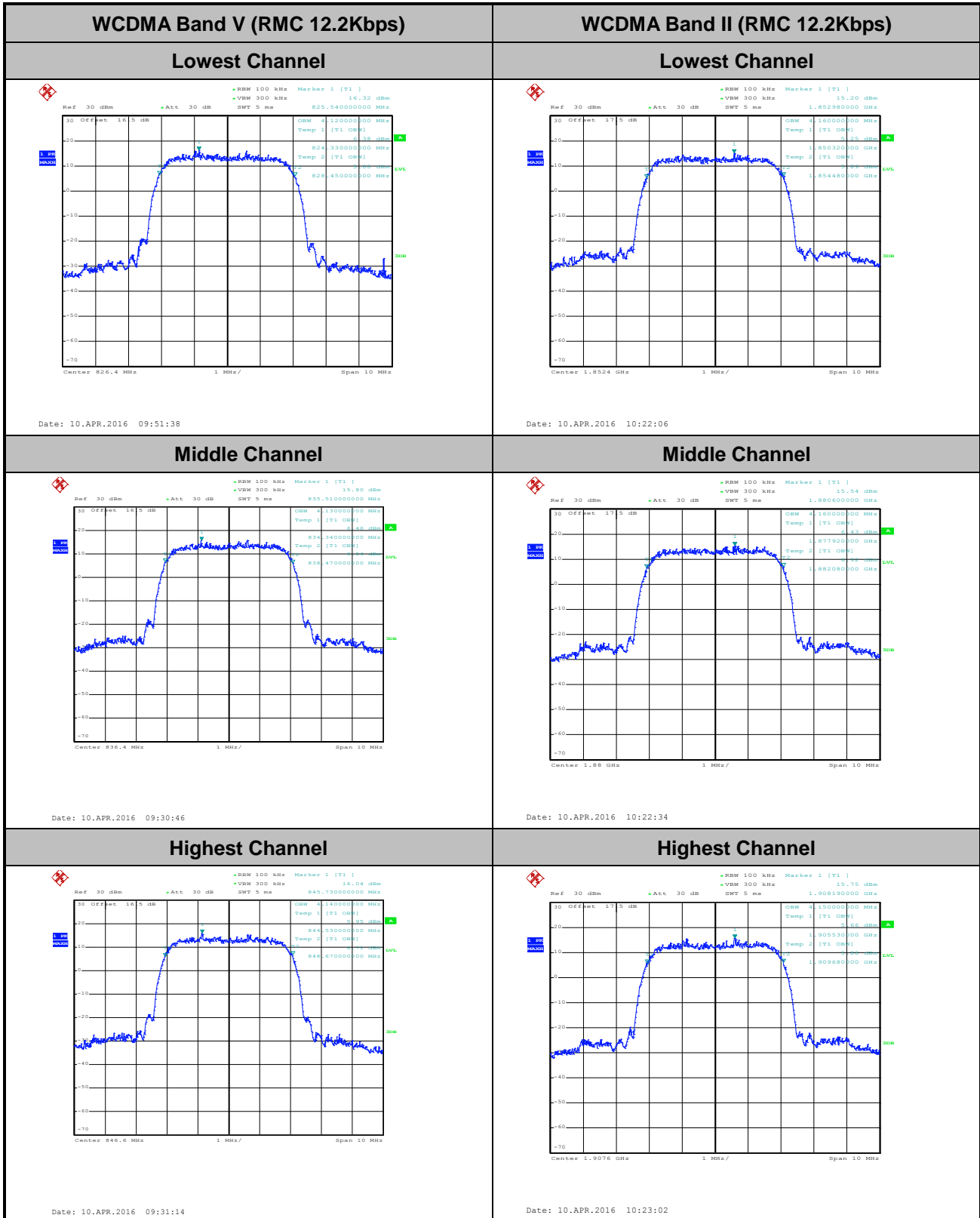



Conducted Band Edge

WCDMA Band V (RMC 12.2Kbps)

Lowest Band Edge

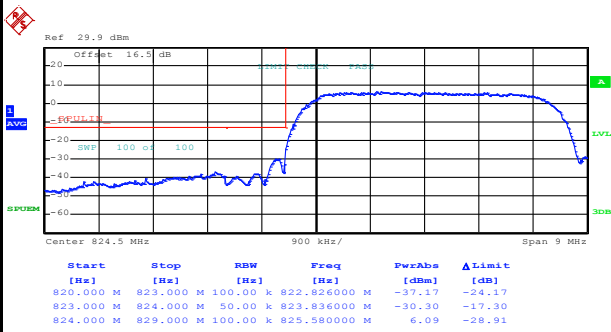

Date: 10.APR.2016 09:40:04

Highest Band Edge

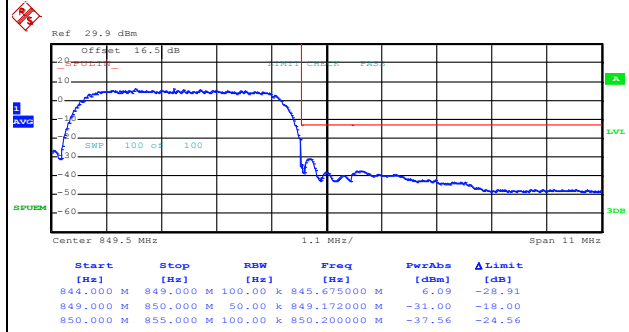

Date: 10.APR.2016 09:42:46



WCDMA Band II (RMC 12.2Kbps)

Lowest Band Edge

Highest Band Edge

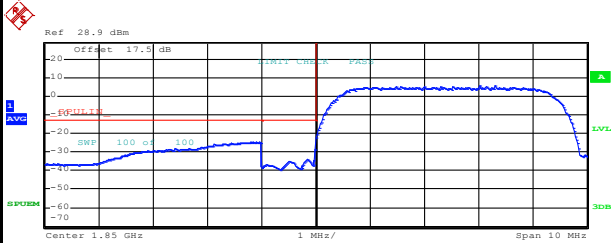

Start [Hz]	Stop [Hz]	RBW [Hz]	Freq [Hz]	PwrAbs [dBm]	ΔLimit [dB]
1.843 G	1.849 G	1.00 M	1.848904 G	-24.73	-11.73
1.849 G	1.850 G	50.00 k	1.849996 G	-29.76	-16.76
1.850 G	1.855 G	100.00 k	1.853295 G	5.57	-29.43

Date: 10.APR.2016 10:25:55

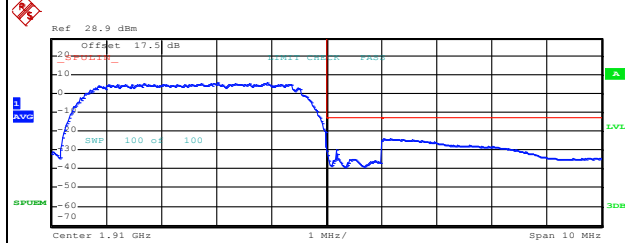

Start [Hz]	Stop [Hz]	RBW [Hz]	Freq [Hz]	PwrAbs [dBm]	ΔLimit [dB]
1.905 G	1.910 G	100.00 k	1.908915 G	5.74	-29.26
1.910 G	1.911 G	50.00 k	1.910004 G	-29.58	-16.58
1.911 G	1.915 G	1.00 M	1.911160 G	-24.24	-11.24

Date: 10.APR.2016 10:28:37



Conducted Spurious Emission

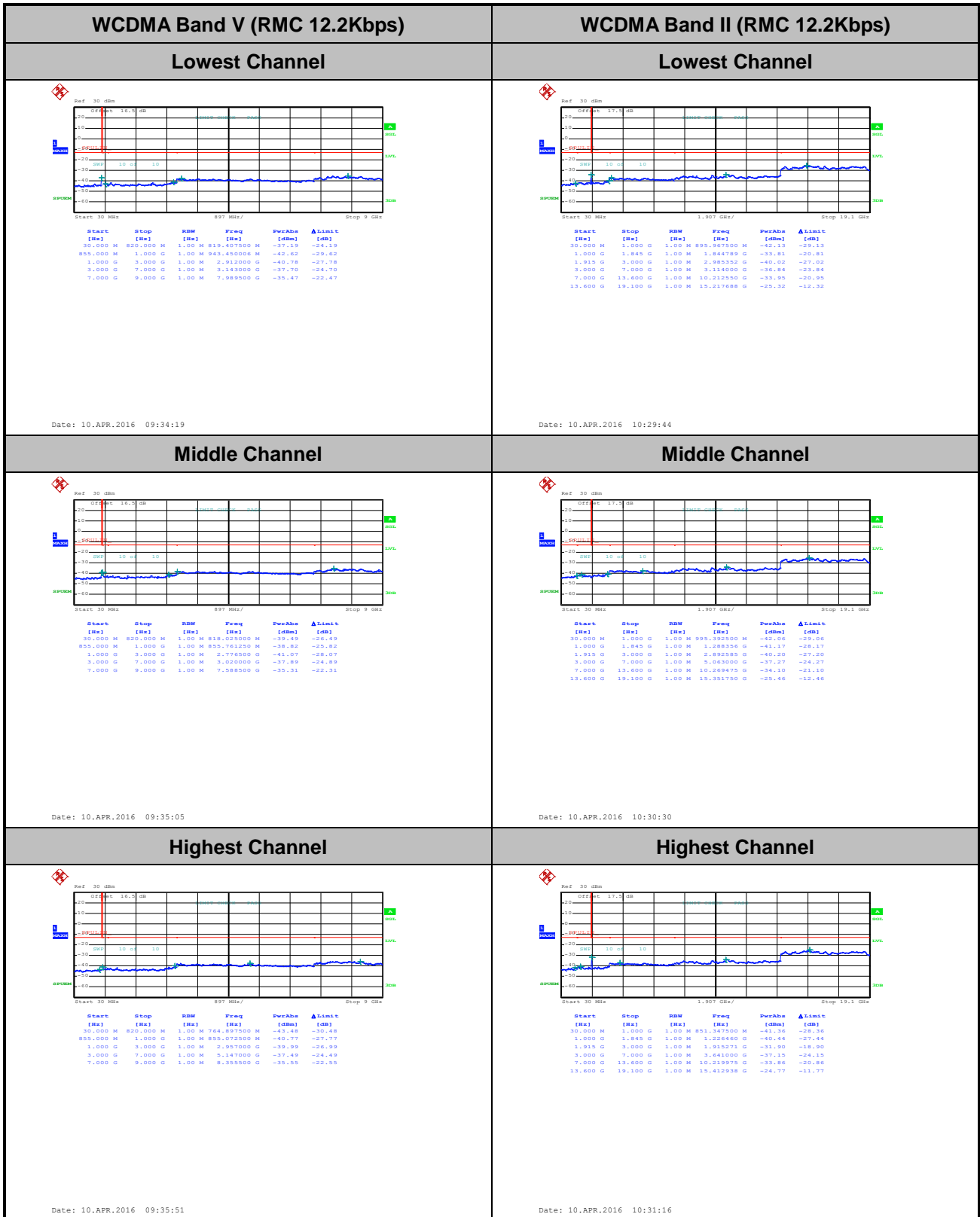



Frequency Stability

Test Conditions Temperature (°C)	Middle Channel Voltage (Volt)	WCDMA Band V (RMC 12.2Kbps)	Limit 2.5ppm
		Deviation (ppm)	Result
50	Normal Voltage	0.0012	PASS
40	Normal Voltage	0.0143	
30	Normal Voltage	0.0024	
20(Ref.)	Normal Voltage	0.0000	
10	Normal Voltage	0.0036	
0	Normal Voltage	0.0120	
-10	Normal Voltage	0.0143	
-20	Normal Voltage	0.0024	
-30	Normal Voltage	0.0155	
20	Maximum Voltage	0.0024	
20	Normal Voltage	0.0143	
20	Battery End Point	0.0012	

Note:

- 1. Normal Voltage = 3.8V. ; Battery End Point (BEP) = 3.4 V. ; Maximum Voltage =4.35 V
- 2. The frequency fundamental emissions stay within the authorized frequency block.



Test Conditions Temperature (°C)	Middle Channel Voltage (Volt)	WCDMA Band II (RMC 12.2Kbps)	Limit Note 2.
		Deviation (ppm)	Result
50	Normal Voltage	0.0021	PASS
40	Normal Voltage	0.0005	
30	Normal Voltage	0.0005	
20(Ref.)	Normal Voltage	0.0000	
10	Normal Voltage	0.0011	
0	Normal Voltage	0.0005	
-10	Normal Voltage	0.0011	
-20	Normal Voltage	0.0000	
-30	Normal Voltage	0.0005	
20	Maximum Voltage	0.0000	
20	Normal Voltage	0.0011	
20	Battery End Point	0.0016	

Note:

- 1. Normal Voltage = 3.8V. ; Battery End Point (BEP) = 3.4V. ; Maximum Voltage =4.35 V
- 2. The frequency fundamental emissions stay within the authorized frequency block.



A3. CDMA

Peak-to-Average Ratio

Mode	CDMA BC0	CDMA BC1	Limit: 13dB
Mod.	1xRTT	1xRTT	Result
Lowest CH	3.56	3.48	PASS
Middle CH	4.64	4.00	
Highest CH	4.40	3.52	

Mode	CDMA BC0	CDMA BC1	Limit: 13dB
Mod.	1xEV-DO Rev. 0	1xEV-DO Rev. 0	Result
Lowest CH	3.56	3.48	PASS
Middle CH	4.52	3.96	
Highest CH	4.40	3.48	

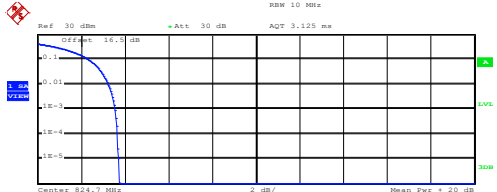
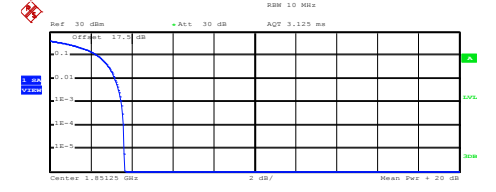
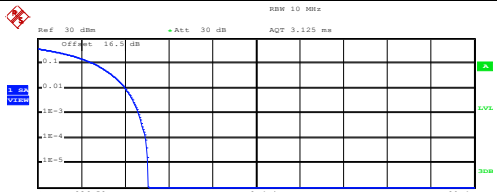
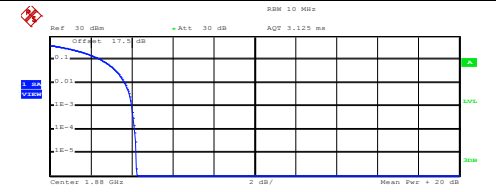
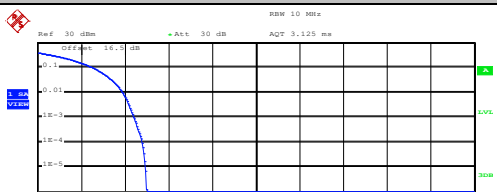
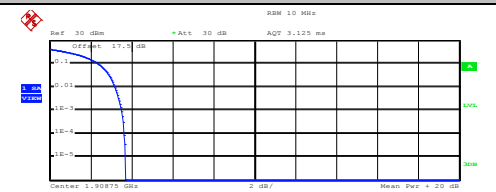

CDMA BC0 (1xRTT)	CDMA BC1 (1xRTT)
<p align="center">Lowest Channel</p>  <p>Center 824.7 MHz 2 dB/ Mean Pwr + 20 dB</p> <p>Complementary Cumulative Distribution Function (100000 samples)</p> <p>Trace 1</p> <p>Mean 23.76 dBm Peak 27.50 dBm Crest 3.74 dB</p> <p>10 % 2.32 dB 1 % 3.24 dB .1 % 3.56 dB .01 % 3.68 dB</p> <p>Date: 10.APR.2016 14:00:18</p>	<p align="center">Lowest Channel</p>  <p>Center 1.85125 GHz 2 dB/ Mean Pwr + 20 dB</p> <p>Complementary Cumulative Distribution Function (100000 samples)</p> <p>Trace 1</p> <p>Mean 23.37 dBm Peak 27.01 dBm Crest 3.63 dB</p> <p>10 % 2.36 dB 1 % 3.20 dB .1 % 3.48 dB .01 % 3.60 dB</p> <p>Date: 10.APR.2016 15:32:29</p>
<p align="center">Middle Channel</p>  <p>Center 836.52 MHz 2 dB/ Mean Pwr + 20 dB</p> <p>Complementary Cumulative Distribution Function (100000 samples)</p> <p>Trace 1</p> <p>Mean 23.71 dBm Peak 28.77 dBm Crest 5.06 dB</p> <p>10 % 2.60 dB 1 % 4.04 dB .1 % 4.64 dB .01 % 4.96 dB</p> <p>Date: 10.APR.2016 14:00:31</p>	<p align="center">Middle Channel</p>  <p>Center 1.88 GHz 2 dB/ Mean Pwr + 20 dB</p> <p>Complementary Cumulative Distribution Function (100000 samples)</p> <p>Trace 1</p> <p>Mean 24.04 dBm Peak 28.28 dBm Crest 4.23 dB</p> <p>10 % 2.52 dB 1 % 3.64 dB .1 % 4.00 dB .01 % 4.16 dB</p> <p>Date: 10.APR.2016 15:32:44</p>
<p align="center">Highest Channel</p>  <p>Center 848.31 MHz 2 dB/ Mean Pwr + 20 dB</p> <p>Complementary Cumulative Distribution Function (100000 samples)</p> <p>Trace 1</p> <p>Mean 23.49 dBm Peak 28.49 dBm Crest 5.00 dB</p> <p>10 % 2.56 dB 1 % 3.88 dB .1 % 4.40 dB .01 % 4.80 dB</p> <p>Date: 10.APR.2016 14:00:43</p>	<p align="center">Highest Channel</p>  <p>Center 1.90875 GHz 2 dB/ Mean Pwr + 20 dB</p> <p>Complementary Cumulative Distribution Function (100000 samples)</p> <p>Trace 1</p> <p>Mean 23.37 dBm Peak 27.08 dBm Crest 3.70 dB</p> <p>10 % 2.40 dB 1 % 3.20 dB .1 % 3.52 dB .01 % 3.64 dB</p> <p>Date: 10.APR.2016 15:33:04</p>

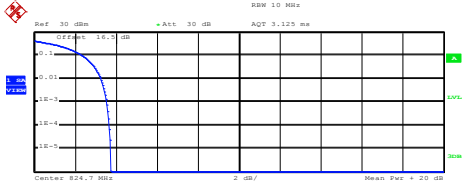
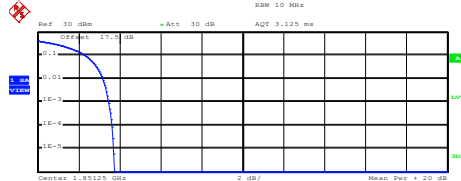
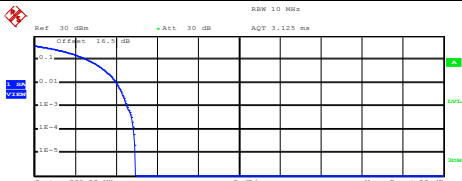
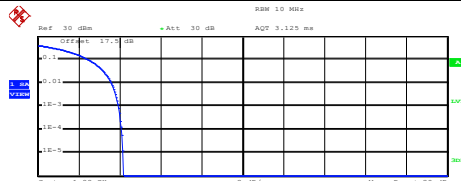
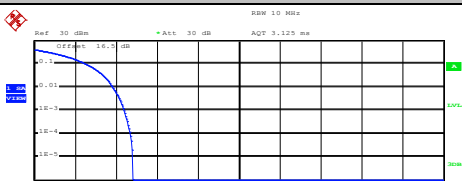
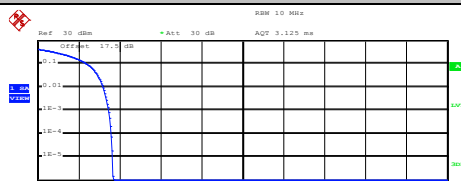

CDMA BC0 (1xEV-DO Rev. 0)	CDMA BC1 (1xEV-DO Rev. 0)																												
<p align="center">Lowest Channel</p>  <p>Center 824.7 MHz</p> <p>Complementary Cumulative Distribution Function (100000 samples) Trace 1</p> <table border="0"> <tr><td>Mean</td><td>23.75 dBm</td></tr> <tr><td>Peak</td><td>27.50 dBm</td></tr> <tr><td>Crest</td><td>3.75 dB</td></tr> </table> <table border="0"> <tr><td>10 %</td><td>2.36 dB</td></tr> <tr><td>1 %</td><td>3.24 dB</td></tr> <tr><td>.1 %</td><td>3.56 dB</td></tr> <tr><td>.01 %</td><td>3.68 dB</td></tr> </table> <p>Date: 10.APR.2016 14:29:27</p>	Mean	23.75 dBm	Peak	27.50 dBm	Crest	3.75 dB	10 %	2.36 dB	1 %	3.24 dB	.1 %	3.56 dB	.01 %	3.68 dB	<p align="center">Lowest Channel</p>  <p>Center 1.85123 GHz</p> <p>Complementary Cumulative Distribution Function (100000 samples) Trace 1</p> <table border="0"> <tr><td>Mean</td><td>23.36 dBm</td></tr> <tr><td>Peak</td><td>27.08 dBm</td></tr> <tr><td>Crest</td><td>3.72 dB</td></tr> </table> <table border="0"> <tr><td>10 %</td><td>2.32 dB</td></tr> <tr><td>1 %</td><td>3.20 dB</td></tr> <tr><td>.1 %</td><td>3.48 dB</td></tr> <tr><td>.01 %</td><td>3.64 dB</td></tr> </table> <p>Date: 10.APR.2016 16:58:28</p>	Mean	23.36 dBm	Peak	27.08 dBm	Crest	3.72 dB	10 %	2.32 dB	1 %	3.20 dB	.1 %	3.48 dB	.01 %	3.64 dB
Mean	23.75 dBm																												
Peak	27.50 dBm																												
Crest	3.75 dB																												
10 %	2.36 dB																												
1 %	3.24 dB																												
.1 %	3.56 dB																												
.01 %	3.68 dB																												
Mean	23.36 dBm																												
Peak	27.08 dBm																												
Crest	3.72 dB																												
10 %	2.32 dB																												
1 %	3.20 dB																												
.1 %	3.48 dB																												
.01 %	3.64 dB																												
<p align="center">Middle Channel</p>  <p>Center 836.52 MHz</p> <p>Complementary Cumulative Distribution Function (100000 samples) Trace 1</p> <table border="0"> <tr><td>Mean</td><td>23.77 dBm</td></tr> <tr><td>Peak</td><td>28.70 dBm</td></tr> <tr><td>Crest</td><td>4.93 dB</td></tr> </table> <table border="0"> <tr><td>10 %</td><td>2.64 dB</td></tr> <tr><td>1 %</td><td>4.00 dB</td></tr> <tr><td>.1 %</td><td>4.52 dB</td></tr> <tr><td>.01 %</td><td>4.84 dB</td></tr> </table> <p>Date: 10.APR.2016 14:29:41</p>	Mean	23.77 dBm	Peak	28.70 dBm	Crest	4.93 dB	10 %	2.64 dB	1 %	4.00 dB	.1 %	4.52 dB	.01 %	4.84 dB	<p align="center">Middle Channel</p>  <p>Center 1.88 GHz</p> <p>Complementary Cumulative Distribution Function (100000 samples) Trace 1</p> <table border="0"> <tr><td>Mean</td><td>24.12 dBm</td></tr> <tr><td>Peak</td><td>28.28 dBm</td></tr> <tr><td>Crest</td><td>4.16 dB</td></tr> </table> <table border="0"> <tr><td>10 %</td><td>2.48 dB</td></tr> <tr><td>1 %</td><td>3.60 dB</td></tr> <tr><td>.1 %</td><td>3.96 dB</td></tr> <tr><td>.01 %</td><td>4.08 dB</td></tr> </table> <p>Date: 10.APR.2016 16:58:42</p>	Mean	24.12 dBm	Peak	28.28 dBm	Crest	4.16 dB	10 %	2.48 dB	1 %	3.60 dB	.1 %	3.96 dB	.01 %	4.08 dB
Mean	23.77 dBm																												
Peak	28.70 dBm																												
Crest	4.93 dB																												
10 %	2.64 dB																												
1 %	4.00 dB																												
.1 %	4.52 dB																												
.01 %	4.84 dB																												
Mean	24.12 dBm																												
Peak	28.28 dBm																												
Crest	4.16 dB																												
10 %	2.48 dB																												
1 %	3.60 dB																												
.1 %	3.96 dB																												
.01 %	4.08 dB																												
<p align="center">Highest Channel</p>  <p>Center 848.31 MHz</p> <p>Complementary Cumulative Distribution Function (100000 samples) Trace 1</p> <table border="0"> <tr><td>Mean</td><td>23.60 dBm</td></tr> <tr><td>Peak</td><td>28.42 dBm</td></tr> <tr><td>Crest</td><td>4.82 dB</td></tr> </table> <table border="0"> <tr><td>10 %</td><td>2.56 dB</td></tr> <tr><td>1 %</td><td>3.84 dB</td></tr> <tr><td>.1 %</td><td>4.40 dB</td></tr> <tr><td>.01 %</td><td>4.72 dB</td></tr> </table> <p>Date: 10.APR.2016 14:29:58</p>	Mean	23.60 dBm	Peak	28.42 dBm	Crest	4.82 dB	10 %	2.56 dB	1 %	3.84 dB	.1 %	4.40 dB	.01 %	4.72 dB	<p align="center">Highest Channel</p>  <p>Center 1.90873 GHz</p> <p>Complementary Cumulative Distribution Function (100000 samples) Trace 1</p> <table border="0"> <tr><td>Mean</td><td>23.47 dBm</td></tr> <tr><td>Peak</td><td>27.15 dBm</td></tr> <tr><td>Crest</td><td>3.68 dB</td></tr> </table> <table border="0"> <tr><td>10 %</td><td>2.40 dB</td></tr> <tr><td>1 %</td><td>3.20 dB</td></tr> <tr><td>.1 %</td><td>3.48 dB</td></tr> <tr><td>.01 %</td><td>3.60 dB</td></tr> </table> <p>Date: 10.APR.2016 16:58:59</p>	Mean	23.47 dBm	Peak	27.15 dBm	Crest	3.68 dB	10 %	2.40 dB	1 %	3.20 dB	.1 %	3.48 dB	.01 %	3.60 dB
Mean	23.60 dBm																												
Peak	28.42 dBm																												
Crest	4.82 dB																												
10 %	2.56 dB																												
1 %	3.84 dB																												
.1 %	4.40 dB																												
.01 %	4.72 dB																												
Mean	23.47 dBm																												
Peak	27.15 dBm																												
Crest	3.68 dB																												
10 %	2.40 dB																												
1 %	3.20 dB																												
.1 %	3.48 dB																												
.01 %	3.60 dB																												



26dB Bandwidth

Mode	CDMA BC0	CDMA BC1
Mod.	1xRTT	1xRTT
Lowest CH	1.44	1.44
Middle CH	1.42	1.43
Highest CH	1.42	1.44

Mode	CDMA BC0	CDMA BC1
Mod.	1xEV-DO Rev. 0	1xEV-DO Rev. 0
Lowest CH	1.44	1.44
Middle CH	1.42	1.43
Highest CH	1.42	1.44



CDMA BC0 (1xRTT)

Lowest Channel

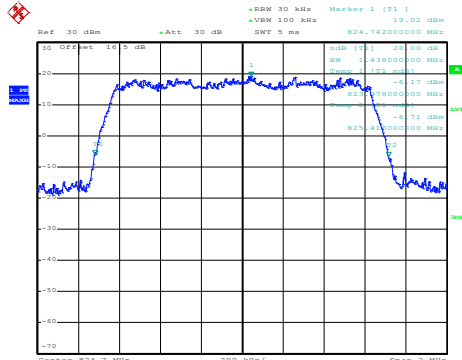

Date: 10.APR.2016 13:41:46

CDMA BC1 (1xRTT)

Lowest Channel

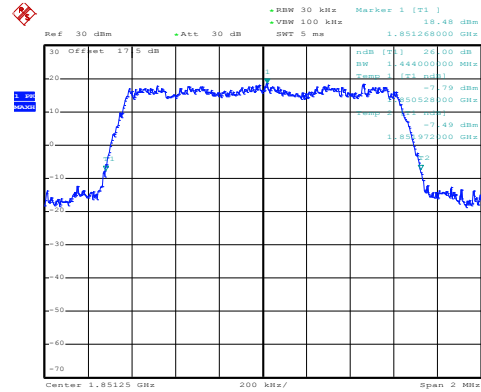

Date: 10.APR.2016 15:15:13

Middle Channel

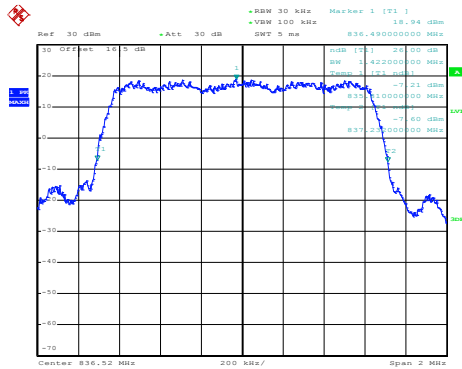

Date: 10.APR.2016 13:43:11

Middle Channel

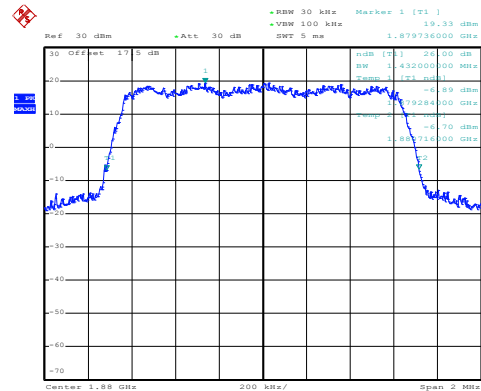

Date: 10.APR.2016 15:15:47

Highest Channel

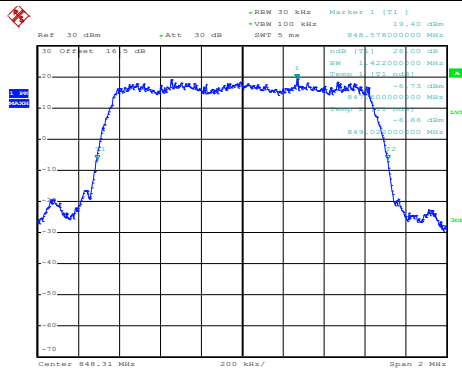

Date: 10.APR.2016 13:44:41

Highest Channel

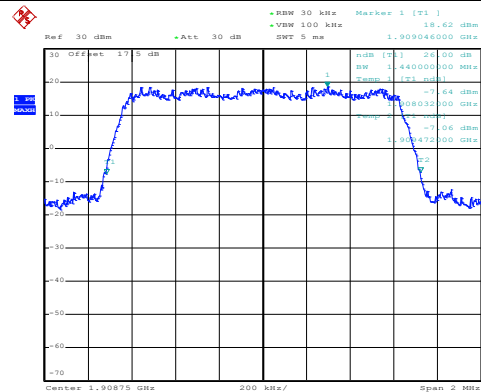

Date: 10.APR.2016 15:16:32



CDMA BC0 (1xEV-DO Rev. 0)

CDMA BC1 (1xEV-DO Rev. 0)

Lowest Channel

Lowest Channel

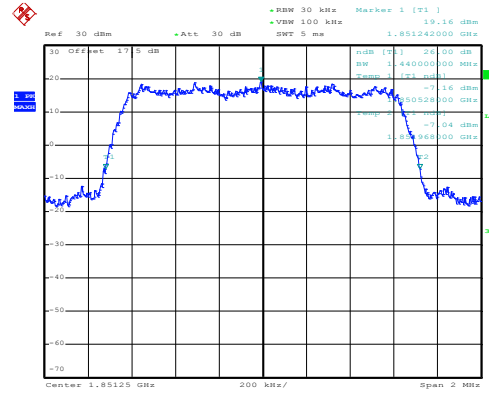
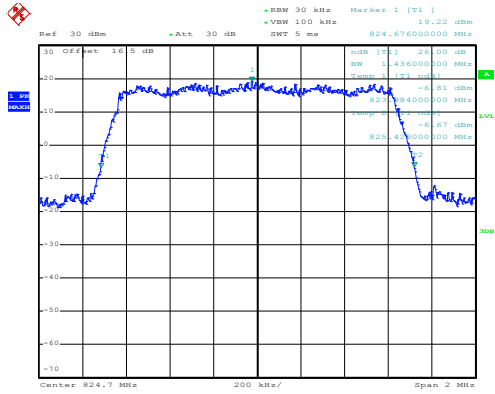

Date: 10.APR.2016 14:11:11

Date: 10.APR.2016 16:48:30

Middle Channel

Middle Channel

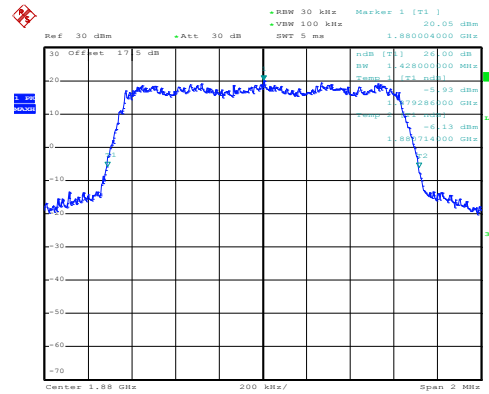
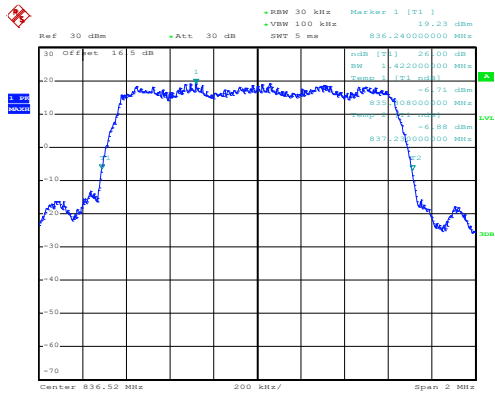

Date: 10.APR.2016 14:11:45

Date: 10.APR.2016 16:49:05

Highest Channel

Highest Channel

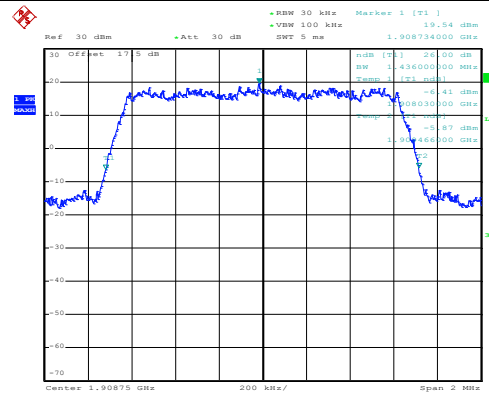
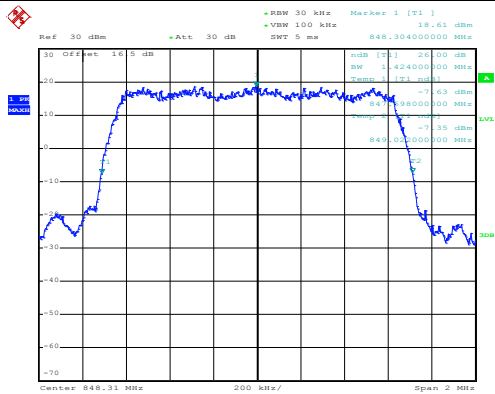

Date: 10.APR.2016 14:12:27

Date: 10.APR.2016 16:49:55



Occupied Bandwidth

Mode	CDMA BC0	CDMA BC1
Mod.	1xRTT	1xRTT
Lowest CH	1.28	1.28
Middle CH	1.28	1.28
Highest CH	1.28	1.28

Mode	CDMA BC0	CDMA BC1
Mod.	1xEV-DO Rev. 0	1xEV-DO Rev. 0
Lowest CH	1.28	1.29
Middle CH	1.27	1.28
Highest CH	1.28	1.28



CDMA BC0 (1xRTT)

Lowest Channel

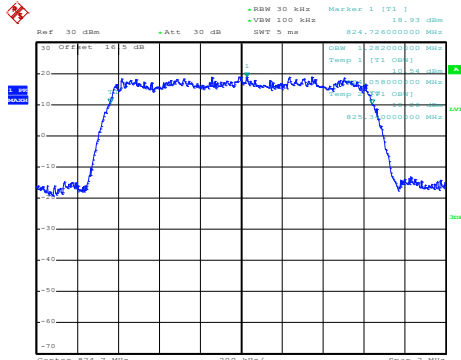

Date: 10.APR.2016 13:46:22

CDMA BC1 (1xRTT)

Lowest Channel

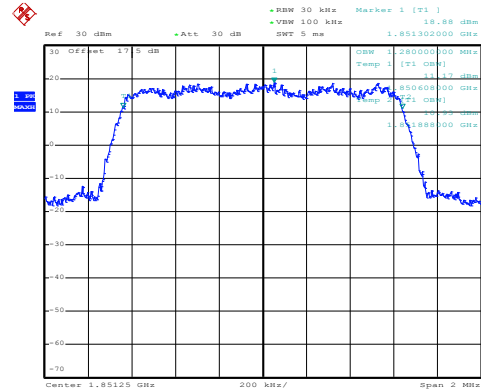

Date: 10.APR.2016 15:17:17

Middle Channel

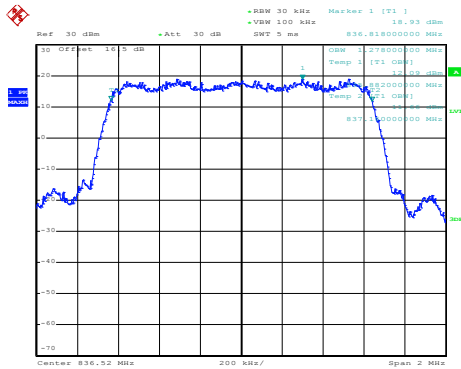

Date: 10.APR.2016 13:47:07

Middle Channel

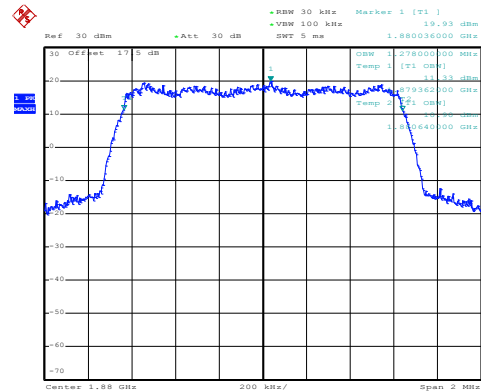

Date: 10.APR.2016 15:17:53

Highest Channel

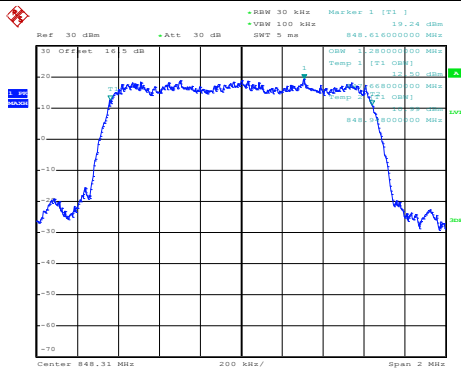

Date: 10.APR.2016 13:47:55

Highest Channel

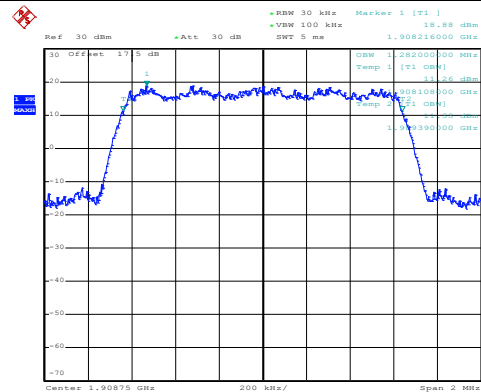

Date: 10.APR.2016 15:18:30



CDMA BC0 (1xEV-DO Rev. 0)

CDMA BC1 (1xEV-DO Rev. 0)

Lowest Channel

Lowest Channel

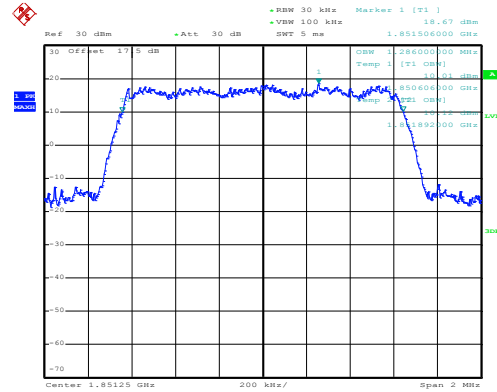
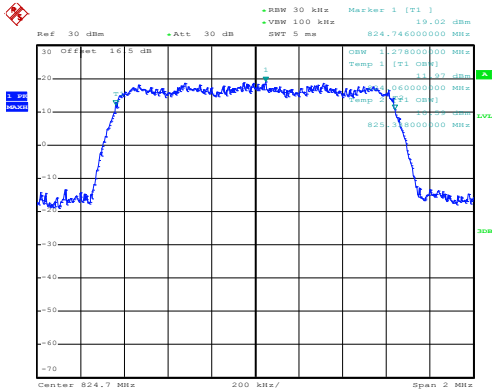

Date: 10.APR.2016 14:13:24

Date: 10.APR.2016 16:51:03

Middle Channel

Middle Channel

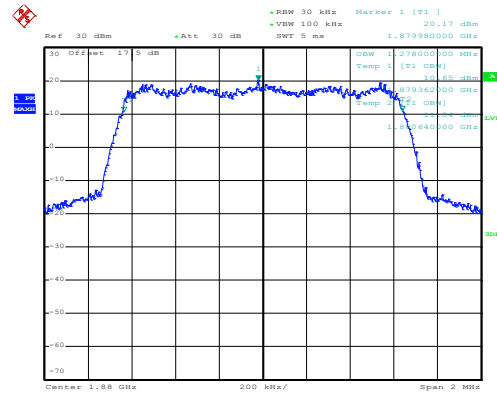
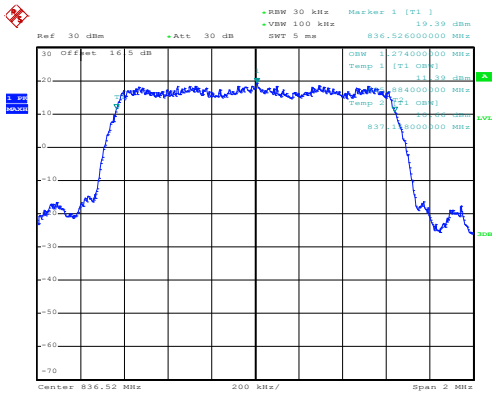

Date: 10.APR.2016 14:14:02

Date: 10.APR.2016 16:51:50

Highest Channel

Highest Channel

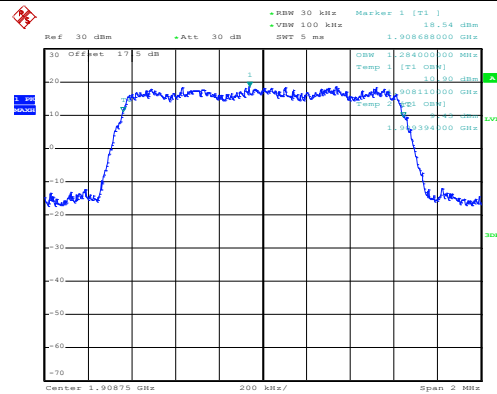
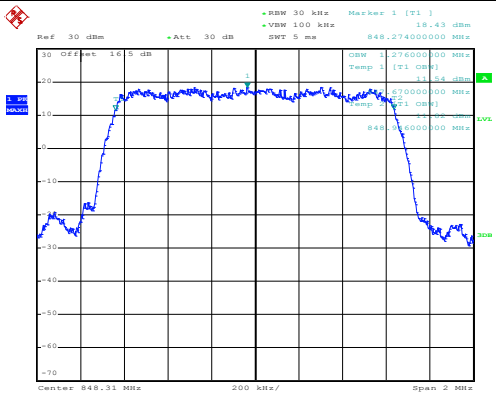

Date: 10.APR.2016 14:14:38

Date: 10.APR.2016 16:52:33



Conducted Band Edge

CDMA BC0 (1xRTT)

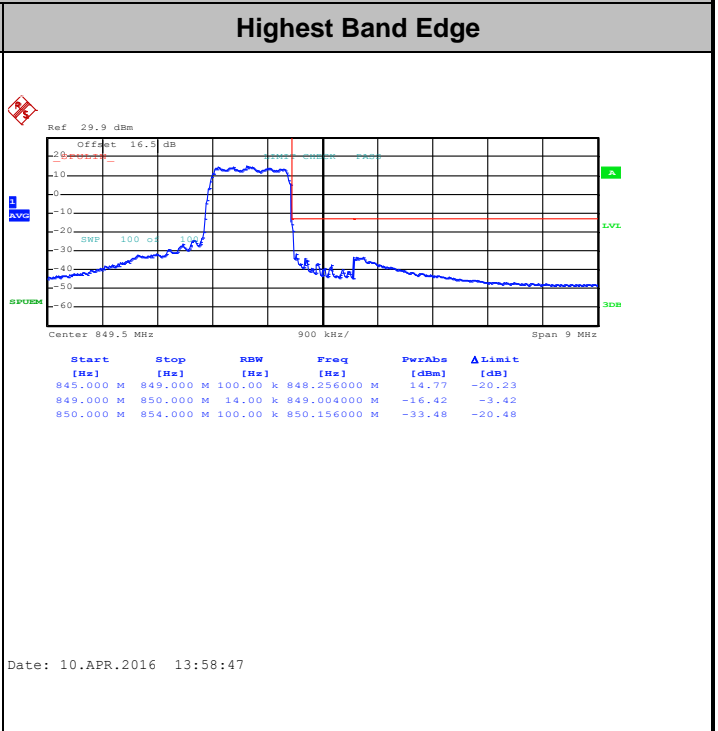
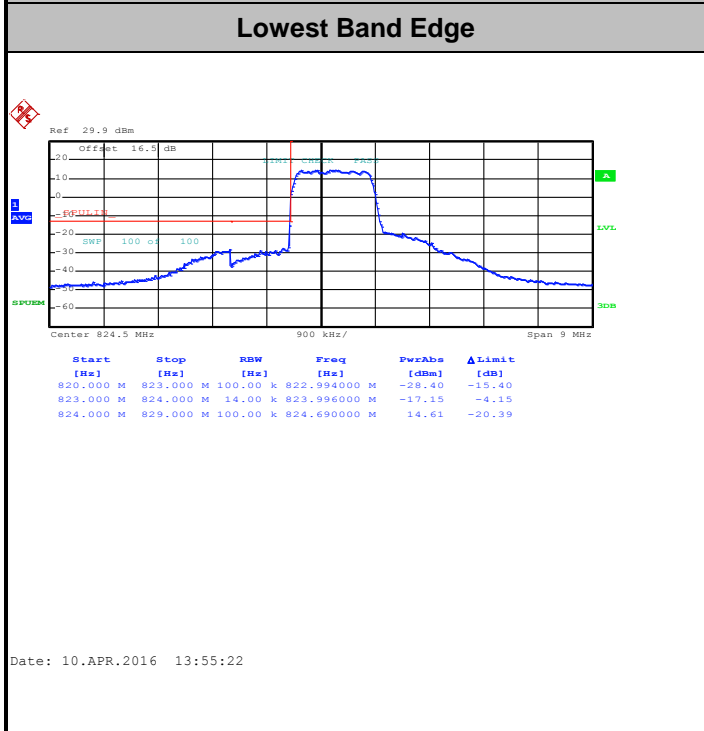

CDMA BC0 (1xEV-DO Rev. 0)

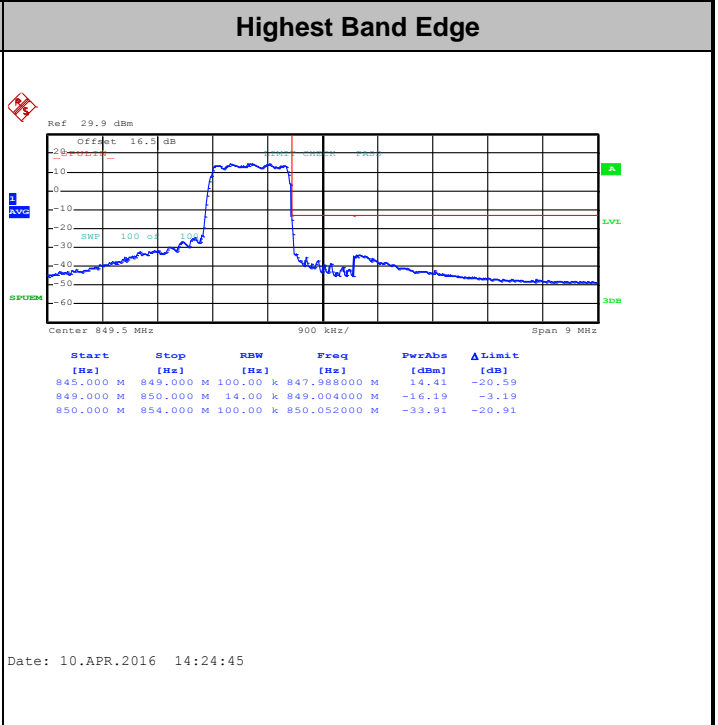
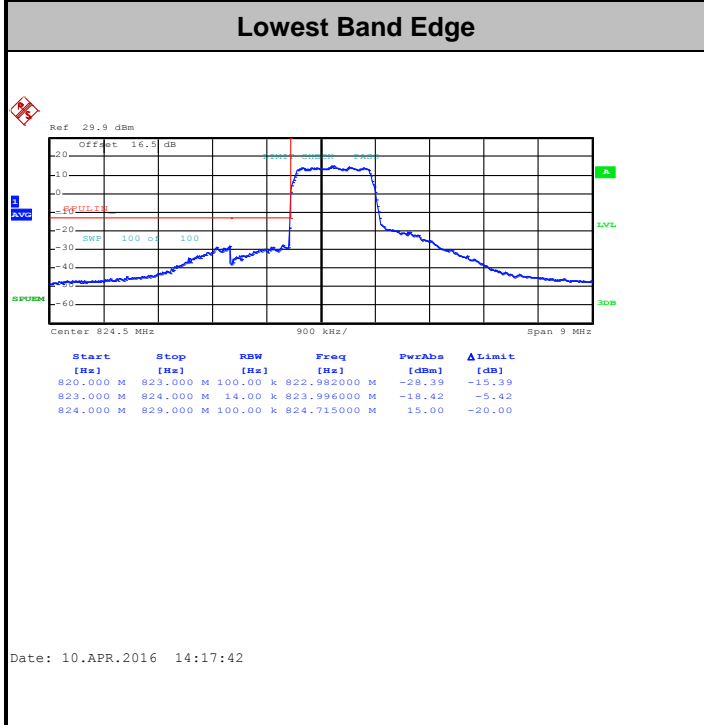



CDMA BC1 (1xRTT)

Lowest Band Edge

Highest Band Edge

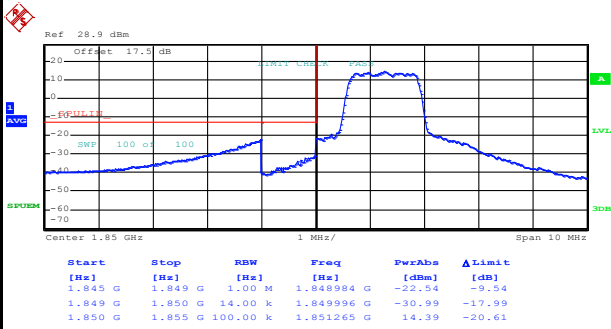

Date: 10.APR.2016 15:21:35

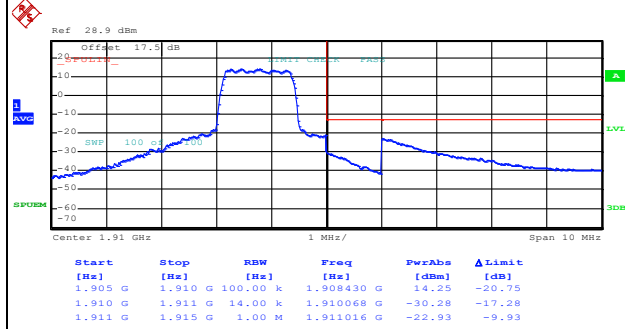

Date: 10.APR.2016 15:27:30

CDMA BC1 (1xEV-DO Rev. 0)

Lowest Band Edge

Highest Band Edge

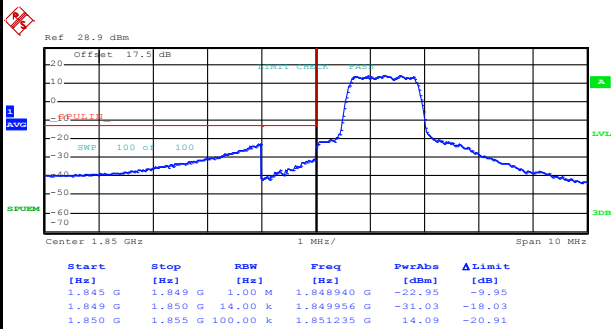

Date: 10.APR.2016 17:02:19

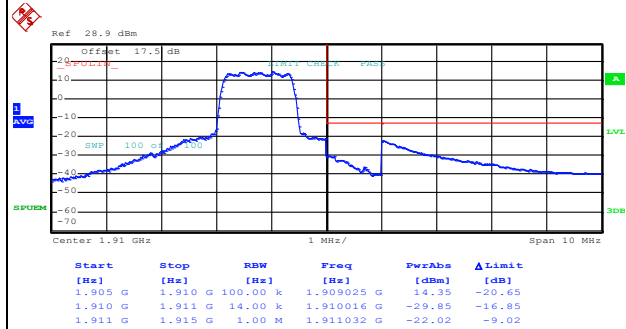

Date: 10.APR.2016 17:05:11



Conducted Spurious Emission

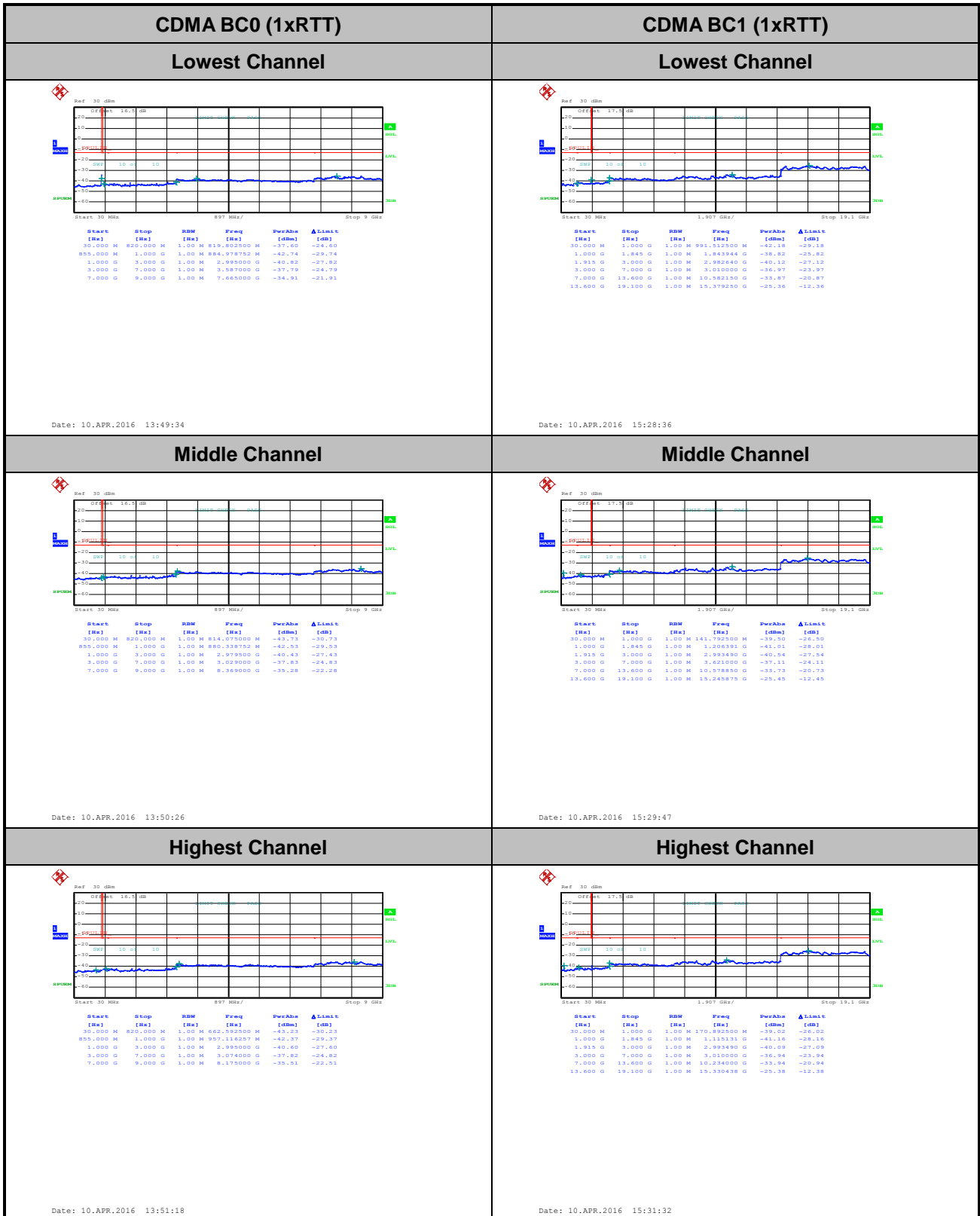

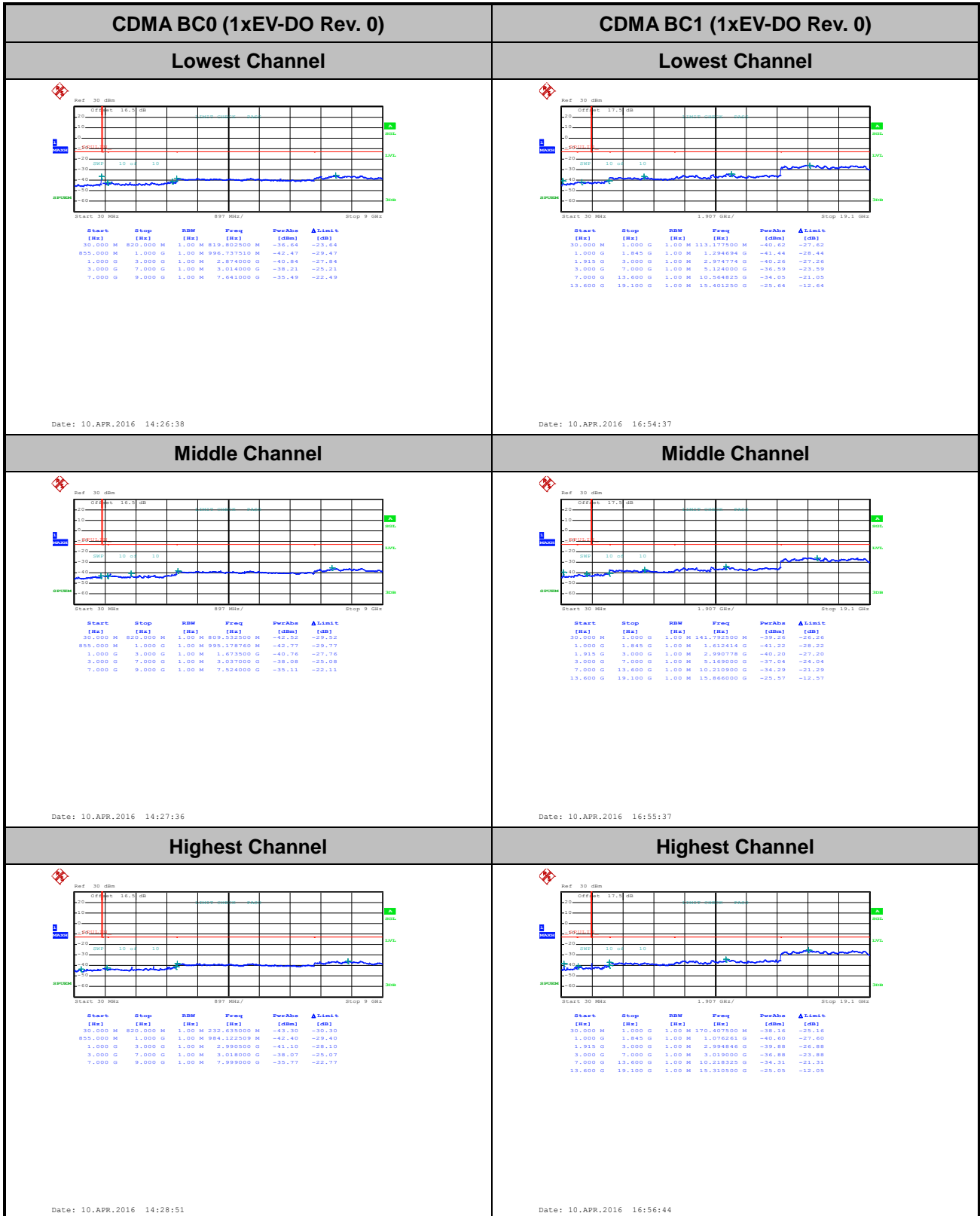



Frequency Stability

Test Conditions Temperature (°C)	Middle Channel Voltage (Volt)	CDMA BC0 (1xRTT)	Limit 2.5ppm
		Deviation (ppm)	Result
50	Normal Voltage	0.0036	PASS
40	Normal Voltage	0.0203	
30	Normal Voltage	0.0179	
20(Ref.)	Normal Voltage	0.0000	
10	Normal Voltage	0.0012	
0	Normal Voltage	0.0024	
-10	Normal Voltage	0.0000	
-20	Normal Voltage	0.0012	
-30	Normal Voltage	0.0048	
20	Maximum Voltage	0.0036	
20	Normal Voltage	0.0012	
20	Battery End Point	0.0012	

Note:

- 1. Normal Voltage = 3.8V. ; Battery End Point (BEP) = 3.4 V. ; Maximum Voltage =4.35 V
- 2. The frequency fundamental emissions stay within the authorized frequency block.



Test Conditions Temperature (°C)	Middle Channel Voltage (Volt)	CDMA BC0 (1xEV-DO Rev. 0)	Limit 2.5ppm
		Deviation (ppm)	Result
50	Normal Voltage	0.0215	PASS
40	Normal Voltage	0.0012	
30	Normal Voltage	0.0179	
20(Ref.)	Normal Voltage	0.0000	
10	Normal Voltage	0.0191	
0	Normal Voltage	0.0036	
-10	Normal Voltage	0.0012	
-20	Normal Voltage	0.0000	
-30	Normal Voltage	0.0024	
20	Maximum Voltage	0.0036	
20	Normal Voltage	0.0000	
20	Battery End Point	0.0048	

Note:

- 1. Normal Voltage = 3.8V. ; Battery End Point (BEP) = 3.4 V. ; Maximum Voltage =4.35 V
- 2. The frequency fundamental emissions stay within the authorized frequency block.



Test Conditions Temperature (°C)	Middle Channel Voltage (Volt)	CDMA BC1 (1xRTT)	Limit Note 2.
		Deviation (ppm)	Result
50	Normal Voltage	0.0085	PASS
40	Normal Voltage	0.0053	
30	Normal Voltage	0.0027	
20(Ref.)	Normal Voltage	0.0000	
10	Normal Voltage	0.0032	
0	Normal Voltage	0.0059	
-10	Normal Voltage	0.0106	
-20	Normal Voltage	0.0090	
-30	Normal Voltage	0.0053	
20	Maximum Voltage	0.0096	
20	Normal Voltage	0.0064	
20	Battery End Point	0.0074	

Note:

- 1. Normal Voltage = 3.8V. ; Battery End Point (BEP) = 3.4 V. ; Maximum Voltage =4.35 V
- 2. The frequency fundamental emissions stay within the authorized frequency block.



Test Conditions Temperature (°C)	Middle Channel Voltage (Volt)	CDMA BC1 (1xEV-DO Rev. 0)	Limit Note 2.
		Deviation (ppm)	Result
50	Normal Voltage	0.0032	PASS
40	Normal Voltage	0.0005	
30	Normal Voltage	0.0011	
20(Ref.)	Normal Voltage	0.0000	
10	Normal Voltage	0.0043	
0	Normal Voltage	0.0032	
-10	Normal Voltage	0.0016	
-20	Normal Voltage	0.0053	
-30	Normal Voltage	0.0048	
20	Maximum Voltage	0.0037	
20	Normal Voltage	0.0048	
20	Battery End Point	0.0043	

Note:

- 1. Normal Voltage = 3.8V. ; Battery End Point (BEP) = 3.4 V. ; Maximum Voltage =4.35 V
- 2. The frequency fundamental emissions stay within the authorized frequency block.



Appendix B. Test Results of Radiated Test

ERP/EIRP

GSM850 (GPRS class 8) Radiated Power ERP							
Horizontal Polarization							
Frequency (MHz)	LVL (dBm)	Tx Cable Loss (dB)	Tx ANT Gain (dBi)	SA Reading (dB)	Correction Factor (dB)	ERP (dBm)	ERP (W)
824.2	-2.29	9.34	0.48	-39.48	30.63	26.19	0.4159
836.4	-0.65	9.38	0.49	-39.53	30.64	27.84	0.6081
848.8	0.35	9.42	0.50	-39.61	30.69	28.89	0.7745
Vertical Polarization							
Frequency (MHz)	LVL (dBm)	Tx Cable Loss (dB)	Tx ANT Gain (dBi)	SA Reading (dB)	Correction Factor (dB)	ERP (dBm)	ERP (W)
824.2	-3.27	9.34	0.48	-41.55	32.70	27.28	0.5346
836.4	-1.48	9.38	0.49	-41.59	32.70	29.07	0.8072
848.8	-0.41	9.42	0.50	-41.73	32.81	30.25	1.0593

GSM850 (EDGE class 8) Radiated Power ERP							
Horizontal Polarization							
Frequency (MHz)	LVL (dBm)	Tx Cable Loss (dB)	Tx ANT Gain (dBi)	SA Reading (dB)	Correction Factor (dB)	ERP (dBm)	ERP (W)
824.2	-9.45	9.34	0.48	-39.42	30.57	18.97	0.0789
836.4	-8.67	9.38	0.49	-39.57	30.68	19.86	0.0968
848.8	-7.67	9.42	0.50	-39.63	30.71	20.89	0.1227
Vertical Polarization							
Frequency (MHz)	LVL (dBm)	Tx Cable Loss (dB)	Tx ANT Gain (dBi)	SA Reading (dB)	Correction Factor (dB)	ERP (dBm)	ERP (W)
824.2	-10.54	9.34	0.48	-41.56	32.71	20.02	0.1005
836.4	-9.28	9.38	0.49	-41.59	32.70	21.27	0.1340
848.8	-8.59	9.42	0.50	-41.71	32.79	22.05	0.1603

* ERP = LVL (dBm) + Correction Factor (dB) - 2.15

S.G. power = 0 (dBm)



WCDMA Band V (RMC 12.2Kbps) Radiated Power ERP							
Horizontal Polarization							
Frequency (MHz)	LVL (dBm)	Tx Cable Loss (dB)	Tx ANT Gain (dBi)	SA Reading (dB)	Correction Factor (dB)	ERP (dBm)	ERP (W)
826.4	-12.49	9.34	0.49	-39.45	30.59	15.95	0.0394
836.4	-11.80	9.38	0.49	-39.56	30.67	16.72	0.0470
846.6	-11.68	9.41	0.50	-39.65	30.73	16.90	0.0490
Vertical Polarization							
Frequency (MHz)	LVL (dBm)	Tx Cable Loss (dB)	Tx ANT Gain (dBi)	SA Reading (dB)	Correction Factor (dB)	ERP (dBm)	ERP (W)
826.4	-11.77	9.34	0.49	-41.48	32.62	18.70	0.0741
836.4	-10.99	9.38	0.49	-41.61	32.72	19.58	0.0908
846.6	-10.66	9.41	0.50	-41.76	32.84	20.03	0.1007

CDMA2000 BC0 1xRTT_RC1 SO55 Radiated Power ERP							
Horizontal Polarization							
Frequency (MHz)	LVL (dBm)	Tx Cable Loss (dB)	Tx ANT Gain (dBi)	SA Reading (dB)	Correction Factor (dB)	ERP (dBm)	ERP (W)
824.70	-10.80	9.34	0.48	-39.41	30.56	17.61	0.0577
836.52	-10.25	9.38	0.49	-39.54	30.65	18.25	0.0668
848.31	-11.95	9.42	0.50	-39.68	30.76	16.66	0.0463
Vertical Polarization							
Frequency (MHz)	LVL (dBm)	Tx Cable Loss (dB)	Tx ANT Gain (dBi)	SA Reading (dB)	Correction Factor (dB)	ERP (dBm)	ERP (W)
824.70	-12.33	9.34	0.48	-41.55	32.70	18.22	0.0664
836.52	-11.10	9.38	0.49	-41.69	32.80	19.55	0.0902
848.31	-11.38	9.42	0.50	-41.78	32.86	19.33	0.0857

* ERP = LVL (dBm) + Correction Factor (dB) - 2.15

S.G. power = 0 (dBm)



CDMA2000 BC0 1xEV-DO Rev. 0_RTAP 153.6Kbps							
Radiated Power ERP							
Horizontal Polarization							
Frequency (MHz)	LVL (dBm)	Tx Cable Loss (dB)	Tx ANT Gain (dBi)	SA Reading (dB)	Correction Factor (dB)	ERP (dBm)	ERP (W)
824.70	-13.67	9.34	0.48	-39.38	30.53	14.71	0.0296
836.52	-12.91	9.38	0.49	-39.48	30.59	15.53	0.0357
848.31	-12.80	9.42	0.50	-39.53	30.61	15.66	0.0368
Vertical Polarization							
Frequency (MHz)	LVL (dBm)	Tx Cable Loss (dB)	Tx ANT Gain (dBi)	SA Reading (dB)	Correction Factor (dB)	ERP (dBm)	ERP (W)
824.70	-13.88	9.34	0.48	-41.52	32.67	16.64	0.0461
836.52	-12.39	9.38	0.49	-41.65	32.76	18.22	0.0664
848.31	-11.96	9.42	0.50	-41.64	32.72	18.61	0.0726

* ERP = LVL (dBm) + Correction Factor (dB) - 2.15

S.G. power = 0 (dBm)



GSM1900 (GPRS class 8) Radiated Power EIRP							
Horizontal Polarization							
Frequency (MHz)	LVL (dBm)	Tx Cable Loss (dB)	Tx ANT Gain (dBi)	SA Reading (dB)	Correction Factor (dB)	EIRP (dBm)	EIRP (W)
1850.2	-18.74	6.35	9.53	-33.24	46.42	27.68	0.5861
1880.0	-18.23	6.40	9.64	-33.35	46.59	28.36	0.6855
1909.8	-17.63	6.46	9.75	-33.41	46.71	29.08	0.8091
Vertical Polarization							
Frequency (MHz)	LVL (dBm)	Tx Cable Loss (dB)	Tx ANT Gain (dBi)	SA Reading (dB)	Correction Factor (dB)	EIRP (dBm)	EIRP (W)
1850.2	-16.82	6.35	9.53	-31.93	45.11	28.29	0.6745
1880.0	-16.22	6.40	9.64	-32.06	45.30	29.08	0.8091
1909.8	-15.04	6.46	9.75	-32.13	45.43	30.39	1.0940

GSM1900 (EDGE class 8) Radiated Power EIRP							
Horizontal Polarization							
Frequency (MHz)	LVL (dBm)	Tx Cable Loss (dB)	Tx ANT Gain (dBi)	SA Reading (dB)	Correction Factor (dB)	EIRP (dBm)	EIRP (W)
1850.2	-23.97	6.35	9.53	-33.28	46.46	22.49	0.1774
1880.0	-23.31	6.40	9.64	-33.37	46.61	23.30	0.2138
1909.8	-22.65	6.46	9.75	-33.46	46.76	24.11	0.2576
Vertical Polarization							
Frequency (MHz)	LVL (dBm)	Tx Cable Loss (dB)	Tx ANT Gain (dBi)	SA Reading (dB)	Correction Factor (dB)	EIRP (dBm)	EIRP (W)
1850.2	-22.16	6.35	9.53	-31.99	45.17	23.01	0.2000
1880.0	-20.87	6.40	9.64	-32.09	45.33	24.46	0.2793
1909.8	-20.00	6.46	9.75	-32.15	45.45	25.45	0.3508

S.G. power = 10 (dBm)



WCDMA Band II (RMC 12.2Kbps) Radiated Power EIRP							
Horizontal Polarization							
Frequency (MHz)	LVL (dBm)	Tx Cable Loss (dB)	Tx ANT Gain (dBi)	SA Reading (dB)	Correction Factor (dB)	EIRP (dBm)	EIRP (W)
1852.4	-24.40	6.35	9.54	-33.27	46.45	22.05	0.1603
1880.0	-24.67	6.40	9.64	-33.34	46.58	21.91	0.1552
1907.6	-24.51	6.45	9.75	-33.45	46.74	22.23	0.1671
Vertical Polarization							
Frequency (MHz)	LVL (dBm)	Tx Cable Loss (dB)	Tx ANT Gain (dBi)	SA Reading (dB)	Correction Factor (dB)	EIRP (dBm)	EIRP (W)
1852.4	-22.40	6.35	9.54	-32.01	45.19	22.79	0.1901
1880.0	-22.50	6.40	9.64	-32.12	45.36	22.86	0.1932
1907.6	-21.62	6.45	9.75	-32.18	45.47	23.85	0.2427

CDMA2000 BC1 1xRTT_ RC1 SO55 Radiated Power EIRP							
Horizontal Polarization							
Frequency (MHz)	LVL (dBm)	Tx Cable Loss (dB)	Tx ANT Gain (dBi)	SA Reading (dB)	Correction Factor (dB)	EIRP (dBm)	EIRP (W)
1851.25	-24.10	6.35	9.53	-33.21	46.39	22.29	0.1694
1880.00	-24.43	6.40	9.64	-33.38	46.62	22.19	0.1656
1908.75	-24.54	6.45	9.75	-33.41	46.71	22.17	0.1648
Vertical Polarization							
Frequency (MHz)	LVL (dBm)	Tx Cable Loss (dB)	Tx ANT Gain (dBi)	SA Reading (dB)	Correction Factor (dB)	EIRP (dBm)	EIRP (W)
1851.25	-22.11	6.35	9.53	-32.04	45.22	23.11	0.2046
1880.00	-22.06	6.40	9.64	-32.19	45.43	23.37	0.2173
1908.75	-22.03	6.45	9.75	-32.24	45.54	23.51	0.2244

S.G. power = 10 (dBm)



CDMA2000 BC1 1xEV-DO Rev. 0_ RTAP 153.6Kbps							
Radiated Power EIRP							
Horizontal Polarization							
Frequency (MHz)	LVL (dBm)	Tx Cable Loss (dB)	Tx ANT Gain (dBi)	SA Reading (dB)	Correction Factor (dB)	EIRP (dBm)	EIRP (W)
1851.25	-24.07	6.35	9.53	-33.24	46.42	22.35	0.1718
1880.00	-23.83	6.40	9.64	-33.35	46.59	22.76	0.1888
1908.75	-23.99	6.45	9.75	-33.39	46.69	22.70	0.1862
Vertical Polarization							
Frequency (MHz)	LVL (dBm)	Tx Cable Loss (dB)	Tx ANT Gain (dBi)	SA Reading (dB)	Correction Factor (dB)	EIRP (dBm)	EIRP (W)
1851.25	-22.02	6.35	9.53	-32.11	45.29	23.27	0.2123
1880.00	-21.41	6.40	9.64	-32.23	45.47	24.06	0.2547
1908.75	-21.64	6.45	9.75	-32.38	45.68	24.04	0.2535

S.G. power = 10 (dBm)



Radiated Spurious Emission

GSM850 (GPRS class 8)									
Channel	Frequency (MHz)	ERP (dBm)	Limit (dBm)	Over Limit (dB)	SPA Reading (dBm)	S.G. Power (dBm)	TX Cable loss (dB)	TX Antenna Gain (dBi)	Polarization (H/V)
Lowest	1648	-31.04	-13	-18.04	-17.83	-32.8	0.98	4.89	H
	2472	-48.74	-13	-35.74	-39.45	-50.62	1.28	5.32	H
	3296	-63.87	-13	-50.87	-57.02	-67.28	1.54	7.10	H
	4120	-63.06	-13	-50.06	-57.81	-67.7	1.83	8.62	H
	1648	-33.32	-13	-20.32	-20.27	-35.08	0.98	4.89	V
	2472	-46.13	-13	-33.13	-36.85	-48.01	1.28	5.32	V
	3296	-66.69	-13	-53.69	-59.6	-70.1	1.54	7.10	V
	4120	-63.68	-13	-50.68	-58.28	-68.32	1.83	8.62	V
Middle	1672	-36.02	-13	-23.02	-22.96	-37.7	0.99	4.82	H
	2512	-47.93	-13	-34.93	-38.76	-49.9	1.29	5.41	H
	3344	-67.54	-13	-54.54	-60.8	-71.15	1.56	7.31	H
	4184	-65.26	-13	-52.26	-60.29	-69.88	1.87	8.64	H
	1672	-42.37	-13	-29.37	-29.43	-44.05	0.99	4.82	V
	2512	-46.77	-13	-33.77	-37.65	-48.74	1.29	5.41	V
	3344	-67.77	-13	-54.77	-60.77	-71.38	1.56	7.31	V
	4184	-65.83	-13	-52.83	-60.66	-70.45	1.87	8.64	V
Highest	1696	-40.49	-13	-27.49	-27.51	-42.09	1.00	4.75	H
	2544	-52.82	-13	-39.82	-43.77	-54.8	1.30	5.44	H
	3392	-67.62	-13	-54.62	-60.97	-71.42	1.57	7.52	H
	4240	-65.96	-13	-52.96	-61.29	-70.56	1.90	8.65	H
	1696	-40.94	-13	-27.94	-28.03	-42.54	1.00	4.75	V
	2544	-46.77	-13	-33.77	-37.76	-48.75	1.30	5.44	V
	3392	-67.43	-13	-54.43	-60.52	-71.23	1.57	7.52	V
	4240	-65.47	-13	-52.47	-60.57	-70.07	1.90	8.65	V

Remark: Spurious emissions within 30-1000MHz were found more than 20dB below limit line.



GSM850 (EDGE class 8)									
Channel	Frequency (MHz)	ERP (dBm)	Limit (dBm)	Over Limit (dB)	SPA Reading (dBm)	S.G. Power (dBm)	TX Cable loss (dB)	TX Antenna Gain (dBi)	Polarization (H/V)
Lowest	1648	-46.99	-13	-33.99	-33.77	-48.75	0.98	4.89	H
	2472	-62.44	-13	-49.44	-53.14	-64.32	1.28	5.32	H
	3296	-66.96	-13	-53.96	-60.1	-70.37	1.54	7.10	H
	1648	-47.60	-13	-34.60	-34.55	-49.36	0.98	4.89	V
	2472	-63.86	-13	-50.86	-54.58	-65.74	1.28	5.32	V
	3296	-67.63	-13	-54.63	-60.55	-71.04	1.54	7.10	V
Middle	1672	-48.93	-13	-35.93	-35.88	-50.61	0.99	4.82	H
	2512	-62.87	-13	-49.87	-53.71	-64.84	1.29	5.41	H
	3344	-67.62	-13	-54.62	-60.87	-71.23	1.56	7.31	H
	1672	-48.06	-13	-35.06	-35.1	-49.74	0.99	4.82	V
	2512	-62.98	-13	-49.98	-53.86	-64.95	1.29	5.41	V
	3344	-67.64	-13	-54.64	-60.63	-71.25	1.56	7.31	V
Highest	1696	-51.86	-13	-38.86	-38.88	-53.46	1.00	4.75	H
	2544	-65.11	-13	-52.11	-56.07	-67.09	1.30	5.44	H
	3392	-67.28	-13	-54.28	-60.63	-71.08	1.57	7.52	H
	1696	-51.41	-13	-38.41	-38.5	-53.01	1.00	4.75	V
	2544	-64.57	-13	-49.42	-53.42	-66.55	1.30	5.44	V
	3392	-69.88	-13	-54.73	-60.81	-73.68	1.57	7.52	V

Remark: Spurious emissions within 30-1000MHz were found more than 20dB below limit line.



GSM1900 (GPRS class 8)									
Channel	Frequency (MHz)	EIRP (dBm)	Limit (dBm)	Over Limit (dB)	SPA Reading (dBm)	S.G. Power (dBm)	TX Cable loss (dB)	TX Antenna Gain (dBi)	Polarization (H/V)
Lowest	3700	-45.24	-13	-32.24	-39.05	-51.81	1.67	8.24	H
	5548	-43.78	-13	-30.78	-44.35	-50.85	2.65	9.72	H
	7403	-55.00	-13	-42.00	-60.98	-64.15	2.46	11.61	H
	9251	-51.22	-13	-38.22	-61.2	-61.28	2.54	12.60	H
	11102	-50.82	-13	-37.82	-65.36	-60.59	2.69	12.46	H
	12954	-39.25	-13	-26.25	-56.26	-49.28	2.92	12.94	H
	14797	-50.05	-13	-37.05	-67.43	-59.89	3.51	13.36	H
	16650	-47.39	-13	-34.39	-70.47	-55.84	3.93	12.38	H
	3700	-44.00	-13	-31.00	-37.56	-50.57	1.67	8.24	V
	5548	-55.50	-13	-42.50	-56.03	-62.57	2.65	9.72	V
	7403	-54.09	-13	-41.09	-60.37	-63.24	2.46	11.61	V
	9251	-47.01	-13	-34.01	-55.56	-57.07	2.54	12.60	V
	11102	-48.24	-13	-35.24	-62.41	-58.01	2.69	12.46	V
	12954	-34.23	-13	-21.23	-50.44	-44.26	2.92	12.94	V
	14797	-50.50	-13	-37.50	-69.02	-60.34	3.51	13.36	V
16650	-49.72	-13	-36.72	-72.52	-58.17	3.93	12.38	V	
Middle	3756	-49.12	-13	-36.12	-42.99	-55.74	1.68	8.31	H
	5639	-52.07	-13	-39.07	-52.88	-59.12	2.71	9.76	H
	7522	-57.00	-13	-44.00	-63.26	-66.39	2.42	11.81	H
	9398	-51.47	-13	-38.47	-61.98	-61.44	2.57	12.54	H
	11282	-49.80	-13	-36.80	-64.53	-59.5	2.68	12.39	H
	13163	-34.46	-13	-21.46	-52.07	-44.72	2.97	13.23	H
	16916	-47.20	-13	-34.20	-70.77	-56.01	3.89	12.70	H
	3756	-49.98	-13	-36.98	-43.63	-56.6	1.68	8.31	V
	5639	-51.09	-13	-38.09	-51.84	-58.14	2.71	9.76	V
	7522	-54.02	-13	-41.02	-60.56	-63.41	2.42	11.81	V
	9398	-49.04	-13	-36.04	-57.9	-59.01	2.57	12.54	V
	11282	-51.45	-13	-38.45	-65.97	-61.15	2.68	12.39	V
	13163	-37.71	-13	-24.71	-54.48	-47.97	2.97	13.23	V
16916	-47.41	-13	-34.41	-70.85	-56.22	3.89	12.70	V	



Highest	3819	-40.24	-13	-27.24	-34.2	-46.92	1.70	8.38	H
	5730	-50.15	-13	-37.15	-51.19	-57.18	2.76	9.79	H
	7641	-55.90	-13	-42.90	-62.36	-65.4	2.38	11.88	H
	9552	-43.81	-13	-30.81	-54.87	-53.68	2.60	12.47	H
	11458	-48.09	-13	-35.09	-63.01	-57.72	2.68	12.32	H
	13372	-32.28	-13	-19.28	-50.4	-42.78	3.02	13.52	H
	3819	-45.21	-13	-32.21	-38.97	-51.89	1.70	8.38	V
	5730	-56.05	-13	-43.05	-57.02	-63.08	2.76	9.79	V
	7641	-59.01	-13	-46.01	-65.7	-68.51	2.38	11.88	V
	9552	-45.07	-13	-32.07	-54.32	-54.94	2.60	12.47	V
	11458	-46.40	-13	-33.40	-61.23	-56.03	2.68	12.32	V
	13372	-34.42	-13	-21.42	-51.68	-44.92	3.02	13.52	V

Remark: Spurious emissions within 30-1000MHz were found more than 20dB below limit line.



GSM1900 (EDGE class 8)									
Channel	Frequency (MHz)	EIRP (dBm)	Limit (dBm)	Over Limit (dB)	SPA Reading (dBm)	S.G. Power (dBm)	TX Cable loss (dB)	TX Antenna Gain (dBi)	Polarization (H/V)
Lowest	3700	-54.45	-13	-41.45	-48.26	-61.02	1.67	8.24	H
	5548	-54.96	-13	-41.96	-55.54	-62.03	2.65	9.72	H
	7403	-58.44	-13	-45.44	-64.42	-67.59	2.46	11.61	H
	9251	-57.68	-13	-44.68	-67.66	-67.74	2.54	12.60	H
	11102	-54.20	-13	-41.20	-68.74	-63.97	2.69	12.46	H
	12954	-41.57	-13	-28.57	-58.58	-51.6	2.92	12.94	H
	3700	-55.17	-13	-42.17	-48.73	-61.74	1.67	8.24	V
	5548	-63.28	-13	-50.28	-63.81	-70.35	2.65	9.72	V
	7403	-57.22	-13	-44.22	-63.5	-66.37	2.46	11.61	V
	9251	-52.66	-13	-39.66	-61.23	-62.72	2.54	12.60	V
	11102	-52.65	-13	-39.65	-66.82	-62.42	2.69	12.46	V
12954	-37.25	-13	-24.25	-53.46	-47.28	2.92	12.94	V	
Middle	3756	-54.15	-13	-41.15	-48.02	-60.77	1.68	8.31	H
	5639	-63.42	-13	-50.42	-64.23	-70.47	2.71	9.76	H
	7522	-59.76	-13	-46.76	-66.02	-69.15	2.42	11.81	H
	9398	-57.94	-13	-44.94	-68.45	-67.91	2.57	12.54	H
	11282	-54.67	-13	-41.67	-69.4	-64.37	2.68	12.39	H
	13163	-42.41	-13	-29.41	-59.98	-52.67	2.97	13.23	H
	3756	-57.21	-13	-44.21	-50.86	-63.83	1.68	8.31	V
	5639	-64.24	-13	-51.24	-64.99	-71.29	2.71	9.76	V
	7522	-57.29	-13	-44.29	-63.83	-66.68	2.42	11.81	V
	9398	-57.85	-13	-44.85	-66.71	-67.82	2.57	12.54	V
	11282	-54.56	-13	-41.56	-69.08	-64.26	2.68	12.39	V
13163	-39.09	-13	-26.09	-55.82	-49.35	2.97	13.23	V	
Highest	3819	-55.63	-13	-42.63	-49.59	-62.31	1.70	8.38	H
	5730	-61.83	-13	-48.83	-62.87	-68.86	2.76	9.79	H
	7641	-56.34	-13	-43.34	-62.8	-65.84	2.38	11.88	H
	9552	-56.69	-13	-43.69	-67.75	-66.56	2.60	12.47	H
	11463	-56.46	-13	-43.46	-71.38	-66.09	2.68	12.31	H
	13372	-38.19	-13	-25.19	-56.31	-48.69	3.02	13.52	H
	3819	-58.35	-13	-45.35	-52.11	-65.03	1.70	8.38	V
	5730	-61.11	-13	-48.11	-62.08	-68.14	2.76	9.79	V
	7641	-58.78	-13	-45.78	-65.47	-68.28	2.38	11.88	V
	9552	-57.34	-13	-44.34	-66.59	-67.21	2.60	12.47	V
	11463	-54.21	-13	-41.21	-69.05	-63.84	2.68	12.31	V
13372	-41.04	-13	-28.04	-58.3	-51.54	3.02	13.52	V	

Remark: Spurious emissions within 30-1000MHz were found more than 20dB below limit line.



WCDMA Band V (RMC 12.2Kbps)									
Channel	Frequency (MHz)	ERP (dBm)	Limit (dBm)	Over Limit (dB)	SPA Reading (dBm)	S.G. Power (dBm)	TX Cable loss (dB)	TX Antenna Gain (dBi)	Polarization (H/V)
Lowest	1656	-57.49	-13	-44.49	-44.35	-59.22	0.98	4.86	H
	2480	-68.41	-13	-55.41	-59.11	-70.32	1.28	5.34	H
	3304	-67.46	-13	-54.46	-60.63	-70.9	1.54	7.14	H
	1656	-58.20	-13	-45.20	-45.2	-59.93	0.98	4.86	V
	2480	-68.59	-13	-55.59	-59.29	-70.5	1.28	5.34	V
	3304	-67.56	-13	-54.56	-60.51	-71	1.54	7.14	V
Middle	1672	-57.65	-13	-44.65	-44.6	-59.33	0.99	4.82	H
	2512	-66.38	-13	-53.38	-57.22	-68.35	1.29	5.41	H
	3344	-67.75	-13	-54.75	-61	-71.36	1.56	7.31	H
	1672	-58.43	-13	-45.43	-45.47	-60.11	0.99	4.82	V
	2512	-66.67	-13	-53.67	-57.55	-68.64	1.29	5.41	V
	3344	-67.50	-13	-54.50	-60.5	-71.11	1.56	7.31	V
Highest	1696	-60.52	-13	-47.52	-47.54	-62.12	1.00	4.75	H
	2536	-67.48	-13	-54.48	-58.39	-69.46	1.30	5.43	H
	3384	-67.66	-13	-54.66	-60.98	-71.43	1.57	7.49	H
	1696	-60.40	-13	-47.40	-47.49	-62	1.00	4.75	V
	2536	-67.02	-13	-54.02	-57.94	-69	1.30	5.43	V
	3384	-67.47	-13	-54.47	-60.53	-71.24	1.57	7.49	V

Remark: Spurious emissions within 30-1000MHz were found more than 20dB below limit line.



WCDMA Band II (RMC 12.2Kbps)									
Channel	Frequency (MHz)	EIRP (dBm)	Limit (dBm)	Over Limit (dB)	SPA Reading (dBm)	S.G. Power (dBm)	TX Cable loss (dB)	TX Antenna Gain (dBi)	Polarization (H/V)
Lowest	3700	-60.63	-13	-47.63	-54.44	-67.2	1.67	8.24	H
	5557	-64.47	-13	-51.47	-65.04	-71.53	2.66	9.72	H
	7410	-58.66	-13	-45.66	-64.64	-67.82	2.46	11.62	H
	9258	-53.64	-13	-40.64	-63.67	-63.7	2.54	12.60	H
	3700	-64.14	-13	-51.14	-57.7	-70.71	1.67	8.24	V
	5557	-63.80	-13	-50.80	-64.33	-70.86	2.66	9.72	V
	7410	-56.59	-13	-43.59	-62.87	-65.75	2.46	11.62	V
	9258	-51.18	-13	-38.18	-59.79	-61.24	2.54	12.60	V
Middle	3756	-59.44	-13	-46.44	-53.31	-66.06	1.68	8.31	H
	5639	-64.45	-13	-51.45	-65.26	-71.5	2.71	9.76	H
	7515	-58.82	-13	-45.82	-65.05	-68.2	2.42	11.81	H
	9405	-50.70	-13	-37.70	-61.21	-60.67	2.57	12.54	H
	3756	-64.22	-13	-51.22	-57.87	-70.84	1.68	8.31	V
	5639	-64.41	-13	-51.41	-65.16	-71.46	2.71	9.76	V
	7515	-56.50	-13	-43.50	-63.02	-65.88	2.42	11.81	V
	9405	-51.50	-13	-38.50	-60.36	-61.47	2.57	12.54	V
Highest	3815	-61.37	-13	-48.37	-55.33	-68.04	1.70	8.38	H
	5723	-62.67	-13	-49.67	-63.71	-69.71	2.75	9.79	H
	7627	-58.58	-13	-45.58	-65.01	-68.07	2.39	11.88	H
	9538	-50.05	-13	-37.05	-61.05	-59.93	2.60	12.48	H
	3815	-62.77	-13	-49.77	-56.53	-69.44	1.70	8.38	V
	5723	-62.41	-13	-49.41	-63.38	-69.45	2.75	9.79	V
	7627	-58.10	-13	-45.10	-64.77	-67.59	2.39	11.88	V
	9538	-51.82	-13	-38.82	-61	-61.7	2.60	12.48	V

Remark: Spurious emissions within 30-1000MHz were found more than 20dB below limit line.



CDMA BC0 (1xRTT)									
Channel	Frequency (MHz)	ERP (dBm)	Limit (dBm)	Over Limit (dB)	SPA Reading (dBm)	S.G. Power (dBm)	TX Cable loss (dB)	TX Antenna Gain (dBi)	Polarization (H/V)
Lowest	1648	-58.85	-13	-45.85	-45.63	-60.61	0.98	4.89	H
	2472	-65.37	-13	-52.37	-56.07	-67.25	1.28	5.32	H
	3296	-67.00	-13	-54.00	-60.14	-70.41	1.54	7.10	H
	1648	-59.48	-13	-46.48	-46.43	-61.24	0.98	4.89	V
	2472	-61.36	-13	-48.36	-52.08	-63.24	1.28	5.32	V
	3296	-67.44	-13	-54.44	-60.35	-70.85	1.54	7.10	V
Middle	1672	-61.95	-13	-48.95	-48.89	-63.63	0.99	4.82	H
	2512	-68.45	-13	-55.45	-59.29	-70.42	1.29	5.41	H
	3344	-67.11	-13	-54.11	-60.36	-70.72	1.56	7.31	H
	1672	-60.63	-13	-47.63	-47.67	-62.31	0.99	4.82	V
	2512	-68.41	-13	-55.41	-59.29	-70.38	1.29	5.41	V
	3344	-67.69	-13	-54.69	-60.68	-71.3	1.56	7.31	V
Highest	1696	-60.98	-13	-47.98	-48	-62.58	1.00	4.75	H
	2544	-68.46	-13	-55.46	-59.42	-70.44	1.30	5.44	H
	3392	-67.20	-13	-54.20	-60.54	-71	1.57	7.52	H
	1696	-62.13	-13	-49.13	-49.22	-63.73	1.00	4.75	V
	2544	-68.38	-13	-55.38	-59.37	-70.36	1.30	5.44	V
	3392	-67.75	-13	-54.75	-60.84	-71.55	1.57	7.52	V

Remark: Spurious emissions within 30-1000MHz were found more than 20dB below limit line.



CDMA BC0 (1xEVDO Rev.0)									
Channel	Frequency (MHz)	ERP (dBm)	Limit (dBm)	Over Limit (dB)	SPA Reading (dBm)	S.G. Power (dBm)	TX Cable loss (dB)	TX Antenna Gain (dBi)	Polarization (H/V)
Lowest	1648	-54.55	-13	-41.55	-41.4	-56.31	0.98	4.89	H
	2474	-69.11	-13	-56.11	-59.86	-71	1.28	5.32	H
	3298	-68.23	-13	-55.23	-61.39	-71.65	1.54	7.11	H
	1648	-53.62	-13	-40.62	-40.59	-55.38	0.98	4.89	V
	2474	-67.40	-13	-54.40	-58.13	-69.29	1.28	5.32	V
	3298	-68.94	-13	-55.94	-61.86	-72.36	1.54	7.11	V
Middle	1672	-58.61	-13	-45.61	-45.56	-60.29	0.99	4.82	H
	2509	-69.69	-13	-56.69	-60.54	-71.65	1.29	5.41	H
	3344	-68.30	-13	-55.30	-61.58	-71.91	1.56	7.31	H
	1672	-57.72	-13	-44.72	-44.76	-59.4	0.99	4.82	V
	2509	-69.97	-13	-56.97	-60.85	-71.93	1.29	5.41	V
	3344	-69.39	-13	-56.39	-62.43	-73	1.56	7.31	V
Highest	1696	-60.82	-13	-47.82	-47.87	-62.42	1.00	4.75	H
	2544	-70.12	-13	-57.12	-61.1	-72.1	1.30	5.44	H
	3392	-68.46	-13	-55.46	-61.82	-72.26	1.57	7.52	H
	1696	-60.52	-13	-47.52	-47.61	-62.12	1.00	4.75	V
	2544	-70.25	-13	-57.25	-61.25	-72.23	1.30	5.44	V
	3392	-69.03	-13	-56.03	-62.18	-72.83	1.57	7.52	V

Remark: Spurious emissions within 30-1000MHz were found more than 20dB below limit line.



CDMA BC1 (1xRTT)									
Channel	Frequency (MHz)	EIRP (dBm)	Limit (dBm)	Over Limit (dB)	SPA Reading (dBm)	S.G. Power (dBm)	TX Cable loss (dB)	TX Antenna Gain (dBi)	Polarization (H/V)
Lowest	3700	-58.11	-13	-45.11	-51.95	-64.68	1.67	8.24	H
	5555	-63.54	-13	-50.54	-64.18	-70.61	2.66	9.72	H
	7403	-56.68	-13	-43.68	-62.68	-65.83	2.46	11.61	H
	9258	-48.41	-13	-35.41	-58.45	-58.47	2.54	12.60	H
	12954	-47.28	-13	-34.28	-64.38	-57.31	2.92	12.94	H
	3700	-62.84	-13	-49.84	-56.46	-69.41	1.67	8.24	V
	5555	-63.58	-13	-50.58	-64.14	-70.65	2.66	9.72	V
	7403	-53.53	-13	-40.53	-59.86	-62.68	2.46	11.61	V
	9258	-44.83	-13	-31.83	-53.46	-54.89	2.54	12.60	V
12954	-48.71	-13	-35.71	-64.95	-58.74	2.92	12.94	V	
Middle	3756	-57.98	-13	-44.98	-51.85	-64.6	1.68	8.31	H
	5639	-61.86	-13	-48.86	-62.7	-68.91	2.71	9.76	H
	7522	-56.22	-13	-43.22	-62.5	-65.61	2.42	11.81	H
	9398	-48.09	-13	-35.09	-58.61	-58.06	2.57	12.54	H
	13163	-46.20	-13	-33.20	-63.77	-56.46	2.97	13.23	H
	3756	-61.97	-13	-48.97	-55.64	-68.59	1.68	8.31	V
	5639	-63.91	-13	-50.91	-64.68	-70.96	2.71	9.76	V
	7522	-52.27	-13	-39.27	-58.81	-61.66	2.42	11.81	V
	9398	-47.42	-13	-34.42	-56.34	-57.39	2.57	12.54	V
13163	-47.35	-13	-34.35	-64.09	-57.61	2.97	13.23	V	
Highest	3819	-59.14	-13	-46.14	-53.1	-65.82	1.70	8.38	H
	5730	-59.55	-13	-46.55	-60.59	-66.58	2.76	9.79	H
	7634	-56.66	-13	-43.66	-63.09	-66.15	2.39	11.88	H
	9545	-47.50	-13	-34.50	-58.56	-57.37	2.60	12.47	H
	13363	-47.29	-13	-34.29	-65.36	-57.78	3.02	13.51	H
	3819	-60.55	-13	-47.55	-54.31	-67.23	1.70	8.38	V
	5730	-59.19	-13	-46.19	-60.16	-66.22	2.76	9.79	V
	7634	-54.55	-13	-41.55	-61.22	-64.04	2.39	11.88	V
	9545	-48.53	-13	-35.53	-57.78	-58.4	2.60	12.47	V
13363	-46.56	-13	-33.56	-63.78	-57.05	3.02	13.51	V	

Remark: Spurious emissions within 30-1000MHz were found more than 20dB below limit line.



CDMA BC1 (1xEVDO Rev.0)									
Channel	Frequency (MHz)	EIRP (dBm)	Limit (dBm)	Over Limit (dB)	SPA Reading (dBm)	S.G. Power (dBm)	TX Cable loss (dB)	TX Antenna Gain (dBi)	Polarization (H/V)
Lowest	3700	-58.63	-13	-45.63	-52.46	-65.2	1.67	8.24	H
	5555	-61.83	-13	-48.83	-62.4	-68.9	2.66	9.72	H
	7403	-57.26	-13	-44.26	-63.25	-66.41	2.46	11.61	H
	9258	-48.23	-13	-35.23	-58.26	-58.29	2.54	12.60	H
	11102	-56.34	-13	-43.34	-70.88	-66.11	2.69	12.46	H
	12955	-48.46	-13	-35.46	-65.49	-58.49	2.92	12.95	H
	3700	-63.00	-13	-50.00	-56.56	-69.57	1.67	8.24	V
	5555	-61.28	-13	-48.28	-61.84	-68.35	2.66	9.72	V
	7403	-54.07	-13	-41.07	-60.37	-63.22	2.46	11.61	V
	9258	-44.85	-13	-31.85	-53.47	-54.91	2.54	12.60	V
	11102	-56.28	-13	-43.28	-70.45	-66.05	2.69	12.46	V
	12955	-48.48	-13	-35.48	-64.71	-58.51	2.92	12.95	V
Middle	3763	-57.53	-13	-44.53	-51.44	-64.16	1.69	8.32	H
	5639	-61.75	-13	-48.75	-62.57	-68.8	2.71	9.76	H
	7522	-56.16	-13	-43.16	-62.42	-65.55	2.42	11.81	H
	9398	-48.84	-13	-35.84	-59.38	-58.81	2.57	12.54	H
	11282	-56.40	-13	-43.40	-71.14	-66.1	2.68	12.39	H
	13163	-44.29	-13	-31.29	-61.95	-54.55	2.97	13.23	H
	3756	-62.19	-13	-49.19	-55.86	-68.81	1.68	8.31	V
	5639	-62.07	-13	-49.07	-62.83	-69.12	2.71	9.76	V
	7522	-53.02	-13	-40.02	-59.58	-62.41	2.42	11.81	V
	9398	-47.34	-13	-34.34	-56.24	-57.31	2.57	12.54	V
	11282	-55.71	-13	-42.71	-70.29	-65.41	2.68	12.39	V
	13163	-45.10	-13	-32.10	-61.86	-55.36	2.97	13.23	V
Highest	3819	-60.16	-13	-47.16	-54.13	-66.84	1.70	8.38	H
	5723	-57.76	-13	-44.76	-58.81	-64.8	2.75	9.79	H
	7634	-55.19	-13	-42.19	-61.64	-64.68	2.39	11.88	H
	9545	-50.25	-13	-37.25	-61.38	-60.12	2.60	12.47	H
	11460	-56.27	-13	-43.27	-71.19	-65.9	2.68	12.32	H
	13363	-46.36	-13	-33.36	-64.45	-56.85	3.02	13.51	H
	3819	-61.55	-13	-48.55	-55.31	-68.23	1.70	8.38	V
	5730	-57.66	-13	-44.66	-58.63	-64.69	2.76	9.79	V
	7634	-51.36	-13	-38.36	-58.05	-60.85	2.39	11.88	V
	9545	-50.64	-13	-37.64	-59.89	-60.51	2.60	12.47	V
	11460	-55.83	-13	-42.83	-70.71	-65.46	2.68	12.32	V
	13363	-45.92	-13	-32.92	-63.21	-56.41	3.02	13.51	V

Remark: Spurious emissions within 30-1000MHz were found more than 20dB below limit line.