



FCC RF Test Report

APPLICANT : Motorola Mobility, LLC
EQUIPMENT : Mobile Cellular Phone
BRAND NAME : Motorola
MODEL NAME : 6918
FCC ID : IHDT56VA5
STANDARD : FCC 47 CFR Part 2, and 90(S)
CLASSIFICATION : PCS Licensed Transmitter Held to Ear (PCE)

The product was received on Feb. 03, 2016 and testing was completed on Mar. 30, 2016. We, SPORTON INTERNATIONAL INC., would like to declare that the tested sample has been evaluated in accordance with the procedures given in ANSI / TIA / EIA-603-D-2010 and shown compliance with the applicable technical standards.

The test results in this report apply exclusively to the tested model / sample. Without written approval of SPORTON INTERNATIONAL INC., the test report shall not be reproduced except in full.

Reviewed by: Joseph Lin / Supervisor

Approved by: Jones Tsai / Manager



SPORTON INTERNATIONAL INC.

No. 52, Hwa Ya 1st Rd., Hwa Ya Technology Park, Kwei-Shan District, Tao Yuan City, Taiwan, R.O.C.



TABLE OF CONTENTS

REVISION HISTORY..... 3

SUMMARY OF TEST RESULT 4

1 GENERAL DESCRIPTION 5

 1.1 Applicant..... 5

 1.2 Manufacturer 5

 1.3 Feature of Equipment Under Test..... 5

 1.4 Product Specification of Equipment Under Test 6

 1.5 Modification of EUT 6

 1.6 Maximum Frequency Tolerance and Emission Designator 6

 1.7 Testing Site..... 7

 1.8 Applied Standards 7

2 TEST CONFIGURATION OF EQUIPMENT UNDER TEST 8

 2.1 Test Mode..... 8

 2.2 Connection Diagram of Test System 9

 2.3 Support Unit used in test configuration and system 9

 2.4 Measurement Results Explanation Example 9

3 TEST RESULT 10

 3.1 Conducted Output Power Measurement..... 10

 3.2 99% Occupied Bandwidth and 26dB Bandwidth Measurement..... 11

 3.3 Emissions Mask Measurement 12

 3.4 Emissions Mask – Out Of Band Emissions Measurement..... 14

 3.5 Field Strength of Spurious Radiation Measurement 16

 3.6 Frequency Stability Measurement..... 18

4 LIST OF MEASURING EQUIPMENT 20

5 UNCERTAINTY OF EVALUATION 21

APPENDIX A. TEST RESULTS OF CONDUCTED TEST

APPENDIX B. TEST RESULTS OF RADIATED TEST



SUMMARY OF TEST RESULT

| Report Section | FCC Rule | Description | Limit | Result | Remark |
|----------------|--------------------|--|-------------------------------------|--------|--|
| 3.1 | §2.1046 | Conducted Output Power | N/A , Reporting only | PASS | - |
| 3.2 | §2.1049 §90.209 | Occupied Bandwidth and 26dB Bandwidth | N/A (Reporting only) | PASS | - |
| 3.3 | §2.1051 §90.691 | Emission masks – In-band emissions | $< 50+10\log_{10}(P[\text{Watts}])$ | PASS | - |
| 3.4 | §2.1051 §90.691 | Emission masks – Out of band emissions | $< 43+10\log_{10}(P[\text{Watts}])$ | PASS | - |
| 3.5 | §2.1053 §90.691 | Field Strength of Spurious Radiation | $< 43+10\log_{10}(P[\text{Watts}])$ | PASS | Under limit 42.00 dB at 1632.000 MHz |
| 3.6 | §2.1055 §90.213 | Frequency Stability for Temperature & Voltage | $< 2.5 \text{ ppm}$ | PASS | - |



1 General Description

1.1 Applicant

Motorola Mobility, LLC
222 W. Merchandise Mart Plaza, Chicago IL 60654 USA

1.2 Manufacturer

Motorola Mobility, LLC
222 W. Merchandise Mart Plaza, Chicago IL 60654 USA

1.3 Feature of Equipment Under Test

| Product Feature | |
|---------------------------------|--|
| Equipment | Mobile Cellular Phone |
| Brand Name | Motorola |
| Model Name | 6918 |
| FCC ID | IHDT56VA5 |
| IMEI Code | 354113070023323 |
| EUT supports Radios application | CDMA/EV-DO/GSM/EGPRS/WCDMA/HSPA/LTE/FM WLAN 11b/g/n HT20 WLAN 11a/n HT20/HT40 Bluetooth v3.0 EDR Bluetooth v4.0 LE |
| HW Version | DVT2 |
| EUT Stage | Identical Prototype |

Remark: The above EUT's information was declared by manufacturer. Please refer to the specifications or user's manual for more detailed description.

| Accessory List | |
|----------------|------------------------|
| AC Adapter | Brand Name : Motorola |
| | Model Name : SPN5864A |
| USB Cable | Brand Name : Motorola |
| | Model Name : SKN6461A |
| Earphone | Brand Name : Motorola |
| | Model Name : SJYN1181B |



1.4 Product Specification of Equipment Under Test

| Product Specification subjective to this standard | |
|---|------------------------------|
| Tx Frequency | 814.7 ~ 823.3 MHz |
| Rx Frequency | 859.7 ~ 868.3 MHz |
| Bandwidth | 1.4MHz / 3MHz / 5MHz / 10MHz |
| Maximum Output Power to Antenna | 23.03 dBm |
| Antenna Type | Fixed Internal Antenna |
| Type of Modulation | LTE: QPSK / 16QAM |

Remark: This test report recorded only product characteristics and test results of PCS Licensed Transmitter Held to Ear (PCE).

1.5 Modification of EUT

No modifications are made to the EUT during all test items.

1.6 Maximum Frequency Tolerance and Emission Designator

| LTE Band 26 BW(MHz) | QPSK | | 16QAM | |
|------------------------|------------------------------|---------------------------|------------------------------|---------------------------|
| | Emission Designator (99%OBW) | Frequency Tolerance (ppm) | Emission Designator (99%OBW) | Frequency Tolerance (ppm) |
| 1.4 | 1M10G7D | - | 1M10W7D | - |
| 3 | 2M72G7D | - | 2M72W7D | - |
| 5 | 4M50G7D | - | 4M49W7D | - |
| 10 | 8M97G7D | 0.0121 | 8M95W7D | - |



1.7 Testing Site

Sporton Lab is accredited to ISO 17025 by Taiwan Accreditation Foundation (TAF code : 1190) and the FCC designation No. TW1022 under the FCC 2.948(e) by Mutual Recognition Agreement (MRA) in FCC Test.

| | |
|---------------------------|--|
| Test Site | SPORTON INTERNATIONAL INC. |
| Test Site Location | No. 52, Hwa Ya 1 st Rd., Hwa Ya Technology Park, Kwei-Shan District, Tao Yuan City, Taiwan, R.O.C. TEL: +886-3-327-3456 FAX: +886-3-328-4978 |
| Test Site No. | Sporton Site No. |
| | TH05-HY |

| | |
|---------------------------|--|
| Test Site | SPORTON INTERNATIONAL INC. |
| Test Site Location | No.58, Aly. 75, Ln. 564, Wenhua 3rd Rd. Guishan Dist, Taoyuan City, Taiwan (R.O.C.) TEL: +886-3-327-0868 FAX: +886-3-327-0855 |
| Test Site No. | Sporton Site No. |
| | 03CH11-HY |

1.8 Applied Standards

According to the specifications of the manufacturer, the EUT must comply with the requirements of the following standards:

- ♦ FCC 47 CFR Part 2, 90
- ♦ ANSI / TIA / EIA-603-D-2010
- ♦ FCC KDB 971168 D01 Power Meas. License Digital Systems v02r02

Remark:

1. All test items were verified and recorded according to the standards and without any deviation during the test.
2. This EUT has also been tested and complied with the requirements of FCC Part 15, Subpart B, recorded in a separate test report.



2 Test Configuration of Equipment Under Test

2.1 Test Mode

During all testing, EUT is in link mode with base station emulator at maximum power level. The spurious emission measurements were carried out in semi-anechoic chamber with 3-meter test range, and EUT is rotated on three test planes to find out the worst emission.

Frequency range investigated for radiated emission is 30 MHz to 9000 MHz.

| Test Items | Band | Bandwidth (MHz) | | | | | | Modulation | | RB # | | | Test Channel | | |
|---|---|-----------------|---|---|----|----|----|------------|-------|------|------|------|--------------|---|---|
| | | 1.4 | 3 | 5 | 10 | 15 | 20 | QPSK | 16QAM | 1 | Half | Full | L | M | H |
| Max. Output Power | 26 | v | v | v | v | - | - | v | v | v | v | v | v | v | v |
| 26dB and 99% Bandwidth | 26 | v | v | v | v | - | - | v | v | | | v | v | v | v |
| Emission masks In-band emissions | 26 | v | v | v | v | - | - | v | v | v | | v | v | | v |
| Emission masks – Out of band emissions | 26 | v | v | v | v | - | - | v | v | v | | | v | v | v |
| Frequency Stability | 26 | | | | v | - | - | v | | | | v | | v | |
| Radiated Spurious Emission | 26 | v | v | v | v | - | - | v | | v | | | v | v | v |
| Note | 1. The mark “v “ means that this configuration is chosen for testing 2. The mark “-“ means that this bandwidth is not supported. | | | | | | | | | | | | | | |

2.2 Connection Diagram of Test System

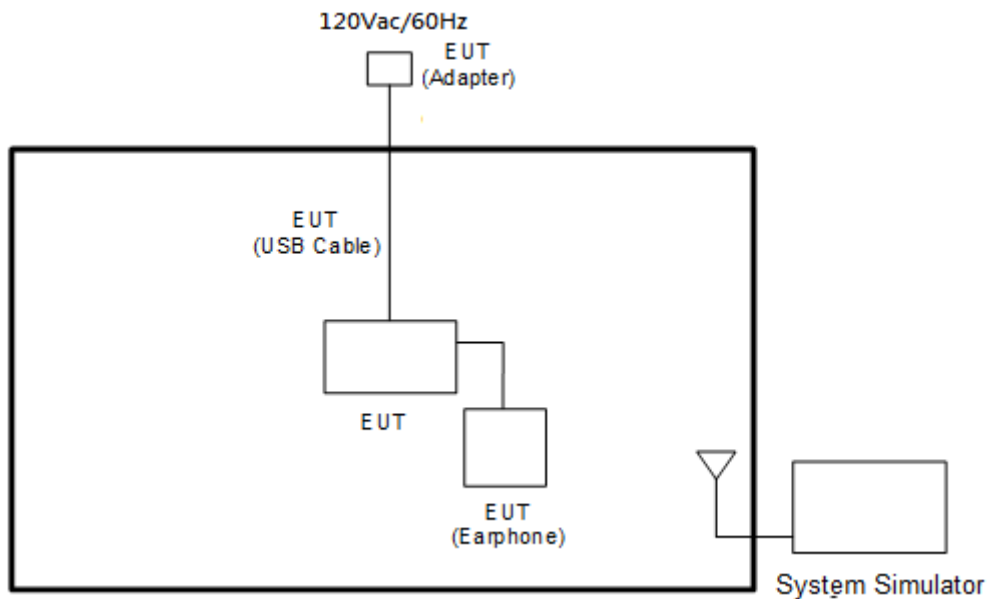

2.3 Support Unit used in test configuration and system

| Item | Equipment | Trade Name | Model No. | FCC ID | Data Cable | Power Cord |
|------|------------------|------------|-----------|--------|------------|-------------------|
| 1. | System Simulator | Anritsu | MT8820C | N/A | N/A | Unshielded, 1.8 m |

2.4 Measurement Results Explanation Example

For all conducted test items:

The offset level is set in the spectrum analyzer to compensate the RF cable loss and attenuator factor between RF conducted output port and spectrum analyzer. With the offset compensation, the spectrum analyzer reading level will be exactly the RF output level.

The spectrum analyzer offset is derived from RF cable loss and attenuator factor.

Offset = RF cable loss + attenuator factor.

The following shows an offset computation example with RF cable loss 4.2 dB and a 10dB attenuator.

Example :

$$\begin{aligned} \text{Offset(dB)} &= \text{RF cable loss(dB)} + \text{attenuator factor(dB)}. \\ &= 4.2 + 10 = 14.2 \text{ (dB)} \end{aligned}$$

3 Test Result

3.1 Conducted Output Power Measurement

3.1.1 Description of the Conducted Output Power Measurement

A system simulator was used to establish communication with the EUT. Its parameters were set to enforce EUT transmitting at the maximum power. The measured power in the radio frequency on the transmitter output terminals shall be reported.

3.1.2 Measuring Instruments

The measuring equipment is listed in the section 4 of this test report.

3.1.3 Test Procedures

1. The transmitter output port was connected to the system simulator.
2. Set EUT at maximum power through system simulator.
3. Select lowest, middle, and highest channels for each band and different modulation.
4. Measure and record the power level from the system simulator.

3.1.4 Test Setup

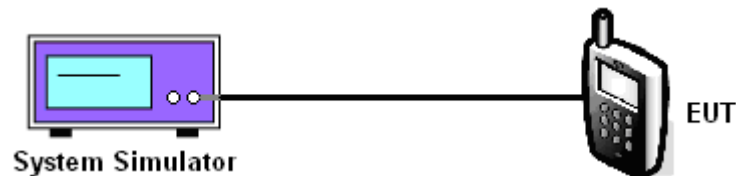

3.1.5 Test Result of Conducted Output Power

Please refer to Appendix A.

3.2 99% Occupied Bandwidth and 26dB Bandwidth Measurement

3.2.1 Description of (Occupied) Bandwidth Limitations Measurement

The 99% occupied bandwidth is the width of a frequency band such that, below the lower and above the upper frequency limits, the mean powers emitted are each equal to a specified percentage 0.5% of the total mean transmitted power.

The emission bandwidth is defined as the width of the signal between two points, located at the 2 sides of the carrier frequency, outside of which all emissions are attenuated at least 26 dB below the transmitter power.

3.2.2 Measuring Instruments

The measuring equipment is listed in the section 4 of this test report.

3.2.3 Test Procedures

1. The EUT was connected to spectrum analyzer and system simulator via a power divider.
2. The 26dB and 99% occupied bandwidth (BW) of the middle channel for the highest RF power with full RB sizes were measured.

3.2.4 Test Setup

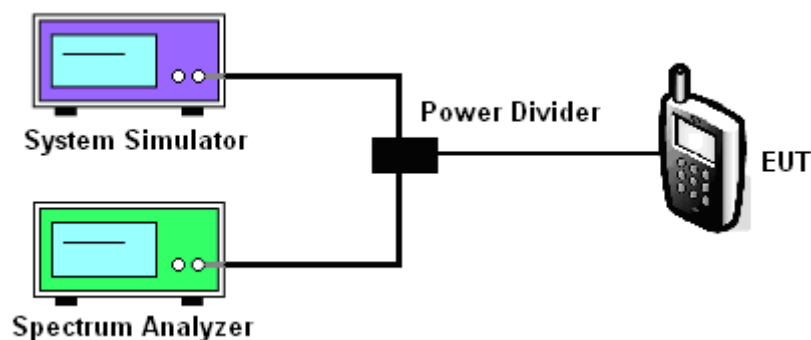

3.2.5 Test Result of 99% Occupied Bandwidth and 26dB Bandwidth

Please refer to Appendix A.



3.3 Emissions Mask Measurement

3.3.1 Description of Emissions Mask Measurement

Equipment used in this licensed to EA or non-EA systems shall comply with the emission mask provisions of FCC Part 90.691.(a)

(a) Out-of-band emission requirement shall apply only to the "outer" channels included in an EA license and to spectrum adjacent to interior channels used by incumbent licensees. The emission limits are as follows:

(1) For any frequency removed from the EA licensee's frequency block by up to and including 37.5 kHz, the power of any emission shall be attenuated below the transmitter power (P) in watts by at least $116 \text{ Log}_{10}(f/6.1)$ decibels or $50 + 10 \text{ Log}_{10}(P)$ decibels or 80 decibels, whichever is the lesser attenuation, where f is the frequency removed from the center of the outer channel in the block in kilohertz and where f is greater than 12.5 kHz.

(2) For any frequency removed from the EA licensee's frequency block greater than 37.5 kHz, the power of any emission shall be attenuated below the transmitter power (P) in watts by at least $43 + 10\text{Log}_{10}(P)$ decibels or 80 decibels, whichever is the lesser attenuation, where f is the frequency removed from the center of the outer channel in the block in kilohertz and where f is greater than 37.5 kHz.

3.3.2 Measuring Instruments

The measuring equipment is listed in the section 4 of this test report.

3.3.3 Test Procedures

1. The EUT was connected to spectrum analyzer and base station via power divider.
2. The emissions mask of low and high channels for the highest RF powers were measured.
3. The measured RBW and the VBW set 3 times of RBW are then set in spectrum analyzer, and the RBW correction factor $10\log(1\% \text{ of OBW/measured RBW})(\text{dB})$ was compensated, if required.
4. The test results were shown below plots with a correction offset factor including cable loss, insertion loss of power divider.

3.3.4 Test Setup

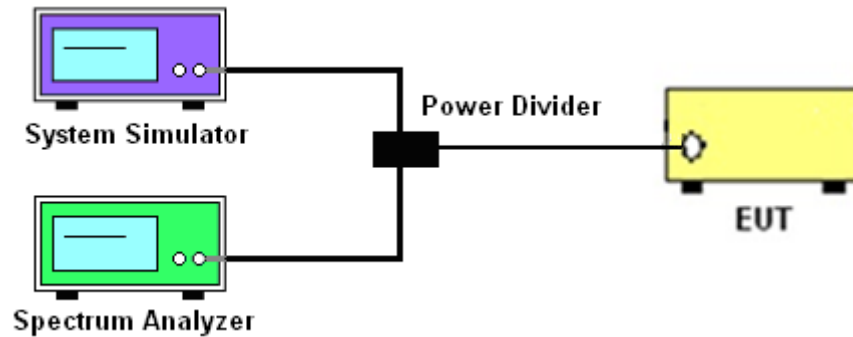

3.3.5 Test Result (Plots) of Conducted Emissions Mask

Please refer to Appendix A.



3.4 Emissions Mask – Out Of Band Emissions Measurement

3.4.1 Description of Conducted Emissions Out of band emissions measurement

The power of any emission FCC Part 90.691 (a)(2) on any frequency removed from the assigned frequency by out of the authorized bandwidth at least $43 + 10 \log (P)$ dB. It is measured by means of a calibrated spectrum analyzer and scanned from 30 MHz up to a frequency including its 10th harmonic.

3.4.2 Measuring Instruments

The measuring equipment is listed in the section 4 of this test report.

3.4.3 Test Procedures

1. The EUT was connected to spectrum analyzer and system simulator via a power divider.
2. The RF output of EUT was connected to the spectrum analyzer by RF cable and attenuator. The path loss was compensated to the results for each measurement.
3. The middle channel for the highest RF power within the transmitting frequency was measured.
4. The conducted spurious emission for the whole frequency range was taken.
5. Make the measurement with the spectrum analyzer's RBW = 1MHz, VBW = 3MHz, taking the record of maximum spurious emission.
6. The RF fundamental frequency should be excluded against the limit line in the operating frequency band.
7. The limit line is derived from $43 + 10\log(P)$ dB below the transmitter power P(Watts)
= P(W)- [43 + 10log(P)] (dB)
= [30 + 10log(P)] (dBm) - [43 + 10log(P)] (dB)
= -13dBm.

3.4.4 Test Setup

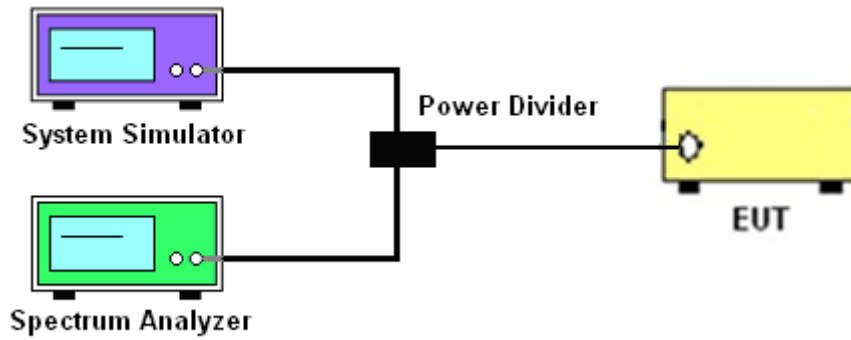

3.4.5 Test Result (Plots) of Conducted Emission

Please refer to Appendix A.



3.5 Field Strength of Spurious Radiation Measurement

3.5.1 Description of Field Strength of Spurious Radiated Measurement

The radiated spurious emission was measured by substitution method according to ANSI / TIA / EIA-603-C-2004. The power of any emission FCC Part 90.691 on any frequency removed from the assigned frequency by more than 250 percent of the authorized bandwidth at least $43 + 10 \log (P)$ dB. The spectrum is scanned from 30 MHz up to a frequency including its 10th harmonic.

The power of any emission outside of the authorized operating frequency ranges must be attenuated below the transmitter power (P) by a factor of at least $43+10\log_{10}(P[\text{Watts}])$ dB. The spectrum is scanned from 30 MHz up to a frequency including its 10th harmonic.

3.5.2 Measuring Instruments

The measuring equipment is listed in the section 4 of this test report.

3.5.3 Test Procedures

1. The EUT was placed on a turntable with 0.8 meter for frequency below 1GHz and 1.5 meter for frequency above 1GHz respectively above ground.
2. The EUT was set 3 meters from the receiving antenna, which was mounted on the antenna tower.
3. The table was rotated 360 degrees to determine the position of the highest spurious emission.
4. The height of the receiving antenna is varied between one meter and four meters to search the maximum spurious emission for both horizontal and vertical polarizations.
5. Make the measurement with the spectrum analyzer's RBW = 1MHz, VBW = 3MHz, Sweep = 500ms, Taking the record of maximum spurious emission.
6. A horn antenna was substituted in place of the EUT and was driven by a signal generator.
7. Tune the output power of signal generator to the same emission level with EUT maximum spurious emission.
8. Taking the record of output power at antenna port.
9. Repeat step 7 to step 8 for another polarization.
10. $\text{EIRP (dBm)} = \text{S.G. Power} - \text{Tx Cable Loss} + \text{Tx Antenna Gain}$
11. $\text{ERP (dBm)} = \text{EIRP} - 2.15$
12. The RF fundamental frequency should be excluded against the limit line in the operating frequency band.
13. The limit line is derived from $43 + 10\log(P)$ dB below the transmitter power P(Watts)
 $= P(W) - [43 + 10\log(P)] \text{ (dB)}$
 $= [30 + 10\log(P)] \text{ (dBm)} - [43 + 10\log(P)] \text{ (dB)}$
 $= -13\text{dBm}.$

3.5.4 Test Setup

For radiated test from 30MHz to 1GHz

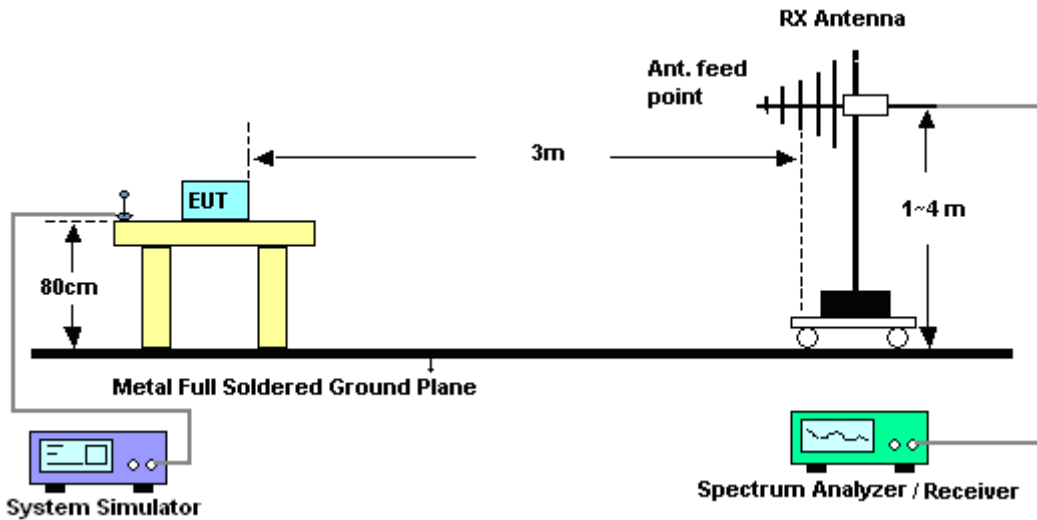

For radiated test above 1GHz

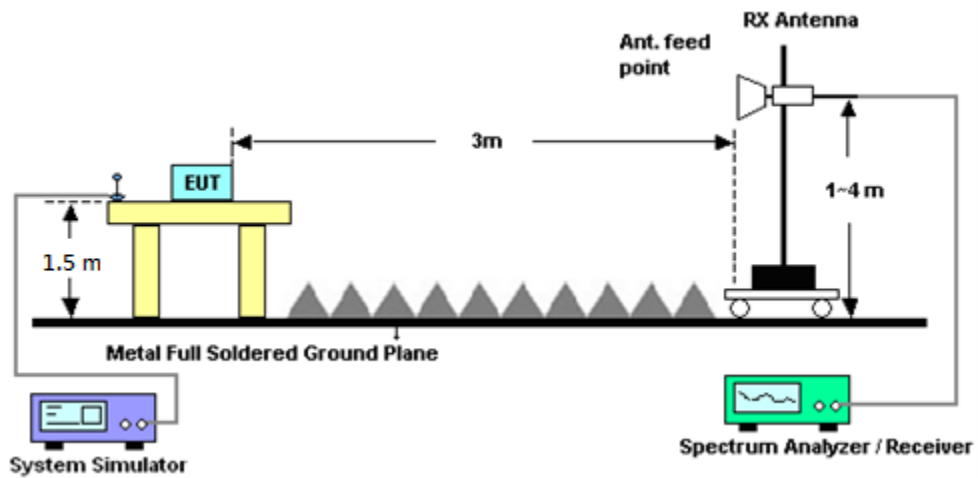

3.5.5 Test Result of Field Strength of Spurious Radiated

Please refer to Appendix B.



3.6 Frequency Stability Measurement

3.6.1 Description of Frequency Stability Measurement

The frequency stability shall be measured by variation of ambient temperature and variation of primary supply voltage to ensure that the fundamental emission stays within the authorized frequency block. The frequency stability of the transmitter shall be maintained within $\pm 0.00025\%$ ($\pm 2.5\text{ppm}$) of the center frequency according to FCC Part 90.213.

3.6.2 Measuring Instruments

The measuring equipment is listed in the section 4 of this test report.

3.6.3 Test Procedures for Temperature Variation

1. The EUT was set up in the thermal chamber and connected with the base station.
2. With power OFF, the temperature was decreased to -30°C and the EUT was stabilized for three hours. Power was applied and the maximum change in frequency was recorded within one minute.
3. With power OFF, the temperature was raised in 10°C step up to 50°C . The EUT was stabilized at each step for at least half an hour. Power was applied and the maximum frequency change was recorded within one minute.

3.6.4 Test Procedures for Voltage Variation

1. The EUT was placed in a temperature chamber at $25\pm 5^{\circ}\text{C}$ and connected with the base station.
2. The power supply voltage to the EUT was varied from BEP to 115% of the nominal value measured at the input to the EUT.
3. The variation in frequency was measured for the worst case.

3.6.5 Test Setup

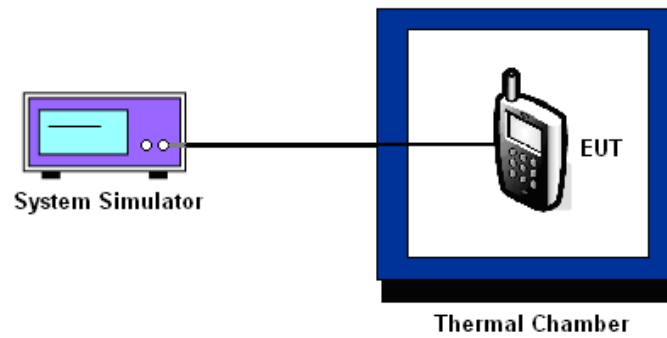

3.6.6 Test Result of Temperature Variation

Please refer to Appendix A.



4 List of Measuring Equipment

| Instrument | Manufacturer | Model No. | Serial No. | Characteristics | Calibration Date | Test Date | Due Date | Remark |
|---------------------------|-----------------|--------------------------------|-----------------|------------------------|------------------|---------------|---------------|--------------------------|
| LTE Base Station | Anritsu | MT8820C | 6201432821 | GSM/GPRS /WCDMA/LTE | Oct. 16, 2015 | Mar. 26, 2016 | Oct. 15, 2016 | Conducted (TH05-HY) |
| Spectrum Analyzer | Rohde & Schwarz | FSV40 | 101397 | 10Hz~40GHz | Sep. 11, 2015 | Mar. 26, 2016 | Sep. 10 2016 | Conducted (TH05-HY) |
| Temperature Chamber | ESPEC | SH-641 | 92013720 | -30℃~70℃ | Sep. 08, 2015 | Mar. 26, 2016 | Sep. 07, 2016 | Conducted (TH05-HY) |
| Programmable Power Supply | GW Instek | PSS-2005 | EL890089 | 1V~20V 0.5A~5A | Jan. 18, 2016 | Mar. 26, 2016 | Jan. 17, 2017 | Conducted (TH05-HY) |
| Amplifier | SONOMA | 310N | 187312 | 9kHz~1GHz | Nov. 20, 2015 | Mar. 30, 2016 | Nov. 19, 2016 | Radiation (03CH11-HY) |
| Bilog Antenna | TESEQ | CBL 6111D | 35414 | 30MHz~1GHz | Nov. 17, 2015 | Mar. 30, 2016 | Nov. 16, 2016 | Radiation (03CH11-HY) |
| Horn Antenna | SCHWARZBECK | BBHA 9120 D | 9120D-1326 | 1GHz ~ 18GHz | Oct. 08, 2015 | Mar. 30, 2016 | Oct. 07, 2016 | Radiation (03CH11-HY) |
| Preamplifier | MITEQ | AMF-7D-00 101800-30- 10P | 1902247 | 1GHz~18GHz | Jul. 01, 2015 | Mar. 30, 2016 | Jun. 30, 2016 | Radiation (03CH11-HY) |
| Spectrum Analyzer | Keysight | N9010A | MY5420048 6 | 10Hz ~ 44GHZ | Sep. 24, 2015 | Mar. 30, 2016 | Sep. 23, 2016 | Radiation (03CH11-HY) |
| Antenna Mast | EMEC | AM-BS-450 0-B | N/A | 1~4m | N/A | Mar. 30, 2016 | N/A | Radiation (03CH11-HY) |
| Turn Table | EMEC | TT 2000 | N/A | 0~360 Degree | N/A | Mar. 30, 2016 | N/A | Radiation (03CH11-HY) |
| SHF-EHF Horn Antenna | SCHWARZBECK | BBHA 9170 | BBHA91705 84 | 18GHz- 40GHz | Nov. 02, 2015 | Mar. 30, 2016 | Nov. 01, 2016 | Radiation (03CH11-HY) |
| SHF-EHF Horn Antenna | SCHWARZBECK | BBHA 9170 | BBHA91705 76 | 18GHz ~ 40GHz | Apr. 20, 2015 | Mar. 30, 2016 | Apr. 19, 2016 | Radiation (03CH11-HY) |
| Bilog Antenna | TESEQ | CBL 6111D | 40103 | 30MHz to 1GHz | Jan. 13, 2016 | Mar. 30, 2016 | Jan. 12, 2017 | Radiation (03CH11-HY) |
| Horn Antenna | SCHWARZBECK | BBHA 9120 D | 9120D-1241 | 1GHz ~ 18GHz | Apr. 22, 2015 | Mar. 30, 2016 | Apr. 21, 2016 | Radiation (03CH11-HY) |
| Preamplifier | MITEQ | JS44-18004 000-33-8P | 1840917 | 18GHz ~ 40GHz | Jun. 02, 2015 | Mar. 30, 2016 | Jun. 01, 2016 | Radiation (03CH11-HY) |
| Signal Generator | Rohde & Schwarz | SMF100A | 101107 | 100kHz~40GHz | May 22, 2015 | Mar. 30, 2016 | May 21, 2016 | Radiation (03CH11-HY) |



5 Uncertainty of Evaluation

Uncertainty of Radiated Emission Measurement (30 MHz ~ 1000 MHz)

| | |
|---|-----|
| Measuring Uncertainty for a Level of Confidence of 95% ($U = 2Uc(y)$) | 4.9 |
|---|-----|



Appendix A. Test Results of Conducted Test

Conducted Output Power (Average power)

| LTE Band 26 Maximum Average Power [dBm] | | | | | | |
|---|---------|-----------|--------|--------|--------------|---------|
| BW [MHz] | RB Size | RB Offset | Mod | Lowest | Middle | Highest |
| 10 | 1 | 0 | QPSK | - | 22.68 | - |
| 10 | 1 | 24 | | - | 22.93 | - |
| 10 | 1 | 49 | | - | 23.01 | - |
| 10 | 25 | 0 | | - | 21.85 | - |
| 10 | 25 | 12 | | - | 21.88 | - |
| 10 | 25 | 24 | | - | 21.87 | - |
| 10 | 50 | 0 | | - | 21.82 | - |
| 10 | 1 | 0 | 16-QAM | - | 21.59 | - |
| 10 | 1 | 24 | | - | 21.79 | - |
| 10 | 1 | 49 | | - | 21.55 | - |
| 10 | 25 | 0 | | - | 20.84 | - |
| 10 | 25 | 12 | | - | 20.80 | - |
| 10 | 25 | 24 | | - | 20.77 | - |
| 10 | 50 | 0 | | - | 20.81 | - |
| 5 | 1 | 0 | QPSK | 22.62 | 22.52 | 22.47 |
| 5 | 1 | 12 | | 23.02 | 23.03 | 22.74 |
| 5 | 1 | 24 | | 22.55 | 22.43 | 22.31 |
| 5 | 12 | 0 | | 21.88 | 21.77 | 21.78 |
| 5 | 12 | 6 | | 21.93 | 21.77 | 21.79 |
| 5 | 12 | 11 | | 21.79 | 21.78 | 21.68 |
| 5 | 25 | 0 | | 21.86 | 21.84 | 21.74 |
| 5 | 1 | 0 | 16-QAM | 21.43 | 21.53 | 21.40 |
| 5 | 1 | 12 | | 21.49 | 21.46 | 21.41 |
| 5 | 1 | 24 | | 21.51 | 21.49 | 21.36 |
| 5 | 12 | 0 | | 20.99 | 20.77 | 20.65 |
| 5 | 12 | 6 | | 20.84 | 20.74 | 20.80 |
| 5 | 12 | 11 | | 20.80 | 20.77 | 20.58 |
| 5 | 25 | 0 | | 20.97 | 20.83 | 20.61 |



| LTE Band 26 Maximum Average Power [dBm] | | | | | | |
|---|---------|-----------|--------|--------|--------|---------|
| BW [MHz] | RB Size | RB Offset | Mod | Lowest | Middle | Highest |
| 3 | 1 | 0 | QPSK | 22.72 | 22.92 | 22.65 |
| 3 | 1 | 7 | | 22.64 | 22.93 | 22.62 |
| 3 | 1 | 14 | | 22.68 | 22.57 | 22.26 |
| 3 | 8 | 0 | | 21.89 | 21.92 | 21.79 |
| 3 | 8 | 4 | | 21.83 | 21.80 | 21.77 |
| 3 | 8 | 7 | | 21.89 | 21.78 | 21.75 |
| 3 | 15 | 0 | | 21.83 | 21.84 | 21.79 |
| 3 | 1 | 0 | 16-QAM | 21.60 | 21.70 | 21.56 |
| 3 | 1 | 7 | | 21.49 | 21.49 | 21.40 |
| 3 | 1 | 14 | | 21.65 | 21.57 | 21.52 |
| 3 | 8 | 0 | | 20.95 | 20.84 | 20.75 |
| 3 | 8 | 4 | | 21.07 | 20.83 | 20.81 |
| 3 | 8 | 7 | | 20.96 | 20.92 | 20.85 |
| 3 | 15 | 0 | | 20.84 | 20.87 | 20.56 |
| 1.4 | 1 | 0 | QPSK | 22.77 | 22.77 | 22.60 |
| 1.4 | 1 | 2 | | 22.85 | 22.71 | 22.55 |
| 1.4 | 1 | 5 | | 22.57 | 22.62 | 22.63 |
| 1.4 | 3 | 0 | | 22.94 | 22.95 | 22.94 |
| 1.4 | 3 | 1 | | 22.90 | 22.92 | 22.83 |
| 1.4 | 3 | 2 | | 22.86 | 22.89 | 22.76 |
| 1.4 | 6 | 0 | | 21.85 | 21.78 | 21.75 |
| 1.4 | 1 | 0 | 16-QAM | 21.91 | 21.59 | 21.45 |
| 1.4 | 1 | 2 | | 21.99 | 21.72 | 21.64 |
| 1.4 | 1 | 5 | | 21.58 | 21.47 | 21.44 |
| 1.4 | 3 | 0 | | 21.94 | 21.94 | 21.89 |
| 1.4 | 3 | 1 | | 21.97 | 22.19 | 21.70 |
| 1.4 | 3 | 2 | | 22.06 | 22.07 | 21.72 |
| 1.4 | 6 | 0 | | 20.73 | 20.68 | 20.55 |



LTE Band 26_Part 90S

Peak-to-Average Ratio

| Mode | LTE Band 26 / 10MHz | | | | |
|------------|---------------------|---------|-------|---------|-------------|
| Mod. | QPSK | | 16QAM | | Limit: 13dB |
| RB Size | 1RB | Full RB | 1RB | Full RB | Result |
| Lowest CH | - | - | - | - | PASS |
| Middle CH | 5.01 | 5.36 | 6 | 6.29 | |
| Highest CH | - | - | - | - | |



LTE Band 26 / 10MHz / QPSK

Middle Channel / 1RB



Date: 26 MAR 2016 14:29:42

Middle Channel / Full RB

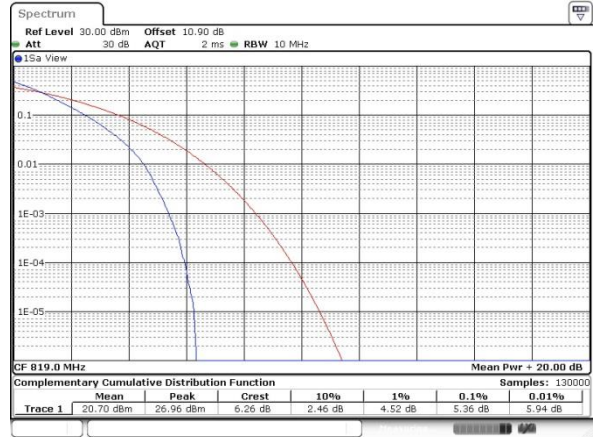

Date: 26 MAR 2016 14:30:43

LTE Band 26 / 10MHz / 16QAM

Middle Channel / 1RB

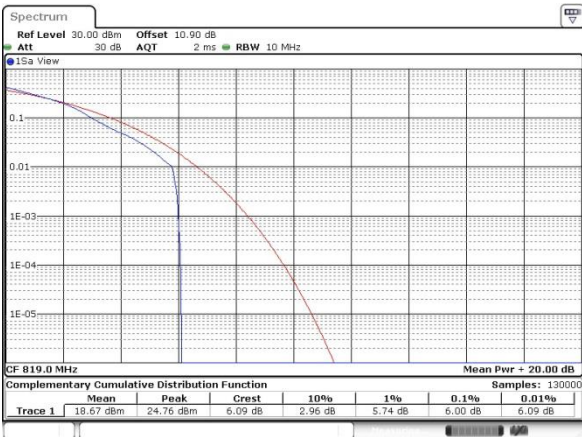

Date: 26 MAR 2016 14:29:58

Middle Channel / Full RB

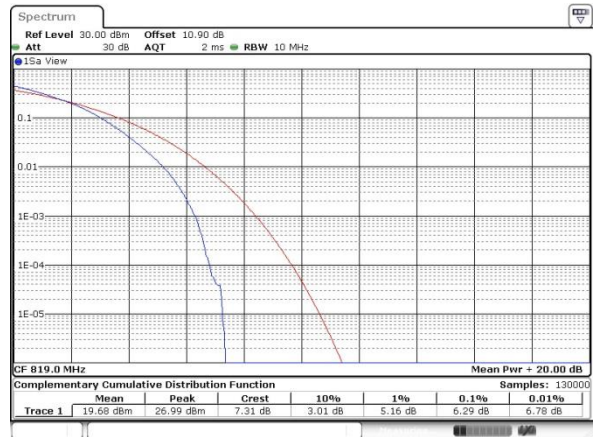

Date: 26 MAR 2016 14:30:20



26dB Bandwidth

| Mode | LTE Band 26 : 26dB BW(MHz) | | | | | | | | | | | |
|------------|----------------------------|-------|------|-------|------|-------|-------|-------|-------|-------|-------|-------|
| | 1.4MHz | | 3MHz | | 5MHz | | 10MHz | | 15MHz | | 20MHz | |
| BW | QPSK | 16QAM | QPSK | 16QAM | QPSK | 16QAM | QPSK | 16QAM | QPSK | 16QAM | QPSK | 16QAM |
| Lowest CH | 1.28 | 1.26 | 3 | 3.02 | 4.9 | 4.89 | - | - | - | - | - | - |
| Middle CH | 1.24 | 1.27 | 3 | 2.96 | 4.95 | 4.9 | 9.79 | 9.73 | - | - | - | - |
| Highest CH | 1.28 | 1.29 | 2.99 | 2.96 | 4.91 | 4.96 | - | - | - | - | - | - |



LTE Band 26

Lowest Channel / 1.4MHz / QPSK

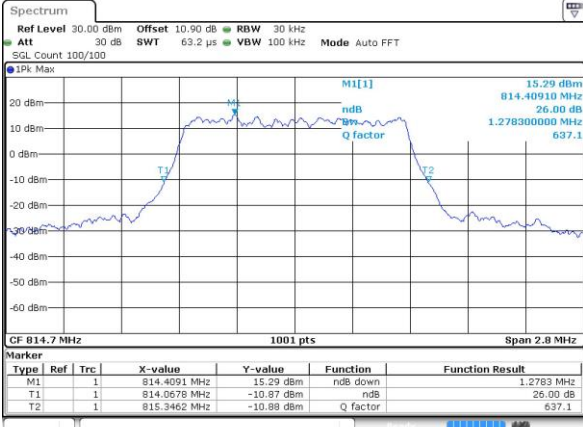

Date: 26 MAR 2016 14:22:26

Lowest Channel / 1.4MHz / 16QAM

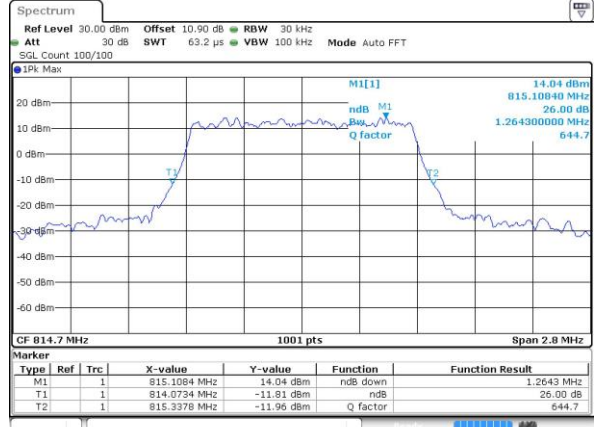

Date: 26 MAR 2016 14:22:15

Middle Channel / 1.4MHz / QPSK

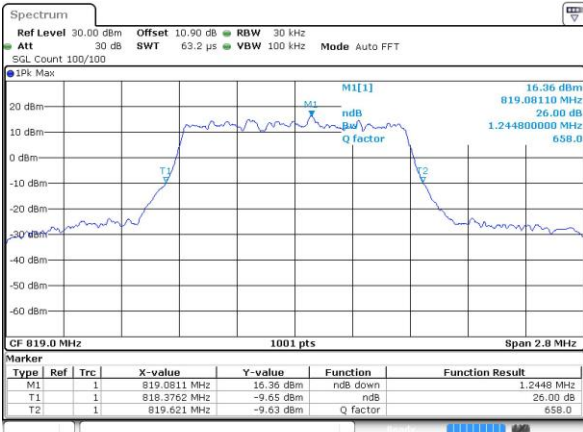

Date: 26 MAR 2016 14:24:46

Middle Channel / 1.4MHz / 16QAM

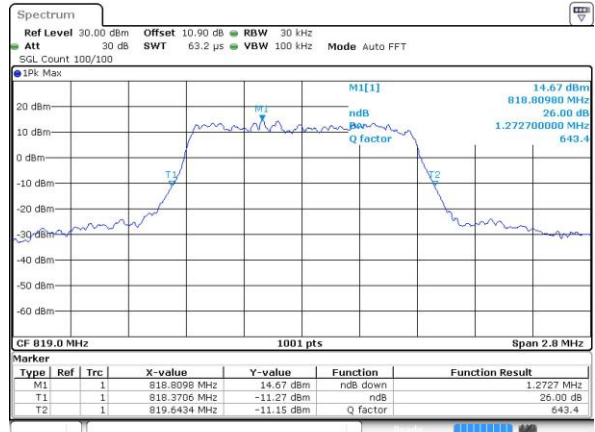

Date: 26 MAR 2016 14:24:57

Highest Channel / 1.4MHz / QPSK

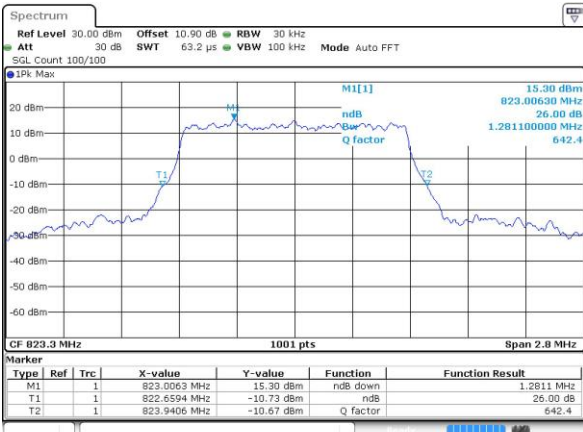

Date: 26 MAR 2016 14:27:17

Highest Channel / 1.4MHz / 16QAM

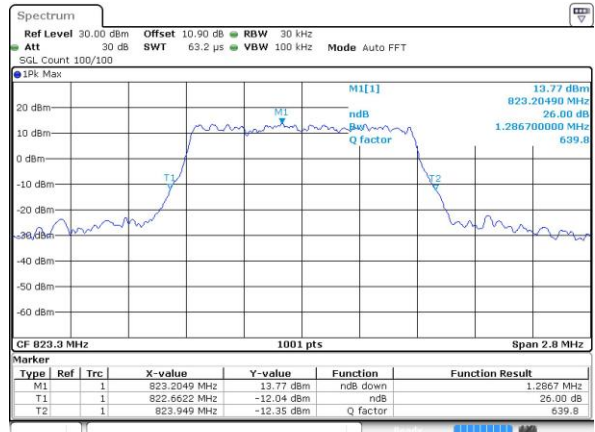

Date: 26 MAR 2016 14:27:27



LTE Band 26

Lowest Channel / 3MHz / QPSK

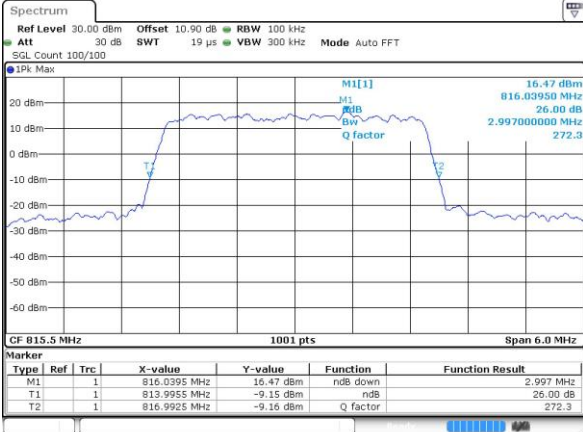

Date: 26 MAR 2016 14:32:48

Lowest Channel / 3MHz / 16QAM

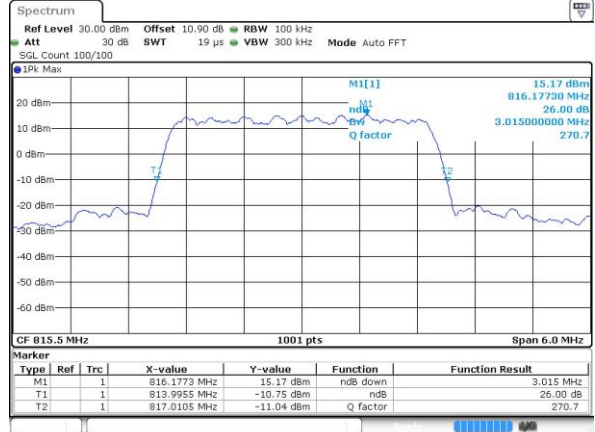

Date: 26 MAR 2016 14:32:18

Middle Channel / 3MHz / QPSK

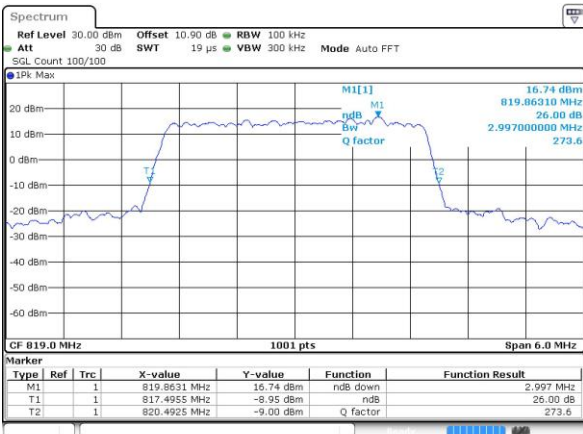

Date: 26 MAR 2016 14:06:08

Middle Channel / 3MHz / 16QAM

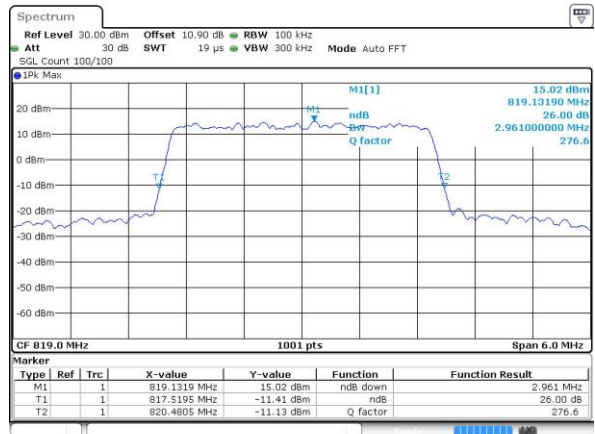

Date: 26 MAR 2016 14:06:18

Highest Channel / 3MHz / QPSK

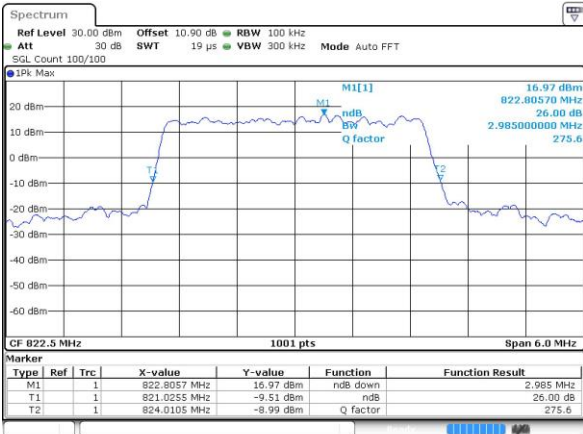

Date: 26 MAR 2016 14:08:39

Highest Channel / 3MHz / 16QAM

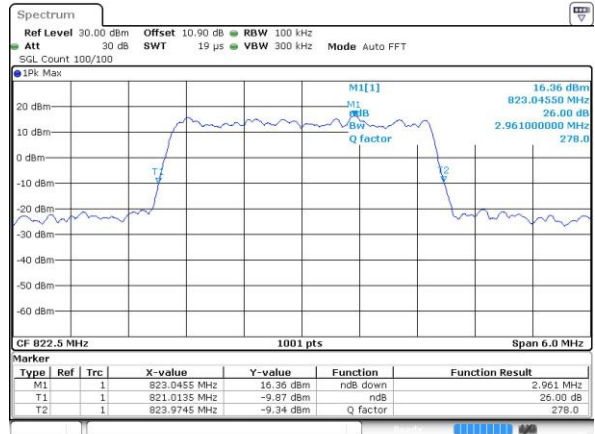

Date: 26 MAR 2016 14:08:49



LTE Band 26

Lowest Channel / 5MHz / QPSK

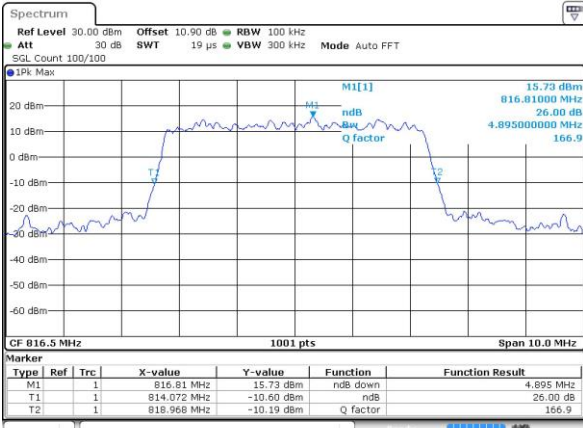

Date: 26 MAR 2016 14:11:10

Lowest Channel / 5MHz / 16QAM

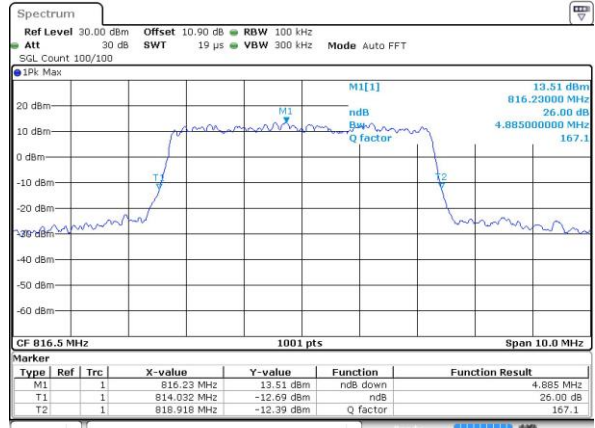

Date: 26 MAR 2016 14:11:20

Middle Channel / 5MHz / QPSK

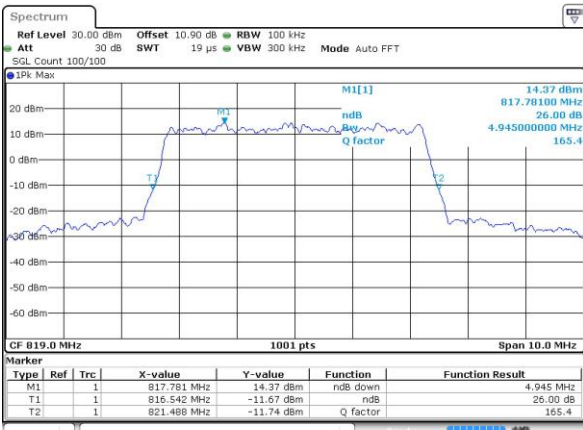

Date: 26 MAR 2016 14:13:40

Middle Channel / 5MHz / 16QAM

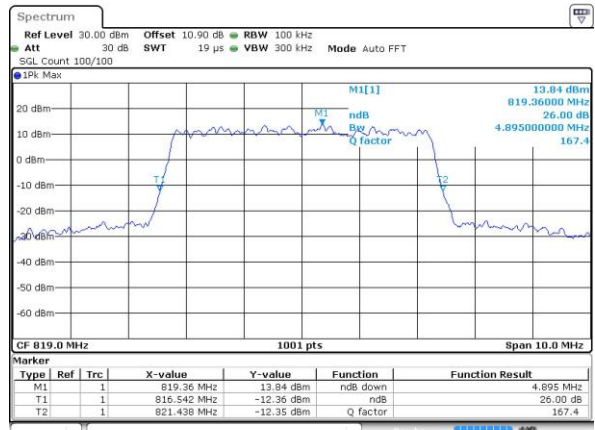

Date: 26 MAR 2016 14:13:51

Highest Channel / 5MHz / QPSK

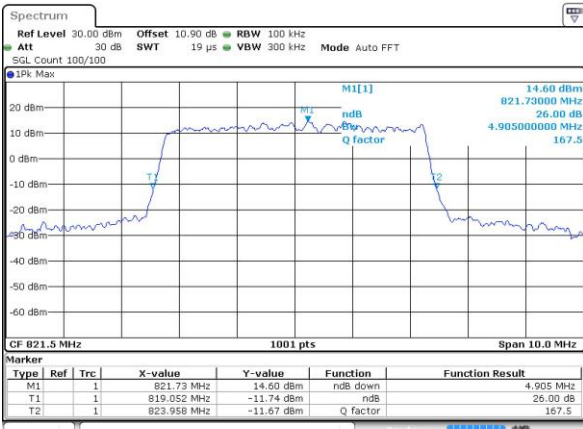

Date: 26 MAR 2016 14:16:11

Highest Channel / 5MHz / 16QAM

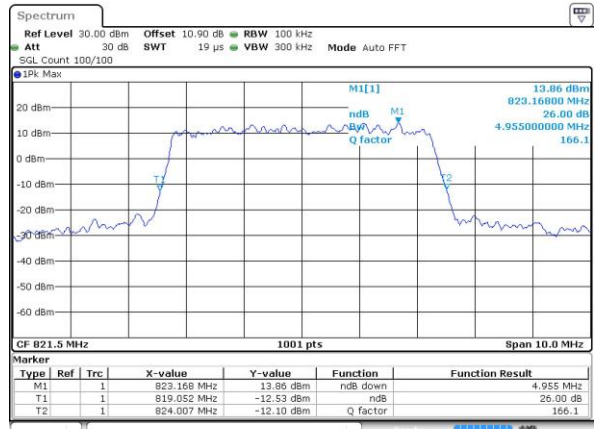

Date: 26 MAR 2016 14:16:22



LTE Band 26

Middle Channel / 10MHz / QPSK

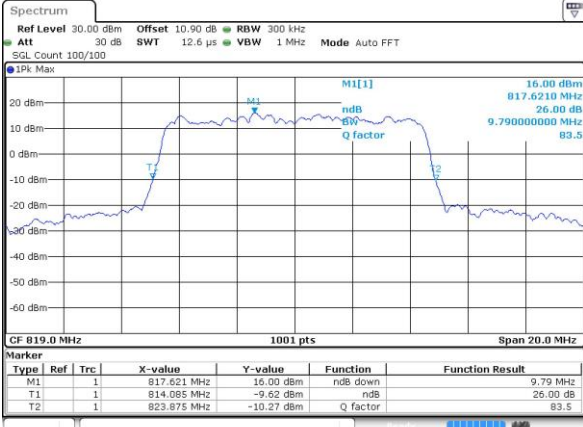

Date: 26 MAR 2016 14:18:42

Middle Channel / 10MHz / 16QAM

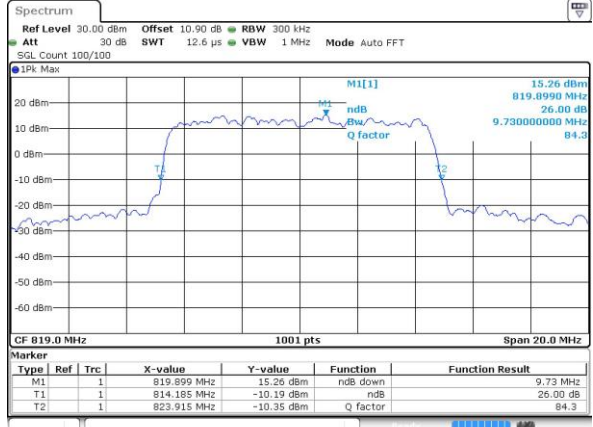

Date: 26 MAR 2016 14:18:52



Occupied Bandwidth

| Mode | LTE Band 26 : 99%OBW(MHz) | | | | | | | | | | | |
|------------|---------------------------|-------|------|-------|------|-------|-------|-------|-------|-------|-------|-------|
| | 1.4MHz | | 3MHz | | 5MHz | | 10MHz | | 15MHz | | 20MHz | |
| BW | QPSK | 16QAM | QPSK | 16QAM | QPSK | 16QAM | QPSK | 16QAM | QPSK | 16QAM | QPSK | 16QAM |
| Lowest CH | 1.09 | 1.09 | 2.72 | 2.7 | 4.49 | 4.48 | - | - | - | - | - | - |
| Middle CH | 1.1 | 1.1 | 2.72 | 2.72 | 4.5 | 4.48 | 8.97 | 8.95 | - | - | - | - |
| Highest CH | 1.1 | 1.1 | 2.7 | 2.72 | 4.47 | 4.49 | - | - | - | - | - | - |



LTE Band 26

Lowest Channel / 1.4MHz / QPSK

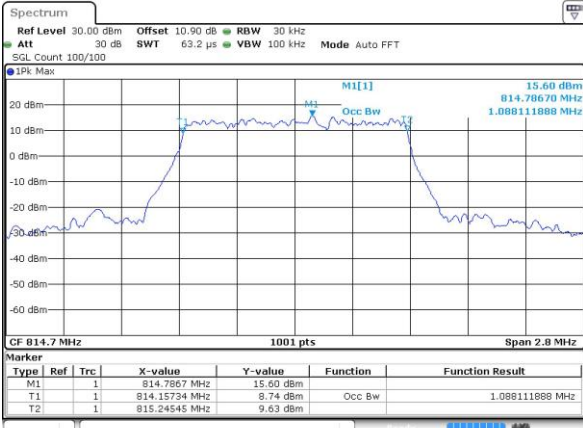

Date: 26 MAR 2016 14:21:54

Lowest Channel / 1.4MHz / 16QAM

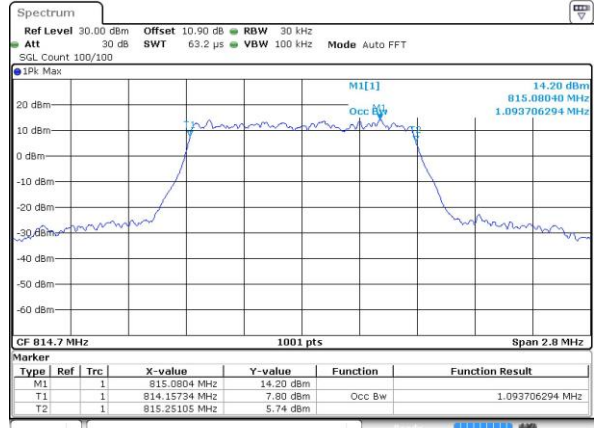

Date: 26 MAR 2016 14:22:05

Middle Channel / 1.4MHz / QPSK

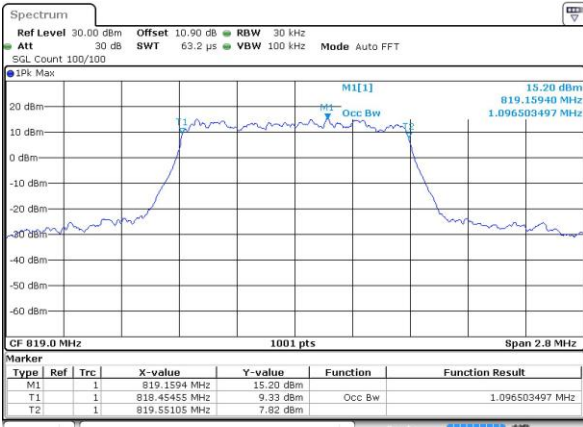

Date: 26 MAR 2016 14:24:25

Middle Channel / 1.4MHz / 16QAM

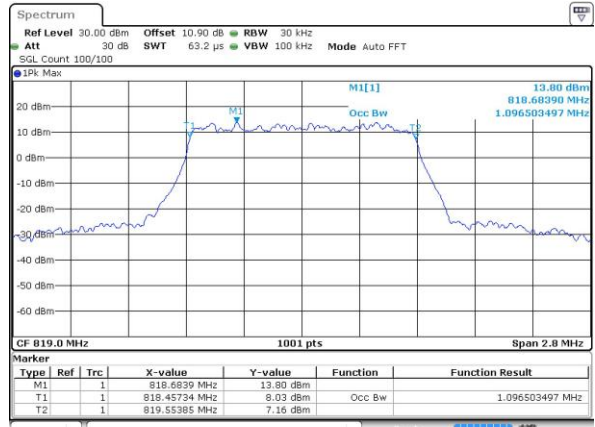

Date: 26 MAR 2016 14:24:36

Highest Channel / 1.4MHz / QPSK

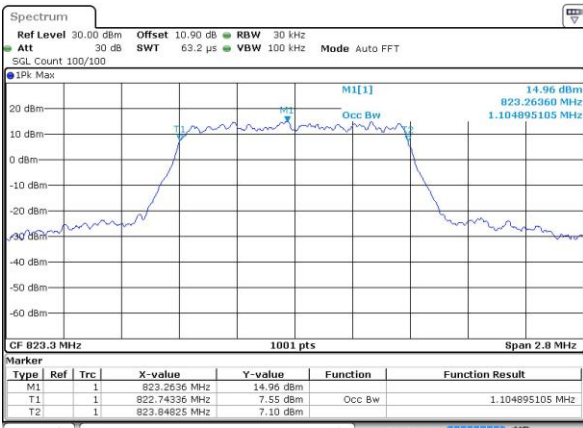

Date: 26 MAR 2016 14:26:56

Highest Channel / 1.4MHz / 16QAM

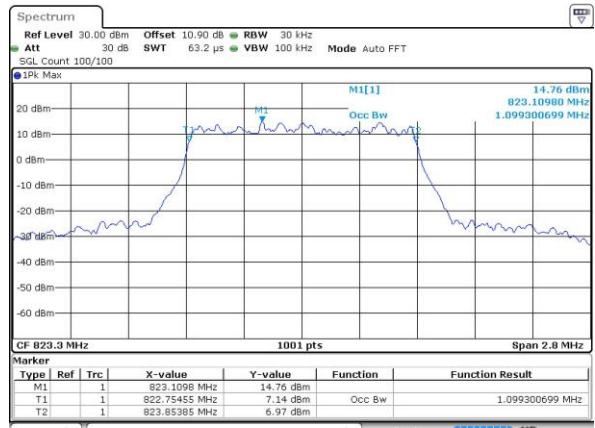

Date: 26 MAR 2016 14:27:06



LTE Band 26

Lowest Channel / 3MHz / QPSK

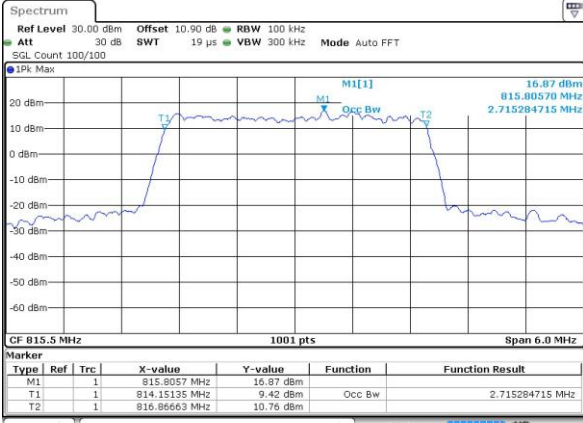

Date: 26 MAR 2016 14:31:46

Lowest Channel / 3MHz / 16QAM

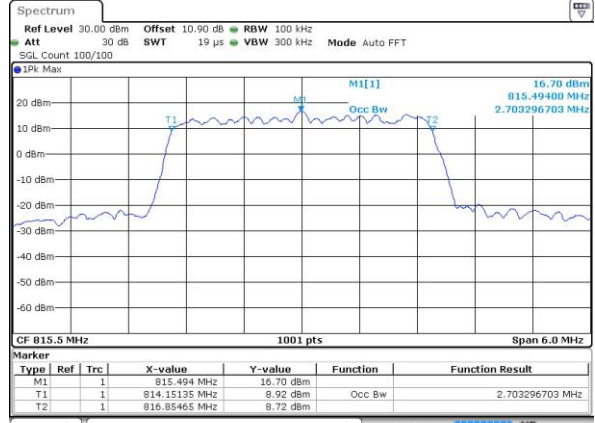

Date: 26 MAR 2016 14:32:03

Middle Channel / 3MHz / QPSK

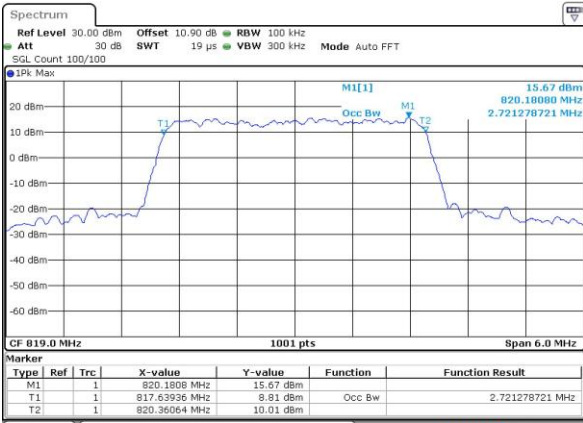

Date: 26 MAR 2016 14:05:47

Middle Channel / 3MHz / 16QAM

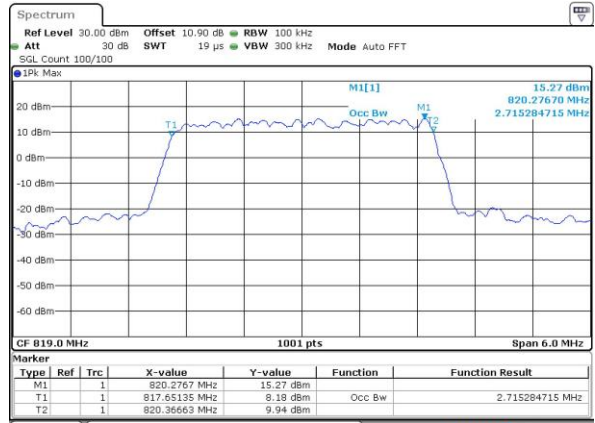

Date: 26 MAR 2016 14:05:57

Highest Channel / 3MHz / QPSK

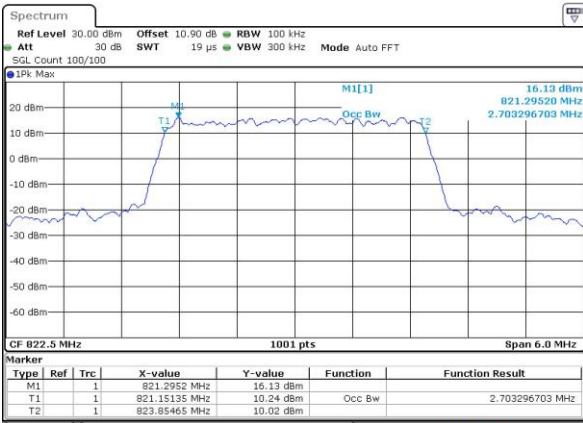

Date: 26 MAR 2016 14:08:16

Highest Channel / 3MHz / 16QAM

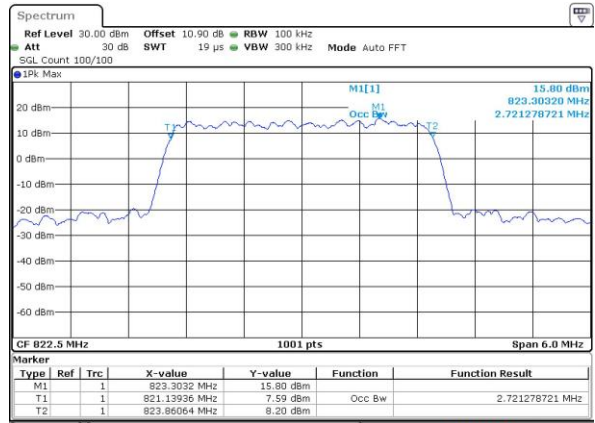

Date: 26 MAR 2016 14:08:28



LTE Band 26

Lowest Channel / 5MHz / QPSK

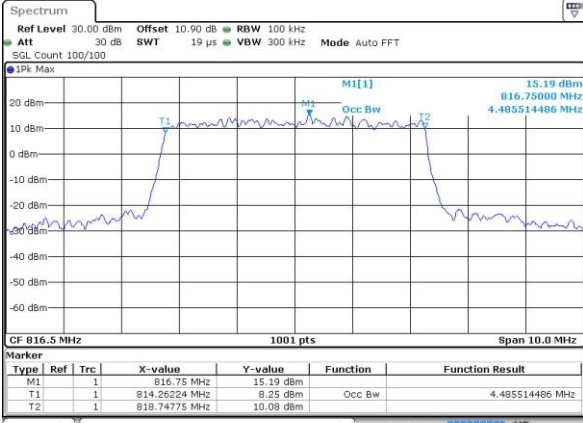

Date: 26 MAR 2016 14:10:49

Lowest Channel / 5MHz / 16QAM

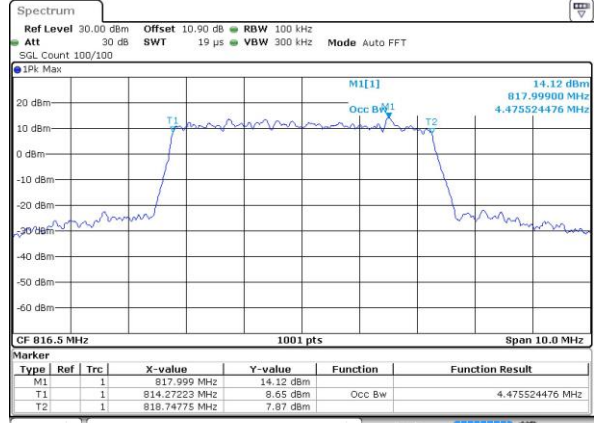

Date: 26 MAR 2016 14:10:59

Middle Channel / 5MHz / QPSK

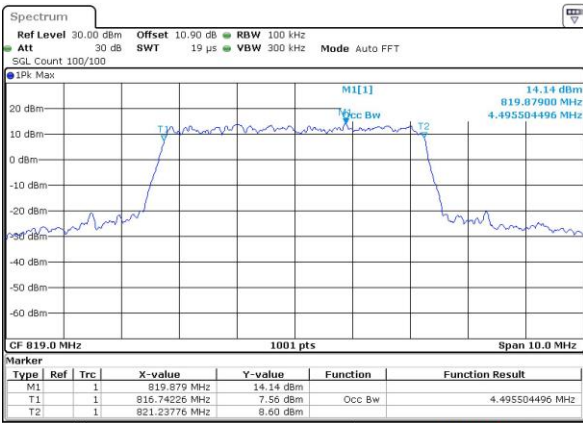

Date: 26 MAR 2016 14:13:19

Middle Channel / 5MHz / 16QAM

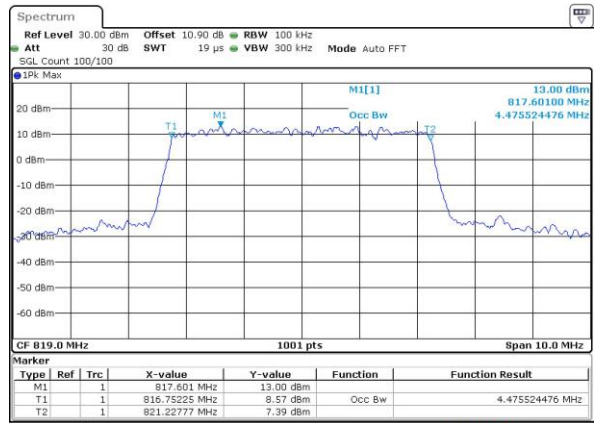

Date: 26 MAR 2016 14:13:30

Highest Channel / 5MHz / QPSK

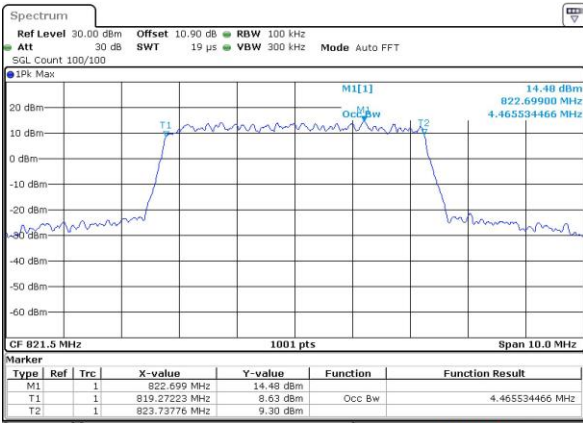

Date: 26 MAR 2016 14:15:50

Highest Channel / 5MHz / 16QAM

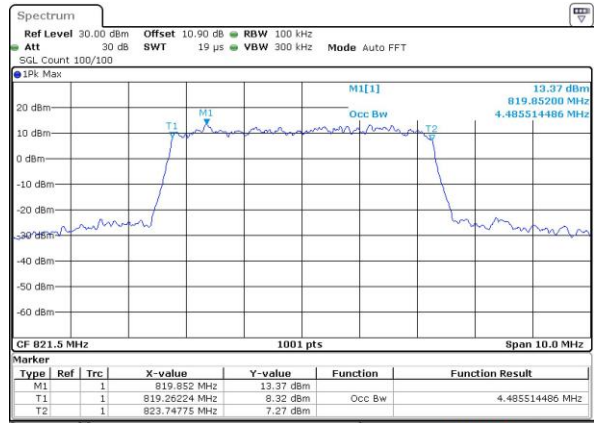

Date: 26 MAR 2016 14:16:01



LTE Band 26

Middle Channel / 10MHz / QPSK

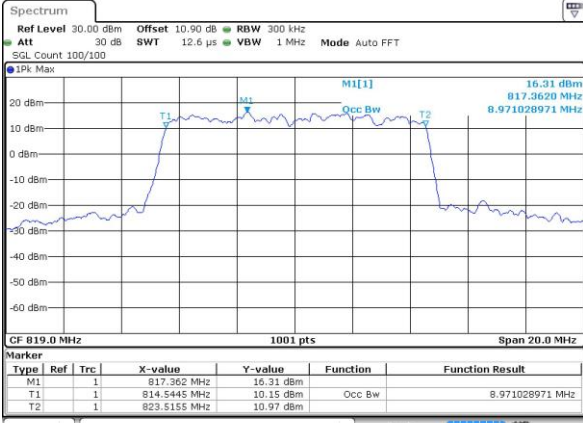

Date: 26 MAR 2016 14:18:21

Middle Channel / 10MHz / 16QAM

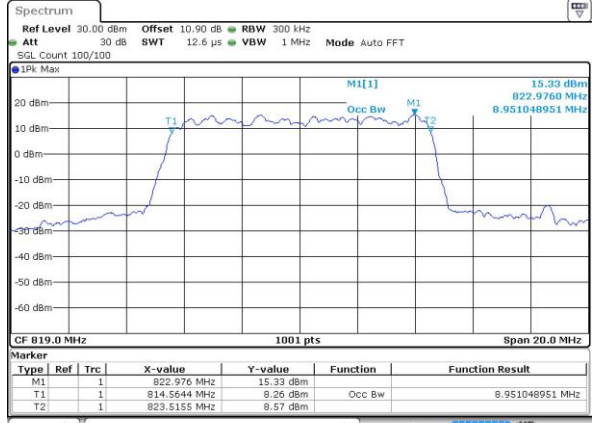

Date: 26 MAR 2016 14:18:32



Emissions Mask

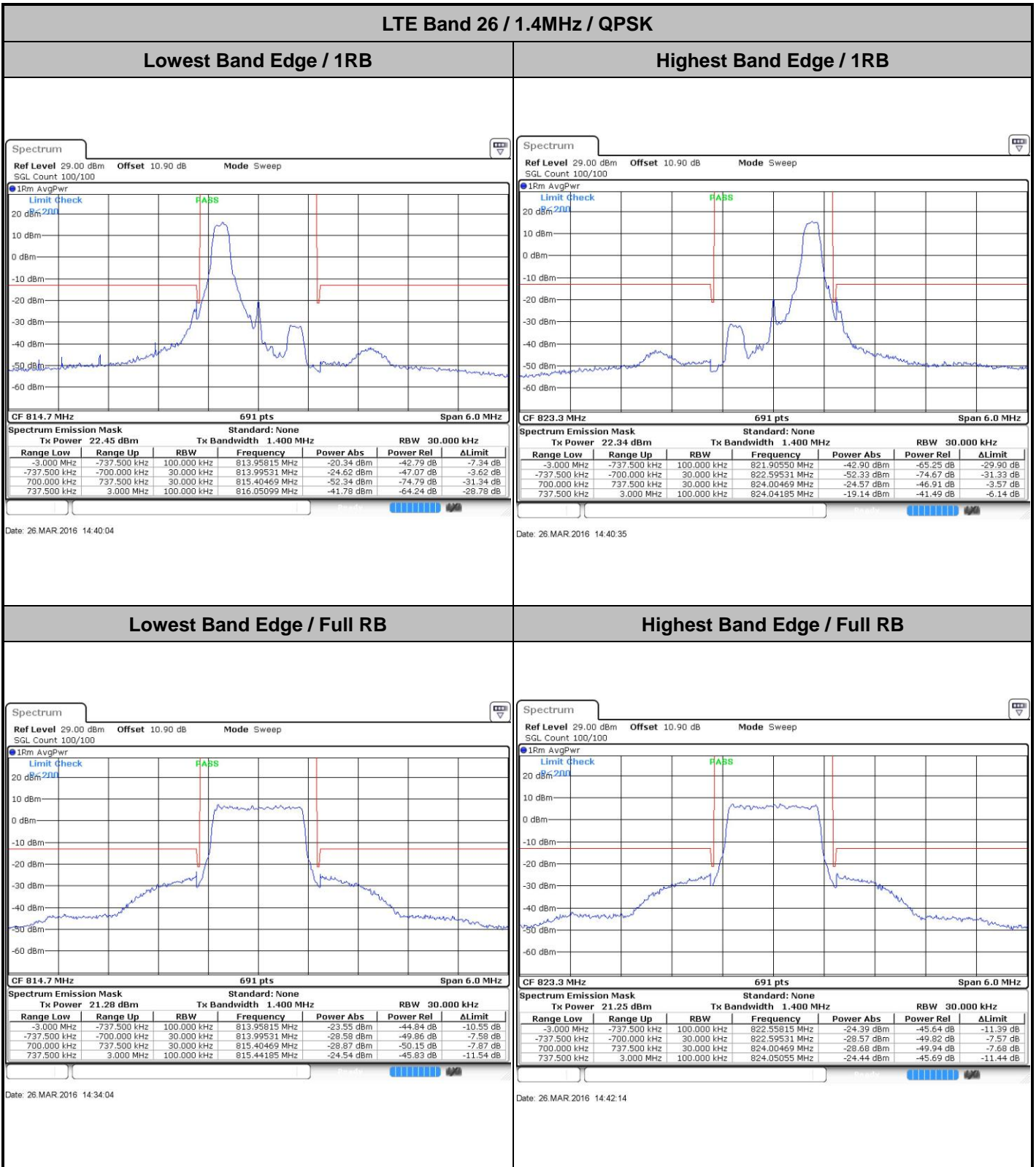



LTE Band 26 / 1.4MHz / 16QAM

Lowest Band Edge / 1 RB

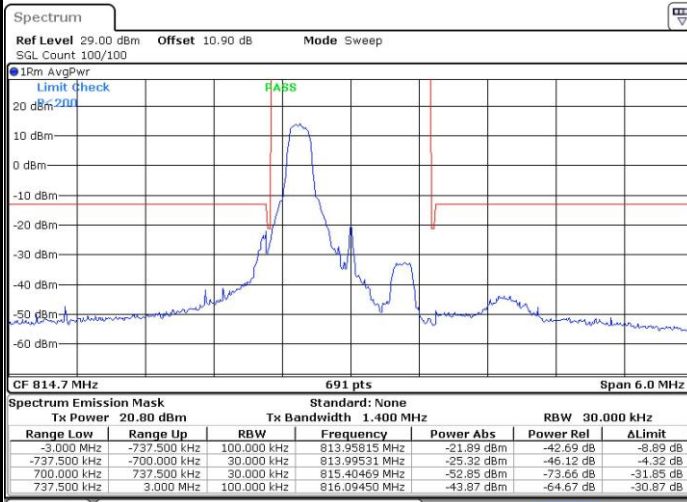

Date: 26 MAR 2016 14:39:42

Highest Band Edge / 1 RB

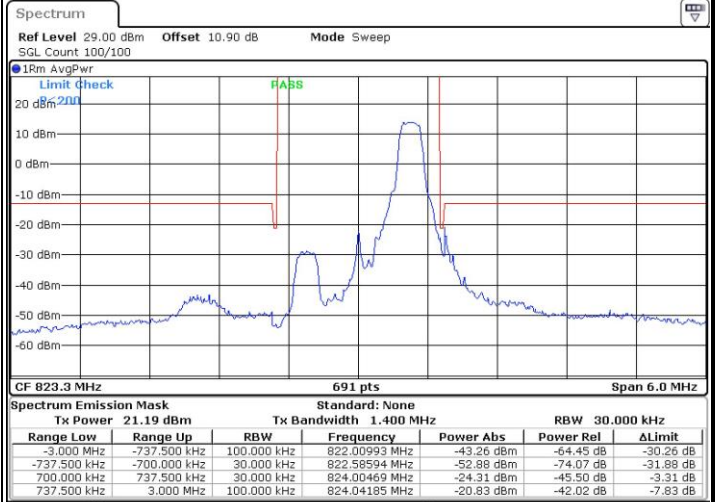

Date: 26 MAR 2016 14:41:14

Lowest Band Edge / Full RB

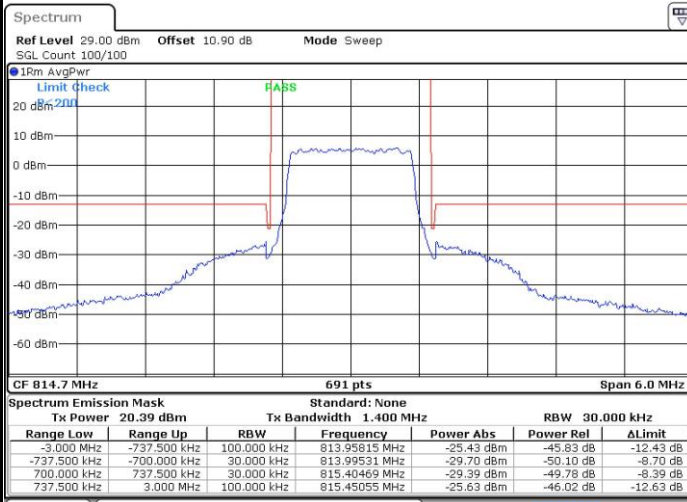

Date: 26 MAR 2016 14:39:26

Highest Band Edge / Full RB

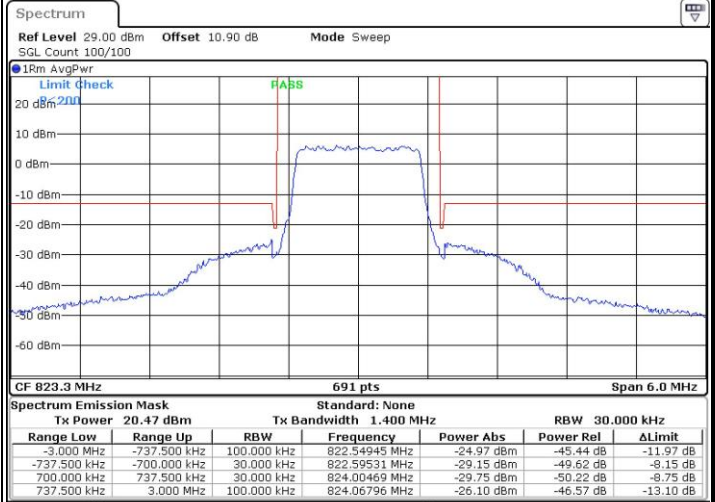

Date: 26 MAR 2016 14:41:54



LTE Band 26 / 3MHz / QPSK

Lowest Band Edge / 1RB

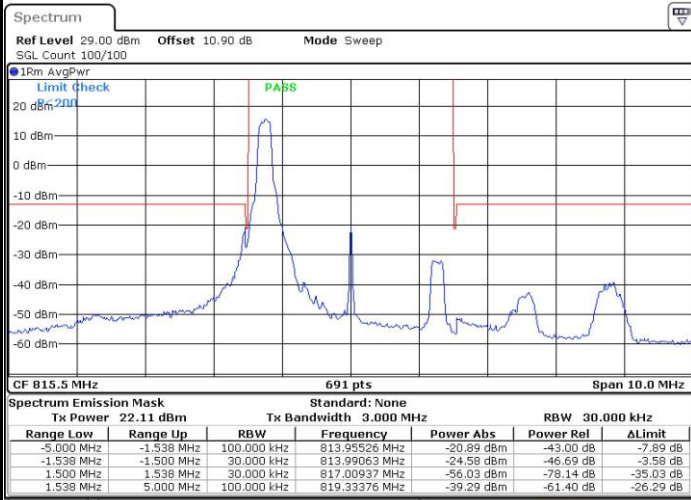

Date: 26 MAR 2016 14:46:04

Highest Band Edge / 1 RB

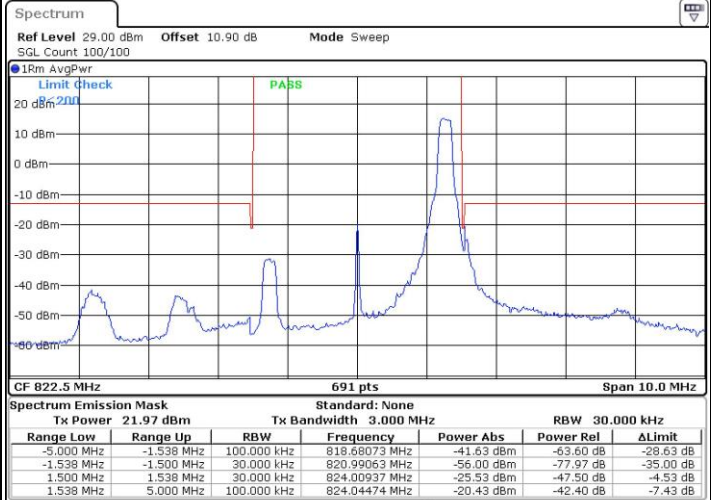

Date: 26 MAR 2016 14:42:46

Lowest Band Edge / Full RB



Date: 26 MAR 2016 14:44:44

Highest Band Edge / Full RB

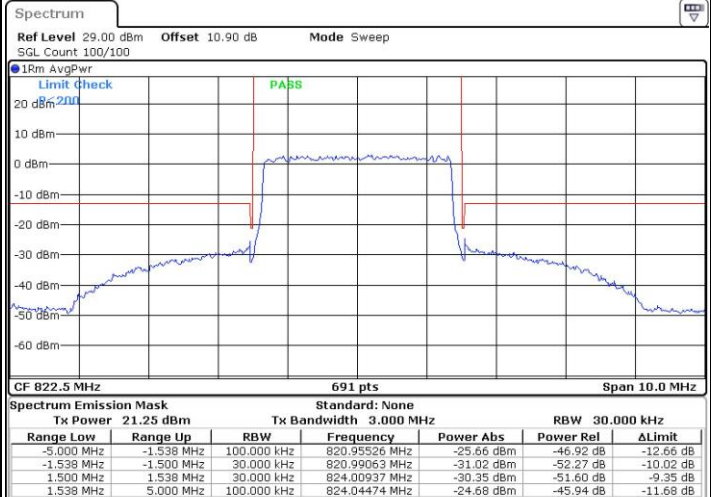

Date: 26 MAR 2016 14:44:20



LTE Band 26 / 3MHz / 16QAM

Lowest Band Edge / 1 RB

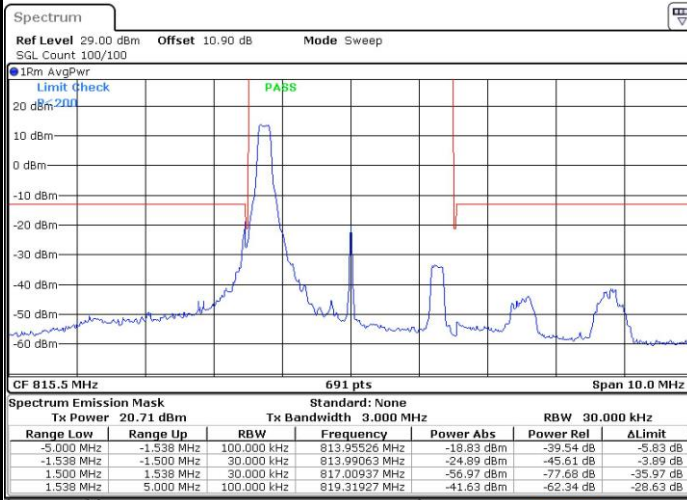

Date: 26 MAR 2016 14:45:44

Highest Band Edge / 1 RB

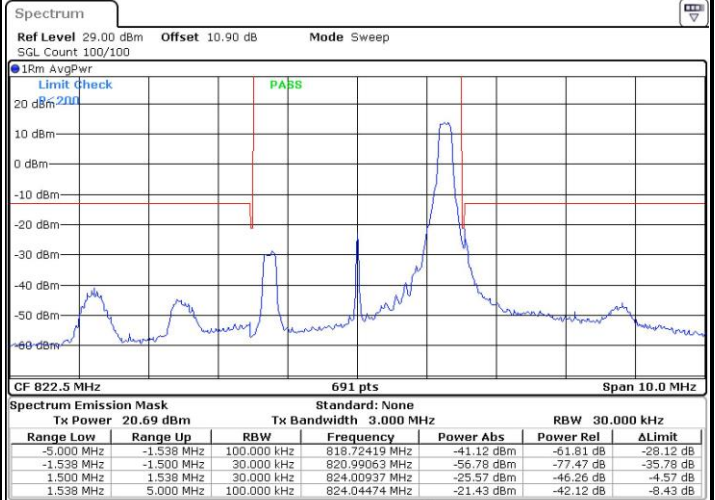

Date: 26 MAR 2016 14:43:04

Lowest Band Edge / Full RB

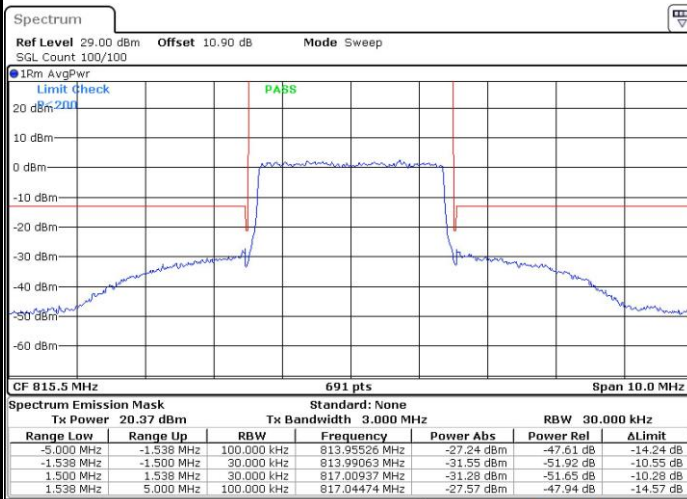

Date: 26 MAR 2016 14:45:26

Highest Band Edge / Full RB

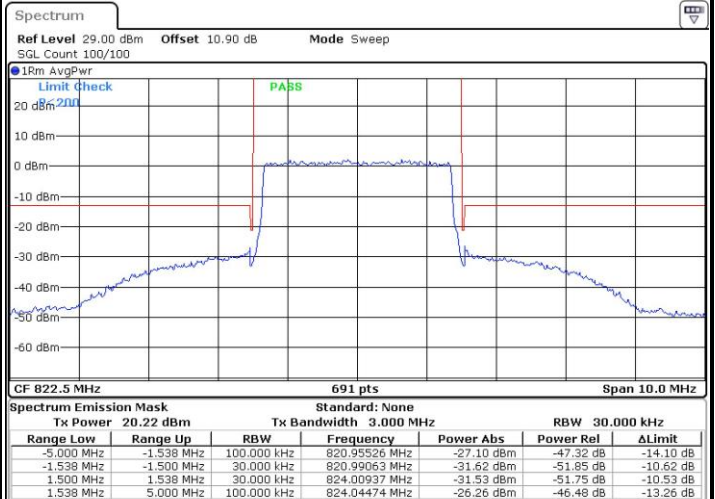

Date: 26 MAR 2016 14:43:40