



FCC RF Test Report

APPLICANT : Motorola Mobility, LLC
EQUIPMENT : Mobile Cellular Phone
BRAND NAME : Motorola
MODEL NAME : 6918
FCC ID : IHDT56VA5
STANDARD : FCC Part 15 Subpart C §15.247
CLASSIFICATION : (DTS) Digital Transmission System

This is a variant report which is only valid together with the original test report. The product was received on Feb. 03, 2016. We, SPORTON INTERNATIONAL INC., would like to declare that the tested sample has been evaluated in accordance with the test procedures and has been in compliance with the applicable technical standards.

The test results in this report apply exclusively to the tested model / sample. Without written approval of SPORTON INTERNATIONAL INC., the test report shall not be reproduced except in full.

Reviewed by: Joseph Lin / Supervisor

Approved by: Jones Tsai / Manager



SPORTON INTERNATIONAL INC.

No. 52, Hwa Ya 1st Rd., Hwa Ya Technology Park, Kwei-Shan District, Tao Yuan City, Taiwan, R.O.C.

SPORTON INTERNATIONAL INC.

TEL : 886-3-327-3456

FAX : 886-3-328-4978

FCC ID : IHDT56VA5

Page Number : 1 of 5

Report Issued Date : May 12, 2016

Report Version : Rev. 02

Report Template No.: BU5-FR15CBT4.0 Version 1.2



TABLE OF CONTENTS

REVISION HISTORY..... 3

1 GENERAL DESCRIPTION..... 4

 1.1 Applicant 4

 1.2 Manufacturer..... 4

 1.3 Product Feature of Equipment Under Test..... 4

 1.4 Re-use of Measured Data 5

 1.5 Modification of EUT 5

APPENDIX A. ORIGINAL REPORT



1 General Description

1.1 Applicant

Motorola Mobility, LLC
222 W. Merchandise Mart Plaza, Chicago IL 60654 USA

1.2 Manufacturer

Motorola Mobility, LLC
222 W. Merchandise Mart Plaza, Chicago IL 60654 USA

1.3 Product Feature of Equipment Under Test

Product Feature	
Equipment	Mobile Cellular Phone
Brand Name	Motorola
Model Name	6918
FCC ID	IHDT56VA5
EUT supports Radios application	GSM/EGPRS/WCDMA/HSPA/LTE/FM WLAN 11b/g/n HT20 WLAN 11a/n HT20/HT40 Bluetooth v3.0 EDR Bluetooth v4.0 LE
HW Version	DVT2
EUT Stage	Identical Prototype

Remark: The above EUT's information was declared by manufacturer. Please refer to the specifications or user's manual for more detailed description.



1.4 Re-use of Measured Data

This application re-uses data collected on a similar device. The subject device of this application (Model 6918, FCC ID IHDT56VA5) is electrically identical to the reference device (Model 8028, FCC ID IHDT56VA2) for the portions of the circuitry corresponding to the data being re-used, as treated by KDB Publication 178919 D01.

For details concerning the similarity with respect to component placement, mechanical/electrical design etc., please refer to the Operational Description.

The re-used RF data includes the following bands provided in Appendix A (Sporton RF Report No. FR620325B for the reference device Model 8028, FCC ID IHDT56VA2):

-Bluetooth

In order to confirm hardware similarity of the subject device with the reference device, spot check measurements were performed on the subject device for the individual cases.

Considering the spot check has been performed at the worst case within WLAN 2.4GHz of the reference device, hence Bluetooth - LE is not required to be tested.

Please refer to the DTS WLAN report.

Assertions concerning the similarity of these devices are based on representations by the applicant. The applicant accepts full responsibility for the validity of the similarity claim, and for the determination that verification test data are sufficient to support it.

1.5 Modification of EUT

No modifications are made to the EUT during all test items.



Appendix A. Original Report

Please refer to Sporton report number FR620325B as below.



FCC RF Test Report

APPLICANT : Motorola Mobility, LLC
EQUIPMENT : Mobile Cellular Phone
BRAND NAME : Motorola
MODEL NAME : 8028
FCC ID : IHDT56VA2
STANDARD : FCC Part 15 Subpart C §15.247
CLASSIFICATION : (DTS) Digital Transmission System

The product was received on Feb. 03, 2016 and testing was completed on Mar. 02, 2016. We, SPORTON INTERNATIONAL INC., would like to declare that the tested sample has been evaluated in accordance with the test procedures and has been in compliance with the applicable technical standards.

The test results in this report apply exclusively to the tested model / sample. Without written approval of SPORTON INTERNATIONAL INC., the test report shall not be reproduced except in full.

Reviewed by: Joseph Lin / Supervisor

Approved by: Jones Tsai / Manager



SPORTON INTERNATIONAL INC.

No. 52, Hwa Ya 1st Rd., Hwa Ya Technology Park, Kwei-Shan District, Tao Yuan City, Taiwan, R.O.C.



TABLE OF CONTENTS

SUMMARY OF TEST RESULT 4

1 GENERAL DESCRIPTION..... 5

1.1 Applicant 5

1.2 Manufacturer..... 5

1.3 Product Feature of Equipment Under Test..... 5

1.4 Product Specification of Equipment Under Test..... 6

1.5 Modification of EUT 6

1.6 Testing Location 7

1.7 Applicable Standards..... 7

2 TEST CONFIGURATION OF EQUIPMENT UNDER TEST..... 8

2.1 Descriptions of Test Mode 8

2.2 Test Mode..... 9

2.3 Connection Diagram of Test System..... 10

2.4 Support Unit used in test configuration and system 11

2.5 EUT Operation Test Setup 11

2.6 Measurement Results Explanation Example..... 11

3 TEST RESULT 12

3.1 6dB and 99% Bandwidth Measurement 12

3.2 Peak Output Power Measurement 17

3.3 Power Spectral Density Measurement 18

3.4 Conducted Band Edges and Spurious Emission Measurement 23

3.5 Radiated Band Edges and Spurious Emission Measurement 32

3.6 AC Conducted Emission Measurement..... 36

3.7 Antenna Requirements 41

4 LIST OF MEASURING EQUIPMENT..... 42

5 UNCERTAINTY OF EVALUATION..... 43

APPENDIX A. CONDUCTED TEST RESULTS

APPENDIX B. RADIATED TEST RESULTS

APPENDIX C. RADIATED SPURIOUS EMISSION PLOTS



SUMMARY OF TEST RESULT

Report Section	FCC Rule	Description	Limit	Result	Remark
3.1	15.247(a)(2)	6dB Bandwidth	$\geq 0.5\text{MHz}$	Pass	-
3.1	-	99% Bandwidth	-	Pass	-
3.2	15.247(b)(1)	Peak Output Power	$\leq 30\text{dBm}$	Pass	-
3.3	15.247(e)	Power Spectral Density	$\leq 8\text{dBm}/3\text{kHz}$	Pass	-
3.4	15.247(d)	Conducted Band Edges and Spurious Emission	$\leq 20\text{dBc}$	Pass	-
3.5	15.247(d)	Radiated Band Edges and Spurious Emission	15.209(a) & 15.247(d)	Pass	Under limit 7.63 dB at 2486.240 MHz
3.6	15.207	AC Conducted Emission	15.207(a)	Pass	Under limit 13.40 dB at 3.222 MHz
3.7	15.203 & 15.247(b)	Antenna Requirement	N/A	Pass	-



1 General Description

1.1 Applicant

Motorola Mobility, LLC
222 W. Merchandise Mart Plaza, Chicago IL 60654 USA

1.2 Manufacturer

Motorola Mobility, LLC
222 W. Merchandise Mart Plaza, Chicago IL 60654 USA

1.3 Product Feature of Equipment Under Test

Product Feature	
Equipment	Mobile Cellular Phone
Brand Name	Motorola
Model Name	8028
FCC ID	IHDT56VA2
IMEI Code	354117070006154 (for Radiated Spurious Emission) 354117070005990 (for AC Conducted Emission)
EUT supports Radios application	GSM/EGPRS/WCDMA/HSPA/LTE/FM WLAN 11b/g/n HT20 WLAN 11a/n HT20/HT40 Bluetooth v3.0 EDR Bluetooth v4.0 LE
HW Version	DVT2
EUT Stage	Identical Prototype

Remark: The above EUT's information was declared by manufacturer. Please refer to the specifications or user's manual for more detailed description.

Accessory List	
AC Adapter	Brand Name : Motorola
	Model Name : SPN5866A
Earphone	Brand Name : Motorola
	Model Name : SJYN1181B
USB Cable	Brand Name : Motorola
	Model Name : SKN6462A



1.4 Product Specification of Equipment Under Test

Standards-related Product Specification	
Tx/Rx Frequency Range	2402 MHz ~ 2480 MHz
Number of Channels	40
Carrier Frequency of Each Channel	40 Channel(37 hopping + 3 advertising channel)
Maximum Output Power to Antenna	3.62 dBm (0.0023 W)
99% Occupied Bandwidth	1.060MHz
Antenna Type	Fixed Internal Antenna (The antenna peak gain of EUT is less than 6 dBi)
Type of Modulation	Bluetooth LE : GFSK

1.5 Modification of EUT

No modifications are made to the EUT during all test items.



1.6 Testing Location

Sporton Lab is accredited to ISO 17025 by Taiwan Accreditation Foundation (TAF code : 1190) and the FCC designation No. TW1022 under the FCC 2.948(e) by Mutual Recognition Agreement (MRA) in FCC Test.

Test Site	SPORTON INTERNATIONAL INC.		
Test Site Location	No. 52, Hwa Ya 1 st Rd., Hwa Ya Technology Park, Kwei-Shan District, Tao Yuan City, Taiwan, R.O.C. TEL: +886-3-327-3456 FAX: +886-3-328-4978		
Test Site No.	Sporton Site No.		
	TH02-HY	CO05-HY	03CH07-HY

Note: The test site complies with ANSI C63.4 2014 requirement.

1.7 Applicable Standards

According to the specifications of the manufacturer, the EUT must comply with the requirements of the following standards:

- ♦ FCC Part 15 Subpart C §15.247
- ♦ FCC KDB Publication No. 558074 D01 DTS Meas. Guidance v03r05
- ♦ ANSI C63.10-2013

Remark:

1. All test items were verified and recorded according to the standards and without any deviation during the test.
2. This EUT has also been tested and complied with the requirements of FCC Part 15, Subpart B, recorded in a separate test report.



2 Test Configuration of Equipment Under Test

2.1 Descriptions of Test Mode

The RF output power was recorded in the following table:

Channel	Frequency	Bluetooth 4.0 – LE RF Output Power	
		Data Rate / Modulation	
		GFSK	
		1Mbps	
Ch00	2402MHz	2.80 dBm	
Ch19	2440MHz	3.62 dBm	
Ch39	2480MHz	2.29 dBm	

Channel	Frequency	Bluetooth 4.0 – LE RF Average Power	
		Data Rate / Modulation	
		GFSK	
		1Mbps	
Ch00	2402MHz	1.58 dBm	
Ch19	2440MHz	2.57 dBm	
Ch39	2480MHz	0.80 dBm	

- a. The EUT has been associated with peripherals and configuration operated in a manner tended to maximize its emission characteristics in a typical application. Frequency range investigated: conduction (150 kHz to 30 MHz), radiation (9 kHz to the 10th harmonic of the highest fundamental frequency or to 40 GHz, whichever is lower). Pre-scanned tests, X, Y, Z in three orthogonal panels to determine the final configuration (X plane as worst plane) from all possible combinations.
- b. AC power line Conducted Emission was tested under maximum output power.



2.2 Test Mode

The following summary table is showing all test modes to demonstrate in compliance with the standard.

Summary table of Test Cases	
Test Item	Data Rate / Modulation
	Bluetooth 4.0 – LE / GFSK
Conducted TCs	Mode 1: Bluetooth Tx CH00_2402 MHz_1Mbps Mode 2: Bluetooth Tx CH19_2440 MHz_1Mbps Mode 3: Bluetooth Tx CH39_2480 MHz_1Mbps
Radiated TCs	Mode 1: Bluetooth Tx CH00_2402 MHz_1Mbps Mode 2: Bluetooth Tx CH19_2440 MHz_1Mbps Mode 3: Bluetooth Tx CH39_2480 MHz_1Mbps
AC Conducted Emission	Mode 1: GSM850 Idle + Bluetooth Link + WLAN (2.4GHz) Link + Earphone + MP3 + USB Cable (Charging from Adapter)

2.3 Connection Diagram of Test System

<Bluetooth 4.0 – LE Tx Mode>

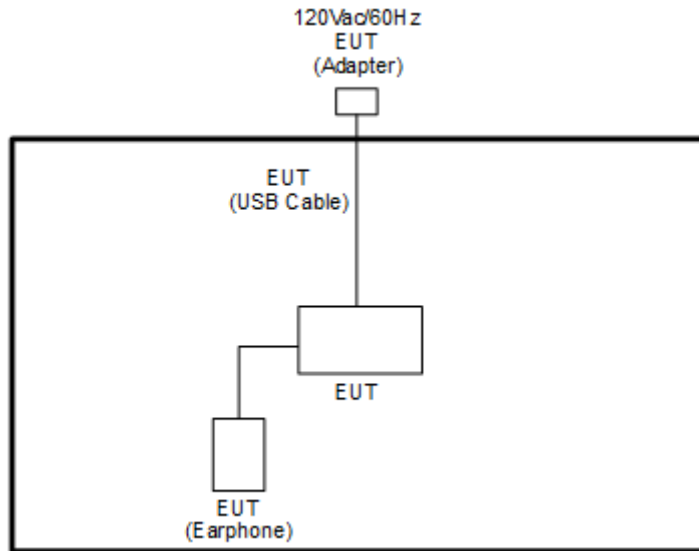

<AC Conducted Emission Mode>

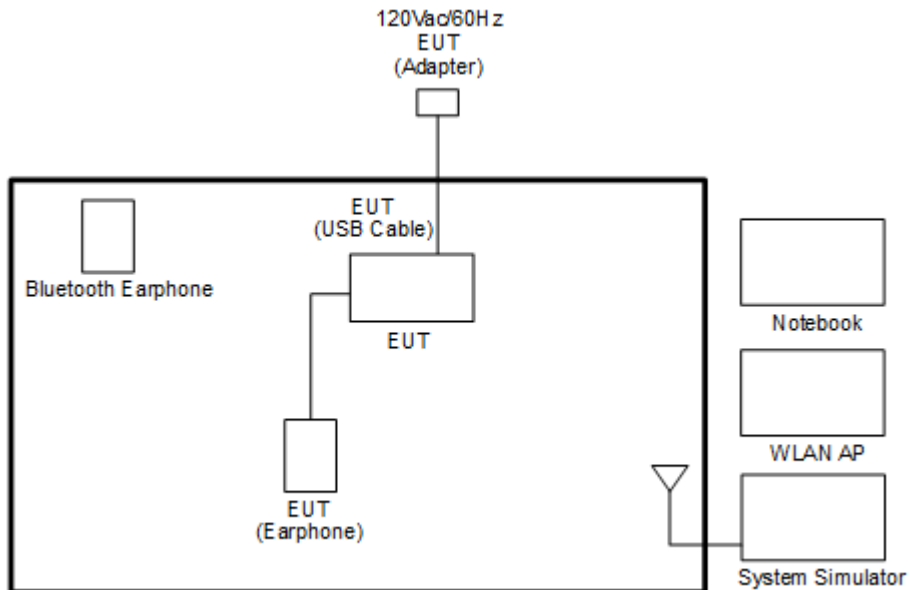



2.4 Support Unit used in test configuration and system

Item	Equipment	Trade Name	Model Name	FCC ID	Data Cable	Power Cord
1.	System Simulator	Anritsu	MT8820C	N/A	N/A	Unshielded, 1.8 m
2.	WLAN AP	D-Link	DIR-865L	KA2IR865LA1	N/A	Unshielded, 1.8 m
3.	Notebook	DELL	Latitude E6320	FCC DoC/ Contains FCC ID: QDS-BRCM1054	N/A	AC I/P: Unshielded, 1.2 m DC O/P: Shielded, 1.8 m
4.	Bluetooth Earphone	Sony Ericsson	MW600	PY7DDA-2029	N/A	N/A
5.	SD Card	SanDisk	MicroSD HC	FCC DoC	N/A	N/A

2.5 EUT Operation Test Setup

For Bluetooth function, programmed RF utility, "QRCT" installed in the notebook make the EUT provide functions like channel selection and power level for continuous transmitting and receiving signals.

2.6 Measurement Results Explanation Example

For all conducted test items:

The offset level is set in the spectrum analyzer to compensate the RF cable loss and attenuator factor between EUT conducted output port and spectrum analyzer. With the offset compensation, the spectrum analyzer reading level is exactly the EUT RF output level.

Example :

The spectrum analyzer offset is derived from RF cable loss and attenuator factor.

Offset = RF cable loss + attenuator factor.

Following shows an offset computation example with cable loss 4.2 dB and 10dB attenuator.

$$\begin{aligned} \text{Offset(dB)} &= \text{RF cable loss(dB)} + \text{attenuator factor(dB)}. \\ &= 4.2 + 10 = 14.2 \text{ (dB)} \end{aligned}$$

3 Test Result

3.1 6dB and 99% Bandwidth Measurement

3.1.1 Limit of 6dB and 99% Bandwidth

The minimum 6 dB bandwidth shall be at least 500 kHz.

3.1.2 Measuring Instruments

The section 4.0 of List of Measuring Equipment of this test report is used for test.

3.1.3 Test Procedures

1. The testing follows FCC KDB Publication No. 558074 D01 DTS Meas. Guidance v03r05.
2. The RF output of EUT was connected to the spectrum analyzer by RF cable and attenuator. The path loss was compensated to the results for each measurement.
3. Set to the maximum power setting and enable the EUT transmit continuously.
4. Make the measurement with the spectrum analyzer's resolution bandwidth (RBW) = 100 kHz. Set the Video bandwidth (VBW) = 300 kHz. In order to make an accurate measurement. The 6 dB bandwidth must be greater than 500 kHz.
5. For 99% Bandwidth Measurement, the spectrum analyzer's resolution bandwidth (RBW) is set 30kHz and set the Video bandwidth (VBW) = 100kHz.
6. Measure and record the results in the test report.

3.1.4 Test Setup

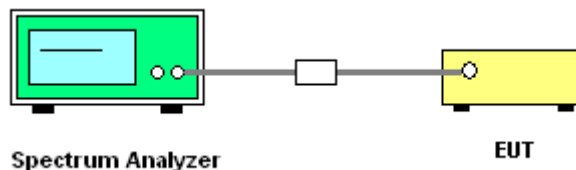



3.1.5 Test Result of 6dB Bandwidth

Test data refer to Appendix A.

6 dB Bandwidth Plot on Channel 00

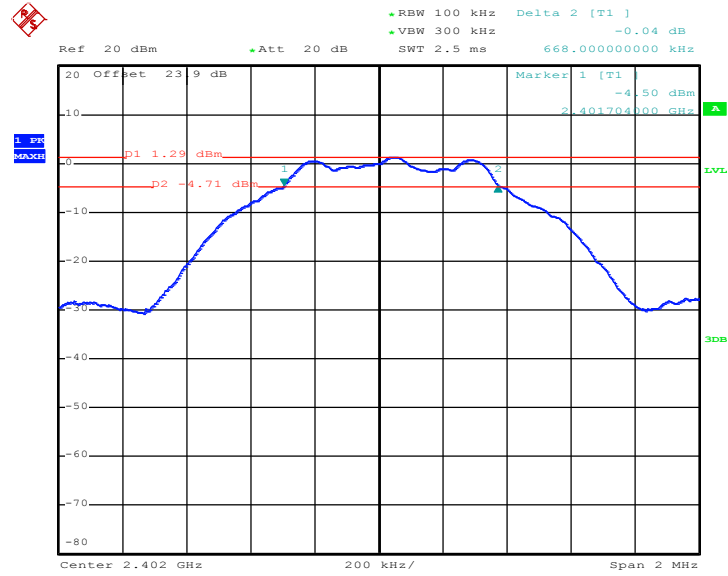

Date: 9.FEB.2016 11:18:26



6 dB Bandwidth Plot on Channel 19

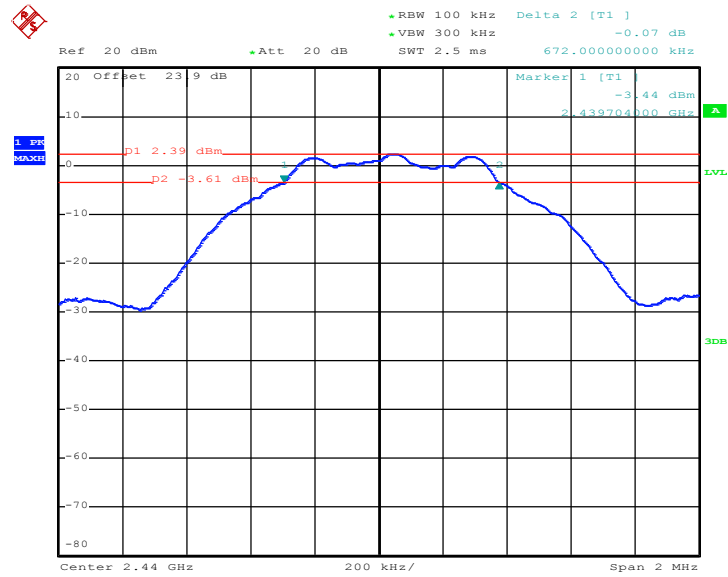

Date: 9.FEB.2016 11:24:39

6 dB Bandwidth Plot on Channel 39

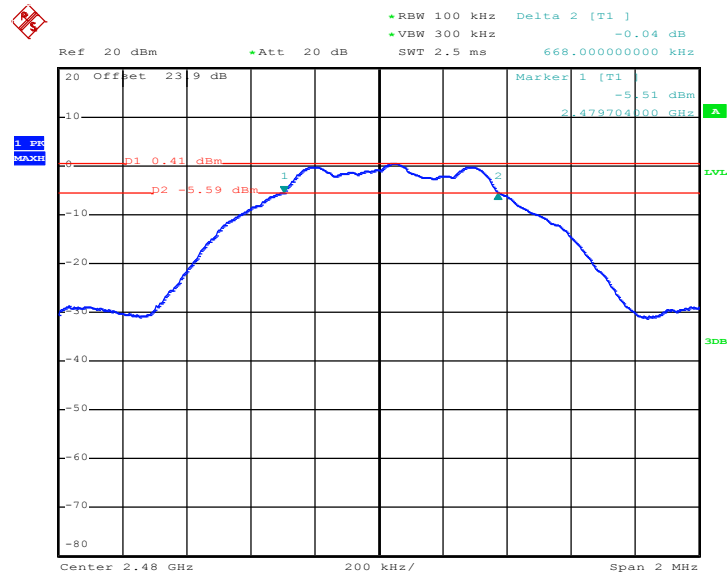

Date: 9.FEB.2016 11:32:21



3.1.6 Test Result of 99% Occupied Bandwidth

Test data refer to Appendix A.

99% Occupied Bandwidth Plot on Channel 00

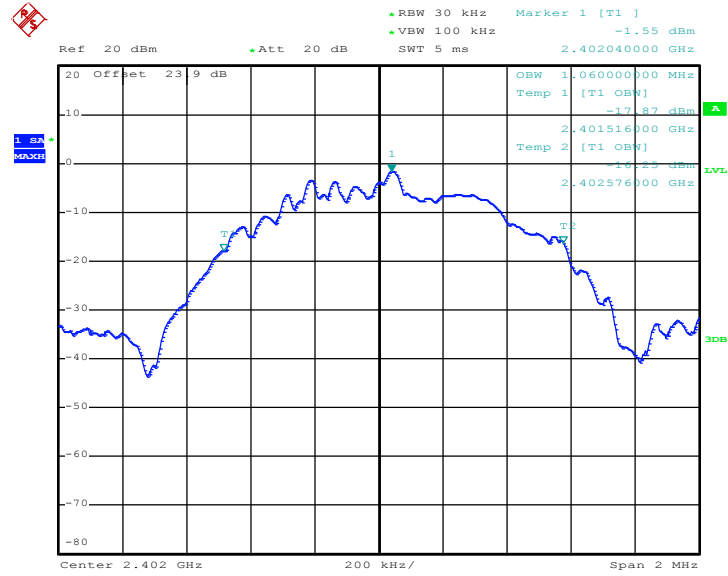

Date: 9.FEB.2016 11:21:53



99% Occupied Bandwidth Plot on Channel 19

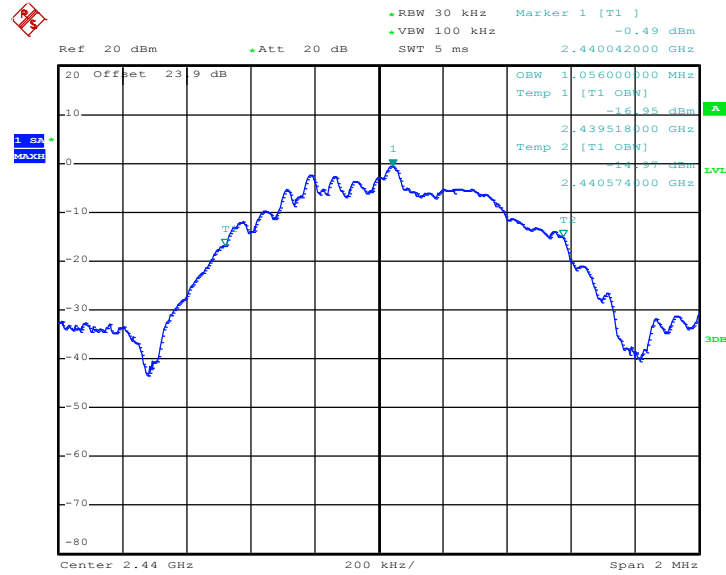

Date: 9.FEB.2016 11:28:27

99% Occupied Bandwidth Plot on Channel 39

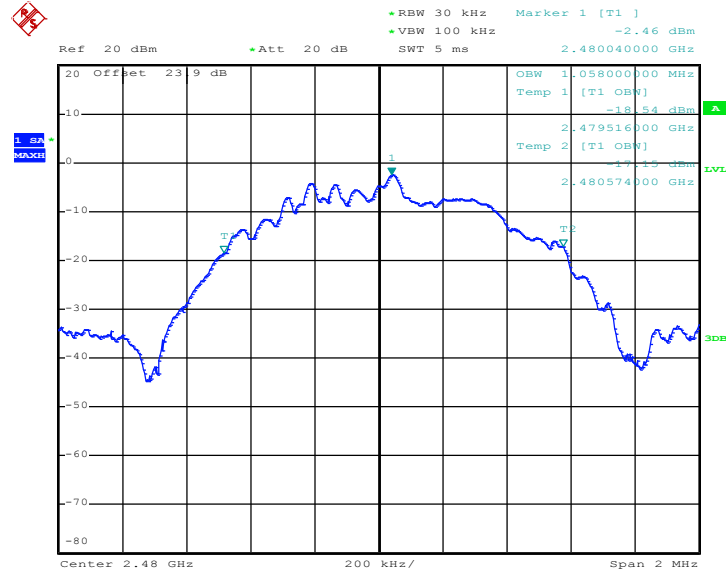

Date: 9.FEB.2016 11:38:38

Note : The occupied channel bandwidth is maintained within the band of operation for all of the modulations.

3.2 Peak Output Power Measurement

3.2.1 Limit of Peak Output Power

For systems using digital modulation in the 2400-2483.5MHz, the limit for peak output power is 30dBm. If transmitting antenna of directional gain greater than 6dBi is used, the peak output power from the intentional radiator shall be reduced below the above stated value by the amount in dB that the directional gain of the antenna exceeds 6 dBi. In case of point-to-point operation, the limit has to be reduced by 1dB for every 3dB that the directional gain of the antenna exceeds 6dBi.

3.2.2 Measuring Instruments

The section 4.0 of List of Measuring Equipment of this test report is used for test.

3.2.3 Test Procedures

1. The testing follows the Measurement Procedure of FCC KDB No. 558074 DTS D01 Meas. Guidance v03r05 section 9.1.2 PKPM1 Peak power meter method.
2. The RF output of EUT was connected to the power meter by RF cable and attenuator. The path loss was compensated to the results for each measurement.
3. Set to the maximum power setting and enable the EUT transmit continuously.
4. Measure the conducted output power and record the results in the test report.

3.2.4 Test Setup

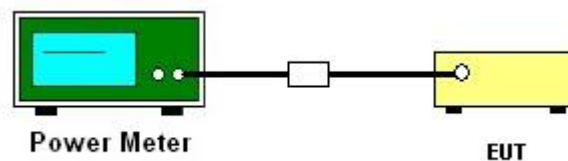

3.2.5 Test Result of Peak Output Power

Test data refers to Appendix A.

3.3 Power Spectral Density Measurement

3.3.1 Limit of Power Spectral Density

The peak power spectral density shall not be greater than 8dBm in any 3kHz band at any time interval of continuous transmission.

3.3.2 Measuring Instruments

The section 4.0 of List of Measuring Equipment of this test report is used for test.

3.3.3 Test Procedures

1. The testing follows Measurement Procedure 10.2 Method PKPSD of FCC KDB Publication No. 558074 D01 DTS Meas. Guidance v03r05
2. The RF output of EUT was connected to the spectrum analyzer by RF cable and attenuator. The path loss was compensated to the results for each measurement.
3. Set to the maximum power setting and enable the EUT transmit continuously.
4. Make the measurement with the spectrum analyzer's resolution bandwidth (RBW) = 3 kHz. Video bandwidth VBW = 10 kHz In order to make an accurate measurement, set the span to 1.5 times DTS Channel Bandwidth. (6dB BW)
5. Detector = peak, Sweep time = auto couple, Trace mode = max hold, Allow trace to fully stabilize. Use the peak marker function to determine the maximum power level.
6. Measure and record the results in the test report.
7. The Measured power density (dBm)/ 100kHz is a reference level and used as 20dBc down limit line for Conducted Band Edges and Conducted Spurious Emission.

3.3.4 Test Setup

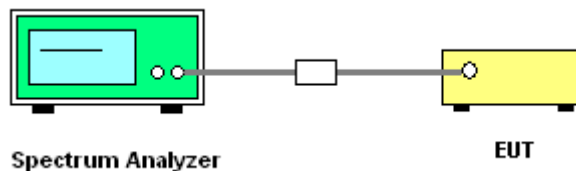



3.3.5 Test Result of Power Spectral Density

Test data refers to Appendix A.

3.3.6 Test Result of Power Spectral Density Plots (100kHz)

PSD 100kHz Plot on Channel 00

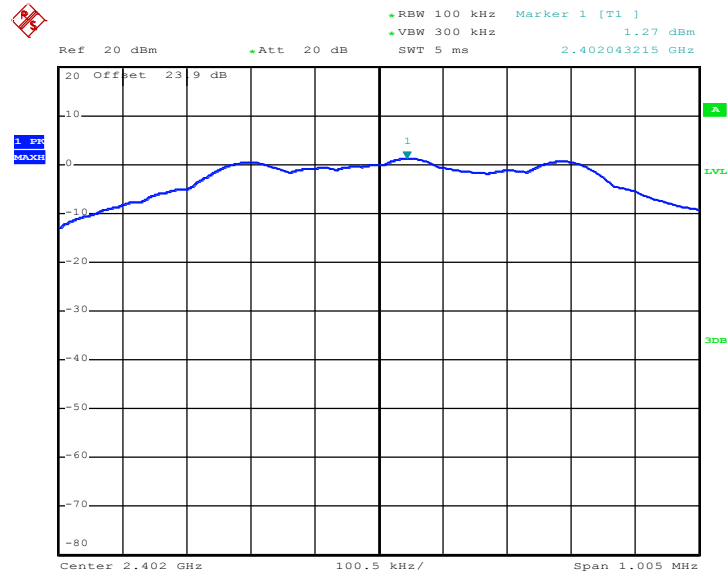

Date: 9.FEB.2016 11:19:08



PSD 100kHz Plot on Channel 19

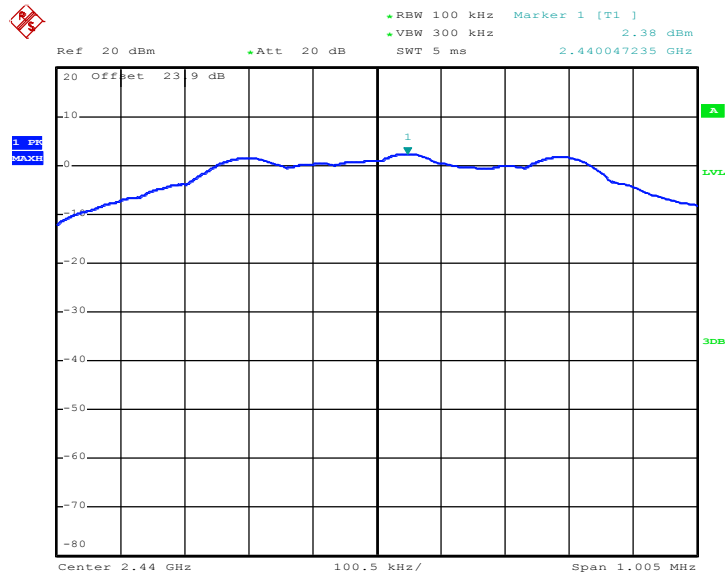

Date: 9.FEB.2016 11:27:19

PSD 100kHz Plot on Channel 39

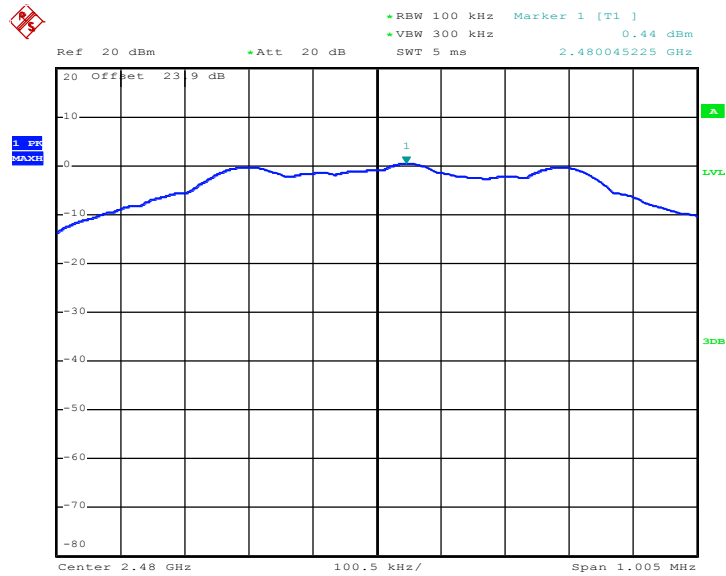

Date: 9.FEB.2016 11:35:21



3.3.7 Test Result of Power Spectral Density Plots (3kHz)

PSD 3kHz Plot on Channel 00

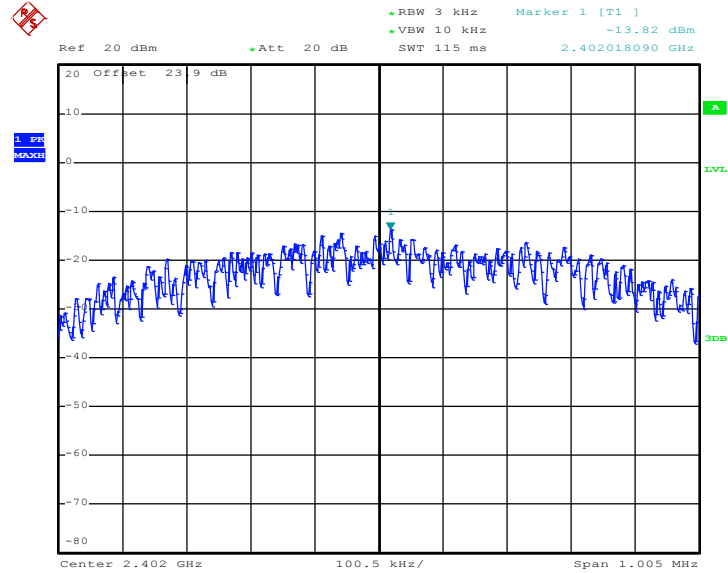

Date: 9.FEB.2016 11:18:44



PSD 3kHz Plot on Channel 19

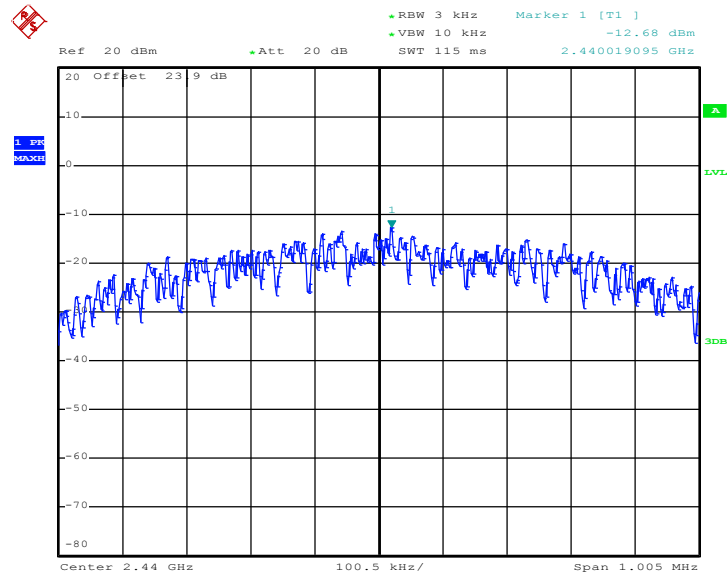

Date: 9.FEB.2016 11:25:24

PSD 3kHz Plot on Channel 39

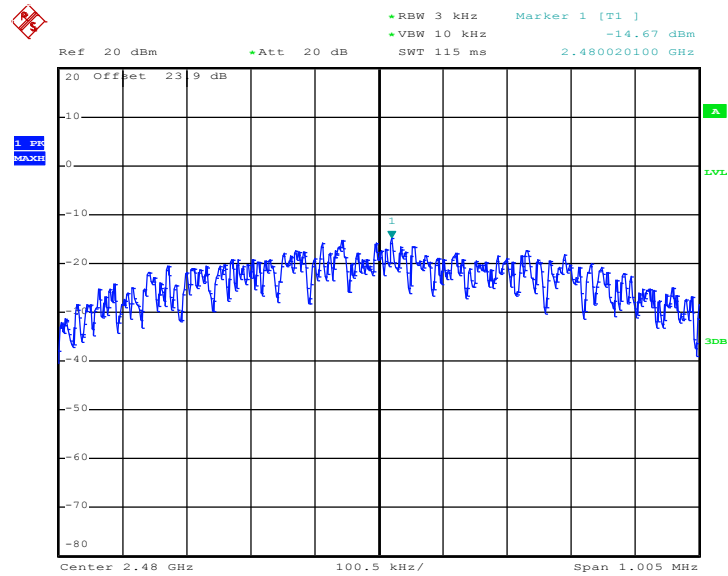

Date: 9.FEB.2016 11:34:07

3.4 Conducted Band Edges and Spurious Emission Measurement

3.4.1 Limit of Conducted Band Edges and Spurious Emission

All harmonics/spurious must be at least 20 dB down from the highest emission level within the authorized band.

3.4.2 Measuring Instruments

The section 4.0 of List of Measuring Equipment of this test report is used for test.

3.4.3 Test Procedure

1. The testing follows FCC KDB Publication No. 558074 D01 DTS Meas. Guidance v03r05.
2. The RF output of EUT was connected to the spectrum analyzer by RF cable and attenuator. The path loss was compensated to the results for each measurement.
3. Set to the maximum power setting and enable the EUT transmit continuously.
4. Set RBW = 100 kHz, VBW=300 kHz, Peak Detector. Unwanted Emissions measured in any 100 kHz bandwidth outside of the authorized frequency band shall be attenuated by at least 20 dB relative to the maximum in-band peak PSD level in 100 kHz when maximum peak conducted output power procedure is used. If the transmitter complies with the conducted power limits based on the use of RMS averaging over a time interval, the attenuation required under this paragraph shall be 30 dB instead of 20 dB per 15.247(d).
5. Measure and record the results in the test report.
6. The RF fundamental frequency should be excluded against the limit line in the operating frequency band.

3.4.4 Test Setup

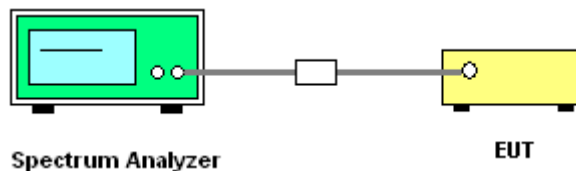



3.4.5 Test Result of Conducted Band Edges Plots

Low Band Edge Plot on Channel 00

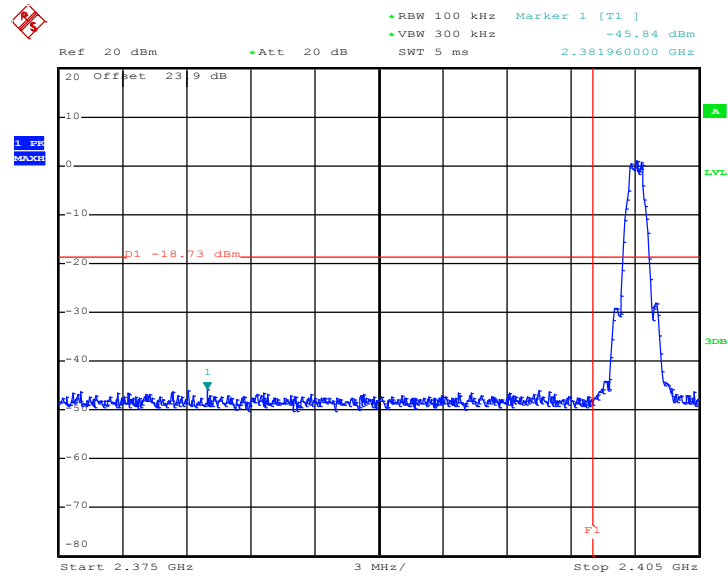

Date: 9.FEB.2016 11:19:26



High Band Edge Plot on Channel 39

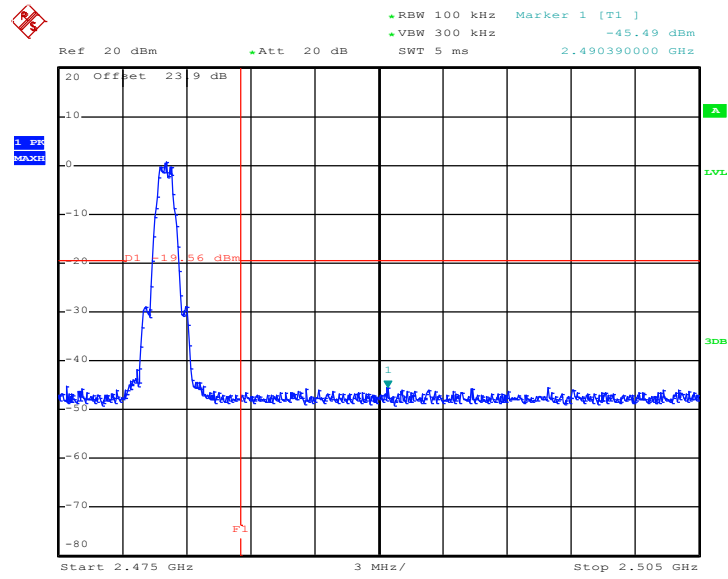

Date: 9.FEB.2016 11:37:54



Conducted Spurious Emission Plot on Bluetooth LE 1Mbps GFSK Channel 00

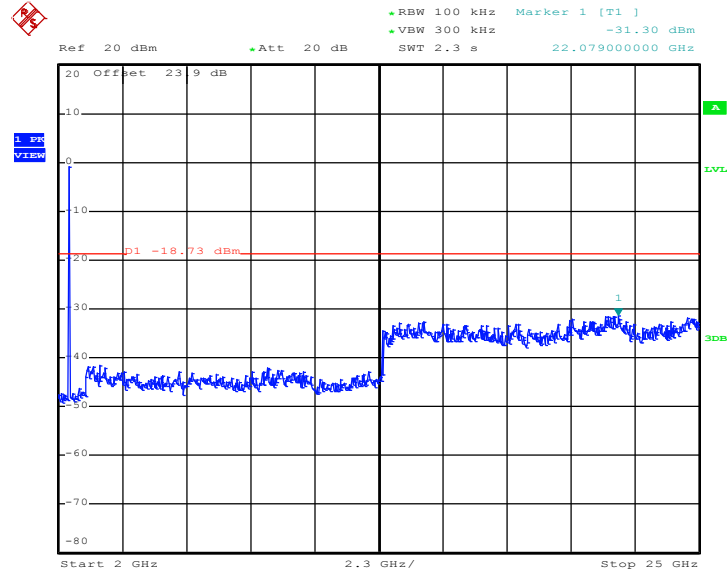

Date: 9.FEB.2016 11:19:46



Conducted Spurious Emission Plot on Bluetooth LE 1Mbps
GFSK Channel 19

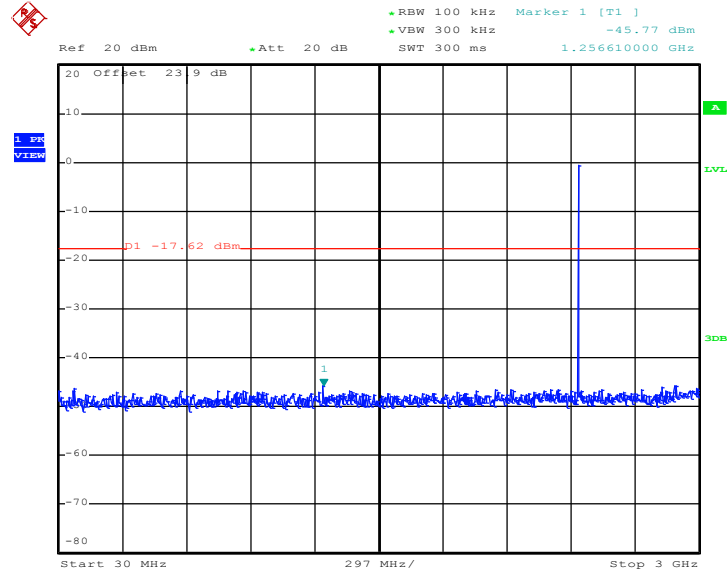

Date: 9.FEB.2016 11:27:35



Conducted Spurious Emission Plot on Bluetooth LE 1Mbps GFSK Channel 19

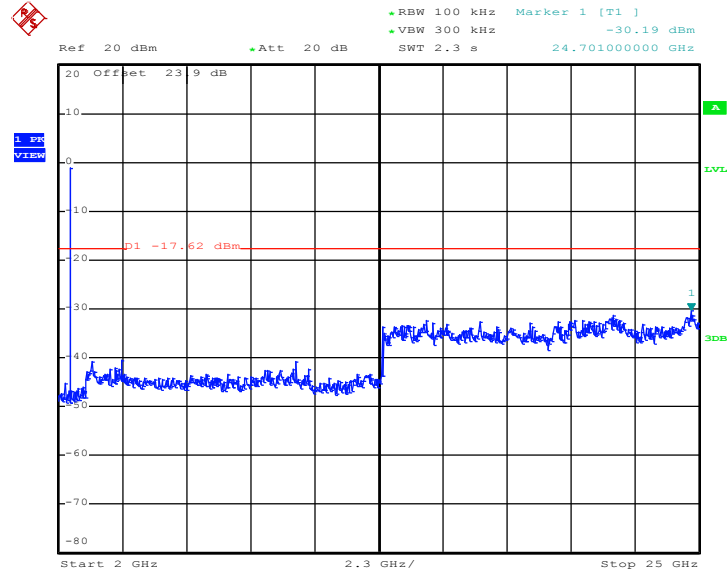

Date: 9.FEB.2016 11:27:44



Conducted Spurious Emission Plot on Bluetooth LE 1Mbps
GFSK Channel 39

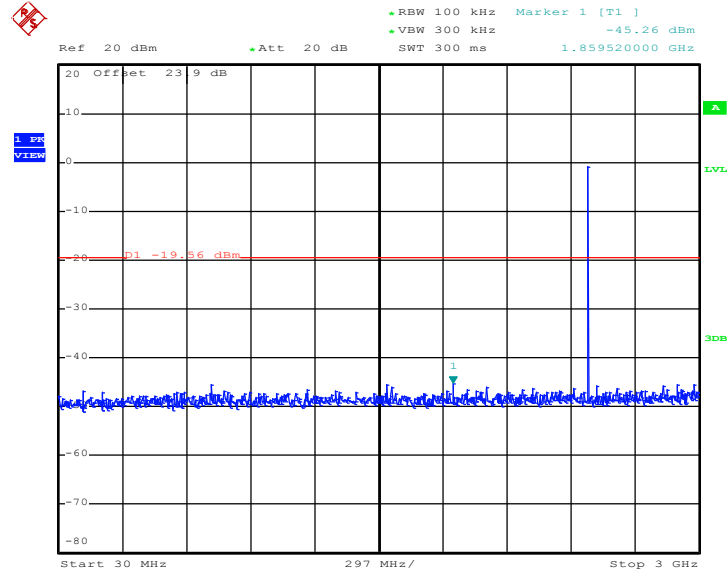

Date: 9.FEB.2016 11:38:06



Conducted Spurious Emission Plot on Bluetooth LE 1Mbps GFSK Channel 39

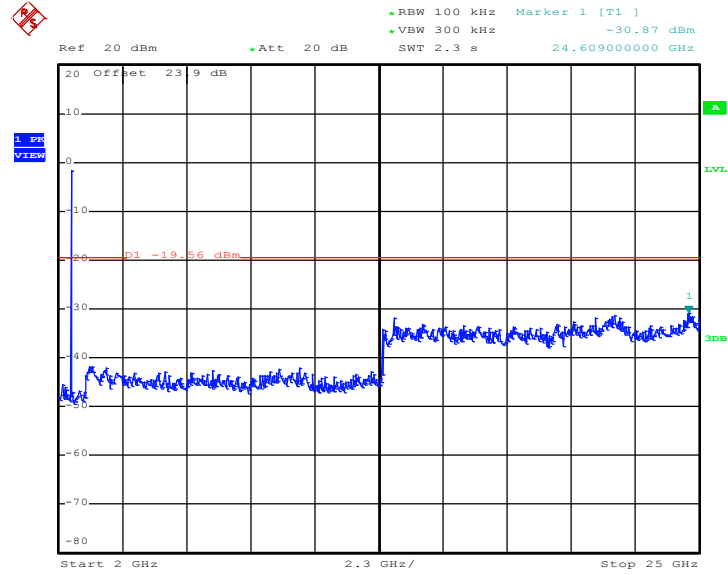

Date: 9.FEB.2016 11:38:15



3.5 Radiated Band Edges and Spurious Emission Measurement

3.5.1 Limit of Radiated Band Edges and Spurious Emission

In any 100 kHz bandwidth outside the intentional radiator frequency band, all harmonics/spurious must be at least 20 dB below the highest emission level within the authorized band. If the output power of this device was measured by spectrum analyzer, the attenuation under this paragraph shall be 30 dB instead of 20 dB. In addition, radiated emissions which fall in the restricted bands must also comply with the FCC section 15.209 limits as below.

Frequency (MHz)	Field Strength (microvolts/meter)	Measurement Distance (meters)
0.009 – 0.490	2400/F(kHz)	300
0.490 – 1.705	24000/F(kHz)	30
1.705 – 30.0	30	30
30 – 88	100	3
88 – 216	150	3
216 - 960	200	3
Above 960	500	3

3.5.2 Measuring Instruments

The section 4.0 of List of Measuring Equipment of this test report is used for test.



3.5.3 Test Procedures

1. The testing follows ANSI C63.10-2013.
2. The EUT was arranged to its worst case and then tune the antenna tower (from 1 m to 4 m) and turntable (from 0 degree to 360 degrees) to find the maximum reading. A pre-amp and a high pass filter are used for the test in order to get better signal level.
3. The EUT was placed on a turntable with 0.8 meter for frequency below 1GHz and 1.5 meter for frequency above 1GHz respectively above ground.
4. The EUT was set 3 meters from the interference receiving antenna, which was mounted on the top of a variable height antenna tower.
5. Corrected Reading: Antenna Factor + Cable Loss + Read Level - Preamp Factor = Level
6. For measurement below 1GHz, If the emission level of the EUT measured by the peak detector is 3 dB lower than the applicable limit, the peak emission level will be reported. Otherwise, the emission measurement will be repeated using the quasi-peak detector and reported.
7. Use the following spectrum analyzer settings:
 - (1) Span shall wide enough to fully capture the emission being measured;
 - (2) Set RBW=100 kHz for $f < 1 \text{ GHz}$; $VBW \geq RBW$; Sweep = auto; Detector function = peak; Trace = max hold;
 - (3) Set RBW = 1 MHz, VBW= 3MHz for $f \geq 1 \text{ GHz}$ for peak measurement.

For average measurement:

 - $VBW = 10 \text{ Hz}$, when duty cycle is no less than 98 percent.
 - $VBW \geq 1/T$, when duty cycle is less than 98 percent where T is the minimum transmission duration over which the transmitter is on and is transmitting at its maximum power control level for the tested mode of operation.

Band	Duty Cycle(%)	T(μs)	1/T(kHz)	VBW Setting
Bluetooth 4.0 - LE	62.18	388	2.577319588	3kHz

3.5.4 Test Setup

For radiated emissions below 30MHz

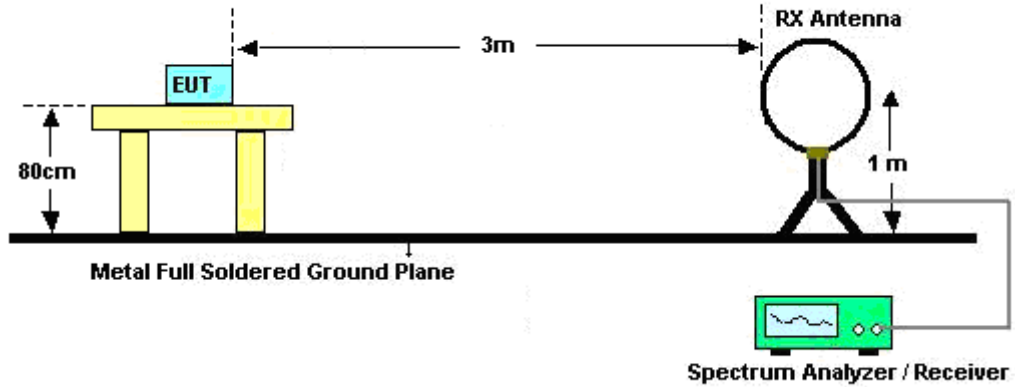

For radiated emissions from 30MHz to 1GHz

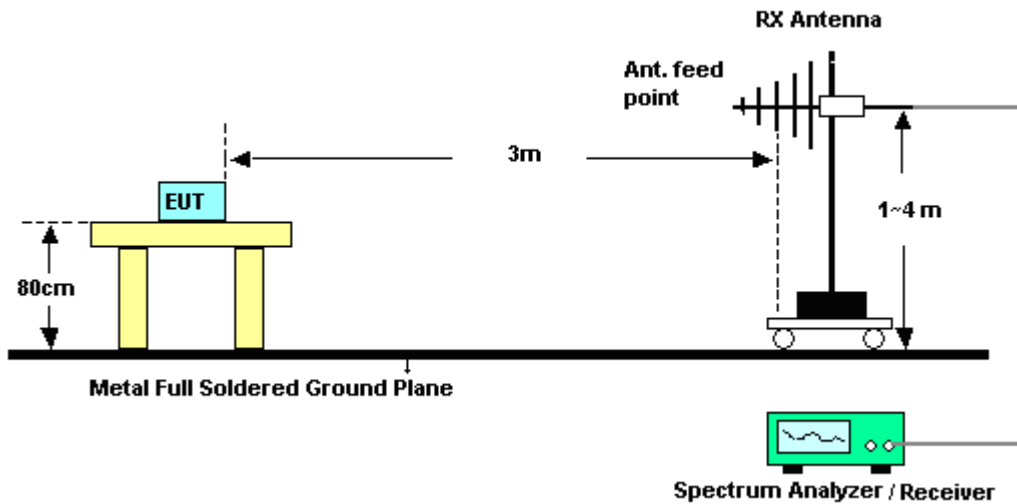

For radiated emissions above 1GHz

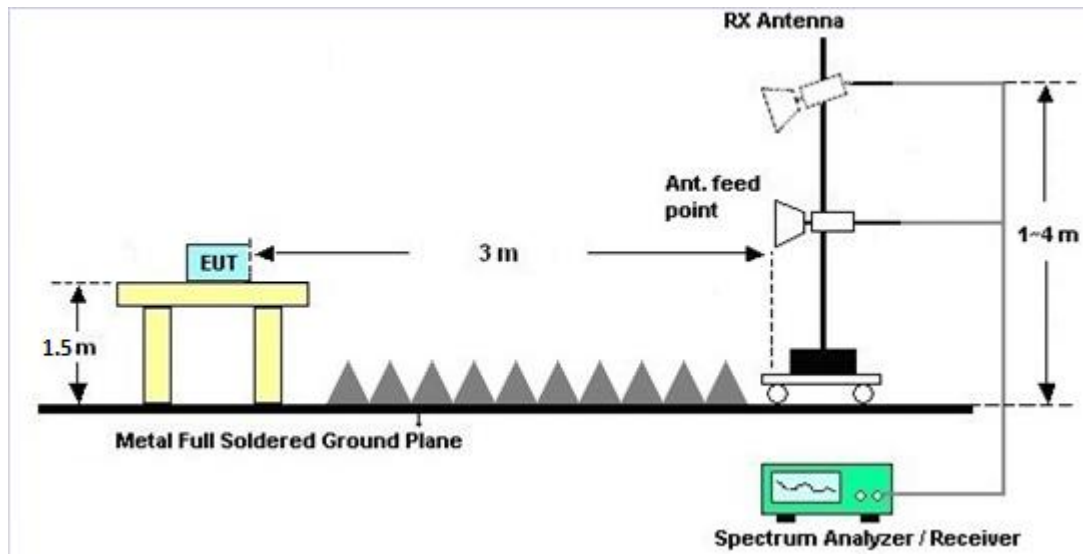

3.5.5 Test Results of Radiated Spurious Emissions (9 kHz ~ 30 MHz)

The low frequency, which started from 9 kHz to 30MHz, was pre-scanned and the result which was 20dB lower than the limit line per 15.31(o) was not reported.

3.5.6 Test Result of Radiated Spurious at Band Edges

Please refer to Appendix B and C.

3.5.7 Test Result of Radiated Spurious Emission (30MHz ~ 10th Harmonic)

Please refer to Appendix B and C.



3.6 AC Conducted Emission Measurement

3.6.1 Limit of AC Conducted Emission

For equipment that is designed to be connected to the public utility (AC) power line, the radio frequency voltage that is conducted back onto the AC power line on any frequency or frequencies within the band 150 kHz to 30 MHz shall not exceed the limits in the following table.

Frequency of emission (MHz)	Conducted limit (dB μ V)	
	Quasi-peak	Average
0.15-0.5	66 to 56*	56 to 46*
0.5-5	56	46
5-30	60	50

*Decreases with the logarithm of the frequency.

3.6.2 Measuring Instruments

The section 4.0 of List of Measuring Equipment of this test report is used for test.

3.6.3 Test Procedures

1. The EUT was placed 0.4 meter from the conducting wall of the shielding room was kept at least 80 centimeters from any other grounded conducting surface.
2. Connect EUT to the power mains through a line impedance stabilization network (LISN).
3. All the support units are connecting to the other LISN.
4. The LISN provides 50 ohm coupling impedance for the measuring instrument.
5. The FCC states that a 50 ohm, 50 microhenry LISN should be used.
6. Both sides of AC line were checked for maximum conducted interference.
7. The frequency range from 150 kHz to 30 MHz was searched.
8. Set the test-receiver system to Peak Detect Function and specified bandwidth (IF Bandwidth = 9kHz) with Maximum Hold Mode. Then measurement is also conducted by Average Detector and Quasi-Peak Detector Function respectively.

3.6.4 Test Setup

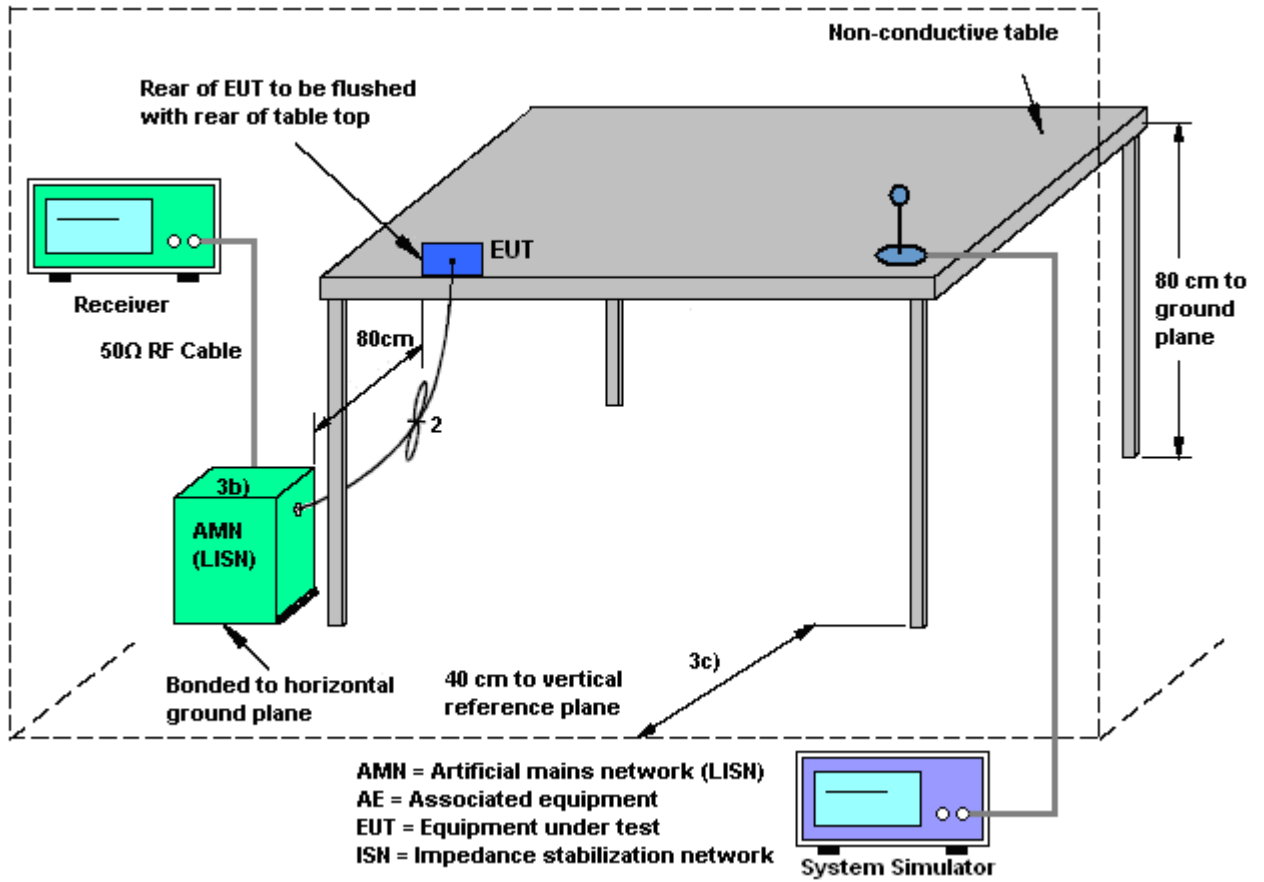



3.6.5 Test Result of AC Conducted Emission

Test Mode :	Mode 1	Temperature :	23~24°C
Test Engineer :	Kai-Chun Chu	Relative Humidity :	48~49%
Test Voltage :	120Vac / 60Hz	Phase :	Line
Function Type :	GSM850 Idle + Bluetooth Link + WLAN (2.4GHz) Link + Earphone + MP3 + USB Cable (Charging from Adapter)		

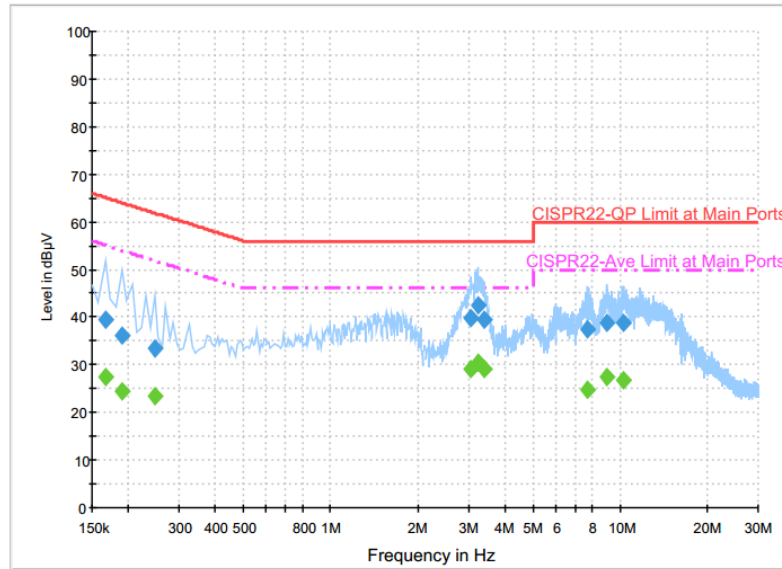

Final Result : Quasi-Peak

Frequency (MHz)	Quasi-Peak (dBµV)	Filter	Line	Corr. (dB)	Margin (dB)	Limit (dBµV)
0.166000	39.6	Off	L1	19.6	25.6	65.2
0.190000	36.2	Off	L1	19.6	27.8	64.0
0.246000	33.4	Off	L1	19.6	28.5	61.9
3.062000	39.9	Off	L1	19.6	16.1	56.0
3.222000	42.6	Off	L1	19.6	13.4	56.0
3.398000	39.3	Off	L1	19.6	16.7	56.0
7.710000	37.4	Off	L1	19.7	22.6	60.0
8.966000	38.7	Off	L1	19.7	21.3	60.0
10.302000	38.7	Off	L1	19.7	21.3	60.0

Final Result : Average

Frequency (MHz)	Average (dBµV)	Filter	Line	Corr. (dB)	Margin (dB)	Limit (dBµV)
0.166000	27.3	Off	L1	19.6	27.9	55.2
0.190000	24.4	Off	L1	19.6	29.6	54.0
0.246000	23.3	Off	L1	19.6	28.6	51.9
3.062000	29.0	Off	L1	19.6	17.0	46.0
3.222000	30.3	Off	L1	19.6	15.7	46.0
3.398000	29.2	Off	L1	19.6	16.8	46.0
7.710000	24.8	Off	L1	19.7	25.2	50.0
8.966000	27.3	Off	L1	19.7	22.7	50.0
10.302000	26.9	Off	L1	19.7	23.1	50.0



Test Mode :	Mode 1	Temperature :	23~24°C
Test Engineer :	Kai-Chun Chu	Relative Humidity :	48~49%
Test Voltage :	120Vac / 60Hz	Phase :	Neutral
Function Type :	GSM850 Idle + Bluetooth Link + WLAN (2.4GHz) Link + Earphone + MP3 + USB Cable (Charging from Adapter)		

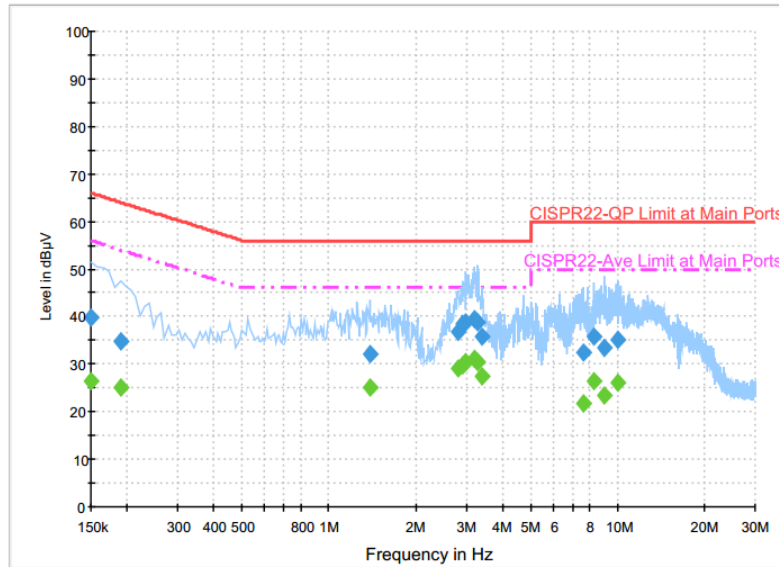

Final Result : Quasi-Peak

Frequency (MHz)	Quasi-Peak (dBµV)	Filter	Line	Corr. (dB)	Margin (dB)	Limit (dBµV)
0.150000	39.9	Off	N	19.6	26.1	66.0
0.190000	34.9	Off	N	19.6	29.1	64.0
1.390000	32.2	Off	N	19.6	23.8	56.0
2.798000	36.9	Off	N	19.5	19.1	56.0
2.910000	38.4	Off	N	19.5	17.6	56.0
2.982000	38.8	Off	N	19.5	17.2	56.0
3.190000	39.4	Off	N	19.6	16.6	56.0
3.278000	38.8	Off	N	19.6	17.2	56.0
3.398000	35.6	Off	N	19.6	20.4	56.0
7.614000	32.6	Off	N	19.7	27.4	60.0
8.318000	35.6	Off	N	19.7	24.4	60.0
9.038000	33.3	Off	N	19.8	26.7	60.0
10.086000	35.1	Off	N	19.8	24.9	60.0



Test Mode :	Mode 1	Temperature :	23~24°C
Test Engineer :	Kai-Chun Chu	Relative Humidity :	48~49%
Test Voltage :	120Vac / 60Hz	Phase :	Neutral
Function Type :	GSM850 Idle + Bluetooth Link + WLAN (2.4GHz) Link + Earphone + MP3 + USB Cable (Charging from Adapter)		

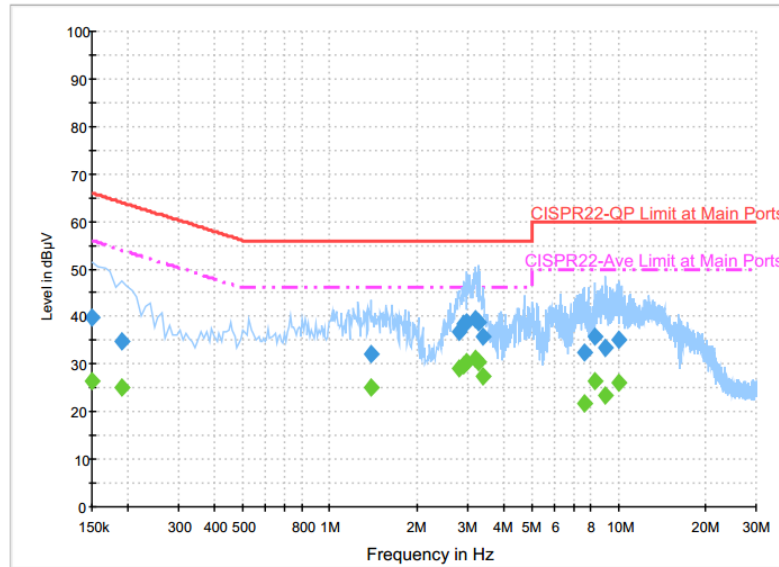

Final Result : Average

Frequency (MHz)	Average (dBµV)	Filter	Line	Corr. (dB)	Margin (dB)	Limit (dBµV)
0.150000	26.4	Off	N	19.6	29.6	56.0
0.190000	24.9	Off	N	19.6	29.1	54.0
1.390000	25.1	Off	N	19.6	20.9	46.0
2.798000	28.9	Off	N	19.5	17.1	46.0
2.910000	29.9	Off	N	19.5	16.1	46.0
2.982000	30.5	Off	N	19.5	15.5	46.0
3.190000	31.0	Off	N	19.6	15.0	46.0
3.278000	30.3	Off	N	19.6	15.7	46.0
3.398000	27.3	Off	N	19.6	18.7	46.0
7.614000	21.7	Off	N	19.7	28.3	50.0
8.318000	26.4	Off	N	19.7	23.6	50.0
9.038000	23.3	Off	N	19.8	26.7	50.0
10.086000	26.2	Off	N	19.8	23.8	50.0



3.7 Antenna Requirements

3.7.1 Standard Applicable

If directional gain of transmitting antennas is greater than 6dBi, the power shall be reduced by the same level in dB comparing to gain minus 6dBi. The use of a permanently attached antenna or of an antenna that uses a unique coupling to the intentional radiator shall be considered sufficient to comply with the FCC rule.

3.7.2 Antenna Anti-Replacement Construction

An embedded-in antenna design is used.

3.7.3 Antenna Gain

The antenna peak gain of EUT is less than 6 dBi. Therefore, it is not necessary to reduce maximum peak output power limit.



4 List of Measuring Equipment

Instrument	Manufacturer	Model No.	Serial No.	Characteristics	Calibration Date	Test Date	Due Date	Remark
Power Meter	Agilent	E4416A	GB41292344	300MHz~40GHz	Jan. 08, 2016	Feb. 09, 2016	Jan. 07, 2017	Conducted (TH02-HY)
Power Sensor	Agilent	E9327A	US40441548	300MHz~40GHz	Jan. 07, 2016	Feb. 09, 2016	Jan. 06, 2017	Conducted (TH02-HY)
Spectrum Analyzer	Rohde & Schwarz	FSP40	100055	9kHz~40GHz	Jun. 18, 2015	Feb. 09, 2016	Jun. 17, 2016	Conducted (TH02-HY)
Bilog Antenna	TESEQ	CBL 6111D	35419	30MHz to 1GHz	Jan. 13, 2016	Feb. 22, 2016 ~ Mar. 02, 2016	Jan. 12, 2017	Radiation (03CH07-HY)
Double Ridge Horn Antenna	ESCO	3117	00075962	1GHz ~ 18GHz	Aug. 21, 2015	Feb. 22, 2016 ~ Mar. 02, 2016	Aug. 20, 2016	Radiation (03CH07-HY)
Loop Antenna	Rohde & Schwarz	HFH2-Z2	100315	9 kHz~30 MHz	Sep. 02, 2015	Feb. 22, 2016 ~ Mar. 02, 2016	Sep. 01, 2016	Radiation (03CH07-HY)
Preamplifier	MITEQ	AMF-7D-0010 1800-30-10P	1590075	1GHz ~ 18GHz	Apr. 20, 2015	Feb. 22, 2016 ~ Mar. 02, 2016	Apr. 19, 2016	Radiation (03CH07-HY)
Preamplifier	COM-POWER	PA-103A	161241	10MHz-1000MHz	Mar. 12, 2015	Feb. 22, 2016 ~ Mar. 02, 2016	Mar. 11, 2016	Radiation (03CH07-HY)
Preamplifier	Agilent	8449B	3008A02362	1GHz~ 26.5GHz	Oct. 19, 2015	Feb. 22, 2016 ~ Mar. 02, 2016	Oct. 18, 2016	Radiation (03CH07-HY)
EMI Test Receiver	Agilent	N9038A(MXE)	MY53290053	20Hz ~ 26.5GHz	Jan. 20, 2016	Feb. 22, 2016 ~ Mar. 02, 2016	Jan. 19, 2017	Radiation (03CH07-HY)
Spectrum Analyzer	Agilent	N9010A	MY53470118	10Hz~44GHz	Feb. 27, 2016	Feb. 28, 2016 ~ Mar. 02, 2016	Feb. 26, 2017	Radiation (03CH07-HY)
Spectrum Analyzer	Agilent	N9010A	MY53470118	10Hz~44GHz	Mar. 03, 2015	Feb. 22, 2016 ~ Feb. 26, 2016	Mar. 02, 2016	Radiation (03CH07-HY)
Antenna Mast	Max-Full	MFA520BS	N/A	1m~4m	N/A	Feb. 22, 2016 ~ Mar. 02, 2016	N/A	Radiation (03CH07-HY)
Turn Table	ChainTek	Chaintek 3000	N/A	0~360 degree	N/A	Feb. 22, 2016 ~ Mar. 02, 2016	N/A	Radiation (03CH07-HY)
SHF-EHF Horn Antenna	SCHWARZBECK	BBHA 9170	BBHA9170251	18GHz- 40GHz	Oct. 12, 2015	Feb. 22, 2016 ~ Mar. 02, 2016	Oct. 11, 2016	Radiation (03CH07-HY)
Preamplifier	MITEQ	JS44-180040 00-33-8P	1840917	18GHz ~ 40GHz	Jun. 02, 2015	Feb. 22, 2016 ~ Mar. 02, 2016	Jun. 01, 2016	Radiation (03CH07-HY)
AC Power Source	ChainTek	APC-1000W	N/A	N/A	N/A	Feb. 12, 2016	N/A	Conduction (CO05-HY)
EMI Test Receiver	Rohde & Schwarz	ESCI 7	100724	9kHz~7GHz	Aug. 26, 2015	Feb. 12, 2016	Aug. 25, 2016	Conduction (CO05-HY)
LISN	Rohde & Schwarz	ENV216	100080	9kHz~30MHz	Dec. 02, 2015	Feb. 12, 2016	Dec. 01, 2016	Conduction (CO05-HY)



5 Uncertainty of Evaluation

Uncertainty of Conducted Emission Measurement (150 kHz ~ 30 MHz)

Measuring Uncertainty for a Level of Confidence of 95% ($U = 2Uc(y)$)	2.26
---	------

Uncertainty of Radiated Emission Measurement (30 MHz ~ 1000 MHz)

Measuring Uncertainty for a Level of Confidence of 95% ($U = 2Uc(y)$)	4.80
---	------



Appendix A. Conducted Test Results

Bluetooth Low Energy

Test Engineer:	Osolemio Chang	Temperature:	21~25	°C
Test Date:	Feb. 09, 2016	Relative Humidity:	51~54	%

TEST RESULTS DATA
6dB and 99% Occupied Bandwidth

Mod.	Data Rate	N _{TX}	CH.	Freq. (MHz)	99% Occupied BW (MHz)	6dB BW (MHz)	6dB BW Limit (MHz)	Pass/Fail
BLE	1Mbps	1	0	2402	1.06	0.67	0.50	Pass
BLE	1Mbps	1	19	2440	1.06	0.67	0.50	Pass
BLE	1Mbps	1	39	2480	1.06	0.67	0.50	Pass

TEST RESULTS DATA
Peak Power Table

Mod.	Data Rate	N _{TX}	CH.	Freq. (MHz)	Peak Conducted Power (dBm)	Conducted Power Limit (dBm)	DG (dBi)	EIRP Power (dBm)	EIRP Power Limit (dBm)	Pass /Fail
BLE	1Mbps	1	0	2402	2.80	30.00	2.50	5.30	36.00	Pass
BLE	1Mbps	1	19	2440	3.62	30.00	2.50	6.12	36.00	Pass
BLE	1Mbps	1	39	2480	2.29	30.00	2.50	4.79	36.00	Pass

TEST RESULTS DATA
Average Power Table
(Reporting Only)

Mod.	Data Rate	N _{TX}	CH.	Freq. (MHz)	Duty Factor (dB)	Average Conducted Power (dBm)
BLE	1Mbps	1	0	2402	2.06	1.58
BLE	1Mbps	1	19	2440	2.06	2.57
BLE	1Mbps	1	39	2480	2.06	0.80

TEST RESULTS DATA
Peak Power Density

Mod.	Data Rate	N _{TX}	CH.	Freq. (MHz)	Peak PSD (dBm /100kHz)	Peak PSD (dBm /3kHz)	DG (dBi)	Peak PSD Limit (dBm /3kHz)	Pass/Fail
BLE	1Mbps	1	0	2402	1.27	-13.82	2.50	8.00	Pass
BLE	1Mbps	1	19	2440	2.38	-12.68	2.50	8.00	Pass
BLE	1Mbps	1	39	2480	0.44	-14.67	2.50	8.00	Pass

Note: PSD (dBm/ 100kHz) is a reference level used for Conducted Band Edges and Conducted Spurious Emission 20dBc limit.



Appendix B. Radiated Spurious Emission

Test Engineer :	James Chiu, Jesse Wang, and Ken Wu	Temperature :	21~24°C
		Relative Humidity :	50~54%

2.4GHz 2400~2483.5MHz

BLE (Band Edge @ 3m)

BLE	Note	Frequency	Level	Over	Limit	Read	Antenna	Cable	Preamp	Ant	Table	Peak	Pol.	
		(MHz)	(dBμV/m)	(dB)	Limit Line	(dBμV)	(dB/m)	(dB)	(dB)	(cm)	(deg)	Avg.	(H/V)	
BLE CH 00 2402MHz		2381.1	55.67	-18.33	74	50.56	32.16	7.31	34.36	130	289	P	H	
		2375.34	45.6	-8.4	54	40.56	32.16	7.24	34.36	130	289	A	H	
	*	2402	95.81	-	-	90.64	32.18	7.31	34.32	130	289	P	H	
	*	2402	95.15	-	-	89.98	32.18	7.31	34.32	130	289	A	H	
													H	
														H
			2363.28	54.96	-19.04	74	49.99	32.13	7.24	34.4	299	311	P	V
			2345.73	45.51	-8.49	54	40.56	32.11	7.24	34.4	299	311	A	V
	*		2402	92.72	-	-	87.55	32.18	7.31	34.32	299	311	P	V
	*		2402	92.07	-	-	86.9	32.18	7.31	34.32	299	311	A	V
														V
														V
BLE CH 19 2440MHz		2382.36	56.18	-17.82	74	51.07	32.16	7.31	34.36	300	64	P	H	
		2386.32	45.75	-8.25	54	40.62	32.18	7.31	34.36	300	64	A	H	
	*	2440	98.02	-	-	92.69	32.24	7.36	34.27	300	64	P	H	
	*	2440	97.19	-	-	91.86	32.24	7.36	34.27	300	64	A	H	
		2495.16	55.63	-18.37	74	50.08	32.3	7.4	34.15	300	64	P	H	
		2491.76	46.06	-7.94	54	40.51	32.3	7.4	34.15	300	64	A	H	
		2313.33	55.5	-18.5	74	50.69	32.07	7.18	34.44	112	0	P	V	
		2382.72	45.51	-8.49	54	40.4	32.16	7.31	34.36	112	0	A	V	
	*	2440	93.28	-	-	87.95	32.24	7.36	34.27	112	0	P	V	
	*	2440	91.89	-	-	86.56	32.24	7.36	34.27	112	0	A	V	
		2498.48	55.13	-18.87	74	49.58	32.3	7.4	34.15	112	0	P	V	
		2491.48	45.83	-8.17	54	40.32	32.3	7.4	34.19	112	0	A	V	



BLE CH 39 2480MHz	*	2480	97.68	-	-	92.19	32.28	7.4	34.19	300	89	P	H
	*	2480	97.08	-	-	91.59	32.28	7.4	34.19	300	89	A	H
		2487.68	55.09	-18.91	74	49.58	32.3	7.4	34.19	300	89	P	H
		2486.24	46.37	-7.63	54	40.88	32.28	7.4	34.19	300	89	A	H
													H
													H
	*	2480	95.78	-	-	90.29	32.28	7.4	34.19	380	137	P	V
	*	2480	95.12	-	-	89.63	32.28	7.4	34.19	380	137	A	V
		2494.84	55.6	-18.4	74	50.05	32.3	7.4	34.15	380	137	P	V
		2488	46.04	-7.96	54	40.53	32.3	7.4	34.19	380	137	A	V
													V
													V
Remark	1. No other spurious found. 2. All results are PASS against Peak and Average limit line.												



2.4GHz 2400~2483.5MHz

BLE (Harmonic @ 3m)

BLE	Note	Frequency (MHz)	Level (dBµV/m)	Over Limit (dB)	Limit Line (dBµV/m)	Read Level (dBµV)	Antenna Factor (dB/m)	Cable Loss (dB)	Preamp Factor (dB)	Ant Pos (cm)	Table Pos (deg)	Peak Avg. (P/A)	Pol. (H/V)	
BLE CH 00 2402MHz		4806	40.01	-33.99	74	53.6	34.25	11.83	59.67	100	0	P	H	
													H	
													H	
													H	
			4806	40.56	-33.44	74	54.15	34.25	11.83	59.67	100	0	P	V
														V
														V
BLE CH 19 2440MHz		4878	39.91	-34.09	74	53.65	34.3	11.53	59.57	100	0	P	H	
		7320	40.58	-33.42	74	49.66	35.6	13.81	58.49	100	0	P	H	
													H	
													H	
			4878	39.64	-34.36	74	53.38	34.3	11.53	59.57	100	0	P	V
			7320	40.93	-33.07	74	50.01	35.6	13.81	58.49	100	0	P	V
														V
BLE CH 39 2480MHz		4962	39.29	-34.71	74	53.15	34.37	11.22	59.45	100	0	P	H	
		7440	41.21	-32.79	74	50.2	35.6	14.05	58.64	100	0	P	H	
													H	
													H	
			4962	39.58	-34.42	74	53.44	34.37	11.22	59.45	100	0	P	V
			7440	41.18	-32.82	74	50.17	35.6	14.05	58.64	100	0	P	V
														V
Remark	1. No other spurious found.													
	2. All results are PASS against Peak and Average limit line.													



Emission below 1GHz

2.4GHz BLE (LF)

BLE	Note	Frequency	Level	Over	Limit	Read	Antenna	Cable	Preamp	Ant	Table	Peak	Pol.	
		(MHz)	(dBμV/m)	(dB)	(dBμV/m)	(dBμV)	(dB/m)	(dB)	(dB)	(cm)	(deg)	(P/A)	(H/V)	
2.4GHz BLE LF		30	28.88	-11.12	40	33.31	26	1.07	31.5			P	H	
		99.66	34.86	-8.64	43.5	48.28	16.4	1.28	31.1			P	H	
		160.14	35.22	-8.28	43.5	47.63	17	1.78	31.19	100	0	P	H	
		462.4	25.75	-20.25	46	30.13	23.38	3.04	30.8			P	H	
		708.8	31.14	-14.86	46	31.26	26.54	3.74	30.4			P	H	
		976.2	33.63	-20.37	54	29.6	30.25	4.07	30.29			P	H	
														H
														H
														H
														H
														H
														H
			49.98	31.49	-8.51	40	46.52	15.1	1.07	31.2	100	0	P	V
			98.85	30.72	-12.78	43.5	44.27	16.27	1.28	31.1			P	V
			194.16	29.94	-13.56	43.5	43.47	15.7	1.87	31.1			P	V
			454.7	25.45	-20.55	46	30.12	23.21	2.89	30.77			P	V
			723.5	30.17	-15.83	46	30.05	26.78	3.74	30.4			P	V
			962.2	33.67	-20.33	54	29.72	30.23	4.07	30.35			P	V
														V
														V
													V	
													V	
													V	
													V	
Remark	1. No other spurious found. 2. All results are PASS against limit line.													



Note symbol

*	Fundamental Frequency which can be ignored. However, the level of any unwanted emissions shall not exceed the level of the fundamental frequency.
!	Test result is over limit line.
P/A	Peak or Average
H/V	Horizontal or Vertical



A calculation example for radiated spurious emission is shown as below:

WIFI	Note	Frequency	Level	Over	Limit	Read	Antenna	Cable	Preamp	Ant	Table	Peak	Pol.
Ant.				Limit	Line	Level	Factor	Loss	Factor	Pos	Pos	Avg.	
1+2		(MHz)	(dBμV/m)	(dB)	(dBμV/m)	(dBμV)	(dB/m)	(dB)	(dB)	(cm)	(deg)	(P/A)	(H/V)
802.11b		2390	55.45	-18.55	74	54.51	32.22	4.58	35.86	103	308	P	H
CH 01													
2412MHz		2390	43.54	-10.46	54	42.6	32.22	4.58	35.86	103	308	A	H

- Level(dBμV/m) =
Antenna Factor(dB/m) + Cable Loss(dB) + Read Level(dBμV) - Preamp Factor(dB)
- Over Limit(dB) = Level(dBμV/m) – Limit Line(dBμV/m)

For Peak Limit @ 2390MHz:

- Level(dBμV/m)
= Antenna Factor(dB/m) + Cable Loss(dB) + Read Level(dBμV) - Preamp Factor(dB)
= 32.22(dB/m) + 4.58(dB) + 54.51(dBμV) – 35.86 (dB)
= 55.45 (dBμV/m)
- Over Limit(dB)
= Level(dBμV/m) – Limit Line(dBμV/m)
= 55.45(dBμV/m) – 74(dBμV/m)
= -18.55(dB)

For Average Limit @ 2390MHz:

- Level(dBμV/m)
= Antenna Factor(dB/m) + Cable Loss(dB) + Read Level(dBμV) - Preamp Factor(dB)
= 32.22(dB/m) + 4.58(dB) + 42.6(dBμV) – 35.86 (dB)
= 43.54 (dBμV/m)
- Over Limit(dB)
= Level(dBμV/m) – Limit Line(dBμV/m)
= 43.54(dBμV/m) – 54(dBμV/m)
= -10.46(dB)

Both peak and average measured complies with the limit line, so test result is “PASS”.



Appendix C. Radiated Spurious Emission

Test Engineer :	James Chiu, Jesse Wang, and Ken Wu	Temperature :	21~24°C
		Relative Humidity :	50~54%

2.4GHz 2400~2483.5MHz

BLE (Band Edge @ 3m)

BLE	2.4GHz 2400~2483.5MHz Band Edge @ 3m	
ANT	BLE CH00 2402MHz	
1	Horizontal	Vertical
Peak	<p>Site : 03CH07HY Condition : FCC CLASS-B 3m HF-ANT, 130209 HORIZONTAL RBW:1000.000kHz VBW:3000.000kHz SVT:Auto Detector : Peak</p>	<p>Site : 03CH07HY Condition : FCC CLASS-B 3m HF-ANT, 130209 VERTICAL RBW:1000.000kHz VBW:3000.000kHz SVT:Auto Detector : Peak</p>



<p>Avg.</p>	<p>Site : 03CH07-HY Condition : FCC CLASS-B (AVG) 3m HF-ANT. 138029 HORIZONTAL RBW: 1000.000kHz VBW:3.000kHz SVWT:Auto Detector : Peak</p>	<p>Site : 03CH07-HY Condition : FCC CLASS-B (AVG) 3m HF-ANT. 138029 VERTICAL RBW: 1000.000kHz VBW:3.000kHz SVWT:Auto Detector : Peak</p>
-------------	--	--



BLE	2.4GHz 2400~2483.5MHz Band Edge @ 3m	
ANT	BLE CH19 2440MHz - L	
1	Horizontal	Vertical
Peak	<p>Date: 2016-02-28</p> <p>Site : 03CH07-HY Condition : FCC CLASS-B 3m HF-ANT_130829 HORIZONTAL RBW: 1000.000kHz VBW: 3000.000kHz SWT: Auto Detector : Peak</p>	<p>Date: 2016-02-28</p> <p>Site : 03CH07-HY Condition : FCC CLASS-B 3m HF-ANT_130829 VERTICAL RBW: 1000.000kHz VBW: 3000.000kHz SWT: Auto Detector : Peak</p>
Avg.	<p>Date: 2016-02-28</p> <p>Site : 03CH07-HY Condition : FCC CLASS-B (AVG) 3m HF-ANT_130829 HORIZONTAL RBW: 1000.000kHz VBW: 3.000kHz SWT: Auto Detector : Peak</p>	<p>Date: 2016-02-28</p> <p>Site : 03CH07-HY Condition : FCC CLASS-B (AVG) 3m HF-ANT_130829 VERTICAL RBW: 1000.000kHz VBW: 3.000kHz SWT: Auto Detector : Peak</p>



BLE	2.4GHz 2400~2483.5MHz Band Edge @ 3m	
ANT	BLE CH19 2440MHz - R	
1	Horizontal	Vertical
Peak	<p>Site : 03CH07-HY Condition : FCC CLASS-B 3m HF-ANT_130829 HORIZONTAL RBW: 1000.000kHz VBW: 5000.000kHz SWT: Auto Detector : Peak</p>	<p>Site : 03CH07-HY Condition : FCC CLASS-B 3m HF-ANT_130829 VERTICAL RBW: 1000.000kHz VBW: 5000.000kHz SWT: Auto Detector : Peak</p>
Avg.	<p>Site : 03CH07-HY Condition : FCC CLASS-B (AVG) 3m HF-ANT_130829 HORIZONTAL RBW: 1000.000kHz VBW: 3.000kHz SWT: Auto Detector : Peak</p>	<p>Site : 03CH07-HY Condition : FCC CLASS-B (AVG) 3m HF-ANT_130829 VERTICAL RBW: 1000.000kHz VBW: 3.000kHz SWT: Auto Detector : Peak</p>



BLE	2.4GHz 2400~2483.5MHz Band Edge @ 3m	
ANT	BLE CH39 2480MHz	
1	Horizontal	Vertical
Peak	<p>Site : 03CH07-HY Condition : FCC CLASS-B 3m HF-ANT_130829 HORIZONTAL RBW: 1000.000kHz VBW: 3000.000kHz SWT: Auto Detector : Peak</p>	<p>Site : 03CH07-HY Condition : FCC CLASS-B 3m HF-ANT_130829 VERTICAL RBW: 1000.000kHz VBW: 3000.000kHz SWT: Auto Detector : Peak</p>
Avg.	<p>Site : 03CH07-HY Condition : FCC CLASS-B (AVG) 3m HF-ANT_130829 HORIZONTAL RBW: 1000.000kHz VBW: 3.000kHz SWT: Auto Detector : Peak</p>	<p>Site : 03CH07-HY Condition : FCC CLASS-B (AVG) 3m HF-ANT_130829 VERTICAL RBW: 1000.000kHz VBW: 3.000kHz SWT: Auto Detector : Peak</p>



2.4GHz 2400~2483.5MHz

BLE (Harmonic @ 3m)

BLE	2.4GHz 2400~2483.5MHz Harmonic @ 3m	
ANT	BLE CH00 2402MHz	
1	Horizontal	Vertical
<p>Peak Avg.</p>	<p>Site : 03CH07HY Condition : FCC CLASS-B 3m SHF-EHF_131029 HORIZONTAL Detector : Peak</p>	<p>Site : 03CH07HY Condition : FCC CLASS-B 3m SHF-EHF_131029 VERTICAL Detector : Peak</p>



BLE	2.4GHz 2400~2483.5MHz Harmonic @ 3m	
ANT	BLE CH19 2440MHz	
1	Horizontal	Vertical
<p>Peak</p> <p>Avg.</p>	<p>Site : 03CH074HY Condition : FCC CLASS-B 3m SHF-EHF_131029 HORIZONTAL Detector : Peak</p>	<p>Site : 03CH074HY Condition : FCC CLASS-B 3m SHF-EHF_131029 VERTICAL Detector : Peak</p>



BLE	2.4GHz 2400~2483.5MHz Band Edge @ 3m	
ANT	BLE CH39 2480MHz	
1	Horizontal	Vertical
<p>Peak</p>	<p>Site : 03CH074HY Condition : FCC CLASS-B 3m SHF-EHF_131029 HORIZONTAL Detector : Peak</p>	<p>Site : 03CH074HY Condition : FCC CLASS-B 3m SHF-EHF_131029 VERTICAL Detector : Peak</p>



Emission below 1GHz

2.4GHz BLE (LF)

BLE	2.4GHz 2400~2483.5MHz	
ANT	BLE LF	
1	Horizontal	Vertical
QP / Peak	<p>Horizontal Emission Spectrum (QP / Peak):</p> <ul style="list-style-type: none"> Site : 63CH074HY Condition : FCC CLASS-B 3m LF-ANT-35419(6) HORIZONTAL Detector : Peak 	<p>Vertical Emission Spectrum (QP / Peak):</p> <ul style="list-style-type: none"> Site : 63CH074HY Condition : FCC CLASS-B 3m LF-ANT-35419(6) VERTICAL Detector : Peak