



FCC RF Test Report

APPLICANT : Motorola Mobility, LLC
EQUIPMENT : Mobile Cellular Phone
BRAND NAME : Motorola
MODEL NAME : 7048
FCC ID : IHDT56VA3
STANDARD : FCC Part 15 Subpart E §15.407
CLASSIFICATION : (NII) Unlicensed National Information Infrastructure

This is a variant report which is only valid together with the original test report. The product was received on Feb. 03, 2016. We, SPORTON INTERNATIONAL INC., would like to declare that the tested sample has been evaluated in accordance with the test procedures and has been in compliance with the applicable technical standards.

The test results in this report apply exclusively to the tested model / sample. Without written approval of SPORTON INTERNATIONAL INC., the test report shall not be reproduced except in full.

Reviewed by: Joseph Lin / Supervisor

Approved by: Jones Tsai / Manager



SPORTON INTERNATIONAL INC.

No. 52, Hwa Ya 1st Rd., Hwa Ya Technology Park, Kwei-Shan District, Tao Yuan City, Taiwan, R.O.C.

SPORTON INTERNATIONAL INC.

TEL : 886-3-327-3456

FAX : 886-3-328-4978

FCC ID : IHDT56VA3

Page Number : 1 of 5

Report Issued Date : May 06, 2016

Report Version : Rev. 02

Report Template No.: BU5-FR15EWL Version 1.3



TABLE OF CONTENTS

1 GENERAL DESCRIPTION 4

 1.1 Applicant 4

 1.2 Manufacturer 4

 1.3 Product Feature of Equipment Under Test 4

 1.4 Re-use of Measured Data 5

 1.5 Modification of EUT 5

APPENDIX A. ORIGINAL REPORT



1 General Description

1.1 Applicant

Motorola Mobility, LLC
222 W. Merchandise Mart Plaza, Chicago IL 60654 USA

1.2 Manufacturer

Motorola Mobility, LLC
222 W. Merchandise Mart Plaza, Chicago IL 60654 USA

1.3 Product Feature of Equipment Under Test

Product Feature	
Equipment	Mobile Cellular Phone
Brand Name	Motorola
Model Name	7048
FCC ID	IHDT56VA3
EUT supports Radios application	GSM/EGPRS/WCDMA/HSPA/LTE/FM WLAN 11b/g/n HT20/HT40 WLAN 11a/n HT20/HT40 Bluetooth v3.0 EDR Bluetooth v4.0 LE
HW Version	DVT2
EUT Stage	Identical Prototype

Remark: The above EUT's information was declared by manufacturer. Please refer to the specifications or user's manual for more detailed description.



1.4 Re-use of Measured Data

This application re-uses data collected on a similar device. The subject device of this application (Model 7048, FCC ID IHDT56VA3) is electrically identical to the reference device (Model 8028, FCC ID IHDT56VA2) for the portions of the circuitry corresponding to the data being re-used, as treated by KDB Publication 178919 D01.

For details concerning the similarity with respect to component placement, mechanical/electrical design etc., please refer to the Operational Description.

The re-used RF data includes the following bands provided in Appendix A (Sporton RF Report No. FR620325D for the reference device Model 8028, FCC ID IHDT56VA2):

-5GHz WLAN

In order to confirm hardware similarity of the subject device with the reference device, spot check measurements were performed on the subject device for the individual cases as the table below this paragraph.

Assertions concerning the similarity of these devices are based on representations by the applicant. The applicant accepts full responsibility for the validity of the similarity claim, and for the determination that verification test data are sufficient to support it.

Standard	Item	Channel
Part 15E	RSE	WLAN 802.11n (HT20) CH140

Result within one uncertainty of reference device

1.5 Modification of EUT

No modifications are made to the EUT during all test items.



Appendix A. Original Report

Please refer to Sporton report number FR620325D as below.



FCC RF Test Report

APPLICANT : Motorola Mobility, LLC
EQUIPMENT : Mobile Cellular Phone
BRAND NAME : Motorola
MODEL NAME : 8028
FCC ID : IHDT56VA2
STANDARD : FCC Part 15 Subpart E §15.407
CLASSIFICATION : (NII) Unlicensed National Information Infrastructure

The product was received on Feb. 03, 2016 and testing was completed on Mar. 05, 2016. We, SPORTON INTERNATIONAL INC., would like to declare that the tested sample has been evaluated in accordance with the test procedures and has been in compliance with the applicable technical standards.

The test results in this report apply exclusively to the tested model / sample. Without written approval of SPORTON INTERNATIONAL INC., the test report shall not be reproduced except in full.

Reviewed by: Joseph Lin / Supervisor

Approved by: Jones Tsai / Manager



SPORTON INTERNATIONAL INC.

No. 52, Hwa Ya 1st Rd., Hwa Ya Technology Park, Kwei-Shan District, Tao Yuan City, Taiwan, R.O.C.

SPORTON INTERNATIONAL INC.

TEL : 886-3-327-3456

FAX : 886-3-328-4978

FCC ID : IHDT56VA2

Page Number : 1 of 36

Report Issued Date : Apr. 28, 2016

Report Version : Rev. 02

Report Template No.: BU5-FR15EWL Version 1.3



TABLE OF CONTENTS

SUMMARY OF TEST RESULT 4

1 GENERAL DESCRIPTION 5

 1.1 Applicant 5

 1.2 Manufacturer 5

 1.3 Product Feature of Equipment Under Test 5

 1.4 Product Specification of Equipment Under Test 6

 1.5 Modification of EUT 6

 1.6 Testing Location 7

 1.7 Applicable Standards 7

2 TEST CONFIGURATION OF EQUIPMENT UNDER TEST 8

 2.1 Carrier Frequency Channel 9

 2.2 Pre-Scanned RF Power 10

 2.3 Test Mode 11

 2.4 Connection Diagram of Test System 13

 2.5 Support Unit used in test configuration and system 14

 2.6 EUT Operation Test Setup 14

 2.7 Measurement Results Explanation Example 14

3 TEST RESULT 15

 3.1 26dB & 99% Occupied Bandwidth Measurement 15

 3.2 Maximum Conducted Output Power Measurement 17

 3.3 Power Spectral Density Measurement 19

 3.4 Unwanted Radiated Emission Measurement 22

 3.5 AC Conducted Emission Measurement 27

 3.6 Frequency Stability Measurement 32

 3.7 Automatically Discontinue Transmission 33

 3.8 Antenna Requirements 34

4 LIST OF MEASURING EQUIPMENTS 35

5 UNCERTAINTY OF EVALUATION 36

APPENDIX A. CONDUCTED TEST RESULTS

APPENDIX B. RADIATED TEST RESULTS

APPENDIX C RADIATED SPURIOUS EMISSION PLOTS



SUMMARY OF TEST RESULT

Report Section	FCC Rule	Description	Limit	Result	Remark
3.1	2.1049 15.403(i)	26dB & 99% Bandwidth	-	Pass	-
3.2	15.407(a)	Maximum Conducted Output Power	≤ 24 dBm (depend on band)	Pass	-
3.3	15.407(a)	Power Spectral Density	≤ 11 dBm (depend on band)	Pass	-
3.4	15.407(b)	Unwanted Emissions	≤ -17, -27 dBm (depend on band)&15.209(a)	Pass	Under limit 0.31 dB at 5725.160 MHz
3.5	15.207	AC Conducted Emission	15.207(a)	Pass	Under limit 15.60 dB at 3.110 MHz
3.6	15.407(g)	Frequency Stability	Within Operation Band	Pass	-
3.7	15.407(c)	Automatically Discontinue Transmission	Discontinue Transmission	Pass	-
3.8	15.203 & 15.407(a)	Antenna Requirement	N/A	Pass	-



1 General Description

1.1 Applicant

Motorola Mobility, LLC
222 W. Merchandise Mart Plaza, Chicago IL 60654 USA

1.2 Manufacturer

Motorola Mobility, LLC
222 W. Merchandise Mart Plaza, Chicago IL 60654 USA

1.3 Product Feature of Equipment Under Test

Product Feature	
Equipment	Mobile Cellular Phone
Brand Name	Motorola
Model Name	8028
FCC ID	IHDT56VA2
IMEI Code	354117070006154 (for Radiated Spurious Emission) 354117070005990 (for AC Conducted Emission)
EUT supports Radios application	GSM/EGPRS/WCDMA/HSPA/LTE/FM WLAN 11b/g/n HT20 WLAN 11a/n HT20/HT40 Bluetooth v3.0 EDR Bluetooth v4.0 LE
HW Version	DVT2
EUT Stage	Identical Prototype

Remark: The above EUT's information was declared by manufacturer. Please refer to the specifications or user's manual for more detailed description.

Accessory List	
AC Adapter	Brand Name : Motorola
	Model Name : SPN5866A
USB Cable	Brand Name : Motorola
	Model Name : SKN6462A
Earphone	Brand Name : Motorola
	Model Name : SJYN1181B



1.4 Product Specification of Equipment Under Test

Standards-related Product Specification	
Tx/Rx Frequency Range	5180 MHz ~ 5240 MHz 5260 MHz ~ 5320 MHz 5500 MHz ~ 5580 MHz 5660 MHz ~ 5700 MHz
Maximum Output Power to Antenna	<5180 MHz ~ 5240 MHz> 802.11a : 16.25 dBm / 0.0422 W 802.11n HT20 : 15.21 dBm / 0.0332 W 802.11n HT40 : 14.92 dBm / 0.0310 W <5260 MHz ~ 5320 MHz> 802.11a : 16.42 dBm / 0.0439 W 802.11n HT20 : 15.69 dBm / 0.0371 W 802.11n HT40 : 14.79 dBm / 0.0301 W <5500 MHz ~ 5580 MHz and 5660 MHz ~ 5700 MHz > 802.11a : 17.44 dBm / 0.0555 W 802.11n HT20 : 16.86 dBm / 0.0485 W 802.11n HT40 : 16.57 dBm / 0.0454 W
99% Occupied Bandwidth	802.11a : 36.80 MHz 802.11n HT20 : 37.00 MHz 802.11n HT40 : 38.20 MHz
Antenna Type	Fixed Internal Antenna type (The antenna peak gain of EUT is less than 6 dBi)
Type of Modulation	OFDM (BPSK / QPSK / 16QAM / 64QAM)

1.5 Modification of EUT

No modifications are made to the EUT during all test items.



1.6 Testing Location

Sporton Lab is accredited to ISO 17025 by Taiwan Accreditation Foundation (TAF code : 1190) and the FCC designation No. TW1022 under the FCC 2.948(e) by Mutual Recognition Agreement (MRA) in FCC Test.

Test Site	SPORTON INTERNATIONAL INC.		
Test Site Location	No. 52, Hwa Ya 1 st Rd., Hwa Ya Technology Park, Kwei-Shan District, Tao Yuan City, Taiwan, R.O.C. TEL: +886-3-327-3456 FAX: +886-3-328-4978		
Test Site No.	Sporton Site No.		
	TH02-HY	CO05-HY	03CH07-HY

Note: The test site complies with ANSI C63.4 2014 requirement.

1.7 Applicable Standards

According to the specifications of the manufacturer, the EUT must comply with the requirements of the following standards:

- ♦ FCC Part 15 Subpart E
- ♦ FCC KDB 789033 D02 General UNII Test Procedures New Rules v01r02
- ♦ ANSI C63.10-2013

Remark:

1. All test items were verified and recorded according to the standards and without any deviation during the test.
2. This EUT has also been tested and complied with the requirements of FCC Part 15, Subpart B, recorded in a separate test report.



2 Test Configuration of Equipment Under Test

The EUT has been associated with peripherals and configuration operated in a manner tended to maximize its emission characteristics in a typical application. Frequency range investigated: conducted emission (150 kHz to 30 MHz) and radiated emission (9 kHz to the 10th harmonic of the highest fundamental frequency or to 40 GHz, whichever is lower). For radiated measurement, pre-scanned in three orthogonal panels, X, Y, Z. The worst cases (Z plane) were recorded in this report.

The final configuration from all the combinations and the worst-case data rates were investigated by measuring the maximum power across all the data rates and modulation modes under section 2.2.

Based on the worst configuration found above, the RF power setting is set individually to meet FCC compliance limit for the final conducted and radiated tests shown in section 2.3.



2.1 Carrier Frequency Channel

Frequency Band	Channel	Freq. (MHz)	Channel	Freq. (MHz)
5150-5250 MHz Band 1 (U-NII-1)	36	5180	44	5220
	38	5190	46	5230
	40	5200	48	5240

Frequency Band	Channel	Freq. (MHz)	Channel	Freq. (MHz)
5250-5350 MHz Band 2 (U-NII-2A)	52	5260	60	5300
	54	5270	62	5310
	56	5280	64	5320

Frequency Band	Channel	Freq. (MHz)	Channel	Freq. (MHz)
5470-5600 MHz and 5650-5725 MHz Band 3 (U-NII-2C)	100	5500	116	5580
	102	5510	132	5660
	104	5520	134	5670
	108	5540	136	5680
	110	5550	140	5700
	112	5560		

Note: The above Frequency and Channel in boldface were 802.11n HT40.



2.2 Pre-Scanned RF Power

Preliminary tests were performed in different data rate and data rate associated with the highest power were chosen for full test in the following tables. Final Output Power equals to Measured Output Power adds the duty factor.

Channel	Frequency	5GHz 802.11a Average Power (dBm)							
		Data Rate							
		6 Mbps	9 Mbps	12 Mbps	18 Mbps	24 Mbps	36 Mbps	48 Mbps	54 Mbps
CH 36	5180 MHz	15.98	15.19	15.36	15.41	14.99	14.09	13.12	12.04
CH 44	5220 MHz	16.25	16.12	15.97	16.07	15.58	14.78	13.73	12.67
CH 48	5240 MHz	16.04	15.41	15.70	15.75	15.36	14.32	13.45	12.38
CH 52	5260 MHz	16.42	16.41	16.23	16.29	15.77	15.08	14.08	12.92
CH 60	5300 MHz	16.27	15.91	16.01	16.10	15.64	14.87	13.92	12.93
CH 64	5320 MHz	16.40	16.02	16.08	16.15	15.70	14.89	13.85	12.99
CH 100	5500 MHz	16.61	16.56	16.57	16.58	16.60	16.40	15.45	14.43
CH 116	5580 MHz	17.44	17.10	17.17	17.21	16.84	16.22	15.37	14.62
CH 140	5700 MHz	14.28	14.25	14.12	14.23	14.26	14.25	14.21	14.24

Channel	Frequency	5GHz 802.11n HT20 Average Power (dBm)							
		Data Rate							
		MCS0	MCS1	MCS2	MCS3	MCS4	MCS5	MCS6	MCS7
CH 36	5180 MHz	15.12	15.04	14.97	15.08	14.65	13.78	12.63	11.85
CH 44	5220 MHz	15.15	14.94	15.00	15.12	14.72	13.85	12.72	11.96
CH 48	5240 MHz	15.21	14.91	15.04	15.09	14.76	13.89	12.64	11.80
CH 52	5260 MHz	15.28	15.15	15.06	15.07	14.73	13.90	12.78	12.01
CH 60	5300 MHz	15.36	15.08	14.91	14.89	14.61	13.71	12.81	11.88
CH 64	5320 MHz	15.69	15.29	15.18	15.30	14.93	14.07	13.17	14.15
CH 100	5500 MHz	15.76	15.75	15.71	15.72	15.75	15.24	14.41	13.64
CH 116	5580 MHz	16.86	16.42	16.56	16.65	16.36	15.52	14.60	13.86
CH 140	5700 MHz	13.68	13.49	13.55	13.65	13.65	13.60	13.65	13.63



Channel	Frequency	5GHz 802.11n HT40 Average Power (dBm)							
		Data Rate							
		MCS0	MCS1	MCS2	MCS3	MCS4	MCS5	MCS6	MCS7
CH 38	5190MHz	10.46	10.43	10.42	10.42	10.43	10.45	10.44	10.45
CH 46	5230MHz	14.92	14.42	14.28	14.46	13.81	13.47	12.56	11.55
CH 54	5270MHz	14.79	14.39	14.42	14.50	13.94	13.62	12.64	11.70
CH 62	5310MHz	12.83	12.68	12.78	12.77	12.83	12.80	12.81	12.07
CH 102	5510MHz	12.90	12.80	12.86	12.73	12.69	12.85	12.88	12.82
CH 110	5550MHz	16.05	15.72	15.72	15.86	15.35	15.07	14.22	13.24
CH 134	5670MHz	16.57	16.13	16.11	16.21	15.74	15.47	14.67	13.79

2.3 Test Mode

Final test mode of conducted test items and radiated spurious emissions are considering the modulation and worse data rates from the power table described in section 2.2.

Modulation	Data Rate
802.11a	6 Mbps
802.11n HT20	MCS0
802.11n HT40	MCS0

AC Conducted Emission	Mode 1 : GSM850 Idle + Bluetooth Link + WLAN (5GHz) Link + Earphone + MP3 + USB Cable (Charging from Adapter)
------------------------------	---



Ch. #		Band I : 5150-5250 MHz	Band II : 5250-5350 MHz	Band III : 5470-5600 MHz and 5650-5725MHz
		802.11a	802.11a	802.11a
L	Low	36	52	100
M	Middle	44	60	116
H	High	48	64	140

Ch. #		Band I : 5150-5250 MHz	Band II : 5250-5350 MHz	Band III : 5470-5600 MHz and 5650-5725MHz
		802.11n HT20	802.11n HT20	802.11n HT20
L	Low	36	52	100
M	Middle	44	60	116
H	High	48	64	140

Ch. #		Band I : 5150-5250 MHz	Band II : 5250-5350 MHz	Band III : 5470-5600 MHz and 5650-5725MHz
		802.11n HT40	802.11n HT40	802.11n HT40
L	Low	38	54	102
M	Middle	-	-	110
H	High	46	62	134

2.4 Connection Diagram of Test System

<WLAN Tx Mode>

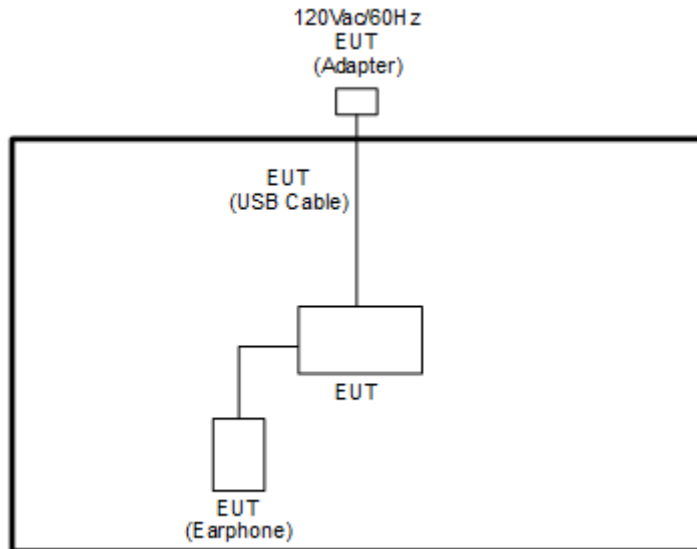

<AC Conducted Emission Mode>

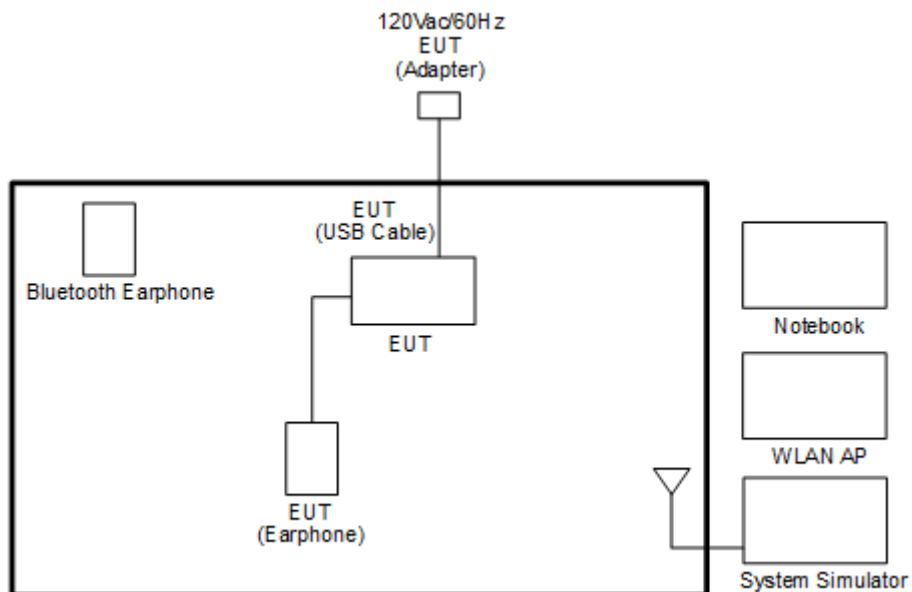



2.5 Support Unit used in test configuration and system

Item	Equipment	Trade Name	Model Name	FCC ID	Data Cable	Power Cord
1.	System Simulator	Anritsu	MT8820C	N/A	N/A	Unshielded, 1.8 m
2.	Bluetooth Earphone	Sony Ericsson	MW600	PY7DDA-2029	N/A	N/A
3.	WLAN AP	D-Link	DIR-865L	KA2IR865LA1	N/A	Unshielded, 1.8 m
4.	Notebook	DELL	Latitude E6320	FCC DoC/ Contains FCC ID: QDS-BRCM1054	N/A	AC I/P: Unshielded, 1.2 m DC O/P: Shielded, 1.8 m
5.	SD Card	SanDisk	MicroSD HC	FCC DoC	N/A	N/A

2.6 EUT Operation Test Setup

For WLAN function, programmed RF utility, "QRCT" installed in the notebook make the EUT provide functions like channel selection and power level for continuous transmitting and receiving signals.

2.7 Measurement Results Explanation Example

For all conducted test items:

The offset level is set in the spectrum analyzer to compensate the RF cable loss and attenuator factor between EUT conducted output port and spectrum analyzer. With the offset compensation, the spectrum analyzer reading level is exactly the EUT RF output level.

Example :

The spectrum analyzer offset is derived from RF cable loss and attenuator factor.

Offset = RF cable loss + attenuator factor.

Following shows an offset computation example with cable loss 4.2 dB and 10dB attenuator.

$$\begin{aligned} \text{Offset(dB)} &= \text{RF cable loss(dB)} + \text{attenuator factor(dB)}. \\ &= 4.2 + 10 = 14.2 \text{ (dB)} \end{aligned}$$

3 Test Result

3.1 26dB & 99% Occupied Bandwidth Measurement

3.1.1 Description of 26dB & 99% Occupied Bandwidth

This section is for reporting purpose only.

There is no restriction limits for bandwidth.

3.1.2 Measuring Instruments

The measuring equipment is listed in the section 4 of this test report.

3.1.3 Test Procedures

1. The testing follows FCC KDB 789033 D02 General UNII Test Procedures New Rules v01r02.
Section C) Emission bandwidth
2. Set RBW = approximately 1% of the emission bandwidth.
3. Set the VBW > RBW.
4. Detector = Peak.
5. Trace mode = max hold
6. Measure the maximum width of the emission that is 26 dB down from the peak of the emission.
Compare this with the RBW setting of the analyzer. Readjust RBW and repeat measurement as needed until the RBW/EBW ratio is approximately 1%.
7. For 99% Bandwidth Measurement, the spectrum analyzer's resolution bandwidth (RBW) is set 1MHz and set the Video bandwidth (VBW) $\geq 3 * RBW$.
8. Measure and record the results in the test report.

3.1.4 Test Setup

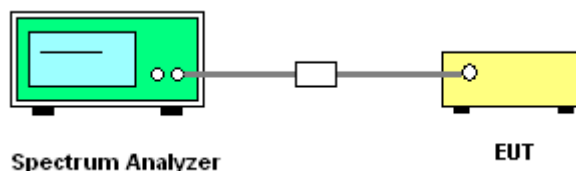



3.1.5 Test Result of 26dB & 99% Occupied Bandwidth Plots

Please refer to Appendix A.

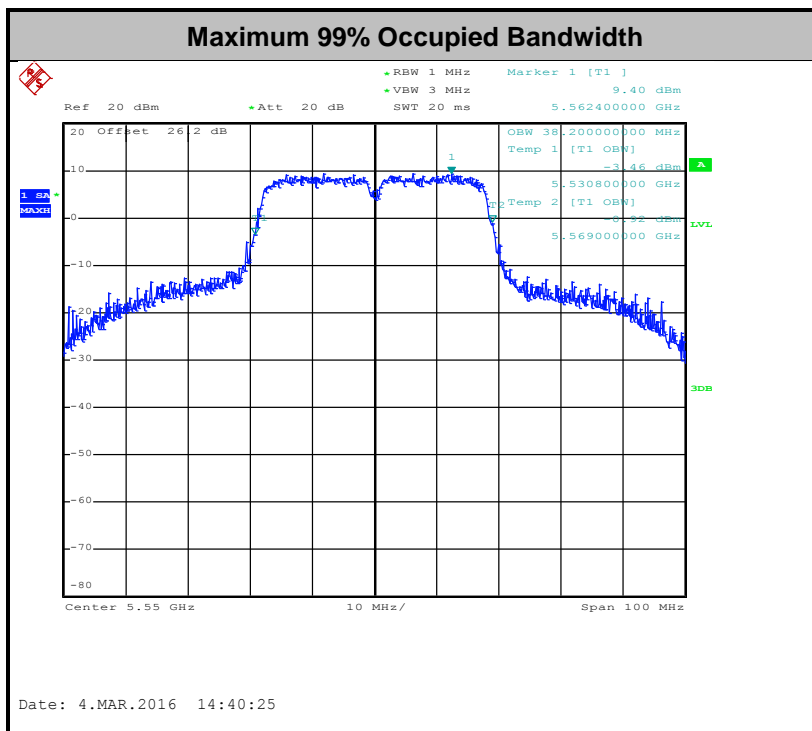
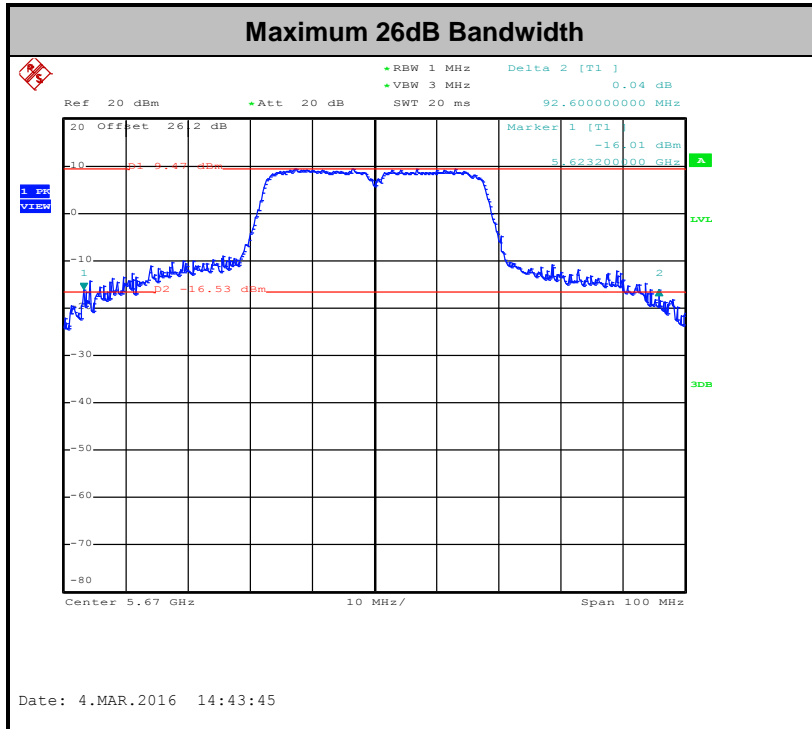



3.2 Maximum Conducted Output Power Measurement

3.2.1 Limit of Maximum Conducted Output Power

<FCC 14-30 CFR 15.407>

For mobile and portable client devices in the 5.15–5.25 GHz band, the maximum conducted output power over the frequency band of operation shall not exceed 250 mW.

For the 5.25–5.35 GHz and 5.47–5.725 GHz bands, the maximum conducted output power over the frequency bands of operation shall not exceed the lesser of 250 mW or $11 \text{ dBm} + 10 \log B$, where B is the 26 dB emission bandwidth in megahertz.

If transmitting antennas of directional gain greater than 6 dBi are used, the peak output power shall be reduced by the amount in dB that the directional gain of the antenna exceeds 6 dBi.

Note that U-NII-2 band, devices with a maximum e.i.r.p. greater than 500 mW shall implement TPC in order to have the capability to operate at least 6 dB below the maximum permitted e.i.r.p. of 1 W.

3.2.2 Measuring Instruments

The measuring equipment is listed in the section 4 of this test report.

3.2.3 Test Procedures

The testing follows Method PM of FCC KDB 789033 D02 General UNII Test Procedures New Rules v01r02.

Method PM (Measurement using an RF average power meter):

1. Measurement is performed using a wideband RF power meter.
2. The EUT is configured to transmit continuously with a consistent duty cycle at its maximum power control level.
3. Measure the average power of the transmitter, and the average power is corrected with duty factor, $10 \log(1/x)$, where x is the duty cycle.

3.2.4 Test Setup

For normal channel:

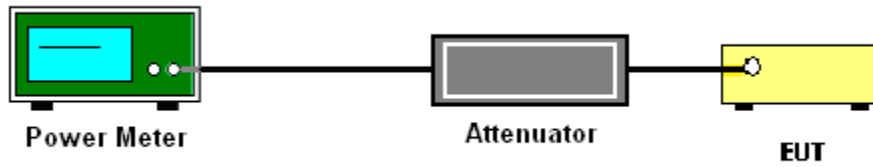

3.2.5 Test Result of Maximum Conducted Output Power

Please refer to Appendix A.



3.3 Power Spectral Density Measurement

3.3.1 Limit of Power Spectral Density

<FCC 14-30 CFR 15.407>

For mobile and portable client devices in the 5.15–5.25 GHz band, the maximum power spectral density shall not exceed 11dBm in any 1 megahertz band.

For the 5.25–5.35 GHz and 5.47–5.725 GHz bands, the maximum power spectral density shall not exceed 11 dBm in any 1 megahertz band.

If transmitting antennas of directional gain greater than 6 dBi are used, the peak output power shall be reduced by the amount in dB that the directional gain of the antenna exceeds 6 dBi.

3.3.2 Measuring Instruments

The measuring equipment is listed in the section 4 of this test report.

3.3.3 Test Procedures

The testing follows FCC KDB 789033 D02 General UNII Test Procedures New Rules v01r02.
Section F) Maximum power spectral density.

Method SA-2

(trace averaging across on and off times of the EUT transmissions, followed by duty cycle correction).

1. The testing follows Method SA-2 of FCC KDB 789033 D02 General UNII Test Procedures New Rules v01r02.
 - Measure the duty cycle.
 - Set span to encompass the entire emission bandwidth (EBW) of the signal.
 - Set RBW = 1 MHz.
 - Set VBW \geq 3 MHz.
 - Number of points in sweep \geq 2 Span / RBW.
 - Sweep time = auto.
 - Detector = RMS
 - Trace average at least 100 traces in power averaging mode.
 - Add $10 \log(1/x)$, where x is the duty cycle, to the measured power in order to compute the average power during the actual transmission times. For example, add $10 \log(1/0.25) = 6$ dB if the duty cycle is 25 percent.
2. The RF output of EUT was connected to the spectrum analyzer by a low loss cable.
3. Each plot has already offset with cable loss, and attenuator loss. Measure the PPSD and record it.

3.3.4 Test Setup

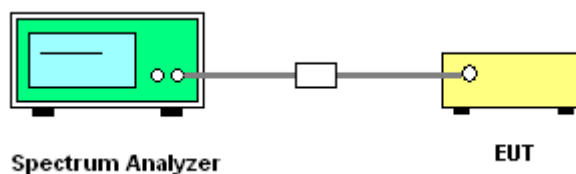



3.3.5 Test Result of Power Spectral Density

Please refer to Appendix A.

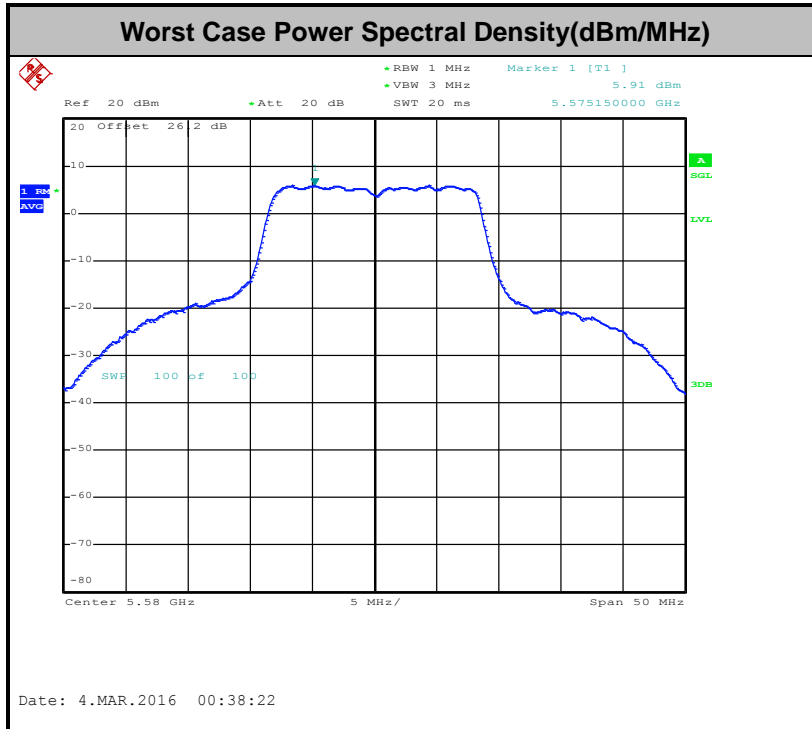

Note: Average Power Density (dB) = Measured value+ Duty Factor



3.4 Unwanted Radiated Emission Measurement

This section as specified in FCC Part 15.407(b) is to measure unwanted emissions through radiated measurement for band edge spurious emissions and out of band emissions measurement. The unwanted emissions shall comply with 15.407(b)(1) to (6), and restricted bands per FCC Part15.205.

3.4.1 Limit of Unwanted Emissions

(1) For transmitters operating in the 5150-5250 MHz band: all emissions outside of the 5150-5350 MHz band shall not exceed an EIRP of -27dBm/MHz.

For transmitters operating in the 5250-5350 MHz band: all emissions outside of the 5150-5350 MHz band shall not exceed an EIRP of -27 dBm/MHz. Devices operating in the 5250-5350 MHz band that generate emissions in the 5150-5250 MHz band must meet all applicable technical requirements for operation in the 5150-5250 MHz band (including indoor use) or alternatively meet an out-of-band emission EIRP limit of -27 dBm/MHz in the 5150-5250 MHz band.

For transmitters operating in the 5470-5600 MHz and 5650-5725MHz band: all emissions outside of the 5470-5600 MHz and 5650-5725MHz band shall not exceed an EIRP of -27 dBm/MHz.

(2) Unwanted spurious emissions fallen in restricted bands per FCC Part15.205 shall comply with the general field strength limits set forth in § 15.209 as below table,

Frequency (MHz)	Field Strength (microvolts/meter)	Measurement Distance (meters)
0.009 – 0.490	2400/F(kHz)	300
0.490 – 1.705	24000/F(kHz)	30
1.705 – 30.0	30	30
30 – 88	100	3
88 – 216	150	3
216 - 960	200	3
Above 960	500	3

Note: The following formula is used to convert the EIRP to field strength.

$$E = \frac{1000000\sqrt{30P}}{3} \mu\text{V/m, where P is the eirp (Watts)}$$

EIRP (dBm)	Field Strength at 3m (dBμV/m)
-17	78.3
- 27	68.3



- (3) KDB789033 D01 v01r02 G)2)c) As specified in 15.407(b), emissions above 1000 MHz that are outside of the restricted bands are subject to a peak emission limit of -27 dBm/MHz (or -17 dBm/MHz as specified in 15.407(b)(4)). However, an out-of-band emission that complies with both the average and peak limits of 15.209 is not required to satisfy the -27 dBm/MHz or -17 dBm/MHz peak emission limit.

3.4.2 Measuring Instruments

The measuring equipment is listed in the section 4 of this test report.



3.4.3 Test Procedures

1. The testing follows FCC ANSI C63.10-2013.

Section G) Unwanted emissions measurement.

(1) Procedure for Unwanted Emissions Measurements Below 1000MHz

- RBW = 120 kHz
- VBW = 300 kHz
- Detector = Peak
- Trace mode = max hold

(2) Procedure for Peak Unwanted Emissions Measurements Above 1000 MHz

- RBW = 1 MHz
- VBW ≥ 3 MHz
- Detector = Peak
- Sweep time = auto
- Trace mode = max hold

(3) Procedures for Average Unwanted Emissions Measurements Above 1000MHz

- RBW = 1 MHz
- VBW = 10 Hz, when duty cycle is no less than 98 percent.
- VBW ≥ 1/T, when duty cycle is less than 98 percent where T is the minimum transmission duration over which the transmitter is on and is transmitting at its maximum power control level for the tested mode of operation.

Band	Duty Cycle(%)	T(μs)	1/T(kHz)	VBW Setting
802.11a	87.261	1370	0.729927007	1kHz
802.11n HT20	86.486	1280	0.78125	1kHz
802.11n HT40	75	630	1.587301587	3kHz

- The EUT was placed on a turntable with 0.8 meter for frequency below 1GHz and 1.5 meter for frequency above 1GHz respectively above ground.
- The EUT was set 3 meters from the interference receiving antenna which was mounted on the top of a variable height antenna tower.
- The antenna is a broadband antenna and its height is adjusted between one meter and four meters above ground to find the maximum value of the field strength for both horizontal polarization and vertical polarization of the antenna.
- For each suspected emission, the EUT was arranged to its worst case and then adjust the antenna tower (from 1 m to 4 m) and turntable (from 0 degree to 360 degrees) to find the maximum reading.

6. For testing below 1GHz, if the emission level of the EUT in peak mode was 3 dB lower than the limit specified, then peak values of EUT will be reported, otherwise, the emissions will be repeated one by one using the CISPR quasi-peak method and reported.
7. For testing above 1GHz, the emission level of the EUT in peak mode was 20dB lower than average limit (that means the emission level in average mode also complies with the limit in average mode), then peak values of EUT will be reported, otherwise, the emissions will be measured in average mode again and reported.

3.4.4 Test Setup

For radiated emissions below 30MHz

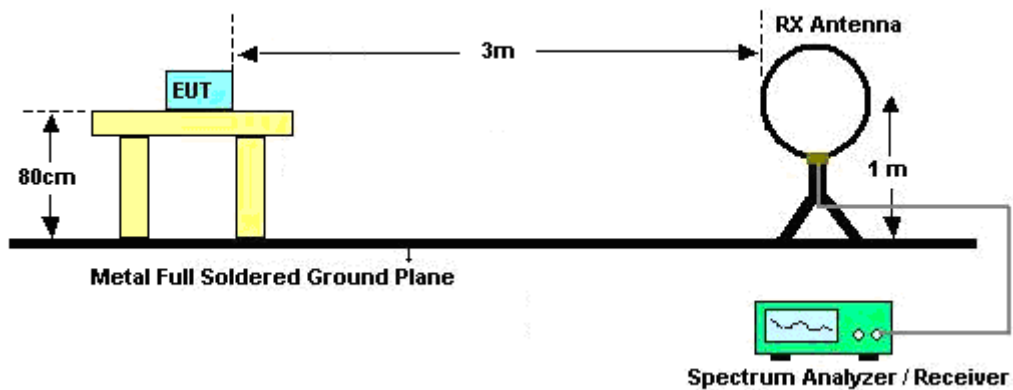

For radiated emissions from 30MHz to 1GHz

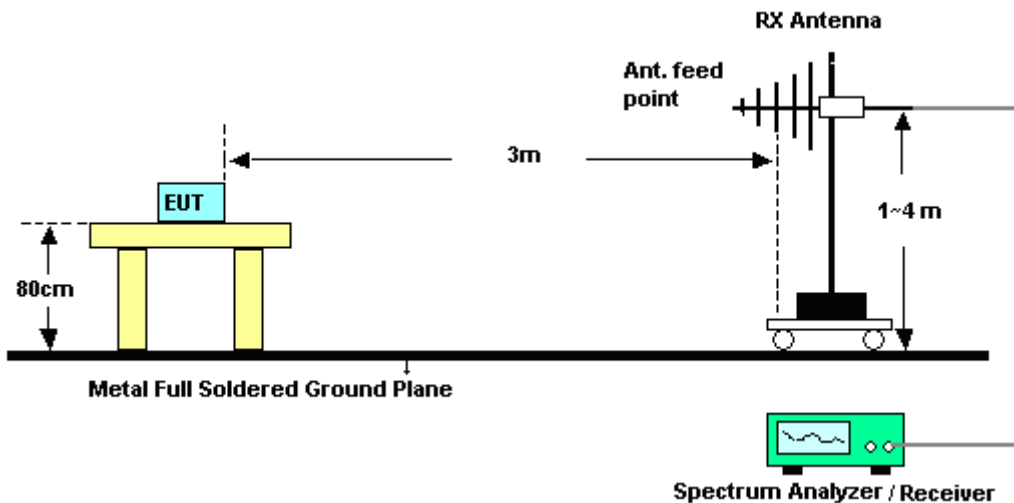

For radiated emissions above 1GHz

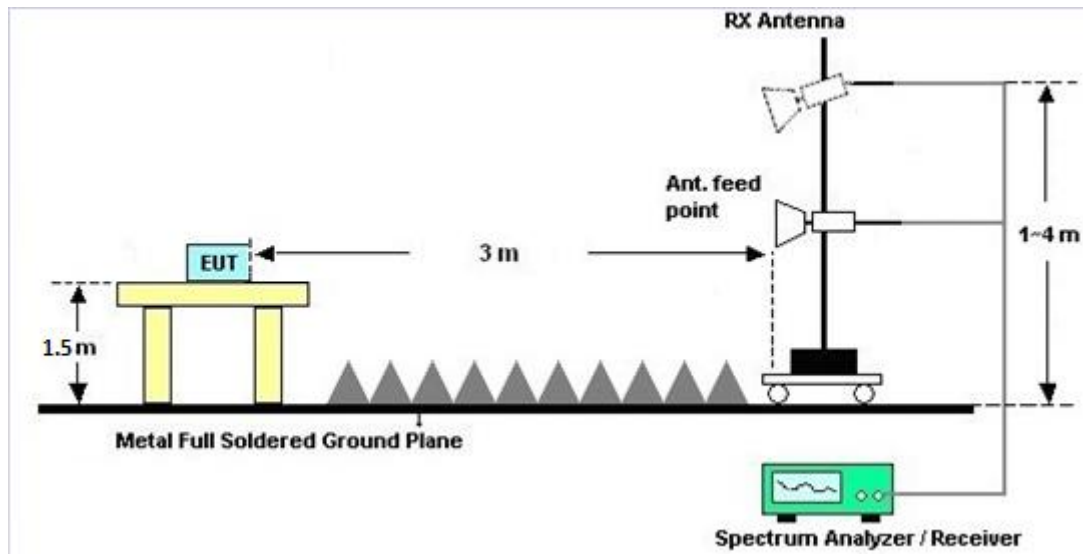

3.4.5 Test Results of Radiated Emissions (9 kHz ~ 30 MHz)

The low frequency, which started from 9 kHz to 30MHz, was pre-scanned and the result which was 20dB lower than the limit line per 15.31(o) was not reported.

3.4.6 Test Result of Radiated Band Edges

Please refer to Appendix B and C.

3.4.7 Test Result of Unwanted Radiated Emission (30MHz ~ 10th Harmonic)

Please refer to Appendix B and C.



3.5 AC Conducted Emission Measurement

3.5.1 Limit of AC Conducted Emission

For equipment that is designed to be connected to the public utility (AC) power line, the radio frequency voltage that is conducted back onto the AC power line on any frequency or frequencies within the band 150 kHz to 30 MHz shall not exceed the limits in the following table.

Frequency of emission (MHz)	Conducted limit (dB μ V)	
	Quasi-peak	Average
0.15-0.5	66 to 56*	56 to 46*
0.5-5	56	46
5-30	60	50

*Decreases with the logarithm of the frequency.

3.5.2 Measuring Instruments

The measuring equipment is listed in the section 4 of this test report.

3.5.3 Test Procedures

1. The EUT was placed 0.4 meter from the conducting wall of the shielding room was kept at least 80 centimeters from any other grounded conducting surface.
2. Connect EUT to the power mains through a line impedance stabilization network (LISN).
3. All the support units are connecting to the other LISN.
4. The LISN provides 50 ohm coupling impedance for the measuring instrument.
5. The FCC states that a 50 ohm, 50 microhenry LISN should be used.
6. Both sides of AC line were checked for maximum conducted interference.
7. The frequency range from 150 kHz to 30 MHz was searched.
8. Set the test-receiver system to Peak Detect Function and specified bandwidth with Maximum Hold Mode.

3.5.4 Test Setup

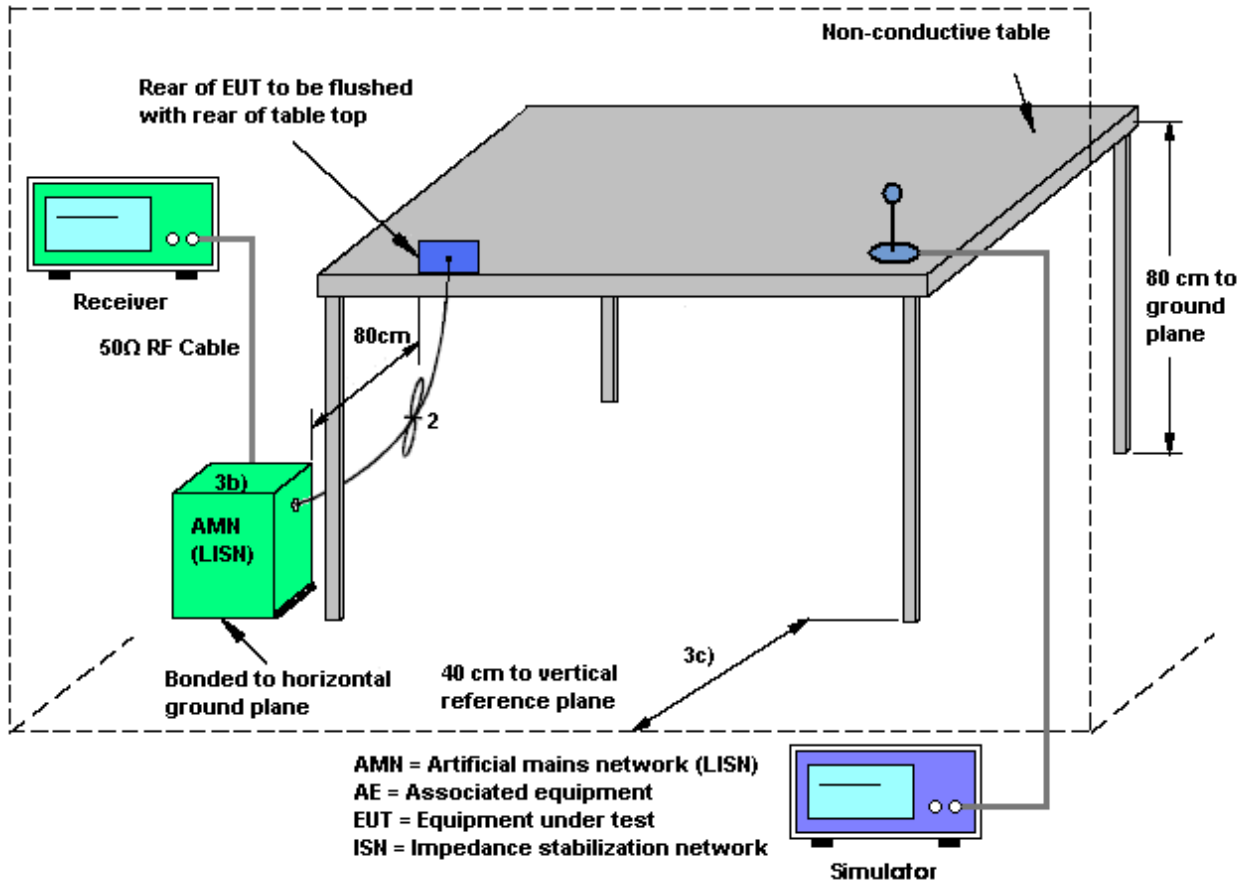

3.5.5 Test Result of AC Conducted Emission

Test Mode :	Mode 1	Temperature :	23~24°C
Test Engineer :	Kai-Chun Chu	Relative Humidity :	48~49%
Test Voltage :	120Vac / 60Hz	Phase :	Line
Function Type :	GSM850 Idle + Bluetooth Link + WLAN (5GHz) Link + Earphone + MP3 + USB Cable (Charging from Adapter)		

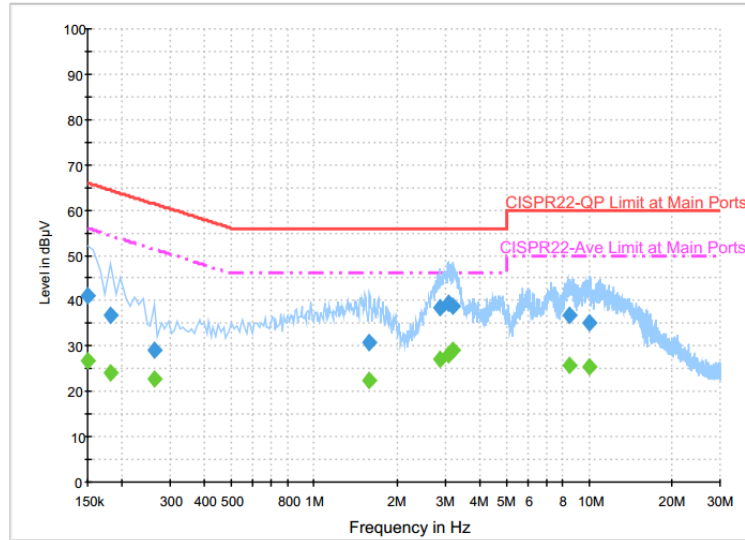

Final Result : QuasiPeak

Frequency (MHz)	QuasiPeak (dBµV)	Filter	Line	Corr. (dB)	Margin (dB)	Limit (dBµV)
0.150000	41.1	Off	L1	19.6	24.9	66.0
0.182000	36.9	Off	L1	19.6	27.5	64.4
0.262000	29.2	Off	L1	19.6	32.2	61.4
1.590000	30.7	Off	L1	19.6	25.3	56.0
2.870000	38.4	Off	L1	19.5	17.6	56.0
3.070000	39.4	Off	L1	19.6	16.6	56.0
3.206000	38.9	Off	L1	19.6	17.1	56.0
8.518000	36.8	Off	L1	19.7	23.2	60.0
9.982000	35.1	Off	L1	19.7	24.9	60.0

Final Result : Average

Frequency (MHz)	Average (dBµV)	Filter	Line	Corr. (dB)	Margin (dB)	Limit (dBµV)
0.150000	26.7	Off	L1	19.6	29.3	56.0
0.182000	24.1	Off	L1	19.6	30.3	54.4
0.262000	22.8	Off	L1	19.6	28.6	51.4
1.590000	22.5	Off	L1	19.6	23.5	46.0
2.870000	27.1	Off	L1	19.5	18.9	46.0
3.070000	28.2	Off	L1	19.6	17.8	46.0
3.206000	29.0	Off	L1	19.6	17.0	46.0
8.518000	25.6	Off	L1	19.7	24.4	50.0
9.982000	25.3	Off	L1	19.7	24.7	50.0



Test Mode :	Mode 1	Temperature :	23~24°C
Test Engineer :	Kai-Chun Chu	Relative Humidity :	48~49%
Test Voltage :	120Vac / 60Hz	Phase :	Neutral
Function Type :	GSM850 Idle + Bluetooth Link + WLAN (5GHz) Link + Earphone + MP3 + USB Cable (Charging from Adapter)		

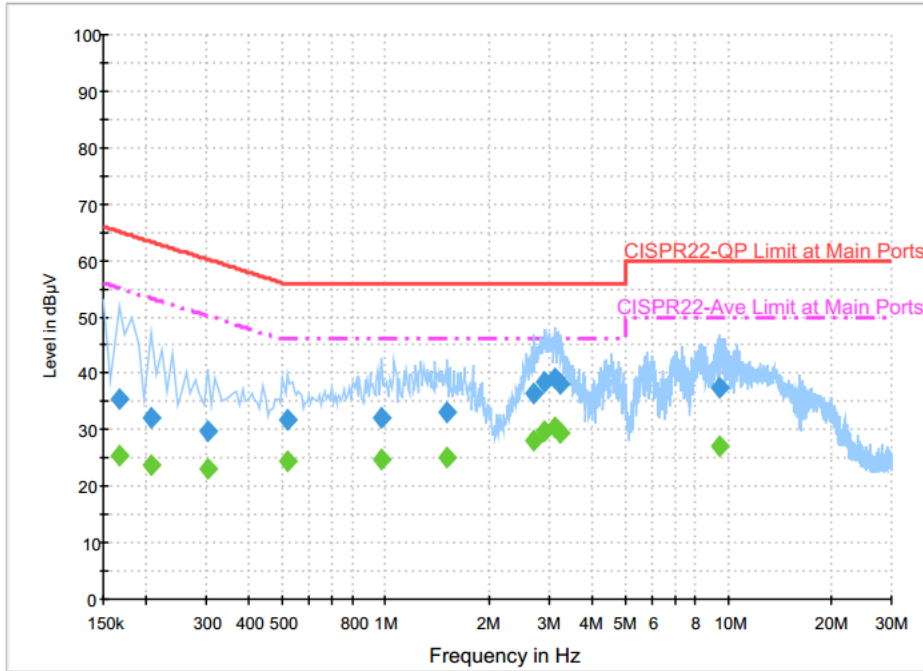

Final Result : QuasiPeak

Frequency (MHz)	QuasiPeak (dBµV)	Filter	Line	Corr. (dB)	Margin (dB)	Limit (dBµV)
0.166000	35.4	Off	N	19.6	29.8	65.2
0.206000	32.2	Off	N	19.7	31.2	63.4
0.302000	29.7	Off	N	19.6	30.5	60.2
0.518000	31.9	Off	N	19.6	24.1	56.0
0.974000	32.1	Off	N	19.6	23.9	56.0
1.510000	33.2	Off	N	19.6	22.8	56.0
2.702000	36.5	Off	N	19.4	19.5	56.0
2.910000	38.5	Off	N	19.5	17.5	56.0
3.110000	39.3	Off	N	19.6	16.7	56.0
3.246000	38.1	Off	N	19.6	17.9	56.0
9.446000	37.3	Off	N	19.8	22.7	60.0



Test Mode :	Mode 1	Temperature :	23~24°C
Test Engineer :	Kai-Chun Chu	Relative Humidity :	48~49%
Test Voltage :	120Vac / 60Hz	Phase :	Neutral
Function Type :	GSM850 Idle + Bluetooth Link + WLAN (5GHz) Link + Earphone + MP3 + USB Cable (Charging from Adapter)		

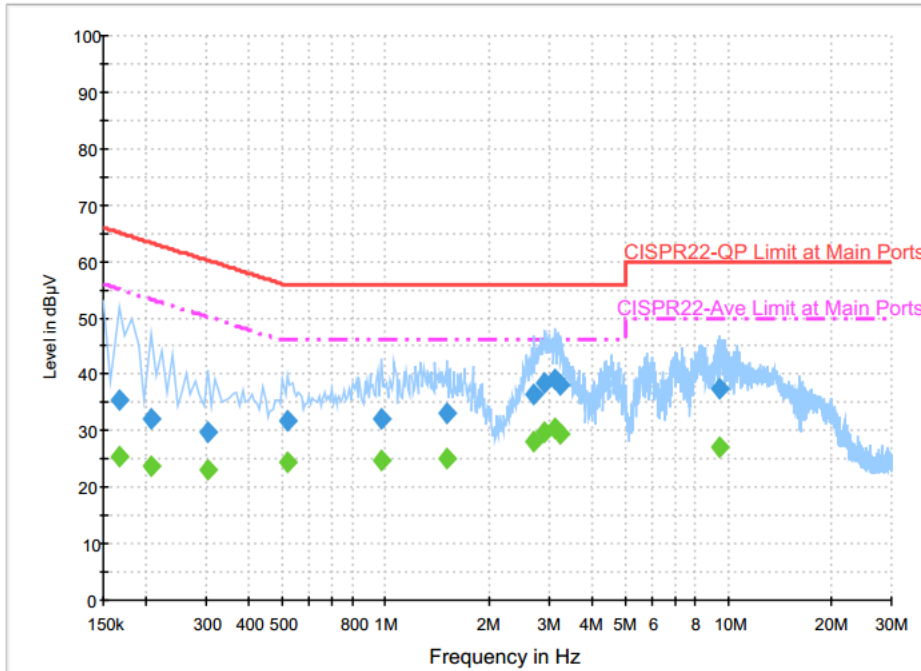

Final Result : Average

Frequency (MHz)	Average (dBµV)	Filter	Line	Corr. (dB)	Margin (dB)	Limit (dBµV)
0.166000	25.4	Off	N	19.6	29.8	55.2
0.206000	23.7	Off	N	19.7	29.7	53.4
0.302000	23.1	Off	N	19.6	27.1	50.2
0.518000	24.3	Off	N	19.6	21.7	46.0
0.974000	24.7	Off	N	19.6	21.3	46.0
1.510000	25.2	Off	N	19.6	20.8	46.0
2.702000	27.9	Off	N	19.4	18.1	46.0
2.910000	29.9	Off	N	19.5	16.1	46.0
3.110000	30.4	Off	N	19.6	15.6	46.0
3.246000	29.3	Off	N	19.6	16.7	46.0
9.446000	27.2	Off	N	19.8	22.8	50.0

3.6 Frequency Stability Measurement

3.6.1 Limit of Frequency Stability

Manufacturers of U-NII devices are responsible for ensuring frequency stability such that an emission is maintained within the band of operation under all conditions of normal operation as specified in the user's manual.

3.6.2 Measuring Instruments

The measuring equipment is listed in the section 4 of this test report.

3.6.3 Test Procedures

1. To ensure emission at the band edge is maintained within the authorized band, those values shall be measured by radiation emissions at upper and lower frequency points, and finally compensated by frequency deviation as procedures below.
2. The EUT was operated at the maximum output power, and connected to the spectrum analyzer, which is set to maximum hold function and peak detector. The peak value of the power envelope was measured and noted. The upper and lower frequency points were respectively measured relatively 10dB lower than the measured peak value.
3. The frequency deviation was calculated by adding the upper frequency point and the lower frequency point divided by two. Those detailed values of frequency deviation are provided in table below.

3.6.4 Test Setup

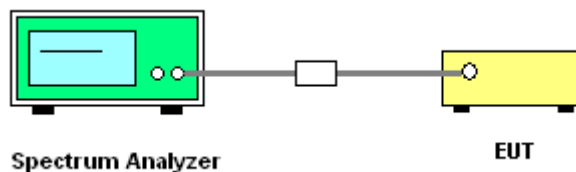

3.6.5 Test Result of Frequency Stability

Please refer to Appendix A.



3.7 Automatically Discontinue Transmission

3.7.1 Limit of Automatically Discontinue Transmission

The device shall automatically discontinue transmission in case of either absence of information to transmit or operational failure. These provisions are not intended to preclude the transmission of control or signaling information or the use of repetitive codes used by certain digital technologies to complete frame or burst intervals. Applicants shall include in their application for equipment authorization to describe how this requirement is met.

3.7.2 Measuring Instruments

The measuring equipment is listed in the section 4 of this test report.

3.7.3 Test Result of Automatically Discontinue Transmission

While the EUT is not transmitting any information, the EUT can automatically discontinue transmission and become standby mode for power saving. The EUT can detect the controlling signal of ACK message transmitting from remote device and verify whether it shall resend or discontinue transmission.



3.8 Antenna Requirements

3.8.1 Standard Applicable

According to FCC 47 CFR Section 15.407(a)(1)(2) ,if transmitting antenna directional gain is greater than 6 dBi, both the peak transmit power and the peak power spectral density shall be reduced by the amount in dB that the directional gain of the antenna exceeds 6 dBi.

3.8.2 Antenna Anti-Replacement Construction

An embedded-in antenna design is used.

3.8.3 Antenna Gain

The antenna gain is less than 6 dBi. Therefore, it is not necessary to reduce maximum peak output power limit.



4 List of Measuring Equipments

Instrument	Manufacturer	Model No.	Serial No.	Characteristics	Calibration Date	Test Date	Due Date	Remark
Power Meter	Agilent	E4416A	GB41292344	300MHz~40GHz	Jan. 08, 2016	Feb. 15, 2016 ~ Mar. 05, 2016	Jan. 07, 2017	Conducted (TH02-HY)
Power Sensor	Agilent	E9327A	US40441548	300MHz~40GHz	Jan. 07, 2016	Feb. 15, 2016 ~ Mar. 05, 2016	Jan. 06, 2017	Conducted (TH02-HY)
Spectrum Analyzer	Rohde & Schwarz	FSP40	100055	9kHz~40GHz	Jun. 18, 2015	Feb. 15, 2016 ~ Mar. 05, 2016	Jun. 17, 2016	Conducted (TH02-HY)
AC Power Source	ChainTek	APC-1000W	N/A	N/A	N/A	Feb. 12, 2016	N/A	Conduction (CO05-HY)
EMI Test Receiver	Rohde & Schwarz	ESCI 7	100724	9kHz~7GHz	Aug. 26, 2015	Feb. 12, 2016	Aug. 25, 2016	Conduction (CO05-HY)
LISN	Rohde & Schwarz	ENV216	100080	9kHz~30MHz	Dec. 02, 2015	Feb. 12, 2016	Dec. 01, 2016	Conduction (CO05-HY)
Bilog Antenna	TESEQ	CBL 6111D	35419	30MHz to 1GHz	Jan. 13, 2016	Feb. 22, 2016 ~ Mar. 02, 2016	Jan. 12, 2017	Radiation (03CH07-HY)
Double Ridge Horn Antenna	ESCO	3117	00075962	1GHz ~ 18GHz	Aug. 21, 2015	Feb. 22, 2016 ~ Mar. 02, 2016	Aug. 20, 2016	Radiation (03CH07-HY)
Loop Antenna	Rohde & Schwarz	HFH2-Z2	100315	9 kHz~30 MHz	Sep. 02, 2015	Feb. 22, 2016 ~ Mar. 02, 2016	Sep. 01, 2016	Radiation (03CH07-HY)
Preamplifier	MITEQ	AMF-7D-0010 1800-30-10P	1590075	1GHz ~ 18GHz	Apr. 20, 2015	Feb. 22, 2016 ~ Mar. 02, 2016	Apr. 19, 2016	Radiation (03CH07-HY)
Preamplifier	COM-POWER	PA-103A	161241	10MHz-1000MHz	Mar. 12, 2015	Feb. 22, 2016 ~ Mar. 02, 2016	Mar. 11, 2016	Radiation (03CH07-HY)
Preamplifier	Agilent	8449B	3008A02362	1GHz~ 26.5GHz	Oct. 19, 2015	Feb. 22, 2016 ~ Mar. 02, 2016	Oct. 18, 2016	Radiation (03CH07-HY)
Spectrum Analyzer	Agilent	N9010A	MY53470118	10Hz~44GHz	Feb. 27, 2016	Feb. 28 2016 ~ Mar. 02, 2016	Feb. 26, 2017	Radiation (03CH07-HY)
EMI Test Receiver	Agilent	N9038A(MXE)	MY53290053	20Hz ~ 26.5GHz	Jan. 20, 2016	Feb. 22, 2016 ~ Mar. 02, 2016	Jan. 19, 2017	Radiation (03CH07-HY)
Spectrum Analyzer	Agilent	N9010A	MY53470118	10Hz~44GHz	Mar. 03, 2015	Feb. 22, 2016 ~ Feb. 26, 2016	Mar. 02, 2016	Radiation (03CH07-HY)
Antenna Mast	Max-Full	MFA520BS	N/A	1m~4m	N/A	Feb. 22, 2016 ~ Mar. 02, 2016	N/A	Radiation (03CH07-HY)
Turn Table	ChainTek	Chaintek 3000	N/A	0~360 degree	N/A	Feb. 22, 2016 ~ Mar. 02, 2016	N/A	Radiation (03CH07-HY)
SHF-EHF Horn Antenna	SCHWARZBECK	BBHA 9170	BBHA917025 1	18GHz- 40GHz	Oct. 12, 2015	Feb. 22, 2016 ~ Mar. 02, 2016	Oct. 11, 2016	Radiation (03CH07-HY)
Preamplifier	MITEQ	JS44-1800400 0-33-8P	1840917	18GHz ~ 40GHz	Jun. 02, 2015	Feb. 22, 2016 ~ Mar. 02, 2016	Jun. 01, 2016	Radiation (03CH07-HY)



5 Uncertainty of Evaluation

Uncertainty of Conducted Emission Measurement (150kHz ~ 30MHz)

Measuring Uncertainty for a Level of Confidence of 95% ($U = 2Uc(y)$)	2.26
---	------

Uncertainty of Radiated Emission Measurement (30 MHz ~ 1000 MHz)

Measuring Uncertainty for a Level of Confidence of 95% ($U = 2Uc(y)$)	4.80
---	------



Appendix A. Conducted Test Results

Test Engineer:	Derek Hsu / AnAn Wu	Temperature:	21~25	°C
Test Date:	2016/02/15~2016/03/05	Relative Humidity:	51~54	%

TEST RESULTS DATA
26dB and 99% OBW

Band I								
Mod.	Data Rate	NTX	CH.	Freq. (MHz)	99% Bandwidth (MHz)	26 dB Bandwidth (MHz)	IC 99% Bandwidth Power Limit (dBm)	IC 99% Bandwidth EIRP Limit (dBm)
11a	6Mbps	1	36	5180	19.00	44.10	-	22.79
11a	6Mbps	1	44	5220	18.75	43.70	-	22.73
11a	6Mbps	1	48	5240	18.60	43.50	-	22.70
HT20	MCS0	1	36	5180	19.20	46.20	-	22.83
HT20	MCS0	1	44	5220	19.55	45.80	-	22.91
HT20	MCS0	1	48	5240	19.30	43.60	-	22.86
HT40	MCS0	1	38	5190	36.80	46.44	-	23.01
HT40	MCS0	1	46	5230	36.80	75.00	-	23.01

TEST RESULTS DATA
Average Power Table

FCC Band I									
Mod.	Data Rate	NTX	CH.	Freq. (MHz)	Duty Factor (dB)	Average Conducted Power (dBm)	FCC Conducted Power Limit (dBm)	DG (dBi)	Pass/Fail
11a	6Mbps	1	36	5180	13.00	15.98	24.00	-1.00	Pass
11a	6Mbps	1	44	5220	13.00	16.25	24.00	-1.00	Pass
11a	6Mbps	1	48	5240	13.00	16.04	24.00	-1.00	Pass
HT20	MCS0	1	36	5180	12.00	15.12	24.00	-1.00	Pass
HT20	MCS0	1	44	5220	12.00	15.15	24.00	-1.00	Pass
HT20	MCS0	1	48	5240	12.00	15.21	24.00	-1.00	Pass
HT40	MCS0	1	38	5190	15.50	10.46	24.00	-1.00	Pass
HT40	MCS0	1	46	5230	15.50	14.92	24.00	-1.00	Pass

TEST RESULTS DATA
Power Spectral Density

FCC Band I									
Mod.	Data Rate	NTX	CH.	Freq. (MHz)	Duty Factor (dB)	Average Power Density (dBm/MHz)	Average PSD Limit (dBm/MHz)	DG (dBi)	Pass/Fail
11a	6Mbps	1	36	5180	0.59	4.32	11.00	-1.00	Pass
11a	6Mbps	1	44	5220	0.59	4.40	11.00	-1.00	Pass
11a	6Mbps	1	48	5240	0.59	4.53	11.00	-1.00	Pass
HT20	MCS0	1	36	5180	0.63	2.87	11.00	-1.00	Pass
HT20	MCS0	1	44	5220	0.63	3.45	11.00	-1.00	Pass
HT20	MCS0	1	48	5240	0.63	3.30	11.00	-1.00	Pass
HT40	MCS0	1	38	5190	1.25	-5.39	11.00	-1.00	Pass
HT40	MCS0	1	46	5230	1.25	4.66	11.00	-1.00	Pass

TEST RESULTS DATA
26dB and 99% OBW

Band II									
Mod.	Data Rate	NTX	CH.	Freq. (MHz)	99% Bandwidth (MHz)	26 dB Bandwidth (MHz)	IC 99% Bandwidth Power Limit (dBm)	IC 99% Bandwidth EIRP Limit (dBm)	FCC 26dB Bandwidth Power Limit (dBm)
11a	6M bps	1	52	5260	18.45	42.9	23.66	29.66	23.98
11a	6M bps	1	60	5300	18.9	44.3	23.76	29.76	23.98
11a	6M bps	1	64	5320	18.75	44.2	23.73	29.73	23.98
HT20	MCS 0	1	52	5260	19.15	45.6	23.82	29.82	23.98
HT20	MCS 0	1	60	5300	18.95	44	23.78	29.78	23.98
HT20	MCS 0	1	64	5320	19.25	45.7	23.84	29.84	23.98
HT40	MCS 0	1	54	5270	37	84.8	23.98	30.00	23.98
HT40	MCS 0	1	62	5310	36.9	50.2	23.98	30.00	23.98

TEST RESULTS DATA
Average Power Table

FCC Band II									
Mod.	Data Rate	NTX	CH.	Freq. (MHz)	Duty Factor (dB)	Average Conducted Power (dBm)	FCC Conducted Power Limit (dBm)	DG (dBi)	Pass/Fail
11a	6M bps	1	52	5260	13.00	16.42	23.98	-2.00	Pass
11a	6M bps	1	60	5300	13.00	16.27	23.98	-2.00	Pass
11a	6M bps	1	64	5320	13.00	16.40	23.98	-2.00	Pass
HT20	MCS 0	1	52	5260	12.00	15.28	23.98	-2.00	Pass
HT20	MCS 0	1	60	5300	12.00	15.36	23.98	-2.00	Pass
HT20	MCS 0	1	64	5320	12.00	15.69	23.98	-2.00	Pass
HT40	MCS 0	1	54	5270	15.50	14.79	23.98	-2.00	Pass
HT40	MCS 0	1	62	5310	15.50	12.83	23.98	-2.00	Pass

TEST RESULTS DATA
Power Spectral Density

Band II									
Mod.	Data Rate	NTX	CH.	Freq. (MHz)	Duty Factor (dB)	Average Power Density (dBm/MHz)	Average PSD Limit (dBm/MHz)	DG (dBi)	Pass/Fail
11a	6M bps	1	52	5260	0.59	4.68	11.00	-2.00	Pass
11a	6M bps	1	60	5300	0.59	4.49	11.00	-2.00	Pass
11a	6M bps	1	64	5320	0.59	4.32	11.00	-2.00	Pass
HT20	MCS 0	1	52	5260	0.63	3.43	11.00	-2.00	Pass
HT20	MCS 0	1	60	5300	0.63	3.37	11.00	-2.00	Pass
HT20	MCS 0	1	64	5320	0.63	3.37	11.00	-2.00	Pass
HT40	MCS 0	1	54	5270	1.25	-1.91	11.00	-2.00	Pass
HT40	MCS 0	1	62	5310	1.25	-3.68	11.00	-2.00	Pass

TEST RESULTS DATA
26dB and 99% OBW

Band III									
Mod.	Data Rate	NTX	CH.	Freq. (MHz)	99% Bandwidth (MHz)	26 dB Bandwidth (MHz)	IC 99% Bandwidth Power Limit (dBm)	IC 99% Bandwidth EIRP Limit (dBm)	FCC 26dB Bandwidth Power Limit (dBm)
11a	6M bps	1	100	5500	18.4	42.8	23.65	29.65	23.98
11a	6M bps	1	116	5580	19.3	44.3	23.86	29.86	23.98
11a	6M bps	1	140	5700	18.05	41.1	23.56	29.56	23.98
HT20	MCS 0	1	100	5500	19.25	45.9	23.84	29.84	23.98
HT20	MCS 0	1	116	5580	19.3	46	23.86	29.86	23.98
HT20	MCS 0	1	140	5700	19.05	37.4	23.80	29.80	23.98
HT40	MCS 0	1	102	5510	36.7	50.6	23.98	30.00	23.98
HT40	MCS 0	1	110	5550	38.2	87.2	23.98	30.00	23.98
HT40	MCS 0	1	134	5670	37.7	92.6	23.98	30.00	23.98

TEST RESULTS DATA
Average Power Table

FCC Band III									
Mod.	Data Rate	NTX	CH.	Freq. (MHz)	Duty Factor (dB)	Average Conducted Power (dBm)	FCC Conducted Power Limit (dBm)	DG (dBi)	Pass/Fail
11a	6M bps	1	100	5500	13.00	16.61	23.98	-1.00	Pass
11a	6M bps	1	116	5580	13.00	17.44	23.98	-1.00	Pass
11a	6M bps	1	140	5700	13.00	14.28	23.98	-1.00	Pass
HT20	MCS 0	1	100	5500	12.00	15.76	23.98	-1.00	Pass
HT20	MCS 0	1	116	5580	12.00	16.86	23.98	-1.00	Pass
HT20	MCS 0	1	140	5700	12.00	13.68	23.98	-1.00	Pass
HT40	MCS 0	1	102	5510	15.50	12.90	23.98	-1.00	Pass
HT40	MCS 0	1	110	5550	15.50	16.05	23.98	-1.00	Pass
HT40	MCS 0	1	134	5670	15.50	16.57	23.98	-1.00	Pass

TEST RESULTS DATA
Power Spectral Density

Band III									
Mod.	Data Rate	NTX	CH.	Freq. (MHz)	Duty Factor (dB)	Average Power Density (dBm/MHz)	Average PSD Limit (dBm/MHz)	DG (dBi)	Pass/Fail
11a	6M bps	1	100	5500	0.59	5.79	11.00	-1.00	Pass
11a	6M bps	1	116	5580	0.59	6.50	11.00	-1.00	Pass
11a	6M bps	1	140	5700	0.59	2.76	11.00	-1.00	Pass
HT20	MCS 0	1	100	5500	0.63	4.88	11.00	-1.00	Pass
HT20	MCS 0	1	116	5580	0.63	5.37	11.00	-1.00	Pass
HT20	MCS 0	1	140	5700	0.63	1.62	11.00	-1.00	Pass
HT40	MCS 0	1	102	5510	1.25	-2.59	11.00	-1.00	Pass
HT40	MCS 0	1	110	5550	1.25	0.94	11.00	-1.00	Pass
HT40	MCS 0	1	134	5670	1.25	0.71	11.00	-1.00	Pass

TEST RESULTS DATA
Frequency Stability

Band I										
Mod.	Data Rate	NTX	CH.	Freq. (MHz)	Center Frequency (MHz)	Frequency Deviation (MHz)	Frequency Stability (ppm)	Temperature (°C)	Voltage (V)	Note
11a	6Mbps	1	36	5180	5180.100	0.100	19.31	20	3.2	
11a	6Mbps	1	36	5180	5180.100	0.100	19.31	20	4.35	
11a	6Mbps	1	36	5180	5180.100	0.100	19.31	20	3.8	
11a	6Mbps	1	36	5180	5180.100	0.100	19.31	-30	3.8	
11a	6Mbps	1	36	5180	5180.075	0.075	14.48	50	3.8	

Band II										
Mod.	Data Rate	NTX	CH.	Freq. (MHz)	Center Frequency (MHz)	Frequency Deviation (MHz)	Frequency Stability (ppm)	Temperature (°C)	Voltage (V)	Note
11a	6Mbps	1	64	5320	5320.075	0.075	14.10	20	3.2	
11a	6Mbps	1	64	5320	5320.100	0.100	18.80	20	4.35	
11a	6Mbps	1	64	5320	5320.075	0.075	14.10	20	3.8	
11a	6Mbps	1	64	5320	5320.125	0.125	23.50	-30	3.8	
11a	6Mbps	1	64	5320	5320.100	0.100	18.80	50	3.8	

Band III										
Mod.	Data Rate	NTX	CH.	Freq. (MHz)	Center Frequency (MHz)	Frequency Deviation (MHz)	Frequency Stability (ppm)	Temperature (°C)	Voltage (V)	Note
11a	6Mbps	1	100	5500	5500.100	0.100	18.18	20	3.2	
11a	6Mbps	1	100	5500	5500.100	0.100	18.18	20	4.35	
11a	6Mbps	1	100	5500	5500.100	0.100	18.18	20	3.8	
11a	6Mbps	1	100	5500	5500.100	0.100	18.18	-30	3.8	
11a	6Mbps	1	100	5500	5500.100	0.100	18.18	50	3.8	



Appendix B. Radiated Spurious Emission

Test Engineer :	James Chiu, Jesse Wang, and Ken Wu	Temperature :	21~24°C
		Relative Humidity :	50~54%

Band 1 - 5150~5250MHz

WIFI 802.11a (Band Edge @ 3m)

WIFI	Note	Frequency	Level	Over	Limit	Read	Antenna	Cable	Preamp	Ant	Table	Peak	Pol.	
Ant.				Limit	Line	Level	Factor	Loss	Factor	Pos	Pos	Avg.		
1		(MHz)	(dBμV/m)	(dB)	(dBμV/m)	(dBμV)	(dB/m)	(dB)	(dB)	(cm)	(deg)	(P/A)	(H/V)	
802.11a CH 36 5180MHz		5150	61.29	-12.71	74	50.69	34.61	11.21	35.22	200	63	P	H	
		5149.85	50.66	-3.34	54	40.06	34.61	11.21	35.22	200	63	A	H	
	*	5180	109.21	-	-	98.56	34.66	11.21	35.22	200	63	P	H	
	*	5180	98.45	-	-	87.8	34.66	11.21	35.22	200	63	A	H	
													H	
														H
			5148.2	61.45	-12.55	74	50.85	34.61	11.21	35.22	200	310	P	V
			5149.55	51.92	-2.08	54	41.32	34.61	11.21	35.22	200	310	A	V
	*		5180	110.23	-	-	99.58	34.66	11.21	35.22	200	310	P	V
	*		5180	99.76	-	-	89.11	34.66	11.21	35.22	200	310	A	V
														V
														V
802.11a CH 44 5220MHz		5136.5	50.05	-23.95	74	39.5	34.59	11.18	35.22	200	63	P	H	
		5147.6	40.76	-13.24	54	30.16	34.61	11.21	35.22	200	63	A	H	
	*	5220	109.43	-	-	98.7	34.7	11.25	35.22	200	63	P	H	
	*	5220	101.27	-	-	90.54	34.7	11.25	35.22	200	63	A	H	
			5452.52	50.59	-23.41	74	38.91	35.03	11.89	35.24	200	63	P	H
			5405.88	41.25	-12.75	54	29.64	34.96	11.89	35.24	200	63	A	H
			5147.3	49.7	-24.3	74	39.1	34.61	11.21	35.22	200	80	P	V
			5149.85	40.56	-13.44	54	29.96	34.61	11.21	35.22	200	80	A	V
	*		5220	105.99	-	-	95.26	34.7	11.25	35.22	200	80	P	V
	*		5220	97.87	-	-	87.14	34.7	11.25	35.22	200	80	A	V
			5390.92	50.1	-23.9	74	38.5	34.94	11.89	35.23	200	80	P	V
			5448.89	41.15	-12.85	54	29.47	35.03	11.89	35.24	200	80	A	V



802.11a CH 48 5240MHz		5144.6	50.3	-23.7	74	39.7	34.61	11.21	35.22	200	62	P	H
		5149.85	40.56	-13.44	54	29.96	34.61	11.21	35.22	200	62	A	H
	*	5240	110.87	-	-	99.98	34.73	11.38	35.22	200	62	P	H
	*	5240	101.58	-	-	90.69	34.73	11.38	35.22	200	62	A	H
		5355.5	50.18	-23.82	74	38.76	34.89	11.76	35.23	200	62	P	H
		5453.51	41.21	-12.79	54	29.53	35.03	11.89	35.24	200	62	A	H
		5131.1	49.01	-24.99	74	38.46	34.59	11.18	35.22	181	86	P	V
		5085.05	40.38	-13.62	54	29.93	34.52	11.14	35.21	181	86	A	V
	*	5240	106.92	-	-	96.03	34.73	11.38	35.22	181	86	P	V
	*	5240	98.77	-	-	87.88	34.73	11.38	35.22	181	86	A	V
		5410.94	49.99	-24.01	74	38.38	34.96	11.89	35.24	181	86	P	V
		5438.44	41.05	-12.95	54	29.39	35.01	11.89	35.24	181	86	A	V
Remark	1. No other spurious found. 2. All results are PASS against Peak and Average limit line.												



Band 1 5150~5250MHz

WIFI 802.11a (Harmonic @ 3m)

WIFI Ant. 1	Note	Frequency (MHz)	Level (dBμV/m)	Over Limit (dB)	Limit Line (dBμV/m)	Read Level (dBμV)	Antenna Factor (dB/m)	Cable Loss (dB)	Preamp Factor (dB)	Ant Pos (cm)	Table Pos (deg)	Peak Avg. (P/A)	Pol. (H/V)
802.11a CH 36 5180MHz		10360	43.92	-30.08	74	49.44	37.22	17.17	59.91	100	0	P	H
		15540	44.22	-29.78	74	42.15	40.34	19.61	57.88	100	0	P	H
													H
													H
		10360	43.67	-30.33	74	49.19	37.22	17.17	59.91	100	0	P	V
		15540	44.55	-29.45	74	42.48	40.34	19.61	57.88	100	0	P	V
													V
													V
802.11a CH 44 5220MHz		10440	42.92	-31.08	74	48.34	37.26	17.17	59.85	100	0	P	H
		15660	43.04	-30.96	74	40.68	40.49	19.68	57.81	100	0	P	H
													H
													H
		10440	43.46	-30.54	74	48.88	37.26	17.17	59.85	100	0	P	V
		15660	43.07	-30.93	74	40.71	40.49	19.68	57.81	100	0	P	V
													V
													V
802.11a CH 48 5240MHz		10480	43.18	-30.82	74	48.53	37.29	17.17	59.81	100	0	P	H
		15720	44.2	-29.8	74	41.67	40.57	19.73	57.77	100	0	P	H
													H
													H
		10480	42.37	-31.63	74	47.72	37.29	17.17	59.81	100	0	P	V
		15720	43.91	-30.09	74	41.38	40.57	19.73	57.77	100	0	P	V
													V
													V
Remark	1. No other spurious found. 2. All results are PASS against Peak and Average limit line.												



Band 1 5150~5250MHz

WIFI 802.11n HT20 (Band Edge @ 3m)

WIFI Ant. 1	Note	Frequency (MHz)	Level (dBμV/m)	Over Limit (dB)	Limit Line (dBμV/m)	Read Level (dBμV)	Antenna Factor (dB/m)	Cable Loss (dB)	Preamp Factor (dB)	Ant Pos (cm)	Table Pos (deg)	Peak Avg. (P/A)	Pol. (H/V)	
802.11n HT20 CH 36 5180MHz		5147.9	59.68	-14.32	74	49.08	34.61	11.21	35.22	200	63	P	H	
		5150	49.62	-4.38	54	39.02	34.61	11.21	35.22	200	63	A	H	
	*	5180	108.26	-	-	97.61	34.66	11.21	35.22	200	63	P	H	
	*	5180	97.8	-	-	87.15	34.66	11.21	35.22	200	63	A	H	
													H	
														H
			5149.85	59.79	-14.21	74	49.19	34.61	11.21	35.22	200	310	P	V
			5149.85	50.89	-3.11	54	40.29	34.61	11.21	35.22	200	310	A	V
		*	5180	109.23	-	-	98.58	34.66	11.21	35.22	200	310	P	V
		*	5180	98.55	-	-	87.9	34.66	11.21	35.22	200	310	A	V
													V	
													V	
802.11n HT20 CH 44 5220MHz		5130.95	50.1	-23.9	74	39.55	34.59	11.18	35.22	200	63	P	H	
		5149.85	40.8	-13.2	54	30.2	34.61	11.21	35.22	200	63	A	H	
		*	5220	108.16	-	-	97.43	34.7	11.25	35.22	200	63	P	H
		*	5220	97.33	-	-	86.6	34.7	11.25	35.22	200	63	A	H
			5365.18	50.53	-23.47	74	39.09	34.91	11.76	35.23	200	63	P	H
			5410.72	41.4	-12.6	54	29.79	34.96	11.89	35.24	200	63	A	H
			5083.55	50.23	-23.77	74	39.78	34.52	11.14	35.21	200	306	P	V
			5148.35	41.06	-12.94	54	30.46	34.61	11.21	35.22	200	306	A	V
		*	5220	108.93	-	-	98.2	34.7	11.25	35.22	200	306	P	V
		*	5220	97.87	-	-	87.14	34.7	11.25	35.22	200	306	A	V
		5418.97	51.41	-22.59	74	39.78	34.98	11.89	35.24	200	306	P	V	
		5449.77	41.1	-12.9	54	29.42	35.03	11.89	35.24	200	306	A	V	



802.11n HT20 CH 48 5240MHz		5015.9	49.39	-24.61	74	39.11	34.42	11.07	35.21	200	63	P	H
		5146.7	40.66	-13.34	54	30.06	34.61	11.21	35.22	200	63	A	H
	*	5240	108.56	-	-	97.67	34.73	11.38	35.22	200	63	P	H
	*	5240	98.55	-	-	87.66	34.73	11.38	35.22	200	63	A	H
		5390.81	50.4	-23.6	74	38.8	34.94	11.89	35.23	200	63	P	H
		5456.48	41.33	-12.67	54	29.65	35.03	11.89	35.24	200	63	A	H
		5087.75	49.95	-24.05	74	39.5	34.52	11.14	35.21	200	306	P	V
		5145.5	41.01	-12.99	54	30.41	34.61	11.21	35.22	200	306	A	V
	*	5240	108.9	-	-	98.01	34.73	11.38	35.22	200	306	P	V
	*	5240	98.08	-	-	87.19	34.73	11.38	35.22	200	306	A	V
		5392.13	50.4	-23.6	74	38.8	34.94	11.89	35.23	200	306	P	V
		5458.79	41.24	-12.76	54	29.56	35.03	11.89	35.24	200	306	A	V
Remark	1. No other spurious found. 2. All results are PASS against Peak and Average limit line.												



Band 1 5150~5250MHz

WIFI 802.11n HT20 (Harmonic @ 3m)

WIFI Ant. 1	Note	Frequency (MHz)	Level (dBμV/m)	Over Limit (dB)	Limit Line (dBμV/m)	Read Level (dBμV)	Antenna Factor (dB/m)	Cable Loss (dB)	Preamp Factor (dB)	Ant Pos (cm)	Table Pos (deg)	Peak Avg. (P/A)	Pol. (H/V)	
802.11n HT20 CH 36 5180MHz		10360	41.86	-32.14	74	47.38	37.22	17.17	59.91	100	0	P	H	
		15540	44.03	-29.97	74	41.96	40.34	19.61	57.88	100	0	P	H	
													H	
													H	
			10360	41.92	-32.08	74	47.44	37.22	17.17	59.91	100	0	P	V
			15540	42.86	-31.14	74	40.79	40.34	19.61	57.88	100	0	P	V
														V
802.11n HT20 CH 44 5220MHz		10440	41.88	-32.12	74	47.3	37.26	17.17	59.85	100	0	P	H	
		15660	42.78	-31.22	74	40.42	40.49	19.68	57.81	100	0	P	H	
													H	
													H	
			10440	41.99	-32.01	74	47.41	37.26	17.17	59.85	100	0	P	V
			15660	43.35	-30.65	74	40.99	40.49	19.68	57.81	100	0	P	V
														V
802.11n HT20 CH 48 5240MHz		10480	44.45	-29.55	74	49.8	37.29	17.17	59.81	100	0	P	H	
		15720	43.85	-30.15	74	41.32	40.57	19.73	57.77	100	0	P	H	
													H	
													H	
			10480	42.73	-31.27	74	48.08	37.29	17.17	59.81	100	0	P	V
			15720	43.83	-30.17	74	41.3	40.57	19.73	57.77	100	0	P	V
														V
Remark	1. No other spurious found.													
	2. All results are PASS against Peak and Average limit line.													



Band 1 5150~5250MHz

WIFI 802.11n HT40 (Band Edge @ 3m)

WIFI Ant. 1	Note	Frequency (MHz)	Level (dBμV/m)	Over Limit (dB)	Limit Line (dBμV/m)	Read Level (dBμV)	Antenna Factor (dB/m)	Cable Loss (dB)	Preamp Factor (dB)	Ant Pos (cm)	Table Pos (deg)	Peak Avg. (P/A)	Pol. (H/V)
802.11n HT40 CH 38 5190MHz		5146.85	60.22	-13.78	74	49.62	34.61	11.21	35.22	200	63	P	H
		5150	51.95	-2.05	54	41.35	34.61	11.21	35.22	200	63	A	H
	*	5190	101.16	-	-	90.47	34.66	11.25	35.22	200	63	P	H
	*	5190	91.58	-	-	80.89	34.66	11.25	35.22	200	63	A	H
		5389.71	50.74	-23.26	74	39.14	34.94	11.89	35.23	200	63	P	H
		5444.16	42.04	-11.96	54	30.38	35.01	11.89	35.24	200	63	A	H
		5147.15	61.68	-12.32	74	51.08	34.61	11.21	35.22	200	306	P	V
		5149.25	52.87	-1.13	54	42.27	34.61	11.21	35.22	200	306	A	V
	*	5190	102.37	-	-	91.68	34.66	11.25	35.22	200	306	P	V
	*	5190	92.03	-	-	81.34	34.66	11.25	35.22	200	306	A	V
		5420.84	50.1	-23.9	74	38.47	34.98	11.89	35.24	200	306	P	V
		5453.51	41.96	-12.04	54	30.28	35.03	11.89	35.24	200	306	A	V
802.11n HT40 CH 46 5230MHz		5149.85	51.98	-22.02	74	41.38	34.61	11.21	35.22	200	63	P	H
		5127.05	43.8	-10.2	54	33.25	34.59	11.18	35.22	200	63	A	H
	*	5230	105.19	-	-	94.3	34.73	11.38	35.22	200	63	P	H
	*	5230	95.1	-	-	84.21	34.73	11.38	35.22	200	63	A	H
		5351.32	50.6	-23.4	74	39.18	34.89	11.76	35.23	200	63	P	H
		5422.16	42.17	-11.83	54	30.54	34.98	11.89	35.24	200	63	A	H
		5127.5	52.68	-21.32	74	42.13	34.59	11.18	35.22	200	306	P	V
		5127.65	44.42	-9.58	54	33.87	34.59	11.18	35.22	200	306	A	V
	*	5230	104.94	-	-	94.05	34.73	11.38	35.22	200	306	P	V
	*	5230	95.05	-	-	84.16	34.73	11.38	35.22	200	306	A	V
	5454.5	50.61	-23.39	74	38.93	35.03	11.89	35.24	200	306	P	V	
	5443.39	42.25	-11.75	54	30.59	35.01	11.89	35.24	200	306	A	V	
Remark	1. No other spurious found. 2. All results are PASS against Peak and Average limit line.												



Band 1 5150~5250MHz

WIFI 802.11n HT40 (Harmonic @ 3m)

WIFI Ant. 1	Note	Frequency (MHz)	Level (dBμV/m)	Over Limit (dB)	Limit Line (dBμV/m)	Read Level (dBμV)	Antenna Factor (dB/m)	Cable Loss (dB)	Preamp Factor (dB)	Ant Pos (cm)	Table Pos (deg)	Peak Avg. (P/A)	Pol. (H/V)
802.11n HT40 CH 38 5190MHz		10380	43.44	-30.56	74	48.93	37.23	17.17	59.89	100	0	P	H
		15570	44.15	-29.85	74	42	40.38	19.63	57.86	100	0	P	H
													H
													H
		10380	42.88	-31.12	74	48.37	37.23	17.17	59.89	100	0	P	V
		15570	42.87	-31.13	74	40.72	40.38	19.63	57.86	100	0	P	V
													V
													V
802.11n HT40 CH 46 5230MHz		10460	42.89	-31.11	74	48.29	37.27	17.17	59.84	200	0	P	H
		15690	43.61	-30.39	74	41.17	40.53	19.7	57.79	100	0	P	H
													H
													H
		10460	43.37	-30.63	74	48.77	37.27	17.17	59.84	200	0	P	V
		15690	43.98	-30.02	74	41.54	40.53	19.7	57.79	100	0	P	V
													V
													V
Remark	1. No other spurious found. 2. All results are PASS against Peak and Average limit line.												



Band 2 - 5250~5350MHz

WIFI 802.11a (Band Edge @ 3m)

WIFI	Note	Frequency	Level	Over	Limit	Read	Antenna	Cable	Preamp	Ant	Table	Peak	Pol.
Ant.				Limit	Line	Level	Factor	Loss	Factor	Pos	Pos	Avg.	
1		(MHz)	(dBμV/m)	(dB)	(dBμV/m)	(dBμV)	(dB/m)	(dB)	(dB)	(cm)	(deg)	(P/A)	(H/V)
802.11a CH 52 5260MHz		5020.7	50.01	-23.99	74	39.66	34.45	11.11	35.21	200	61	P	H
		5145.2	40.56	-13.44	54	29.96	34.61	11.21	35.22	200	61	A	H
	*	5260	109.86	-	-	98.94	34.77	11.38	35.23	200	61	P	H
	*	5260	101.37	-	-	90.45	34.77	11.38	35.23	200	61	A	H
		5409.07	50.58	-23.42	74	38.97	34.96	11.89	35.24	200	61	P	H
		5445.7	41.26	-12.74	54	29.58	35.03	11.89	35.24	200	61	A	H
		5035.25	49.88	-24.12	74	39.53	34.45	11.11	35.21	181	86	P	V
		5105	40.44	-13.56	54	29.94	34.54	11.18	35.22	181	86	A	V
	*	5260	106.16	-	-	95.24	34.77	11.38	35.23	181	86	P	V
	*	5260	98.5	-	-	87.58	34.77	11.38	35.23	181	86	A	V
		5413.25	50.37	-23.63	74	38.74	34.98	11.89	35.24	181	86	P	V
		5452.85	41.1	-12.9	54	29.42	35.03	11.89	35.24	181	86	A	V
802.11a CH 60 5300MHz		5047.1	49.5	-24.5	74	39.13	34.47	11.11	35.21	197	61	P	H
		5080.7	40.39	-13.61	54	29.94	34.52	11.14	35.21	197	61	A	H
	*	5300	110.25	-	-	99.15	34.82	11.51	35.23	197	61	P	H
	*	5300	101.87	-	-	90.77	34.82	11.51	35.23	197	61	A	H
		5352.31	57.06	-16.94	74	45.64	34.89	11.76	35.23	197	61	P	H
		5352.2	49.09	-4.91	54	37.67	34.89	11.76	35.23	197	61	A	H
		5068.1	49.62	-24.38	74	39.2	34.49	11.14	35.21	185	86	P	V
		5097.35	40.41	-13.59	54	29.95	34.54	11.14	35.22	185	86	A	V
	*	5300	107.63	-	-	96.53	34.82	11.51	35.23	185	86	P	V
	*	5300	99.06	-	-	87.96	34.82	11.51	35.23	185	86	A	V
		5352.97	54.36	-19.64	74	42.94	34.89	11.76	35.23	185	86	P	V
		5352.31	46.47	-7.53	54	35.05	34.89	11.76	35.23	185	86	A	V



802.11a CH 64 5320MHz	*	5320	110.28	-	-	99.04	34.84	11.63	35.23	200	60	P	H
	*	5320	102.24	-	-	91	34.84	11.63	35.23	200	60	A	H
		5350.88	62.66	-11.34	74	51.24	34.89	11.76	35.23	200	60	P	H
		5350	51.93	-2.07	54	40.51	34.89	11.76	35.23	200	60	A	H
													H
													H
	*	5320	107.56	-	-	96.32	34.84	11.63	35.23	204	86	P	V
	*	5320	98.57	-	-	87.33	34.84	11.63	35.23	204	86	A	V
		5351.43	58.7	-15.3	74	47.28	34.89	11.76	35.23	204	86	P	V
		5351.32	48.18	-5.82	54	36.76	34.89	11.76	35.23	204	86	A	V
													V
													V
Remark	1. No other spurious found. 2. All results are PASS against Peak and Average limit line.												



Band 2 5250~5350MHz

WIFI 802.11a (Harmonic @ 3m)

WIFI Ant. 1	Note	Frequency (MHz)	Level (dBμV/m)	Over Limit (dB)	Limit Line (dBμV/m)	Read Level (dBμV)	Antenna Factor (dB/m)	Cable Loss (dB)	Preamp Factor (dB)	Ant Pos (cm)	Table Pos (deg)	Peak Avg. (P/A)	Pol. (H/V)
802.11a CH 52 5260MHz		10520	41.9	-32.1	74	47.19	37.32	17.17	59.78	100	0	P	H
		15780	42.39	-31.61	74	39.74	40.63	19.75	57.73	100	0	P	H
													H
													H
		10520	42.72	-31.28	74	48.01	37.32	17.17	59.78	100	0	P	V
		15780	43.3	-30.7	74	40.65	40.63	19.75	57.73	100	0	P	V
													V
													V
802.11a CH 60 5300MHz		10600	42.01	-31.99	74	47.08	37.42	17.17	59.66	100	0	P	H
		15900	44.13	-29.87	74	41.19	40.78	19.82	57.66	100	0	P	H
													H
													H
		10600	41.98	-32.02	74	47.05	37.42	17.17	59.66	100	0	P	V
		15900	42.59	-31.41	74	39.65	40.78	19.82	57.66	100	0	P	V
													V
													V
802.11a CH 64 5320MHz		10640	41.17	-32.83	74	46.14	37.47	17.17	59.61	100	0	P	H
		15960	44.21	-29.79	74	41.1	40.86	19.87	57.62	100	0	P	H
													H
													H
		10640	42.33	-31.67	74	47.3	37.47	17.17	59.61	100	0	P	V
		15960	42.61	-31.39	74	39.5	40.86	19.87	57.62	100	0	P	V
													V
													V
Remark	1. No other spurious found. 2. All results are PASS against Peak and Average limit line.												



Band 2 5250~5350MHz

WIFI 802.11n HT20 (Band Edge @ 3m)

WIFI Ant. 1	Note	Frequency (MHz)	Level (dBμV/m)	Over Limit (dB)	Limit Line (dBμV/m)	Read Level (dBμV)	Antenna Factor (dB/m)	Cable Loss (dB)	Preamp Factor (dB)	Ant Pos (cm)	Table Pos (deg)	Peak Avg. (P/A)	Pol. (H/V)
802.11n HT20 CH 52 5260MHz		5132.3	50.35	-23.65	74	39.8	34.59	11.18	35.22	200	61	P	H
		5107.25	40.61	-13.39	54	30.09	34.56	11.18	35.22	200	61	A	H
	*	5260	108.25	-	-	97.33	34.77	11.38	35.23	200	61	P	H
	*	5260	97.67	-	-	86.75	34.77	11.38	35.23	200	61	A	H
		5407.53	50.56	-23.44	74	38.95	34.96	11.89	35.24	200	61	P	H
		5455.93	41.49	-12.51	54	29.81	35.03	11.89	35.24	200	61	A	H
		5071.55	50.67	-23.33	74	40.22	34.52	11.14	35.21	200	306	P	V
		5148.35	40.79	-13.21	54	30.19	34.61	11.21	35.22	200	306	A	V
	*	5260	108.49	-	-	97.57	34.77	11.38	35.23	200	306	P	V
	*	5260	97.79	-	-	86.87	34.77	11.38	35.23	200	306	A	V
		5405	50.82	-23.18	74	39.21	34.96	11.89	35.24	200	306	P	V
		5456.7	41.1	-12.9	54	29.42	35.03	11.89	35.24	200	306	A	V
802.11n HT20 CH 60 5300MHz		5087.45	49.41	-24.59	74	38.96	34.52	11.14	35.21	187	297	P	H
		5134.55	40.51	-13.49	54	29.96	34.59	11.18	35.22	187	297	A	H
	*	5300	107.72	-	-	96.62	34.82	11.51	35.23	187	297	P	H
	*	5300	96.49	-	-	85.39	34.82	11.51	35.23	187	297	A	H
		5351.76	54.86	-19.14	74	43.44	34.89	11.76	35.23	187	297	P	H
		5351.65	47.9	-6.1	54	36.48	34.89	11.76	35.23	187	297	A	H
		5135.9	49.67	-24.33	74	39.12	34.59	11.18	35.22	200	305	P	V
		5145.5	40.69	-13.31	54	30.09	34.61	11.21	35.22	200	305	A	V
	*	5300	108.97	-	-	97.87	34.82	11.51	35.23	200	305	P	V
	*	5300	98.95	-	-	87.85	34.82	11.51	35.23	200	305	A	V
	5351.54	55.86	-18.14	74	44.44	34.89	11.76	35.23	200	305	P	V	
	5351.65	48.36	-5.64	54	36.94	34.89	11.76	35.23	200	305	A	V	



802.11n HT20 CH 64 5320MHz	*	5320	108.52	-	-	97.28	34.84	11.63	35.23	200	62	P	H
	*	5320	98.56	-	-	87.32	34.84	11.63	35.23	200	62	A	H
		5350.55	64.05	-9.95	74	52.63	34.89	11.76	35.23	200	62	P	H
		5350	51.74	-2.26	54	40.32	34.89	11.76	35.23	200	62	A	H
													H
													H
	*	5320	107.41	-	-	96.17	34.84	11.63	35.23	200	306	P	V
	*	5320	97.23	-	-	85.99	34.84	11.63	35.23	200	306	A	V
		5350.66	61.06	-12.94	74	49.64	34.89	11.76	35.23	200	306	P	V
		5350.11	49.48	-4.52	54	38.06	34.89	11.76	35.23	200	306	A	V
													V
													V
Remark	1. No other spurious found. 2. All results are PASS against Peak and Average limit line.												



Band 2 5250~5350MHz

WIFI 802.11n HT20 (Harmonic @ 3m)

WIFI Ant. 1	Note	Frequency (MHz)	Level (dBμV/m)	Over Limit (dB)	Limit Line (dBμV/m)	Read Level (dBμV)	Antenna Factor (dB/m)	Cable Loss (dB)	Preamp Factor (dB)	Ant Pos (cm)	Table Pos (deg)	Peak Avg. (P/A)	Pol. (H/V)
802.11n HT20 CH 52 5260MHz		10520	43.86	-30.14	74	49.15	37.32	17.17	59.78	100	0	P	H
		15780	42.67	-31.33	74	40.02	40.63	19.75	57.73	100	0	P	H
													H
													H
		10520	44.25	-29.75	74	49.54	37.32	17.17	59.78	100	0	P	V
		15780	42.23	-31.77	74	39.58	40.63	19.75	57.73	100	0	P	V
													V
802.11n HT20 CH 60 5300MHz		10600	43.29	-30.71	74	48.36	37.42	17.17	59.66	100	0	P	H
		15900	42.95	-31.05	74	40.01	40.78	19.82	57.66	100	0	P	H
													H
													H
		10600	43.01	-30.99	74	48.08	37.42	17.17	59.66	100	0	P	V
		15900	44.83	-29.17	74	41.89	40.78	19.82	57.66	100	0	P	V
													V
802.11n HT20 CH 64 5320MHz		10640	43.64	-30.36	74	48.61	37.47	17.17	59.61	100	0	P	H
		15960	42.14	-31.86	74	39.03	40.86	19.87	57.62	100	0	P	H
													H
													H
		10640	43.84	-30.16	74	48.81	37.47	17.17	59.61	100	0	P	V
		15960	42.74	-31.26	74	39.63	40.86	19.87	57.62	100	0	P	V
													V
Remark	1. No other spurious found.												
	2. All results are PASS against Peak and Average limit line.												



Band 2 5250~5350MHz

WIFI 802.11n HT40 (Band Edge @ 3m)

WIFI Ant. 1	Note	Frequency (MHz)	Level (dBμV/m)	Over Limit (dB)	Limit Line (dBμV/m)	Read Level (dBμV)	Antenna Factor (dB/m)	Cable Loss (dB)	Preamp Factor (dB)	Ant Pos (cm)	Table Pos (deg)	Peak Avg. (P/A)	Pol. (H/V)	
802.11n HT40 CH 54 5270MHz		5114.15	49.37	-24.63	74	38.85	34.56	11.18	35.22	200	60	P	H	
		5083.4	41.44	-12.56	54	30.99	34.52	11.14	35.21	200	60	A	H	
	*	5270	103.4	-	-	92.35	34.77	11.51	35.23	200	60	P	H	
	*	5270	95.27	-	-	84.22	34.77	11.51	35.23	200	60	A	H	
		5371.56	49.78	-24.22	74	38.34	34.91	11.76	35.23	200	60	P	H	
		5373.21	42.7	-11.3	54	31.26	34.91	11.76	35.23	200	60	A	H	
		5139.95	49.52	-24.48	74	38.95	34.61	11.18	35.22	200	303	P	V	
		5097.05	41.43	-12.57	54	30.97	34.54	11.14	35.22	200	303	A	V	
	*	5270	102.93	-	-	91.88	34.77	11.51	35.23	200	303	P	V	
	*	5270	94.16	-	-	83.11	34.77	11.51	35.23	200	303	A	V	
		5354.95	50.11	-23.89	74	38.69	34.89	11.76	35.23	200	303	P	V	
		5374.53	41.68	-12.32	54	30.24	34.91	11.76	35.23	200	303	A	V	
	802.11n HT40 CH 62 5310MHz		5110.55	50.41	-23.59	74	39.89	34.56	11.18	35.22	200	61	P	H
			5083.85	41.28	-12.72	54	30.83	34.52	11.14	35.21	200	61	A	H
*		5310	102	-	-	90.76	34.84	11.63	35.23	200	61	P	H	
*		5310	93.39	-	-	82.15	34.84	11.63	35.23	200	61	A	H	
		5353.19	61.23	-12.77	74	49.81	34.89	11.76	35.23	200	61	P	H	
		5350	53.06	-0.94	54	41.64	34.89	11.76	35.23	200	61	A	H	
		5003.6	50.05	-23.95	74	39.77	34.42	11.07	35.21	200	317	P	V	
		5075.9	41.34	-12.66	54	30.89	34.52	11.14	35.21	200	317	A	V	
*		5310	99.95	-	-	88.71	34.84	11.63	35.23	200	317	P	V	
*		5310	91.19	-	-	79.95	34.84	11.63	35.23	200	317	A	V	
	5350.22	58.13	-15.87	74	46.71	34.89	11.76	35.23	200	317	P	V		
	5350	50.31	-3.69	54	38.89	34.89	11.76	35.23	200	317	A	V		
Remark	1. No other spurious found. 2. All results are PASS against Peak and Average limit line.													



Band 2 5250~5350MHz

WIFI 802.11n HT40 (Harmonic @ 3m)

WIFI Ant. 1	Note	Frequency (MHz)	Level (dBμV/m)	Over Limit (dB)	Limit Line (dBμV/m)	Read Level (dBμV)	Antenna Factor (dB/m)	Cable Loss (dB)	Preamp Factor (dB)	Ant Pos (cm)	Table Pos (deg)	Peak Avg. (P/A)	Pol. (H/V)
802.11n HT40 CH 54 5270MHz		10540	43.66	-30.34	74	48.9	37.34	17.17	59.75	100	0	P	H
		15810	43.72	-30.28	74	40.99	40.67	19.77	57.71	100	0	P	H
													H
													H
		10540	43.34	-30.66	74	48.58	37.34	17.17	59.75	100	0	P	V
		15810	42.79	-31.21	74	40.06	40.67	19.77	57.71	100	0	P	V
													V
802.11n HT40 CH 62 5310MHz		10620	42.2	-31.8	74	47.22	37.44	17.17	59.63	380	0	P	H
		15930	43.06	-30.94	74	40.04	40.82	19.84	57.64	100	0	P	H
													H
													H
		10620	43.41	-30.59	74	48.43	37.44	17.17	59.63	380	0	P	V
		15930	43.2	-30.8	74	40.18	40.82	19.84	57.64	100	0	P	V
													V
Remark	1. No other spurious found.												
	2. All results are PASS against Peak and Average limit line.												



Band 3 - 5470~5725MHz

WIFI 802.11a (Band Edge @ 3m)

WIFI	Note	Frequency	Level	Over	Limit	Read	Antenna	Cable	Preamp	Ant	Table	Peak	Pol.	
Ant.				Limit	Line	Level	Factor	Loss	Factor	Pos	Pos	Avg.		
1		(MHz)	(dBμV/m)	(dB)	(dBμV/m)	(dBμV)	(dB/m)	(dB)	(dB)	(cm)	(deg)	(P/A)	(H/V)	
802.11a CH 100 5500MHz		5468.88	63.7	-10.3	74	52	35.05	11.89	35.24	200	64	P	H	
		5470	52.53	-1.47	54	40.83	35.05	11.89	35.24	200	64	A	H	
	*	5500	112.01	-	-	100.26	35.1	11.89	35.24	200	64	P	H	
	*	5500	104.21	-	-	92.46	35.1	11.89	35.24	200	64	A	H	
													H	
													H	
			5469.36	62.53	-11.47	74	50.83	35.05	11.89	35.24	204	77	P	V
			5469.2	50.6	-3.4	54	38.9	35.05	11.89	35.24	204	77	A	V
	*		5500	110.72	-	-	98.97	35.1	11.89	35.24	204	77	P	V
	*		5500	101.76	-	-	90.01	35.1	11.89	35.24	204	77	A	V
														V
														V
802.11a CH 116 5580MHz		5469.2	50.1	-23.9	74	38.4	35.05	11.89	35.24	196	61	P	H	
		5467.12	41.42	-12.58	54	29.72	35.05	11.89	35.24	196	61	A	H	
	*	5580	114.33	-	-	102.56	35.14	11.89	35.26	196	61	P	H	
	*	5580	104.11	-	-	92.34	35.14	11.89	35.26	196	61	A	H	
			5742.12	51.1	-22.9	74	39.04	35.24	12.11	35.29	196	61	P	H
			5726.92	42.25	-11.75	54	30.24	35.23	12.06	35.28	196	61	A	H
			5460.08	49.73	-24.27	74	38.05	35.03	11.89	35.24	200	83	P	V
			5466.8	41.09	-12.91	54	29.39	35.05	11.89	35.24	200	83	A	V
	*		5580	110.72	-	-	98.95	35.14	11.89	35.26	200	83	P	V
	*		5580	102.51	-	-	90.74	35.14	11.89	35.26	200	83	A	V
			5753.32	51.51	-22.49	74	39.43	35.26	12.11	35.29	200	83	P	V
			5739.24	42.12	-11.88	54	30.11	35.24	12.06	35.29	200	83	A	V



802.11a CH 140 5700MHz	*	5700	110.1	-	-	98.17	35.21	12	35.28	188	61	P	H
	*	5700	101.93	-	-	90	35.21	12	35.28	188	61	A	H
		5727.08	63.76	-10.24	74	51.75	35.23	12.06	35.28	188	61	P	H
		5725.16	52.64	-1.36	54	40.63	35.23	12.06	35.28	188	61	A	H
													H
													H
	*	5700	106.06	-	-	94.13	35.21	12	35.28	201	83	P	V
	*	5700	98.58	-	-	86.65	35.21	12	35.28	201	83	A	V
		5727.24	60.17	-13.83	74	48.16	35.23	12.06	35.28	201	83	P	V
		5725.08	49.37	-4.63	54	37.36	35.23	12.06	35.28	201	83	A	V
													V
													V
Remark	1. No other spurious found. 2. All results are PASS against Peak and Average limit line.												



Band 3 - 5470~5725MHz

WIFI 802.11a (Harmonic @ 3m)

WIFI Ant. 1	Note	Frequency (MHz)	Level (dBµV/m)	Over Limit (dB)	Limit Line (dBµV/m)	Read Level (dBµV)	Antenna Factor (dB/m)	Cable Loss (dB)	Preamp Factor (dB)	Ant Pos (cm)	Table Pos (deg)	Peak Avg. (P/A)	Pol. (H/V)
802.11a CH 100 5500MHz		11000	44.86	-29.14	74	48.89	37.9	17.17	59.1	100	0	P	H
		16500	45.51	-28.49	74	40.68	41.4	20.23	56.8	100	0	P	H
													H
													H
		11000	44.55	-29.45	74	48.58	37.9	17.17	59.1	100	0	P	V
		16500	46.21	-27.79	74	41.38	41.4	20.23	56.8	100	0	P	V
													V
													V
802.11a CH 116 5580MHz		11160	41.81	-32.19	74	45.32	38	17.16	58.67	100	0	P	H
		16740	43.89	-30.11	74	38.23	41.88	20.39	56.61	100	0	P	H
													H
													H
		11160	42.19	-31.81	74	45.7	38	17.16	58.67	100	0	P	V
		16740	44.77	-29.23	74	39.11	41.88	20.39	56.61	100	0	P	V
													V
													V
802.11a CH 140 5700MHz		11400	42.53	-31.47	74	45.29	38.14	17.16	58.06	100	0	P	H
		17100	46.4	-27.6	74	39.89	42.32	20.65	56.46	100	0	P	H
													H
													H
		11400	43.21	-30.79	74	45.97	38.14	17.16	58.06	100	0	P	V
		17100	46.71	-27.29	74	40.2	42.32	20.65	56.46	100	0	P	V
													V
													V
Remark	1. No other spurious found. 2. All results are PASS against Peak and Average limit line.												



Band 3 - 5470~5725MHz

WIFI 802.11n HT20 (Band Edge @ 3m)

WIFI Ant. 1	Note	Frequency (MHz)	Level (dBµV/m)	Over Limit (dB)	Limit Line (dBµV/m)	Read Level (dBµV)	Antenna Factor (dB/m)	Cable Loss (dB)	Preamp Factor (dB)	Ant Pos (cm)	Table Pos (deg)	Peak Avg. (P/A)	Pol. (H/V)	
802.11n HT20 CH 100 5500MHz		5470	63.1	-10.9	74	51.4	35.05	11.89	35.24	200	61	P	H	
		5469.2	52.6	-1.4	54	40.9	35.05	11.89	35.24	200	61	A	H	
	*	5500	111.43	-	-	99.68	35.1	11.89	35.24	200	61	P	H	
	*	5500	101.72	-	-	89.97	35.1	11.89	35.24	200	61	A	H	
													H	
														H
			5468.88	60.29	-13.71	74	48.59	35.05	11.89	35.24	200	77	P	V
			5469.84	49.14	-4.86	54	37.44	35.05	11.89	35.24	200	77	A	V
		*	5500	108.55	-	-	96.8	35.1	11.89	35.24	200	77	P	V
		*	5500	97.8	-	-	86.05	35.1	11.89	35.24	200	77	A	V
													V	
													V	
802.11n HT20 CH 116 5580MHz		5352.4	49.89	-24.11	74	38.47	34.89	11.76	35.23	200	58	P	H	
		5454.64	41.4	-12.6	54	29.72	35.03	11.89	35.24	200	58	A	H	
		* 5580	112.64	-	-	100.87	35.14	11.89	35.26	200	58	P	H	
		* 5580	102.04	-	-	90.27	35.14	11.89	35.26	200	58	A	H	
			5757.88	51.79	-22.21	74	39.72	35.26	12.11	35.3	200	58	P	H
			5746.28	42.33	-11.67	54	30.27	35.24	12.11	35.29	200	58	A	H
			5446.64	50.16	-23.84	74	38.48	35.03	11.89	35.24	200	78	P	V
			5463.12	41.24	-12.76	54	29.54	35.05	11.89	35.24	200	78	A	V
		*	5580	108.98	-	-	97.21	35.14	11.89	35.26	200	78	P	V
		*	5580	98.6	-	-	86.83	35.14	11.89	35.26	200	78	A	V
		5734.44	51.36	-22.64	74	39.36	35.23	12.06	35.29	200	78	P	V	
		5745.08	42.39	-11.61	54	30.33	35.24	12.11	35.29	200	78	A	V	



802.11n HT20 CH 140 5700MHz	*	5700	108.52	-	-	96.59	35.21	12	35.28	200	68	P	H
	*	5700	98.57	-	-	86.64	35.21	12	35.28	200	68	A	H
		5725.24	65.42	-8.58	74	53.41	35.23	12.06	35.28	200	68	P	H
		5725.16	53.69	-0.31	54	41.68	35.23	12.06	35.28	200	68	A	H
													H
													H
	*	5700	104.47	-	-	92.54	35.21	12	35.28	200	84	P	V
	*	5700	94.72	-	-	82.79	35.21	12	35.28	200	84	A	V
		5725.16	59.2	-14.8	74	47.19	35.23	12.06	35.28	200	84	P	V
		5725	50.34	-3.66	54	38.33	35.23	12.06	35.28	200	84	A	V
													V
													V
Remark	1. No other spurious found. 2. All results are PASS against Peak and Average limit line.												



Band 3 - 5470~5725MHz

WIFI 802.11n HT20 (Harmonic @ 3m)

WIFI Ant. 1	Note	Frequency (MHz)	Level (dBμV/m)	Over Limit (dB)	Limit Line (dBμV/m)	Read Level (dBμV)	Antenna Factor (dB/m)	Cable Loss (dB)	Preamp Factor (dB)	Ant Pos (cm)	Table Pos (deg)	Peak Avg. (P/A)	Pol. (H/V)	
802.11n HT20 CH 100 5500MHz		11000	44.57	-29.43	74	48.6	37.9	17.17	59.1	100	0	P	H	
		16500	45.34	-28.66	74	40.51	41.4	20.23	56.8	100	0	P	H	
													H	
													H	
			11000	43.74	-30.26	74	47.77	37.9	17.17	59.1	100	0	P	V
			16500	45.2	-28.8	74	40.37	41.4	20.23	56.8	100	0	P	V
														V
802.11n HT20 CH 116 5580MHz		11160	43.66	-30.34	74	47.17	38	17.16	58.67	100	0	P	H	
		16740	43.8	-30.2	74	38.14	41.88	20.39	56.61	100	0	P	H	
													H	
													H	
			11160	43.58	-30.42	74	47.09	38	17.16	58.67	100	0	P	V
			16740	44.1	-29.9	74	38.44	41.88	20.39	56.61	100	0	P	V
														V
802.11n HT20 CH 140 5700MHz		11400	43.3	-30.7	74	46.06	38.14	17.16	58.06	100	0	P	H	
		17100	46.06	-27.94	74	39.55	42.32	20.65	56.46	100	0	P	H	
													H	
													H	
			11400	43.26	-30.74	74	46.02	38.14	17.16	58.06	100	0	P	V
			17100	47.25	-26.75	74	40.74	42.32	20.65	56.46	100	0	P	V
														V
Remark	1. No other spurious found.													
	2. All results are PASS against Peak and Average limit line.													



Band 3 - 5470~5725MHz

WIFI 802.11n HT40 (Band Edge @ 3m)

WIFI Ant. 1	Note	Frequency (MHz)	Level (dBμV/m)	Over Limit (dB)	Limit Line (dBμV/m)	Read Level (dBμV)	Antenna Factor (dB/m)	Cable Loss (dB)	Preamp Factor (dB)	Ant Pos (cm)	Table Pos (deg)	Peak Avg. (P/A)	Pol. (H/V)
802.11n HT40 CH 102 5510MHz		5468.88	58.96	-15.04	74	47.26	35.05	11.89	35.24	200	65	P	H
		5470	53.06	-0.94	54	41.36	35.05	11.89	35.24	200	65	A	H
	*	5510	104.52	-	-	92.78	35.1	11.89	35.25	200	65	P	H
	*	5510	95.81	-	-	84.07	35.1	11.89	35.25	200	65	A	H
		5764.52	50.08	-23.92	74	38.01	35.26	12.11	35.3	200	65	P	H
		5761.48	42.12	-11.88	54	30.05	35.26	12.11	35.3	200	65	A	H
		5466.64	57.15	-16.85	74	45.45	35.05	11.89	35.24	200	80	P	V
		5469.04	50.32	-3.68	54	38.62	35.05	11.89	35.24	200	80	A	V
	*	5510	102.03	-	-	90.29	35.1	11.89	35.25	200	80	P	V
	*	5510	93.04	-	-	81.3	35.1	11.89	35.25	200	80	A	V
		5743	50.28	-23.72	74	38.22	35.24	12.11	35.29	200	80	P	V
		5725.4	42.06	-11.94	54	30.05	35.23	12.06	35.28	200	80	A	V
802.11n HT40 CH 110 5550MHz		5464.08	50.71	-23.29	74	39.01	35.05	11.89	35.24	200	67	P	H
		5469.84	44.03	-9.97	54	32.33	35.05	11.89	35.24	200	67	A	H
	*	5550	108.41	-	-	96.64	35.13	11.89	35.25	200	67	P	H
	*	5550	99.92	-	-	88.15	35.13	11.89	35.25	200	67	A	H
		5745.96	50.84	-23.16	74	38.78	35.24	12.11	35.29	200	67	P	H
		5749.72	42	-12	54	29.94	35.24	12.11	35.29	200	67	A	H
		5445.36	49.9	-24.1	74	38.24	35.01	11.89	35.24	200	79	P	V
		5469.2	42.96	-11.04	54	31.26	35.05	11.89	35.24	200	79	A	V
	*	5550	105.58	-	-	93.81	35.13	11.89	35.25	200	79	P	V
	*	5550	96.62	-	-	84.85	35.13	11.89	35.25	200	79	A	V
	5731.72	49.63	-24.37	74	37.63	35.23	12.06	35.29	200	79	P	V	
	5754.04	41.95	-12.05	54	29.87	35.26	12.11	35.29	200	79	A	V	



802.11n HT40 CH 134 5670MHz		5460.4	48.88	-25.12	74	37.2	35.03	11.89	35.24	200	65	P	H
		5467.44	41.31	-12.69	54	29.61	35.05	11.89	35.24	200	65	A	H
	*	5670	108.21	-	-	96.29	35.2	12	35.28	200	65	P	H
	*	5670	100.25	-	-	88.33	35.2	12	35.28	200	65	A	H
		5727.16	60.66	-13.34	74	48.65	35.23	12.06	35.28	200	65	P	H
		5725.4	52.15	-1.85	54	40.14	35.23	12.06	35.28	200	65	A	H
		5409.52	49.22	-24.78	74	37.61	34.96	11.89	35.24	200	88	P	V
		5469.36	41.27	-12.73	54	29.57	35.05	11.89	35.24	200	88	A	V
	*	5670	105.18	-	-	93.26	35.2	12	35.28	200	88	P	V
	*	5670	96.18	-	-	84.26	35.2	12	35.28	200	88	A	V
		5725.48	56.81	-17.19	74	44.8	35.23	12.06	35.28	200	88	P	V
		5725.16	48.54	-5.46	54	36.53	35.23	12.06	35.28	200	88	A	V
Remark	1. No other spurious found. 2. All results are PASS against Peak and Average limit line.												



Band 3 - 5470~5725MHz

WIFI 802.11n HT40 (Harmonic @ 3m)

WIFI Ant. 1	Note	Frequency (MHz)	Level (dBμV/m)	Over Limit (dB)	Limit Line (dBμV/m)	Read Level (dBμV)	Antenna Factor (dB/m)	Cable Loss (dB)	Preamp Factor (dB)	Ant Pos (cm)	Table Pos (deg)	Peak Avg. (P/A)	Pol. (H/V)
802.11n HT40 CH 102 5510MHz		11020	43.98	-30.02	74	47.96	37.91	17.17	59.06	100	0	P	H
		16530	45.42	-28.58	74	40.47	41.47	20.25	56.77	100	0	P	H
													H
													H
		11020	43.58	-30.42	74	47.56	37.91	17.17	59.06	100	0	P	V
		16530	43.98	-30.02	74	39.03	41.47	20.25	56.77	100	0	P	V
													V
802.11n HT40 CH 110 5550MHz		11100	43.02	-30.98	74	46.74	37.96	17.16	58.84	100	0	P	H
		16650	44.86	-29.14	74	39.49	41.71	20.34	56.68	100	0	P	H
													H
													H
		11100	42.22	-31.78	74	45.94	37.96	17.16	58.84	100	0	P	V
		16650	46.21	-27.79	74	40.84	41.71	20.34	56.68	100	0	P	V
													V
802.11n HT40 CH 134 5670MHz		11340	42.71	-31.29	74	45.68	38.1	17.16	58.23	100	0	P	H
		17010	46.16	-27.84	74	39.59	42.39	20.59	56.41	100	0	P	H
													H
													H
		11340	42.62	-31.38	74	45.59	38.1	17.16	58.23	100	0	P	V
		17010	46.76	-27.24	74	40.19	42.39	20.59	56.41	100	0	P	V
													V
Remark	1. No other spurious found.												
	2. All results are PASS against Peak and Average limit line.												



Emission below 1GHz

WIFI 802.11n HT20 (LF @ 3m)

WIFI	Note	Frequency	Level	Over	Limit	Read	Antenna	Cable	Preamp	Ant	Table	Peak	Pol.	
Ant.				Limit	Line	Level	Factor	Loss	Factor	Pos	Pos	Avg.		
1		(MHz)	(dBμV/m)	(dB)	(dBμV/m)	(dBμV)	(dB/m)	(dB)	(dB)	(cm)	(deg)	(P/A)	(H/V)	
802.11n HT20 LF		30.81	27.44	-12.56	40	32.37	25.46	1.07	31.46			P	H	
		195.51	36.43	-7.07	43.5	49.86	15.8	1.87	31.1	100	0	P	H	
		220.08	30.66	-15.34	46	43.19	16.4	2.07	31			P	H	
		871.2	32.65	-13.35	46	30.01	28.83	4.17	30.36			P	H	
		920.9	32.98	-13.02	46	29.71	29.49	4.12	30.34			P	H	
		938.4	33.65	-12.35	46	29.99	29.92	4.12	30.38			P	H	
														H
														H
														H
														H
														H
														H
			50.79	31.45	-8.55	40	46.48	15.1	1.07	31.2	100	0	P	V
			98.85	31.03	-12.47	43.5	44.58	16.27	1.28	31.1			P	V
			278.94	26.16	-19.84	46	35.45	19.31	2.32	30.92			P	V
			881	32.49	-13.51	46	29.78	28.88	4.17	30.34			P	V
			911.8	32.94	-13.06	46	29.86	29.28	4.12	30.32			P	V
			932.1	33.56	-12.44	46	30.02	29.78	4.12	30.36			P	V
														V
														V
													V	
													V	
													V	
													V	
Remark	1. No other spurious found. 2. All results are PASS against limit line.													



Note symbol

*	Fundamental Frequency which can be ignored. However, the level of any unwanted emissions shall not exceed the level of the fundamental frequency.
!	Test result is over limit line.
P/A	Peak or Average
H/V	Horizontal or Vertical



A calculation example for radiated spurious emission is shown as below:

WIFI	Note	Frequency	Level	Over	Limit	Read	Antenna	Cable	Preamp	Ant	Table	Peak	Pol.
Ant.				Limit	Line	Level	Factor	Loss	Factor	Pos	Pos	Avg.	
1		(MHz)	(dBμV/m)	(dB)	(dBμV/m)	(dBμV)	(dB/m)	(dB)	(dB)	(cm)	(deg)	(P/A)	(H/V)
802.11b		2390	55.45	-18.55	74	54.51	32.22	4.58	35.86	103	308	P	H
CH 01													
2412MHz		2390	43.54	-10.46	54	42.6	32.22	4.58	35.86	103	308	A	H

- 1. Level(dBμV/m) =
Antenna Factor(dB/m) + Cable Loss(dB) + Read Level(dBμV) - Preamp Factor(dB)
- 2. Over Limit(dB) = Level(dBμV/m) – Limit Line(dBμV/m)

For Peak Limit @ 2390MHz:

- 1. Level(dBμV/m)
= Antenna Factor(dB/m) + Cable Loss(dB) + Read Level(dBμV) - Preamp Factor(dB)
= 32.22(dB/m) + 4.58(dB) + 54.51(dBμV) – 35.86 (dB)
= 55.45 (dBμV/m)
- 2. Over Limit(dB)
= Level(dBμV/m) – Limit Line(dBμV/m)
= 55.45(dBμV/m) – 74(dBμV/m)
= -18.55(dB)

For Average Limit @ 2390MHz:

- 1. Level(dBμV/m)
= Antenna Factor(dB/m) + Cable Loss(dB) + Read Level(dBμV) - Preamp Factor(dB)
= 32.22(dB/m) + 4.58(dB) + 42.6(dBμV) – 35.86 (dB)
= 43.54 (dBμV/m)
- 2. Over Limit(dB)
= Level(dBμV/m) – Limit Line(dBμV/m)
= 43.54(dBμV/m) – 54(dBμV/m)
= -10.46(dB)

Both peak and average measured complies with the limit line, so test result is “PASS”.



Appendix C. Radiated Spurious Emission

Test Engineer :	James Chiu, Jesse Wang, and Ken Wu	Temperature :	21~24°C
		Relative Humidity :	50~54%

Band 1 - 5150~5250MHz
WIFI 802.11a (Band Edge @ 3m)

WIFI	Band 1 5150~5250MHz Band Edge @ 3m	
ANT	802.11a CH36 5180MHz	
1	Horizontal	Vertical
Peak	<p>Site : 03CH07-HY Condition : FCC CLASS-B 3m HF-ANT_130629 HORIZONTAL RBW: 1000.000kHz VBW: 3000.000kHz SVWT: Auto Detector : Peak</p>	<p>Site : 03CH07-HY Condition : FCC CLASS-B 3m HF-ANT_130629 VERTICAL RBW: 1000.000kHz VBW: 3000.000kHz SVWT: Auto Detector : Peak</p>



<p>Avg.</p>	<p>Site : 03CH07-HY Condition : FCC CLASS-B (AVG) 3m HF-ANT_130829 HORIZONTAL Sweep : 1000.000kHz VIEW:1.000kHz SWIT:Auto Detector : Peak</p>	<p>Site : 03CH07-HY Condition : FCC CLASS-B (AVG) 3m HF-ANT_130829 VERTICAL Sweep : 1000.000kHz VIEW:1.000kHz SWIT:Auto Detector : Peak</p>
-------------	---	---



WIFI	Band 1 5150~5250MHz Band Edge @ 3m	
ANT	802.11a CH44 5220MHz - L	
1	Horizontal	Vertical
Peak	<p>Site : 03CH07.HY Condition : FCC CLASS-B 3m HF-ANT_130829 HORIZONTAL Detector : Peak</p>	<p>Site : 03CH07.HY Condition : FCC CLASS-B 3m HF-ANT_130829 VERTICAL Detector : Peak</p>
Avg.	<p>Site : 03CH07.HY Condition : FCC CLASS-B (AVG) 3m HF-ANT_130829 HORIZONTAL Detector : Peak</p>	<p>Site : 03CH07.HY Condition : FCC CLASS-B (AVG) 3m HF-ANT_130829 VERTICAL Detector : Peak</p>



WIFI	Band 1 5150~5250MHz Band Edge @ 3m	
ANT	802.11a CH44 5220MHz - R	
1	Horizontal	Vertical
Peak	<p>Date: 2016-03-01</p> <p>Site : 03CH07-HY Condition : FCC CLASS-B 3m HF-ANT_130829 HORIZONTAL RBW: 1000.000kHz VBW: 3000.000kHz SWT: Auto Detector : Peak</p>	<p>Date: 2016-03-01</p> <p>Site : 03CH07-HY Condition : FCC CLASS-B 3m HF-ANT_130829 VERTICAL RBW: 1000.000kHz VBW: 3000.000kHz SWT: Auto Detector : Peak</p>
Avg.	<p>Date: 2016-03-01</p> <p>Site : 03CH07-HY Condition : FCC CLASS-B (AVG) 3m HF-ANT_130829 HORIZONTAL RBW: 1000.000kHz VBW: 1.000kHz SWT: Auto Detector : Peak</p>	<p>Date: 2016-03-01</p> <p>Site : 03CH07-HY Condition : FCC CLASS-B (AVG) 3m HF-ANT_130829 VERTICAL RBW: 1000.000kHz VBW: 1.000kHz SWT: Auto Detector : Peak</p>



WIFI	Band 1 5150~5250MHz Band Edge @ 3m	
ANT	802.11a CH48 5240MHz - L	
1	Horizontal	Vertical
Peak	<p>Site : 03CH07.HY Condition : FCC CLASS-B 3m HF-ANT_130829 HORIZONTAL RBW:1000.000kHz VBW:3000.000kHz SWT:Auto Detector : Peak</p>	<p>Site : 03CH07.HY Condition : FCC CLASS-B 3m HF-ANT_130829 VERTICAL RBW:1000.000kHz VBW:3000.000kHz SWT:Auto Detector : Peak</p>
Avg.	<p>Site : 03CH07.HY Condition : FCC CLASS-B (AVG) 3m HF-ANT_130829 HORIZONTAL RBW:1000.000kHz VBW:1.000kHz SWT:Auto Detector : Peak</p>	<p>Site : 03CH07.HY Condition : FCC CLASS-B (AVG) 3m HF-ANT_130829 VERTICAL RBW:1000.000kHz VBW:1.000kHz SWT:Auto Detector : Peak</p>



WIFI	Band 1 5150~5250MHz Band Edge @ 3m	
ANT	802.11a CH48 5240MHz - R	
1	Horizontal	Vertical
Peak	<p>Site : 03CH07-HY Condition : FCC CLASS-B 3m HF-ANT_130829 HORIZONTAL RBW:1000.000kHz VBW:3000.000kHz SWT:Auto Detector : Peak</p>	<p>Site : 03CH07-HY Condition : FCC CLASS-B 3m HF-ANT_130829 VERTICAL RBW:1000.000kHz VBW:3000.000kHz SWT:Auto Detector : Peak</p>
Avg.	<p>Site : 03CH07-HY Condition : FCC CLASS-B (AVG) 3m HF-ANT_130829 HORIZONTAL RBW:1000.000kHz VBW:1.000kHz SWT:Auto Detector : Peak</p>	<p>Site : 03CH07-HY Condition : FCC CLASS-B (AVG) 3m HF-ANT_130829 VERTICAL RBW:1000.000kHz VBW:1.000kHz SWT:Auto Detector : Peak</p>



Band 1 5150~5250MHz
WIFI 802.11n HT20 (Band Edge @ 3m)

Table with 4 columns: WIFI, ANT, 1, and two sub-columns for Horizontal and Vertical. Rows are labeled 'Peak' and 'Avg.' containing spectral plots and technical details.

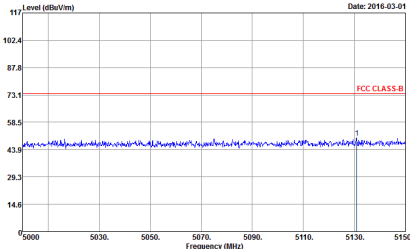
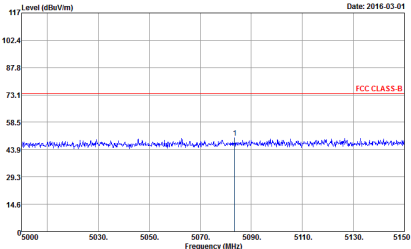
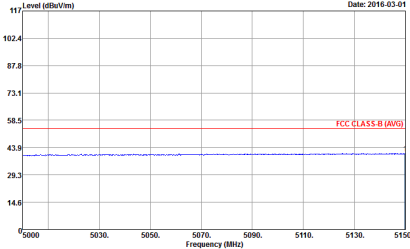
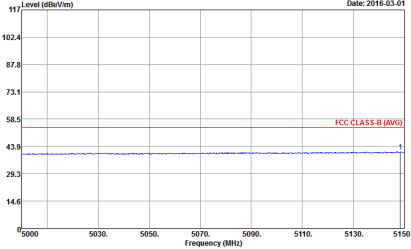

WIFI	Band 1 5150~5250MHz Band Edge @ 3m	
ANT	802.11n HT20 CH44 5220MHz - L	
1	Horizontal	Vertical
Peak	 <p>Site : 03CH07.HY Condition : FCC CLASS-B 3m HF-ANT_130829 HORIZONTAL RBW:1000.000kHz VBW:3000.000kHz SWT:Auto Detector : Peak</p>	 <p>Site : 03CH07.HY Condition : FCC CLASS-B 3m HF-ANT_130829 VERTICAL RBW:1000.000kHz VBW:3000.000kHz SWT:Auto Detector : Peak</p>
Avg.	 <p>Site : 03CH07.HY Condition : FCC CLASS-B (AVG) 3m HF-ANT_130829 HORIZONTAL RBW:1000.000kHz VBW:1.000kHz SWT:Auto Detector : Peak</p>	 <p>Site : 03CH07.HY Condition : FCC CLASS-B (AVG) 3m HF-ANT_130829 VERTICAL RBW:1000.000kHz VBW:1.000kHz SWT:Auto Detector : Peak</p>



WIFI	Band 1 5150~5250MHz Band Edge @ 3m	
ANT	802.11n HT20 CH44 5220MHz - R	
1	Horizontal	Vertical
Peak	<p>Site : 03CH07.HY Condition : FCC CLASS-B 3m HF-ANT_130829 HORIZONTAL RBW: 1000.000kHz VBW:3000.000kHz SWT:Auto Detector : Peak</p>	<p>Site : 03CH07.HY Condition : FCC CLASS-B 3m HF-ANT_130829 VERTICAL RBW: 1000.000kHz VBW:3000.000kHz SWT:Auto Detector : Peak</p>
Avg.	<p>Site : 03CH07.HY Condition : FCC CLASS-B (AVG) 3m HF-ANT_130829 HORIZONTAL RBW: 1000.000kHz VBW:1.000kHz SWT:Auto Detector : Peak</p>	<p>Site : 03CH07.HY Condition : FCC CLASS-B (AVG) 3m HF-ANT_130829 VERTICAL RBW: 1000.000kHz VBW:1.000kHz SWT:Auto Detector : Peak</p>



WIFI	Band 1 5150~5250MHz Band Edge @ 3m	
ANT	802.11n HT20 CH48 5240MHz - L	
1	Horizontal	Vertical
Peak	<p>Site : 03CH07.HY Condition : FCC CLASS-B 3m HF-ANT_130829 HORIZONTAL RBW: 1000.000kHz VBW: 3000.000kHz SWT: Auto Detector : Peak</p>	<p>Site : 03CH07.HY Condition : FCC CLASS-B 3m HF-ANT_130829 VERTICAL RBW: 1000.000kHz VBW: 3000.000kHz SWT: Auto Detector : Peak</p>
Avg.	<p>Site : 03CH07.HY Condition : FCC CLASS-B (AVG) 3m HF-ANT_130829 HORIZONTAL RBW: 1000.000kHz VBW: 1.000kHz SWT: Auto Detector : Peak</p>	<p>Site : 03CH07.HY Condition : FCC CLASS-B (AVG) 3m HF-ANT_130829 VERTICAL RBW: 1000.000kHz VBW: 1.000kHz SWT: Auto Detector : Peak</p>

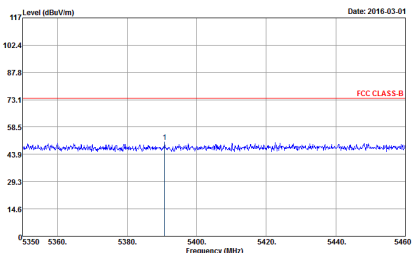
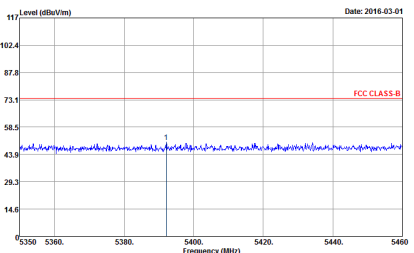
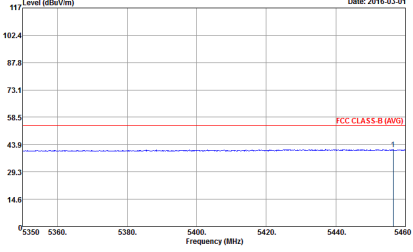
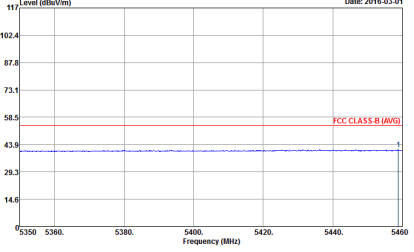

WIFI	Band 1 5150~5250MHz Band Edge @ 3m	
ANT	802.11n HT20 CH48 5240MHz - R	
1	Horizontal	Vertical
Peak	 <p>Date: 2016-03-01</p> <p>Site : 03CH07-HY Condition : FCC CLASS-B 3m HF-ANT_130829 HORIZONTAL RBW: 1000.000kHz VBW: 3000.000kHz SWT: Auto Detector : Peak</p>	 <p>Date: 2016-03-01</p> <p>Site : 03CH07-HY Condition : FCC CLASS-B 3m HF-ANT_130829 VERTICAL RBW: 1000.000kHz VBW: 3000.000kHz SWT: Auto Detector : Peak</p>
Avg.	 <p>Date: 2016-03-01</p> <p>Site : 03CH07-HY Condition : FCC CLASS-B (AVG) 3m HF-ANT_130829 HORIZONTAL RBW: 1000.000kHz VBW: 1.000kHz SWT: Auto Detector : Peak</p>	 <p>Date: 2016-03-01</p> <p>Site : 03CH07-HY Condition : FCC CLASS-B (AVG) 3m HF-ANT_130829 VERTICAL RBW: 1000.000kHz VBW: 1.000kHz SWT: Auto Detector : Peak</p>



**Band 1 5150~5250MHz
WIFI 802.11n HT40 (Band Edge @ 3m)**

WIFI	Band 1 5150~5250MHz Band Edge @ 3m	
ANT	802.11n HT40 CH38 5190MHz - L	
1	Horizontal	Vertical
Peak	<p>117 Level (dBuV/m) Date: 2016-03-01</p> <p>102.4 87.8 73.1 58.5 43.8 29.3 14.6</p> <p>5000 5030 5050 5070 5090 5110 5130 5150</p> <p>Frequency (MHz)</p> <p>Site : 03CH07-HY Condition : FCC CLASS-B 3m HF-ANT_130829 HORIZONTAL RBW: 1000.000kHz VBW: 3000.000kHz SVWT: Auto Detector : Peak</p>	<p>117 Level (dBuV/m) Date: 2016-03-01</p> <p>102.4 87.8 73.1 58.5 43.8 29.3 14.6</p> <p>5000 5030 5050 5070 5090 5110 5130 5150</p> <p>Frequency (MHz)</p> <p>Site : 03CH07-HY Condition : FCC CLASS-B 3m HF-ANT_130829 VERTICAL RBW: 1000.000kHz VBW: 3000.000kHz SVWT: Auto Detector : Peak</p>
Avg.	<p>117 Level (dBuV/m) Date: 2016-03-01</p> <p>102.4 87.8 73.1 58.5 43.8 29.3 14.6</p> <p>5000 5030 5050 5070 5090 5110 5130 5150</p> <p>Frequency (MHz)</p> <p>Site : 03CH07-HY Condition : FCC CLASS-B (AVG) 3m HF-ANT_130829 HORIZONTAL RBW: 1000.000kHz VBW: 3.000kHz SVWT: Auto Detector : Peak</p>	<p>117 Level (dBuV/m) Date: 2016-03-01</p> <p>102.4 87.8 73.1 58.5 43.8 29.3 14.6</p> <p>5000 5030 5050 5070 5090 5110 5130 5150</p> <p>Frequency (MHz)</p> <p>Site : 03CH07-HY Condition : FCC CLASS-B (AVG) 3m HF-ANT_130829 VERTICAL RBW: 1000.000kHz VBW: 3.000kHz SVWT: Auto Detector : Peak</p>

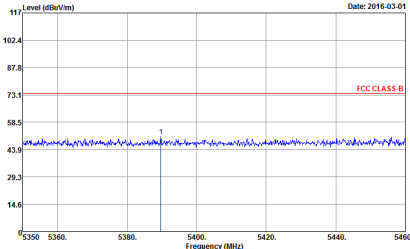
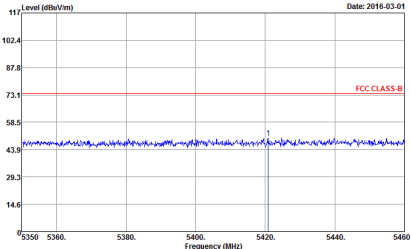
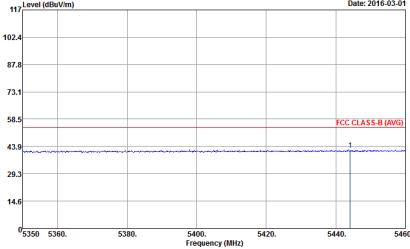
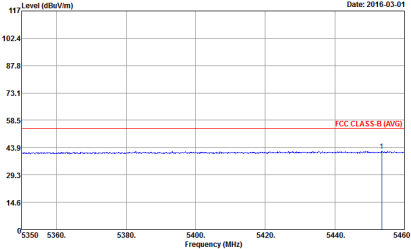

WIFI	Band 1 5150~5250MHz Band Edge @ 3m	
ANT	802.11n HT40 CH38 5190MHz - R	
1	Horizontal	Vertical
Peak	 <p>Site : 03CH07.HY Condition : FCC CLASS-B 3m HF-ANT_130829 HORIZONTAL RBW:1000.000kHz VBW:3000.000kHz SWT:Auto Detector : Peak</p>	 <p>Site : 03CH07.HY Condition : FCC CLASS-B 3m HF-ANT_130829 VERTICAL RBW:1000.000kHz VBW:3000.000kHz SWT:Auto Detector : Peak</p>
Avg.	 <p>Site : 03CH07.HY Condition : FCC CLASS-B (AVG) 3m HF-ANT_130829 HORIZONTAL RBW:1000.000kHz VBW:3.000kHz SWT:Auto Detector : Peak</p>	 <p>Site : 03CH07.HY Condition : FCC CLASS-B (AVG) 3m HF-ANT_130829 VERTICAL RBW:1000.000kHz VBW:3.000kHz SWT:Auto Detector : Peak</p>

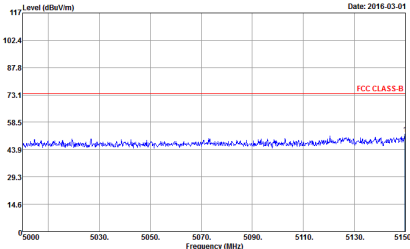
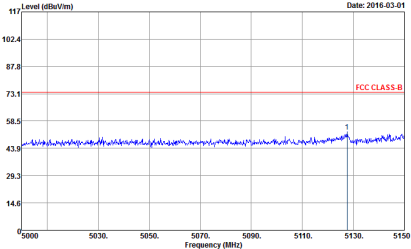
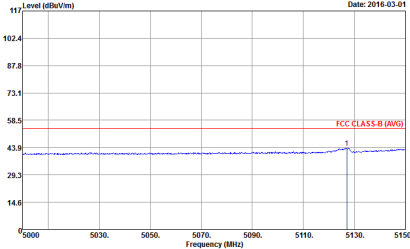
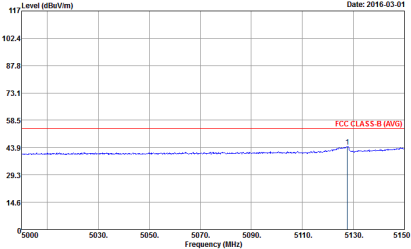

WIFI	Band 1 5150~5250MHz Band Edge @ 3m	
ANT	802.11n HT40 CH46 5230MHz - L	
1	Horizontal	Vertical
Peak	 <p>Site : 03CH07-HY Condition : FCC CLASS-B 3m HF-ANT_130829 HORIZONTAL RBW:1000.000kHz VBW:3000.000kHz SWT:Auto Detector : Peak</p>	 <p>Site : 03CH07-HY Condition : FCC CLASS-B 3m HF-ANT_130829 VERTICAL RBW:1000.000kHz VBW:3000.000kHz SWT:Auto Detector : Peak</p>
Avg.	 <p>Site : 03CH07-HY Condition : FCC CLASS-B (AVG) 3m HF-ANT_130829 HORIZONTAL RBW:1000.000kHz VBW:3.000kHz SWT:Auto Detector : Peak</p>	 <p>Site : 03CH07-HY Condition : FCC CLASS-B (AVG) 3m HF-ANT_130829 VERTICAL RBW:1000.000kHz VBW:3.000kHz SWT:Auto Detector : Peak</p>



WIFI	Band 1 5150~5250MHz Band Edge @ 3m	
ANT	802.11n HT40 CH46 5230MHz - R	
1	Horizontal	Vertical
Peak	<p>Site : 03CH07-HY Condition : FCC CLASS-B 3m HF-ANT_130829 HORIZONTAL RBW:1000.000kHz VBW:3000.000kHz SWT:Auto Detector : Peak</p>	<p>Site : 03CH07-HY Condition : FCC CLASS-B 3m HF-ANT_130829 VERTICAL RBW:1000.000kHz VBW:3000.000kHz SWT:Auto Detector : Peak</p>
Avg.	<p>Site : 03CH07-HY Condition : FCC CLASS-B (AVG) 3m HF-ANT_130829 HORIZONTAL RBW:1000.000kHz VBW:3.000kHz SWT:Auto Detector : Peak</p>	<p>Site : 03CH07-HY Condition : FCC CLASS-B (AVG) 3m HF-ANT_130829 VERTICAL RBW:1000.000kHz VBW:3.000kHz SWT:Auto Detector : Peak</p>



Band 1 - 5150~5250MHz
WIFI 802.11a (Harmonic @ 3m)

WIFI	Band 1 5150~5250MHz Harmonic @ 3m	
ANT	802.11a CH36 5180MHz	
1	Horizontal	Vertical
Peak Avg.	<p>Site : 03CH07.HY Condition : FCC CLASS-B 3m SHF-EHF_131029 HORIZONTAL Detector : Peak</p>	<p>Site : 03CH07.HY Condition : FCC CLASS-B 3m SHF-EHF_131029 VERTICAL Detector : Peak</p>



WIFI	Band 1 5150-5250MHz Harmonic @ 3m	
ANT	802.11a CH44 5220MHz	
1	Horizontal	Vertical
Peak Avg.	<p>Site : 03CH7.HY Condition : FCC CLASS-B 3m SHF-EHF_131029 HORIZONTAL Detector : Peak</p>	<p>Site : 03CH7.HY Condition : FCC CLASS-B 3m SHF-EHF_131029 VERTICAL Detector : Peak</p>



WIFI	Band 1 5150-5250MHz Harmonic @ 3m	
ANT	802.11a CH48 5240MHz	
1	Horizontal	Vertical
Peak Avg.	<p>Site : 03CH07.HY Condition : FCC CLASS-B 3m SHF-EHF_131029 HORIZONTAL Detector : Peak</p>	<p>Site : 03CH07.HY Condition : FCC CLASS-B 3m SHF-EHF_131029 VERTICAL Detector : Peak</p>



Band 1 5150~5250MHz
WIFI 802.11n HT20 (Harmonic @ 3m)

Table with 3 columns: WIFI, ANT, and measurement results for Horizontal and Vertical orientations. Includes peak and average level graphs for FCC CLASS-B and FCC CLASS-B (AVG) standards.



WIFI	Band 1 5150-5250MHz Harmonic @ 3m	
ANT	802.11n HT20 CH44 5220MHz	
1	Horizontal	Vertical
Peak Avg.	<p>Site : 03CH07.HY Condition : FCC CLASS-B 3m SHF-EHF_131029 HORIZONTAL Detector : Peak</p>	<p>Site : 03CH07.HY Condition : FCC CLASS-B 3m SHF-EHF_131029 VERTICAL Detector : Peak</p>



WIFI	Band 1 5150-5250MHz Harmonic @ 3m	
ANT	802.11n HT20 CH48 5240MHz	
1	Horizontal	Vertical
<p>Peak</p> <p>Avg.</p>	<p>Site : 03CH67-HY Condition : FCC CLASS-B 3m SHF-EHF_131029 HORIZONTAL Detector : Peak</p>	<p>Site : 03CH67-HY Condition : FCC CLASS-B 3m SHF-EHF_131029 VERTICAL Detector : Peak</p>



Band 1 5150~5250MHz
WIFI 802.11n HT40 (Harmonic @ 3m)

Table with 3 columns: WIFI, ANT, and 1. It contains two graphs showing Peak and Avg. levels for Horizontal and Vertical orientations. The graphs plot Level (dBuV/m) against Frequency (MHz) from 1000 to 40000. Two red lines indicate FCC CLASS-B and FCC CLASS-B (AVG) limits.



WIFI	Band 1 5150-5250MHz Harmonic @ 3m	
ANT	802.11n HT40 CH46 5230MHz	
1	Horizontal	Vertical
Peak Avg.	<p>Site : 03CH07.HY Condition : FCC CLASS-B 3m SHF-EHF_131029 HORIZONTAL Detector : Peak</p>	<p>Site : 03CH07.HY Condition : FCC CLASS-B 3m SHF-EHF_131029 VERTICAL Detector : Peak</p>



Band 2 - 5250~5350MHz
WIFI 802.11a (Band Edge @ 3m)

WIFI	Band 2 5250~5350MHz Band Edge @ 3m	
ANT	802.11a CH52 5260MHz - L	
1	Horizontal	Vertical
Peak	<p>Site : 03CH074HY Condition : FCC CLASS-B 3m HF-ANT_130829 HORIZONTAL Detector : Peak</p>	<p>Site : 03CH074HY Condition : FCC CLASS-B 3m HF-ANT_130829 VERTICAL Detector : Peak</p>
Avg.	<p>Site : 03CH074HY Condition : FCC CLASS-B (AVG) 3m HF-ANT_130829 HORIZONTAL Detector : Peak</p>	<p>Site : 03CH074HY Condition : FCC CLASS-B (AVG) 3m HF-ANT_130829 VERTICAL Detector : Peak</p>



WIFI	Band 2 5250~5350MHz Band Edge @ 3m	
ANT	802.11a CH52 5260MHz - R	
1	Horizontal	Vertical
Peak	<p>Site : 03CH07.HY Condition : FCC CLASS-B 3m HF-ANT_130829 HORIZONTAL RBW: 1000.000kHz VBW: 3000.000kHz SWT: Auto Detector : Peak</p>	<p>Site : 03CH07.HY Condition : FCC CLASS-B 3m HF-ANT_130829 VERTICAL RBW: 1000.000kHz VBW: 3000.000kHz SWT: Auto Detector : Peak</p>
Avg.	<p>Site : 03CH07.HY Condition : FCC CLASS-B (AVG) 3m HF-ANT_130829 HORIZONTAL RBW: 1000.000kHz VBW: 1.000kHz SWT: Auto Detector : Peak</p>	<p>Site : 03CH07.HY Condition : FCC CLASS-B (AVG) 3m HF-ANT_130829 VERTICAL RBW: 1000.000kHz VBW: 1.000kHz SWT: Auto Detector : Peak</p>



WIFI	Band 2 5250~5350MHz Band Edge @ 3m	
ANT	802.11a CH60 5300MHz - L	
1	Horizontal	Vertical
Peak	<p>Site : 03CH07.HY Condition : FCC CLASS-B 3m HF-ANT_130829 HORIZONTAL RBW:1000.000kHz VBW:3000.000kHz SWT:Auto Detector : Peak</p>	<p>Site : 03CH07.HY Condition : FCC CLASS-B 3m HF-ANT_130829 VERTICAL RBW:1000.000kHz VBW:3000.000kHz SWT:Auto Detector : Peak</p>
Avg.	<p>Site : 03CH07.HY Condition : FCC CLASS-B (AVG) 3m HF-ANT_130829 HORIZONTAL RBW:1000.000kHz VBW:1.000kHz SWT:Auto Detector : Peak</p>	<p>Site : 03CH07.HY Condition : FCC CLASS-B (AVG) 3m HF-ANT_130829 VERTICAL RBW:1000.000kHz VBW:1.000kHz SWT:Auto Detector : Peak</p>



WIFI	Band 2 5250~5350MHz Band Edge @ 3m	
ANT	802.11a CH60 5300MHz - R	
1	Horizontal	Vertical
Peak	<p>Site : 03CH07-HY Condition : FCC CLASS-B 3m HF-ANT_130829 HORIZONTAL RBW:1000.000kHz VBW:3000.000kHz SWT:Auto Detector : Peak</p>	<p>Site : 03CH07-HY Condition : FCC CLASS-B 3m HF-ANT_130829 VERTICAL RBW:1000.000kHz VBW:3000.000kHz SWT:Auto Detector : Peak</p>
Avg.	<p>Site : 03CH07-HY Condition : FCC CLASS-B (AVG) 3m HF-ANT_130829 HORIZONTAL RBW:1000.000kHz VBW:1.000kHz SWT:Auto Detector : Peak</p>	<p>Site : 03CH07-HY Condition : FCC CLASS-B (AVG) 3m HF-ANT_130829 VERTICAL RBW:1000.000kHz VBW:1.000kHz SWT:Auto Detector : Peak</p>



WIFI	Band 2 5250~5350MHz Band Edge @ 3m	
ANT	802.11a CH64 5320MHz	
1	Horizontal	Vertical
Peak	<p>Site : 03CH07.HY Condition : FCC CLASS-B 3m HF-ANT_130829 HORIZONTAL RBW:1000.000kHz VBW:3000.000kHz SWT:Auto Detector : Peak</p>	<p>Site : 03CH07.HY Condition : FCC CLASS-B 3m HF-ANT_130829 VERTICAL RBW:1000.000kHz VBW:3000.000kHz SWT:Auto Detector : Peak</p>
Avg.	<p>Site : 03CH07.HY Condition : FCC CLASS-B (AVG) 3m HF-ANT_130829 HORIZONTAL RBW:1000.000kHz VBW:1.000kHz SWT:Auto Detector : Peak</p>	<p>Site : 03CH07.HY Condition : FCC CLASS-B (AVG) 3m HF-ANT_130829 VERTICAL RBW:1000.000kHz VBW:1.000kHz SWT:Auto Detector : Peak</p>



Band 2 5250~5350MHz
WIFI 802.11n HT20 (Band Edge @ 3m)

Table with 3 columns: WIFI, ANT, and test results. Rows include '1' for Peak and 'Avg.' for Average. Columns are 'Horizontal' and 'Vertical'. Each cell contains a graph of Level (dBuV/m) vs Frequency (MHz) with FCC CLASS-B limits and test parameters.

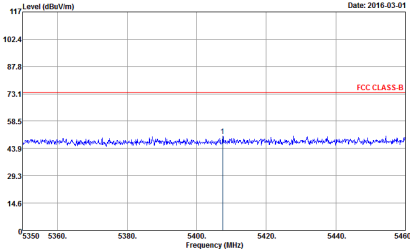
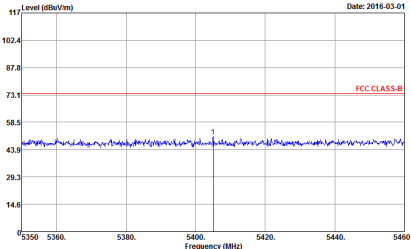
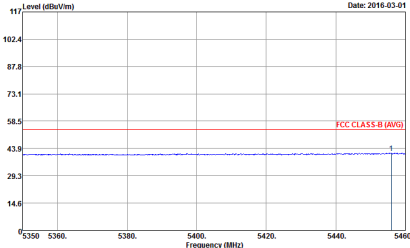
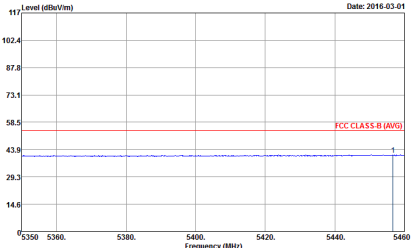

WIFI	Band 2 5250~5350MHz Band Edge @ 3m	
ANT	802.11n HT20 CH52 5260MHz - R	
1	Horizontal	Vertical
Peak	 <p>117 Level (dBuV/m) Date: 2016-03-01</p> <p>102.4</p> <p>87.8</p> <p>73.1</p> <p>58.5</p> <p>43.8</p> <p>29.3</p> <p>14.6</p> <p>5350 5360. 5380. 5400. 5420. 5440. 5460</p> <p>Frequency (MHz)</p> <p>Site : 03CH07-HY Condition : FCC CLASS-B 3m HF-ANT_130829 HORIZONTAL RBW: 1000.000kHz VBW: 3000.000kHz SWT: Auto Detector : Peak</p>	 <p>117 Level (dBuV/m) Date: 2016-03-01</p> <p>102.4</p> <p>87.8</p> <p>73.1</p> <p>58.5</p> <p>43.8</p> <p>29.3</p> <p>14.6</p> <p>5350 5360. 5380. 5400. 5420. 5440. 5460</p> <p>Frequency (MHz)</p> <p>Site : 03CH07-HY Condition : FCC CLASS-B 3m HF-ANT_130829 VERTICAL RBW: 1000.000kHz VBW: 3000.000kHz SWT: Auto Detector : Peak</p>
Avg.	 <p>117 Level (dBuV/m) Date: 2016-03-01</p> <p>102.4</p> <p>87.8</p> <p>73.1</p> <p>58.5</p> <p>43.8</p> <p>29.3</p> <p>14.6</p> <p>5350 5360. 5380. 5400. 5420. 5440. 5460</p> <p>Frequency (MHz)</p> <p>Site : 03CH07-HY Condition : FCC CLASS-B (AVG) 3m HF-ANT_130829 HORIZONTAL RBW: 1000.000kHz VBW: 1.000kHz SWT: Auto Detector : Peak</p>	 <p>117 Level (dBuV/m) Date: 2016-03-01</p> <p>102.4</p> <p>87.8</p> <p>73.1</p> <p>58.5</p> <p>43.8</p> <p>29.3</p> <p>14.6</p> <p>5350 5360. 5380. 5400. 5420. 5440. 5460</p> <p>Frequency (MHz)</p> <p>Site : 03CH07-HY Condition : FCC CLASS-B (AVG) 3m HF-ANT_130829 VERTICAL RBW: 1000.000kHz VBW: 1.000kHz SWT: Auto Detector : Peak</p>

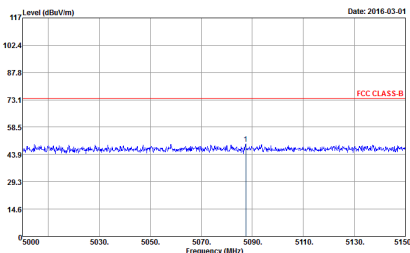
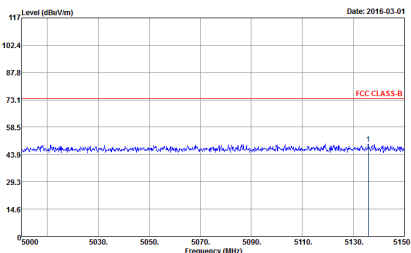
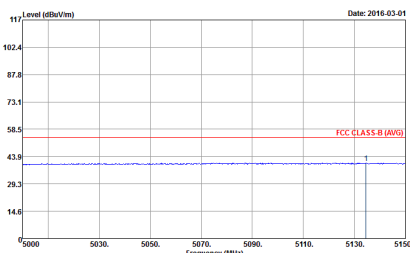
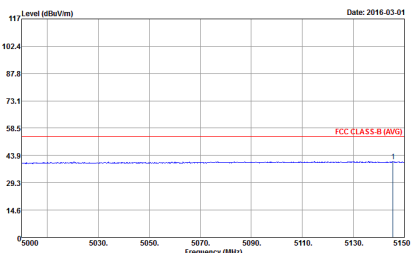

WIFI	Band 2 5250~5350MHz Band Edge @ 3m	
ANT	802.11n HT20 CH60 5300MHz - L	
1	Horizontal	Vertical
Peak	 <p>Site : 03CH07-HY Condition : FCC CLASS-B 3m HF-ANT_130829 HORIZONTAL RBW:1000.000kHz VBW:3000.000kHz SWT:Auto Detector : Peak</p>	 <p>Site : 03CH07-HY Condition : FCC CLASS-B 3m HF-ANT_130829 VERTICAL RBW:1000.000kHz VBW:3000.000kHz SWT:Auto Detector : Peak</p>
Avg.	 <p>Site : 03CH07-HY Condition : FCC CLASS-B (AVG) 3m HF-ANT_130829 HORIZONTAL RBW:1000.000kHz VBW:1.000kHz SWT:Auto Detector : Peak</p>	 <p>Site : 03CH07-HY Condition : FCC CLASS-B (AVG) 3m HF-ANT_130829 VERTICAL RBW:1000.000kHz VBW:1.000kHz SWT:Auto Detector : Peak</p>



WIFI	Band 2 5250~5350MHz Band Edge @ 3m	
ANT	802.11n HT20 CH60 5300MHz - R	
1	Horizontal	Vertical
Peak	<p>Site : 03CH07-HY Condition : FCC CLASS-B 3m HF-ANT_130829 HORIZONTAL RBW:1000.000kHz VBW:3000.000kHz SWT:Auto Detector : Peak</p>	<p>Site : 03CH07-HY Condition : FCC CLASS-B 3m HF-ANT_130829 VERTICAL RBW:1000.000kHz VBW:3000.000kHz SWT:Auto Detector : Peak</p>
Avg.	<p>Site : 03CH07-HY Condition : FCC CLASS-B (AVG) 3m HF-ANT_130829 HORIZONTAL RBW:1000.000kHz VBW:1.000kHz SWT:Auto Detector : Peak Project : 620325 Mode : 14</p>	<p>Site : 03CH07-HY Condition : FCC CLASS-B (AVG) 3m HF-ANT_130829 VERTICAL RBW:1000.000kHz VBW:1.000kHz SWT:Auto Detector : Peak Project : 620325 Mode : 14</p>

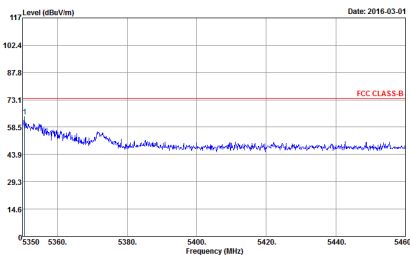
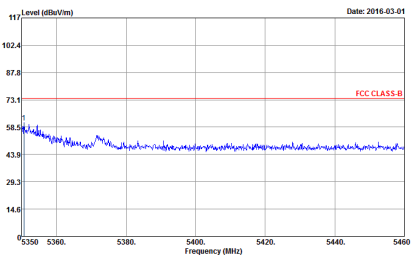
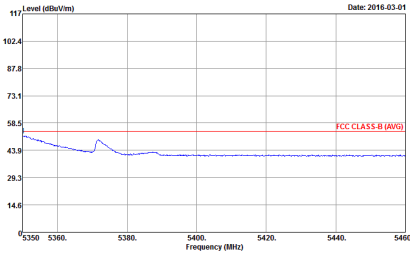
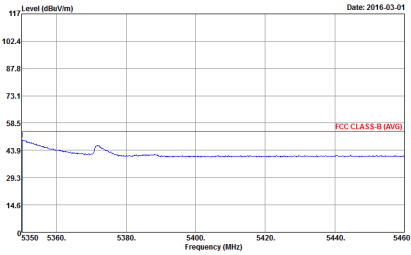

WIFI	Band 2 5250~5350MHz Band Edge @ 3m	
ANT	802.11n HT20 CH64 5320MHz	
1	Horizontal	Vertical
Peak	 <p>Site : 03CH07.HY Condition : FCC CLASS-B 3m HF-ANT_130829 HORIZONTAL RBW:1000.000kHz VBW:3000.000kHz SWT:Auto Detector : Peak</p>	 <p>Site : 03CH07.HY Condition : FCC CLASS-B 3m HF-ANT_130829 VERTICAL RBW:1000.000kHz VBW:3000.000kHz SWT:Auto Detector : Peak</p>
Avg.	 <p>Site : 03CH07.HY Condition : FCC CLASS-B (AVG) 3m HF-ANT_130829 HORIZONTAL RBW:1000.000kHz VBW:1.000kHz SWT:Auto Detector : Peak</p>	 <p>Site : 03CH07.HY Condition : FCC CLASS-B (AVG) 3m HF-ANT_130829 VERTICAL RBW:1000.000kHz VBW:1.000kHz SWT:Auto Detector : Peak</p>



Band 2 5250~5350MHz
WIFI 802.11n HT40 (Band Edge @ 3m)

Table with 4 columns: WIFI, ANT, 1, and two columns for Horizontal and Vertical orientations. Rows are labeled 'Peak' and 'Avg.' containing spectral plots and technical details.



WIFI	Band 2 5250~5350MHz Band Edge @ 3m	
ANT	802.11n HT40 CH54 5270 - R	
1	Horizontal	Vertical
Peak	<p>Date: 2016-03-01</p> <p>Site : 03CH07-HY Condition : FCC CLASS-B 3m HF-ANT_130829 HORIZONTAL RBW: 1000.000kHz VBW:3000.000kHz SWT:Auto Detector : Peak</p>	<p>Date: 2016-03-01</p> <p>Site : 03CH07-HY Condition : FCC CLASS-B 3m HF-ANT_130829 VERTICAL RBW: 1000.000kHz VBW:3000.000kHz SWT:Auto Detector : Peak</p>
Avg.	<p>Date: 2016-03-01</p> <p>Site : 03CH07-HY Condition : FCC CLASS-B (AVG) 3m HF-ANT_130829 HORIZONTAL RBW: 1000.000kHz VBW:3.000kHz SWT:Auto Detector : Peak</p>	<p>Date: 2016-03-01</p> <p>Site : 03CH07-HY Condition : FCC CLASS-B (AVG) 3m HF-ANT_130829 VERTICAL RBW: 1000.000kHz VBW:3.000kHz SWT:Auto Detector : Peak</p>



WIFI	Band 2 5250~5350MHz Band Edge @ 3m	
ANT	802.11n HT40 CH62 5310 - L	
1	Horizontal	Vertical
Peak	<p>Site : 03CH07.HY Condition : FCC CLASS-B 3m HF-ANT_130829 HORIZONTAL RBW: 1000.000kHz VBW: 3000.000kHz SWT: Auto Detector : Peak</p>	<p>Site : 03CH07.HY Condition : FCC CLASS-B 3m HF-ANT_130829 VERTICAL RBW: 1000.000kHz VBW: 3000.000kHz SWT: Auto Detector : Peak</p>
Avg.	<p>Site : 03CH07.HY Condition : FCC CLASS-B (AVG) 3m HF-ANT_130829 HORIZONTAL RBW: 1000.000kHz VBW: 3.000kHz SWT: Auto Detector : Peak</p>	<p>Site : 03CH07.HY Condition : FCC CLASS-B (AVG) 3m HF-ANT_130829 VERTICAL RBW: 1000.000kHz VBW: 3.000kHz SWT: Auto Detector : Peak</p>



WIFI	Band 2 5250~5350MHz Band Edge @ 3m	
ANT	802.11n HT40 CH62 5310 - R	
1	Horizontal	Vertical
Peak	<p>Site : 03CH07.HY Condition : FCC CLASS-B 3m HF-ANT_130829 HORIZONTAL RBW:1000.000kHz VBW:3000.000kHz SWT:Auto Detector : Peak</p>	<p>Site : 03CH07.HY Condition : FCC CLASS-B 3m HF-ANT_130829 VERTICAL RBW:1000.000kHz VBW:3000.000kHz SWT:Auto Detector : Peak</p>
Avg.	<p>Site : 03CH07.HY Condition : FCC CLASS-B (AVG) 3m HF-ANT_130829 HORIZONTAL RBW:1000.000kHz VBW:3.000kHz SWT:Auto Detector : Peak</p>	<p>Site : 03CH07.HY Condition : FCC CLASS-B (AVG) 3m HF-ANT_130829 VERTICAL RBW:1000.000kHz VBW:3.000kHz SWT:Auto Detector : Peak</p>



Band 2 - 5250~5350MHz
WIFI 802.11a (Harmonic @ 3m)

WIFI	Band 2 5250~5350MHz Harmonic @ 3m	
ANT	802.11a CH52 5260MHz	
1	Horizontal	Vertical
Peak Avg.	<p>Site : 03CH07.HY Condition : FCC CLASS-B 3m SHF-EHF_131029 HORIZONTAL Detector : Peak</p>	<p>Site : 03CH07.HY Condition : FCC CLASS-B 3m SHF-EHF_131029 VERTICAL Detector : Peak</p>



WIFI	Band 2 5250-5350MHz Harmonic @ 3m	
ANT	802.11a CH60 5300MHz	
1	Horizontal	Vertical
Peak Avg.	<p>Site : 03CH67-HY Condition : FCC CLASS-B 3m SHF-EHF_131029 HORIZONTAL Detector : Peak</p>	<p>Site : 03CH67-HY Condition : FCC CLASS-B 3m SHF-EHF_131029 VERTICAL Detector : Peak</p>



WIFI	Band 2 5250-5350MHz Harmonic @ 3m	
ANT	802.11a CH64 5320MHz	
1	Horizontal	Vertical
Peak Avg.	<p>Site : 03CH07.HY Condition : FCC CLASS-B 3m SHF-EHF_131029 HORIZONTAL Detector : Peak</p>	<p>Site : 03CH07.HY Condition : FCC CLASS-B 3m SHF-EHF_131029 VERTICAL Detector : Peak</p>



Band 2 5250~5350MHz
WIFI 802.11n HT20 (Harmonic @ 3m)

WIFI	Band 2 5250~5350MHz Harmonic @ 3m	
ANT	802.11n HT20 CH52 5260MHz	
1	Horizontal	Vertical
Peak Avg.	<p>Site : 03CH07-HY Condition : FCC CLASS-B 3m SHF-EHF_131029 HORIZONTAL Detector : Peak</p>	<p>Site : 03CH07-HY Condition : FCC CLASS-B 3m SHF-EHF_131029 VERTICAL Detector : Peak</p>

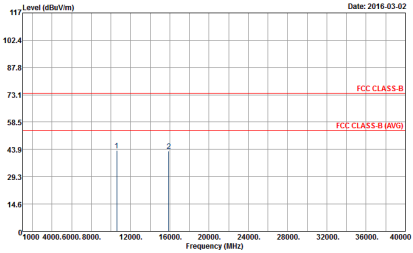
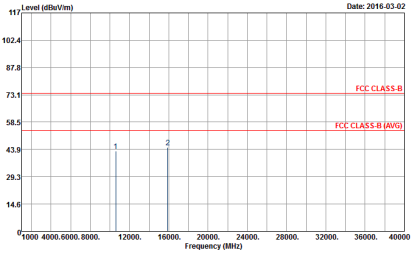

WIFI	Band 2 5250-5350MHz Harmonic @ 3m	
ANT	802.11n HT20 CH60 5300MHz	
1	Horizontal	Vertical
<p>Peak</p> <p>Avg.</p>	 <p>Site : 03CH07HY Condition : FCC CLASS-B 3m SHF-EHF_131029 HORIZONTAL Detector : Peak</p>	 <p>Site : 03CH07HY Condition : FCC CLASS-B 3m SHF-EHF_131029 VERTICAL Detector : Peak</p>



WIFI	Band 2 5250-5350MHz Harmonic @ 3m	
ANT	802.11n HT20 CH64 5320MHz	
1	Horizontal	Vertical
<p>Peak</p> <p>Avg.</p>	<p>Site : 03CH67-HY Condition : FCC CLASS-B 3m SHF-EHF_131029 HORIZONTAL Detector : Peak</p>	<p>Site : 03CH67-HY Condition : FCC CLASS-B 3m SHF-EHF_131029 VERTICAL Detector : Peak</p>



Band 2 5250~5350MHz
WIFI 802.11n HT40 (Harmonic @ 3m)

WIFI	Band 2 5250~5350MHz Harmonic @ 3m	
ANT	802.11n HT40 CH54 5270	
1	Horizontal	Vertical
Peak Avg.	<p>Site : 03CH07-HY Condition : FCC CLASS-B 3m SHF-EHF_131029 HORIZONTAL Detector : Peak</p>	<p>Site : 03CH07-HY Condition : FCC CLASS-B 3m SHF-EHF_131029 VERTICAL Detector : Peak</p>



WIFI	Band 2 5250-5350MHz Harmonic @ 3m	
ANT	802.11n HT40 CH62 5310	
1	Horizontal	Vertical
<p>Peak</p> <p>Avg.</p>	<p>Site : 03CH7-HY Condition : FCC CLASS-B 3m SHF-EHF_131029 HORIZONTAL Detector : Peak</p>	<p>Site : 03CH7-HY Condition : FCC CLASS-B 3m SHF-EHF_131029 VERTICAL Detector : Peak</p>



Band 3 - 5470~5725MHz
WIFI 802.11a (Band Edge @ 3m)

WIFI	Band 3 5470~5725MHz Band Edge @ 3m	
ANT	802.11a CH100 5500MHz	
1	Horizontal	Vertical
Peak	<p>Site : 03CH07-HY Condition : FCC CLASS-B 3m HF-ANT_130829 HORIZONTAL RBW:1000.000kHz VBW:3000.000kHz SWT:Auto Detector : Peak</p>	<p>Site : 03CH07-HY Condition : FCC CLASS-B 3m HF-ANT_130829 VERTICAL RBW:1000.000kHz VBW:3000.000kHz SWT:Auto Detector : Peak</p>
Avg.	<p>Site : 03CH07-HY Condition : FCC CLASS-B (AVG) 3m HF-ANT_130829 HORIZONTAL RBW:1000.000kHz VBW:1.000kHz SWT:Auto Detector : Peak</p>	<p>Site : 03CH07-HY Condition : FCC CLASS-B (AVG) 3m HF-ANT_130829 VERTICAL RBW:1000.000kHz VBW:1.000kHz SWT:Auto Detector : Peak</p>



WIFI	Band 3 5470~5725MHz Band Edge @ 3m	
ANT	802.11a CH116 5580MHz - L	
1	Horizontal	Vertical
Peak	<p>Date: 2016-02-29</p> <p>Site : 03CH07-HY Condition : FCC CLASS-B 3m HF-ANT_130829 HORIZONTAL RBW:1000.000kHz VBW:3000.000kHz SWT:Auto Detector : Peak</p>	<p>Date: 2016-02-29</p> <p>Site : 03CH07-HY Condition : FCC CLASS-B 3m HF-ANT_130829 VERTICAL RBW:1000.000kHz VBW:3000.000kHz SWT:Auto Detector : Peak</p>
Avg.	<p>Date: 2016-02-29</p> <p>Site : 03CH07-HY Condition : FCC CLASS-B (AVG) 3m HF-ANT_130829 HORIZONTAL RBW:1000.000kHz VBW:1.000kHz SWT:Auto Detector : Peak</p>	<p>Date: 2016-02-29</p> <p>Site : 03CH07-HY Condition : FCC CLASS-B (AVG) 3m HF-ANT_130829 VERTICAL RBW:1000.000kHz VBW:1.000kHz SWT:Auto Detector : Peak</p>



WIFI	Band 3 5470~5725MHz Band Edge @ 3m	
ANT	802.11a CH116 5580MHz - R	
1	Horizontal	Vertical
Peak	<p>Site : 03CH07.HY Condition : FCC CLASS-B 3m HF-ANT_130829 HORIZONTAL RBW: 1000.000kHz VBW: 3000.000kHz SWT: Auto Detector : Peak</p>	<p>Site : 03CH07.HY Condition : FCC CLASS-B 3m HF-ANT_130829 VERTICAL RBW: 1000.000kHz VBW: 3000.000kHz SWT: Auto Detector : Peak</p>
Avg.	<p>Site : 03CH07.HY Condition : FCC CLASS-B (AVG) 3m HF-ANT_130829 HORIZONTAL RBW: 1000.000kHz VBW: 1.000kHz SWT: Auto Detector : Peak</p>	<p>Site : 03CH07.HY Condition : FCC CLASS-B (AVG) 3m HF-ANT_130829 VERTICAL RBW: 1000.000kHz VBW: 1.000kHz SWT: Auto Detector : Peak</p>



WIFI	Band 3 5470~5725MHz Band Edge @ 3m	
ANT	802.11a CH140 5700MHz	
1	Horizontal	Vertical
Peak	<p>Site : 03CH07.HY Condition : FCC CLASS-B 3m HF-ANT_130829 HORIZONTAL RBW: 1000.000kHz VBW: 3000.000kHz SWT: Auto Detector : Peak</p>	<p>Site : 03CH07.HY Condition : FCC CLASS-B 3m HF-ANT_130829 VERTICAL RBW: 1000.000kHz VBW: 3000.000kHz SWT: Auto Detector : Peak</p>
Avg.	<p>Site : 03CH07.HY Condition : FCC CLASS-B (AVG) 3m HF-ANT_130829 HORIZONTAL RBW: 1000.000kHz VBW: 1.000kHz SWT: Auto Detector : Peak</p>	<p>Site : 03CH07.HY Condition : FCC CLASS-B (AVG) 3m HF-ANT_130829 VERTICAL RBW: 1000.000kHz VBW: 1.000kHz SWT: Auto Detector : Peak</p>



Band 3 5470~5725MHz
WIFI 802.11n HT20 (Band Edge @ 3m)

WIFI	Band 3 5470~5725MHz Band Edge @ 3m	
ANT	802.11n HT20 CH100 5500MHz	
1	Horizontal	Vertical
Peak	<p>Site : 03CH07-HY Condition : FCC CLASS-B 3m HF-ANT_130829 HORIZONTAL Detector : Peak</p>	<p>Site : 03CH07-HY Condition : FCC CLASS-B 3m HF-ANT_130829 VERTICAL Detector : Peak</p>
Avg.	<p>Site : 03CH07-HY Condition : FCC CLASS-B (AVG) 3m HF-ANT_130829 HORIZONTAL Detector : Peak</p>	<p>Site : 03CH07-HY Condition : FCC CLASS-B (AVG) 3m HF-ANT_130829 VERTICAL Detector : Peak</p>

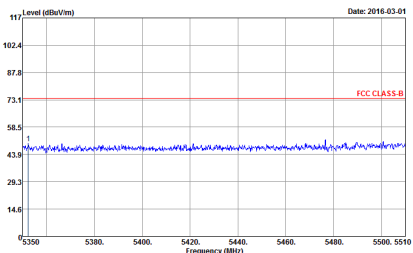
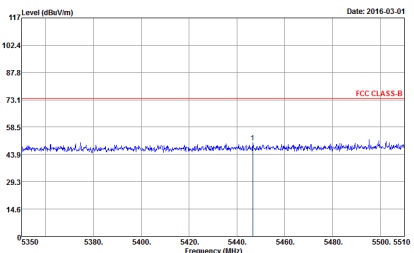
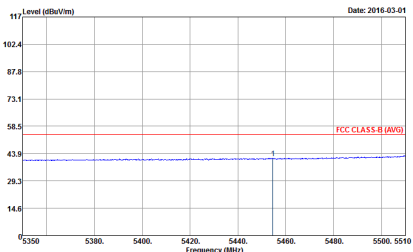
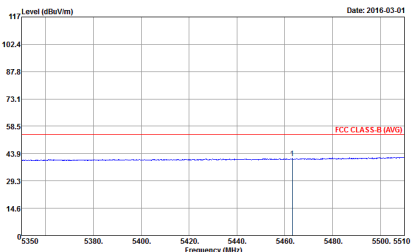

WIFI	Band 3 5470~5725MHz Band Edge @ 3m	
ANT	802.11n HT20 CH116 5580MHz - L	
1	Horizontal	Vertical
Peak	 <p>Date: 2016-03-01</p> <p>Site : 03CH07-HY Condition : FCC CLASS-B 3m HF-ANT_130829 HORIZONTAL RBW: 1000.000kHz VBW: 3000.000kHz SWT: Auto Detector : Peak</p>	 <p>Date: 2016-03-01</p> <p>Site : 03CH07-HY Condition : FCC CLASS-B 3m HF-ANT_130829 VERTICAL RBW: 1000.000kHz VBW: 3000.000kHz SWT: Auto Detector : Peak</p>
Avg.	 <p>Date: 2016-03-01</p> <p>Site : 03CH07-HY Condition : FCC CLASS-B (AVG) 3m HF-ANT_130829 HORIZONTAL RBW: 1000.000kHz VBW: 1.000kHz SWT: Auto Detector : Peak</p>	 <p>Date: 2016-03-01</p> <p>Site : 03CH07-HY Condition : FCC CLASS-B (AVG) 3m HF-ANT_130829 VERTICAL RBW: 1000.000kHz VBW: 1.000kHz SWT: Auto Detector : Peak</p>

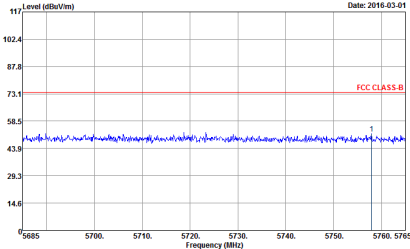
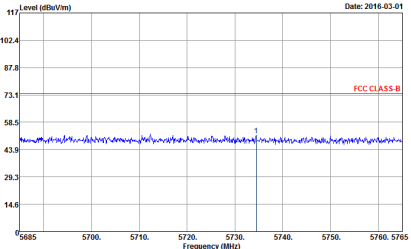
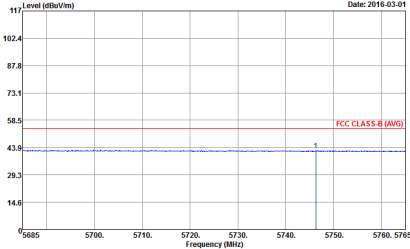
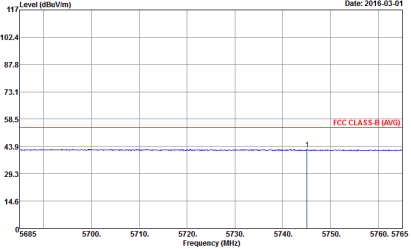

WIFI	Band 3 5470~5725MHz Band Edge @ 3m	
ANT	802.11n HT20 CH116 5580MHz - R	
1	Horizontal	Vertical
Peak	 <p>Date: 2016-03-01</p> <p>Site : 03CH07-HY Condition : FCC CLASS-B 3m HF-ANT_130829 HORIZONTAL RBW: 1000.000kHz VBW: 3000.000kHz SWT: Auto Detector : Peak</p>	 <p>Date: 2016-03-01</p> <p>Site : 03CH07-HY Condition : FCC CLASS-B 3m HF-ANT_130829 VERTICAL RBW: 1000.000kHz VBW: 3000.000kHz SWT: Auto Detector : Peak</p>
Avg.	 <p>Date: 2016-03-01</p> <p>Site : 03CH07-HY Condition : FCC CLASS-B (AVG) 3m HF-ANT_130829 HORIZONTAL RBW: 1000.000kHz VBW: 1.000kHz SWT: Auto Detector : Peak</p>	 <p>Date: 2016-03-01</p> <p>Site : 03CH07-HY Condition : FCC CLASS-B (AVG) 3m HF-ANT_130829 VERTICAL RBW: 1000.000kHz VBW: 1.000kHz SWT: Auto Detector : Peak</p>



WIFI	Band 3 5470~5725MHz Band Edge @ 3m	
ANT	802.11n HT20 CH140 5700MHz	
1	Horizontal	Vertical
Peak	<p>Site : 03CH07.HY Condition : FCC CLASS-B 3m HF-ANT_130829 HORIZONTAL RBW:1000.000kHz VBW:3000.000kHz SWT:Auto Detector : Peak</p>	<p>Site : 03CH07.HY Condition : FCC CLASS-B 3m HF-ANT_130829 VERTICAL RBW:1000.000kHz VBW:3000.000kHz SWT:Auto Detector : Peak</p>
Avg.	<p>Site : 03CH07.HY Condition : FCC CLASS-B (AVG) 3m HF-ANT_130829 HORIZONTAL RBW:1000.000kHz VBW:1.000kHz SWT:Auto Detector : Peak</p>	<p>Site : 03CH07.HY Condition : FCC CLASS-B (AVG) 3m HF-ANT_130829 VERTICAL RBW:1000.000kHz VBW:1.000kHz SWT:Auto Detector : Peak</p>



**Band 3 5470~5725MHz
WIFI 802.11n HT40 (Band Edge @ 3m)**

WIFI	Band 3 5470~5725MHz Band Edge @ 3m	
ANT	802.11n HT40 CH102 5510MHz - L	
1	Horizontal	Vertical
Peak	<p>Site : 03CH07-HY Condition : FCC CLASS-B 3m HF-ANT_130829 HORIZONTAL Detector : Peak</p>	<p>Site : 03CH07-HY Condition : FCC CLASS-B 3m HF-ANT_130829 VERTICAL Detector : Peak</p>
Avg.	<p>Site : 03CH07-HY Condition : FCC CLASS-B (AVG) 3m HF-ANT_130829 HORIZONTAL Detector : Peak</p>	<p>Site : 03CH07-HY Condition : FCC CLASS-B (AVG) 3m HF-ANT_130829 VERTICAL Detector : Peak</p>



WIFI	Band 3 5470~5725MHz Band Edge @ 3m	
ANT	802.11n HT40 CH102 5510MHz - R	
1	Horizontal	Vertical
Peak	<p>Date: 2016-03-01</p> <p>Site : 03CH07-HY Condition : FCC CLASS-B 3m HF-ANT_130829 HORIZONTAL RBW: 1000.000kHz VBW: 3000.000kHz SWT: Auto Detector : Peak</p>	<p>Date: 2016-03-01</p> <p>Site : 03CH07-HY Condition : FCC CLASS-B 3m HF-ANT_130829 VERTICAL RBW: 1000.000kHz VBW: 3000.000kHz SWT: Auto Detector : Peak</p>
Avg.	<p>Date: 2016-03-01</p> <p>Site : 03CH07-HY Condition : FCC CLASS-B (AVG) 3m HF-ANT_130829 HORIZONTAL RBW: 1000.000kHz VBW: 3.000kHz SWT: Auto Detector : Peak</p>	<p>Date: 2016-03-01</p> <p>Site : 03CH07-HY Condition : FCC CLASS-B (AVG) 3m HF-ANT_130829 VERTICAL RBW: 1000.000kHz VBW: 3.000kHz SWT: Auto Detector : Peak</p>

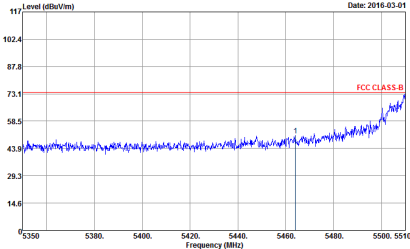
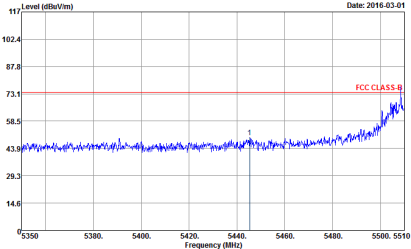
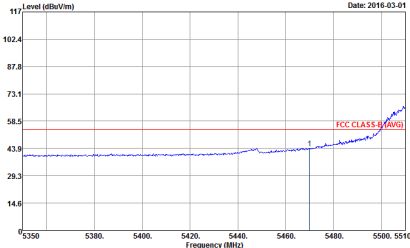
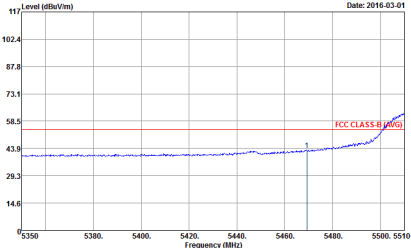

WIFI	Band 3 5470~5725MHz Band Edge @ 3m	
ANT	802.11n HT40 CH110 5550MHz - L	
1	Horizontal	Vertical
Peak	 <p>Site : 03CH07.HY Condition : FCC CLASS-B 3m HF-ANT_130829 HORIZONTAL RBW: 1000.000kHz VBW: 3000.000kHz SWT: Auto Detector : Peak</p>	 <p>Site : 03CH07.HY Condition : FCC CLASS-B 3m HF-ANT_130829 VERTICAL RBW: 1000.000kHz VBW: 3000.000kHz SWT: Auto Detector : Peak</p>
Avg.	 <p>Site : 03CH07.HY Condition : FCC CLASS-B (AVG) 3m HF-ANT_130829 HORIZONTAL RBW: 1000.000kHz VBW: 3.000kHz SWT: Auto Detector : Peak</p>	 <p>Site : 03CH07.HY Condition : FCC CLASS-B (AVG) 3m HF-ANT_130829 VERTICAL RBW: 1000.000kHz VBW: 3.000kHz SWT: Auto Detector : Peak</p>

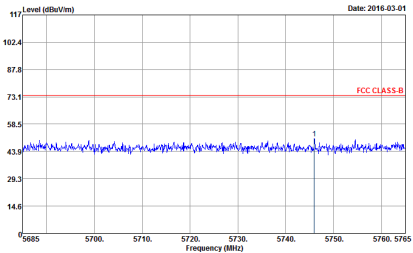
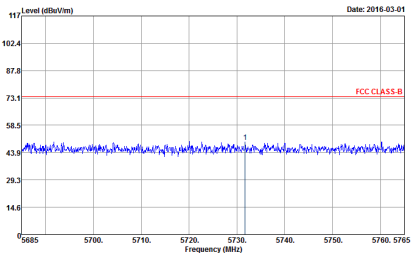
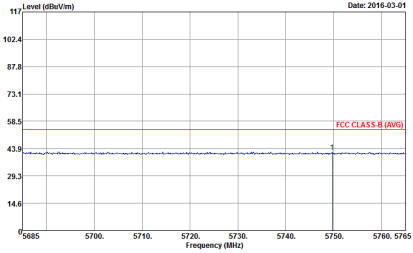
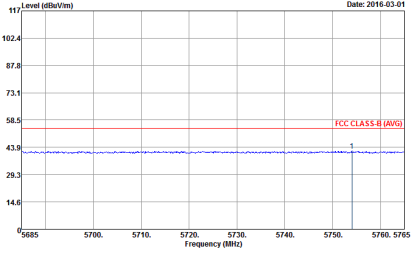

WIFI	Band 3 5470~5725MHz Band Edge @ 3m	
ANT	802.11n HT40 CH110 5550MHz - R	
1	Horizontal	Vertical
Peak	 <p>Site : 03CH07-HY Condition : FCC CLASS-B 3m HF-ANT_130829 HORIZONTAL RBW:1000.000kHz VBW:3000.000kHz SWT:Auto Detector : Peak</p>	 <p>Site : 03CH07-HY Condition : FCC CLASS-B 3m HF-ANT_130829 VERTICAL RBW:1000.000kHz VBW:3000.000kHz SWT:Auto Detector : Peak</p>
Avg.	 <p>Site : 03CH07-HY Condition : FCC CLASS-B (AVG) 3m HF-ANT_130829 HORIZONTAL RBW:1000.000kHz VBW:3.000kHz SWT:Auto Detector : Peak</p>	 <p>Site : 03CH07-HY Condition : FCC CLASS-B (AVG) 3m HF-ANT_130829 VERTICAL RBW:1000.000kHz VBW:3.000kHz SWT:Auto Detector : Peak</p>



WIFI	Band 3 5470~5725MHz Band Edge @ 3m	
ANT	802.11n HT40 CH134 5670MHz - L	
1	Horizontal	Vertical
Peak	<p>Site : 03CH07.HY Condition : FCC CLASS-B 3m HF-ANT_130829 HORIZONTAL RBW:1000.000kHz VBW:3000.000kHz SWT:Auto Detector : Peak</p>	<p>Site : 03CH07.HY Condition : FCC CLASS-B 3m HF-ANT_130829 VERTICAL RBW:1000.000kHz VBW:3000.000kHz SWT:Auto Detector : Peak</p>
Avg.	<p>Site : 03CH07.HY Condition : FCC CLASS-B (AVG) 3m HF-ANT_130829 HORIZONTAL RBW:1000.000kHz VBW:3.000kHz SWT:Auto Detector : Peak</p>	<p>Site : 03CH07.HY Condition : FCC CLASS-B (AVG) 3m HF-ANT_130829 VERTICAL RBW:1000.000kHz VBW:3.000kHz SWT:Auto Detector : Peak</p>



WIFI	Band 3 5470~5725MHz Band Edge @ 3m	
ANT	802.11n HT40 CH134 5670MHz - R	
1	Horizontal	Vertical
Peak	<p>Site : 03CH07.HY Condition : FCC CLASS-B 3m HF-ANT_130829 HORIZONTAL RBW: 1000.000kHz VBW: 3000.000kHz SWT: Auto Detector : Peak</p>	<p>Site : 03CH07.HY Condition : FCC CLASS-B 3m HF-ANT_130829 VERTICAL RBW: 1000.000kHz VBW: 3000.000kHz SWT: Auto Detector : Peak</p>
Avg.	<p>Site : 03CH07.HY Condition : FCC CLASS-B (AVG) 3m HF-ANT_130829 HORIZONTAL RBW: 1000.000kHz VBW: 3.000kHz SWT: Auto Detector : Peak</p>	<p>Site : 03CH07.HY Condition : FCC CLASS-B (AVG) 3m HF-ANT_130829 VERTICAL RBW: 1000.000kHz VBW: 3.000kHz SWT: Auto Detector : Peak</p>



Band 3 - 5470~5725MHz
WIFI 802.11a (Harmonic @ 3m)

WIFI	Band 3 5470~5725MHz Harmonic @ 3m	
ANT	802.11a CH100 5500MHz	
1	Horizontal	Vertical
Peak Avg.	<p>Site : 03CH07.HY Condition : FCC CLASS-B 3m SHF-EHF_131029 HORIZONTAL Detector : Peak</p>	<p>Site : 03CH07.HY Condition : FCC CLASS-B 3m SHF-EHF_131029 VERTICAL Detector : Peak</p>



WIFI	Band 3 5470-5725MHz Harmonic @ 3m	
ANT	802.11a CH116 5580MHz	
1	Horizontal	Vertical
Peak Avg.	<p>Site : 03CH07.HY Condition : FCC CLASS-B 3m SHF-EHF_131029 HORIZONTAL Detector : Peak</p>	<p>Site : 03CH07.HY Condition : FCC CLASS-B 3m SHF-EHF_131029 VERTICAL Detector : Peak</p>



WIFI	Band 3 5470-5725MHz Harmonic @ 3m	
ANT	802.11a CH140 5700MHz	
1	Horizontal	Vertical
Peak Avg.	<p>Site : 03CH07-HY Condition : FCC CLASS-B 3m SHF-EHF_131029 HORIZONTAL Detector : Peak</p>	<p>Site : 03CH07-HY Condition : FCC CLASS-B 3m SHF-EHF_131029 VERTICAL Detector : Peak</p>



Band 3 5470~5725MHz
WIFI 802.11n HT20 (Harmonic @ 3m)

Table with 3 columns: WIFI, ANT, and 1. It contains two graphs: 'Horizontal' and 'Vertical'. Each graph plots Level (dBuV/m) vs Frequency (MHz) with FCC CLASS-B and FCC CLASS-B (AVG) limits. The graphs show two peaks labeled 1 and 2, both well below the limits.



WIFI	Band 3 5470-5725MHz Harmonic @ 3m	
ANT	802.11n HT20 CH116 5580MHz	
1	Horizontal	Vertical
<p>Peak Avg.</p>	<p>Site : 03CH07.HY Condition : FCC CLASS-B 3m SHF-EHF_131029 HORIZONTAL Detector : Peak</p>	<p>Site : 03CH07.HY Condition : FCC CLASS-B 3m SHF-EHF_131029 VERTICAL Detector : Peak</p>



WIFI	Band 3 5470-5725MHz Harmonic @ 3m	
ANT	802.11n HT20 CH140 5700MHz	
1	Horizontal	Vertical
Peak Avg.	<p>Site : 03CH07-HY Condition : FCC CLASS-B 3m SHF-EHF_131029 HORIZONTAL Detector : Peak</p>	<p>Site : 03CH07-HY Condition : FCC CLASS-B 3m SHF-EHF_131029 VERTICAL Detector : Peak</p>



Band 3 5470~5725MHz
WIFI 802.11n HT40 (Harmonic @ 3m)

WIFI	Band 3 5470~5725MHz Harmonic @ 3m	
ANT	802.11n HT40 CH102 5510MHz	
1	Horizontal	Vertical
Peak Avg.	<p>Site : 03CH07-HY Condition : FCC CLASS-B 3m SHF-EHF_131029 HORIZONTAL Detector : Peak</p>	<p>Site : 03CH07-HY Condition : FCC CLASS-B 3m SHF-EHF_131029 VERTICAL Detector : Peak</p>



WIFI	Band 3 5470-5725MHz Harmonic @ 3m	
ANT	802.11n HT40 CH110 5550MHz	
1	Horizontal	Vertical
Peak Avg.	<p>Site : 03CH07.HY Condition : FCC CLASS-B 3m SHF-EHF_131029 HORIZONTAL Detector : Peak</p>	<p>Site : 03CH07.HY Condition : FCC CLASS-B 3m SHF-EHF_131029 VERTICAL Detector : Peak</p>



WIFI	Band 3 5470-5725MHz Harmonic @ 3m	
ANT	802.11n HT40 CH134 5670MHz	
1	Horizontal	Vertical
Peak Avg.	<p>Site : 03CH7-HY Condition : FCC CLASS-B 3m SHF-EHF_131029 HORIZONTAL Detector : Peak</p>	<p>Site : 03CH7-HY Condition : FCC CLASS-B 3m SHF-EHF_131029 VERTICAL Detector : Peak</p>



**Emission below 1GHz
5GHz WIFI 802.11n HT20 (LF)**

WIFI	5GHz WIFI	
ANT	802.11n HT20 LF	
1	Horizontal	Vertical
QP / Peak	<p>Site : 03CH07-HY Condition : FCC CLASS-B 3m LF-ANT-35419(6) HORIZONTAL Detector : Peak</p>	<p>Site : 03CH07-HY Condition : FCC CLASS-B 3m LF-ANT-35419(6) VERTICAL Detector : Peak</p>