



# FCC RF Test Report

APPLICANT : Motorola Mobility, LLC  
EQUIPMENT : Mobile Cellular Phone  
BRAND NAME : Motorola  
MODEL NAME : 8028  
FCC ID : IHDT56VA2  
STANDARD : FCC Part 15 Subpart C §15.247  
CLASSIFICATION : (DTS) Digital Transmission System

The product was received on Feb. 03, 2016 and testing was completed on Mar. 03, 2016. We, SPORTON INTERNATIONAL INC., would like to declare that the tested sample has been evaluated in accordance with the test procedures and has been in compliance with the applicable technical standards.

The test results in this report apply exclusively to the tested model / sample. Without written approval of SPORTON INTERNATIONAL INC., the test report shall not be reproduced except in full.

Reviewed by: Joseph Lin / Supervisor

Approved by: Jones Tsai / Manager



## SPORTON INTERNATIONAL INC.

No. 52, Hwa Ya 1<sup>st</sup> Rd., Hwa Ya Technology Park, Kwei-Shan District, Tao Yuan City, Taiwan, R.O.C.

SPORTON INTERNATIONAL INC.

TEL : 886-3-327-3456

FAX : 886-3-328-4978

FCC ID : IHDT56VA2

Page Number : 1 of 39

Report Issued Date : Apr. 28, 2016

Report Version : Rev. 02

Report Template No.: BU5-FR15CWL Version 1.2



# TABLE OF CONTENTS

**REVISION HISTORY ..... 3**

**SUMMARY OF TEST RESULT ..... 4**

**1 GENERAL DESCRIPTION ..... 5**

    1.1 Applicant ..... 5

    1.2 Manufacturer ..... 5

    1.3 Product Feature of Equipment Under Test ..... 5

    1.4 Product Specification of Equipment Under Test ..... 6

    1.5 Modification of EUT ..... 6

    1.6 Testing Location ..... 6

    1.7 Applicable Standards ..... 7

**2 TEST CONFIGURATION OF EQUIPMENT UNDER TEST ..... 8**

    2.1 Carrier Frequency Channel ..... 8

    2.2 Pre-Scanned RF Power ..... 9

    2.3 Test Mode ..... 10

    2.4 Connection Diagram of Test System ..... 11

    2.5 Support Unit used in test configuration and system ..... 12

    2.6 EUT Operation Test Setup ..... 12

    2.7 Measurement Results Explanation Example ..... 12

**3 TEST RESULT ..... 13**

    3.1 6dB and 99% Bandwidth Measurement ..... 13

    3.2 Output Power Measurement ..... 15

    3.3 Power Spectral Density Measurement ..... 16

    3.4 Conducted Band Edges and Spurious Emission Measurement ..... 18

    3.5 Radiated Band Edges and Spurious Emission Measurement ..... 28

    3.6 AC Conducted Emission Measurement ..... 32

    3.7 Antenna Requirements ..... 37

**4 LIST OF MEASURING EQUIPMENT ..... 38**

**5 UNCERTAINTY OF EVALUATION ..... 39**

**APPENDIX A. CONDUCTED TEST RESULTS**

**APPENDIX B. RADIATED TEST RESULTS**

**APPENDIX C RADIATED SPURIOUS EMISSION PLOTS**





### SUMMARY OF TEST RESULT

Report Section	FCC Rule	Description	Limit	Result	Remark
3.1	15.247(a)(2)	6dB Bandwidth	$\geq 0.5\text{MHz}$	Pass	-
3.1	-	99% Bandwidth	-	Pass	-
3.2	15.247(b)	Power Output Measurement	$\leq 30\text{dBm}$	Pass	-
3.3	15.247(e)	Power Spectral Density	$\leq 8\text{dBm}/3\text{kHz}$	Pass	-
3.4	15.247(d)	Conducted Band Edges	$\leq 20\text{dBc}$	Pass	-
		Conducted Spurious Emission		Pass	-
3.5	15.247(d)	Radiated Band Edges and Radiated Spurious Emission	15.209(a) & 15.247(d)	Pass	Under limit 1.10 dB at 2483.760 MHz
3.6	15.207	AC Conducted Emission	15.207(a)	Pass	Under limit 13.40 dB at 3.222 MHz
3.7	15.203 & 15.247(b)	Antenna Requirement	N/A	Pass	-



# 1 General Description

## 1.1 Applicant

**Motorola Mobility, LLC**  
222 W. Merchandise Mart Plaza, Chicago IL 60654 USA

## 1.2 Manufacturer

**Motorola Mobility, LLC**  
222 W. Merchandise Mart Plaza, Chicago IL 60654 USA

## 1.3 Product Feature of Equipment Under Test

Product Feature	
<b>Equipment</b>	Mobile Cellular Phone
<b>Brand Name</b>	Motorola
<b>Model Name</b>	8028
<b>FCC ID</b>	IHDT56VA2
<b>IMEI Code</b>	354117070006154 (for Radiated Spurious Emission) 354117070005990 (for AC Conducted Emission)
<b>EUT supports Radios application</b>	GSM/EGPRS/WCDMA/HSPA/LTE/FM WLAN 11b/g/n HT20 WLAN 11a/n HT20/HT40 Bluetooth v3.0 EDR Bluetooth v4.0 LE
<b>HW Version</b>	DVT2
<b>EUT Stage</b>	Identical Prototype

**Remark:** The above EUT's information was declared by manufacturer. Please refer to the specifications or user's manual for more detailed description.

Accessory List	
<b>AC Adapter</b>	Brand Name : Motorola
	Model Name : SPN5866A
<b>USB Cable</b>	Brand Name : Motorola
	Model Name : SKN6462A
<b>Earphone</b>	Brand Name : Motorola
	Model Name : SJYN1181B



### 1.4 Product Specification of Equipment Under Test

Standards-related Product Specification	
<b>Tx/Rx Channel Frequency Range</b>	802.11b/g/n : 2412 MHz ~ 2462 MHz
<b>Maximum (Peak) Output Power to Antenna</b>	802.11b : 20.52 dBm (0.1127 W) 802.11g : 23.20 dBm (0.2089 W) 802.11n HT20 : 22.81 dBm (0.1910 W)
<b>99% Occupied Bandwidth</b>	802.11b : 14.00MHz 802.11g : 18.70MHz 802.11n HT20 : 19.30MHz
<b>Antenna Type</b>	802.11b/g/n : Fixed Internal Antenna type (The antenna peak gain of EUT is less than 6 dBi)
<b>Type of Modulation</b>	802.11b : DSSS (DBPSK / DQPSK / CCK) 802.11g/n : OFDM (BPSK / QPSK / 16QAM / 64QAM)

### 1.5 Modification of EUT

No modifications are made to the EUT during all test items.

### 1.6 Testing Location

Sporton Lab is accredited to ISO 17025 by Taiwan Accreditation Foundation (TAF code : 1190) and the FCC designation No. TW1022 under the FCC 2.948(e) by Mutual Recognition Agreement (MRA) in FCC Test.

<b>Test Site</b>	SPORTON INTERNATIONAL INC.		
<b>Test Site Location</b>	No. 52, Hwa Ya 1 <sup>st</sup> Rd., Hwa Ya Technology Park, Kwei-Shan District, Tao Yuan City, Taiwan, R.O.C. TEL: +886-3-327-3456 FAX: +886-3-328-4978		
<b>Test Site No.</b>	<b>Sporton Site No.</b>		
	TH02-HY	CO05-HY	03CH07-HY

**Note:** The test site complies with ANSI C63.4 2014 requirement.



## 1.7 Applicable Standards

According to the specifications of the manufacturer, the EUT must comply with the requirements of the following standards:

- ♦ FCC Part 15 Subpart C §15.247
- ♦ FCC KDB Publication No. 558074 D01 DTS Meas. Guidance v03r05
- ♦ ANSI C63.10-2013

### **Remark:**

1. All test items were verified and recorded according to the standards and without any deviation during the test.
2. This EUT has also been tested and complied with the requirements of FCC Part 15, Subpart B, recorded in a separate test report.



## 2 Test Configuration of Equipment Under Test

The EUT has been associated with peripherals and configuration operated in a manner tended to maximize its emission characteristics in a typical application. Frequency range investigated: conducted emission (150 kHz to 30 MHz) and radiated emission (9 kHz to the 10th harmonic of the highest fundamental frequency or to 40 GHz, whichever is lower). For radiated measurement, pre-scanned in three orthogonal panels, X, Y, Z. The worst cases (Z plane) were recorded in this report.

The final configuration from all the combinations and the worst-case data rates were investigated by measuring the maximum power across all the data rates and modulation modes under section 2.2.

Based on the worst configuration found above, the RF power setting is set individually to meet FCC compliance limit for the final conducted and radiated tests shown in section 2.3.

### 2.1 Carrier Frequency Channel

Frequency Band	Channel	Freq. (MHz)	Channel	Freq. (MHz)
2400-2483.5 MHz	1	2412	7	2442
	2	2417	8	2447
	3	2422	9	2452
	4	2427	10	2457
	5	2432	11	2462
	6	2437	-	-



## 2.2 Pre-Scanned RF Power

Preliminary tests were performed in different data rate and data rate associated with the highest power were chosen for full test shown in the following tables.

Channel	Frequency	2.4GHz 802.11b RF Power (dBm)			
		DSSS Data Rate			
		1 Mbps	2 Mbps	5.5 Mbps	11 Mbps
CH 01	2412MHz	19.93	19.90	19.82	19.89
CH 06	2437MHz	19.37	19.30	19.27	19.36
CH 11	2462MHz	20.52	20.49	20.32	20.49

Channel	Frequency	2.4GHz 802.11b Average Power (dBm)			
		DSSS Data Rate			
		1 Mbps	2 Mbps	5.5 Mbps	11 Mbps
CH 01	2412MHz	17.62	17.59	17.60	17.61
CH 06	2437MHz	16.91	16.90	16.86	16.84
CH 11	2462MHz	18.15	18.09	17.84	18.15

Channel	Frequency	2.4GHz 802.11g RF Power (dBm)							
		OFDM Data Rate							
		6Mbps	9Mbps	12Mbps	18Mbps	24Mbps	36Mbps	48Mbps	54Mbps
CH 01	2412MHz	23.20	23.08	23.04	23.13	22.93	22.83	22.41	22.25
CH 06	2437MHz	22.86	22.67	22.80	22.74	22.61	22.34	21.21	21.53
CH 11	2462MHz	23.18	23.08	23.12	23.15	23.16	22.98	23.10	22.61

Channel	Frequency	2.4GHz 802.11g Average Power (dBm)							
		OFDM Data Rate							
		6Mbps	9Mbps	12Mbps	18Mbps	24Mbps	36Mbps	48Mbps	54Mbps
CH 01	2412MHz	15.78	15.62	15.69	15.71	15.74	15.17	14.30	13.81
CH 06	2437MHz	15.38	15.10	15.16	15.15	15.17	14.40	13.60	13.05
CH 11	2462MHz	15.66	15.60	15.64	15.60	15.58	15.23	15.44	13.65



Channel	Frequency	2.4GHz 802.11n HT20 RF Power (dBm)							
		OFDM Data Rate							
		MCS0	MCS1	MCS2	MCS3	MCS4	MCS5	MCS6	MCS7
CH 01	2412MHz	22.81	22.75	22.70	22.80	22.76	22.27	21.22	20.49
CH 06	2437MHz	22.62	22.60	22.59	22.59	22.60	21.53	20.79	20.32
CH 11	2462MHz	22.79	22.61	22.71	22.76	22.68	22.78	22.14	21.67

Channel	Frequency	2.4GHz 802.11n HT20 Average Power (dBm)							
		OFDM Data Rate							
		MCS0	MCS1	MCS2	MCS3	MCS4	MCS5	MCS6	MCS7
CH 01	2412MHz	15.43	15.22	15.22	15.27	15.17	14.12	13.11	12.24
CH 06	2437MHz	14.90	14.74	14.88	14.84	15.17	13.81	12.75	11.94
CH 11	2462MHz	14.95	14.93	14.89	14.94	14.93	14.79	13.90	12.95

### 2.3 Test Mode

Final test mode of conducted test items and radiated spurious emissions are considering the modulation and worse data rates from the power table described in section 2.2.

<2.4GHz>

Modulation	Data Rate
802.11b	1 Mbps
802.11g	6 Mbps
802.11n HT20	MCS0

Test Cases	
AC Conducted Emission	Mode 1 : GSM850 Idle + Bluetooth Link + WLAN (2.4GHz) Link + Earphone + MP3 + USB Cable (Charging from Adapter)

## 2.4 Connection Diagram of Test System

<WLAN Tx Mode>

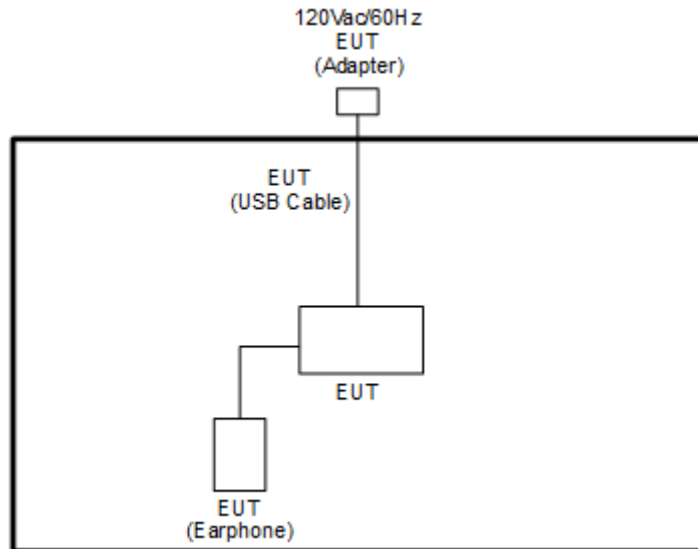

<AC Conducted Emission Mode>

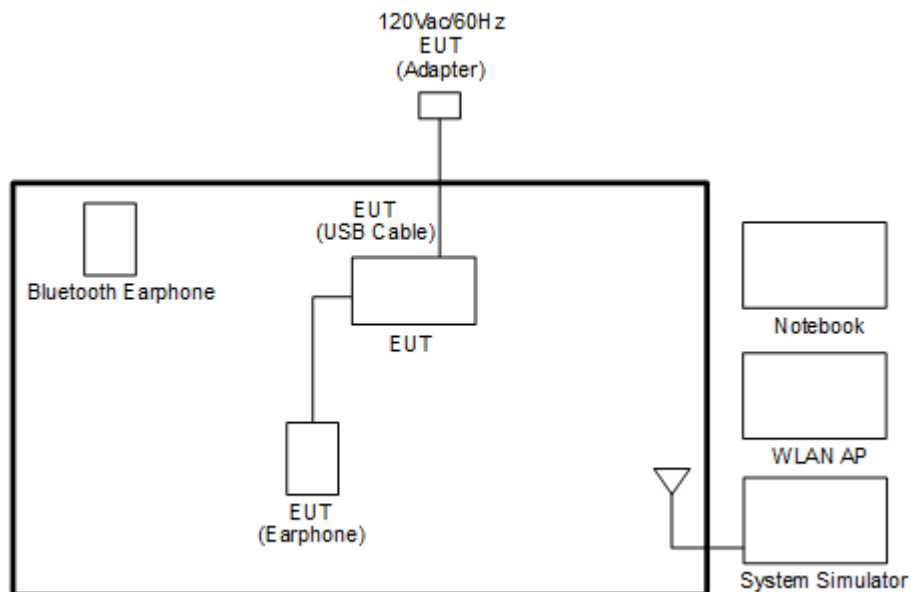



### 2.5 Support Unit used in test configuration and system

Item	Equipment	Trade Name	Model Name	FCC ID	Data Cable	Power Cord
1.	System Simulator	Anritsu	MT8820C	N/A	N/A	Unshielded, 1.8 m
2.	WLAN AP	D-Link	DIR-865L	KA2IR865LA1	N/A	Unshielded, 1.8 m
3.	Notebook	DELL	Latitude E6320	FCC DoC/ Contains FCC ID: QDS-BRCM1054	N/A	AC I/P: Unshielded, 1.2 m DC O/P: Shielded, 1.8 m
4.	Bluetooth Earphone	Sony Ericsson	MW600	PY7DDA-2029	N/A	N/A
5.	SD Card	SanDisk	MicroSD HC	FCC DoC	N/A	N/A

### 2.6 EUT Operation Test Setup

For WLAN function, programmed RF utility, "QRCT" installed in the notebook make the EUT provide functions like channel selection and power level for continuous transmitting and receiving signals.

### 2.7 Measurement Results Explanation Example

For all conducted test items:

The offset level is set in the spectrum analyzer to compensate the RF cable loss and attenuator factor between EUT conducted output port and spectrum analyzer. With the offset compensation, the spectrum analyzer reading level is exactly the EUT RF output level.

Example :

The spectrum analyzer offset is derived from RF cable loss and attenuator factor.

$$\text{Offset} = \text{RF cable loss} + \text{attenuator factor}.$$

Following shows an offset computation example with cable loss 4.2 dB and 10dB attenuator.

$$\begin{aligned} \text{Offset(dB)} &= \text{RF cable loss(dB)} + \text{attenuator factor(dB)}. \\ &= 4.2 + 10 = 14.2 \text{ (dB)} \end{aligned}$$

### 3 Test Result

#### 3.1 6dB and 99% Bandwidth Measurement

##### 3.1.1 Limit of 6dB and 99% Bandwidth

The minimum 6 dB bandwidth shall be at least 500 kHz.

##### 3.1.2 Measuring Instruments

The measuring equipment is listed in the section 4 of this test report.

##### 3.1.3 Test Procedures

1. The testing follows FCC KDB Publication No. 558074 DTS D01 Meas. Guidance v03r05.
2. The RF output of EUT was connected to the spectrum analyzer by RF cable and attenuator. The path loss was compensated to the results for each measurement.
3. Set to the maximum power setting and enable the EUT transmit continuously.
4. Make the measurement with the spectrum analyzer's resolution bandwidth (RBW) = 100 kHz. Set the Video bandwidth (VBW) = 300 kHz. In order to make an accurate measurement. The 6 dB bandwidth must be greater than 500 kHz.
5. For 99% Bandwidth Measurement, the spectrum analyzer's resolution bandwidth (RBW) = 1MHz and set the Video bandwidth (VBW) = 3MHz.
6. Measure and record the results in the test report.

##### 3.1.4 Test Setup

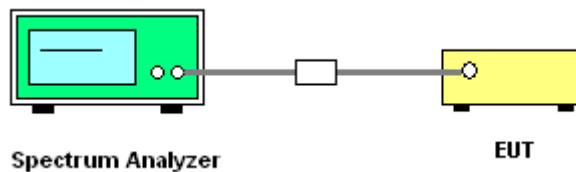



### 3.1.5 Test Result of 6dB and 99% Occupied Bandwidth

Please refer to Appendix A of this test report.

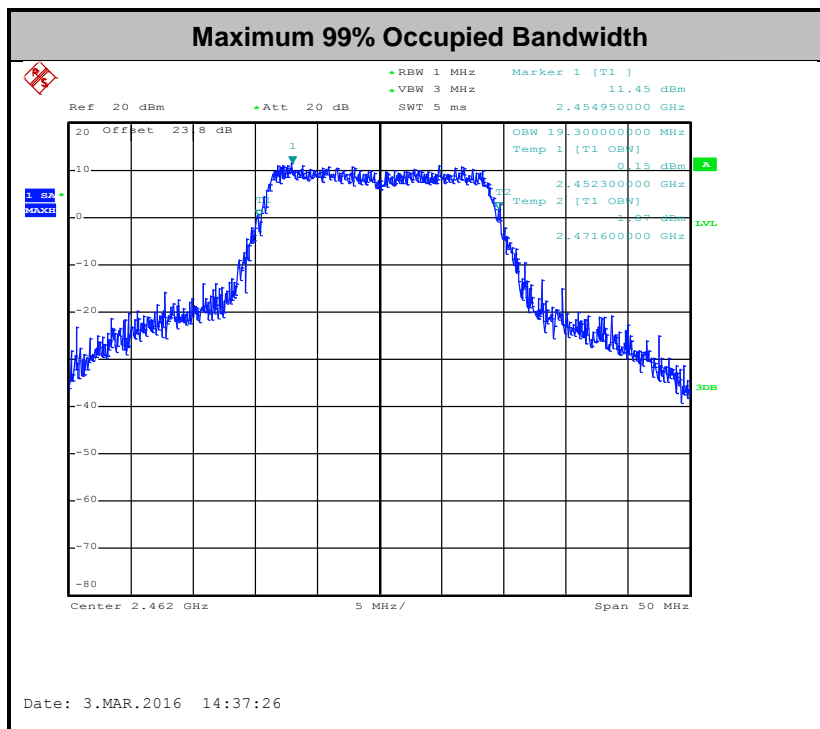
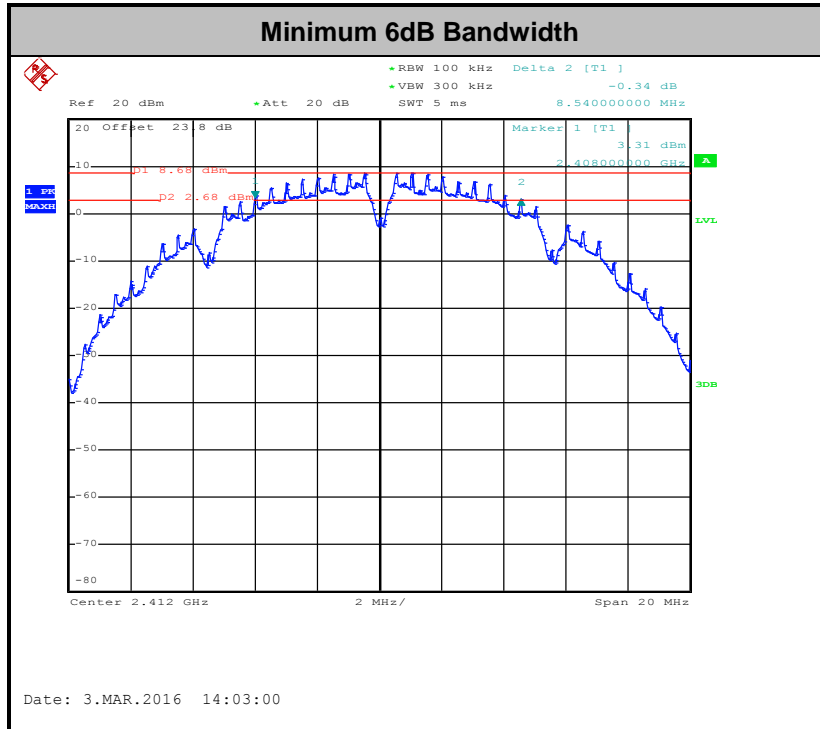

**Note:** The occupied channel bandwidth is maintained within the band of operation for all of the modulations.

## 3.2 Output Power Measurement

### 3.2.1 Limit of Output Power

For systems using digital modulation in the 2400-2483.5MHz, the limit for peak output power is 30dBm. If transmitting Antenna of directional gain greater than 6dBi are used the peak output power from the intentional radiator shall be reduced below the above stated value by the amount in dB that the directional gain of the Antenna exceeds 6 dBi. In case of point-to-point operation, the limit has to be reduced by 1dB for every 3dB that the directional gain of the Antenna exceeds 6dBi.

### 3.2.2 Measuring Instruments

The measuring equipment is listed in the section 4 of this test report.

### 3.2.3 Test Procedures

1. The testing follows the Measurement Procedure of FCC KDB No. 558074 DTS D01 Meas. Guidance v03r05 section 9.1.2 PKPM1 Peak power meter method.
2. The RF output of EUT was connected to the power meter by RF cable and attenuator. The path loss was compensated to the results for each measurement.
3. Set to the maximum power setting and enable the EUT transmit continuously.
4. Measure the conducted output power and record the results in the test report.

### 3.2.4 Test Setup

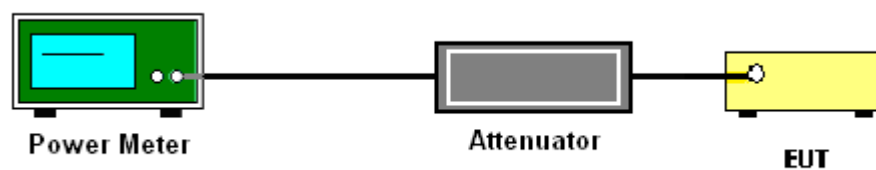

### 3.2.5 Test Result of Peak Output Power

Please refer to Appendix A of this test report.

### 3.2.6 Test Result of Average output Power (Reporting Only)

Please refer to Appendix A of this test report.

### 3.3 Power Spectral Density Measurement

#### 3.3.1 Limit of Power Spectral Density

The peak power spectral density shall not be greater than 8dBm in any 3kHz band at any time interval of continuous transmission.

#### 3.3.2 Measuring Instruments

The measuring equipment is listed in the section 4 of this test report.

#### 3.3.3 Test Procedures

1. The testing follows Measurement Procedure 10.2 Method PKPSD of FCC KDB Publication No. 558074 D01 DTS Meas. Guidance v03r05
2. The RF output of EUT was connected to the spectrum analyzer by RF cable and attenuator. The path loss was compensated to the results for each measurement.
3. Set to the maximum power setting and enable the EUT transmit continuously.
4. Make the measurement with the spectrum analyzer's resolution bandwidth (RBW) = 3 kHz. Video bandwidth VBW = 10 kHz In order to make an accurate measurement, set the span to 1.5 times DTS Channel Bandwidth. (6dB BW)
5. Detector = peak, Sweep time = auto couple, Trace mode = max hold, Allow trace to fully stabilize. Use the peak marker function to determine the maximum power level.
6. Measure and record the results in the test report.

#### 3.3.4 Test Setup

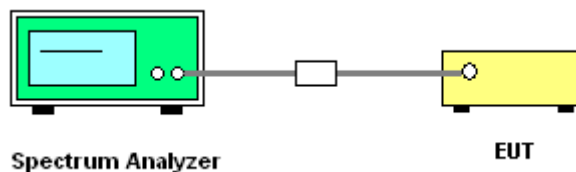



### 3.3.5 Test Result of Power Spectral Density

Please refer to Appendix A of this test report.

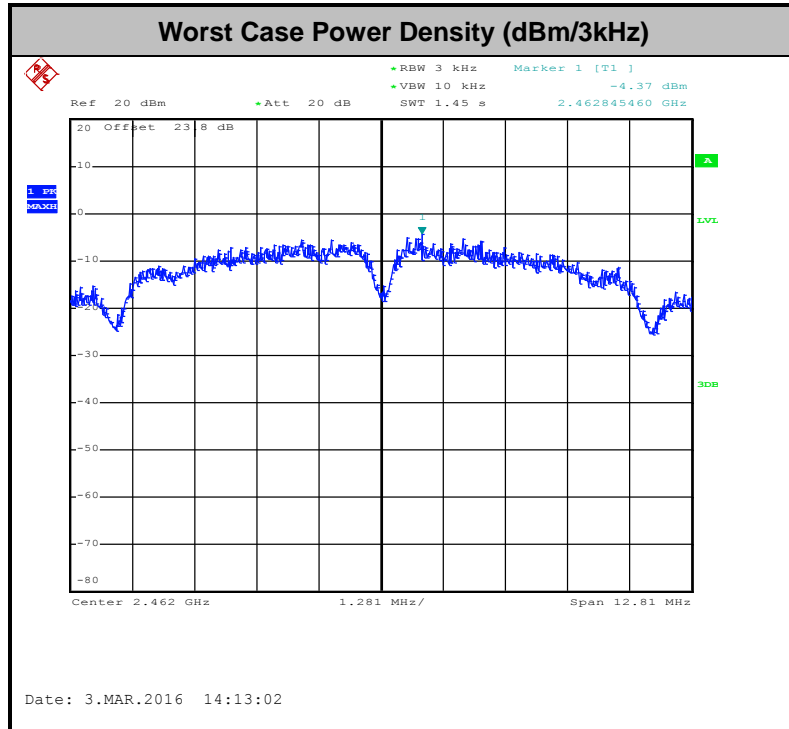

### 3.4 Conducted Band Edges and Spurious Emission Measurement

#### 3.4.1 Limit of Conducted Band Edges and Spurious Emission Measurement

In any 100 kHz bandwidth outside of the authorized frequency band, the emissions which fall in the non-restricted bands shall be attenuated at least 20 dB / 30dB relative to the maximum PSD level in 100 kHz by RF conducted measurement and radiated emissions which fall in the restricted bands, as defined in Section 15.205(a), must also comply with the radiated emission limits specified in Section 15.209(a).

#### 3.4.2 Measuring Instruments

The measuring equipment is listed in the section 4 of this test report.

#### 3.4.3 Test Procedures

1. The testing follows FCC KDB Publication No. 558074 D01 DTS Meas. Guidance v03r05.
2. The RF output of EUT was connected to the spectrum analyzer by RF cable and attenuator. The path loss was compensated to the results for each measurement.
3. Set to the maximum power setting and enable the EUT transmit continuously.
4. Set RBW = 100 kHz, VBW=300 kHz, Peak Detector. Unwanted Emissions measured in any 100 kHz bandwidth outside of the authorized frequency band shall be attenuated by at least 20 dB relative to the maximum in-band peak PSD level in 100 kHz when maximum peak conducted output power procedure is used. If the transmitter complies with the conducted power limits based on the use of RMS averaging over a time interval, the attenuation required under this paragraph shall be 30 dB instead of 20 dB per 15.247(d).
5. Measure and record the results in the test report.
6. The RF fundamental frequency should be excluded against the limit line in the operating frequency band.

#### 3.4.4 Test Setup

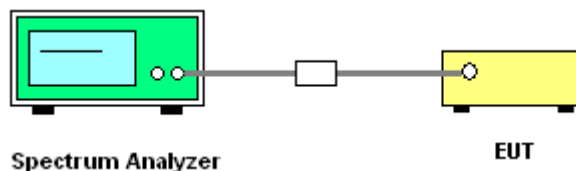



### 3.4.5 Test Result of Conducted Band Edges and Spurious Emission

Test Mode :	802.11b	Temperature :	21~25°C
Test Band :	2.4GHz Low	Relative Humidity :	51~54%
Test Channel :	01	Test Engineer :	AC Chang

#### WLAN 802.11b Channel 01

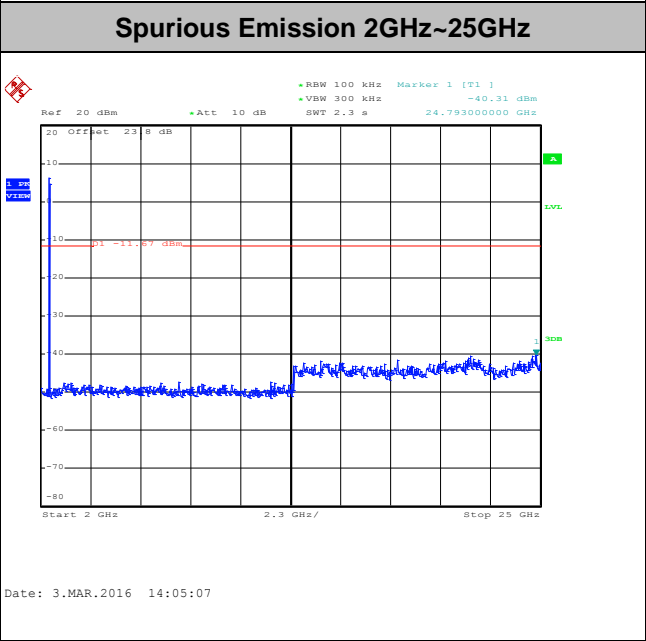
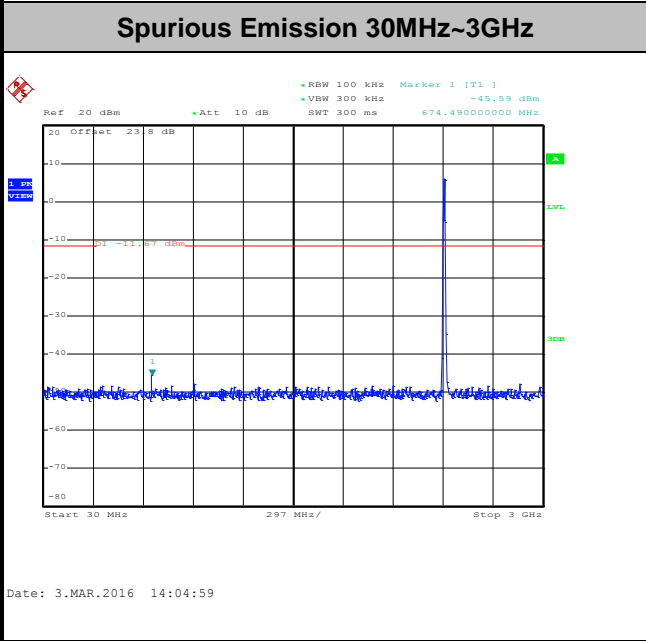
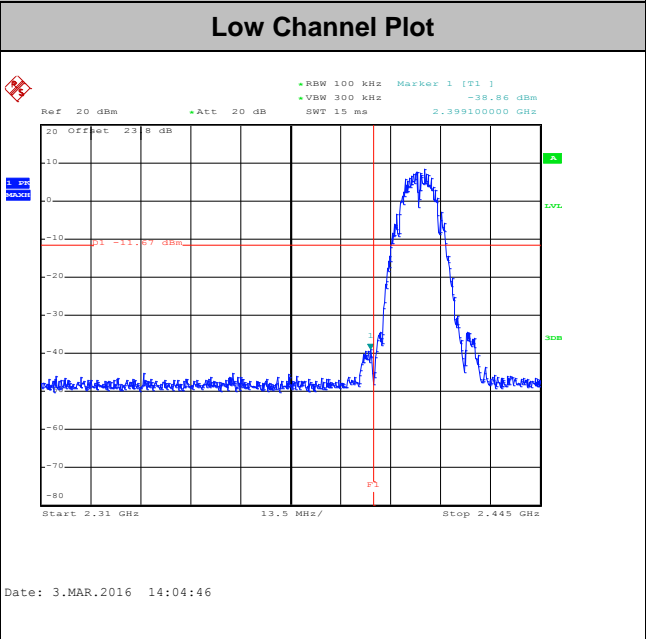
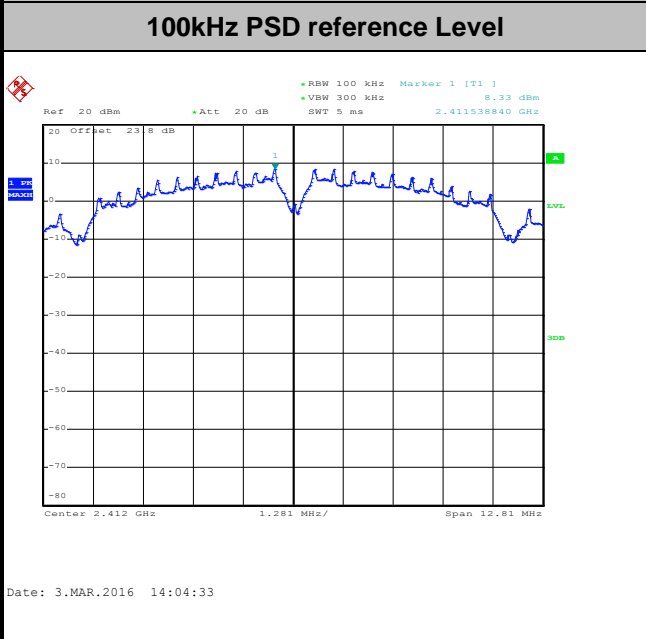



Test Mode :	802.11b	Temperature :	21~25°C
Test Band :	2.4GHz Mid	Relative Humidity :	51~54%
Test Channel :	06	Test Engineer :	AC Chang

WLAN 802.11b Channel 06

100kHz PSD reference Level

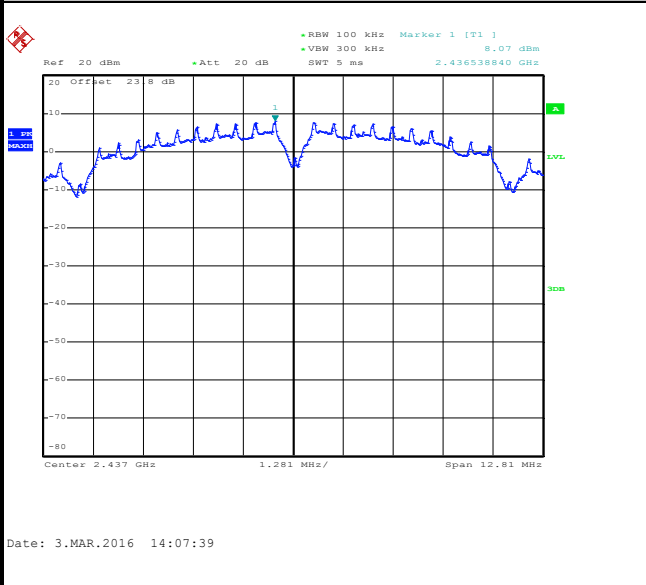

Spurious Emission 30MHz~3GHz

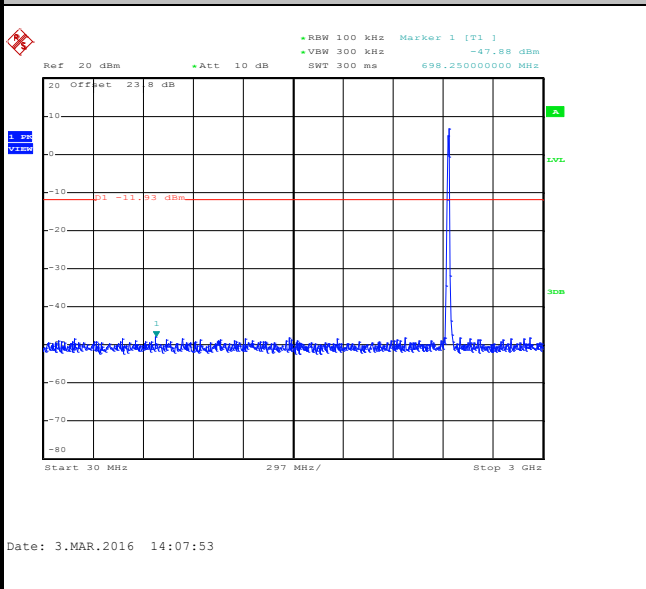

Spurious Emission 2GHz~25GHz

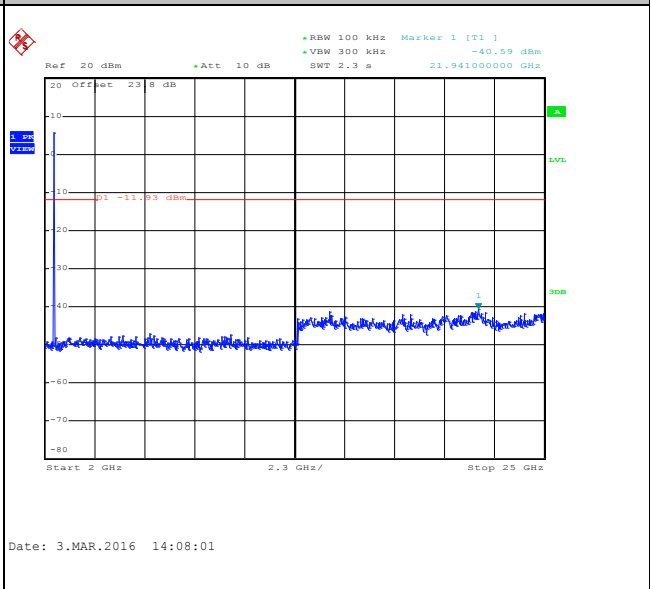



Test Mode :	802.11b	Temperature :	21~25°C
Test Band :	2.4GHz High	Relative Humidity :	51~54%
Test Channel :	11	Test Engineer :	AC Chang

WLAN 802.11b Channel 11

100kHz PSD reference Level

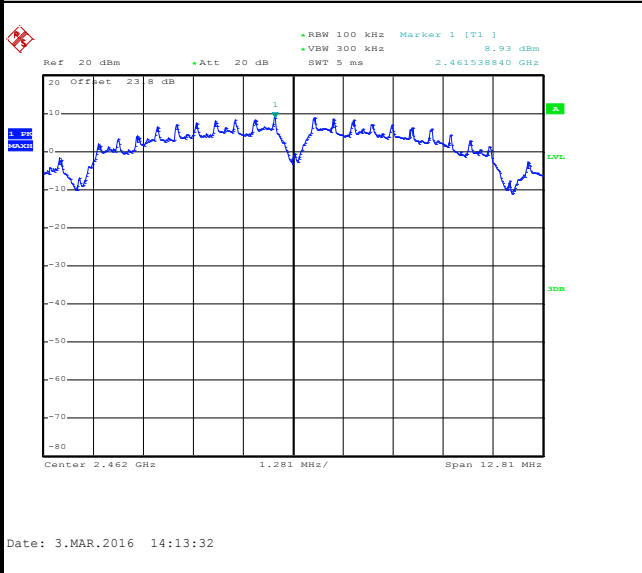

High Channel Plot

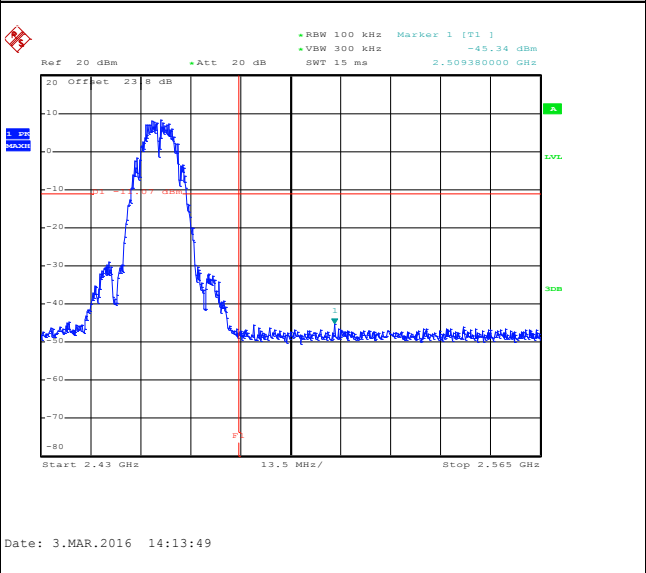

Spurious Emission 30MHz~3GHz

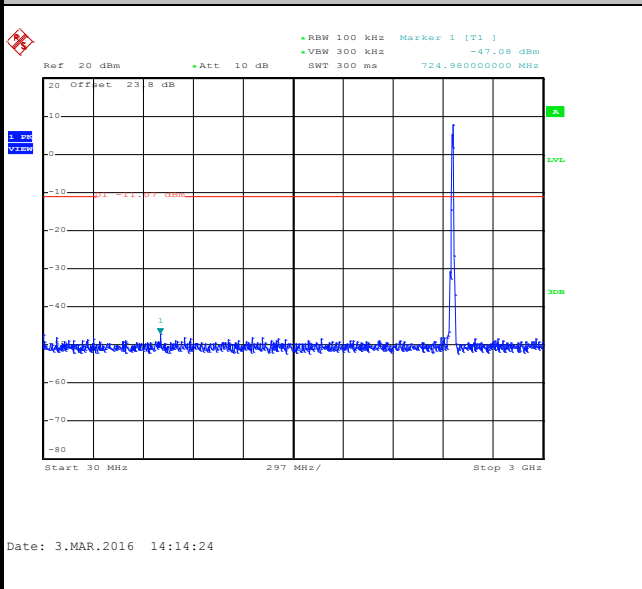

Spurious Emission 2GHz~25GHz

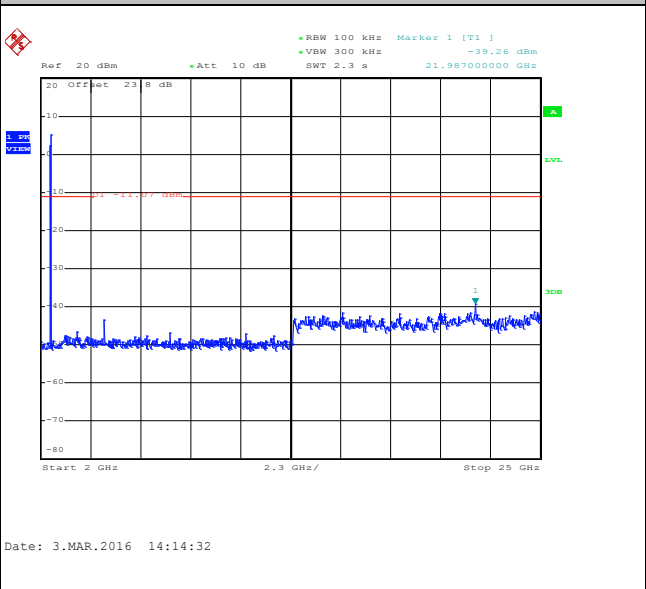



Test Mode :	802.11g	Temperature :	21~25°C
Test Band :	2.4GHz Low	Relative Humidity :	51~54%
Test Channel :	01	Test Engineer :	AC Chang

WLAN 802.11g Channel 01

100kHz PSD reference Level

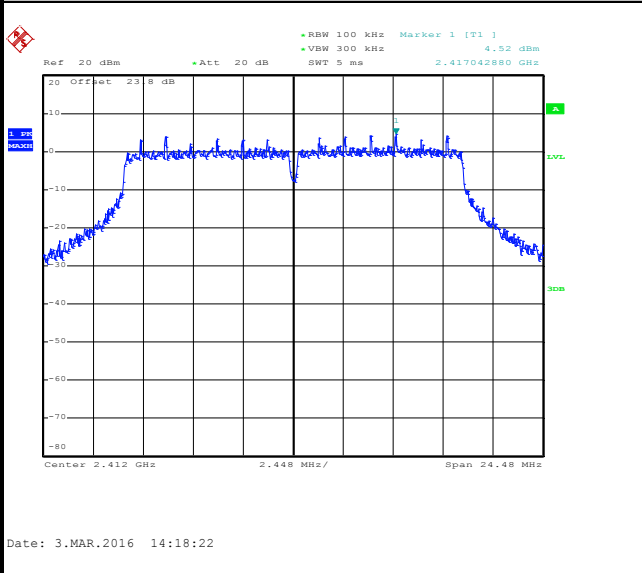

Low Channel Plot

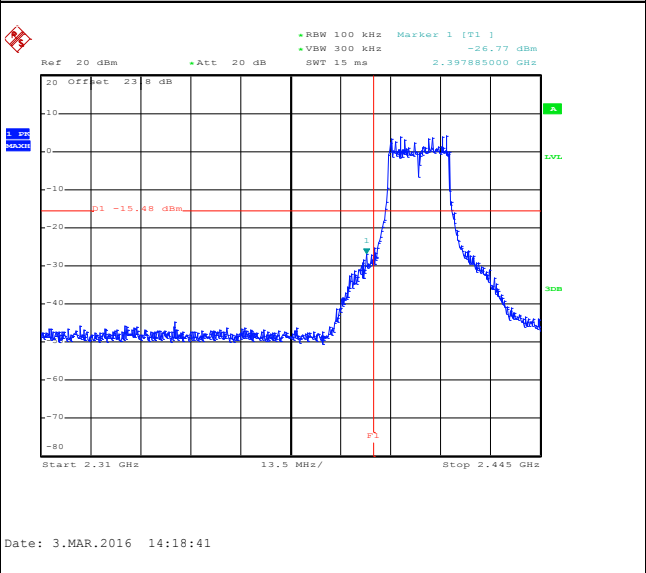

Spurious Emission 30MHz~3GHz

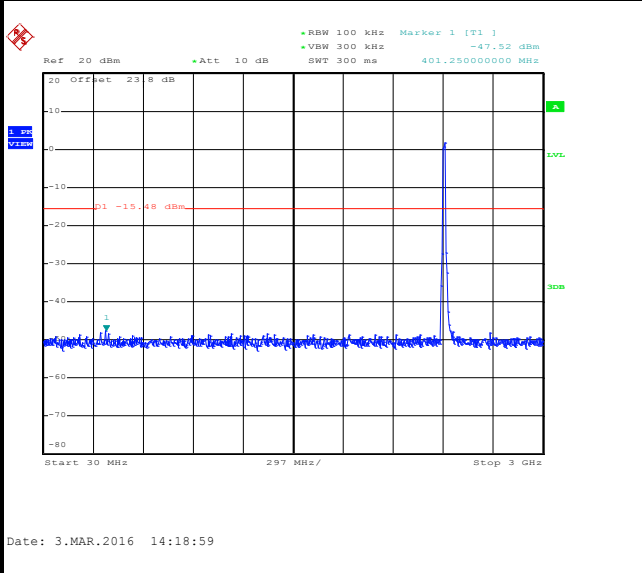

Spurious Emission 2GHz~25GHz

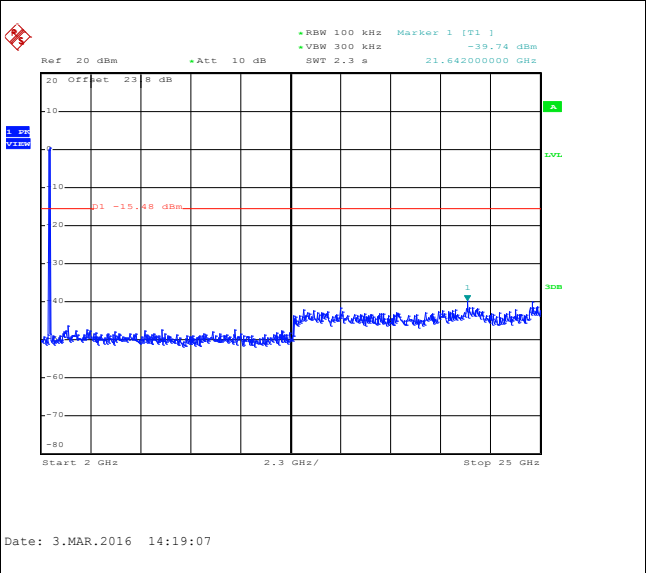



Test Mode :	802.11g	Temperature :	21~25°C
Test Band :	2.4GHz Mid	Relative Humidity :	51~54%
Test Channel :	06	Test Engineer :	AC Chang

WLAN 802.11g Channel 06

100kHz PSD reference Level

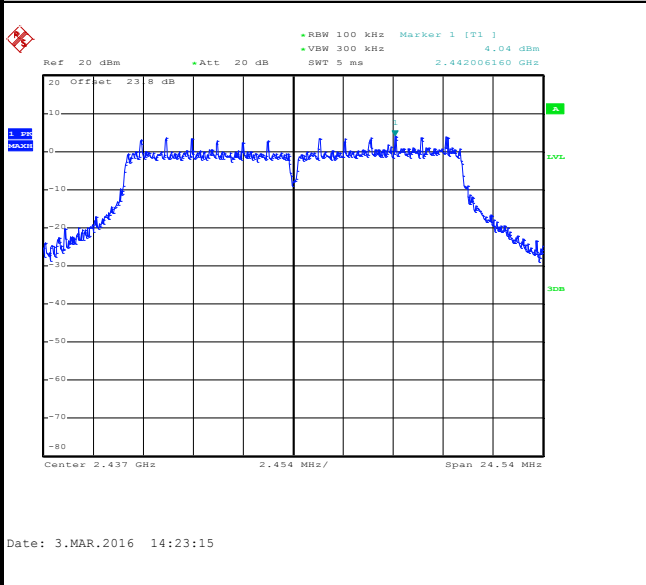

Spurious Emission 30MHz~3GHz

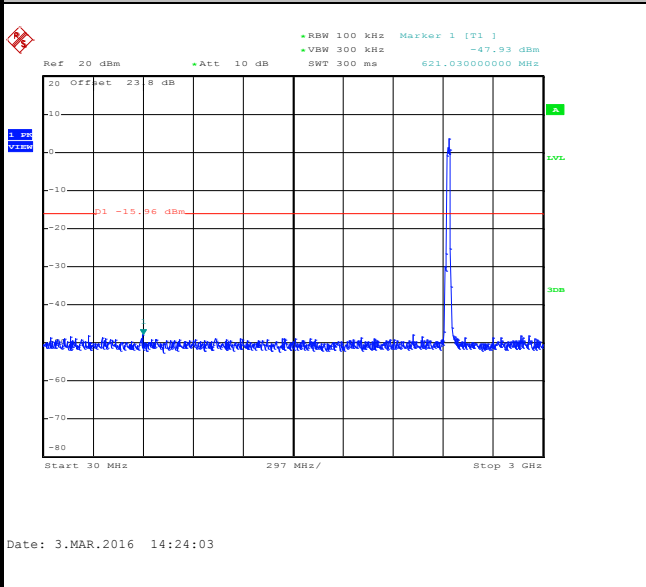

Spurious Emission 2GHz~25GHz

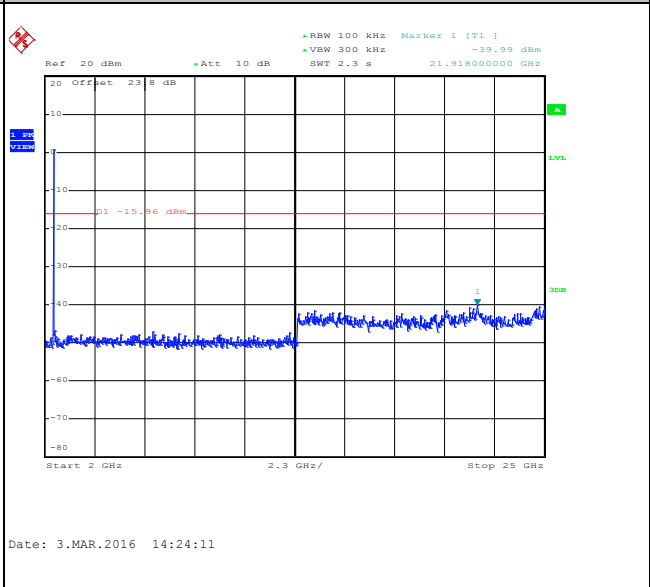



Test Mode :	802.11g	Temperature :	21~25°C
Test Band :	2.4GHz High	Relative Humidity :	51~54%
Test Channel :	11	Test Engineer :	AC Chang

WLAN 802.11g Channel 11

100kHz PSD reference Level

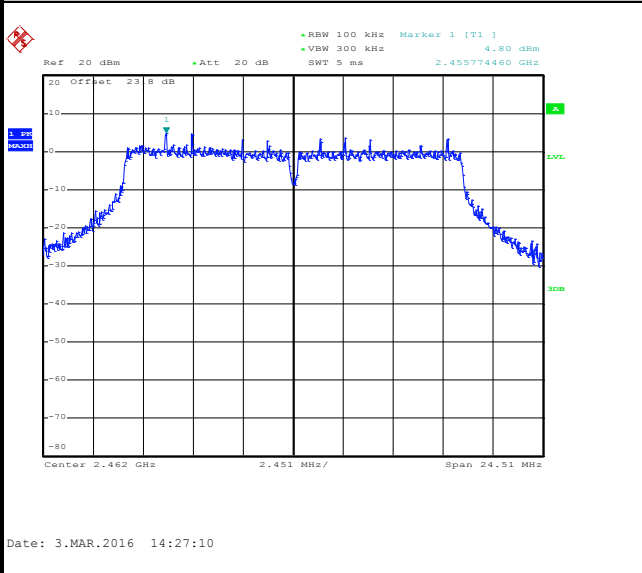

High Channel Plot

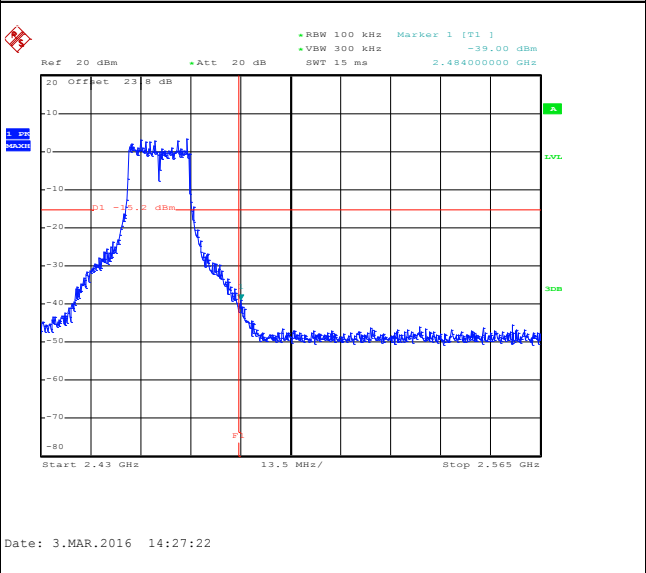

Spurious Emission 30MHz~3GHz

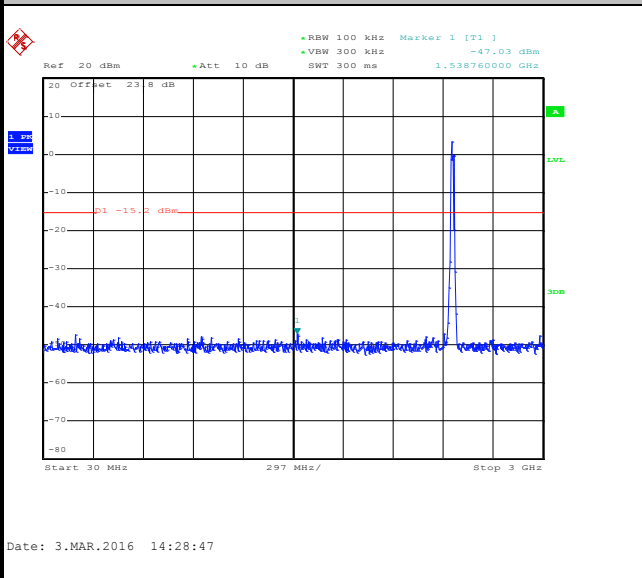

Spurious Emission 2GHz~25GHz

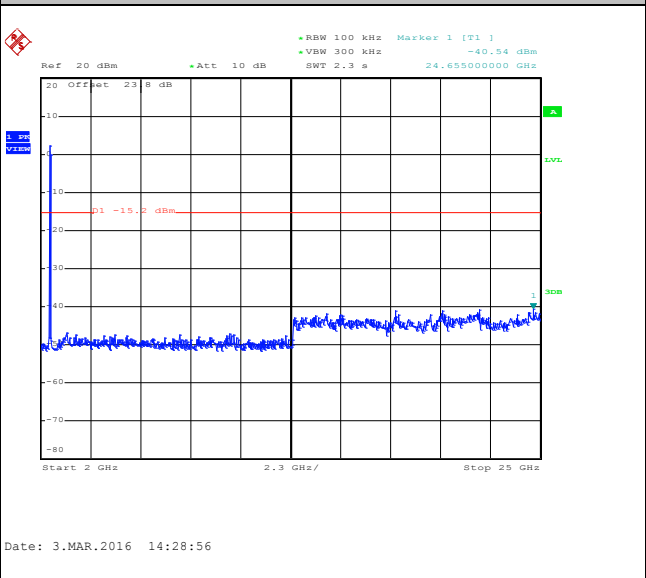



Test Mode :	802.11n HT20	Temperature :	21~25°C
Test Band :	2.4GHz Low	Relative Humidity :	51~54%
Test Channel :	01	Test Engineer :	AC Chang

WLAN 802.11n HT20 Channel 01

100kHz PSD reference Level

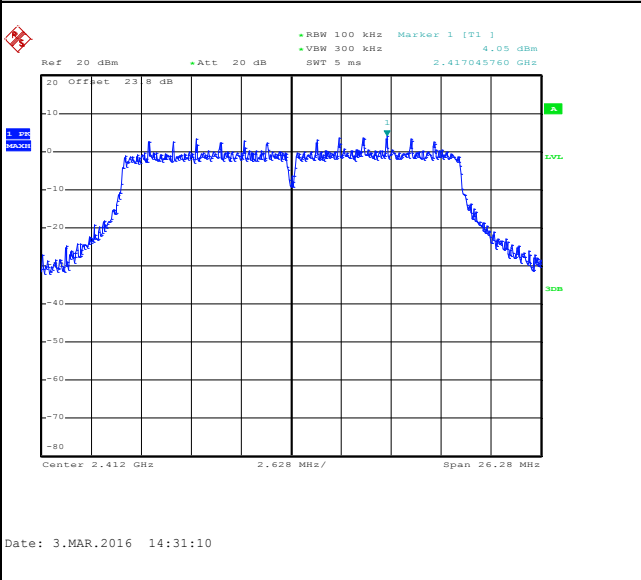

Low Channel Plot

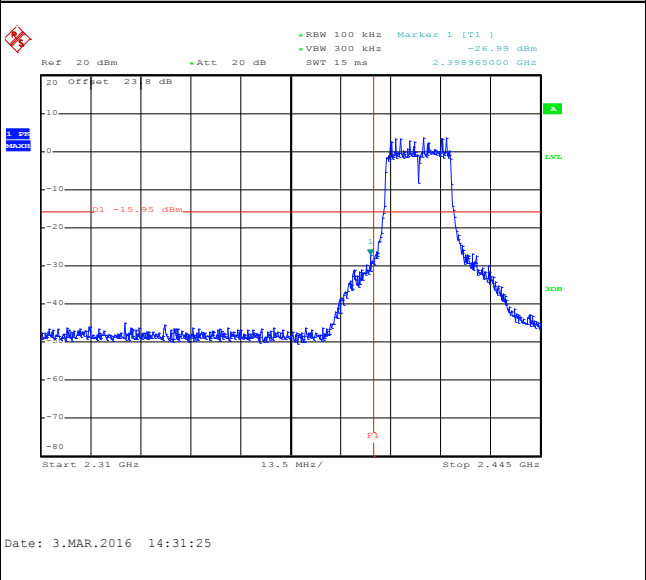

Spurious Emission 30MHz~3GHz

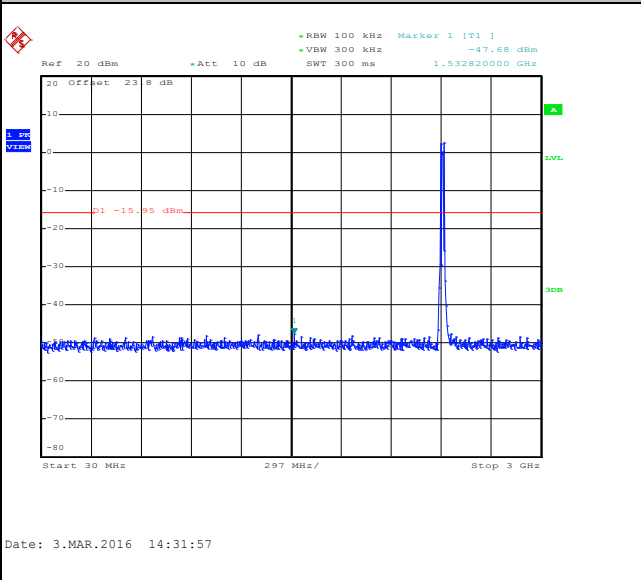

Spurious Emission 2GHz~25GHz

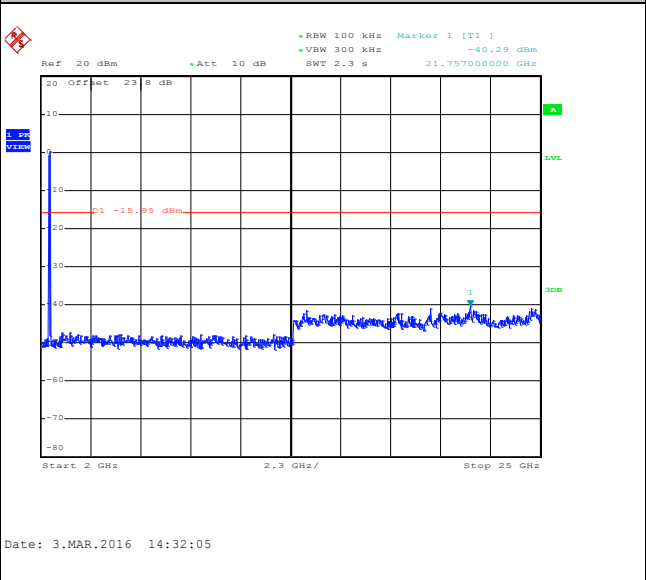



Test Mode :	802.11n HT20	Temperature :	21~25°C
Test Band :	2.4GHz Mid	Relative Humidity :	51~54%
Test Channel :	06	Test Engineer :	AC Chang

WLAN 802.11n HT20 Channel 06

100kHz PSD reference Level

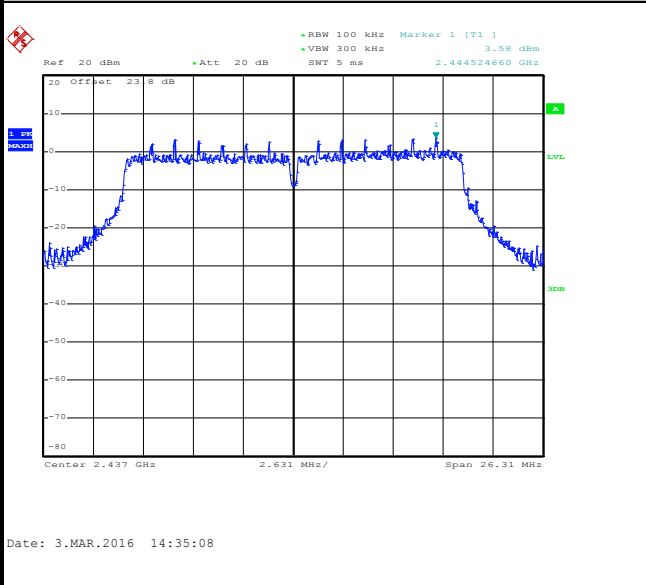

Spurious Emission 30MHz~3GHz

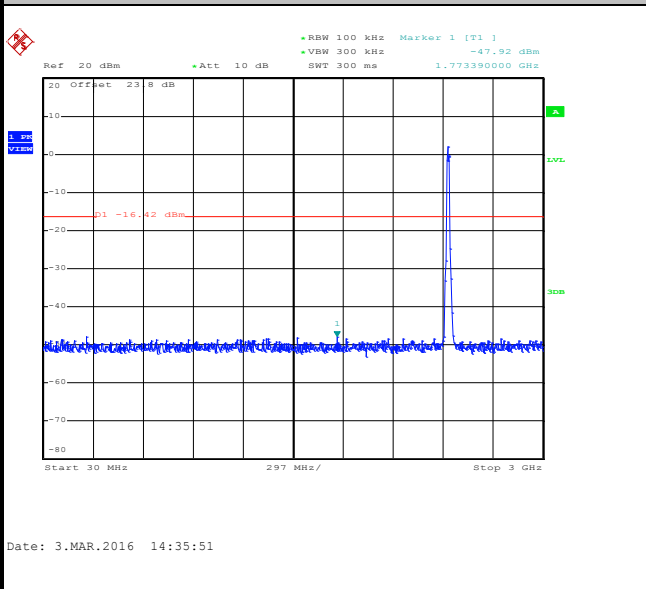

Spurious Emission 2GHz~25GHz

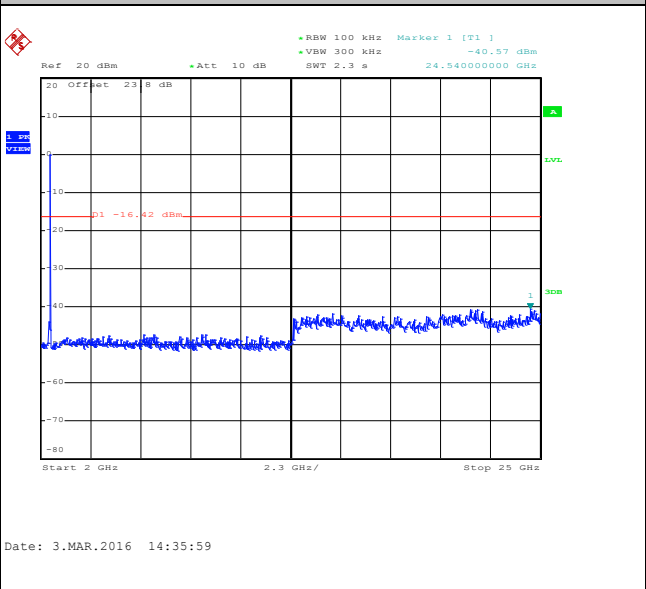



Test Mode :	802.11n HT20	Temperature :	21~25°C
Test Band :	2.4GHz High	Relative Humidity :	51~54%
Test Channel :	11	Test Engineer :	AC Chang

WLAN 802.11n HT20 Channel 11

100kHz PSD reference Level

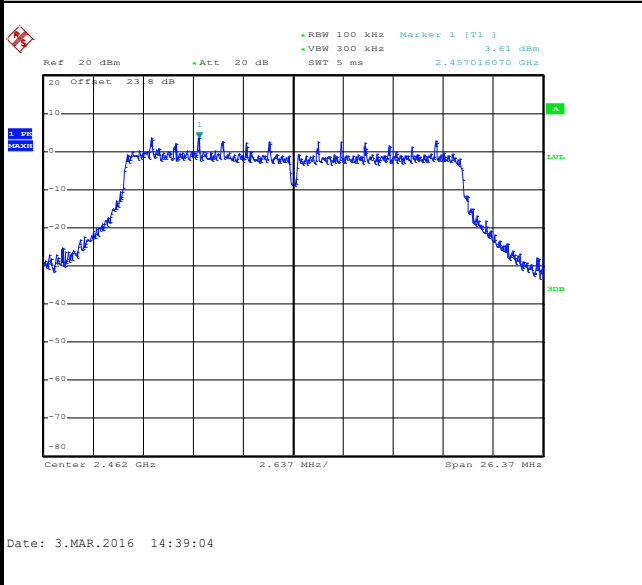

High Channel Plot

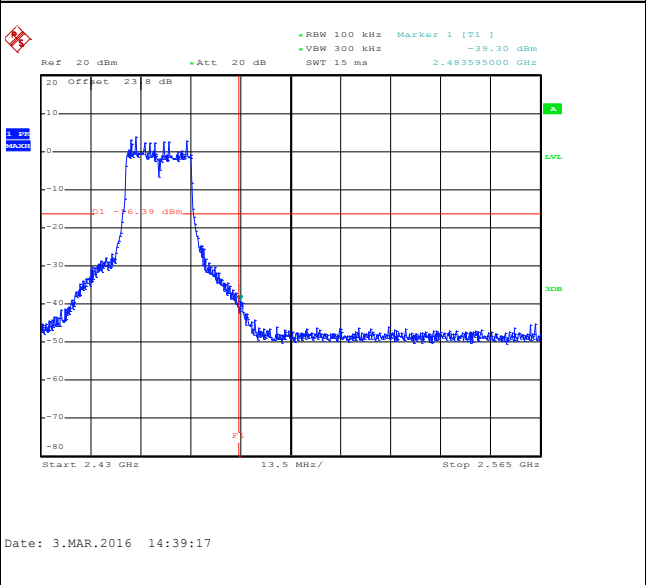

Spurious Emission 30MHz~3GHz

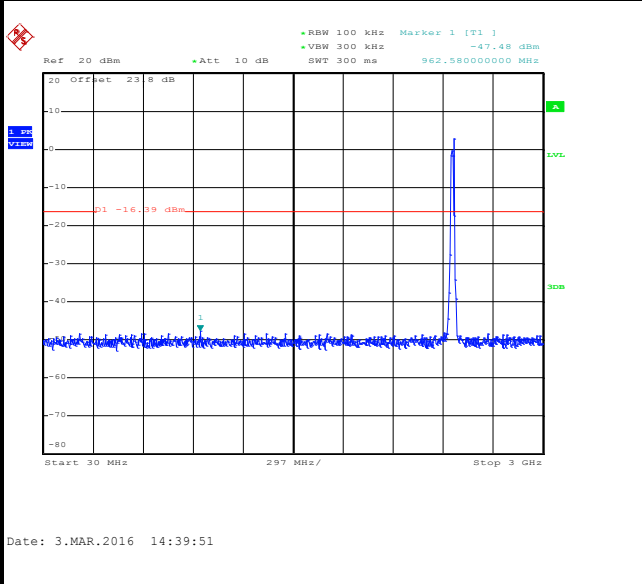

Spurious Emission 2GHz~25GHz

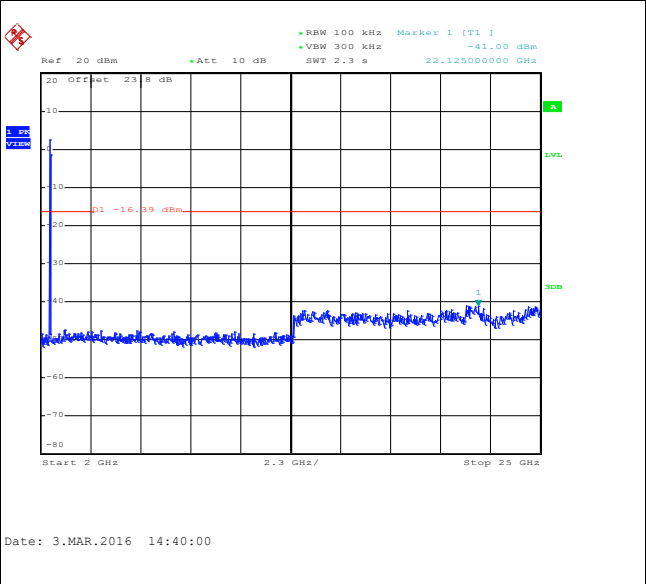



### 3.5 Radiated Band Edges and Spurious Emission Measurement

#### 3.5.1 Limit of Radiated band edge and Spurious Emission Measurement

In any 100 kHz bandwidth outside the intentional radiator frequency band, all harmonics/spurious must be at least 20 dB below the highest emission level within the authorized band. If the output power of this device was measured by spectrum analyzer, the attenuation under this paragraph shall be 30 dB instead of 20 dB. In addition, radiated emissions which fall in the restricted bands must also comply with the FCC section 15.209 limits as below.

Frequency (MHz)	Field Strength (microvolts/meter)	Measurement Distance (meters)
0.009 – 0.490	2400/F(kHz)	300
0.490 – 1.705	24000/F(kHz)	30
1.705 – 30.0	30	30
30 – 88	100	3
88 – 216	150	3
216 - 960	200	3
Above 960	500	3

#### 3.5.2 Measuring Instruments

The measuring equipment is listed in the section 4 of this test report.



3.5.3 Test Procedures

1. The testing follows ANSI C63.10-2013.
2. The EUT was arranged to its worst case and then tune the antenna tower (from 1 m to 4 m) and turntable (from 0 degree to 360 degrees) to find the maximum reading. A pre-amp and a high pass filter are used for the test in order to get better signal level.
3. The EUT was placed on a turntable with 0.8 meter for frequency below 1GHz and 1.5 meter for frequency above 1GHz respectively above ground.
4. The EUT was set 3 meters from the interference receiving antenna, which was mounted on the top of a variable height antenna tower.
5. Corrected Reading: Antenna Factor + Cable Loss + Read Level - Preamp Factor = Level
6. For measurement below 1GHz, If the emission level of the EUT measured by the peak detector is 3 dB lower than the applicable limit, the peak emission level will be reported. Otherwise, the emission measurement will be repeated using the quasi-peak detector and reported.
7. Use the following spectrum analyzer settings:
  - (1) Span shall wide enough to fully capture the emission being measured;
  - (2) Set RBW=100 kHz for  $f < 1 \text{ GHz}$ ;  $\text{VBW} \geq \text{RBW}$ ; Sweep = auto; Detector function = peak; Trace = max hold;
  - (3) Set RBW = 1 MHz, VBW= 3MHz for  $f \geq 1 \text{ GHz}$  for peak measurement.  
For average measurement:
    - $\text{VBW} = 10 \text{ Hz}$ , when duty cycle is no less than 98 percent.
    - $\text{VBW} \geq 1/T$ , when duty cycle is less than 98 percent where T is the minimum transmission duration over which the transmitter is on and is transmitting at its maximum power control level for the tested mode of operation.

Band	Duty Cycle(%)	T(μs)	1/T(kHz)	VBW Setting
802.11b	97.16	8200	0.12	300Hz
802.11g	87.18	1360	0.74	1kHz
2.4GHz 802.11n HT20	85.14	1260	0.79	1kHz

### 3.5.4 Test Setup

For radiated emissions below 30MHz

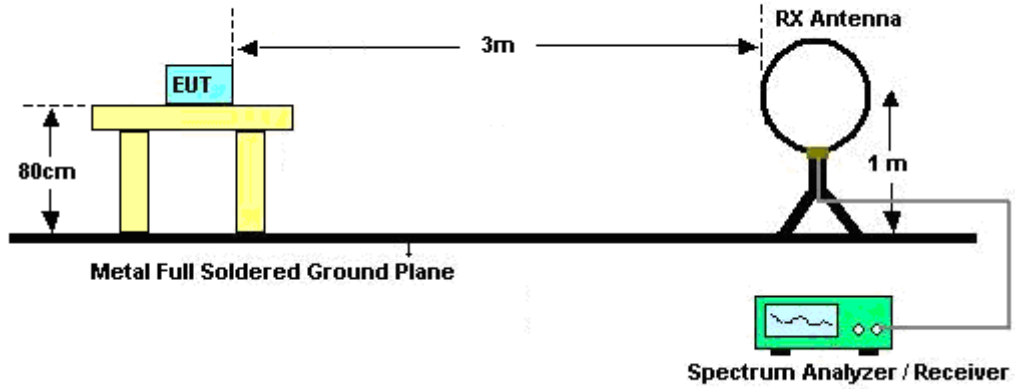

For radiated emissions from 30MHz to 1GHz

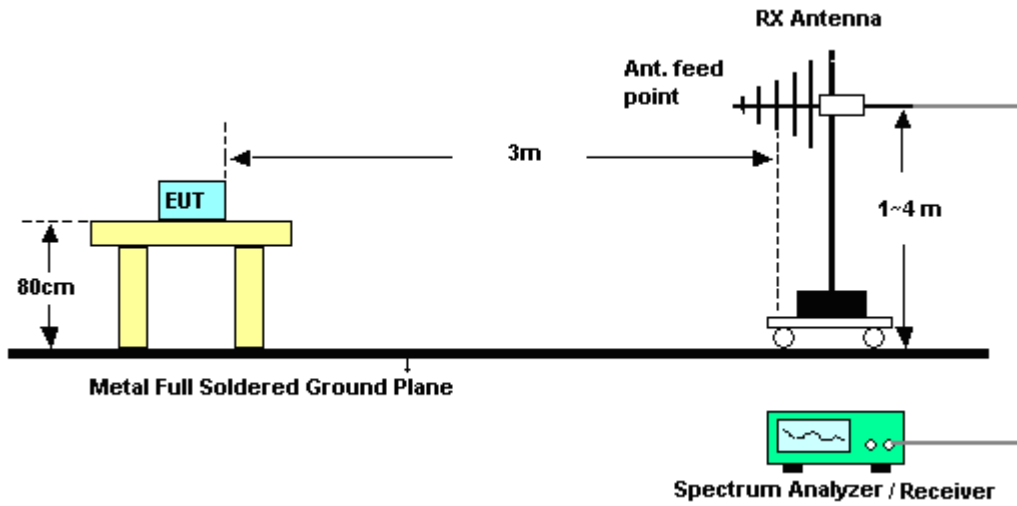

For radiated emissions above 1GHz

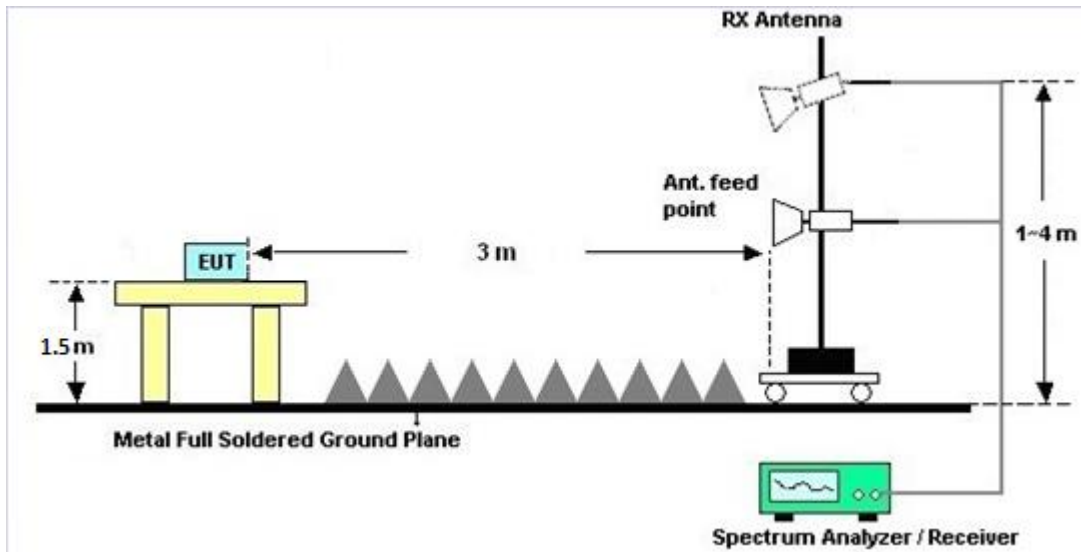

### 3.5.5 Test Results of Radiated Spurious Emissions (9kHz ~ 30MHz)

The low frequency, which started from 9 kHz to 30MHz, was pre-scanned and the result which was 20dB lower than the limit line per 15.31(o) was not reported.

### 3.5.6 Test Result of Radiated Spurious at Band Edges

Please refer to Appendix B and C.

### 3.5.7 Test Result of Radiated Spurious Emission (30MHz ~ 10<sup>th</sup> Harmonic)

Please refer to Appendix B and C.



### 3.6 AC Conducted Emission Measurement

#### 3.6.1 Limit of AC Conducted Emission

For equipment that is designed to be connected to the public utility (AC) power line, the radio frequency voltage that is conducted back onto the AC power line on any frequency or frequencies within the band 150 kHz to 30 MHz shall not exceed the limits in the following table.

Frequency of Emission (MHz)	Conducted Limit (dB $\mu$ V)	
	Quasi-Peak	Average
0.15-0.5	66 to 56*	56 to 46*
0.5-5	56	46
5-30	60	50

\*Decreases with the logarithm of the frequency.

#### 3.6.2 Measuring Instruments

The measuring equipment is listed in the section 4 of this test report.

#### 3.6.3 Test Procedures

1. The EUT was placed 0.4 meter from the conducting wall of the shielding room, and it was kept at least 80 centimeters from any other grounded conducting surface.
2. Connect EUT to the power mains through a line impedance stabilization network (LISN).
3. All the support units are connecting to the other LISN.
4. The LISN provides 50 ohm coupling impedance for the measuring instrument.
5. The FCC states that a 50 ohm, 50 microhenry LISN should be used.
6. Both sides of AC line were checked for maximum conducted interference.
7. The frequency range from 150 kHz to 30 MHz was searched.
8. Set the test-receiver system to Peak Detect Function and specified bandwidth (IF bandwidth = 9kHz) with Maximum Hold Mode.

### 3.6.4 Test Setup

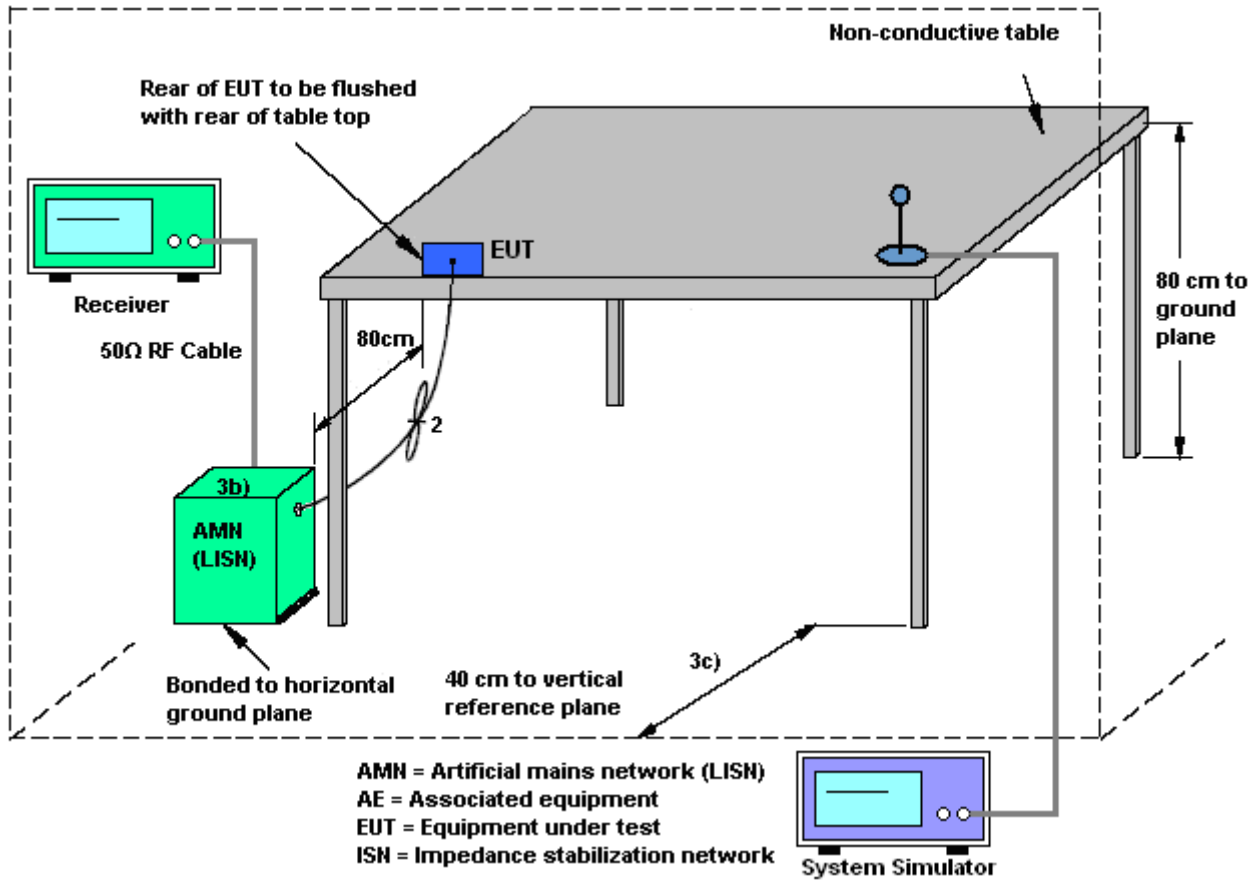



### 3.6.5 Test Result of AC Conducted Emission

Test Mode :	Mode 1	Temperature :	23~24°C
Test Engineer :	Kai-Chun Chu	Relative Humidity :	48~49%
Test Voltage :	120Vac / 60Hz	Phase :	Line
Function Type :	GSM850 Idle + Bluetooth Link + WLAN (2.4GHz) Link + Earphone + MP3 + USB Cable (Charging from Adapter)		

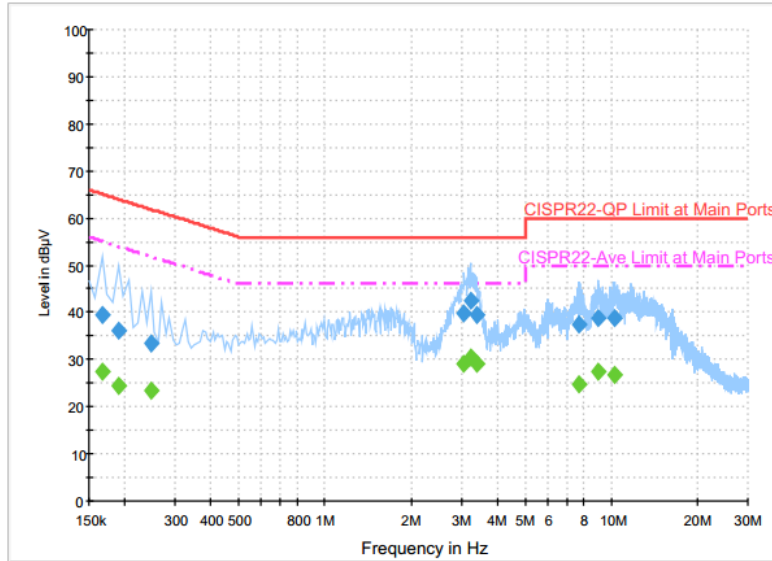

**Final Result : Quasi-Peak**

Frequency (MHz)	Quasi-Peak (dBµV)	Filter	Line	Corr. (dB)	Margin (dB)	Limit (dBµV)
0.166000	39.6	Off	L1	19.6	25.6	65.2
0.190000	36.2	Off	L1	19.6	27.8	64.0
0.246000	33.4	Off	L1	19.6	28.5	61.9
3.062000	39.9	Off	L1	19.6	16.1	56.0
3.222000	42.6	Off	L1	19.6	13.4	56.0
3.398000	39.3	Off	L1	19.6	16.7	56.0
7.710000	37.4	Off	L1	19.7	22.6	60.0
8.966000	38.7	Off	L1	19.7	21.3	60.0
10.302000	38.7	Off	L1	19.7	21.3	60.0

**Final Result : Average**

Frequency (MHz)	Average (dBµV)	Filter	Line	Corr. (dB)	Margin (dB)	Limit (dBµV)
0.166000	27.3	Off	L1	19.6	27.9	55.2
0.190000	24.4	Off	L1	19.6	29.6	54.0
0.246000	23.3	Off	L1	19.6	28.6	51.9
3.062000	29.0	Off	L1	19.6	17.0	46.0
3.222000	30.3	Off	L1	19.6	15.7	46.0
3.398000	29.2	Off	L1	19.6	16.8	46.0
7.710000	24.8	Off	L1	19.7	25.2	50.0
8.966000	27.3	Off	L1	19.7	22.7	50.0
10.302000	26.9	Off	L1	19.7	23.1	50.0



Test Mode :	Mode 1	Temperature :	23~24°C
Test Engineer :	Kai-Chun Chu	Relative Humidity :	48~49%
Test Voltage :	120Vac / 60Hz	Phase :	Neutral
Function Type :	GSM850 Idle + Bluetooth Link + WLAN (2.4GHz) Link + Earphone + MP3 + USB Cable (Charging from Adapter)		

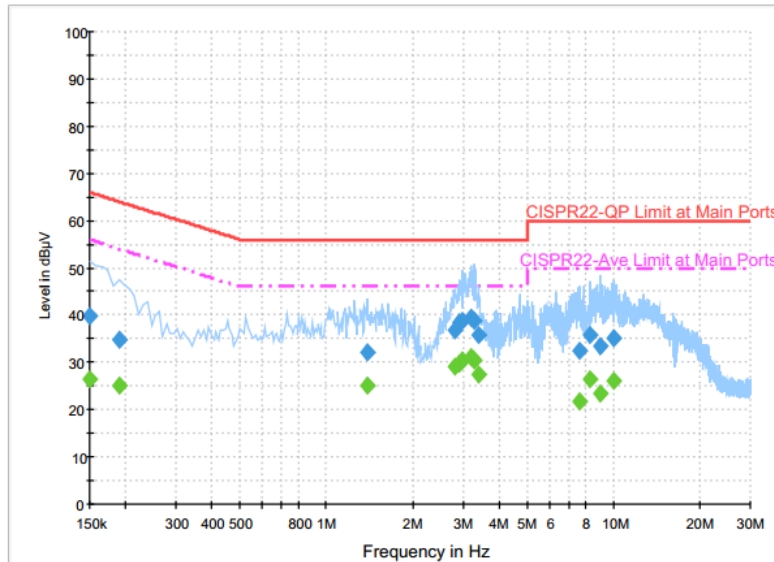

Final Result : Quasi-Peak

Frequency (MHz)	Quasi-Peak (dBµV)	Filter	Line	Corr. (dB)	Margin (dB)	Limit (dBµV)
0.150000	39.9	Off	N	19.6	26.1	66.0
0.190000	34.9	Off	N	19.6	29.1	64.0
1.390000	32.2	Off	N	19.6	23.8	56.0
2.798000	36.9	Off	N	19.5	19.1	56.0
2.910000	38.4	Off	N	19.5	17.6	56.0
2.982000	38.8	Off	N	19.5	17.2	56.0
3.190000	39.4	Off	N	19.6	16.6	56.0
3.278000	38.8	Off	N	19.6	17.2	56.0
3.398000	35.6	Off	N	19.6	20.4	56.0
7.614000	32.6	Off	N	19.7	27.4	60.0
8.318000	35.6	Off	N	19.7	24.4	60.0
9.038000	33.3	Off	N	19.8	26.7	60.0
10.086000	35.1	Off	N	19.8	24.9	60.0



Test Mode :	Mode 1	Temperature :	23~24°C
Test Engineer :	Kai-Chun Chu	Relative Humidity :	48~49%
Test Voltage :	120Vac / 60Hz	Phase :	Neutral
Function Type :	GSM850 Idle + Bluetooth Link + WLAN (2.4GHz) Link + Earphone + MP3 + USB Cable (Charging from Adapter)		

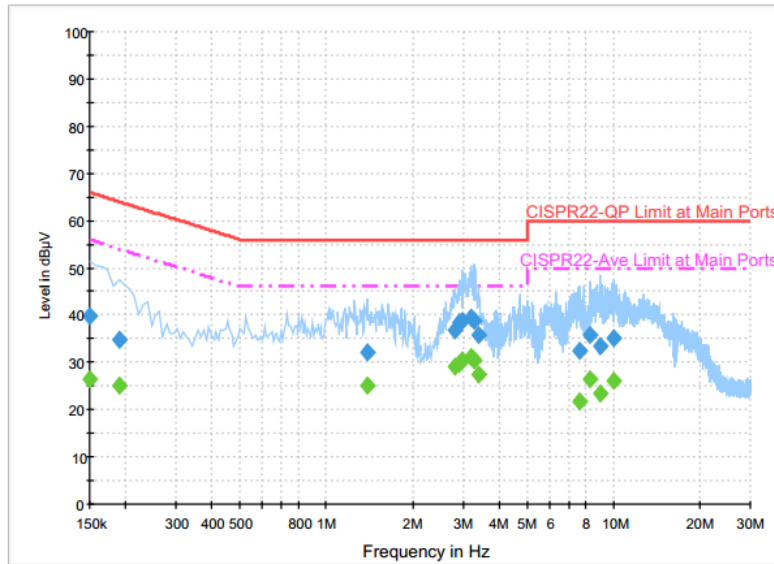

Final Result : Average

Frequency (MHz)	Average (dBµV)	Filter	Line	Corr. (dB)	Margin (dB)	Limit (dBµV)
0.150000	26.4	Off	N	19.6	29.6	56.0
0.190000	24.9	Off	N	19.6	29.1	54.0
1.390000	25.1	Off	N	19.6	20.9	46.0
2.798000	28.9	Off	N	19.5	17.1	46.0
2.910000	29.9	Off	N	19.5	16.1	46.0
2.982000	30.5	Off	N	19.5	15.5	46.0
3.190000	31.0	Off	N	19.6	15.0	46.0
3.278000	30.3	Off	N	19.6	15.7	46.0
3.398000	27.3	Off	N	19.6	18.7	46.0
7.614000	21.7	Off	N	19.7	28.3	50.0
8.318000	26.4	Off	N	19.7	23.6	50.0
9.038000	23.3	Off	N	19.8	26.7	50.0
10.086000	26.2	Off	N	19.8	23.8	50.0



## **3.7 Antenna Requirements**

### **3.7.1 Standard Applicable**

If directional gain of transmitting antennas is greater than 6dBi, the power shall be reduced by the same level in dB comparing to gain minus 6dBi. For the fixed point-to-point operation, the power shall be reduced by one dB for every 3 dB that the directional gain of the antenna exceeds 6 dBi. The use of a permanently attached antenna or of an antenna that uses a unique coupling to the intentional radiator shall be considered sufficient to comply with the FCC rule.

### **3.7.2 Antenna Anti-Replacement Construction**

An embedded-in antenna design is used.

### **3.7.3 Antenna Gain**

The antenna peak gain of EUT is less than 6 dBi. Therefore, it is not necessary to reduce maximum peak output power limit.



## 4 List of Measuring Equipment

Instrument	Manufacturer	Model No.	Serial No.	Characteristics	Calibration Date	Test Date	Due Date	Remark
Power Meter	Anritsu	ML2495A	1036004	300MHz~40GHz	Jul. 29, 2015	Feb. 15, 2016 ~ Mar. 03, 2016	Jul. 28, 2016	Conducted (TH02-HY)
Power Sensor	Anritsu	MA2411B	1027253	300MHz~40GHz	Jul. 29, 2015	Feb. 15, 2016 ~ Mar. 03, 2016	Jul. 28, 2016	Conducted (TH02-HY)
Spectrum Analyzer	Rohde & Schwarz	FSP40	100055	9kHz~40GHz	Jun. 18, 2015	Feb. 15, 2016 ~ Mar. 03, 2016	Jun. 17, 2016	Conducted (TH02-HY)
Bilog Antenna	TESEQ	CBL 6111D	35419	30MHz to 1GHz	Jan. 13, 2016	Feb. 27, 2016 ~ Mar. 02, 2016	Jan. 12, 2017	Radiation (03CH07-HY)
Double Ridge Horn Antenna	ESCO	3117	00075962	1GHz ~ 18GHz	Aug. 21, 2015	Feb. 27, 2016 ~ Mar. 02, 2016	Aug. 20, 2016	Radiation (03CH07-HY)
Loop Antenna	Rohde & Schwarz	HFH2-Z2	100315	9 kHz~30 MHz	Sep. 02, 2015	Feb. 27, 2016 ~ Mar. 02, 2016	Sep. 01, 2016	Radiation (03CH07-HY)
Preamplifier	MITEQ	AMF-7D-00101 800-30-10P	1590075	1GHz ~ 18GHz	Apr. 20, 2015	Feb. 27, 2016 ~ Mar. 02, 2016	Apr. 19, 2016	Radiation (03CH07-HY)
Preamplifier	COM-POWER	PA-103A	161241	10MHz-1000MHz	Mar. 12, 2015	Feb. 27, 2016 ~ Mar. 02, 2016	Mar. 11, 2016	Radiation (03CH07-HY)
Preamplifier	Agilent	8449B	3008A023 62	1GHz~ 26.5GHz	Oct. 19, 2015	Feb. 27, 2016 ~ Mar. 02, 2016	Oct. 18, 2016	Radiation (03CH07-HY)
EMI Test Receiver	Agilent	N9038A(MXE)	MY532900 53	20Hz ~ 26.5GHz	Jan. 20, 2016	Feb. 27, 2016 ~ Mar. 02, 2016	Jan. 19, 2017	Radiation (03CH07-HY)
Spectrum Analyzer	Agilent	N9010A	MY534701 18	10Hz~44GHz	Feb. 27, 2016	Feb. 28, 2016 ~ Mar. 02, 2016	Feb. 26, 2017	Radiation (03CH07-HY)
Spectrum Analyzer	Agilent	N9010A	MY534701 18	10Hz~44GHz	Mar. 03, 2015	Feb. 22, 2016 ~ Feb. 26, 2016	Mar. 02, 2016	Radiation (03CH07-HY)
Antenna Mast	Max-Full	MFA520BS	N/A	1m~4m	N/A	Feb. 27, 2016 ~ Mar. 02, 2016	N/A	Radiation (03CH07-HY)
Turn Table	ChainTek	Chaintek 3000	N/A	0~360 degree	N/A	Feb. 27, 2016 ~ Mar. 02, 2016	N/A	Radiation (03CH07-HY)
SHF-EHF Horn Antenna	SCHWARZBE CK	BBHA 9170	BBHA9170 251	18GHz- 40GHz	Oct. 12, 2015	Feb. 27, 2016 ~ Mar. 02, 2016	Oct. 11, 2016	Radiation (03CH07-HY)
Preamplifier	MITEQ	JS44-1800400 0-33-8P	1840917	18GHz ~ 40GHz	Jun. 02, 2015	Feb. 27, 2016 ~ Mar. 02, 2016	Jun. 01, 2016	Radiation (03CH07-HY)
AC Power Source	ChainTek	APC-1000W	N/A	N/A	N/A	Feb. 12, 2016	N/A	Conduction (CO05-HY)
EMI Test Receiver	Rohde & Schwarz	ESCI 7	100724	9kHz~7GHz	Aug. 26, 2015	Feb. 12, 2016	Aug. 25, 2016	Conduction (CO05-HY)
LISN	Rohde & Schwarz	ENV216	100080	9kHz~30MHz	Dec. 02, 2015	Feb. 12, 2016	Dec. 01, 2016	Conduction (CO05-HY)



## 5 Uncertainty of Evaluation

### Uncertainty of Conducted Emission Measurement (150kHz ~ 30MHz)

Measuring Uncertainty for a Level of Confidence of 95% ( $U = 2Uc(y)$ )	2.26
---	------

### Uncertainty of Radiated Emission Measurement (30 MHz ~ 1000 MHz)

Measuring Uncertainty for a Level of Confidence of 95% ( $U = 2Uc(y)$ )	4.80
---	------



## Appendix A. Conducted Test Results

**A1 - DTS Part**

Test Engineer:	AC Chang	Temperature:	21~25	°C
Test Date:	2016/02/15~2016/03/03	Relative Humidity:	51~54	%

**TEST RESULTS DATA**  
**6dB and 99% Occupied Bandwidth**

2.4GHz Band								
Mod.	Data Rate	N <sub>TX</sub>	CH.	Freq. (MHz)	99% Occupied BW (MHz)	6dB BW (MHz)	6dB BW Limit (MHz)	Pass/Fail
11b	1Mbps	1	1	2412	13.60	8.54	0.50	Pass
11b	1Mbps	1	6	2437	14.00	8.54	0.50	Pass
11b	1Mbps	1	11	2462	13.95	8.54	0.50	Pass
11g	6Mbps	1	1	2412	18.15	16.32	0.50	Pass
11g	6Mbps	1	6	2437	18.55	16.36	0.50	Pass
11g	6Mbps	1	11	2462	18.70	16.34	0.50	Pass
HT20	MCS0	1	1	2412	19.10	17.52	0.50	Pass
HT20	MCS0	1	6	2437	19.20	17.54	0.50	Pass
HT20	MCS0	1	11	2462	19.30	17.58	0.50	Pass

**TEST RESULTS DATA**  
**Peak Power Table**

2.4GHz Band										
Mod.	Data Rate	N <sub>TX</sub>	CH.	Freq. (MHz)	Peak Conducted Power (dBm)	Conducted Power Limit (dBm)	DG (dBi)	EIRP Power (dBm)	EIRP Power Limit (dBm)	Pass /Fail
11b	1Mbps	1	1	2412	19.93	30.00	2.50	22.43	36.00	Pass
11b	1Mbps	1	6	2437	19.37	30.00	2.50	21.87	36.00	Pass
11b	1Mbps	1	11	2462	20.52	30.00	2.50	23.02	36.00	Pass
11g	6Mbps	1	1	2412	23.20	30.00	2.50	25.70	36.00	Pass
11g	6Mbps	1	6	2437	22.86	30.00	2.50	25.36	36.00	Pass
11g	6Mbps	1	11	2462	23.18	30.00	2.50	25.68	36.00	Pass
HT20	MCS0	1	1	2412	22.81	30.00	2.50	25.31	36.00	Pass
HT20	MCS0	1	6	2437	22.62	30.00	2.50	25.12	36.00	Pass
HT20	MCS0	1	11	2462	22.79	30.00	2.50	25.29	36.00	Pass

**TEST RESULTS DATA**  
**Average Power Table**  
***(Reporting Only)***

2.4GHz Band						
Mod.	Data Rate	N <sub>TX</sub>	CH.	Freq. (MHz)	Duty Factor (dB)	Average Conducted Power (dBm)
11b	1Mbps	1	1	2412	0.13	17.62
11b	1Mbps	1	6	2437	0.13	16.91
11b	1Mbps	1	11	2462	0.13	18.15
11g	6Mbps	1	1	2412	0.60	15.78
11g	6Mbps	1	6	2437	0.60	15.38
11g	6Mbps	1	11	2462	0.60	15.66
HT20	MCS0	1	1	2412	0.70	15.43
HT20	MCS0	1	6	2437	0.70	14.90
HT20	MCS0	1	11	2462	0.70	14.95

**TEST RESULTS DATA**  
**Peak Power Density**

2.4GHz Band								
Mod.	Data Rate	N <sub>TX</sub>	CH.	Freq. (MHz)	Peak PSD (dBm /3kHz)	DG (dBi)	Peak PSD Limit (dBm /3kHz)	Pass/Fail
11b	1Mbps	1	1	2412	-6.45	2.50	8.00	Pass
11b	1Mbps	1	6	2437	-6.36	2.50	8.00	Pass
11b	1Mbps	1	11	2462	-4.37	2.50	8.00	Pass
11g	6Mbps	1	1	2412	-10.20	2.50	8.00	Pass
11g	6Mbps	1	6	2437	-10.92	2.50	8.00	Pass
11g	6Mbps	1	11	2462	-9.67	2.50	8.00	Pass
HT20	MCS0	1	1	2412	-11.11	2.50	8.00	Pass
HT20	MCS0	1	6	2437	-10.66	2.50	8.00	Pass
HT20	MCS0	1	11	2462	-11.61	2.50	8.00	Pass



## Appendix B. Radiated Spurious Emission

Test Engineer :	James Chiu and Jesse Wang and Ken Wu	Temperature :	21~24°C
		Relative Humidity :	50~54%

### 2.4GHz 2400~2483.5MHz

#### WIFI 802.11b (Band Edge @ 3m)

WIFI Ant. 1	Note	Frequency ( MHz )	Level ( dBμV/m )	Over Limit ( dB )	Limit Line ( dBμV/m )	Read Level ( dBμV )	Antenna Factor ( dB/m )	Cable Loss ( dB )	Preamp Factor ( dB )	Ant Pos ( cm )	Table Pos ( deg )	Peak Avg. ( P/A )	Pol. ( H/V )	
802.11b CH 01 2412MHz		2363.55	53.94	-20.06	74	48.97	32.13	7.24	34.4	339	151	P	H	
		2390	44.08	-9.92	54	38.91	32.18	7.31	34.32	339	151	A	H	
	*	2412.859	102.82	-	-	97.63	32.2	7.31	34.32	339	151	P	H	
	*	2412.859	101	-	-	95.81	32.2	7.31	34.32	339	151	A	H	
													H	
														H
			2356.89	55.13	-18.87	74	50.16	32.13	7.24	34.4	181	138	P	V
			2389.29	44.59	-9.41	54	39.46	32.18	7.31	34.36	181	138	A	V
	*		2412.942	107.29	-	-	102.1	32.2	7.31	34.32	181	138	P	V
	*		2412.942	103.79	-	-	98.6	32.2	7.31	34.32	181	138	A	V
														V
														V
802.11b CH 06 2437MHz		2371.29	54.84	-19.16	74	49.8	32.16	7.24	34.36	380	156	P	H	
		2389.74	43.88	-10.12	54	38.75	32.18	7.31	34.36	380	156	A	H	
	*	2437.909	104.22	-	-	98.89	32.24	7.36	34.27	380	156	P	H	
	*	2437.992	100.18	-	-	94.85	32.24	7.36	34.27	380	156	A	H	
			2484.44	55.2	-18.8	74	49.71	32.28	7.4	34.19	380	156	P	H
			2498.64	44.2	-9.8	54	38.65	32.3	7.4	34.15	380	156	A	H
			2329.89	54.49	-19.51	74	49.66	32.09	7.18	34.44	195	139	P	V
			2389.02	43.99	-10.01	54	38.86	32.18	7.31	34.36	195	139	A	V
	*		2437.909	104.98	-	-	99.65	32.24	7.36	34.27	195	139	P	V
	*		2437.909	101.13	-	-	95.8	32.24	7.36	34.27	195	139	A	V
			2489.64	55.23	-18.77	74	49.72	32.3	7.4	34.19	195	139	P	V
			2484.24	44.3	-9.7	54	38.81	32.28	7.4	34.19	195	139	A	V



<b>802.11b</b> <b>CH 11</b> <b>2462MHz</b>	*	2461.122	105.9	-	-	100.47	32.26	7.4	34.23	380	132	P	H
	*	2461.122	101.87	-	-	96.44	32.26	7.4	34.23	380	132	A	H
		2485.16	54.54	-19.46	74	49.05	32.28	7.4	34.19	380	132	P	H
		2484.8	44.65	-9.35	54	39.16	32.28	7.4	34.19	380	132	A	H
													H
													H
	*	2461.206	106.85	-	-	101.42	32.26	7.4	34.23	204	291	P	V
	*	2461.122	102.75	-	-	97.32	32.26	7.4	34.23	204	291	A	V
		2494	54.63	-19.37	74	49.08	32.3	7.4	34.15	204	291	P	V
		2483.68	44.4	-9.6	54	38.91	32.28	7.4	34.19	204	291	A	V
													V
													V
<b>Remark</b>	1. No other spurious found. 2. All results are PASS against Peak and Average limit line.												



**2.4GHz 2400~2483.5MHz  
WIFI 802.11b (Harmonic @ 3m)**

WIFI Ant. 1	Note	Frequency ( MHz )	Level ( dBμV/m )	Over Limit ( dB )	Limit Line ( dBμV/m )	Read Level ( dBμV )	Antenna Factor ( dB/m )	Cable Loss ( dB )	Preamp Factor ( dB )	Ant Pos ( cm )	Table Pos ( deg )	Peak Avg. ( P/A )	Pol. ( H/V )	
802.11b CH 01 2412MHz		4824	41.32	-32.68	74	55.02	34.26	11.68	59.64	100	0	P	H	
													H	
													H	
													H	
			4824	43.18	-30.82	74	56.88	34.26	11.68	59.64	100	0	P	V
														V
														V
802.11b CH 06 2437MHz		4872	39.75	-34.25	74	53.49	34.3	11.53	59.57	100	0	P	H	
		7308	41.31	-32.69	74	50.37	35.6	13.81	58.47	100	0	P	H	
													H	
													H	
			4872	40.91	-33.09	74	54.65	34.3	11.53	59.57	100	0	P	V
			7308	40.72	-33.28	74	49.78	35.6	13.81	58.47	100	0	P	V
														V
802.11b CH 11 2462MHz		4926	39.87	-34.13	74	53.66	34.34	11.37	59.5	100	0	P	H	
		7386	41.28	-32.72	74	50.31	35.6	13.95	58.58	100	0	P	H	
													H	
													H	
			4926	39.65	-34.35	74	53.44	34.34	11.37	59.5	100	0	P	V
			7386	40.78	-33.22	74	49.81	35.6	13.95	58.58	100	0	P	V
														V
Remark	1. No other spurious found.													
	2. All results are PASS against Peak and Average limit line.													



**2.4GHz 2400~2483.5MHz  
WIFI 802.11g (Band Edge @ 3m)**

WIFI Ant. 1	Note	Frequency ( MHz )	Level ( dBμV/m )	Over Limit ( dB )	Limit Line ( dBμV/m )	Read Level ( dBμV )	Antenna Factor ( dB/m )	Cable Loss ( dB )	Preamp Factor ( dB )	Ant Pos ( cm )	Table Pos ( deg )	Peak Avg. ( P/A )	Pol. ( H/V )	
802.11g CH 01 2412MHz		2390	59.4	-14.6	74	54.23	32.18	7.31	34.32	342	155	P	H	
		2389.74	47.79	-6.21	54	42.66	32.18	7.31	34.36	342	155	A	H	
	*	2412	106.83	-	-	101.64	32.2	7.31	34.32	342	155	P	H	
	*	2412	97.31	-	-	92.12	32.2	7.31	34.32	342	155	A	H	
													H	
													H	
			2389.02	62.91	-11.09	74	57.78	32.18	7.31	34.36	142	135	P	V
			2390	51.28	-2.72	54	46.11	32.18	7.31	34.32	142	135	A	V
	*		2412	108.69	-	-	103.5	32.2	7.31	34.32	142	135	P	V
	*		2412	99.2	-	-	94.01	32.2	7.31	34.32	142	135	A	V
													V	
													V	
802.11g CH 06 2437MHz		2357.7	54.64	-19.36	74	49.67	32.13	7.24	34.4	379	136	P	H	
		2345.64	44.5	-9.5	54	39.55	32.11	7.24	34.4	379	136	A	H	
	*	2437	105.49	-	-	100.16	32.24	7.36	34.27	379	136	P	H	
	*	2437	96.17	-	-	90.84	32.24	7.36	34.27	379	136	A	H	
			2490.4	54.27	-19.73	74	48.76	32.3	7.4	34.19	379	136	P	H
			2484.12	44.8	-9.2	54	39.31	32.28	7.4	34.19	379	136	A	H
			2371.29	54.03	-19.97	74	48.99	32.16	7.24	34.36	161	136	P	V
			2384.79	44.71	-9.29	54	39.6	32.16	7.31	34.36	161	136	A	V
	*		2437	106.93	-	-	101.6	32.24	7.36	34.27	161	136	P	V
	*		2437	97.13	-	-	91.8	32.24	7.36	34.27	161	136	A	V
			2499.84	55.31	-18.69	74	49.76	32.3	7.4	34.15	161	136	P	V
			2489.04	45.36	-8.64	54	39.85	32.3	7.4	34.19	161	136	A	V



<b>802.11g</b>  <b>CH 11</b>  <b>2462MHz</b>	*	2462	107.22	-	-	101.79	32.26	7.4	34.23	380	134	P	H
	*	2462	97.47	-	-	92.04	32.26	7.4	34.23	380	134	A	H
		2483.72	63.5	-10.5	74	58.01	32.28	7.4	34.19	380	134	P	H
		2483.6	50.72	-3.28	54	45.23	32.28	7.4	34.19	380	134	A	H
													H
													H
	*	2462	108.53	-	-	103.1	32.26	7.4	34.23	202	290	P	V
	*	2462	98.5	-	-	93.07	32.26	7.4	34.23	202	290	A	V
		2484.36	65.79	-8.21	74	60.3	32.28	7.4	34.19	202	290	P	V
		2483.52	52.5	-1.5	54	47.01	32.28	7.4	34.19	202	290	A	V
													V
													V
<b>Remark</b>	1. No other spurious found. 2. All results are PASS against Peak and Average limit line.												



**2.4GHz 2400~2483.5MHz  
WIFI 802.11g (Harmonic @ 3m)**

WIFI Ant. 1	Note	Frequency ( MHz )	Level ( dBµV/m )	Over Limit ( dB )	Limit Line ( dBµV/m )	Read Level ( dBµV )	Antenna Factor ( dB/m )	Cable Loss ( dB )	Preamp Factor ( dB )	Ant Pos ( cm )	Table Pos ( deg )	Peak Avg. ( P/A )	Pol. ( H/V )	
802.11g CH 01 2412MHz		4824	39.98	-34.02	74	53.68	34.26	11.68	59.64	100	0	P	H	
													H	
													H	
													H	
			4824	40.68	-33.32	74	54.38	34.26	11.68	59.64	100	0	P	V
														V
														V
802.11g CH 06 2437MHz		4872	39.85	-34.15	74	53.59	34.3	11.53	59.57	100	0	P	H	
		7308	40.4	-33.6	74	49.46	35.6	13.81	58.47	100	0	P	H	
													H	
													H	
			4872	39.33	-34.67	74	53.07	34.3	11.53	59.57	100	0	P	V
			7308	41.03	-32.97	74	50.09	35.6	13.81	58.47	100	0	P	V
														V
802.11g CH 11 2462MHz		4926	39.05	-34.95	74	52.84	34.34	11.37	59.5	100	0	P	H	
		7386	41.32	-32.68	74	50.35	35.6	13.95	58.58	100	0	P	H	
													H	
													H	
			4926	39.2	-34.8	74	52.99	34.34	11.37	59.5	100	0	P	V
			7386	40.68	-33.32	74	49.71	35.6	13.95	58.58	100	0	P	V
														V
Remark	1. No other spurious found.													
	2. All results are PASS against Peak and Average limit line.													



**2.4GHz 2400~2483.5MHz  
WIFI 802.11n HT20 (Band Edge @ 3m)**

WIFI Ant. 1	Note	Frequency ( MHz )	Level ( dBμV/m )	Over Limit ( dB )	Limit Line ( dBμV/m )	Read Level ( dBμV )	Antenna Factor ( dB/m )	Cable Loss ( dB )	Preamp Factor ( dB )	Ant Pos ( cm )	Table Pos ( deg )	Peak Avg. ( P/A )	Pol. ( H/V )	
802.11n HT20 CH 01 2412MHz		2389.2	62.73	-11.27	74	57.6	32.18	7.31	34.36	342	155	P	H	
		2390	48.68	-5.32	54	43.51	32.18	7.31	34.32	342	155	A	H	
	*	2412	106.65	-	-	101.46	32.2	7.31	34.32	342	155	P	H	
	*	2412	96.69	-	-	91.5	32.2	7.31	34.32	342	155	A	H	
													H	
														H
			2389.29	66	-8	74	60.87	32.18	7.31	34.36	142	135	P	V
			2390	51.68	-2.32	54	46.51	32.18	7.31	34.32	142	135	A	V
		*	2412	108.4	-	-	103.21	32.2	7.31	34.32	142	135	P	V
		*	2412	98.46	-	-	93.27	32.2	7.31	34.32	142	135	A	V
													V	
													V	
802.11n HT20 CH 06 2437MHz		2333.94	54.55	-19.45	74	49.72	32.09	7.18	34.44	379	136	P	H	
		2377.68	44.44	-9.56	54	39.4	32.16	7.24	34.36	379	136	A	H	
	*	2437	105.09	-	-	99.76	32.24	7.36	34.27	379	136	P	H	
	*	2437	96.08	-	-	90.75	32.24	7.36	34.27	379	136	A	H	
			2490.16	55.54	-18.46	74	50.03	32.3	7.4	34.19	379	136	P	H
			2487.56	44.78	-9.22	54	39.27	32.3	7.4	34.19	379	136	A	H
			2389.29	55.32	-18.68	74	50.19	32.18	7.31	34.36	161	136	P	V
			2386.14	44.81	-9.19	54	39.68	32.18	7.31	34.36	161	136	A	V
		*	2437	106.45	-	-	101.12	32.24	7.36	34.27	161	136	P	V
		*	2437	96.58	-	-	91.25	32.24	7.36	34.27	161	136	A	V
		2483.84	55.15	-18.85	74	49.66	32.28	7.4	34.19	161	136	P	V	
		2488.28	45.55	-8.45	54	40.04	32.3	7.4	34.19	161	136	A	V	



<b>802.11n HT20 CH 11 2462MHz</b>	*	2462	107.18	-	-	101.75	32.26	7.4	34.23	380	134	P	H
	*	2462	96.91	-	-	91.48	32.26	7.4	34.23	380	134	A	H
		2483.52	64.89	-9.11	74	59.4	32.28	7.4	34.19	380	134	P	H
		2483.52	51.48	-2.52	54	45.99	32.28	7.4	34.19	380	134	A	H
													H
													H
	*	2462	107.89	-	-	102.46	32.26	7.4	34.23	202	290	P	V
	*	2462	97.88	-	-	92.45	32.26	7.4	34.23	202	290	A	V
		2483.52	66.48	-7.52	74	60.99	32.28	7.4	34.19	202	290	P	V
		2483.76	52.9	-1.1	54	47.41	32.28	7.4	34.19	202	290	A	V
												V	
												V	
<b>Remark</b>	1. No other spurious found. 2. All results are PASS against Peak and Average limit line.												



**2.4GHz 2400~2483.5MHz  
WIFI 802.11n HT20 (Harmonic @ 3m)**

WIFI Ant. 1	Note	Frequency ( MHz )	Level ( dBμV/m )	Over Limit ( dB )	Limit Line ( dBμV/m )	Read Level ( dBμV )	Antenna Factor ( dB/m )	Cable Loss ( dB )	Preamp Factor ( dB )	Ant Pos ( cm )	Table Pos ( deg )	Peak Avg. ( P/A )	Pol. ( H/V )	
802.11n HT20 CH 01 2412MHz		4824	40.24	-33.76	74	53.94	34.26	11.68	59.64	100	0	P	H	
													H	
													H	
													H	
			4824	40.6	-33.4	74	54.3	34.26	11.68	59.64	100	0	P	V
														V
														V
802.11n HT20 CH 06 2437MHz		4872	40.57	-33.43	74	54.31	34.3	11.53	59.57	100	0	P	H	
		7308	40.44	-33.56	74	49.5	35.6	13.81	58.47	100	0	P	H	
													H	
													H	
			4872	39.74	-34.26	74	53.48	34.3	11.53	59.57	100	0	P	V
			7308	40.09	-33.91	74	49.15	35.6	13.81	58.47	100	0	P	V
														V
802.11n HT20 CH 11 2462MHz		4926	40.55	-33.45	74	54.34	34.34	11.37	59.5	100	0	P	H	
		7386	40.84	-33.16	74	49.87	35.6	13.95	58.58	100	0	P	H	
													H	
													H	
			4926	39.3	-34.7	74	53.09	34.34	11.37	59.5	100	0	P	V
			7386	41.56	-32.44	74	50.59	35.6	13.95	58.58	100	0	P	V
														V
Remark	1. No other spurious found.													
	2. All results are PASS against Peak and Average limit line.													



**Emission below 1GHz**  
**2.4GHz WIFI 802.11n HT20 (LF)**

WIFI	Note	Frequency	Level	Over	Limit	Read	Antenna	Cable	Preamp	Ant	Table	Peak	Pol.	
Ant.				Limit	Line	Level	Factor	Loss	Factor	Pos	Pos	Avg.		
1		( MHz )	( dBμV/m )	( dB )	( dBμV/m )	( dBμV )	( dB/m )	( dB )	( dB )	( cm )	( deg )	( P/A )	( H/V )	
2.4GHz 802.11n HT20 LF		31.62	26.33	-13.67	40	31.76	24.92	1.07	31.42			P	H	
		157.71	35.51	-7.99	43.5	47.77	17.14	1.78	31.18	100	0	P	H	
		222.51	29.63	-16.37	46	42	16.56	2.07	31			P	H	
		895	32.65	-13.35	46	29.82	28.97	4.17	30.31			P	H	
		924.4	33.44	-12.56	46	30.08	29.59	4.12	30.35			P	H	
		944.7	34.37	-11.63	46	30.61	30.08	4.07	30.39			P	H	
														H
														H
														H
														H
														H
														H
														H
			39.45	31.05	-8.95	40	40.78	20.4	1.07	31.2	100	0	P	V
			196.59	31.28	-12.22	43.5	44.66	15.85	1.87	31.1			P	V
			254.64	25.07	-20.93	46	34.5	19.5	2.07	31			P	V
			908.3	32.77	-13.23	46	29.78	29.19	4.12	30.32			P	V
			923	33	-13	46	29.67	29.56	4.12	30.35			P	V
			947.5	33.57	-12.43	46	29.74	30.15	4.07	30.39			P	V
														V
													V	
													V	
													V	
													V	
													V	
<b>Remark</b>	1. No other spurious found. 2. All results are PASS against limit line.													



**Note symbol**

*	<b>Fundamental Frequency</b> which can be ignored. However, the level of any unwanted emissions shall not exceed the level of the fundamental frequency.
!	Test result is <b>over limit</b> line.
P/A	<b>Peak</b> or <b>Average</b>
H/V	<b>Horizontal</b> or <b>Vertical</b>



A calculation example for radiated spurious emission is shown as below:

WIFI	Note	Frequency	Level	Over	Limit	Read	Antenna	Cable	Preamp	Ant	Table	Peak	Pol.
Ant.				Limit	Line	Level	Factor	Loss	Factor	Pos	Pos	Avg.	
1		( MHz )	( dBμV/m )	( dB )	( dBμV/m )	( dBμV )	( dB/m )	( dB )	( dB )	( cm )	( deg )	( P/A )	( H/V )
802.11b		2390	55.45	-18.55	74	54.51	32.22	4.58	35.86	103	308	P	H
CH 01													
2412MHz		2390	43.54	-10.46	54	42.6	32.22	4.58	35.86	103	308	A	H

- Level(dBμV/m) =  
Antenna Factor(dB/m) + Cable Loss(dB) + Read Level(dBμV) - Preamp Factor(dB)
- Over Limit(dB) = Level(dBμV/m) – Limit Line(dBμV/m)

**For Peak Limit @ 2390MHz:**

- Level(dBμV/m)  
= Antenna Factor(dB/m) + Cable Loss(dB) + Read Level(dBμV) - Preamp Factor(dB)  
= 32.22(dB/m) + 4.58(dB) + 54.51(dBμV) – 35.86 (dB)  
= 55.45 (dBμV/m)
- Over Limit(dB)  
= Level(dBμV/m) – Limit Line(dBμV/m)  
= 55.45(dBμV/m) – 74(dBμV/m)  
= -18.55(dB)

**For Average Limit @ 2390MHz:**

- Level(dBμV/m)  
= Antenna Factor(dB/m) + Cable Loss(dB) + Read Level(dBμV) - Preamp Factor(dB)  
= 32.22(dB/m) + 4.58(dB) + 42.6(dBμV) – 35.86 (dB)  
= 43.54 (dBμV/m)
- Over Limit(dB)  
= Level(dBμV/m) – Limit Line(dBμV/m)  
= 43.54(dBμV/m) – 54(dBμV/m)  
= -10.46(dB)

Both peak and average measured complies with the limit line, so test result is “PASS”.



## Appendix C. Radiated Spurious Emission Plots

Test Engineer :	James Chiu and Jesse Wang and Ken Wu	Temperature :	21~24°C
		Relative Humidity :	50~54%



**2.4GHz 2400~2483.5MHz**  
**WIFI 802.11b (Band Edge @ 3m)**

WIFI	2.4GHz 2400~2483.5MHz Band Edge @ 3m	
ANT	802.11b CH01 2412MHz	
1	Horizontal	Vertical
<b>Peak</b>	<p>Site : 03CH07-HY            Condition : FCC CLASS-B 3m HF-ANT_130829 HORIZONTAL            RBW:1000.000kHz VBW:3000.000kHz SWT:Auto            Detector : Peak</p>	<p>Site : 03CH07-HY            Condition : FCC CLASS-B 3m HF-ANT_130829 VERTICAL            RBW:1000.000kHz VBW:3000.000kHz SWT:Auto            Detector : Peak</p>
<b>Avg.</b>	<p>Site : 03CH07-HY            Condition : FCC CLASS-B (AVG) 3m HF-ANT_130829 HORIZONTAL            RBW:1000.000kHz VBW:0.300kHz SWT:Auto            Detector : Peak</p>	<p>Site : 03CH07-HY            Condition : FCC CLASS-B (AVG) 3m HF-ANT_130829 VERTICAL            RBW:1000.000kHz VBW:0.300kHz SWT:Auto            Detector : Peak</p>



WIFI	2.4GHz 2400~2483.5MHz Band Edge @ 3m	
ANT	802.11b CH06 2437MHz - L	
1	Horizontal	Vertical
Peak	<p>Site : 03CH07-HY Condition : FCC CLASS-B 3m HF-ANT_130829 HORIZONTAL Detector : Peak</p>	<p>Site : 03CH07-HY Condition : FCC CLASS-B 3m HF-ANT_130829 VERTICAL Detector : Peak</p>
Avg.	<p>Site : 03CH07-HY Condition : FCC CLASS-B (AVG) 3m HF-ANT_130829 HORIZONTAL Detector : Peak</p>	<p>Site : 03CH07-HY Condition : FCC CLASS-B (AVG) 3m HF-ANT_130829 VERTICAL Detector : Peak</p>



WIFI	2.4GHz 2400~2483.5MHz Band Edge @ 3m	
ANT	802.11b CH06 2437MHz - R	
1	Horizontal	Vertical
Peak	<p>Date: 2016-02-27</p> <p>Site : 03CH07-HY Condition : FCC CLASS-B 3m HF-ANT_130829 HORIZONTAL Detector : Peak</p>	<p>Date: 2016-02-27</p> <p>Site : 03CH07-HY Condition : FCC CLASS-B 3m HF-ANT_130829 VERTICAL Detector : Peak</p>
Avg.	<p>Date: 2016-02-27</p> <p>Site : 03CH07-HY Condition : FCC CLASS-B (AVG) 3m HF-ANT_130829 HORIZONTAL Detector : Peak</p>	<p>Date: 2016-02-27</p> <p>Site : 03CH07-HY Condition : FCC CLASS-B (AVG) 3m HF-ANT_130829 VERTICAL Detector : Peak</p>



WIFI	2.4GHz 2400~2483.5MHz Band Edge @ 3m	
ANT	802.11b CH11 2462MHz	
1	Horizontal	Vertical
Peak	<p>Site : 03CH07-HY Condition : FCC CLASS-B 3m HF-ANT_130829 HORIZONTAL Detector : Peak</p>	<p>Site : 03CH07-HY Condition : FCC CLASS-B 3m HF-ANT_130829 VERTICAL Detector : Peak</p>
Avg.	<p>Site : 03CH07-HY Condition : FCC CLASS-B (AVG) 3m HF-ANT_130829 HORIZONTAL Detector : Peak</p>	<p>Site : 03CH07-HY Condition : FCC CLASS-B (AVG) 3m HF-ANT_130829 VERTICAL Detector : Peak</p>



**2.4GHz 2400~2483.5MHz**  
**WIFI 802.11g (Band Edge @ 3m)**

WIFI	2.4GHz 2400~2483.5MHz Band Edge @ 3m	
ANT	802.11g CH01 2412MHz	
1	Horizontal	Vertical
<b>Peak</b>	<p>Site : 03CH07-HY            Condition : FCC CLASS-B 3m HF-ANT_130829 HORIZONTAL            RBW:1000.000kHz VBW:3000.000kHz SWT:Auto            Detector : Peak</p>	<p>Site : 03CH07-HY            Condition : FCC CLASS-B 3m HF-ANT_130829 VERTICAL            RBW:1000.000kHz VBW:3000.000kHz SWT:Auto            Detector : Peak</p>
<b>Avg.</b>	<p>Site : 03CH07-HY            Condition : FCC CLASS-B (AVG) 3m HF-ANT_130829 HORIZONTAL            RBW:1000.000kHz VBW:1.000kHz SWT:Auto            Detector : Peak</p>	<p>Site : 03CH07-HY            Condition : FCC CLASS-B (AVG) 3m HF-ANT_130829 VERTICAL            RBW:1000.000kHz VBW:1.000kHz SWT:Auto            Detector : Peak</p>



WIFI	2.4GHz 2400~2483.5MHz Band Edge @ 3m	
ANT	802.11g CH06 2437MHz - L	
1	Horizontal	Vertical
Peak	<p>Date: 2016-02-27</p> <p>Site : 03CH07-HY Condition : FCC CLASS-B 3m HF-ANT_130829 HORIZONTAL Detector : Peak</p>	<p>Date: 2016-02-27</p> <p>Site : 03CH07-HY Condition : FCC CLASS-B 3m HF-ANT_130829 VERTICAL Detector : Peak</p>
Avg.	<p>Date: 2016-02-27</p> <p>Site : 03CH07-HY Condition : FCC CLASS-B (AVG) 3m HF-ANT_130829 HORIZONTAL Detector : Peak</p>	<p>Date: 2016-02-27</p> <p>Site : 03CH07-HY Condition : FCC CLASS-B (AVG) 3m HF-ANT_130829 VERTICAL Detector : Peak</p>



WIFI	2.4GHz 2400~2483.5MHz Band Edge @ 3m	
ANT	802.11g CH06 2437MHz - R	
1	Horizontal	Vertical
Peak	<p>Site : 03CH07-HY            Condition : FCC CLASS-B 3m HF-ANT_130829 HORIZONTAL            RBW:1000.000kHz VBW:3000.000kHz SWT:Auto            Detector : Peak</p>	<p>Site : 03CH07-HY            Condition : FCC CLASS-B 3m HF-ANT_130829 VERTICAL            RBW:1000.000kHz VBW:3000.000kHz SWT:Auto            Detector : Peak</p>
Avg.	<p>Site : 03CH07-HY            Condition : FCC CLASS-B (AVG) 3m HF-ANT_130829 HORIZONTAL            RBW:1000.000kHz VBW:1.000kHz SWT:Auto            Detector : Peak</p>	<p>Site : 03CH07-HY            Condition : FCC CLASS-B (AVG) 3m HF-ANT_130829 VERTICAL            RBW:1000.000kHz VBW:1.000kHz SWT:Auto            Detector : Peak</p>



WIFI	2.4GHz 2400~2483.5MHz Band Edge @ 3m	
ANT	802.11g CH11 2462MHz	
1	Horizontal	Vertical
Peak	<p>Date: 2016-02-27</p> <p>Site : 03CH07-HY            Condition : FCC CLASS-B 3m HF-ANT_130829 HORIZONTAL            RBW:1000.000kHz VBW:3000.000kHz SWT:Auto            Detector : Peak</p>	<p>Date: 2016-02-27</p> <p>Site : 03CH07-HY            Condition : FCC CLASS-B 3m HF-ANT_130829 VERTICAL            RBW:1000.000kHz VBW:3000.000kHz SWT:Auto            Detector : Peak</p>
Avg.	<p>Date: 2016-02-27</p> <p>Site : 03CH07-HY            Condition : FCC CLASS-B (AVG) 3m HF-ANT_130829 HORIZONTAL            RBW:1000.000kHz VBW:1.000kHz SWT:Auto            Detector : Peak</p>	<p>Date: 2016-02-27</p> <p>Site : 03CH07-HY            Condition : FCC CLASS-B (AVG) 3m HF-ANT_130829 VERTICAL            RBW:1000.000kHz VBW:1.000kHz SWT:Auto            Detector : Peak</p>

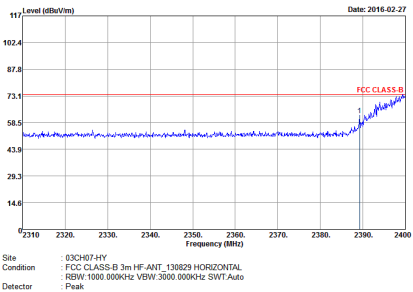
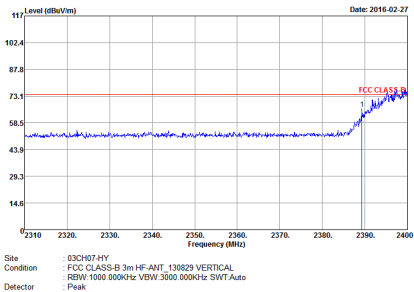
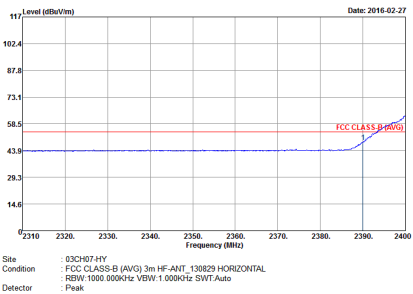
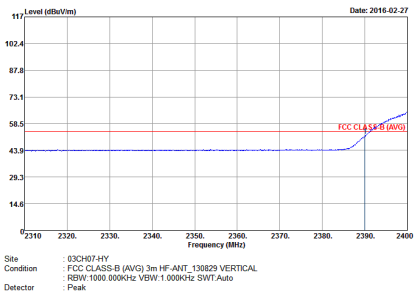

**2.4GHz 2400~2483.5MHz**  
**WIFI 802.11n HT20 (Band Edge @ 3m)**

WIFI	2.4GHz 2400~2483.5MHz Band Edge @ 3m	
ANT	802.11n HT20 CH01 2412MHz	
1	Horizontal	Vertical
<b>Peak</b>	 <p>Site : 03CH07-HY            Condition : FCC CLASS-B 3m HF-ANT_130829 HORIZONTAL            RBW:1000.000kHz VBW:3000.000kHz SWT:Auto            Detector : Peak</p>	 <p>Site : 03CH07-HY            Condition : FCC CLASS-B 3m HF-ANT_130829 VERTICAL            RBW:1000.000kHz VBW:3000.000kHz SWT:Auto            Detector : Peak</p>
<b>Avg.</b>	 <p>Site : 03CH07-HY            Condition : FCC CLASS-B (AVG) 3m HF-ANT_130829 HORIZONTAL            RBW:1000.000kHz VBW:1.000kHz SWT:Auto            Detector : Peak</p>	 <p>Site : 03CH07-HY            Condition : FCC CLASS-B (AVG) 3m HF-ANT_130829 VERTICAL            RBW:1000.000kHz VBW:1.000kHz SWT:Auto            Detector : Peak</p>



WIFI	2.4GHz 2400~2483.5MHz Band Edge @ 3m	
ANT	802.11n HT20 CH06 2437MHz - L	
1	Horizontal	Vertical
Peak	<p>Site : 03CH07-HY Condition : FCC CLASS-B 3m HF-ANT_130829 HORIZONTAL Detector : Peak</p>	<p>Site : 03CH07-HY Condition : FCC CLASS-B 3m HF-ANT_130829 VERTICAL Detector : Peak</p>
Avg.	<p>Site : 03CH07-HY Condition : FCC CLASS-B (AVG) 3m HF-ANT_130829 HORIZONTAL Detector : Peak</p>	<p>Site : 03CH07-HY Condition : FCC CLASS-B (AVG) 3m HF-ANT_130829 VERTICAL Detector : Peak</p>

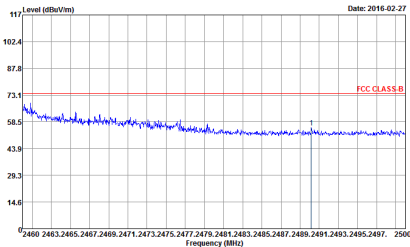
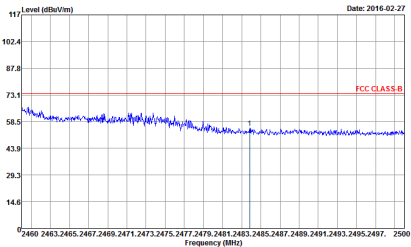
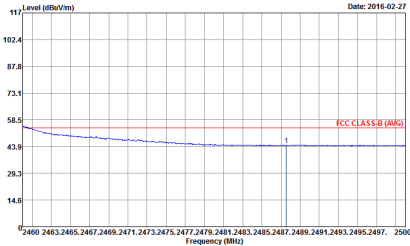
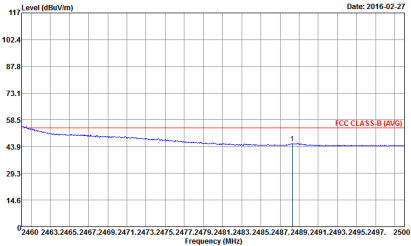

WIFI	2.4GHz 2400~2483.5MHz Band Edge @ 3m	
ANT	802.11n HT20 CH06 2437MHz - R	
1	Horizontal	Vertical
Peak	 <p>Date: 2016-02-27</p> <p>Site : 03CH07-HY Condition : FCC CLASS-B 3m HF-ANT_130829 HORIZONTAL RBW: 1000.000kHz VBW: 3000.000kHz SWT: Auto Detector : Peak</p>	 <p>Date: 2016-02-27</p> <p>Site : 03CH07-HY Condition : FCC CLASS-B 3m HF-ANT_130829 VERTICAL RBW: 1000.000kHz VBW: 3000.000kHz SWT: Auto Detector : Peak</p>
Avg.	 <p>Date: 2016-02-27</p> <p>Site : 03CH07-HY Condition : FCC CLASS-B (AVG) 3m HF-ANT_130829 HORIZONTAL RBW: 1000.000kHz VBW: 1.000kHz SWT: Auto Detector : Peak</p>	 <p>Date: 2016-02-27</p> <p>Site : 03CH07-HY Condition : FCC CLASS-B (AVG) 3m HF-ANT_130829 VERTICAL RBW: 1000.000kHz VBW: 1.000kHz SWT: Auto Detector : Peak</p>



WIFI	2.4GHz 2400~2483.5MHz Band Edge @ 3m	
ANT	802.11n HT20 CH11 2462MHz	
1	Horizontal	Vertical
Peak	<p>Date: 2016-02-27</p> <p>Site : 03CH07-HY Condition : FCC CLASS-B 3m HF-ANT_130829 HORIZONTAL RBW: 1000.000kHz VBW: 3000.000kHz SWT: Auto Detector : Peak</p>	<p>Date: 2016-02-27</p> <p>Site : 03CH07-HY Condition : FCC CLASS-B 3m HF-ANT_130829 VERTICAL RBW: 1000.000kHz VBW: 3000.000kHz SWT: Auto Detector : Peak</p>
Avg.	<p>Date: 2016-02-27</p> <p>Site : 03CH07-HY Condition : FCC CLASS-B (AVG) 3m HF-ANT_130829 HORIZONTAL RBW: 1000.000kHz VBW: 1.000kHz SWT: Auto Detector : Peak</p>	<p>Date: 2016-02-27</p> <p>Site : 03CH07-HY Condition : FCC CLASS-B (AVG) 3m HF-ANT_130829 VERTICAL RBW: 1000.000kHz VBW: 1.000kHz SWT: Auto Detector : Peak</p>



2.4GHz 2400~2483.5MHz  
WIFI 802.11b (Harmonic @ 3m)

WIFI	2.4GHz 2400~2483.5MHz Harmonic @ 3m	
ANT	802.11b CH01 2412MHz	
1	Horizontal	Vertical
Peak Avg.	<p>Site : 03CH07-HY Condition : FCC CLASS B 3m SHF-EHF_131029 HORIZONTAL Detector : Peak</p>	<p>Site : 03CH07-HY Condition : FCC CLASS B 3m SHF-EHF_131029 VERTICAL Detector : Peak</p>



WIFI	2.4GHz 2400~2483.5MHz Harmonic @ 3m	
ANT	802.11b CH06 2437MHz	
1	Horizontal	Vertical
Peak Avg.	<p>Site : 03CH07-HY Condition : FCC CLASS-B 3m SHF-EHF_131029 HORIZONTAL Detector : Peak</p>	<p>Site : 03CH07-HY Condition : FCC CLASS-B 3m SHF-EHF_131029 VERTICAL Detector : Peak</p>



WIFI	2.4GHz 2400~2483.5MHz Harmonic @ 3m	
ANT	802.11b CH11 2462MHz	
1	Horizontal	Vertical
Peak Avg.	<p>Site : 03CH07-HY Condition : FCC CLASS-B 3m SHF-EHF_131029 HORIZONTAL Detector : Peak</p>	<p>Site : 03CH07-HY Condition : FCC CLASS-B 3m SHF-EHF_131029 VERTICAL Detector : Peak</p>



2.4GHz 2400~2483.5MHz  
WIFI 802.11g (Harmonic @ 3m)

WIFI	2.4GHz 2400~2483.5MHz Harmonic @ 3m	
ANT	802.11g CH01 2412MHz	
1	Horizontal	Vertical
Peak Avg.	<p>Site : 03CH07-HY Condition : FCC CLASS-B 3m SHF-EHF_131029 HORIZONTAL Detector : Peak</p>	<p>Site : 03CH07-HY Condition : FCC CLASS-B 3m SHF-EHF_131029 VERTICAL Detector : Peak</p>



WIFI	2.4GHz 2400~2483.5MHz Harmonic @ 3m	
ANT	802.11g CH06 2437MHz	
1	Horizontal	Vertical
Peak Avg.	<p>Site : 03CH07-HY Condition : FCC CLASS B 3m SHF-EHF_131029 HORIZONTAL Detector : Peak</p>	<p>Site : 03CH07-HY Condition : FCC CLASS B 3m SHF-EHF_131029 VERTICAL Detector : Peak</p>



WIFI	2.4GHz 2400~2483.5MHz Harmonic @ 3m	
ANT	802.11g CH11 2462MHz	
1	Horizontal	Vertical
Peak Avg.	<p>Site : 03CH07-HY Condition : FCC CLASS-B 3m SHF-EHF_131029 HORIZONTAL Detector : Peak</p>	<p>Site : 03CH07-HY Condition : FCC CLASS-B 3m SHF-EHF_131029 VERTICAL Detector : Peak</p>



2.4GHz 2400~2483.5MHz  
WIFI 802.11n HT20 (Harmonic @ 3m)

WIFI	2.4GHz 2400~2483.5MHz Harmonic @ 3m	
ANT	802.11n HT20 CH01 2412MHz	
1	Horizontal	Vertical
Peak Avg.	<p>Site : 03CH07-HY Condition : FCC CLASS-B 3m SHF-EHF_131029 HORIZONTAL Detector : Peak</p>	<p>Site : 03CH07-HY Condition : FCC CLASS-B 3m SHF-EHF_131029 VERTICAL Detector : Peak</p>



WIFI	2.4GHz 2400~2483.5MHz Harmonic @ 3m	
ANT	802.11n HT20 CH06 2437MHz	
1	Horizontal	Vertical
Peak Avg.	<p>Site : 03CH07-HY Condition : FCC CLASS B 3m SHF-EHF_131029 HORIZONTAL Detector : Peak</p>	<p>Site : 03CH07-HY Condition : FCC CLASS B 3m SHF-EHF_131029 VERTICAL Detector : Peak</p>



WIFI	2.4GHz 2400~2483.5MHz Harmonic @ 3m	
ANT	802.11n HT20 CH11 2462MHz	
1	Horizontal	Vertical
Peak Avg.	<p>Site : 03CH07-HY Condition : FCC CLASS-B 3m SHF-EHF_131029 HORIZONTAL Detector : Peak</p>	<p>Site : 03CH07-HY Condition : FCC CLASS-B 3m SHF-EHF_131029 VERTICAL Detector : Peak</p>



Emission below 1GHz
2.4GHz WIFI 802.11n HT20 (LF)

Table with 3 columns: WIFI (2.4GHz 2400~2483.5MHz), ANT (802.11n HT20 LF), and 1 (Horizontal/Vertical). It contains two graphs showing Level (dBuV/m) vs Frequency (MHz) for QP / Peak, with FCC CLASS B limits and peak markers.