



FCC RF Test Report

APPLICANT : Motorola Mobility, LLC
EQUIPMENT : Mobile Cellular Phone
BRAND NAME : Motorola
MODEL NAME : 8028
FCC ID : IHDT56VA2
STANDARD : FCC Part 15 Subpart E §15.407
CLASSIFICATION : (NII) Unlicensed National Information Infrastructure

The product was received on Feb. 03, 2016 and testing was completed on Mar. 05, 2016. We, SPORTON INTERNATIONAL INC., would like to declare that the tested sample has been evaluated in accordance with the test procedures and has been in compliance with the applicable technical standards.

The test results in this report apply exclusively to the tested model / sample. Without written approval of SPORTON INTERNATIONAL INC., the test report shall not be reproduced except in full.

Reviewed by: Joseph Lin / Supervisor

Approved by: Jones Tsai / Manager



SPORTON INTERNATIONAL INC.

No. 52, Hwa Ya 1st Rd., Hwa Ya Technology Park, Kwei-Shan District, Tao Yuan City, Taiwan, R.O.C.

SPORTON INTERNATIONAL INC.

TEL : 886-3-327-3456

FAX : 886-3-328-4978

FCC ID : IHDT56VA2

Page Number : 1 of 34

Report Issued Date : Apr. 28, 2016

Report Version : Rev. 02

Report Template No.: BU5-FR15EWLB4 AC MA Version 1.2



TABLE OF CONTENTS

SUMMARY OF TEST RESULT 4

1 GENERAL DESCRIPTION 5

1.1 Applicant 5

1.2 Manufacturer 5

1.3 Product Feature of Equipment Under Test 5

1.4 Product Specification of Equipment Under Test 6

1.5 Modification of EUT 6

1.6 Testing Location 6

1.7 Applicable Standards 7

2 TEST CONFIGURATION OF EQUIPMENT UNDER TEST 8

2.1 Carrier Frequency and Channel 8

2.2 Pre-Scanned RF Power 9

2.3 Test Mode 10

2.4 Connection Diagram of Test System 11

2.5 Support Unit used in test configuration and system 12

2.6 EUT Operation Test Setup 12

2.7 Measurement Results Explanation Example 12

3 TEST RESULT 13

3.1 6dB and 26dB and 99% Occupied Bandwidth Measurement 13

3.2 Maximum Conducted Output Power Measurement 16

3.3 Power Spectral Density Measurement 17

3.4 Unwanted Emissions Measurement 20

3.5 AC Conducted Emission Measurement 25

3.6 Frequency Stability Measurement 30

3.7 Automatically Discontinue Transmission 31

3.8 Antenna Requirements 32

4 LIST OF MEASURING EQUIPMENT 33

5 UNCERTAINTY OF EVALUATION 34

APPENDIX A. CONDUCTED TEST RESULTS

APPENDIX B. RADIATED TEST RESULTS

APPENDIX C RADIATED SPURIOUS EMISSION PLOTS



SUMMARY OF TEST RESULT

Report Section	FCC Rule	Description	Limit	Result	Remark
3.1	15.403(i)	6dB, 26dB and 99% Occupied Bandwidth	> 500kHz	Pass	-
3.2	15.407(a)	Maximum Conducted Output Power	≤ 30 dBm	Pass	-
3.3	15.407(a)	Power Spectral Density	≤ 30 dBm/500kHz	Pass	-
3.4	15.407(b)	Unwanted Emissions	≤ -17, -27 dBm/MHz & 15.209(a)	Pass	Under limit 1.88 dB at 5711.000 MHz
3.5	15.207	AC Conducted Emission	15.207(a)	Pass	Under limit 15.60 dB at 3.110 MHz
3.6	15.407(g)	Frequency Stability	Within Operation Band	Pass	-
3.7	15.407(c)	Automatically Discontinue Transmission	Discontinue Transmission	Pass	-
3.8	15.203 & 15.407(a)	Antenna Requirement	N/A	Pass	-



1 General Description

1.1 Applicant

Motorola Mobility, LLC
222 W. Merchandise Mart Plaza, Chicago IL 60654 USA

1.2 Manufacturer

Motorola Mobility, LLC
222 W. Merchandise Mart Plaza, Chicago IL 60654 USA

1.3 Product Feature of Equipment Under Test

Product Feature	
Equipment	Mobile Cellular Phone
Brand Name	Motorola
Model Name	8028
FCC ID	IHDT56VA2
IMEI Code	354117070006154 (for Radiated Spurious Emission) 354117070005990 (for AC Conducted Emission)
EUT supports Radios application	GSM/EGPRS/WCDMA/HSPA/LTE/FM WLAN 11b/g/n HT20 WLAN 11a/n HT20/HT40 Bluetooth v3.0 EDR Bluetooth v4.0 LE
HW Version	DVT2
EUT Stage	Identical Prototype

Remark: The above EUT's information was declared by manufacturer. Please refer to the specifications or user's manual for more detailed description.

Accessory List	
AC Adapter	Brand Name : Motorola
	Model Name : SPN5866A
USB Cable	Brand Name : Motorola
	Model Name : SKN6462A
Earphone	Brand Name : Motorola
	Model Name : SJYN1181B



1.4 Product Specification of Equipment Under Test

Standards-related Product Specification	
Tx/Rx Channel Frequency Range	5745 MHz ~ 5825 MHz
Maximum Output Power	802.11a : 17.47 dBm / 0.0558 W 802.11n HT20 : 16.68 dBm / 0.0466 W 802.11n HT40 : 16.50 dBm / 0.0447 W
99% Occupied Bandwidth	802.11a : 20.85 MHz 802.11n HT20 : 20.60 MHz 802.11n HT40 : 37.10 MHz
Type of Modulation	802.11a/n : OFDM (BPSK / QPSK / 16QAM / 64QAM)
Antenna Type	Fixed Internal Antenna type (The antenna peak gain of EUT is less than 6 dBi)

1.5 Modification of EUT

No modifications are made to the EUT during all test items.

1.6 Testing Location

Sporton Lab is accredited to ISO 17025 by Taiwan Accreditation Foundation (TAF code : 1190) and the FCC designation No. TW1022 under the FCC 2.948(e) by Mutual Recognition Agreement (MRA) in FCC Test.

Test Site	SPORTON INTERNATIONAL INC.		
Test Site Location	No. 52, Hwa Ya 1 st Rd., Hwa Ya Technology Park, Kwei-Shan District, Tao Yuan City, Taiwan, R.O.C. TEL: +886-3-327-3456 FAX: +886-3-328-4978		
Test Site No.	Sporton Site No.		
	TH02-HY	CO05-HY	03CH07-HY

Note: The test site complies with ANSI C63.4 2014 requirement.



1.7 Applicable Standards

According to the specifications of the manufacturer, the EUT must comply with the requirements of the following standards:

- ♦ FCC Part 15 Subpart E
- ♦ FCC KDB 789033 D02 General UNII Test Procedures New Rules v01r02
- ♦ ANSI C63.10-2013

Remark:

1. All test items were verified and recorded according to the standards and without any deviation during the test.
2. This EUT has also been tested and complied with the requirements of FCC Part 15, Subpart B, recorded in a separate test report.



2 Test Configuration of Equipment Under Test

The EUT has been associated with peripherals and configuration operated in a manner tended to maximize its emission characteristics in a typical application. Frequency range investigated: conducted emission (150 kHz to 30 MHz) and radiated emission (9 kHz to the 10th harmonic of the highest fundamental frequency or to 40 GHz, whichever is lower). For radiated measurement, pre-scanned in three orthogonal panels, X, Y, Z. The worst cases (Z plane) were recorded in this report.

The final configuration from all the combinations and the worst-case data rates were investigated by measuring the maximum power across all the data rates and modulation modes under section 2.2.

Based on the worst configuration found above, the RF power setting is set individually to meet FCC compliance limit for the final conducted and radiated tests shown in section 2.3.

2.1 Carrier Frequency and Channel

Frequency Band	Channel	Freq. (MHz)	Channel	Freq. (MHz)
5725-5850 MHz Band 4 (U-NII-3)	149	5745	157	5785
	151	5755	159	5795
	153	5765	161	5805
	155	5775	165	5825

Note: The above Frequency and Channel in boldface were 802.11n HT40.



2.2 Pre-Scanned RF Power

Preliminary tests were performed in different data rate and data rate associated with the highest power were chosen for full test in the following tables. Final Output Power equals to Measured Output Power adds the duty factor.

Channel	Frequency	5GHz 802.11a Average Power (dBm)							
		Data Rate							
		6 Mbps	9 Mbps	12 Mbps	18 Mbps	24 Mbps	36 Mbps	48 Mbps	54 Mbps
CH 149	5745 MHz	16.64	16.20	16.27	16.33	16.29	15.04	14.25	13.43
CH 157	5785 MHz	17.47	16.73	16.71	16.82	16.37	15.63	14.73	13.84
CH 165	5825 MHz	16.94	16.61	16.67	16.74	16.27	15.63	14.65	13.78

Channel	Frequency	5GHz 802.11n HT20 Average Power (dBm)							
		Data Rate							
		MCS0	MCS1	MCS2	MCS3	MCS4	MCS5	MCS6	MCS7
CH 149	5745 MHz	16.50	15.86	15.85	15.83	15.51	14.63	13.85	12.99
CH 157	5785 MHz	16.68	16.33	16.33	16.31	15.95	15.17	14.31	13.44
CH 165	5825 MHz	16.20	15.80	15.74	15.78	15.45	14.82	13.78	12.95

Channel	Frequency	5GHz 802.11n HT40 Average Power (dBm)							
		Data Rate							
		MCS0	MCS1	MCS2	MCS3	MCS4	MCS5	MCS6	MCS7
CH 151	5755 MHz	14.42	14.31	14.32	14.39	14.41	14.36	13.79	12.89
CH 159	5795 MHz	16.50	15.93	15.92	16.01	15.52	15.19	14.36	13.44



2.3 Test Mode

Final test mode of conducted test items and radiated spurious emissions are considering the modulation and worse data rates from the power table described in section 2.2.

Modulation	Data Rate
802.11a	6 Mbps
802.11n HT20	MCS0
802.11n HT40	MCS0

AC Conducted Emission	Mode 1 : GSM850 Idle + Bluetooth Link + WLAN (5GHz) Link + MP3 + Earphone + USB Cable (Charging from Adapter)
--------------------------------------	--

Ch. #		Band IV : 5725-5850 MHz		
		802.11a	802.11n HT20	802.11n HT40
L	Low	149	149	151
M	Middle	157	157	-
H	High	165	165	159

2.4 Connection Diagram of Test System

<WLAN Tx Mode>

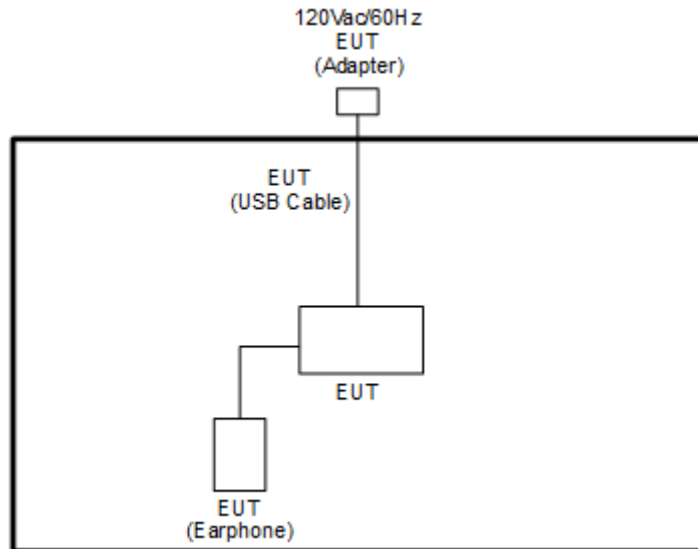

<AC Conducted Emission Mode>

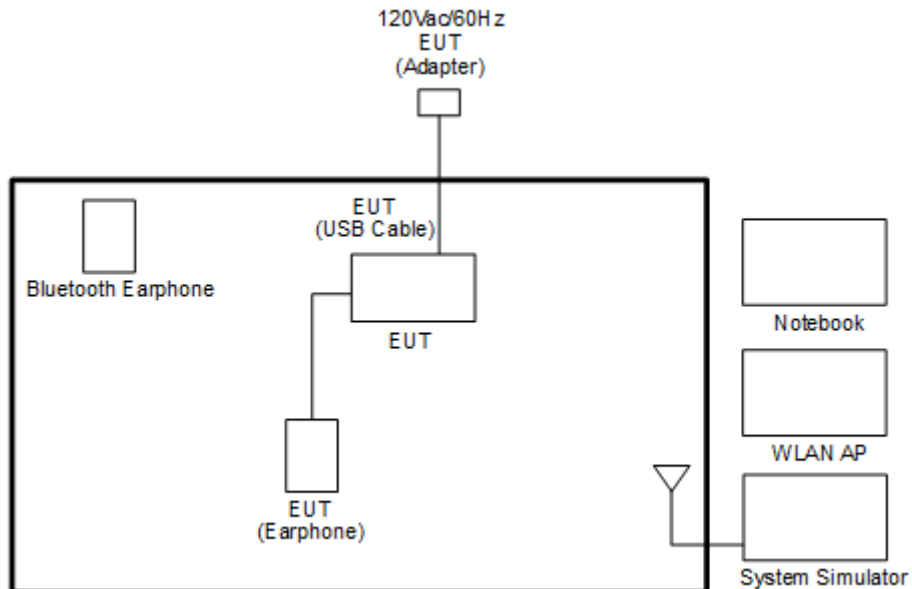



2.5 Support Unit used in test configuration and system

Item	Equipment	Trade Name	Model Name	FCC ID	Data Cable	Power Cord
1.	System Simulator	Anritsu	MT8820C	N/A	N/A	Unshielded, 1.8 m
2.	WLAN AP	D-Link	DIR-865L	KA2IR865LA1	N/A	Unshielded, 1.8 m
3.	Notebook	DELL	Latitude E6320	FCC DoC/ Contains FCC ID: QDS-BRCM1054	N/A	AC I/P: Unshielded, 1.2 m DC O/P: Shielded, 1.8 m
4.	Bluetooth Earphone	Sony Ericsson	MW600	PY7DDA-2029	N/A	N/A
5.	SD Card	SanDisk	MicroSD HC	FCC DoC	N/A	N/A

2.6 EUT Operation Test Setup

For WLAN function, programmed RF utility, "QRCT" installed in the notebook make the EUT provide functions like channel selection and power level for continuous transmitting and receiving signals.

2.7 Measurement Results Explanation Example

For all conducted test items:

The offset level is set in the spectrum analyzer to compensate the RF cable loss and attenuator factor between EUT conducted output port and spectrum analyzer. With the offset compensation, the spectrum analyzer reading level is exactly the EUT RF output level.

Example :

The spectrum analyzer offset is derived from RF cable loss and attenuator factor.

$$\text{Offset} = \text{RF cable loss} + \text{attenuator factor}.$$

Following shows an offset computation example with cable loss 4.2 dB and 10dB attenuator.

$$\begin{aligned} \text{Offset(dB)} &= \text{RF cable loss(dB)} + \text{attenuator factor(dB)}. \\ &= 4.2 + 10 = 14.2 \text{ (dB)} \end{aligned}$$

3 Test Result

3.1 6dB and 26dB and 99% Occupied Bandwidth Measurement

3.1.1 Description of 6dB and 26dB and 99% Occupied Bandwidth

The minimum 6 dB bandwidth shall be at least 500 kHz.

26dB and 99% Occupied bandwidth are reporting only.

3.1.2 Measuring Instruments

The measuring equipment is listed in the section 4 of this test report.

3.1.3 Test Procedures

1. The testing follows FCC KDB 789033 D02 General UNII Test Procedures New Rules v01r02.
Section C) Emission bandwidth for the band 5.725-5.85GHz
2. Set RBW = 100kHz.
3. Set the VBW $\geq 3 \times$ RBW.
4. Detector = Peak.
5. Trace mode = max hold
6. Measure the maximum width of the emission that is 6 dB down from the peak of the emission.
7. Measure and record the results in the test report.

3.1.4 Test Setup

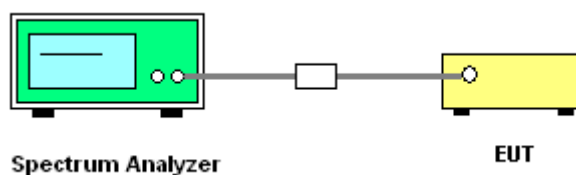



3.1.5 Test Result of 6dB Bandwidth

Please refer to Appendix A.

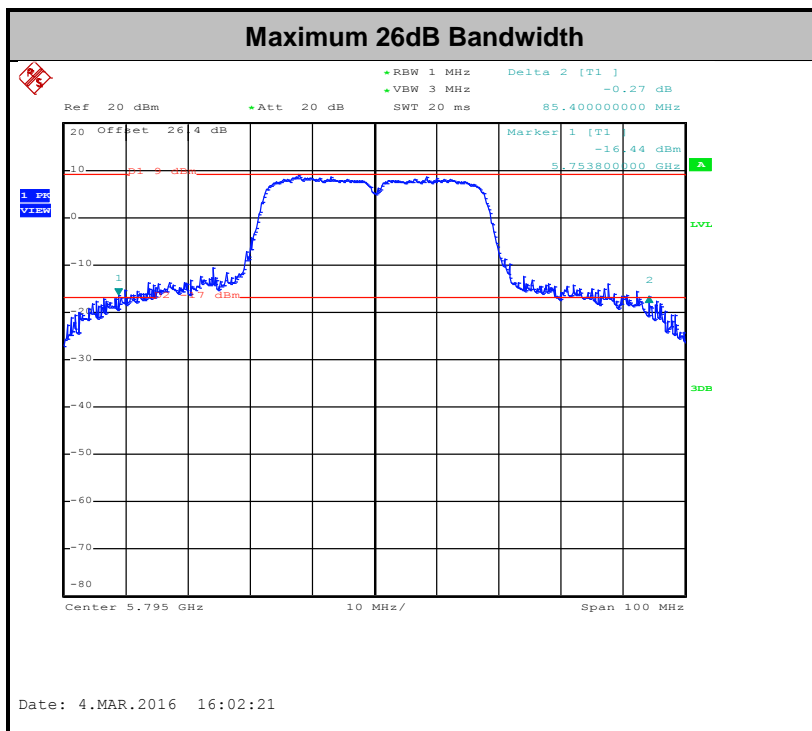
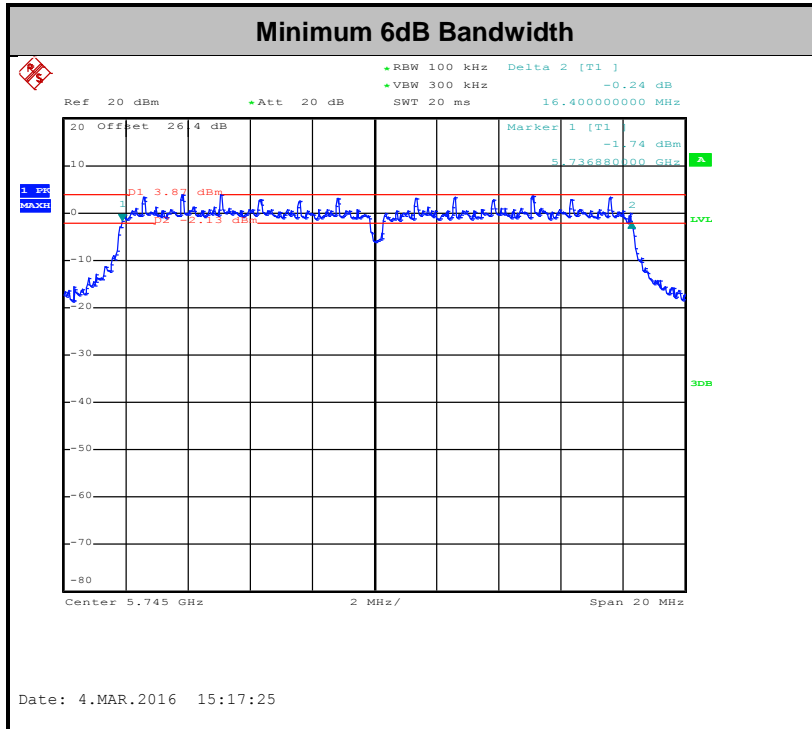

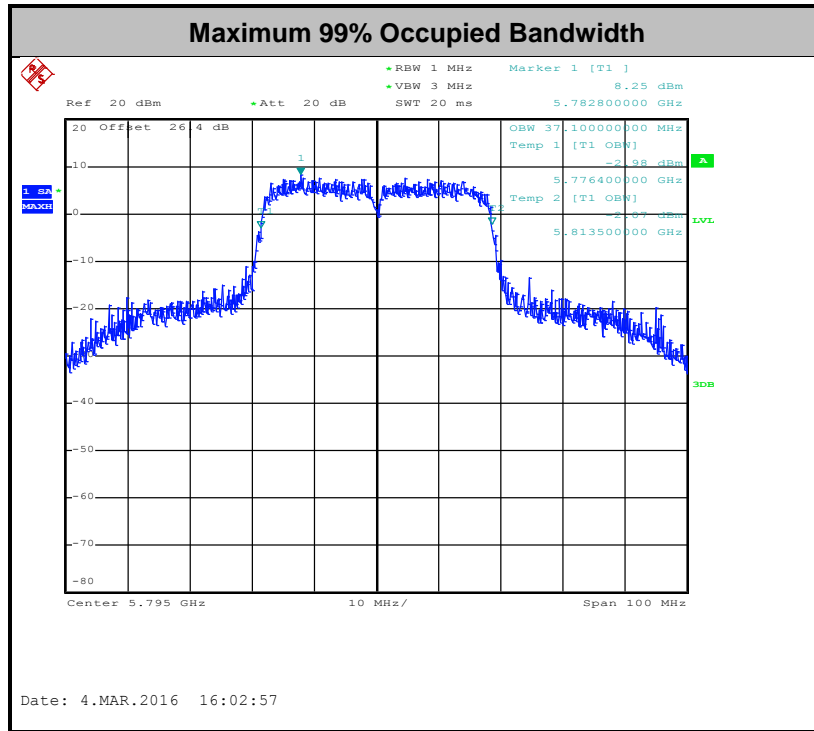

Note: The occupied channel bandwidth is maintained within the band of operation for all of the modulations.

3.2 Maximum Conducted Output Power Measurement

3.2.1 Limit of Maximum Conducted Output Power

For the band 5.725–5.85 GHz, the maximum conducted output power over the frequency band of operation shall not exceed 1 W.

If transmitting antennas of directional gain greater than 6 dBi are used, the peak output power shall be reduced by the amount in dB that the directional gain of the antenna exceeds 6 dBi.

3.2.2 Measuring Instruments

The measuring equipment is listed in the section 4 of this test report.

3.2.3 Test Procedures

The testing follows Method PM of FCC KDB 789033 D02 General UNII Test Procedures New Rules v01r02.

Method PM (Measurement using an RF average power meter):

1. Measurement is performed using a wideband RF power meter.
2. The EUT is configured to transmit continuously with a consistent duty cycle at its maximum power control level.
3. Measure the average power of the transmitter, and the average power is corrected with duty factor, $10 \log(1/x)$, where x is the duty cycle.

3.2.4 Test Setup

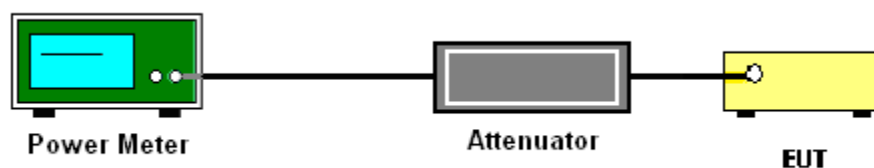

3.2.5 Test Result of Maximum Conducted Output Power

Please refer to Appendix A.



3.3 Power Spectral Density Measurement

3.3.1 Limit of Power Spectral Density

For the band 5.725–5.85 GHz, the maximum power spectral density shall not exceed 30 dBm in any 500-kHz band.

If transmitting antennas of directional gain greater than 6 dBi are used, the peak output power shall be reduced by the amount in dB that the directional gain of the antenna exceeds 6 dBi.

3.3.2 Measuring Instruments

The measuring equipment is listed in the section 4 of this test report.

3.3.3 Test Procedures

The testing follows FCC KDB 789033 D02 General UNII Test Procedures New Rules v01r02. Section F) Maximum power spectral density.

Method SA-2

(trace averaging across on and off times of the EUT transmissions, followed by duty cycle correction).

1. The testing follows Method SA-2 of FCC KDB 789033 D02 General UNII Test Procedures New Rules v01r02.
 - Measure the duty cycle.
 - Set span to encompass the entire emission bandwidth (EBW) of the signal.
 - Set RBW = 300 kHz.
 - Set VBW \geq 1 MHz.
 - Number of points in sweep \geq 2 Span / RBW.
 - Sweep time = auto.
 - Detector = RMS
 - Trace average at least 100 traces in power averaging mode.
 - Add $10 \log(500\text{kHz}/\text{RBW})$ to the test result.
 - Add $10 \log(1/x)$, where x is the duty cycle, to the measured power in order to compute the average power during the actual transmission times. For example, add $10 \log(1/0.25) = 6$ dB if the duty cycle is 25 percent.

2. The RF output of EUT was connected to the spectrum analyzer by a low loss cable.
3. Each plot has already offset with cable loss, and attenuator loss. Measure the PPSD and record it.

3.3.4 Test Setup

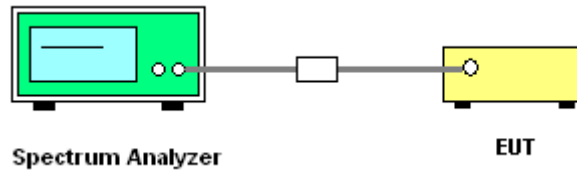



3.3.5 Test Result of Power Spectral Density

Please refer to Appendix A.

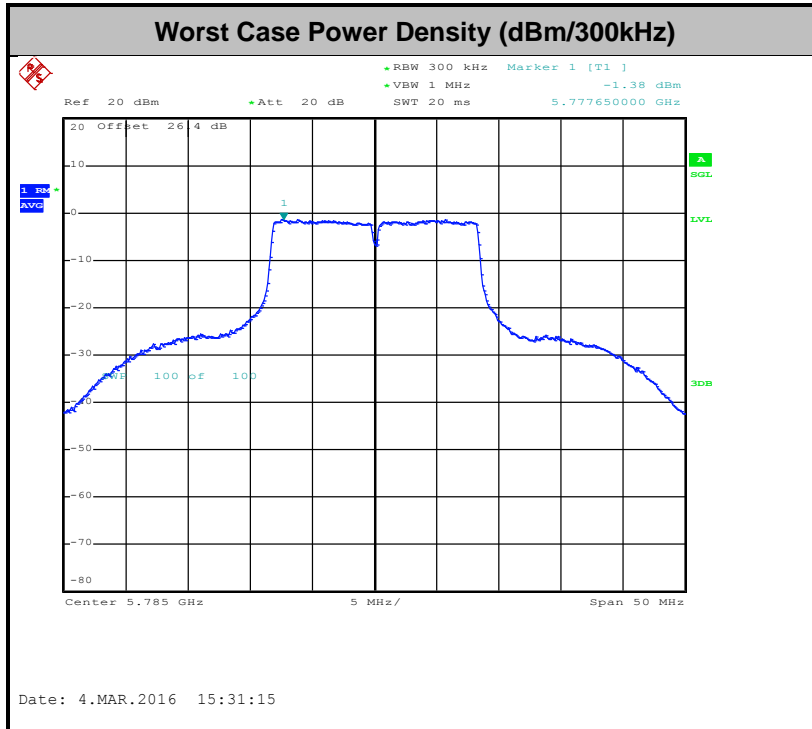



3.4 Unwanted Emissions Measurement

This section as specified in FCC Part 15.407(b) is to measure unwanted emissions through radiated measurement for band edge spurious emissions and out of band emissions measurement. The unwanted emissions shall comply with 15.407(b)(1) to (6), and restricted bands per FCC Part15.205.

3.4.1 Limit of Unwanted Emissions

- (1) For transmitters operating in the 5725-5850 MHz band: all emissions within the frequency range from the band edge to 10 MHz above or below the band edge shall not exceed an EIRP of -17 dBm/MHz (78.3dBµV/m); for frequencies 10 MHz or greater above or below the band edge, emissions shall not exceed an EIRP of -27 dBm/MHz (68.3dBµV/m).
- (2) Unwanted spurious emissions fallen in restricted bands per FCC Part15.205 shall comply with the general field strength limits set forth in § 15.209 as below table,

Frequency (MHz)	Field Strength (microvolts/meter)	Measurement Distance (meters)
0.009 – 0.490	2400/F(kHz)	300
0.490 – 1.705	24000/F(kHz)	30
1.705 – 30.0	30	30
30 – 88	100	3
88 – 216	150	3
216 - 960	200	3
Above 960	500	3

Note: The following formula is used to convert the EIRP to field strength.

$$E = \frac{1000000\sqrt{30P}}{3} \mu\text{V/m, where P is the eirp (Watts)}$$

EIRP (dBm)	Field Strength at 3m (dBµV/m)
-17	78.3
-27	68.3

- (3) KDB 789033 D02 General UNII Test Procedures New Rules v01r02 G)2)c) As specified in 15.407(b), emissions above 1000 MHz that are outside of the restricted bands are subject to a peak emission limit of -27 dBm/MHz (or -17 dBm/MHz as specified in 15.407(b)(4)). However, an out-of-band emission that complies with both the average and peak limits of 15.209 is not required to satisfy the -27 dBm/MHz or -17 dBm/MHz peak emission limit.



3.4.2 Measuring Instruments

The measuring equipment is listed in the section 4 of this test report.

3.4.3 Test Procedures

1. The testing follows FCC ANSI C63.10-2013.

Section G) Unwanted emissions measurement.

(1) Procedure for Unwanted Emissions Measurements Below 1000MHz

- RBW = 120 kHz
- VBW = 300 kHz
- Detector = Peak
- Trace mode = max hold

(2) Procedure for Peak Unwanted Emissions Measurements Above 1000 MHz

- RBW = 1 MHz
- VBW ≥ 3 MHz
- Detector = Peak
- Sweep time = auto
- Trace mode = max hold

(3) Procedures for Average Unwanted Emissions Measurements Above 1000MHz

- RBW = 1 MHz
- VBW = 10 Hz, when duty cycle is no less than 98 percent.
- $VBW \geq 1/T$, when duty cycle is less than 98 percent where T is the minimum transmission duration over which the transmitter is on and is transmitting at its maximum power control level for the tested mode of operation.

Antenna	Band	Duty Cycle(%)	T(us)	1/T(kHz)	VBW Setting
1	802.11a	87.261	1370	0.73	1kHz
1	802.11n HT20	86.486	1280	0.78	1kHz
1	802.11n HT40	75	630	1.59	3kHz



1. The EUT was placed on a turntable with 0.8 meter for frequency below 1GHz and 1.5 meter for frequency above 1GHz respectively above ground.
2. The EUT was set 3 meters from the interference receiving antenna which was mounted on the top of a variable height antenna tower.
3. The antenna is a broadband antenna and its height is adjusted between one meter and four meters above ground to find the maximum value of the field strength for both horizontal polarization and vertical polarization of the antenna.
4. For each suspected emission, the EUT was arranged to its worst case and then adjust the antenna tower (from 1 m to 4 m) and turntable (from 0 degree to 360 degrees) to find the maximum reading.
5. For testing below 1GHz, if the emission level of the EUT in peak mode was 3 dB lower than the limit specified, then peak values of EUT will be reported, otherwise, the emissions will be repeated one by one using the CISPR quasi-peak method and reported.
6. For testing above 1GHz, the emission level of the EUT in peak mode was 20dB lower than average limit (that means the emission level in average mode also complies with the limit in average mode), then peak values of EUT will be reported, otherwise, the emissions will be measured in average mode again and reported.

3.4.4 Test Setup

For radiated emissions below 30MHz

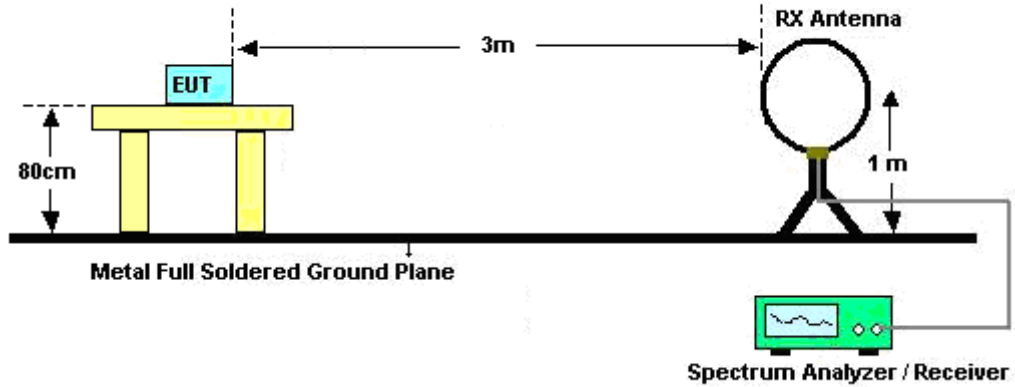

For radiated emissions from 30MHz to 1GHz

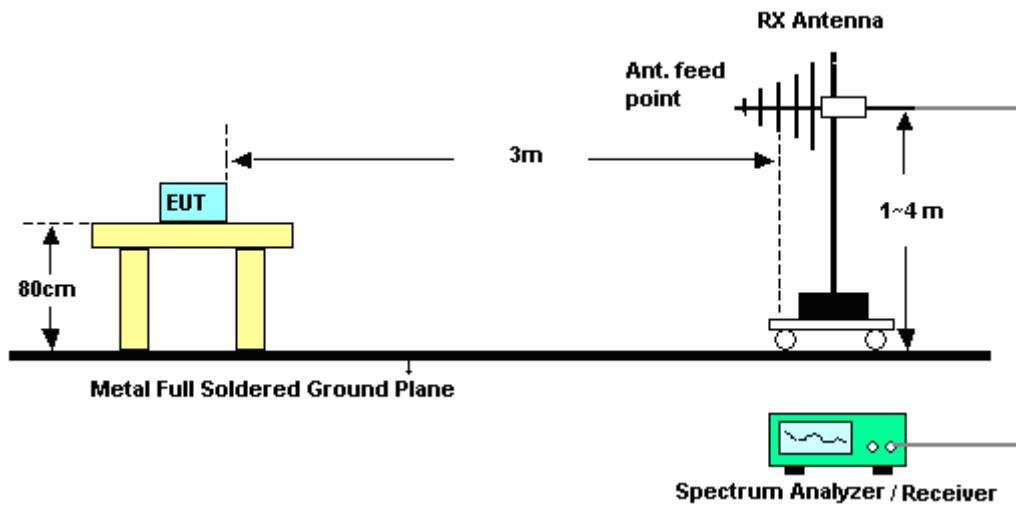

For radiated emissions above 1GHz

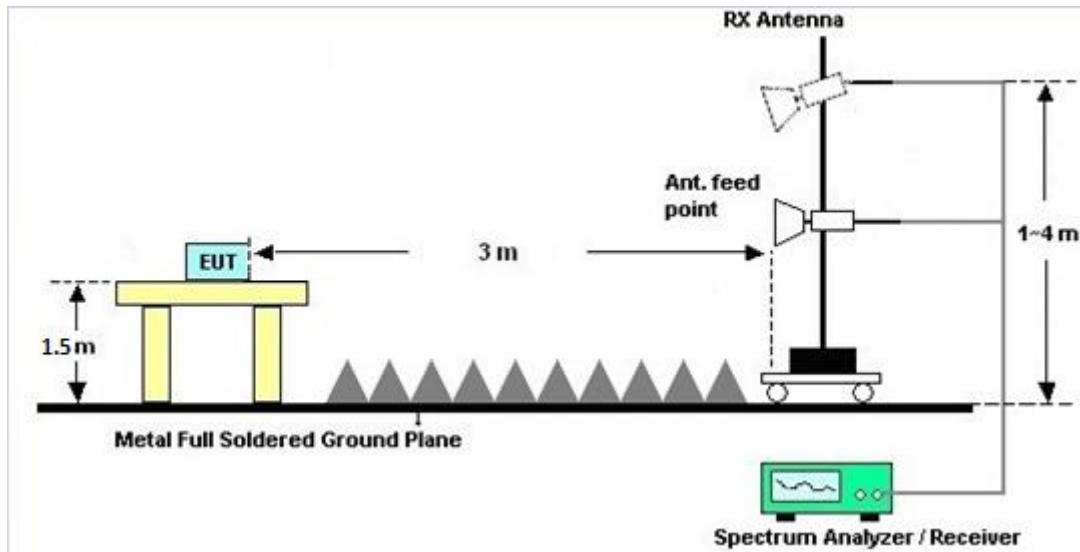

3.4.5 Test Results of Radiated Emissions (9 kHz ~ 30 MHz)

The low frequency, which started from 9 kHz to 30MHz, was pre-scanned and the result which was 20dB lower than the limit line per 15.31(o) was not reported.

3.4.6 Test Result of Radiated Band Edges

Please refer to Appendix B and C.

3.4.7 Test Result of Unwanted Radiated Emission (30MHz ~ 10th Harmonic)

Please refer to Appendix B and C.



3.5 AC Conducted Emission Measurement

3.5.1 Limit of AC Conducted Emission

For equipment that is designed to be connected to the public utility (AC) power line, the radio frequency voltage that is conducted back onto the AC power line on any frequency or frequencies within the band 150 kHz to 30 MHz shall not exceed the limits in the following table.

Frequency of emission (MHz)	Conducted limit (dB μ V)	
	Quasi-peak	Average
0.15-0.5	66 to 56*	56 to 46*
0.5-5	56	46
5-30	60	50

*Decreases with the logarithm of the frequency.

3.5.2 Measuring Instruments

The measuring equipment is listed in the section 4 of this test report.

3.5.3 Test Procedures

1. The EUT was placed 0.4 meter from the conducting wall of the shielding room was kept at least 80 centimeters from any other grounded conducting surface.
2. Connect EUT to the power mains through a line impedance stabilization network (LISN).
3. All the support units are connecting to the other LISN.
4. The LISN provides 50 ohm coupling impedance for the measuring instrument.
5. The FCC states that a 50 ohm, 50 microhenry LISN should be used.
6. Both sides of AC line were checked for maximum conducted interference.
7. The frequency range from 150 kHz to 30 MHz was searched.
8. Set the test-receiver system to Peak Detect Function and specified bandwidth with Maximum Hold Mode.

3.5.4 Test Setup

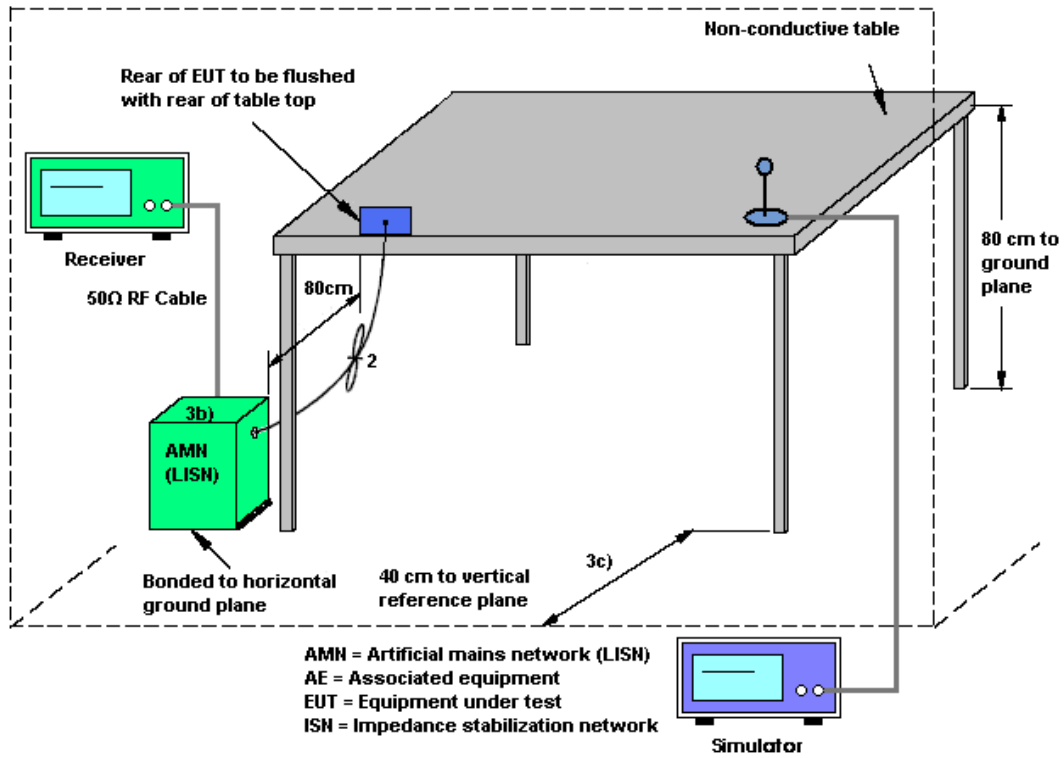



3.5.5 Test Result of AC Conducted Emission

Test Mode :	Mode 1	Temperature :	23~24°C
Test Engineer :	Kai-Chun Chu	Relative Humidity :	48~49%
Test Voltage :	120Vac / 60Hz	Phase :	Line
Function Type :	GSM850 Idle + Bluetooth Link + WLAN (5GHz) Link + MP3 + Earphone + USB Cable (Charging from Adapter)		

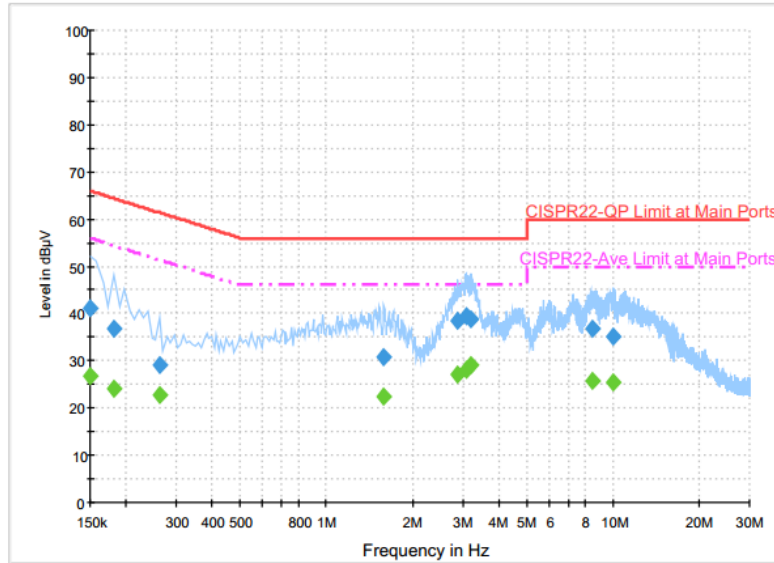

Final Result : QuasiPeak

Frequency (MHz)	QuasiPeak (dBµV)	Filter	Line	Corr. (dB)	Margin (dB)	Limit (dBµV)
0.150000	41.1	Off	L1	19.6	24.9	66.0
0.182000	36.9	Off	L1	19.6	27.5	64.4
0.262000	29.2	Off	L1	19.6	32.2	61.4
1.590000	30.7	Off	L1	19.6	25.3	56.0
2.870000	38.4	Off	L1	19.5	17.6	56.0
3.070000	39.4	Off	L1	19.6	16.6	56.0
3.206000	38.9	Off	L1	19.6	17.1	56.0
8.518000	36.8	Off	L1	19.7	23.2	60.0
9.982000	35.1	Off	L1	19.7	24.9	60.0

Final Result : Average

Frequency (MHz)	Average (dBµV)	Filter	Line	Corr. (dB)	Margin (dB)	Limit (dBµV)
0.150000	26.7	Off	L1	19.6	29.3	56.0
0.182000	24.1	Off	L1	19.6	30.3	54.4
0.262000	22.8	Off	L1	19.6	28.6	51.4
1.590000	22.5	Off	L1	19.6	23.5	46.0
2.870000	27.1	Off	L1	19.5	18.9	46.0
3.070000	28.2	Off	L1	19.6	17.8	46.0
3.206000	29.0	Off	L1	19.6	17.0	46.0
8.518000	25.6	Off	L1	19.7	24.4	50.0
9.982000	25.3	Off	L1	19.7	24.7	50.0



Test Mode :	Mode 1	Temperature :	23~24°C
Test Engineer :	Kai-Chun Chu	Relative Humidity :	48~49%
Test Voltage :	120Vac / 60Hz	Phase :	Neutral
Function Type :	GSM850 Idle + Bluetooth Link + WLAN (5GHz) Link + MP3 + Earphone + USB Cable (Charging from Adapter)		

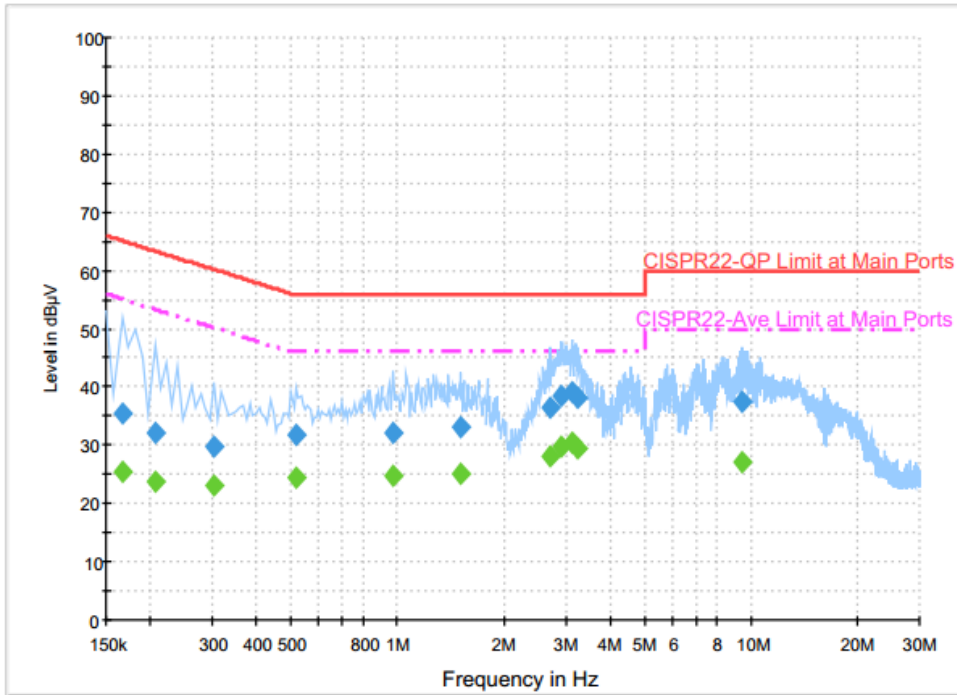

Final Result : QuasiPeak

Frequency (MHz)	QuasiPeak (dBµV)	Filter	Line	Corr. (dB)	Margin (dB)	Limit (dBµV)
0.166000	35.4	Off	N	19.6	29.8	65.2
0.206000	32.2	Off	N	19.7	31.2	63.4
0.302000	29.7	Off	N	19.6	30.5	60.2
0.518000	31.9	Off	N	19.6	24.1	56.0
0.974000	32.1	Off	N	19.6	23.9	56.0
1.510000	33.2	Off	N	19.6	22.8	56.0
2.702000	36.5	Off	N	19.4	19.5	56.0
2.910000	38.5	Off	N	19.5	17.5	56.0
3.110000	39.3	Off	N	19.6	16.7	56.0
3.246000	38.1	Off	N	19.6	17.9	56.0
9.446000	37.3	Off	N	19.8	22.7	60.0



Test Mode :	Mode 1	Temperature :	23~24°C
Test Engineer :	Kai-Chun Chu	Relative Humidity :	48~49%
Test Voltage :	120Vac / 60Hz	Phase :	Neutral
Function Type :	GSM850 Idle + Bluetooth Link + WLAN (5GHz) Link + MP3 + Earphone + USB Cable (Charging from Adapter)		

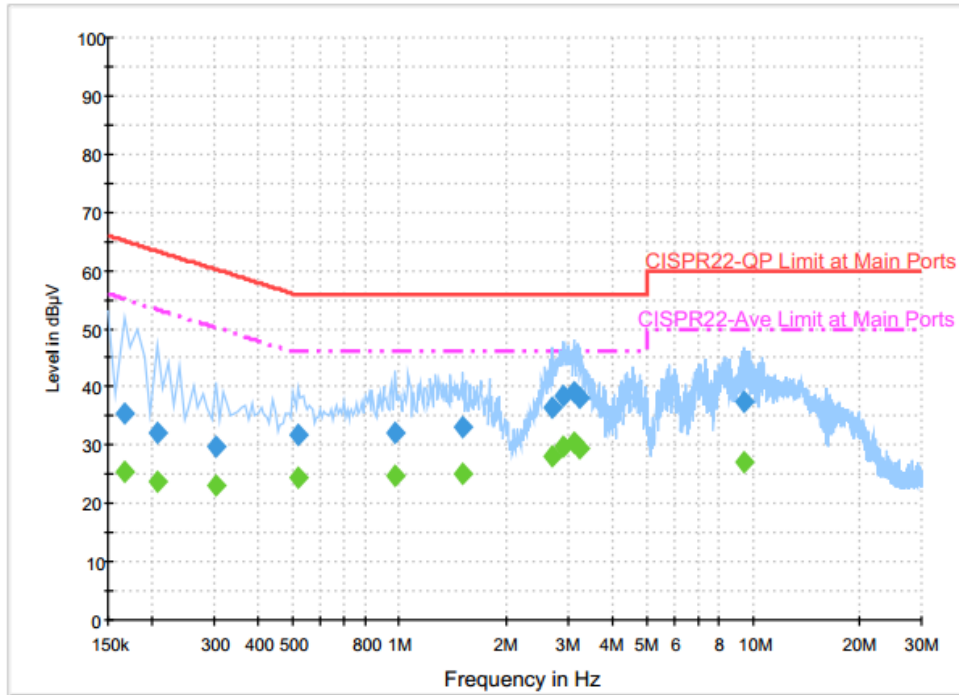

Final Result : Average

Frequency (MHz)	Average (dBµV)	Filter	Line	Corr. (dB)	Margin (dB)	Limit (dBµV)
0.166000	25.4	Off	N	19.6	29.8	55.2
0.206000	23.7	Off	N	19.7	29.7	53.4
0.302000	23.1	Off	N	19.6	27.1	50.2
0.518000	24.3	Off	N	19.6	21.7	46.0
0.974000	24.7	Off	N	19.6	21.3	46.0
1.510000	25.2	Off	N	19.6	20.8	46.0
2.702000	27.9	Off	N	19.4	18.1	46.0
2.910000	29.9	Off	N	19.5	16.1	46.0
3.110000	30.4	Off	N	19.6	15.6	46.0
3.246000	29.3	Off	N	19.6	16.7	46.0
9.446000	27.2	Off	N	19.8	22.8	50.0

3.6 Frequency Stability Measurement

3.6.1 Limit of Frequency Stability

Manufacturers of U-NII devices are responsible for ensuring frequency stability such that an emission is maintained within the band of operation under all conditions of normal operation as specified in the user's manual.

3.6.2 Measuring Instruments

The measuring equipment is listed in the section 4 of this test report.

3.6.3 Test Procedures

1. To ensure emission at the band edge is maintained within the authorized band, those values shall be measured by radiation emissions at upper and lower frequency points, and finally compensated by frequency deviation as procedures below.
2. The EUT was operated at the maximum output power, and connected to the spectrum analyzer, which is set to maximum hold function and peak detector. The peak value of the power envelope was measured and noted. The upper and lower frequency points were respectively measured relatively 10dB lower than the measured peak value.
3. The frequency deviation was calculated by adding the upper frequency point and the lower frequency point divided by two. Those detailed values of frequency deviation are provided in table below.

3.6.4 Test Setup

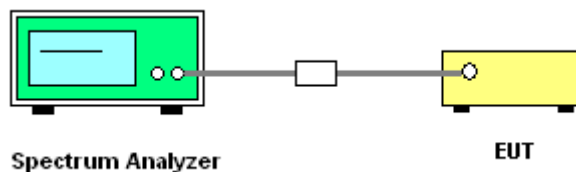

3.6.5 Test Result of Frequency Stability

Please refer to Appendix A.



3.7 Automatically Discontinue Transmission

3.7.1 Limit of Automatically Discontinue Transmission

The device shall automatically discontinue transmission in case of either absence of information to transmit or operational failure. These provisions are not intended to preclude the transmission of control or signaling information or the use of repetitive codes used by certain digital technologies to complete frame or burst intervals. Applicants shall include in their application for equipment authorization to describe how this requirement is met.

3.7.2 Measuring Instruments

The measuring equipment is listed in the section 4 of this test report.

3.7.3 Test Result of Automatically Discontinue Transmission

While the EUT is not transmitting any information, the EUT can automatically discontinue transmission and become standby mode for power saving. The EUT can detect the controlling signal of ACK message transmitting from remote device and verify whether it shall resend or discontinue transmission.



3.8 Antenna Requirements

3.8.1 Standard Applicable

According to FCC 47 CFR Section 15.407(a)(1)(2) ,if transmitting antenna directional gain is greater than 6 dBi, both the peak transmit power and the peak power spectral density shall be reduced by the amount in dB that the directional gain of the antenna exceeds 6 dBi.

3.8.2 Antenna Anti-Replacement Construction

An embedded-in antenna design is used.

3.8.3 Antenna Gain

The antenna gain is less than 6 dBi. Therefore, it is not necessary to reduce maximum peak output power limit.



4 List of Measuring Equipment

Instrument	Manufacturer	Model No.	Serial No.	Characteristics	Calibration Date	Test Date	Due Date	Remark
AC Power Source	AC POWER	AFC-500W	F104070011	50Hz~60Hz	Dec. 02, 2015	Feb. 15, 2016 ~ Mar. 05, 2016	Dec. 01, 2016	Conducted (TH02-HY)
Power Meter	Agilent	E4416A	GB41292344	300MHz~40GHz	Jan. 08, 2016	Feb. 15, 2016 ~ Mar. 05, 2016	Jan. 07, 2017	Conducted (TH02-HY)
Power Sensor	Agilent	E9327A	US40441548	300MHz~40GHz	Jan. 07, 2016	Feb. 15, 2016 ~ Mar. 05, 2016	Jan. 06, 2017	Conducted (TH02-HY)
Spectrum Analyzer	Rohde & Schwarz	FSP40	100055	9kHz~40GHz	Jun. 18, 2015	Feb. 15, 2016 ~ Mar. 05, 2016	Jun. 17, 2016	Conducted (TH02-HY)
Bilog Antenna	TESEQ	CBL 6111D	35419	30MHz to 1GHz	Jan. 13, 2016	Mar. 01, 2016 ~ Mar. 02, 2016	Jan. 12, 2017	Radiation (03CH07-HY)
Double Ridge Horn Antenna	ESCO	3117	00075962	1GHz ~ 18GHz	Aug. 21, 2015	Mar. 01, 2016 ~ Mar. 02, 2016	Aug. 20, 2016	Radiation (03CH07-HY)
Loop Antenna	Rohde & Schwarz	HFH2-Z2	100315	9 kHz~30 MHz	Sep. 02, 2015	Mar. 01, 2016 ~ Mar. 02, 2016	Sep. 01, 2016	Radiation (03CH07-HY)
Preamplifier	MITEQ	AMF-7D-0010 1800-30-10P	1590075	1GHz ~ 18GHz	Apr. 20, 2015	Mar. 01, 2016 ~ Mar. 02, 2016	Apr. 19, 2016	Radiation (03CH07-HY)
Preamplifier	COM-POWER	PA-103A	161241	10MHz-1000MHz	Mar. 12, 2015	Mar. 01, 2016 ~ Mar. 02, 2016	Mar. 11, 2016	Radiation (03CH07-HY)
Preamplifier	Agilent	8449B	3008A02362	1GHz~ 26.5GHz	Oct. 19, 2015	Mar. 01, 2016 ~ Mar. 02, 2016	Oct. 18, 2016	Radiation (03CH07-HY)
Spectrum Analyzer	Agilent	N9010A	MY53470118	10Hz~44GHz	Feb. 27, 2016	Mar. 01, 2016 ~ Mar. 02, 2016	Feb. 26, 2017	Radiation (03CH07-HY)
EMI Test Receiver	Agilent	N9038A(MXE)	MY53290053	20Hz ~ 26.5GHz	Jan. 20, 2016	Mar. 01, 2016 ~ Mar. 02, 2016	Jan. 19, 2017	Radiation (03CH07-HY)
Antenna Mast	Max-Full	MFA520BS	N/A	1m~4m	N/A	Mar. 01, 2016 ~ Mar. 02, 2016	N/A	Radiation (03CH07-HY)
Turn Table	ChainTek	Chaintek 3000	N/A	0~360 degree	N/A	Mar. 01, 2016 ~ Mar. 02, 2016	N/A	Radiation (03CH07-HY)
SHF-EHF Horn Antenna	SCHWARZBECK	BBHA 9170	BBHA9170251	18GHz- 40GHz	Oct. 12, 2015	Mar. 01, 2016 ~ Mar. 02, 2016	Oct. 11, 2016	Radiation (03CH07-HY)
Preamplifier	MITEQ	JS44-1800400 0-33-8P	1840917	18GHz ~ 40GHz	Jun. 02, 2015	Mar. 01, 2016 ~ Mar. 02, 2016	Jun. 01, 2016	Radiation (03CH07-HY)
EMI Test Receiver	Agilent Technologies	N9038A(MXE)	MY53290045	20MHz~8.4GHz	Feb. 01, 2016	Mar. 01, 2016 ~ Mar. 02, 2016	Jan. 31, 2017	Radiation (03CH07-HY)
AC Power Source	ChainTek	APC-1000W	N/A	N/A	N/A	Feb. 12, 2016	N/A	Conduction (CO05-HY)
EMI Test Receiver	Rohde & Schwarz	ESCI 7	100724	9kHz~7GHz	Aug. 26, 2015	Feb. 12, 2016	Aug. 25, 2016	Conduction (CO05-HY)
LISN	Rohde & Schwarz	ENV216	100080	9kHz~30MHz	Dec. 02, 2015	Feb. 12, 2016	Dec. 01, 2016	Conduction (CO05-HY)



5 Uncertainty of Evaluation

Uncertainty of Conducted Emission Measurement (150kHz ~ 30MHz)

Measuring Uncertainty for a Level of Confidence of 95% ($U = 2Uc(y)$)	2.26
---	------

Uncertainty of Radiated Emission Measurement (30 MHz ~ 1000 MHz)

Measuring Uncertainty for a Level of Confidence of 95% ($U = 2Uc(y)$)	4.80
---	------



Appendix A. Conducted Test Results

Test Engineer:	An Wu	Temperature:	23~24	°C
Test Date:	2016/02/15~2016/03/05	Relative Humidity:	52~53	%

TEST RESULTS DATA
6dB and 26dB EBW and 99% OBW

Band IV									
Mod.	Data Rate	NTX	CH.	Freq. (MHz)	99% Bandwidth (MHz)	26 dB Bandwidth (MHz)	6 dB Bandwidth (MHz)	6dB Bandwidth min. Limit (MHz)	Pass/Fail
11a	6M bps	1	149	5745	19.85	44.3	16.4	0.5	Pass
11a	6Mbps	1	157	5785	20.85	45.2	16.4	0.5	Pass
11a	6Mbps	1	165	5825	20.85	44.6	16.4	0.5	Pass
HT20	MCS 0	1	149	5745	20.1	47	17.6	0.5	Pass
HT20	MCS 0	1	157	5785	20.6	45.8	17.6	0.5	Pass
HT20	MCS 0	1	165	5825	19.85	47.7	17.6	0.5	Pass
HT40	MCS 0	1	151	5755	36.9	76	35.76	0.5	Pass
HT40	MCS 0	1	159	5795	37.1	85.4	35.2	0.5	Pass

TEST RESULTS DATA
Average Power Table

Band IV									
Mod.	Data Rate	NTX	CH.	Freq. (MHz)	Duty Factor (dB)	Average Conducted Power (dBm)	FCC Conducted Power Limit (dBm)	DG (dBi)	Pass/Fail
11a	6M bps	1	149	5745	0.59	16.64	30.00	0.00	Pass
11a	6Mbps	1	157	5785	0.59	17.47	30.00	0.00	Pass
11a	6Mbps	1	165	5825	0.59	16.94	30.00	0.00	Pass
HT20	MCS 0	1	149	5745	0.63	16.50	30.00	0.00	Pass
HT20	MCS 0	1	157	5785	0.63	16.68	30.00	0.00	Pass
HT20	MCS 0	1	165	5825	0.63	16.20	30.00	0.00	Pass
HT40	MCS 0	1	151	5755	1.25	14.42	30.00	0.00	Pass
HT40	MCS 0	1	159	5795	1.25	16.50	30.00	0.00	Pass

TEST RESULTS DATA
Power Spectral Density

Band IV										
Mod.	Data Rate	NTX	CH.	Freq. (MHz)	Duty Factor (dB)	10log (500kHz /RBW) Factor (dB)	Average Power Density (dBm/500kHz)	Average PSD Limit (dBm/500kHz)	DG (dBi)	Pass/Fail
11a	6M bps	1	149	5745	0.59	2.22	0.98	30.00	0.00	Pass
11a	6Mbps	1	157	5785	0.59	2.22	1.43	30.00	0.00	Pass
11a	6Mbps	1	165	5825	0.59	2.22	1.03	30.00	0.00	Pass
HT20	MCS 0	1	149	5745	0.63	2.22	0.35	30.00	0.00	Pass
HT20	MCS 0	1	157	5785	0.63	2.22	0.43	30.00	0.00	Pass
HT20	MCS 0	1	165	5825	0.63	2.22	-0.16	30.00	0.00	Pass
HT40	MCS 0	1	151	5755	1.25	2.22	-4.54	30.00	0.00	Pass
HT40	MCS 0	1	159	5795	1.25	2.22	-2.56	30.00	0.00	Pass

TEST RESULTS DATA
Frequency Stability

Band IV										
Mod.	Data Rate	NTX	CH.	Freq. (MHz)	Center Frequency (MHz)	Frequency Deviation (MHz)	Frequency Stability (ppm)	Temperature (°C)	Voltage (V)	Note
11a	6M bps	1	149	5745	5745.125	0.125	21.76	20	3.2	
11a	6M bps	1	149	5745	5745.100	0.100	17.41	20	4.35	
11a	6M bps	1	149	5745	5745.100	0.100	17.41	20	3.8	
11a	6M bps	1	149	5745	5745.125	0.125	21.76	-30	3.8	
11a	6M bps	1	149	5745	5745.075	0.075	13.05	50	3.8	



Appendix B. Radiated Spurious Emission

Test Engineer :	James Chiu and Jesse Wang and Ken Wu	Temperature :	21~24°C
		Relative Humidity :	50~54%

Band 4 - 5725~5850MHz

WIFI 802.11a (Band Edge @ 3m)

WIFI Ant. 1	Note	Frequency (MHz)	Level (dBμV/m)	Over Limit (dB)	Limit Line (dBμV/m)	Read Level (dBμV)	Antenna Factor (dB/m)	Cable Loss (dB)	Preamp Factor (dB)	Ant Pos (cm)	Table Pos (deg)	Peak Avg. (P/A)	Pol. (H/V)	
802.11a CH 149 5745MHz		5714.28	61.63	-6.67	68.3	49.63	35.22	12.06	35.28	186	66	P	H	
		5724.92	75.4	-2.9	78.3	63.39	35.23	12.06	35.28	186	66	P	H	
	*	5745	111.6	-	-	99.54	35.24	12.11	35.29	186	66	P	H	
	*	5745	102.8	-	-	90.74	35.24	12.11	35.29	186	66	A	H	
													H	
													H	
													H	
													H	
			5710.44	60.27	-8.03	68.3	48.27	35.22	12.06	35.28	200	78	P	V
			5723.4	72.48	-5.82	78.3	60.47	35.23	12.06	35.28	200	78	P	V
	*		5745	108.51	-	-	96.45	35.24	12.11	35.29	200	78	P	V
	*		5745	99.43	-	-	87.37	35.24	12.11	35.29	200	78	A	V
													V	
													V	
													V	
													V	



WIFI Ant. 1	Note	Frequency (MHz)	Level (dBμV/m)	Over Limit (dB)	Limit Line (dBμV/m)	Read Level (dBμV)	Antenna Factor (dB/m)	Cable Loss (dB)	Preamp Factor (dB)	Ant Pos (cm)	Table Pos (deg)	Peak Avg. (P/A)	Pol. (H/V)	
802.11a CH 157 5785MHz		5694.36	51.04	-17.26	68.3	39.11	35.21	12	35.28	186	67	P	H	
		5721.64	53.73	-24.57	78.3	41.72	35.23	12.06	35.28	186	67	P	H	
	*	5785	112.56	-	-	100.42	35.27	12.17	35.3	186	67	P	H	
	*	5785	103.59	-	-	91.45	35.27	12.17	35.3	186	67	A	H	
		5851.28	52.79	-25.51	78.3	40.51	35.31	12.28	35.31	186	67	P	H	
		5867.6	51.47	-16.83	68.3	39.08	35.32	12.39	35.32	186	67	P	H	
														H
														H
			5690.68	49.77	-18.53	68.3	37.84	35.21	12	35.28	205	85	P	V
			5718.36	50.52	-27.78	78.3	38.51	35.23	12.06	35.28	205	85	P	V
	*		5785	108.44	-	-	96.3	35.27	12.17	35.3	205	85	P	V
	*		5785	99.77	-	-	87.63	35.27	12.17	35.3	205	85	A	V
			5852.56	49.51	-28.79	78.3	37.23	35.31	12.28	35.31	205	85	P	V
			5880.16	50.7	-17.6	68.3	38.3	35.33	12.39	35.32	205	85	P	V
														V
														V



WIFI Ant. 1	Note	Frequency (MHz)	Level (dBμV/m)	Over Limit (dB)	Limit Line (dBμV/m)	Read Level (dBμV)	Antenna Factor (dB/m)	Cable Loss (dB)	Preamp Factor (dB)	Ant Pos (cm)	Table Pos (deg)	Peak Avg. (P/A)	Pol. (H/V)
802.11a CH 165 5825MHz	*	5825	113.25	-	-	100.98	35.3	12.28	35.31	193	65	P	H
	*	5825	103.79	-	-	91.52	35.3	12.28	35.31	193	65	A	H
		5851.92	71.14	-7.16	78.3	58.86	35.31	12.28	35.31	193	65	P	H
		5860.16	63.96	-4.34	68.3	51.57	35.32	12.39	35.32	193	65	P	H
													H
													H
													H
													H
	*	5825	108.68	-	-	96.41	35.3	12.28	35.31	200	85	P	V
	*	5825	99.93	-	-	87.66	35.3	12.28	35.31	200	85	A	V
		5852.96	67.98	-10.32	78.3	55.7	35.31	12.28	35.31	200	85	P	V
		5864.8	60.01	-8.29	68.3	47.62	35.32	12.39	35.32	200	85	P	V
													V
													V
													V
													V
												V	
Remark	1. No other spurious found. 2. All results are PASS against Peak and Average limit line.												



Band 4 5725~5850MHz
WIFI 802.11a (Harmonic @ 3m)

WIFI Ant. 1	Note	Frequency (MHz)	Level (dBμV/m)	Over Limit (dB)	Limit Line (dBμV/m)	Read Level (dBμV)	Antenna Factor (dB/m)	Cable Loss (dB)	Preamp Factor (dB)	Ant Pos (cm)	Table Pos (deg)	Peak Avg. (P/A)	Pol. (H/V)
802.11a CH 149 5745MHz		11490	43.24	-30.76	74	45.73	38.19	17.16	57.84	100	0	P	H
		17235	47.51	-20.79	68.3	41.08	42.21	20.76	56.54	100	0	P	H
													H
													H
		11490	42.37	-31.63	74	44.86	38.19	17.16	57.84	100	0	P	V
		17235	45.97	-22.33	68.3	39.54	42.21	20.76	56.54	100	0	P	V
													V
													V
802.11a CH 157 5785MHz		11570	42.48	-31.52	74	44.71	38.3	17.16	57.69	100	0	P	H
		17355	45.76	-22.54	68.3	39.41	42.12	20.84	56.61	100	0	P	H
													H
													H
		11570	42.34	-31.66	74	44.57	38.3	17.16	57.69	100	0	P	V
		17355	46.4	-21.9	68.3	40.05	42.12	20.84	56.61	100	0	P	V
													V
													V
802.11a CH 165 5825MHz		11650	42.31	-31.69	74	44.34	38.39	17.16	57.58	100	0	P	H
		17475	47.76	-20.54	68.3	41.48	42.03	20.93	56.68	100	0	P	H
													H
													H
		11650	42.55	-31.45	74	44.58	38.39	17.16	57.58	100	0	P	V
		17475	47.1	-21.2	68.3	40.82	42.03	20.93	56.68	100	0	P	V
													V
													V
Remark	1. No other spurious found. 2. All results are PASS against Peak and Average limit line.												



WIFI Ant. 1	Note	Frequency (MHz)	Level (dBµV/m)	Over Limit (dB)	Limit Line (dBµV/m)	Read Level (dBµV)	Antenna Factor (dB/m)	Cable Loss (dB)	Preamp Factor (dB)	Ant Pos (cm)	Table Pos (deg)	Peak Avg. (P/A)	Pol. (H/V)	
802.11n HT20 CH 157 5785MHz		5712.28	49.93	-18.37	68.3	37.93	35.22	12.06	35.28	187	66	P	H	
		5721.32	52.44	-25.86	78.3	40.43	35.23	12.06	35.28	187	66	P	H	
	*	5785	110.22	-	-	98.08	35.27	12.17	35.3	187	66	P	H	
	*	5785	102.57	-	-	90.43	35.27	12.17	35.3	187	66	A	H	
		5850.56	53.7	-24.6	78.3	41.42	35.31	12.28	35.31	187	66	P	H	
		5861.44	50.3	-18	68.3	37.91	35.32	12.39	35.32	187	66	P	H	
														H
														H
			5694.92	50.23	-18.07	68.3	38.3	35.21	12	35.28	200	85	P	V
			5718.04	50.57	-27.73	78.3	38.56	35.23	12.06	35.28	200	85	P	V
	*		5785	106.36	-	-	94.22	35.27	12.17	35.3	200	85	P	V
	*		5785	98.87	-	-	86.73	35.27	12.17	35.3	200	85	A	V
			5851.84	51.31	-26.99	78.3	39.03	35.31	12.28	35.31	200	85	P	V
			5885.36	51.15	-17.15	68.3	38.75	35.33	12.39	35.32	200	85	P	V
														V
													V	



WIFI Ant. 1	Note	Frequency (MHz)	Level (dBμV/m)	Over Limit (dB)	Limit Line (dBμV/m)	Read Level (dBμV)	Antenna Factor (dB/m)	Cable Loss (dB)	Preamp Factor (dB)	Ant Pos (cm)	Table Pos (deg)	Peak Avg. (P/A)	Pol. (H/V)
802.11n HT20 CH 165 5825MHz	*	5825	110.11	-	-	97.84	35.3	12.28	35.31	200	64	P	H
	*	5825	102.31	-	-	90.04	35.3	12.28	35.31	200	64	A	H
		5850	69.55	-8.75	78.3	57.27	35.31	12.28	35.31	200	64	P	H
		5861.76	63.12	-5.18	68.3	50.73	35.32	12.39	35.32	200	64	P	H
													H
													H
													H
													H
	*	5825	106.51	-	-	94.24	35.3	12.28	35.31	200	86	P	V
	*	5825	98.99	-	-	86.72	35.3	12.28	35.31	200	86	A	V
		5850	67.57	-10.73	78.3	55.29	35.31	12.28	35.31	200	86	P	V
		5860.96	61.24	-7.06	68.3	48.85	35.32	12.39	35.32	200	86	P	V
													V
													V
													V
													V
Remark	1. No other spurious found. 2. All results are PASS against Peak and Average limit line.												



Band 4 5725~5850MHz
WIFI 802.11n HT20 (Harmonic @ 3m)

WIFI Ant. 1	Note	Frequency (MHz)	Level (dBμV/m)	Over Limit (dB)	Limit Line (dBμV/m)	Read Level (dBμV)	Antenna Factor (dB/m)	Cable Loss (dB)	Preamp Factor (dB)	Ant Pos (cm)	Table Pos (deg)	Peak Avg. (P/A)	Pol. (H/V)
802.11n HT20 CH 149 5745MHz		11490	42.76	-31.24	74	45.25	38.19	17.16	57.84	100	0	P	H
		17235	45.97	-22.33	68.3	39.54	42.21	20.76	56.54	100	0	P	H
													H
													H
		11490	42.94	-31.06	74	45.43	38.19	17.16	57.84	100	0	P	V
		17235	47.35	-20.95	68.3	40.92	42.21	20.76	56.54	100	0	P	V
802.11n HT20 CH 157 5785MHz		11570	42.46	-31.54	74	44.69	38.3	17.16	57.69	100	0	P	H
		17355	45.68	-22.62	68.3	39.33	42.12	20.84	56.61	100	0	P	H
													H
													H
		11570	42.43	-31.57	74	44.66	38.3	17.16	57.69	100	0	P	V
		17355	46.9	-21.4	68.3	40.55	42.12	20.84	56.61	100	0	P	V
802.11n HT20 CH 165 5825MHz		11650	43.09	-30.91	74	45.12	38.39	17.16	57.58	100	0	P	H
		17475	46.73	-21.57	68.3	40.45	42.03	20.93	56.68	100	0	P	H
													H
													H
		11650	44.2	-29.8	74	46.23	38.39	17.16	57.58	100	0	P	V
		17475	46.79	-21.51	68.3	40.51	42.03	20.93	56.68	100	0	P	V
Remark	1. No other spurious found.												
	2. All results are PASS against Peak and Average limit line.												



Band 4 5725~5850MHz
WIFI 802.11n HT40 (Band Edge @ 3m)

WIFI Ant. 1	Note	Frequency (MHz)	Level (dBμV/m)	Over Limit (dB)	Limit Line (dBμV/m)	Read Level (dBμV)	Antenna Factor (dB/m)	Cable Loss (dB)	Preamp Factor (dB)	Ant Pos (cm)	Table Pos (deg)	Peak Avg. (P/A)	Pol. (H/V)	
802.11n HT40 CH 151 5755MHz		5713.32	65.17	-3.13	68.3	53.17	35.22	12.06	35.28	200	66	P	H	
		5721.24	72.28	-6.02	78.3	60.27	35.23	12.06	35.28	200	66	P	H	
	*	5755	104.51	-	-	92.43	35.26	12.11	35.29	200	66	P	H	
	*	5755	97.62	-	-	85.54	35.26	12.11	35.29	200	66	A	H	
		5857.84	51.36	-26.94	78.3	39.08	35.32	12.28	35.32	200	66	P	H	
		5862.32	51	-17.3	68.3	38.61	35.32	12.39	35.32	200	66	P	H	
														H
														H
			5714.92	65.11	-3.19	68.3	53.11	35.22	12.06	35.28	200	79	P	V
			5724.52	72.83	-5.47	78.3	60.82	35.23	12.06	35.28	200	79	P	V
	*		5755	101.33	-	-	89.25	35.26	12.11	35.29	200	79	P	V
	*		5755	94.02	-	-	81.94	35.26	12.11	35.29	200	79	A	V
			5857.92	49.47	-28.83	78.3	37.19	35.32	12.28	35.32	200	79	P	V
			5866.24	51.04	-17.26	68.3	38.65	35.32	12.39	35.32	200	79	P	V
														V
														V



WIFI Ant. 1	Note	Frequency (MHz)	Level (dBµV/m)	Over Limit (dB)	Limit Line (dBµV/m)	Read Level (dBµV)	Antenna Factor (dB/m)	Cable Loss (dB)	Preamp Factor (dB)	Ant Pos (cm)	Table Pos (deg)	Peak Avg. (P/A)	Pol. (H/V)	
802.11n HT40 CH 159 5795MHz		5713.72	53.8	-14.5	68.3	41.8	35.22	12.06	35.28	200	65	P	H	
		5720.44	58.42	-19.88	78.3	46.41	35.23	12.06	35.28	200	65	P	H	
	*	5795	106.33	-	-	94.18	35.28	12.17	35.3	200	65	P	H	
	*	5795	99.04	-	-	86.89	35.28	12.17	35.3	200	65	A	H	
		5851.68	61.42	-16.88	78.3	49.14	35.31	12.28	35.31	200	65	P	H	
		5863.04	58.35	-9.95	68.3	45.96	35.32	12.39	35.32	200	65	P	H	
														H
														H
			5691.08	51.38	-16.92	68.3	39.45	35.21	12	35.28	200	86	P	V
			5723.64	54.29	-24.01	78.3	42.28	35.23	12.06	35.28	200	86	P	V
	*		5795	104.12	-	-	91.97	35.28	12.17	35.3	200	86	P	V
	*		5795	95.81	-	-	83.66	35.28	12.17	35.3	200	86	A	V
			5851.6	58.73	-19.57	78.3	46.45	35.31	12.28	35.31	200	86	P	V
			5872.96	57.96	-10.34	68.3	45.56	35.33	12.39	35.32	200	86	P	V
														V
													V	
Remark	1. No other spurious found. 2. All results are PASS against Peak and Average limit line.													



Band 4 5725~5850MHz
WIFI 802.11n HT40 (Harmonic @ 3m)

WIFI Ant. 1	Note	Frequency (MHz)	Level (dBμV/m)	Over Limit (dB)	Limit Line (dBμV/m)	Read Level (dBμV)	Antenna Factor (dB/m)	Cable Loss (dB)	Preamp Factor (dB)	Ant Pos (cm)	Table Pos (deg)	Peak Avg. (P/A)	Pol. (H/V)
802.11n HT40 CH 151 5755MHz		11510	42.58	-31.42	74	45.02	38.2	17.16	57.8	100	0	P	H
		17265	46.09	-22.21	68.3	39.67	42.19	20.79	56.56	100	0	P	H
													H
													H
		11510	42.26	-31.74	74	44.7	38.2	17.16	57.8	100	0	P	V
		17265	45.95	-22.35	68.3	39.53	42.19	20.79	56.56	100	0	P	V
													V
													V
802.11n HT40 CH 159 5795MHz		11590	42.83	-31.17	74	45.01	38.32	17.16	57.66	100	0	P	H
		17385	46.04	-22.26	68.3	39.71	42.09	20.87	56.63	100	0	P	H
													H
													H
		11590	43.07	-30.93	74	45.25	38.32	17.16	57.66	100	0	P	V
		17385	46.74	-21.56	68.3	40.41	42.09	20.87	56.63	100	0	P	V
													V
													V
Remark	1. No other spurious found. 2. All results are PASS against Peak and Average limit line.												



Emission below 1GHz

5GHz WIFI 802.11n HT20 (LF @ 3m)

WIFI	Note	Frequency	Level	Over	Limit	Read	Antenna	Cable	Preamp	Ant	Table	Peak	Pol.	
Ant.				Limit	Line	Level	Factor	Loss	Factor	Pos	Pos	Avg.		
1		(MHz)	(dBμV/m)	(dB)	(dBμV/m)	(dBμV)	(dB/m)	(dB)	(dB)	(cm)	(deg)	(P/A)	(H/V)	
5GHz 802.11n HT20 LF		30	27.53	-12.47	40	31.96	26	1.07	31.5			P	H	
		196.05	36.28	-7.22	43.5	49.71	15.8	1.87	31.1	100	0	P	H	
		216.57	31.14	-14.86	46	43.95	16.36	1.87	31.04			P	H	
		875.4	32.62	-13.38	46	29.94	28.86	4.17	30.35			P	H	
		913.9	33.37	-12.63	46	30.25	29.33	4.12	30.33			P	H	
		950.3	33.32	-12.68	46	29.45	30.2	4.07	30.4			P	H	
														H
														H
														H
														H
														H
														H
														H
														H
														H
			52.68	32.51	-7.49	40	48.16	14.48	1.07	31.2	100	0	P	V
			99.93	32.14	-11.36	43.5	45.56	16.4	1.28	31.1			P	V
			244.11	29.93	-16.07	46	40.41	18.45	2.07	31			P	V
			834.8	32.96	-13.04	46	30.82	28.41	4.1	30.37			P	V
			930	33.52	-12.48	46	30.03	29.73	4.12	30.36			P	V
		952.4	33.72	-12.28	46	29.83	30.21	4.07	30.39			P	V	
													V	
													V	
													V	
													V	
													V	
													V	
Remark	1. No other spurious found. 2. All results are PASS against limit line.													



Note symbol

*	Fundamental Frequency which can be ignored. However, the level of any unwanted emissions shall not exceed the level of the fundamental frequency.
!	Test result is over limit line.
P/A	Peak or Average
H/V	Horizontal or Vertical



A calculation example for radiated spurious emission is shown as below:

WIFI	Note	Frequency	Level	Over	Limit	Read	Antenna	Cable	Preamp	Ant	Table	Peak	Pol.
Ant.				Limit	Line	Level	Factor	Loss	Factor	Pos	Pos	Avg.	
1		(MHz)	(dBμV/m)	(dB)	(dBμV/m)	(dBμV)	(dB/m)	(dB)	(dB)	(cm)	(deg)	(P/A)	(H/V)
802.11b		2390	55.45	-18.55	74	54.51	32.22	4.58	35.86	103	308	P	H
CH 01													
2412MHz		2390	43.54	-10.46	54	42.6	32.22	4.58	35.86	103	308	A	H

- Level(dBμV/m) =
Antenna Factor(dB/m) + Cable Loss(dB) + Read Level(dBμV) - Preamp Factor(dB)
- Over Limit(dB) = Level(dBμV/m) – Limit Line(dBμV/m)

For Peak Limit @ 2390MHz:

- Level(dBμV/m)
= Antenna Factor(dB/m) + Cable Loss(dB) + Read Level(dBμV) - Preamp Factor(dB)
= 32.22(dB/m) + 4.58(dB) + 54.51(dBμV) – 35.86 (dB)
= 55.45 (dBμV/m)
- Over Limit(dB)
= Level(dBμV/m) – Limit Line(dBμV/m)
= 55.45(dBμV/m) – 74(dBμV/m)
= -18.55(dB)

For Average Limit @ 2390MHz:

- Level(dBμV/m)
= Antenna Factor(dB/m) + Cable Loss(dB) + Read Level(dBμV) - Preamp Factor(dB)
= 32.22(dB/m) + 4.58(dB) + 42.6(dBμV) – 35.86 (dB)
= 43.54 (dBμV/m)
- Over Limit(dB)
= Level(dBμV/m) – Limit Line(dBμV/m)
= 43.54(dBμV/m) – 54(dBμV/m)
= -10.46(dB)

Both peak and average measured complies with the limit line, so test result is “PASS”.



Appendix C. Radiated Spurious Emission Plots

Test Engineer :	James Chiu and Jesse Wang and Ken Wu	Temperature :	21~24°C
		Relative Humidity :	50~54%

Band 4 - 5725~5850MHz
WIFI 802.11a (Band Edge @ 3m)

WIFI	Band 4 5725~5850MHz Band Edge @ 3m	
ANT	802.11a CH149 5745MHz	
1	Horizontal	Vertical
Peak	<p>Site : 03CH07-HY Condition : FCC PART 15E, BAND4 3m HF-ANT, 130029 HORIZONTAL RBW: 1000.000kHz VBW:3000.000kHz SVWT:Auto Detector : Peak</p>	<p>Site : 03CH07-HY Condition : FCC PART 15E, BAND4 3m HF-ANT, 130029 VERTICAL RBW: 1000.000kHz VBW:3000.000kHz SVWT:Auto Detector : Peak</p>



WIFI	Band 4 5725~5850MHz Band Edge @ 3m	
ANT	802.11a CH157 5785MHz - L	
1	Horizontal	Vertical
Peak	<p>Site : 03CH07-HY Condition : FCC PART 15E_BAND4 3m HF-ANT_130829 HORIZONTAL RBW:1000.000KHz VBW:3000.000KHz SVWT:Auto Detector : Peak</p>	<p>Site : 03CH07-HY Condition : FCC PART 15E_BAND4 3m HF-ANT_130829 VERTICAL RBW:1000.000KHz VBW:3000.000KHz SVWT:Auto Detector : Peak</p>



WIFI	Band 4 5725~5850MHz Band Edge @ 3m	
ANT	802.11a CH157 5785MHz - R	
1	Horizontal	Vertical
Peak	<p>Site : 03CH07-HY Condition : FCC PART 15E_BAND4 3m HF-ANT_130829 HORIZONTAL RBW: 1000.0000Hz VIEW:3000.0000Hz SVWT:Auto Detector : Peak</p>	<p>Site : 03CH07-HY Condition : FCC PART 15E_BAND4 3m HF-ANT_130829 VERTICAL RBW: 1000.0000Hz VIEW:3000.0000Hz SVWT:Auto Detector : Peak</p>



WIFI	Band 4 5725~5850MHz Band Edge @ 3m	
ANT	802.11a CH165 5825MHz	
1	Horizontal	Vertical
Peak	<p>Site : 03CH07-HY Condition : FCC PART 15E_BAND4 3m HF-ANT_130829 HORIZONTAL RBW: 1000.000kHz VBW: 3000.000kHz SVWT: Auto Detector : Peak</p>	<p>Site : 03CH07-HY Condition : FCC PART 15E_BAND4 3m HF-ANT_130829 VERTICAL RBW: 1000.000kHz VBW: 3000.000kHz SVWT: Auto Detector : Peak</p>



Band 4 5725~5850MHz
WIFI 802.11n HT20 (Band Edge @ 3m)

Table with 3 columns: WIFI, ANT, and test results for Horizontal and Vertical orientations. Includes spectral plots and technical details like Site, Condition, and Detector.



WIFI	Band 4 5725~5850MHz Band Edge @ 3m	
ANT	802.11n HT20 CH157 5785MHz - L	
1	Horizontal	Vertical
<p>Peak</p>	<p>Site : 03CH07-HY Condition : FCC PART 15E_BAND4 3m HF-ANT_130829 HORIZONTAL RBW: 1000.000kHz VBW:3000.000kHz SVWT:Auto Detector : Peak</p>	<p>Site : 03CH07-HY Condition : FCC PART 15E_BAND4 3m HF-ANT_130829 VERTICAL RBW: 1000.000kHz VBW:3000.000kHz SVWT:Auto Detector : Peak</p>

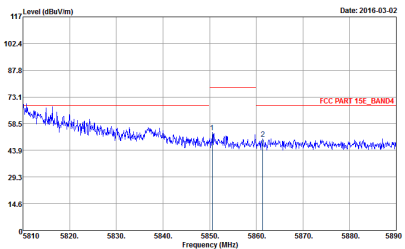
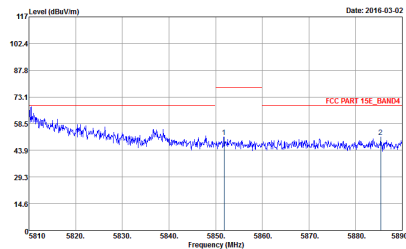

WIFI	Band 4 5725~5850MHz Band Edge @ 3m	
ANT	802.11n HT20 CH157 5785MHz - R	
1	Horizontal	Vertical
Peak	 <p data-bbox="351 896 758 952"> Site : 03CH07-HY Condition : FCC PART 15E_BAND4 3m HF-ANT_130829 HORIZONTAL Detector : Peak </p>	 <p data-bbox="941 896 1348 952"> Site : 03CH07-HY Condition : FCC PART 15E_BAND4 3m HF-ANT_130829 VERTICAL Detector : Peak </p>



WIFI	Band 4 5725~5850MHz Band Edge @ 3m	
ANT	802.11n HT20 CH165 5825MHz	
1	Horizontal	Vertical
Peak	<p>Site : 03CH07-HY Condition : FCC PART 15E_BAND4 3m HF-ANT_130829 HORIZONTAL RBW: 1000.000KHz VBW:3000.000KHz SVWT:Auto Detector : Peak</p>	<p>Site : 03CH07-HY Condition : FCC PART 15E_BAND4 3m HF-ANT_130829 VERTICAL RBW: 1000.000KHz VBW:3000.000KHz SVWT:Auto Detector : Peak</p>



Band 4 5725~5850MHz
WIFI 802.11n HT40 (Band Edge @ 3m)

WIFI	Band 4 5725~5850MHz Band Edge @ 3m	
ANT	802.11n HT40 CH151 5755MHz - L	
1	Horizontal	Vertical
Peak	<p>Site : 00CH07-41Y Condition : FCC PART 15E_BAND4 3m HF-ANT_130829 HORIZONTAL RBW: 1000.000kHz VBW: 3000.000kHz SWT: Auto Detector : Peak</p>	<p>Site : 00CH07-41Y Condition : FCC PART 15E_BAND4 3m HF-ANT_130829 VERTICAL RBW: 1000.000kHz VBW: 3000.000kHz SWT: Auto Detector : Peak</p>

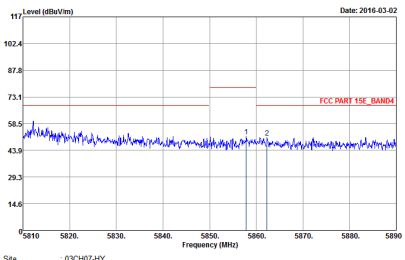
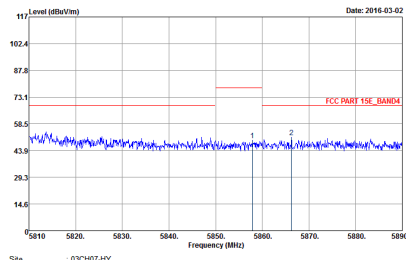

WIFI	Band 4 5725~5850MHz Band Edge @ 3m	
ANT	802.11n HT40 CH151 5755MHz - R	
1	Horizontal	Vertical
Peak	 <p>Date: 2016-03-02</p> <p>Site : 03CH07-HY Condition : FCC PART 15E_BAND4 3m HF-ANT_130829 HORIZONTAL RBW: 1000.000kHz VIEW:3000.000Hz SWT:Auto Detector : Peak</p>	 <p>Date: 2016-03-02</p> <p>Site : 03CH07-HY Condition : FCC PART 15E_BAND4 3m HF-ANT_130829 VERTICAL RBW: 1000.000kHz VIEW:3000.000Hz SWT:Auto Detector : Peak</p>

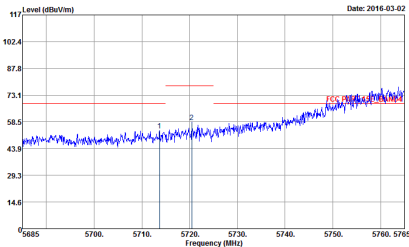
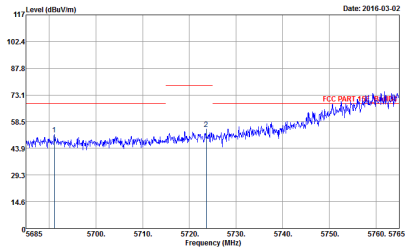

WIFI	Band 4 5725~5850MHz Band Edge @ 3m	
ANT	802.11n HT40 CH159 5795MHz - L	
1	Horizontal	Vertical
Peak	 <p>Date: 2016-03-02</p> <p>Site : 03CH07-HY Condition : FCC PART 15E_BAND4 3m HF-ANT_130829 HORIZONTAL RBW: 1000.000kHz VBW:3000.000kHz SVWT:Auto Detector : Peak</p>	 <p>Date: 2016-03-02</p> <p>Site : 03CH07-HY Condition : FCC PART 15E_BAND4 3m HF-ANT_130829 VERTICAL RBW: 1000.000kHz VBW:3000.000kHz SVWT:Auto Detector : Peak</p>



WIFI	Band 4 5725~5850MHz Band Edge @ 3m	
ANT	802.11n HT40 CH159 5795MHz - R	
1	Horizontal	Vertical
Peak	<p>Date: 2016-03-02</p> <p>Site : 03CH07-HY Condition : FCC PART 15E_BAND4 3m HF-ANT_130829 HORIZONTAL RBW: 1000.000kHz VIEW:3000.000Hz SWT:Auto Detector : Peak</p>	<p>Date: 2016-03-02</p> <p>Site : 03CH07-HY Condition : FCC PART 15E_BAND4 3m HF-ANT_130829 VERTICAL RBW: 1000.000kHz VIEW:3000.000Hz SWT:Auto Detector : Peak</p>



Band 4 - 5725~5850MHz
WIFI 802.11a (Harmonic @ 3m)

WIFI	Band 4 5725~5850MHz Harmonic @ 3m	
ANT	802.11a CH149 5745MHz	
1	Horizontal	Vertical
Peak Avg.	<p>Site : 62CH07-HY Condition : FCC PART 15E_BAND4 3m SHF-EHF_131029 HORIZONTAL Detector : Peak</p>	<p>Site : 62CH07-HY Condition : FCC PART 15E_BAND4 3m SHF-EHF_131029 VERTICAL Detector : Peak</p>



WIFI	Band 4 5725-5850MHz Harmonic @ 3m	
ANT	802.11a CH157 5785MHz	
1	Horizontal	Vertical
Peak Avg.	<p>Site : 03CH07-HY Condition : FCC PART 15E_BAND4 3m SHF-EHF_131029 HORIZONTAL Detector : Peak</p>	<p>Site : 03CH07-HY Condition : FCC PART 15E_BAND4 3m SHF-EHF_131029 VERTICAL Detector : Peak</p>



WIFI	Band 4 5725-5850MHz Harmonic @ 3m	
ANT	802.11a CH165 5825MHz	
1	Horizontal	Vertical
Peak Avg.	<p>Site : 03CH07-HY Condition : FCC PART 15E_BAND4 3m SHF-EHF_131029 HORIZONTAL Detector : Peak</p>	<p>Site : 03CH07-HY Condition : FCC PART 15E_BAND4 3m SHF-EHF_131029 VERTICAL Detector : Peak</p>



Band 4 5725~5850MHz
WIFI 802.11n HT20 (Harmonic @ 3m)

WIFI	Band 4 5725~5850MHz Harmonic @ 3m	
ANT	802.11n HT20 CH149 5745MHz	
1	Horizontal	Vertical
Peak Avg.	<p>Site : 03CH07-HY Condition : FCC PART 15E_BAND4 3m SHF-EHF_131029 HORIZONTAL Detector : Peak</p>	<p>Site : 03CH07-HY Condition : FCC PART 15E_BAND4 3m SHF-EHF_131029 VERTICAL Detector : Peak</p>



WIFI	Band 4 5725-5850MHz Harmonic @ 3m	
ANT	802.11n HT20 CH157 5785MHz	
1	Horizontal	Vertical
Peak Avg.	<p>Site : 03CH07-HY Condition : FCC PART 15E_BAND4 3m SHF-EHF_131029 HORIZONTAL Detector : Peak</p>	<p>Site : 03CH07-HY Condition : FCC PART 15E_BAND4 3m SHF-EHF_131029 VERTICAL Detector : Peak</p>



WIFI	Band 4 5725-5850MHz Harmonic @ 3m	
ANT	802.11n HT20 CH165 5825MHz	
1	Horizontal	Vertical
Peak Avg.	<p>Site : 63CH07-HY Condition : FCC PART 15E_BAND4 3m SHF-EHF_131029 HORIZONTAL Detector : Peak</p>	<p>Site : 63CH07-HY Condition : FCC PART 15E_BAND4 3m SHF-EHF_131029 VERTICAL Detector : Peak</p>



Band 4 5725~5850MHz
WIFI 802.11n HT40 (Harmonic @ 3m)

WIFI	Band 4 5725~5850MHz Harmonic @ 3m	
ANT	802.11n HT40 CH151 5755MHz	
1	Horizontal	Vertical
Peak Avg.	<p>Site : 03CH07-HY Condition : FCC PART 15E_BAND4 3m SHF-EHF_131029 HORIZONTAL Detector : Peak</p>	<p>Site : 03CH07-HY Condition : FCC PART 15E_BAND4 3m SHF-EHF_131029 VERTICAL Detector : Peak</p>



WIFI	Band 4 5725-5850MHz Harmonic @ 3m	
ANT	802.11n HT40 CH159 5795MHz	
1	Horizontal	Vertical
Peak Avg.	<p>Site : 03CH07-HY Condition : FCC PART 15E_BAND4 3m SHF-EHF_131029 HORIZONTAL Detector : Peak</p>	<p>Site : 03CH07-HY Condition : FCC PART 15E_BAND4 3m SHF-EHF_131029 VERTICAL Detector : Peak</p>



**Emission below 1GHz
5GHz WIFI 802.11n HT20 (LF)**

WIFI	5GHz 5725~5850MHz	
ANT	802.11n HT20 LF	
1	Horizontal	Vertical
QP / Peak	<p>Site : 63CH07-HY Condition : FCC CLASS B 3m LF-ANT:35419(6) HORIZONTAL Detector : Peak</p>	<p>Site : 63CH07-HY Condition : FCC CLASS B 3m LF-ANT:35419(6) VERTICAL Detector : Peak</p>