



# FCC RF Test Report

**APPLICANT** : Motorola Mobility, LLC  
**EQUIPMENT** : Mobile Cellular Phone  
**BRAND NAME** : Motorola  
**MODEL NAME** : 7050  
**FCC ID** : IHDT56VA1  
**STANDARD** : FCC Part 15 Subpart C §15.247  
**CLASSIFICATION** : (DSS) Spread Spectrum Transmitter

This is a variant report which is only valid together with the original test report. The product was received on Feb. 03, 2016. We, SPORTON INTERNATIONAL INC., would like to declare that the tested sample has been evaluated in accordance with the test procedures and has been in compliance with the applicable technical standards.

The test results in this report apply exclusively to the tested model / sample. Without written approval of SPORTON INTERNATIONAL INC., the test report shall not be reproduced except in full.

Reviewed by: Joseph Lin / Supervisor

Approved by: Jones Tsai / Manager



## **SPORTON INTERNATIONAL INC.**

**No. 52, Hwa Ya 1<sup>st</sup> Rd., Hwa Ya Technology Park, Kwei-Shan District, Tao Yuan City, Taiwan, R.O.C.**

SPORTON INTERNATIONAL INC.

TEL : 886-3-327-3456

FAX : 886-3-328-4978

FCC ID : IHDT56VA1

Page Number : 1 of 6

Report Issued Date : May 08, 2016

Report Version : Rev. 04

Report Template No.: BU5-FR15CBT Version 1.1



# TABLE OF CONTENTS

**REVISION HISTORY..... 3**

**1 GENERAL DESCRIPTION..... 4**

    1.1 Applicant ..... 4

    1.2 Manufacturer..... 4

    1.3 Product Feature of Equipment Under Test..... 4

    1.4 Re-use of Measured Data ..... 5

    1.5 Modification of EUT ..... 6

**APPENDIX A. ORIGINAL REPORT**





# 1 General Description

## 1.1 Applicant

Motorola Mobility, LLC  
222 W. Merchandise Mart Plaza, Chicago IL 60654 USA

## 1.2 Manufacturer

Motorola Mobility, LLC  
222 W. Merchandise Mart Plaza, Chicago IL 60654 USA

## 1.3 Product Feature of Equipment Under Test

Product Feature	
Equipment	Mobile Cellular Phone
Brand Name	Motorola
Model Name	7050
FCC ID	IHDT56VA1
EUT supports Radios application	GSM/EGPRS/WCDMA/HSPA/LTE/FM WLAN 11b/g/n HT20 WLAN 11a/n HT20/HT40 Bluetooth v3.0 EDR Bluetooth v4.0 LE
HW Version	DVT2
EUT Stage	Identical Prototype



## 1.4 Re-use of Measured Data

This application re-uses data collected on a similar device. The subject device of this application (Model 7050, FCC ID IHDT56VA1) is electrically identical to the reference device (Model 8028, FCC ID IHDT56VA2) for the portions of the circuitry corresponding to the data being re-used, as treated by KDB Publication 178919 D01.

For details concerning the similarity with respect to component placement, mechanical/electrical design etc., please refer to the Operational Description.

The re-used RF data includes the following bands provided in Appendix A (Sporton RF Report No. FR620325A for the reference device Model 8028, FCC ID IHDT56VA2):

-Bluetooth

In order to confirm hardware similarity of the subject device with the reference device, spot check measurements were performed on the subject device for the individual cases as the table below this paragraph.

Assertions concerning the similarity of these devices are based on representations by the applicant. The applicant accepts full responsibility for the validity of the similarity claim, and for the determination that verification test data are sufficient to support it.

Considering the spot check has been performed at the worst case within WLAN 2.4GHz of the reference device, hence Bluetooth is not required to be tested.

Please refer to the DTS WLAN report.

**Note:** The device from which these reference data are taken is currently in the process of FCC certification, and may not yet be visible on the FCC web system. However, these data are representative of the reference device, and are valid for this purpose.



## **1.5 Modification of EUT**

No modifications are made to the EUT during all test items.



## **Appendix A. Original Report**

Please refer to Sporton report number FR620325A as below.



# FCC RF Test Report

**APPLICANT** : Motorola Mobility, LLC  
**EQUIPMENT** : Mobile Cellular Phone  
**BRAND NAME** : Motorola  
**MODEL NAME** : 8028  
**FCC ID** : IHDT56VA2  
**STANDARD** : FCC Part 15 Subpart C §15.247  
**CLASSIFICATION** : (DSS) Spread Spectrum Transmitter

The product was received on Feb. 03, 2016 and testing was completed on Mar. 04, 2016. We, SPORTON INTERNATIONAL INC., would like to declare that the tested sample has been evaluated in accordance with the test procedures and has been in compliance with the applicable technical standards.

The test results in this report apply exclusively to the tested model / sample. Without written approval of SPORTON INTERNATIONAL INC., the test report shall not be reproduced except in full.

---

Reviewed by: Joseph Lin / Supervisor

---

Approved by: Jones Tsai / Manager



## **SPORTON INTERNATIONAL INC.**

**No. 52, Hwa Ya 1<sup>st</sup> Rd., Hwa Ya Technology Park, Kwei-Shan District, Tao Yuan City, Taiwan, R.O.C.**



# TABLE OF CONTENTS

**REVISION HISTORY..... 3**

**SUMMARY OF TEST RESULT ..... 4**

**1 GENERAL DESCRIPTION..... 5**

1.1 Applicant ..... 5

1.2 Manufacturer..... 5

1.3 Product Feature of Equipment Under Test..... 5

1.4 Product Specification of Equipment Under Test..... 6

1.5 Modification of EUT ..... 6

1.6 Testing Location ..... 7

1.7 Applicable Standards..... 7

**2 TEST CONFIGURATION OF EQUIPMENT UNDER TEST..... 8**

2.1 Descriptions of Test Mode ..... 8

2.2 Test Mode..... 9

2.3 Connection Diagram of Test System..... 10

2.4 Support Unit used in test configuration and system ..... 11

2.5 EUT Operation Test Setup ..... 11

2.6 Measurement Results Explanation Example..... 11

**3 TEST RESULT ..... 12**

3.1 Number of Channel Measurement ..... 12

3.2 Hopping Channel Separation Measurement ..... 14

3.3 Dwell Time Measurement..... 21

3.4 20dB and 99% Bandwidth Measurement ..... 23

3.5 Peak Output Power Measurement ..... 36

3.6 Conducted Band Edges Measurement..... 38

3.7 Conducted Spurious Emission Measurement ..... 45

3.8 Radiated Band Edges and Spurious Emission Measurement ..... 55

3.9 AC Conducted Emission Measurement..... 61

3.10 Antenna Requirements..... 66

**4 LIST OF MEASURING EQUIPMENT..... 67**

**5 UNCERTAINTY OF EVALUATION..... 68**

**APPENDIX A. RADIATED TEST RESULTS**

**APPENDIX B. RADIATED SPURIOUS EMISSION PLOTS**





### SUMMARY OF TEST RESULT

Report Section	FCC Rule	Description	Limit	Result	Remark
3.1	15.247(a)(1)	Number of Channels	≥ 15Chs	Pass	-
3.2	15.247(a)(1)	Hopping Channel Separation	≥ 2/3 of 20dB BW	Pass	-
3.3	15.247(a)(1)	Dwell Time of Each Channel	≤ 0.4sec in 31.6sec period	Pass	-
3.4	15.247(a)(1)	20dB Bandwidth	NA	Pass	-
3.4	-	99% Bandwidth	-	Pass	-
3.5	15.247(b)(1)	Peak Output Power	≤ 125 mW	Pass	-
3.6	15.247(d)	Conducted Band Edges	≤ 20dBc	Pass	-
3.7	15.247(d)	Conducted Spurious Emission	≤ 20dBc	Pass	-
3.8	15.247(d)	Radiated Band Edges and Radiated Spurious Emission	15.209(a) & 15.247(d)	Pass	Under limit 7.30 dB at 197.940 MHz
3.9	15.207	AC Conducted Emission	15.207(a)	Pass	Under limit 13.40 dB at 3.222 MHz
3.10	15.203 & 15.247(b)	Antenna Requirement	N/A	Pass	-



# 1 General Description

## 1.1 Applicant

**Motorola Mobility, LLC**  
222 W. Merchandise Mart Plaza, Chicago IL 60654 USA

## 1.2 Manufacturer

**Motorola Mobility, LLC**  
222 W. Merchandise Mart Plaza, Chicago IL 60654 USA

## 1.3 Product Feature of Equipment Under Test

Product Feature	
<b>Equipment</b>	Mobile Cellular Phone
<b>Brand Name</b>	Motorola
<b>Model Name</b>	8028
<b>FCC ID</b>	IHDT56VA2
<b>IMEI Code</b>	354117070006154 (for Radiated Spurious Emission) 354117070005990 (for AC Conducted Emission)
<b>EUT supports Radios application</b>	GSM/EGPRS/WCDMA/HSPA/LTE/FM WLAN 11b/g/n HT20 WLAN 11a/n HT20/HT40 Bluetooth v3.0 EDR Bluetooth v4.0 LE
<b>HW Version</b>	DVT2
<b>EUT Stage</b>	Identical Prototype

**Remark:** The above EUT's information was declared by manufacturer. Please refer to the specifications or user's manual for more detailed description.

Accessory List	
<b>AC Adapter</b>	Brand Name : Motorola
	Model Name : SPN5866A
<b>Earphone</b>	Brand Name : Motorola
	Model Name : SJYN1181B
<b>USB Cable</b>	Brand Name : Motorola
	Model Name : SKN6462A



### 1.4 Product Specification of Equipment Under Test

Standards-related Product Specification	
<b>Tx/Rx Frequency Range</b>	2402 MHz ~ 2480 MHz
<b>Number of Channels</b>	79
<b>Carrier Frequency of Each Channel</b>	2402+n*1 MHz; n=0~78
<b>Maximum Output Power to Antenna</b>	Bluetooth BR(1Mbps) : 12.26 dBm (0.0168 W) Bluetooth EDR (2Mbps) : 12.29 dBm (0.0169 W) Bluetooth EDR (3Mbps) : 12.64 dBm (0.0184 W)
<b>99% Occupied Bandwidth</b>	Bluetooth BR(1Mbps) : 0.876MHz Bluetooth EDR (2Mbps) : 1.168MHz Bluetooth EDR (3Mbps) : 1.152MHz
<b>Antenna Type</b>	Fixed Internal Antenna (The antenna peak gain of EUT is less than 6 dBi)
<b>Type of Modulation</b>	Bluetooth BR (1Mbps) : GFSK Bluetooth EDR (2Mbps) : $\pi/4$ -DQPSK Bluetooth EDR (3Mbps) : 8-DPSK

### 1.5 Modification of EUT

No modifications are made to the EUT during all test items.



### 1.6 Testing Location

Sporton Lab is accredited to ISO 17025 by Taiwan Accreditation Foundation (TAF code : 1190) and the FCC designation No. TW1022 under the FCC 2.948(e) by Mutual Recognition Agreement (MRA) in FCC Test.

<b>Test Site</b>	SPORTON INTERNATIONAL INC.		
<b>Test Site Location</b>	No. 52, Hwa Ya 1 <sup>st</sup> Rd., Hwa Ya Technology Park, Kwei-Shan District, Tao Yuan City, Taiwan, R.O.C. TEL: +886-3-327-3456 FAX: +886-3-328-4978		
<b>Test Site No.</b>	<b>Sporton Site No.</b>		
	TH02-HY	CO05-HY	03CH07-HY

**Note:** The test site complies with ANSI C63.4 2014 requirement.

### 1.7 Applicable Standards

According to the specifications of the manufacturer, the EUT must comply with the requirements of the following standards:

- ♦ FCC Part 15 Subpart C §15.247
- ♦ ANSI C63.10-2013

**Remark:**

1. All test items were verified and recorded according to the standards and without any deviation during the test.
2. This EUT has also been tested and complied with the requirements of FCC Part 15, Subpart B, recorded in a separate test report.



## 2 Test Configuration of Equipment Under Test

### 2.1 Descriptions of Test Mode

Preliminary tests were performed in different data rates and recorded the RF output power in the following table:

Channel	Frequency	Bluetooth RF Output Power		
		Data Rate / Modulation		
		GFSK	$\pi/4$ -DQPSK	8-DPSK
		1Mbps	2Mbps	3Mbps
Ch00	2402MHz	10.94 dBm	10.89 dBm	11.22 dBm
Ch39	2441MHz	12.26 dBm	12.29 dBm	12.64 dBm
Ch78	2480MHz	9.95 dBm	9.84 dBm	10.21 dBm

Channel	Frequency	Bluetooth Average Power		
		Data Rate / Modulation		
		GFSK	$\pi/4$ -DQPSK	8-DPSK
		1Mbps	2Mbps	3Mbps
Ch00	2402MHz	10.67 dBm	8.76 dBm	8.65 dBm
Ch39	2441MHz	12.01 dBm	10.14 dBm	10.06 dBm
Ch78	2480MHz	9.60 dBm	7.49 dBm	7.44 dBm

**Remark:**

1. All the test data for each data rate were verified, but only the worst case was reported.
  2. The data rate was set in 3Mbps for all the test items due to the highest RF output power.
- a. The EUT has been associated with peripherals and configuration operated in a manner tended to maximize its emission characteristics in a typical application. Frequency range investigated: conduction (150 kHz to 30 MHz), radiation (9 kHz to the 10th harmonic of the highest fundamental frequency or to 40 GHz, whichever is lower). Pre-scanned tests, X, Y, Z in three orthogonal panels, and different data rates were conducted to determine the final configuration (Z plane as worst plane) from all possible combinations, and the worst mode of radiated spurious emissions is Bluetooth 3Mbps mode, and recorded in this report.
- b. AC power line Conducted Emission was tested under maximum output power.



## 2.2 Test Mode

The following summary table is showing all test modes to demonstrate in compliance with the standard.

Summary table of Test Cases			
Test Item	Data Rate / Modulation		
	Bluetooth BR 1Mbps GFSK	Bluetooth EDR 2Mbps $\pi/4$ -DQPSK	Bluetooth EDR 3Mbps 8-DPSK
Conducted Test Cases	Mode 1: CH00_2402 MHz	Mode 4: CH00_2402 MHz	Mode 7: CH00_2402 MHz
	Mode 2: CH39_2441 MHz	Mode 5: CH39_2441 MHz	Mode 8: CH39_2441 MHz
	Mode 3: CH78_2480 MHz	Mode 6: CH78_2480 MHz	Mode 9: CH78_2480 MHz
Radiated Test Cases	Bluetooth EDR 3Mbps 8-DPSK		
	Mode 1: CH00_2402 MHz		
	Mode 2: CH39_2441 MHz		
	Mode 3: CH78_2480 MHz		
AC Conducted Emission	Mode 1 :GSM850 Idle + Bluetooth Link + WLAN (2.4GHz) Link + Earphone + MP3 + USB Cable (Charging from Adapter)		
<p><b>Remark:</b> For radiated test cases, the worst mode data rate 3Mbps was reported only, because this data rate has the highest RF output power at preliminary tests, and the conducted spurious emissions and conducted band edge measurement for each data rate are no worse than 3Mbps, and no other significantly frequencies found in conducted spurious emission.</p>			

## 2.3 Connection Diagram of Test System

### <Bluetooth Tx Mode>

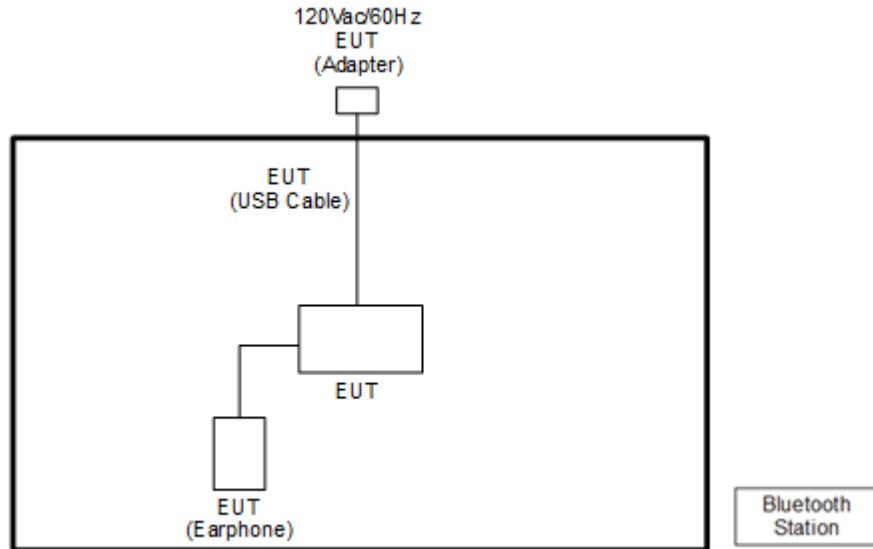

### <AC Conducted Emission Mode>

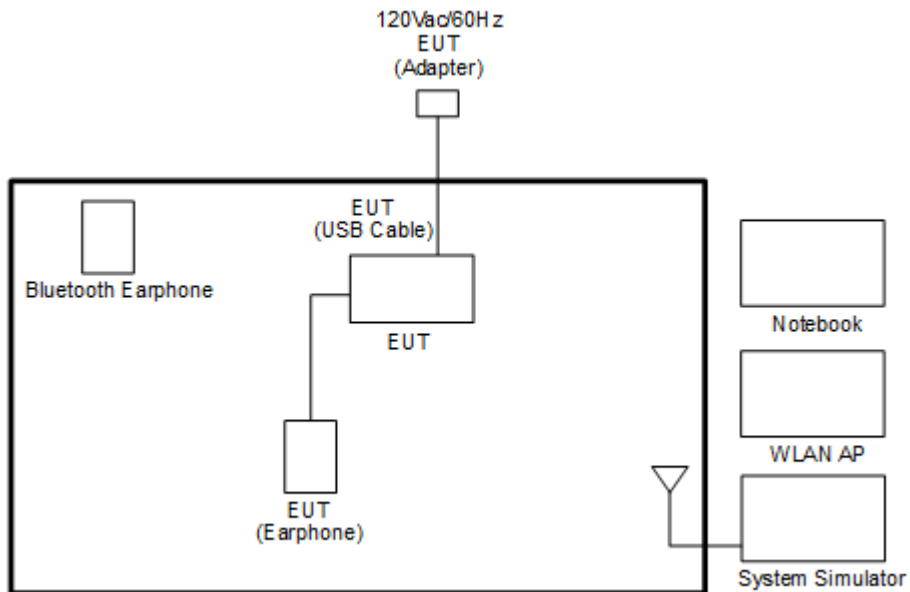



## 2.4 Support Unit used in test configuration and system

Item	Equipment	Trade Name	Model Name	FCC ID	Data Cable	Power Cord
1.	Bluetooth Base Station	R&S	CBT32	N/A	N/A	Unshielded, 1.8 m
2.	System Simulator	Anritsu	MT8820C	N/A	N/A	Unshielded, 1.8 m
3.	WLAN AP	D-Link	DIR-865L	KA2IR865LA1	N/A	Unshielded, 1.8 m
4.	Notebook	DELL	Latitude E6320	FCC DoC/ Contains FCC ID: QDS-BRCM1054	N/A	AC I/P: Unshielded, 1.2 m DC O/P: Shielded, 1.8 m
5.	Bluetooth Earphone	Sony Ericsson	MW600	PY7DDA-2029	N/A	N/A
6.	SD Card	SanDisk	MicroSD HC	FCC DoC	N/A	N/A

## 2.5 EUT Operation Test Setup

For Bluetooth function, programmed RF utility, “Command” installed in the EUT provide functions like channel selection and power level for continuous transmitting and receiving signals.

## 2.6 Measurement Results Explanation Example

**For all conducted test items:**

The offset level is set in the spectrum analyzer to compensate the RF cable loss and attenuator factor between EUT conducted output port and spectrum analyzer. With the offset compensation, the spectrum analyzer reading level is exactly the EUT RF output level.

Example:

The spectrum analyzer offset is derived from RF cable loss and attenuator factor.

*Offset = RF cable loss + attenuator factor.*

Following shows an offset computation example with cable loss 4.2 dB and 10dB attenuator.

$$\begin{aligned} \text{Offset(dB)} &= \text{RF cable loss(dB)} + \text{attenuator factor(dB)}. \\ &= 4.2 + 10 = 14.2 \text{ (dB)} \end{aligned}$$

### 3 Test Result

#### 3.1 Number of Channel Measurement

##### 3.1.1 Limits of Number of Hopping Frequency

Frequency hopping systems in the 2400-2483.5 MHz band shall use at least 15 channels.

##### 3.1.2 Measuring Instruments

The measuring equipment is listed in the section 4 of this test report.

##### 3.1.3 Test Procedure

1. The testing follows ANSI C63.10-2013 clause 7.8.3.
2. The RF output of EUT was connected to the spectrum analyzer by RF cable and attenuator. The path loss was compensated to the results for each measurement.
3. Set to the maximum power setting and enable the EUT transmit continuously.
4. Enable the EUT hopping function.
5. Use the following spectrum analyzer settings: Span = the frequency band of operation; RBW = 300kHz; VBW  $\geq$  RBW; Sweep = auto; Detector function = peak; Trace = max hold.
6. The number of hopping frequency used is defined as the number of total channel.
7. Record the measurement data derived from spectrum analyzer.

##### 3.1.4 Test Setup

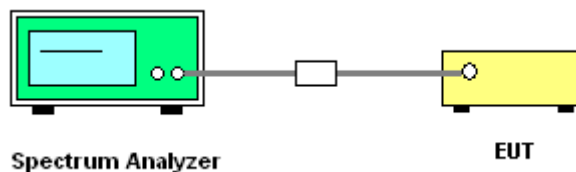

##### 3.1.5 Test Result of Number of Hopping Frequency

<b>Test Mode :</b>	3Mbps	<b>Temperature :</b>	24~26°C
<b>Test Engineer :</b>	Osolemio Chang	<b>Relative Humidity :</b>	48~51%
<b>Number of Hopping (Channel)</b>	<b>Adaptive Frequency Hopping (Channel)</b>	<b>Limits (Channel)</b>	<b>Pass/Fail</b>
79	20	> 15	Pass



Number of Hopping Channel Plot on Channel 00 - 78

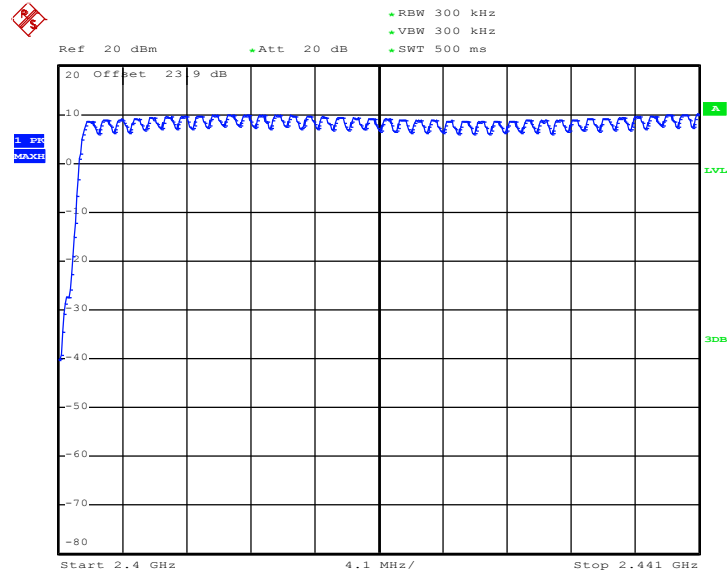

Date: 9.FEB.2016 15:17:04

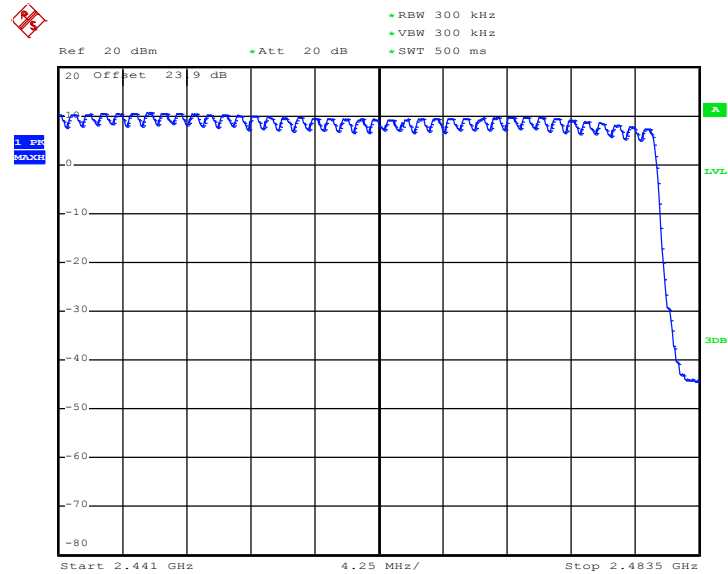

Date: 9.FEB.2016 15:24:31

## 3.2 Hopping Channel Separation Measurement

### 3.2.1 Limit of Hopping Channel Separation

Frequency hopping systems operating in the 2400-2483.5 MHz band may have hopping channel carrier frequencies that are separated by 25 kHz or two-thirds of the 20 dB bandwidth of the hopping channel, whichever is greater.

### 3.2.2 Measuring Instruments

The measuring equipment is listed in the section 4 of this test report.

### 3.2.3 Test Procedures

1. The testing follows ANSI C63.10-2013 clause 7.8.2.
2. The RF output of EUT was connected to the spectrum analyzer by RF cable and attenuator. The path loss was compensated to the results for each measurement.
3. Set to the maximum power setting and enable the EUT transmit continuously.
4. Enable the EUT hopping function.
5. Use the following spectrum analyzer settings:  
Span = wide enough to capture the peaks of two adjacent channels;  
RBW = 300kHz; VBW  $\geq$  RBW; Sweep = auto; Detector function = peak; Trace = max hold.
6. Measure and record the results in the test report.

### 3.2.4 Test Setup

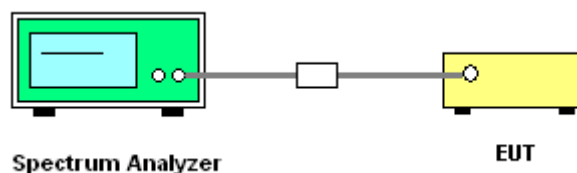



### 3.2.5 Test Result of Hopping Channel Separation

Test Mode :	1Mbps	Temperature :	24~26°C
Test Engineer :	Osolemio Chang	Relative Humidity :	48~51%

Channel	Frequency (MHz)	Frequency Separation (MHz)	(2/3 of 20dB BW) Limits (MHz)	Pass/Fail
00	2402	1.002	0.6333	Pass
39	2441	1.002	0.6333	Pass
78	2480	1.002	0.6333	Pass

Channel Separation Plot on Channel 00 - 01

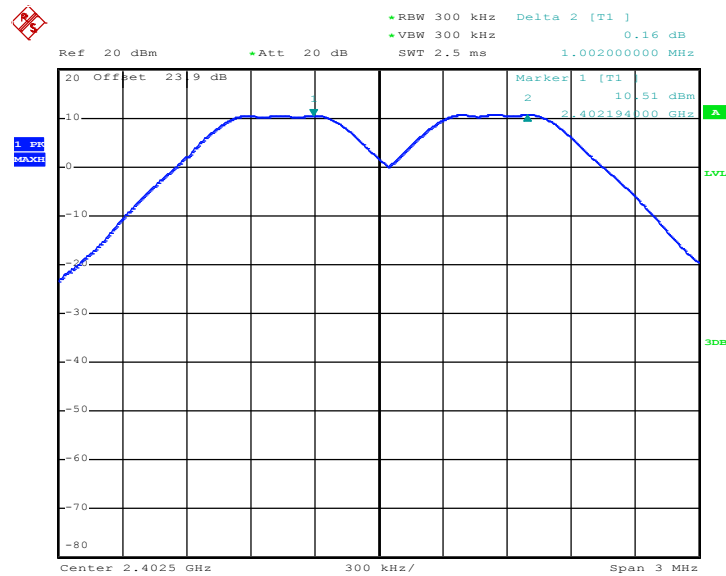

Date: 9.FEB.2016 14:07:19



### Channel Separation Plot on Channel 39 - 40

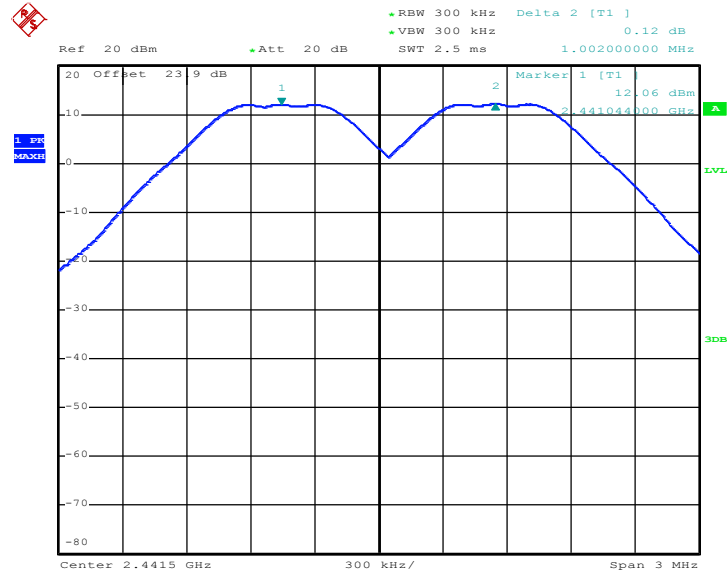

Date: 9.FEB.2016 14:08:54

### Channel Separation Plot on Channel 77 - 78

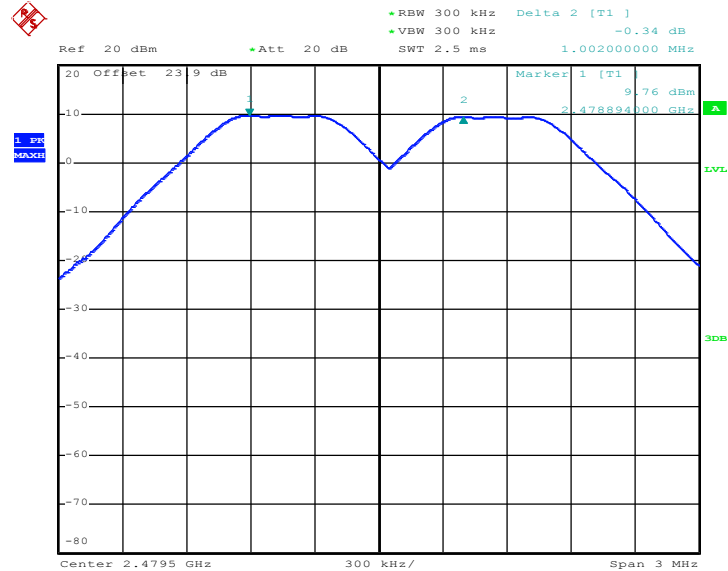

Date: 9.FEB.2016 14:11:01



Test Mode :	2Mbps	Temperature :	24~26°C
Test Engineer :	Osolemio Chang	Relative Humidity :	48~51%

Channel	Frequency (MHz)	Frequency Separation (MHz)	(2/3 of 20dB BW) Limits (MHz)	Pass/Fail
00	2402	1.302	0.8440	Pass
39	2441	1.002	0.8480	Pass
78	2480	1.008	0.8480	Pass

Channel Separation Plot on Channel 00 - 01

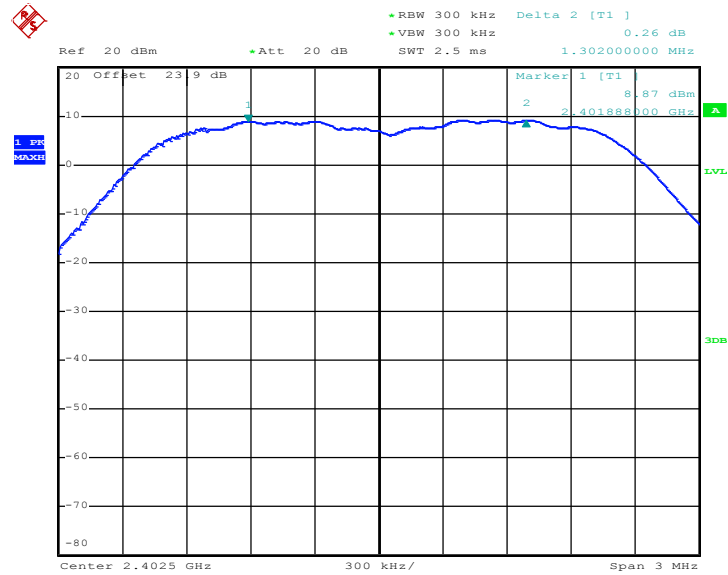

Date: 9.FEB.2016 14:15:17



Channel Separation Plot on Channel 39 - 40

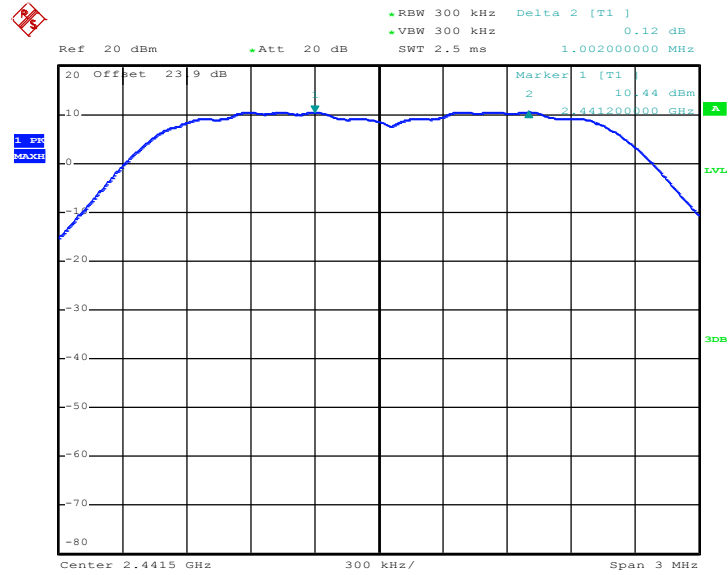

Date: 9.FEB.2016 14:16:22

Channel Separation Plot on Channel 77 - 78

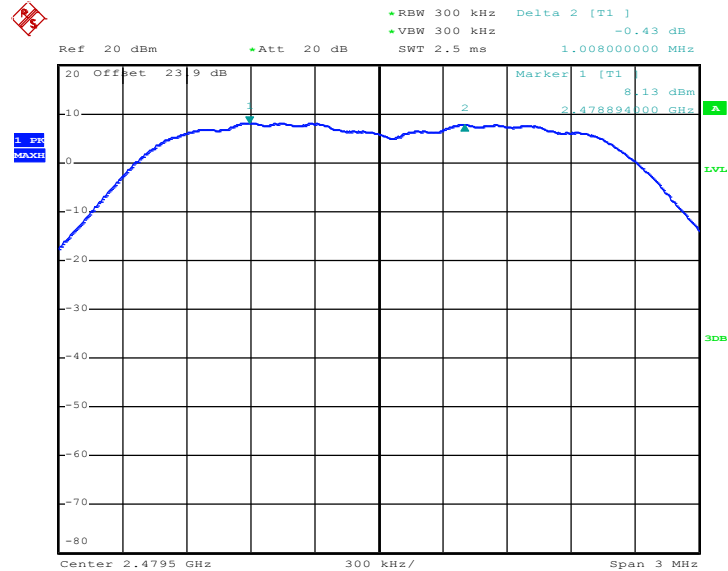

Date: 9.FEB.2016 14:17:28



Test Mode :	3Mbps	Temperature :	24~26°C
Test Engineer :	Osolemio Chang	Relative Humidity :	48~51%

Channel	Frequency (MHz)	Frequency Separation (MHz)	(2/3 of 20dB BW) Limits (MHz)	Pass/Fail
00	2402	1.002	0.8240	Pass
39	2441	1.002	0.8280	Pass
78	2480	1.002	0.8240	Pass

Channel Separation Plot on Channel 00 - 01

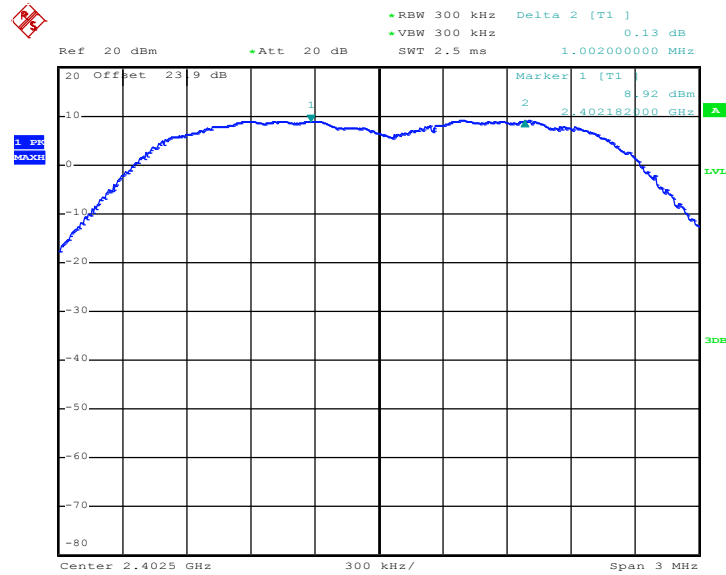

Date: 9.FEB.2016 14:19:17



### Channel Separation Plot on Channel 39 - 40

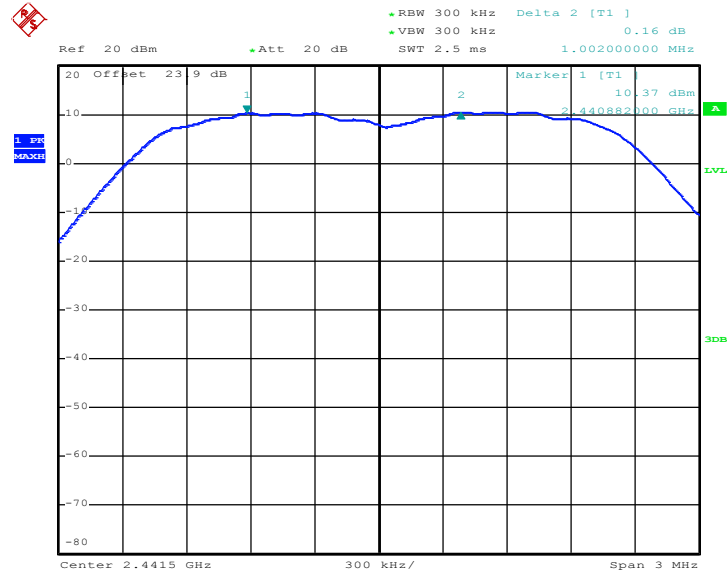

Date: 9.FEB.2016 14:22:10

### Channel Separation Plot on Channel 77 - 78

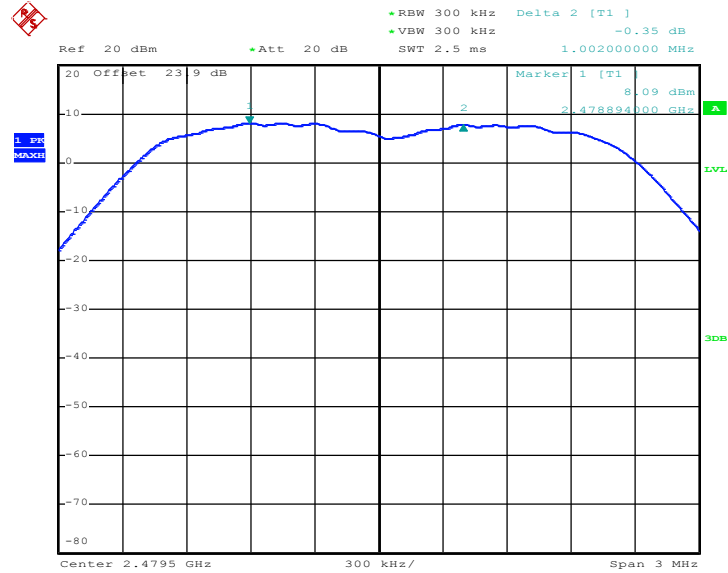

Date: 9.FEB.2016 14:25:37

### 3.3 Dwell Time Measurement

#### 3.3.1 Limit of Dwell Time

The average time of occupancy on any channel shall not be greater than 0.4 seconds within a period of 0.4 seconds multiplied by the number of hopping channels employed.

#### 3.3.2 Measuring Instruments

The measuring equipment is listed in the section 4 of this test report.

#### 3.3.3 Test Procedures

1. The testing follows ANSI C63.10-2013 clause 7.8.4.
2. The RF output of EUT was connected to the spectrum analyzer by RF cable and attenuator. The path loss was compensated to the results for each measurement.
3. Set to the maximum power setting and enable the EUT transmit continuously.
4. Enable the EUT hopping function.
5. Use the following spectrum analyzer settings: Span = zero span, centered on a hopping channel; RBW = 1 MHz; VBW  $\geq$  RBW; Sweep = as necessary to capture the entire dwell time per hopping channel; Detector function = peak; Trace = max hold.
6. Measure and record the results in the test report.

#### 3.3.4 Test Setup

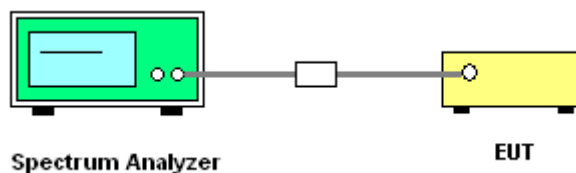



### 3.3.5 Test Result of Dwell Time

Test Mode :	DH5	Temperature :	24~26°C
Test Engineer :	Osolemio Chang	Relative Humidity :	48~51%

Mode	Hopping Channel Number	Hops Over Occupancy Time(hops)	Package Transfer Time (msec)	Dwell Time (sec)	Limits (sec)	Pass/Fail
Normal	79	106.67	2.90	0.31	0.4	Pass
AFH	20	53.33	2.90	0.15	0.4	Pass

**Remark:**

- In normal mode, hopping rate is 1600 hops/s with 6 slots in 79 hopping channels.  
With channel hopping rate (1600 / 6 / 79) in Occupancy Time Limit (0.4 x 79) (s),  
Hops Over Occupancy Time comes to (1600 / 6 / 79) x (0.4 x 79) = 106.67 hops.
- In AFH mode, hopping rate is 800 hops/s with 6 slots in 20 hopping channels.  
With channel hopping rate (800 / 6 / 20) in Occupancy Time Limit (0.4 x 20) (s),  
Hops Over Occupancy Time comes to (800 / 6 / 20) x (0.4 x 20) = 53.33 hops.
- Dwell Time(s) = Hops Over Occupancy Time (hops) x Package Transfer Time

**Package Transfer Time Plot**

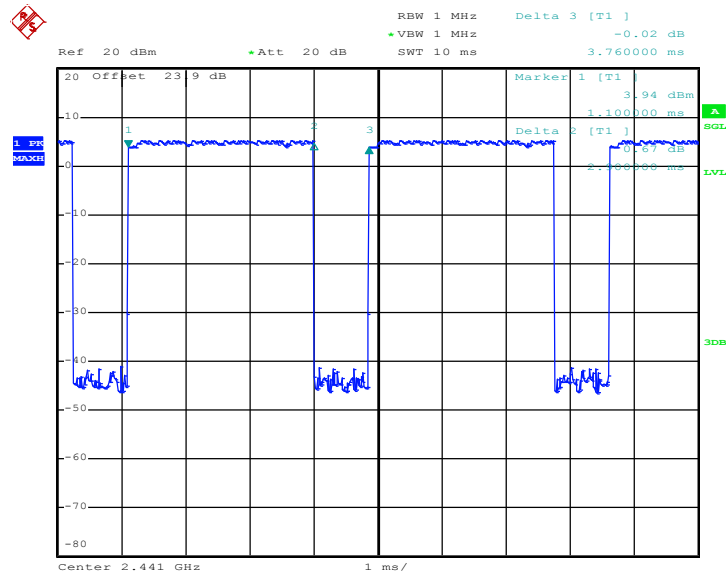

Date: 9.FEB.2016 12:19:25

### 3.4 20dB and 99% Bandwidth Measurement

#### 3.4.1 Limit of 20dB and 99% Bandwidth

Reporting only

#### 3.4.2 Measuring Instruments

The measuring equipment is listed in the section 4 of this test report.

#### 3.4.3 Test Procedures

1. The testing follows ANSI C63.10-2013 clause 6.9.2 and 6.9.3.
2. The RF output of EUT was connected to the spectrum analyzer by RF cable and attenuator. The path loss was compensated to the results for each measurement.
3. Set to the maximum power setting and enable the EUT transmit continuously.
4. Use the following spectrum analyzer settings for 20dB Bandwidth measurement.  
Span = approximately 2 to 5 times the 20 dB bandwidth, centered on a hopping channel;  
RBW  $\geq$  1% of the 20 dB bandwidth; VBW  $\geq$  RBW; Sweep = auto; Detector function = peak;  
Trace = max hold.
5. Use the following spectrum analyzer settings for 99 % Bandwidth measurement.  
Span = approximately 1.5 to 5 times the 99% bandwidth, centered on a hopping channel;  
RBW  $\geq$  1% of the 99% bandwidth; VBW  $\geq$  RBW; Sweep = auto; Detector function = peak;  
Trace = max hold.
6. Measure and record the results in the test report.

#### 3.4.4 Test Setup

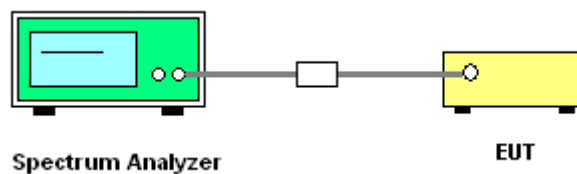



### 3.4.5 Test Result of 20dB Bandwidth

Test Mode :	1Mbps	Temperature :	24~26°C
Test Engineer :	Osolemio Chang	Relative Humidity :	48~51%

Channel	Frequency (MHz)	20dB Bandwidth (MHz)
00	2402	0.950
39	2441	0.950
78	2480	0.950

20 dB Bandwidth Plot on Channel 00

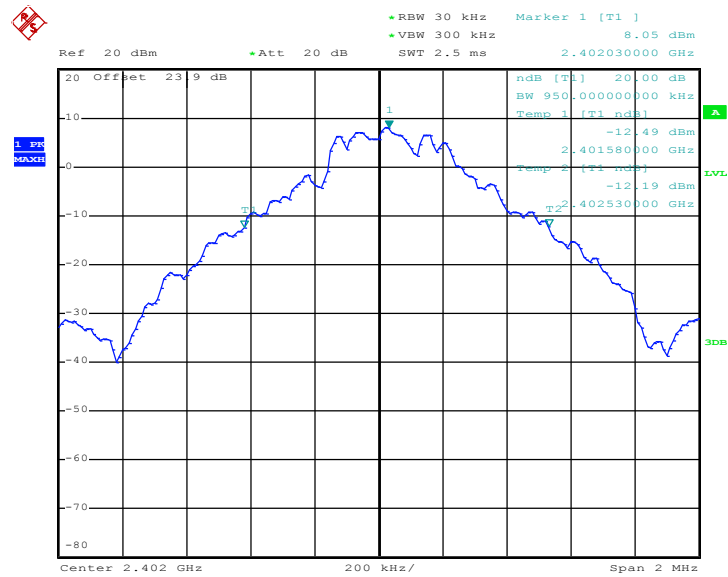

Date: 9.FEB.2016 14:30:11



20 dB Bandwidth Plot on Channel 39

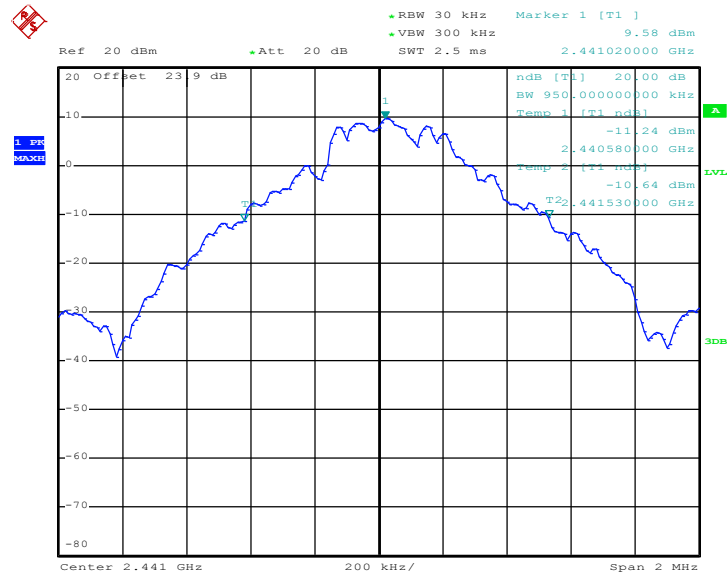

Date: 9.FEB.2016 14:34:19

20 dB Bandwidth Plot on Channel 78

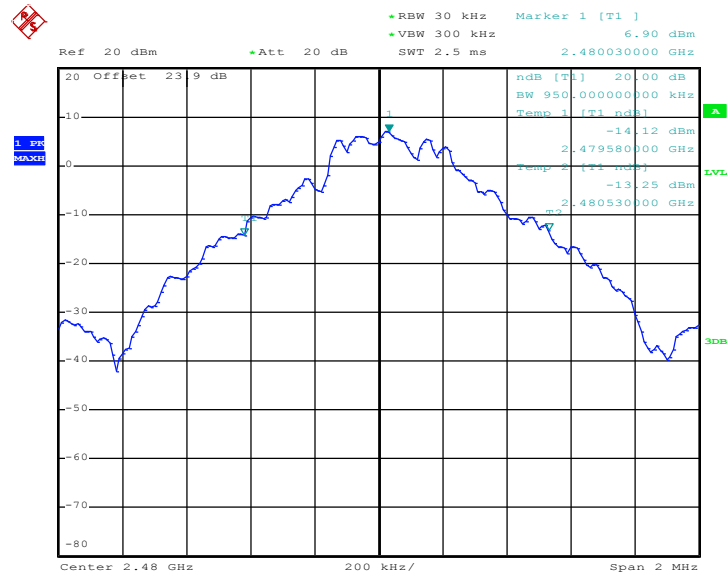

Date: 9.FEB.2016 14:39:56



Test Mode :	2Mbps	Temperature :	24~26°C
Test Engineer :	Osolemio Chang	Relative Humidity :	48~51%

Channel	Frequency (MHz)	20dB Bandwidth (MHz)
00	2402	1.266
39	2441	1.272
78	2480	1.272

20 dB Bandwidth Plot on Channel 00

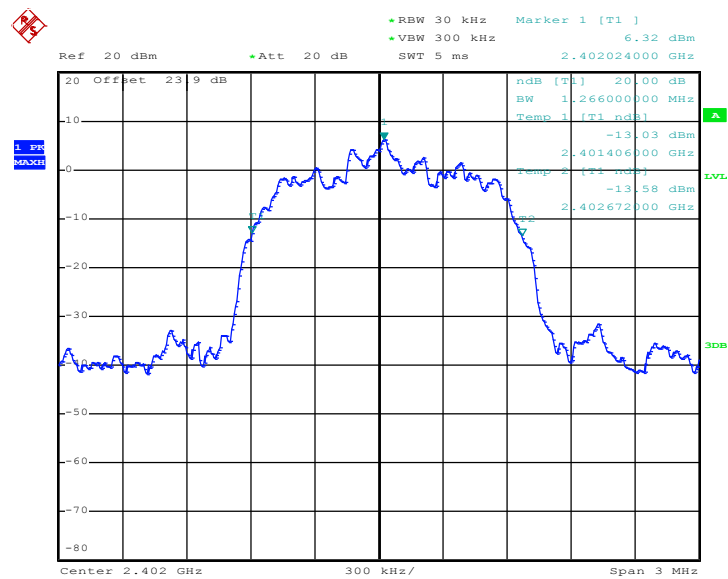

Date: 9.FEB.2016 14:45:22



20 dB Bandwidth Plot on Channel 39

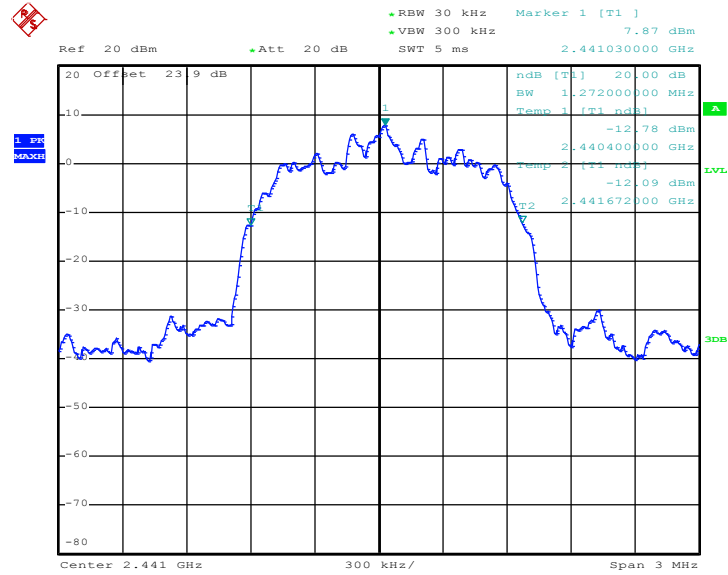

Date: 9.FEB.2016 14:49:00

20 dB Bandwidth Plot on Channel 78

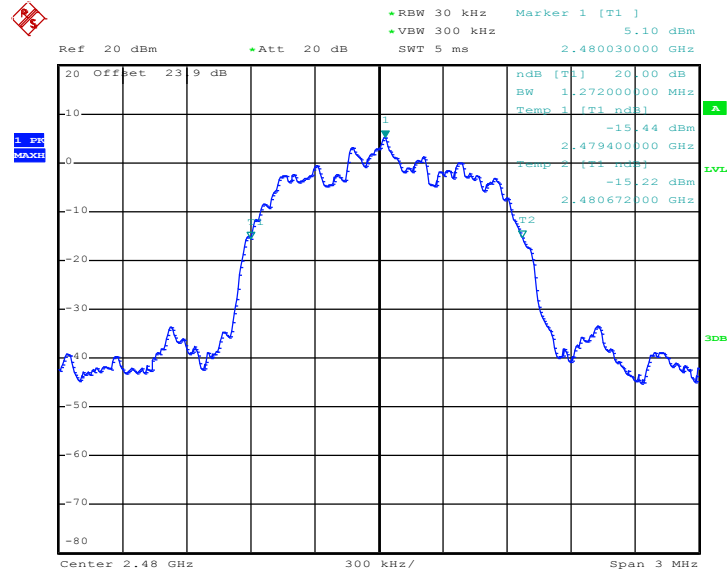

Date: 9.FEB.2016 14:52:32



Test Mode :	3Mbps	Temperature :	24~26°C
Test Engineer :	Osolemio Chang	Relative Humidity :	48~51%

Channel	Frequency (MHz)	20dB Bandwidth (MHz)
00	2402	1.236
39	2441	1.242
78	2480	1.236

20 dB Bandwidth Plot on Channel 00

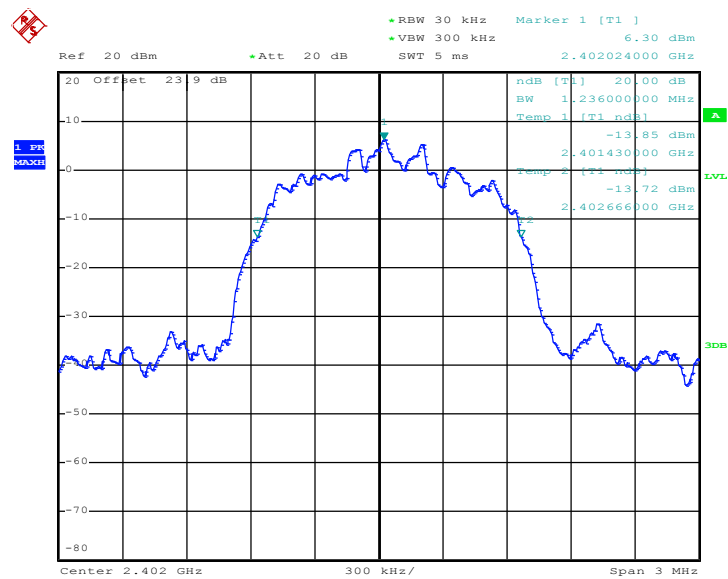

Date: 9.FEB.2016 14:55:12



20 dB Bandwidth Plot on Channel 39

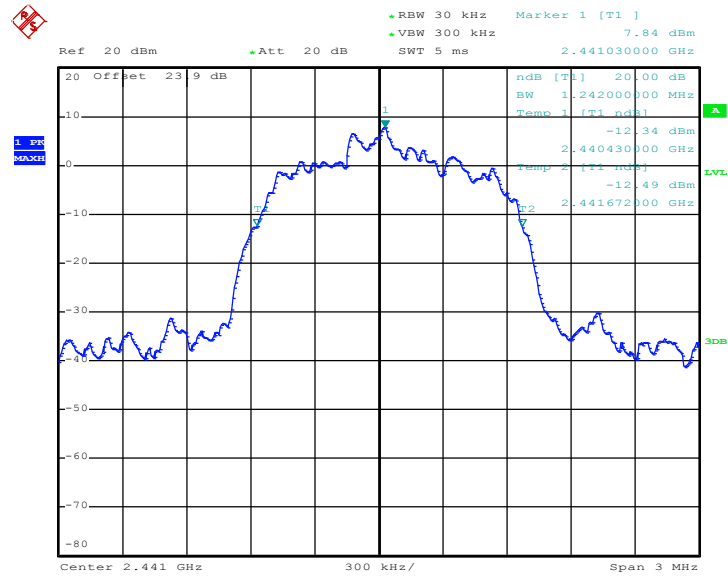

Date: 9.FEB.2016 15:01:07

20 dB Bandwidth Plot on Channel 78

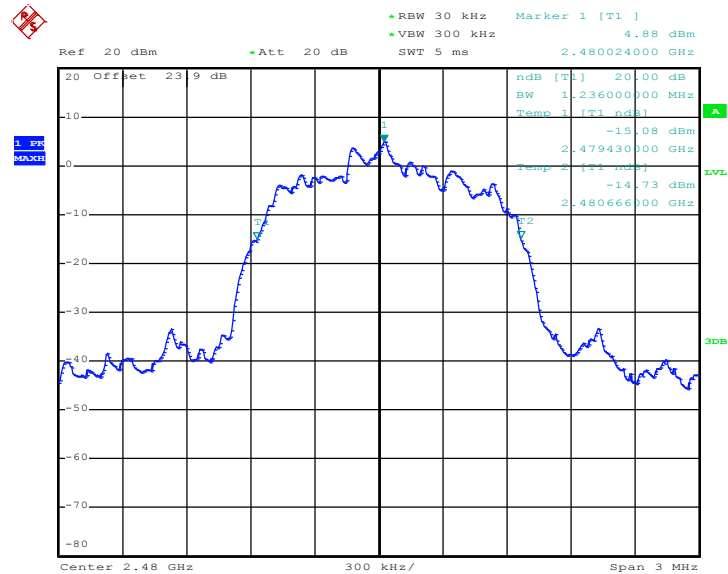

Date: 9.FEB.2016 15:04:52



3.4.6 Test Result of 99% Occupied Bandwidth

Test Mode :	1Mbps	Temperature :	24~26°C
Test Engineer :	Osolemio Chang	Relative Humidity :	48~51%

Channel	Frequency (MHz)	99% Occupied Bandwidth (MHz)
00	2402	0.872
39	2441	0.872
78	2480	0.876

99% Occupied Bandwidth Plot on Channel 00

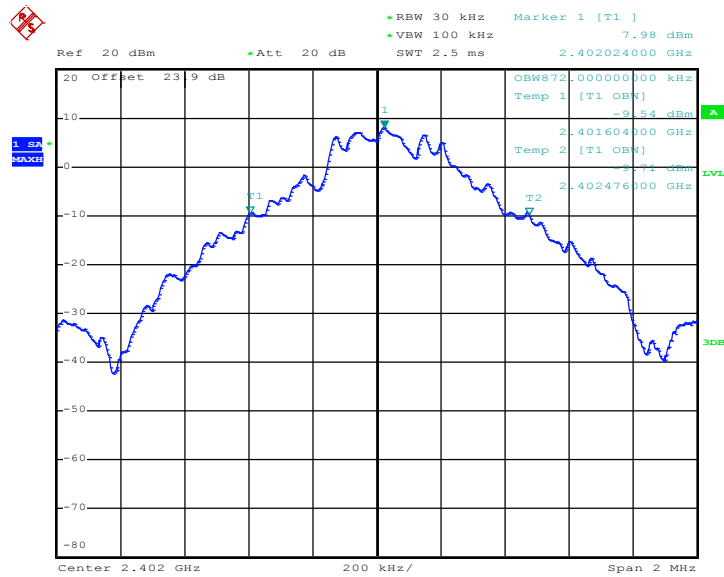

Date: 9.FEB.2016 14:31:49



99% Occupied Bandwidth Plot on Channel 39

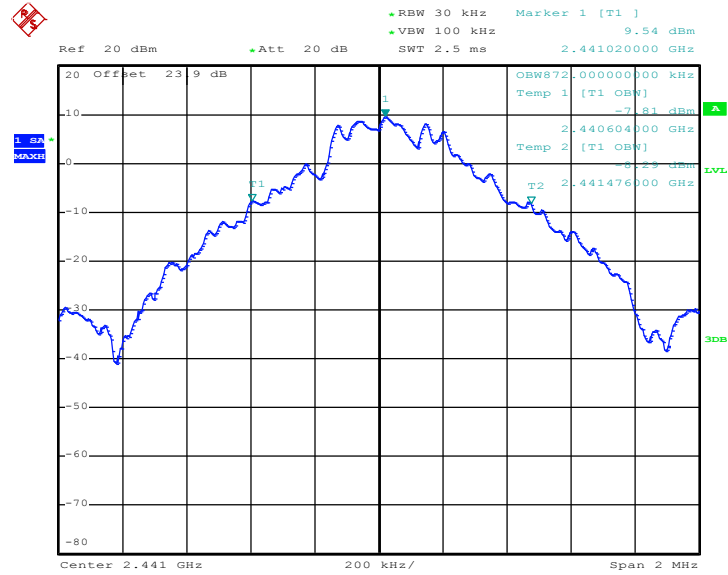

Date: 9.FEB.2016 14:36:39

99% Occupied Bandwidth Plot on Channel 78

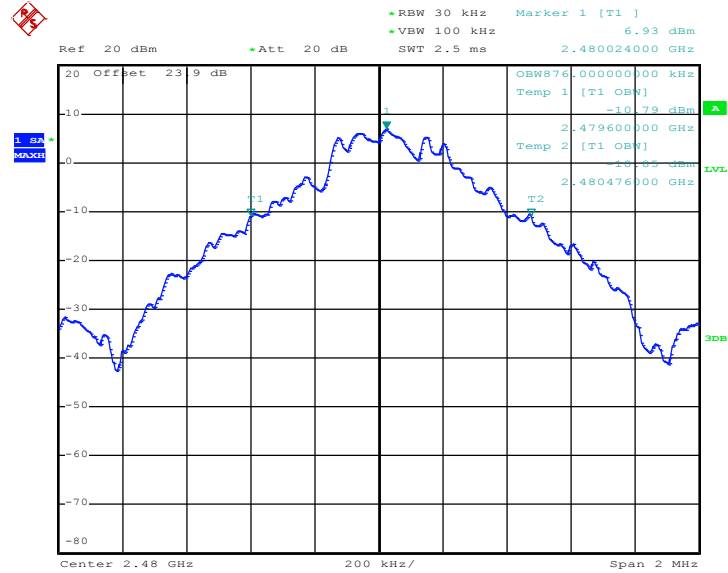

Date: 9.FEB.2016 14:42:31



Test Mode :	2Mbps	Temperature :	24~26°C
Test Engineer :	Osolemio Chang	Relative Humidity :	48~51%

Channel	Frequency (MHz)	99% Occupied Bandwidth (MHz)
00	2402	1.168
39	2441	1.168
78	2480	1.168

99% Occupied Bandwidth Plot on Channel 00

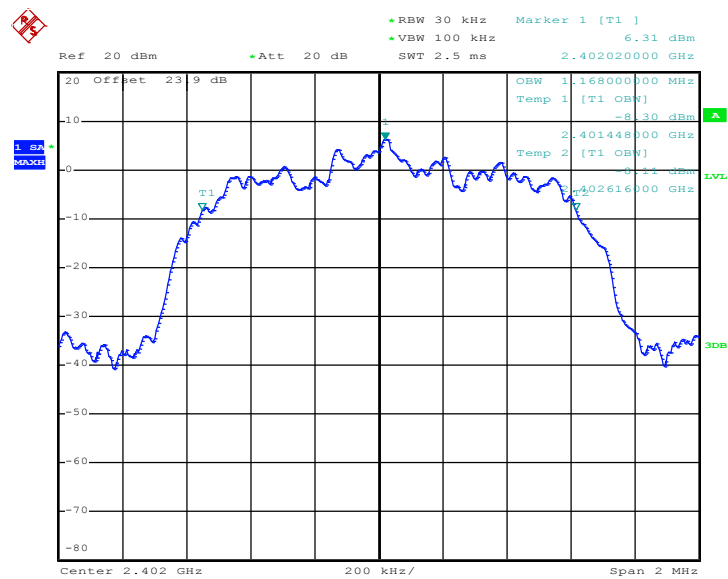

Date: 9.FEB.2016 14:46:08



99% Occupied Bandwidth Plot on Channel 39

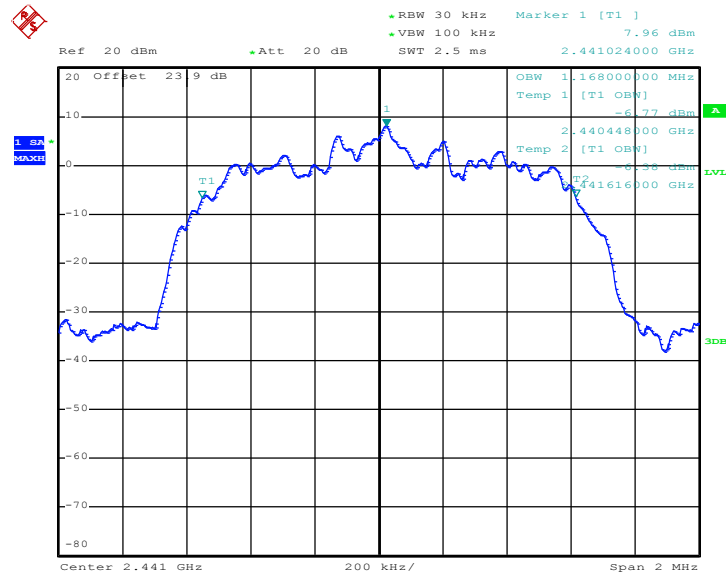

Date: 9.FEB.2016 14:50:36

99% Occupied Bandwidth Plot on Channel 78

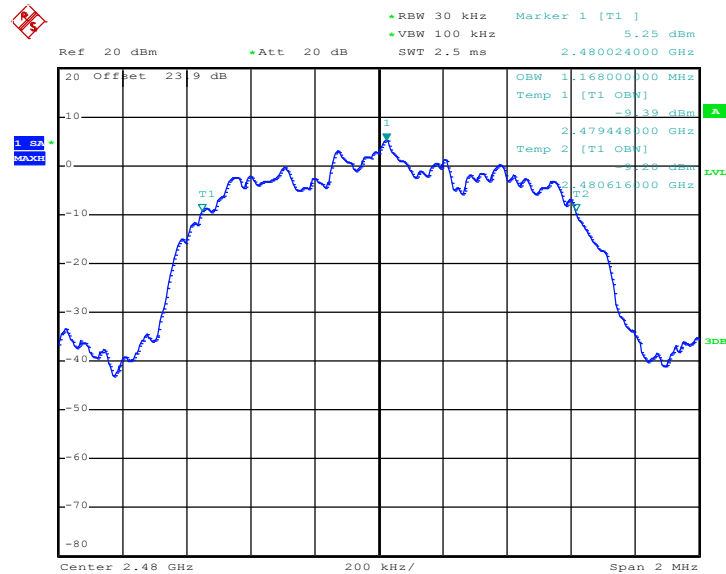

Date: 9.FEB.2016 14:53:41



Test Mode :	3Mbps	Temperature :	24~26°C
Test Engineer :	Osolemio Chang	Relative Humidity :	48~51%

Channel	Frequency (MHz)	99% Occupied Bandwidth (MHz)
00	2402	1.144
39	2441	1.152
78	2480	1.148

99% Occupied Bandwidth Plot on Channel 00

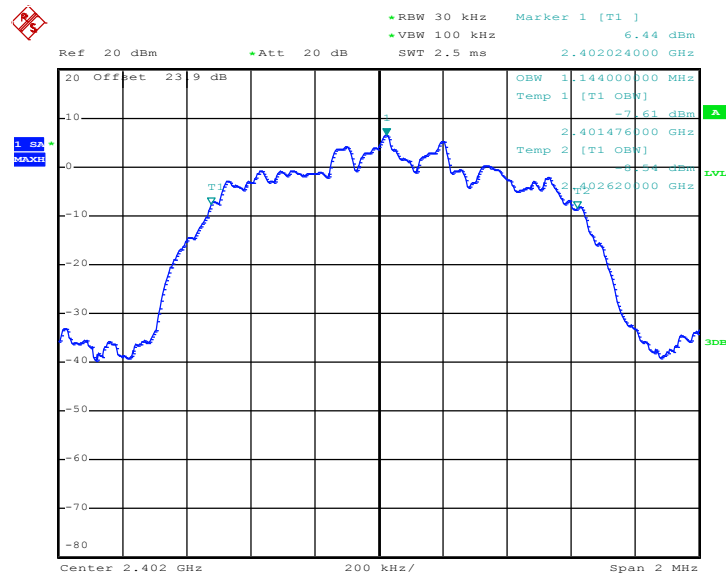

Date: 9.FEB.2016 14:55:50



99% Occupied Bandwidth Plot on Channel 39

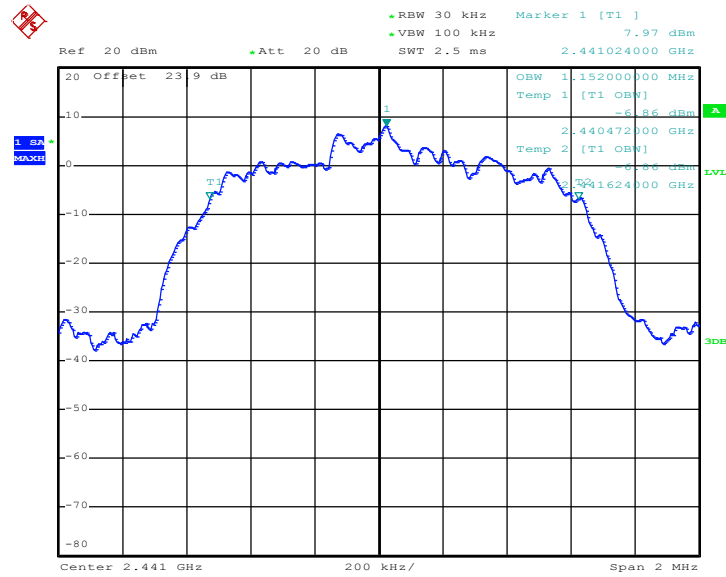

Date: 9.FEB.2016 15:01:49

99% Occupied Bandwidth Plot on Channel 78

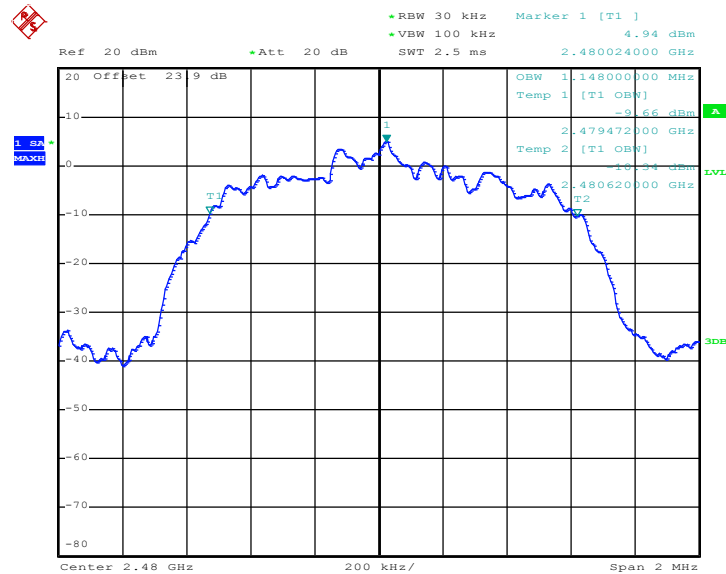

Date: 9.FEB.2016 15:07:57

Note : The occupied channel bandwidth is maintained within the band of operation for all of the modulations.

### 3.5 Peak Output Power Measurement

#### 3.5.1 Limit of Peak Output Power

Section 15.247 (b) The maximum peak conducted output power of the intentional radiator shall not exceed the following: (1) For frequency hopping systems operating in the 2400-2483.5 MHz band employing at least 75 non-overlapping hopping channels, and all frequency hopping systems in the 5725-5850 MHz band: 1 watt. For all other frequency hopping systems in the 2400-2483.5 MHz band 0.125 watts. The power limit for 1Mbps is 1watt, and for 2Mbps, 3Mbps and AFH are 0.125 watts.

#### 3.5.2 Measuring Instruments

The measuring equipment is listed in the section 4 of this test report.

#### 3.5.3 Test Procedures

1. The testing follows ANSI C63.10-2013 clause 7.8.5.
2. The RF output of EUT was connected to the power meter by RF cable and attenuator. The path loss was compensated to the results for each measurement.
3. Set to the maximum power setting and enable the EUT transmit continuously.
4. Measure the conducted output power with cable loss and record the results in the test report.
5. Measure and record the results in the test report.

#### 3.5.4 Test Setup

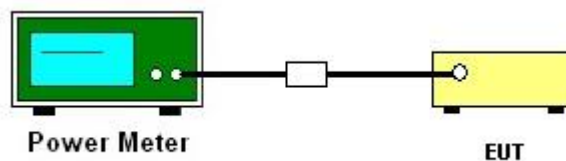



3.5.5 Test Result of Peak Output Power

Test Mode :	1Mbps	Temperature :	24~26°C
Test Engineer :	Osolemio Chang	Relative Humidity :	48~51%

Channel	Frequency (MHz)	RF Power (dBm)		
		GFSK	Max. Limits (dBm)	Pass/Fail
		1 Mbps		
00	2402	10.94	20.97	Pass
39	2441	12.26	20.97	Pass
78	2480	9.95	20.97	Pass

Note: For AFH mode using 20 hopping channels, the maximum output power limit is 20.97dBm.

Test Mode :	2Mbps	Temperature :	24~26°C
Test Engineer :	Osolemio Chang	Relative Humidity :	48~51%

Channel	Frequency (MHz)	RF Power (dBm)		
		$\pi/4$ -DQPSK	Max. Limits (dBm)	Pass/Fail
		2 Mbps		
00	2402	10.89	20.97	Pass
39	2441	12.29	20.97	Pass
78	2480	9.84	20.97	Pass

Test Mode :	3Mbps	Temperature :	24~26°C
Test Engineer :	Osolemio Chang	Relative Humidity :	48~51%

Channel	Frequency (MHz)	RF Power (dBm)		
		8-DPSK	Max. Limits (dBm)	Pass/Fail
		3 Mbps		
00	2402	11.22	20.97	Pass
39	2441	12.64	20.97	Pass
78	2480	10.21	20.97	Pass

## 3.6 Conducted Band Edges Measurement

### 3.6.1 Limit of Band Edges

In any 100 kHz bandwidth outside the intentional radiation frequency band, the radio frequency power shall be at least 20 dB below the highest level of the radiated power. In addition, radiated emissions which fall in the restricted bands must also comply with the radiated emission limits.

### 3.6.2 Measuring Instruments

The measuring equipment is listed in the section 4 of this test report.

### 3.6.3 Test Procedures

1. The testing follows ANSI C63.10-2013 clause 7.8.6.
2. Set to the maximum power setting and enable the EUT transmit continuously.
3. Set RBW = 100kHz, VBW = 300kHz. Band edge emissions must be at least 20 dB down from the highest emission level within the authorized band as measured with a 100kHz RBW. The attenuation shall be 30 dB instead of 20 dB when RMS conducted output power procedure is used.
4. Enable hopping function of the EUT and then repeat step 2. and 3.
5. Measure and record the results in the test report.

### 3.6.4 Test Setup

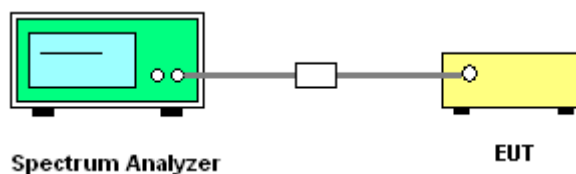





Test Mode :	2Mbps	Temperature :	24~26°C
Test Channel :	00 and 78	Relative Humidity :	48~51%
		Test Engineer :	Osolemio Chang

Low Band Edge Plot on Channel 00

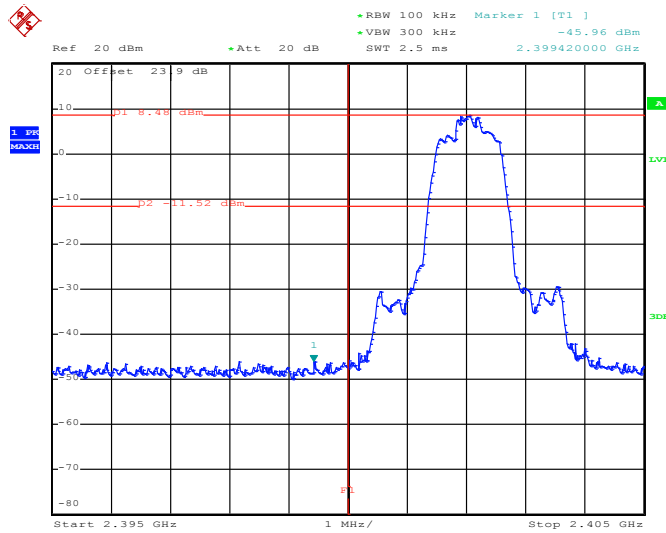

Date: 9.FEB.2016 15:32:50

High Band Edge Plot on Channel 78

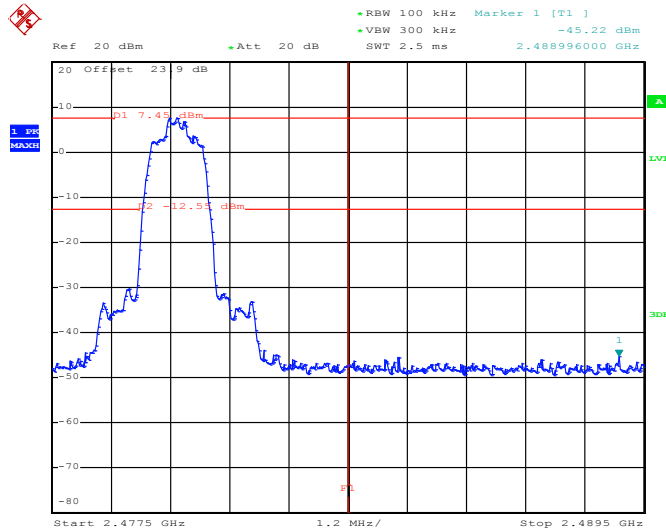

Date: 9.FEB.2016 15:33:30



Test Mode :	3Mbps	Temperature :	24~26°C
Test Channel :	00 and 78	Relative Humidity :	48~51%
		Test Engineer :	Osolemio Chang

Low Band Edge Plot on Channel 00

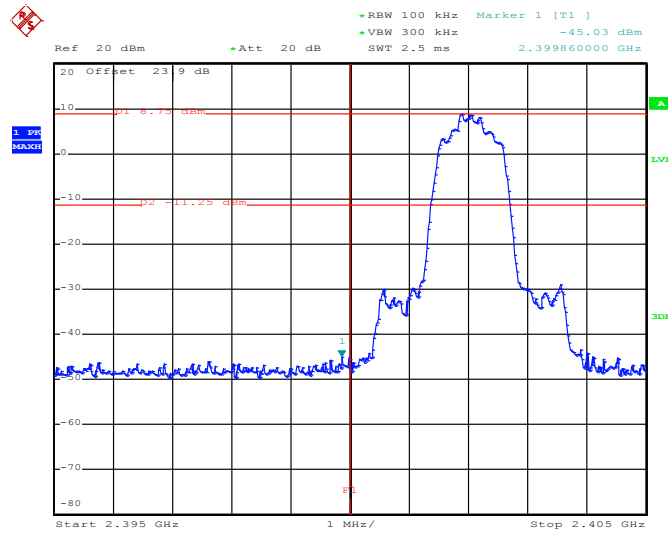

Date: 9.FEB.2016 15:34:28

High Band Edge Plot on Channel 78

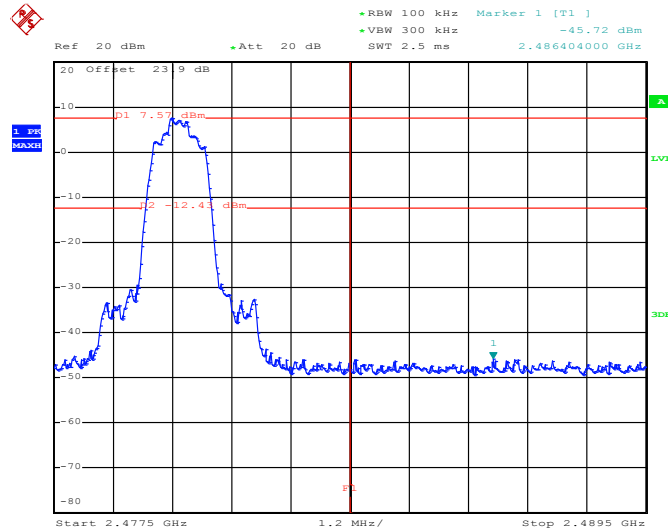

Date: 9.FEB.2016 15:35:08



### 3.6.6 Test Result of Conducted Hopping Mode Band Edges

Test Mode :	1Mbps	Temperature :	24~26°C
Test Engineer :	Osolemio Chang	Relative Humidity :	48~51%

1Mbps Hopping Mode Low Band Edge Plot

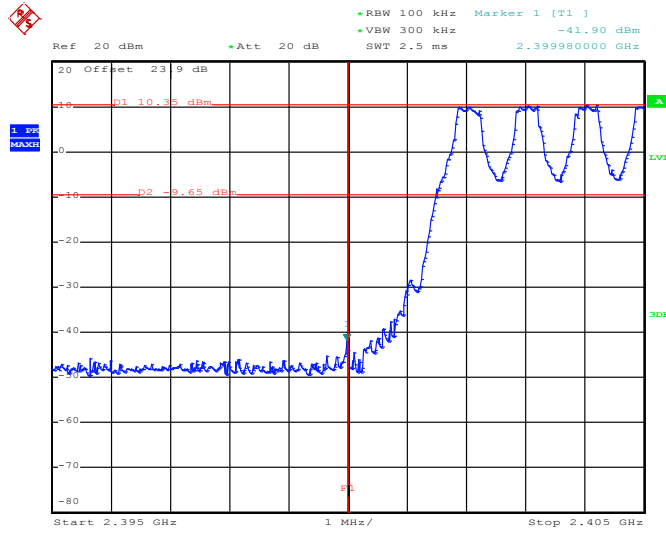

Date: 9.FEB.2016 15:27:19

1Mbps Hopping Mode High Band Edge Plot

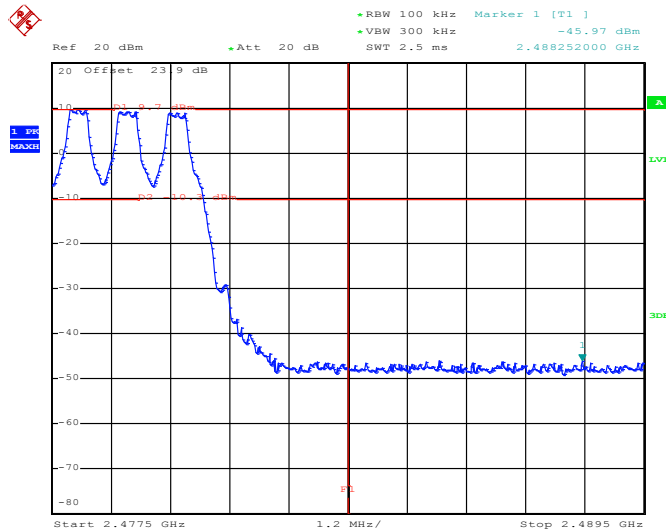

Date: 9.FEB.2016 15:27:58



Test Mode :	2Mbps	Temperature :	24~26°C
Test Engineer :	Osolemio Chang	Relative Humidity :	48~51%

2Mbps Hopping Mode Low Band Edge Plot

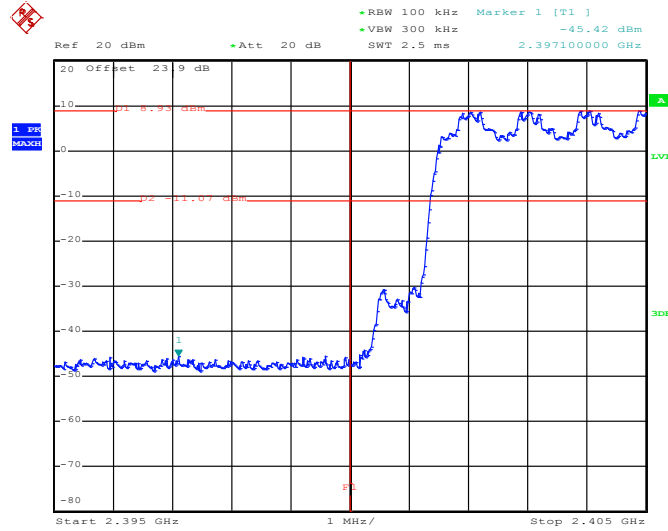

Date: 9.FEB.2016 15:29:02

2Mbps Hopping Mode High Band Edge Plot

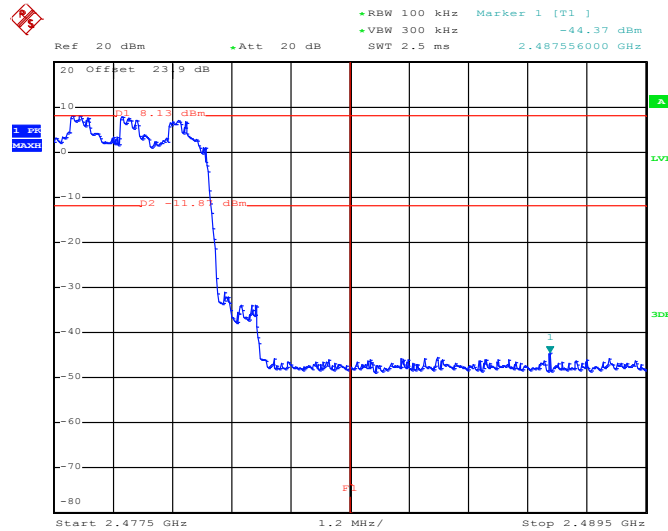

Date: 9.FEB.2016 15:29:45



Test Mode :	3Mbps	Temperature :	24~26°C
Test Engineer :	Osolemio Chang	Relative Humidity :	48~51%

3Mbps Hopping Mode Low Band Edge Plot

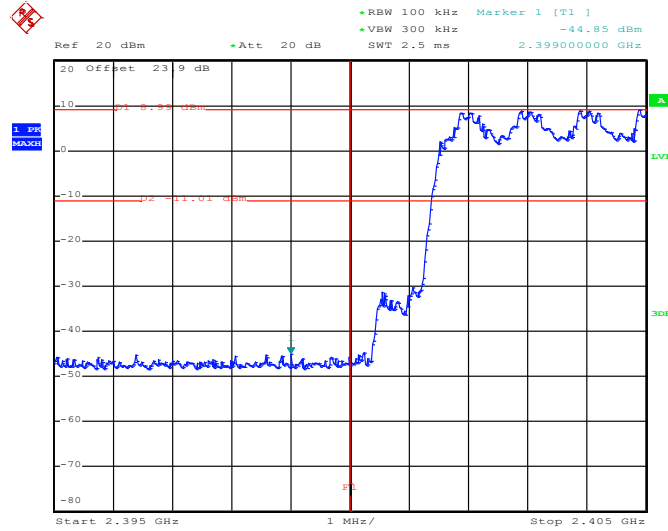

Date: 9.FEB.2016 15:26:00

3Mbps Hopping Mode High Band Edge Plot

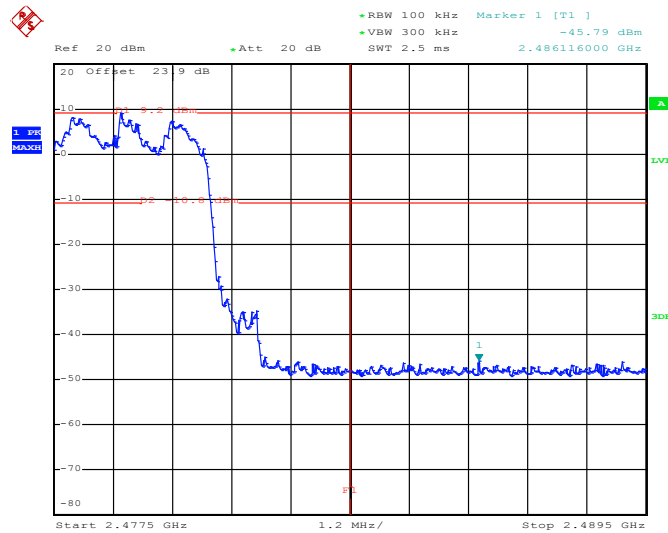

Date: 9.FEB.2016 15:26:41

### 3.7 Conducted Spurious Emission Measurement

#### 3.7.1 Limit of Spurious Emission Measurement

In any 100 kHz bandwidth outside the intentional radiation frequency band, the radio frequency power shall be at least 20 dB below the highest level of the radiated power. In addition, radiated emissions which fall in the restricted bands must also comply with the radiated emission limits.

#### 3.7.2 Measuring Instruments

The measuring equipment is listed in the section 4 of this test report.

#### 3.7.3 Test Procedure

1. The testing follows ANSI C63.10-2013 clause 7.8.8.
2. The RF output of EUT was connected to the spectrum analyzer by RF cable and attenuator. The path loss was compensated to the results for each measurement.
3. Set to the maximum power setting and enable the EUT transmit continuously.
4. Set RBW = 100 kHz, VBW = 300kHz, scan up through 10th harmonic. All harmonics / spurs must be at least 20 dB down from the highest emission level within the authorized band as measured with a 100 kHz RBW.
5. Measure and record the results in the test report.
6. The RF fundamental frequency should be excluded against the limit line in the operating frequency band.

#### 3.7.4 Test Setup

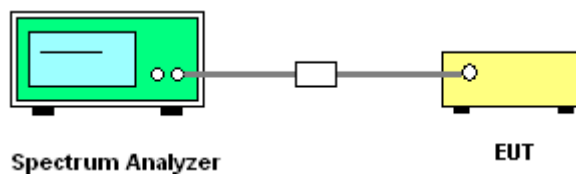



### 3.7.5 Test Result of Conducted Spurious Emission

Test Mode :	1Mbps	Temperature :	24~26°C
Test Channel :	00	Relative Humidity :	48~51%
		Test Engineer :	Osolemio Chang

1Mbps CSE Plot on Ch 00 between 30MHz ~ 3 GHz

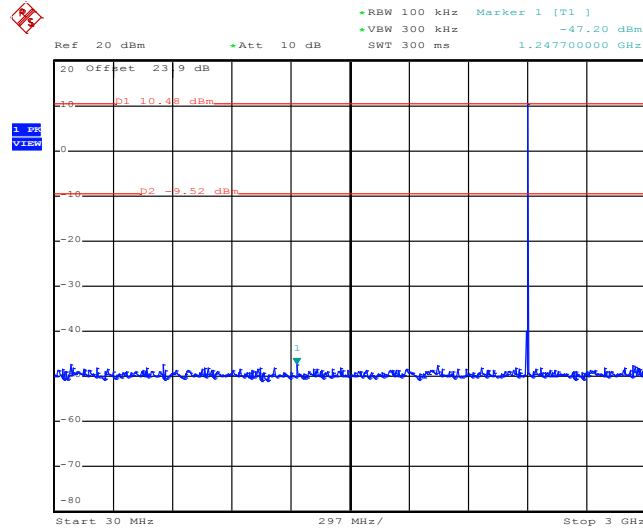

Date: 9.FEB.2016 14:32:50

1Mbps CSE Plot on Ch 00 between 2 GHz ~ 25 GHz

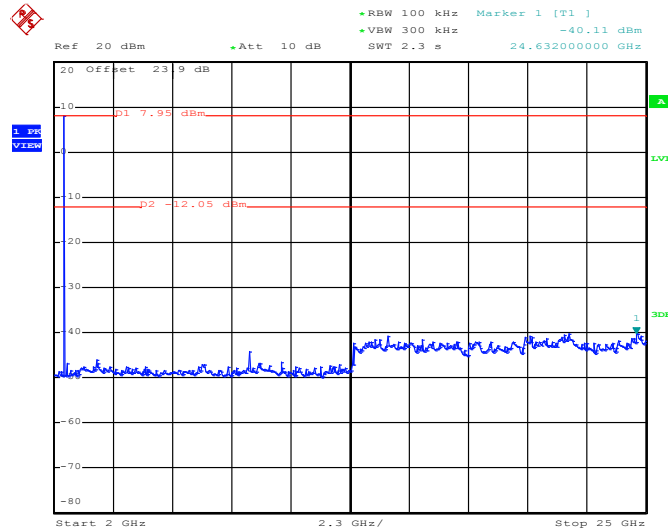

Date: 9.FEB.2016 14:33:12



Test Mode :	1Mbps	Temperature :	24~26°C
Test Channel :	39	Relative Humidity :	48~51%
		Test Engineer :	Osolemio Chang

1Mbps CSE Plot on Ch 39 between 30MHz ~ 3 GHz

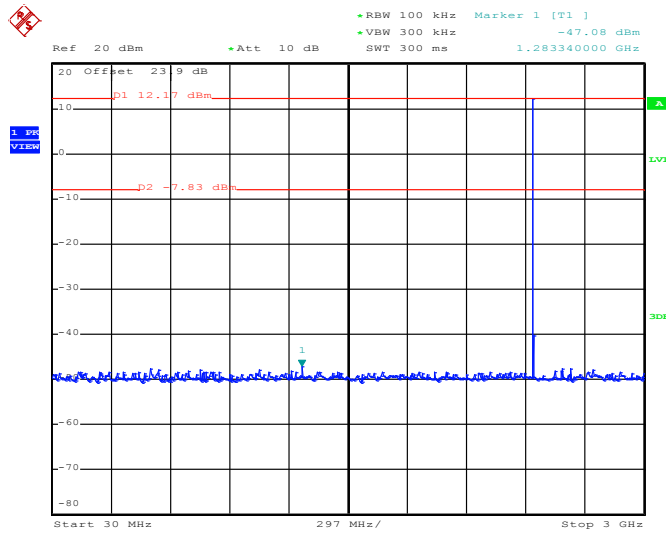

Date: 9.FEB.2016 14:38:11

1Mbps CSE Plot on Ch 39 between 2 GHz ~ 25 GHz

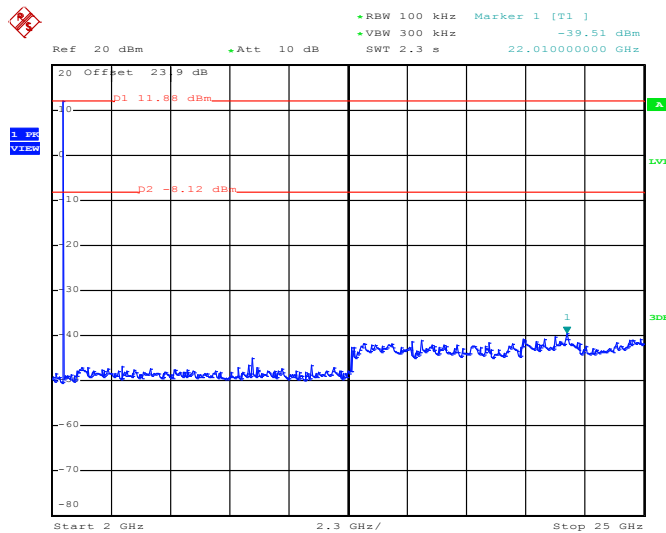

Date: 9.FEB.2016 14:38:33



Test Mode :	1Mbps	Temperature :	24~26°C
Test Channel :	78	Relative Humidity :	48~51%
		Test Engineer :	Osolemio Chang

1Mbps CSE Plot on Ch 78 between 30MHz ~ 3 GHz

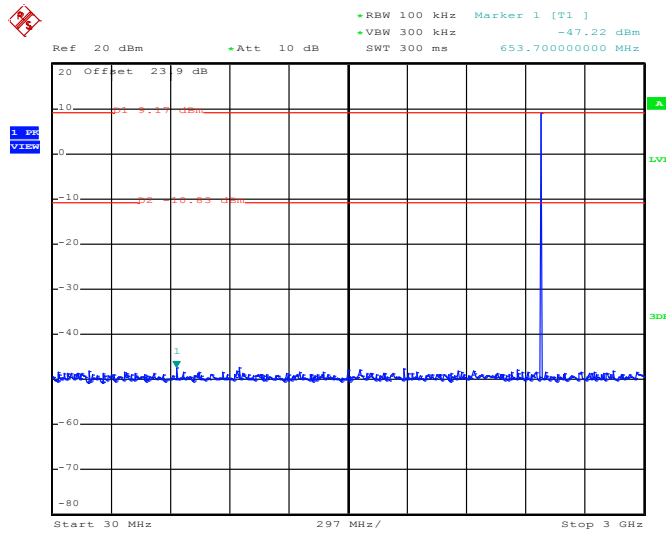

Date: 9.FEB.2016 14:43:33

1Mbps CSE Plot on Ch 78 between 2 GHz ~ 25 GHz

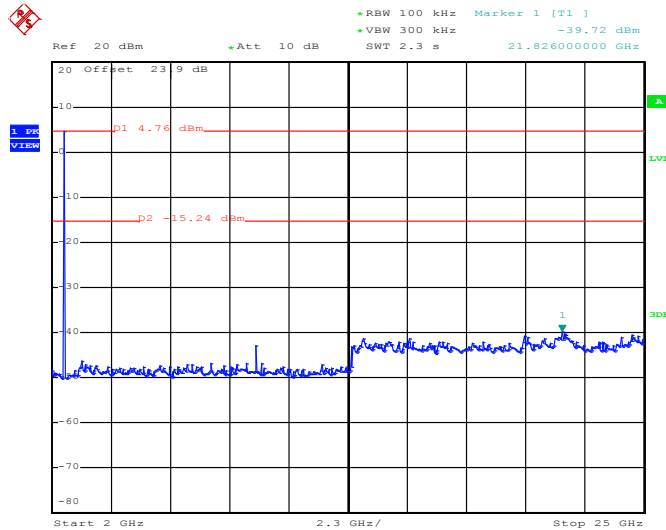

Date: 9.FEB.2016 14:43:55



Test Mode :	2Mbps	Temperature :	24~26°C
Test Channel :	00	Relative Humidity :	48~51%
		Test Engineer :	Osolemio Chang

2Mbps CSE Plot on Ch 00 between 30MHz ~ 3 GHz

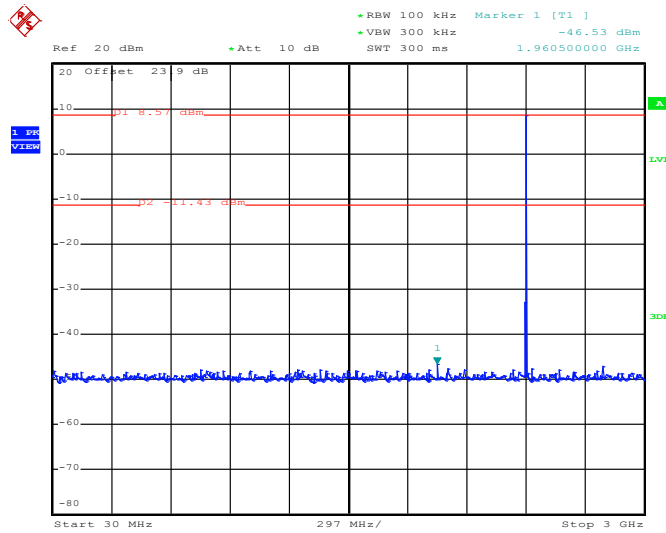

Date: 9.FEB.2016 14:47:58

2Mbps CSE Plot on Ch 00 between 2 GHz ~ 25 GHz

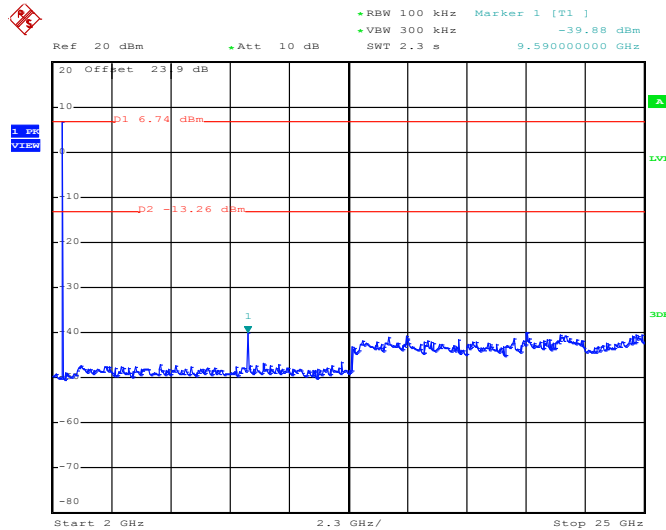

Date: 9.FEB.2016 14:48:20



Test Mode :	2Mbps	Temperature :	24~26°C
Test Channel :	39	Relative Humidity :	48~51%
		Test Engineer :	Osolemio Chang

2Mbps CSE Plot on Ch 39 between 30MHz ~ 3 GHz

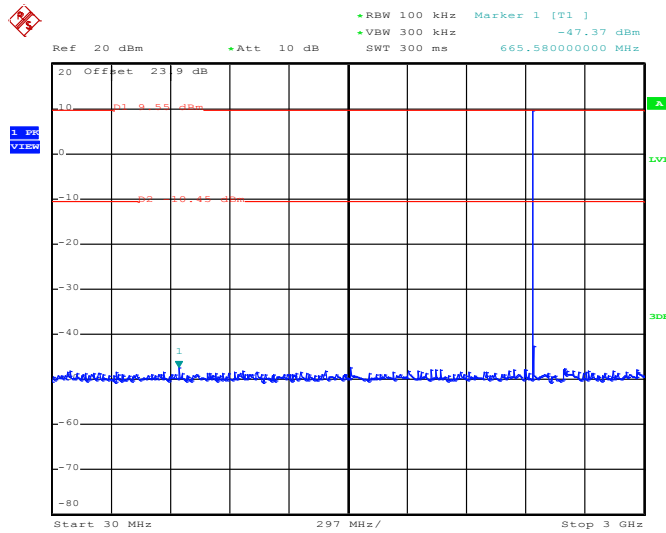

Date: 9.FEB.2016 14:51:02

2Mbps CSE Plot on Ch 39 between 2 GHz ~ 25 GHz

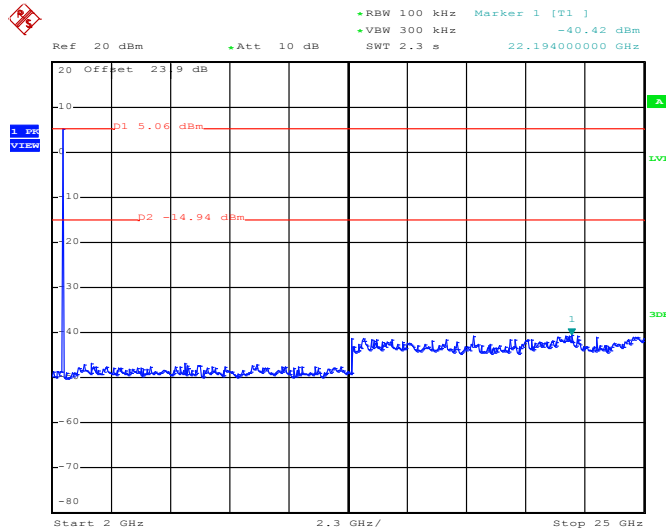

Date: 9.FEB.2016 14:51:24



Test Mode :	2Mbps	Temperature :	24~26°C
Test Channel :	78	Relative Humidity :	48~51%
		Test Engineer :	Osolemio Chang

2Mbps CSE Plot on Ch 78 between 30MHz ~ 3 GHz

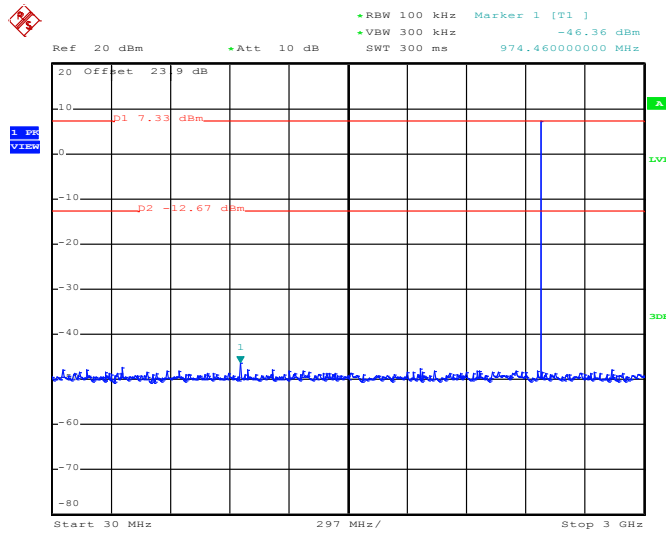

Date: 9.FEB.2016 14:54:06

2Mbps CSE Plot on Ch 78 between 2 GHz ~ 25 GHz

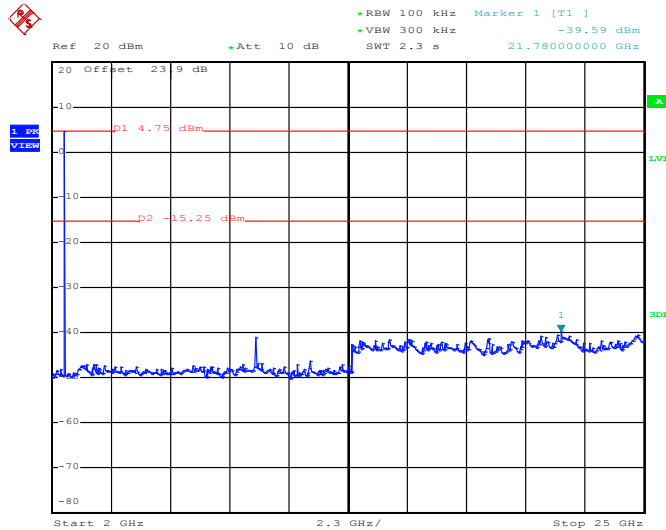

Date: 9.FEB.2016 14:54:28



Test Mode :	3Mbps	Temperature :	24~26°C
Test Channel :	00	Relative Humidity :	48~51%
		Test Engineer :	Osolemio Chang

3Mbps CSE Plot on Ch 00 between 30MHz ~ 3 GHz

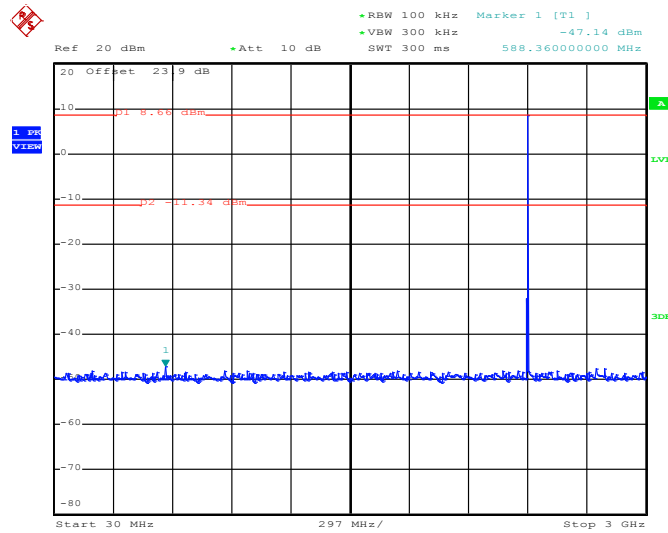

Date: 9.FEB.2016 14:58:03

3Mbps CSE Plot on Ch 00 between 2 GHz ~ 25 GHz

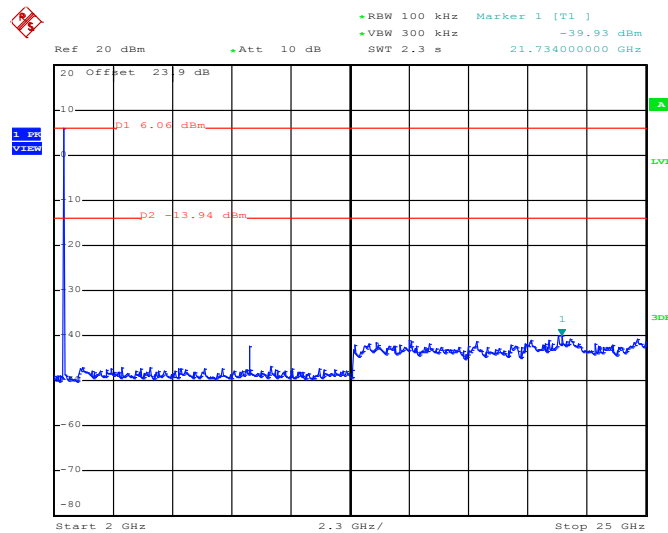

Date: 9.FEB.2016 14:58:24



Test Mode :	3Mbps	Temperature :	24~26°C
Test Channel :	39	Relative Humidity :	48~51%
		Test Engineer :	Osolemio Chang

3Mbps CSE Plot on Ch 39 between 30MHz ~ 3 GHz

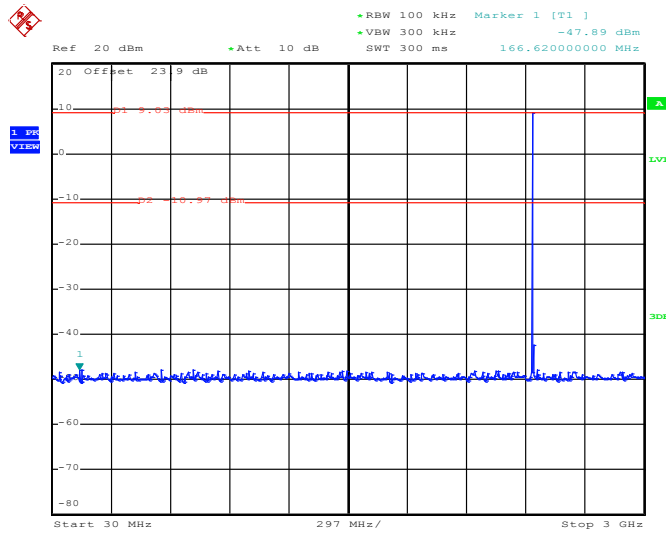

Date: 9.FEB.2016 15:03:14

3Mbps CSE Plot on Ch 39 between 2 GHz ~ 25 GHz

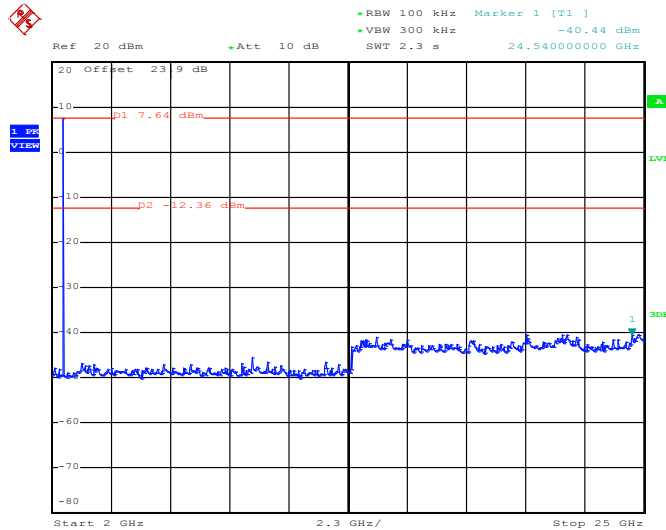

Date: 9.FEB.2016 15:03:36



Test Mode :	3Mbps	Temperature :	24~26°C
Test Channel :	78	Relative Humidity :	48~51%
		Test Engineer :	Osolemio Chang

3Mbps CSE Plot on Ch 78 between 30MHz ~ 3 GHz

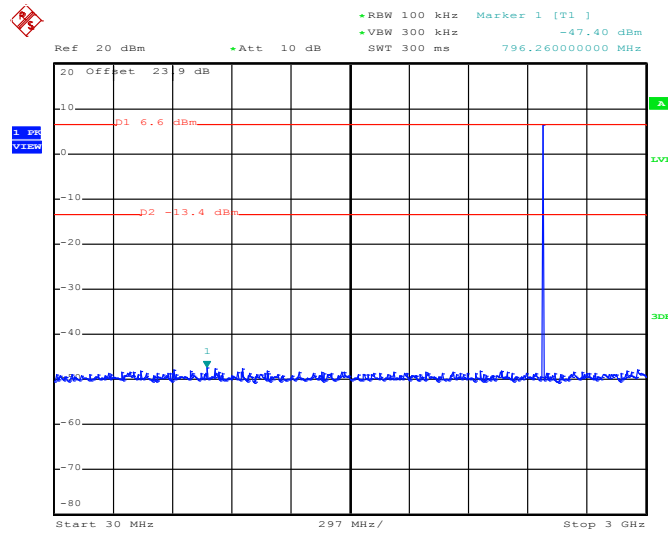

Date: 9.FEB.2016 15:09:00

3Mbps CSE Plot on Ch 78 between 2 GHz ~ 25 GHz

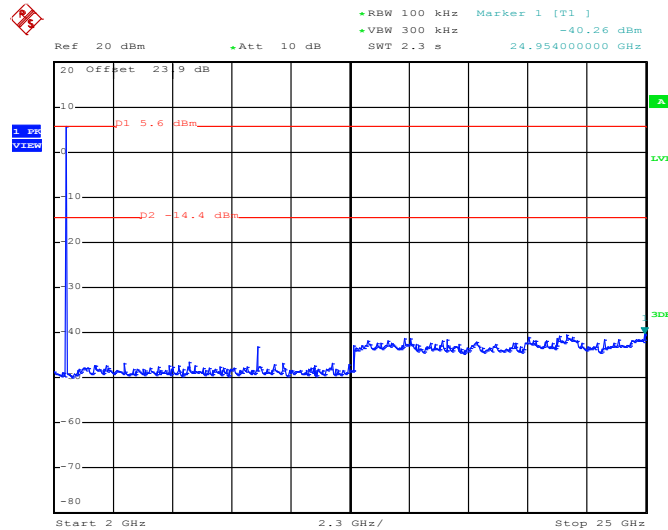

Date: 9.FEB.2016 15:09:22



### 3.8 Radiated Band Edges and Spurious Emission Measurement

#### 3.8.1 Limit of Radiated Band Edges and Spurious Emission

In any 100 kHz bandwidth outside the intentional radiator frequency band, all harmonics/spurious must be at least 20 dB below the highest emission level within the authorized band. In addition, radiated emissions which fall in the restricted bands must also comply with the FCC section 15.209 limits as below.

Frequency (MHz)	Field Strength (microvolts/meter)	Measurement Distance (meters)
0.009 – 0.490	2400/F(kHz)	300
0.490 – 1.705	24000/F(kHz)	30
1.705 – 30.0	30	30
30 – 88	100	3
88 – 216	150	3
216 - 960	200	3
Above 960	500	3

#### 3.8.2 Measuring Instruments

The measuring equipment is listed in the section 4 of this test report.



### 3.8.3 Test Procedures

1. The EUT was placed on a turntable with 0.8 meter for frequency below 1GHz and 1.5 meter for frequency above 1GHz respectively above ground.
2. The EUT was set 3 meters from the interference receiving antenna, which was mounted on the top of a variable height antenna tower.
3. For each suspected emission, the EUT was arranged to its worst case and then tune the Antenna tower (from 1 m to 4 m) and turntable (from 0 degree to 360 degrees) to find the maximum reading. A pre-amp and a high pass filter are used for the test in order to get better signal level to comply with the guidelines.
4. Set to the maximum power setting and enable the EUT transmit continuously.
5. Use the following spectrum analyzer settings:
  - (1) Span shall wide enough to fully capture the emission being measured;
  - (2) Set RBW=100 kHz for  $f < 1 \text{ GHz}$ , RBW=1MHz for  $f > 1\text{GHz}$  ; VBW  $\geq$  RBW; Sweep = auto; Detector function = peak; Trace = max hold for peak
  - (3) For average measurement: use duty cycle correction factor method per 15.35(c).  
Duty cycle = On time/100 milliseconds  
On time =  $N_1 * L_1 + N_2 * L_2 + \dots + N_{n-1} * L_{n-1} + N_n * L_n$   
Where  $N_1$  is number of type 1 pulses,  $L_1$  is length of type 1 pulses, etc.  
Average Emission Level = Peak Emission Level +  $20 * \log(\text{Duty cycle})$
6. Corrected Reading: Antenna Factor + Cable Loss + Read Level - Preamp Factor = Level

Note: The average levels were calculated from the peak level corrected with duty cycle correction factor (24.79dB) derived from  $20 \log (\text{dwell time}/100\text{ms})$ . This correction is only for signals that hop with the fundamental signal, such as band-edge and harmonic. Other spurious signals that are independent of the hopping signal would not use this correction.

### 3.8.4 Test Setup

For radiated emissions below 30MHz

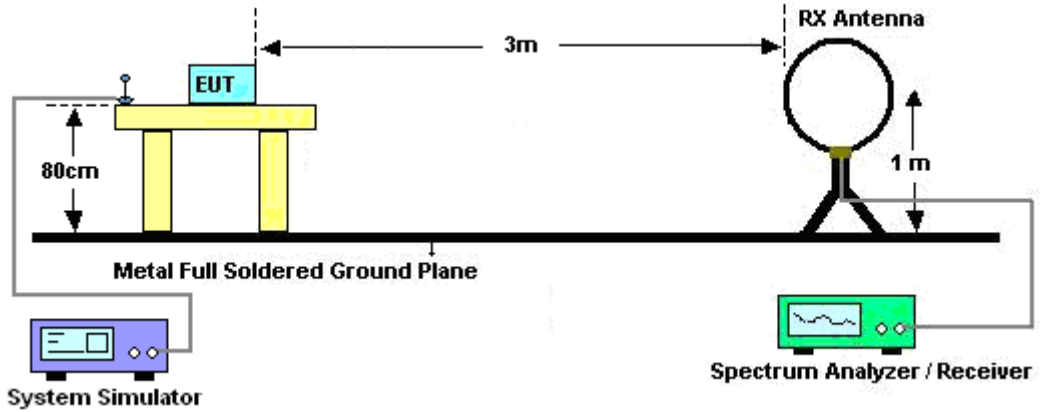

For radiated emissions from 30MHz to 1GHz

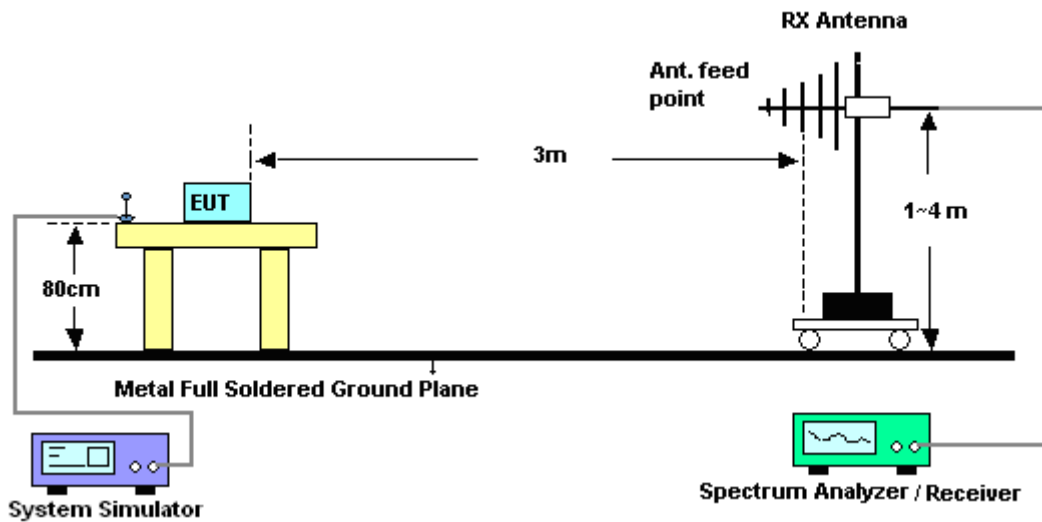

For radiated emissions above 1GHz

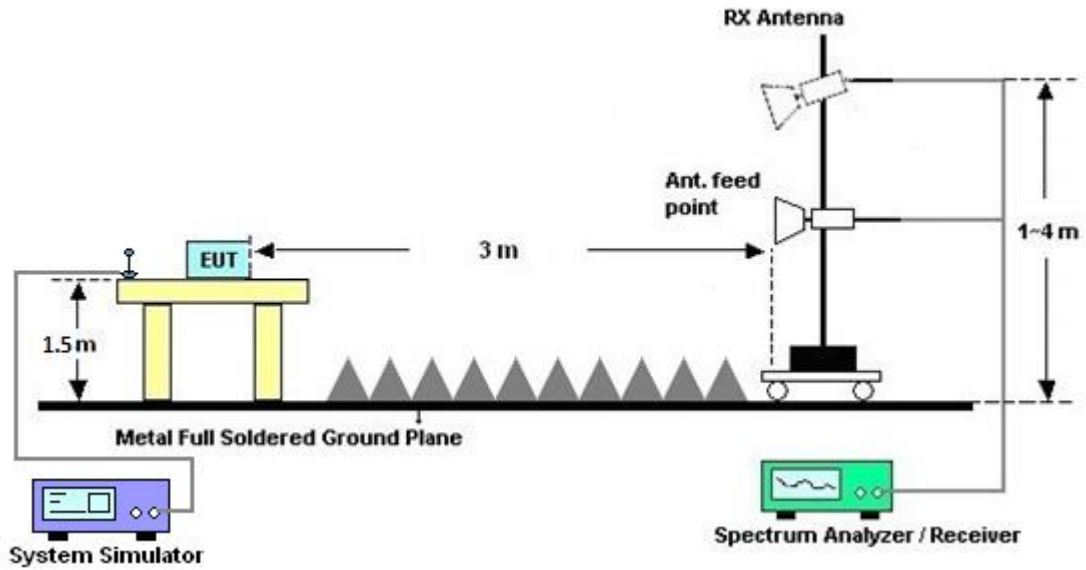

### 3.8.5 Test Results of Radiated Spurious Emissions (9 kHz ~ 30 MHz)

The low frequency, which started from 9 kHz to 30MHz, was pre-scanned and the result which was 20dB lower than the limit line per 15.31(o) was not reported.



### 3.8.6 Duty cycle correction factor for average measurement

3DH5 on time (One Pulse) Plot on Channel 39

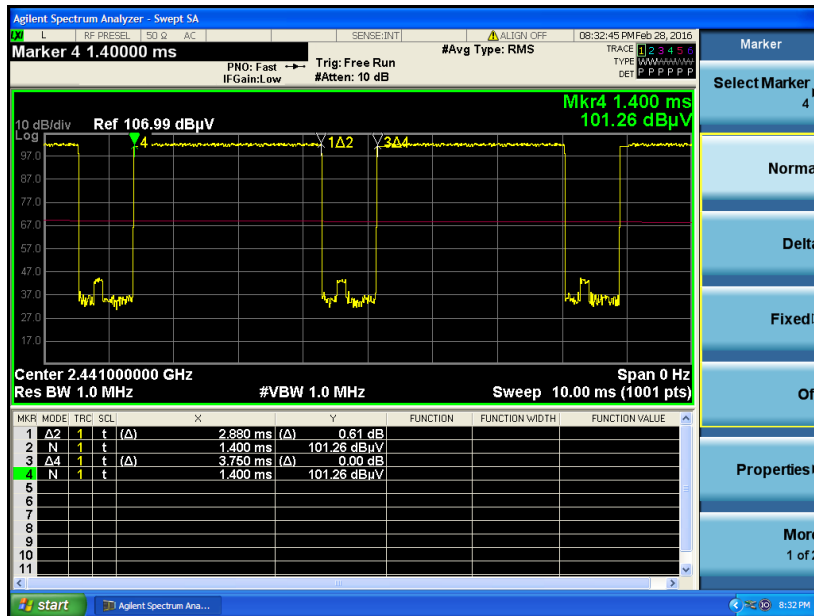

3DH5 on time (Count Pulses) Plot on Channel 39

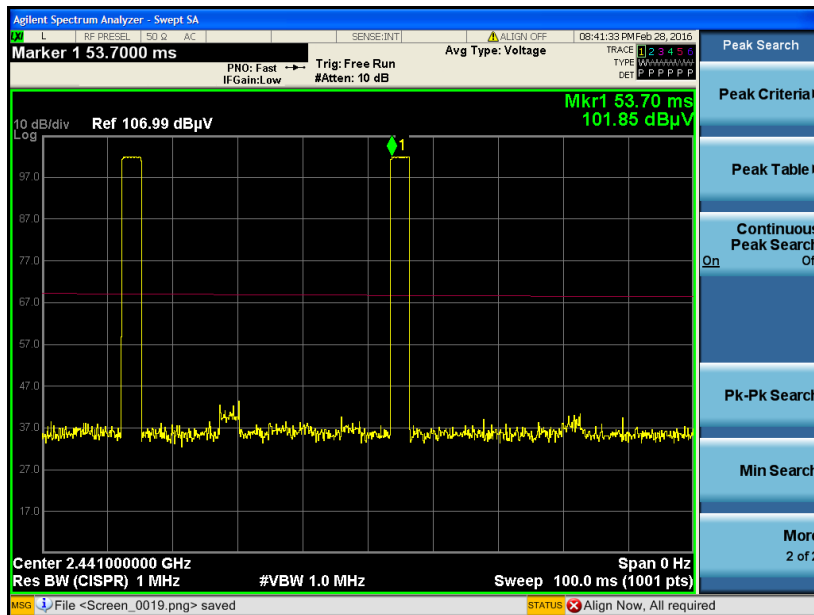

**Note:**

1. Worst case Duty cycle = on time/100 milliseconds = 2 \* 2.88 / 100 = 5.76 %
2. Worst case Duty cycle correction factor = 20\*log(Duty cycle) = -24.79 dB
3. 3DH5 has the highest duty cycle worst case and is reported.



**Duty Cycle Correction Factor Consideration for AFH mode:**

Bluetooth normal hopping rate is 1600Hz and reduced to 800Hz in AFH mode; due to the reduced number of hopping frequencies, with the same packet configuration the dwell time in each channel frequency within 100msec period is longer in AFH mode than normal mode.

In AFH mode, the minimum hopping frequencies are 20, to get the longest dwell time DH5 packet is observed; the period to have DH5 packet completing one hopping sequence is

$$2.88 \text{ ms} \times 20 \text{ channels} = 57.6 \text{ ms}$$

There cannot be 2 complete hopping sequences within 100ms period, considering the random hopping behavior, maximum 2 hops can be possibly observed within the period.  $[100\text{ms} / 57.6\text{ms}] = 2 \text{ hops}$

Thus, the maximum possible ON time:

$$2.88 \text{ ms} \times 2 = 5.76 \text{ ms}$$

Worst case Duty Cycle Correction factor, which is derived from the maximum possible ON time,

$$20 \times \log(5.76 \text{ ms}/100\text{ms}) = -24.79 \text{ dB}$$

**3.8.7 Test Result of Radiated Spurious at Band Edges**

Please refer to Appendix A and B.

**3.8.8 Test Result of Radiated Spurious Emission (30MHz ~ 10<sup>th</sup> Harmonic)**

Please refer to Appendix A and B.



### 3.9 AC Conducted Emission Measurement

#### 3.9.1 Limit of AC Conducted Emission

For equipment that is designed to be connected to the public utility (AC) power line, the radio frequency voltage that is conducted back onto the AC power line on any frequency or frequencies within the band 150 kHz to 30 MHz shall not exceed the limits in the following table.

Frequency of emission (MHz)	Conducted limit (dBµV)	
	Quasi-peak	Average
0.15-0.5	66 to 56*	56 to 46*
0.5-5	56	46
5-30	60	50

\*Decreases with the logarithm of the frequency.

#### 3.9.2 Measuring Instruments

The measuring equipment is listed in the section 4 of this test report.

#### 3.9.3 Test Procedures

1. The EUT was placed 0.4 meter from the conducting wall of the shielding room was kept at least 80 centimeters from any other grounded conducting surface.
2. Connect EUT to the power mains through a line impedance stabilization network (LISN).
3. All the support units are connecting to the other LISN.
4. The LISN provides 50 ohm coupling impedance for the measuring instrument.
5. The FCC states that a 50 ohm, 50 microhenry LISN should be used.
6. Both sides of AC line were checked for maximum conducted interference.
7. The frequency range from 150 kHz to 30 MHz was searched.
8. Set the test-receiver system to Peak Detect Function and specified bandwidth (IF Bandwidth = 9kHz) with Maximum Hold Mode. Then measurement is also conducted by Average Detector and Quasi-Peak Detector Function respectively.

### 3.9.4 Test Setup

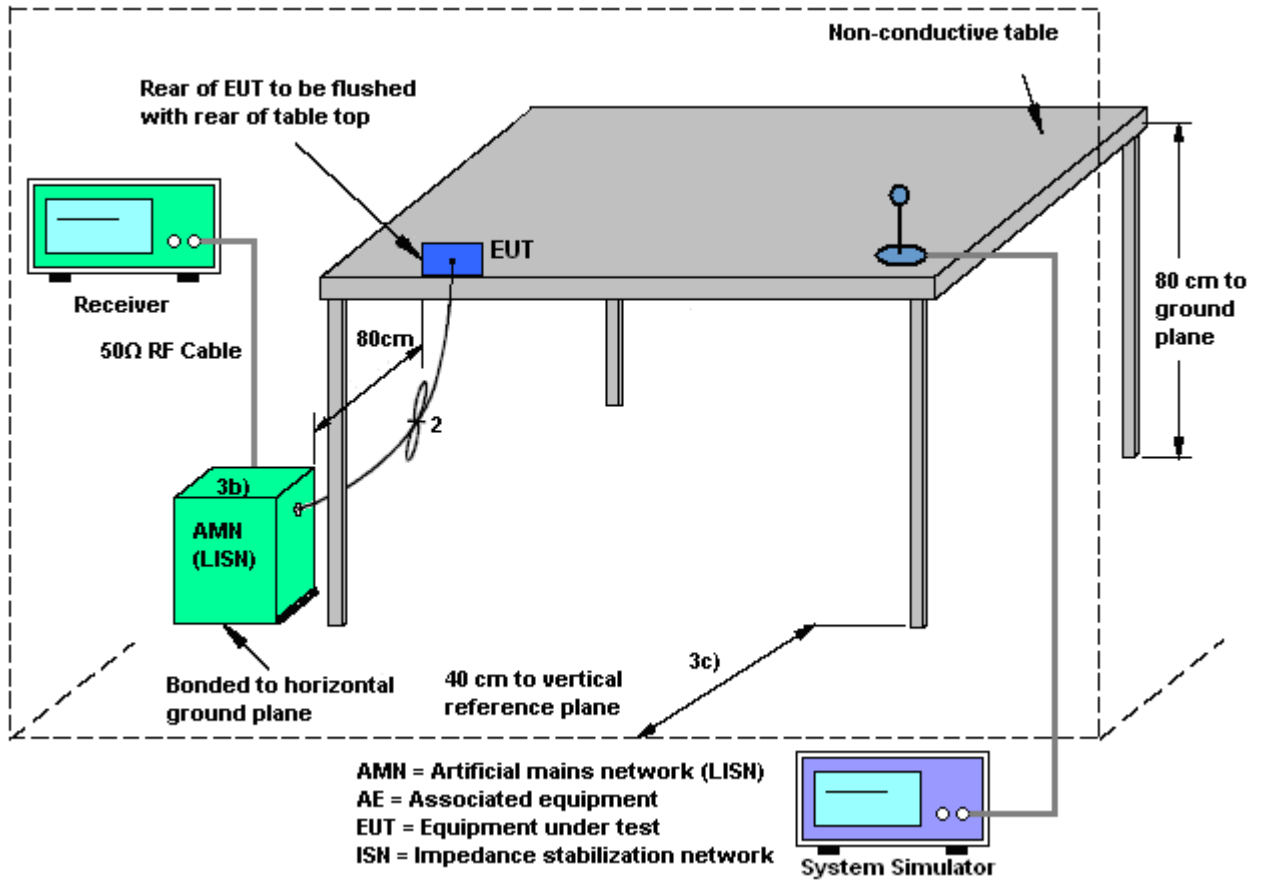



### 3.9.5 Test Result of AC Conducted Emission

Test Mode :	Mode 1	Temperature :	23~24°C
Test Engineer :	Kai-Chun Chu	Relative Humidity :	48~49%
Test Voltage :	120Vac / 60Hz	Phase :	Line
Function Type :	GSM850 Idle + Bluetooth Link + WLAN (2.4GHz) Link + Earphone + MP3 + USB Cable (Charging from Adapter)		

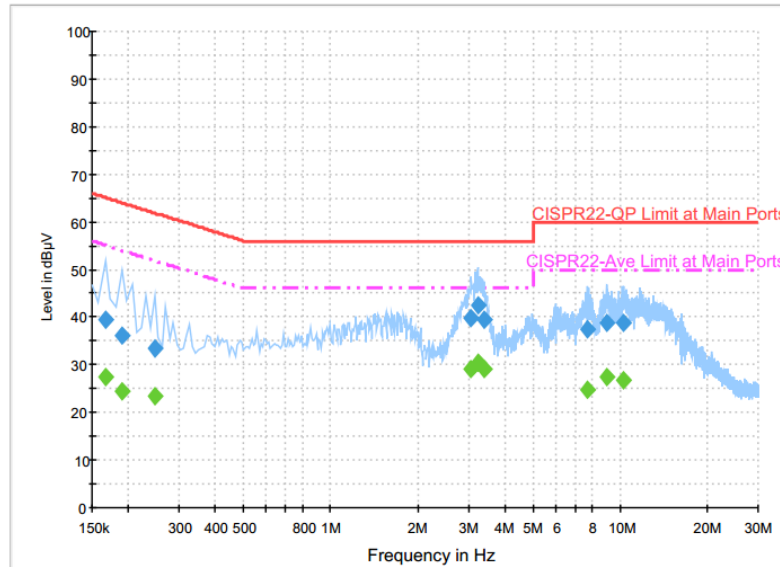

#### Final Result : Quasi-Peak

Frequency (MHz)	Quasi-Peak (dBµV)	Filter	Line	Corr. (dB)	Margin (dB)	Limit (dBµV)
0.166000	39.6	Off	L1	19.6	25.6	65.2
0.190000	36.2	Off	L1	19.6	27.8	64.0
0.246000	33.4	Off	L1	19.6	28.5	61.9
3.062000	39.9	Off	L1	19.6	16.1	56.0
3.222000	42.6	Off	L1	19.6	13.4	56.0
3.398000	39.3	Off	L1	19.6	16.7	56.0
7.710000	37.4	Off	L1	19.7	22.6	60.0
8.966000	38.7	Off	L1	19.7	21.3	60.0
10.302000	38.7	Off	L1	19.7	21.3	60.0

#### Final Result : Average

Frequency (MHz)	Average (dBµV)	Filter	Line	Corr. (dB)	Margin (dB)	Limit (dBµV)
0.166000	27.3	Off	L1	19.6	27.9	55.2
0.190000	24.4	Off	L1	19.6	29.6	54.0
0.246000	23.3	Off	L1	19.6	28.6	51.9
3.062000	29.0	Off	L1	19.6	17.0	46.0
3.222000	30.3	Off	L1	19.6	15.7	46.0
3.398000	29.2	Off	L1	19.6	16.8	46.0
7.710000	24.8	Off	L1	19.7	25.2	50.0
8.966000	27.3	Off	L1	19.7	22.7	50.0
10.302000	26.9	Off	L1	19.7	23.1	50.0



Test Mode :	Mode 1	Temperature :	23~24°C
Test Engineer :	Kai-Chun Chu	Relative Humidity :	48~49%
Test Voltage :	120Vac / 60Hz	Phase :	Neutral
Function Type :	GSM850 Idle + Bluetooth Link + WLAN (2.4GHz) Link + Earphone + MP3 + USB Cable (Charging from Adapter)		

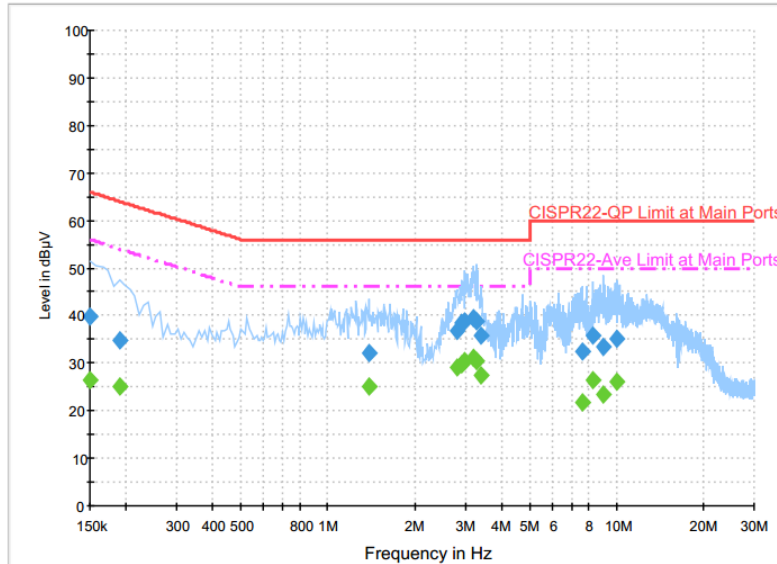

Final Result : Quasi-Peak

Frequency (MHz)	Quasi-Peak (dBµV)	Filter	Line	Corr. (dB)	Margin (dB)	Limit (dBµV)
0.150000	39.9	Off	N	19.6	26.1	66.0
0.190000	34.9	Off	N	19.6	29.1	64.0
1.390000	32.2	Off	N	19.6	23.8	56.0
2.798000	36.9	Off	N	19.5	19.1	56.0
2.910000	38.4	Off	N	19.5	17.6	56.0
2.982000	38.8	Off	N	19.5	17.2	56.0
3.190000	39.4	Off	N	19.6	16.6	56.0
3.278000	38.8	Off	N	19.6	17.2	56.0
3.398000	35.6	Off	N	19.6	20.4	56.0
7.614000	32.6	Off	N	19.7	27.4	60.0
8.318000	35.6	Off	N	19.7	24.4	60.0
9.038000	33.3	Off	N	19.8	26.7	60.0
10.086000	35.1	Off	N	19.8	24.9	60.0



Test Mode :	Mode 1	Temperature :	23~24°C
Test Engineer :	Kai-Chun Chu	Relative Humidity :	48~49%
Test Voltage :	120Vac / 60Hz	Phase :	Neutral
Function Type :	GSM850 Idle + Bluetooth Link + WLAN (2.4GHz) Link + Earphone + MP3 + USB Cable (Charging from Adapter)		

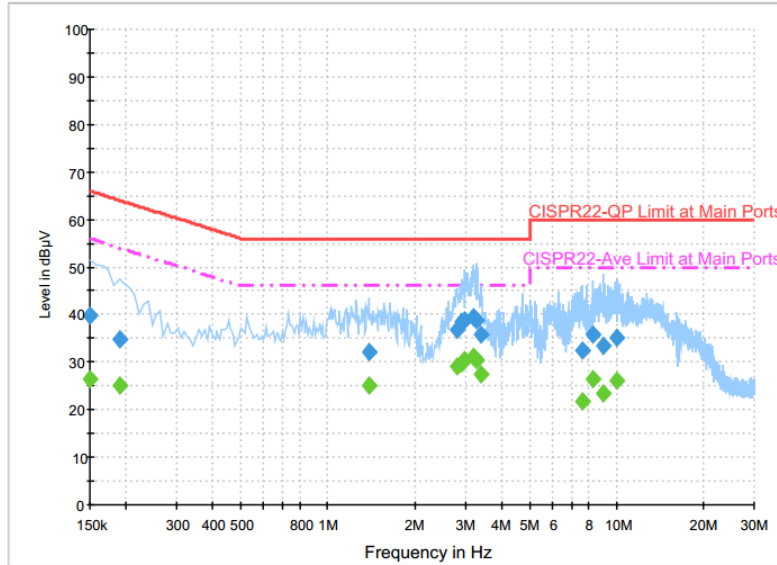

Final Result : Average

Frequency (MHz)	Average (dBµV)	Filter	Line	Corr. (dB)	Margin (dB)	Limit (dBµV)
0.150000	26.4	Off	N	19.6	29.6	56.0
0.190000	24.9	Off	N	19.6	29.1	54.0
1.390000	25.1	Off	N	19.6	20.9	46.0
2.798000	28.9	Off	N	19.5	17.1	46.0
2.910000	29.9	Off	N	19.5	16.1	46.0
2.982000	30.5	Off	N	19.5	15.5	46.0
3.190000	31.0	Off	N	19.6	15.0	46.0
3.278000	30.3	Off	N	19.6	15.7	46.0
3.398000	27.3	Off	N	19.6	18.7	46.0
7.614000	21.7	Off	N	19.7	28.3	50.0
8.318000	26.4	Off	N	19.7	23.6	50.0
9.038000	23.3	Off	N	19.8	26.7	50.0
10.086000	26.2	Off	N	19.8	23.8	50.0



## **3.10 Antenna Requirements**

### **3.10.1 Standard Applicable**

If directional gain of transmitting antennas is greater than 6dBi, the power shall be reduced by the same level in dB comparing to gain minus 6dBi. The use of a permanently attached antenna or of an antenna that uses a unique coupling to the intentional radiator shall be considered sufficient to comply with the FCC rule.

### **3.10.2 Antenna Anti-Replacement Construction**

An embedded-in antenna design is used.

### **3.10.3 Antenna Gain**

The antenna peak gain of EUT is less than 6 dBi. Therefore, it is not necessary to reduce maximum peak output power limit.



## 4 List of Measuring Equipment

Instrument	Manufacturer	Model No.	Serial No.	Characteristics	Calibration Date	Test Date	Due Date	Remark
Power Meter	Agilent	E4416A	GB41292344	300MHz~40GHz	Jan. 08, 2016	Feb. 09, 2016 ~ Mar. 04, 2016	Jan. 07, 2017	Conducted (TH02-HY)
Power Sensor	Agilent	E9327A	US40441548	300MHz~40GHz	Jan. 07, 2016	Feb. 09, 2016 ~ Mar. 04, 2016	Jan. 06, 2017	Conducted (TH02-HY)
Spectrum Analyzer	Rohde & Schwarz	FSP40	100055	9kHz~40GHz	Jun. 18, 2015	Feb. 09, 2016 ~ Mar. 04, 2016	Jun. 17, 2016	Conducted (TH02-HY)
Bilog Antenna	TESEQ	CBL 6111D	35419	30MHz to 1GHz	Jan. 13, 2016	Feb. 22, 2016 ~ Mar. 02, 2016	Jan. 12, 2017	Radiation (03CH07-HY)
Double Ridge Horn Antenna	ESCO	3117	00075962	1GHz ~ 18GHz	Aug. 21, 2015	Feb. 22, 2016 ~ Mar. 02, 2016	Aug. 20, 2016	Radiation (03CH07-HY)
Loop Antenna	Rohde & Schwarz	HFH2-Z2	100315	9 kHz~30 MHz	Sep. 02, 2015	Feb. 22, 2016 ~ Mar. 02, 2016	Sep. 01, 2016	Radiation (03CH07-HY)
Preamplifier	MITEQ	AMF-7D-0010 1800-30-10P	1590075	1GHz ~ 18GHz	Apr. 20, 2015	Feb. 22, 2016 ~ Mar. 02, 2016	Apr. 19, 2016	Radiation (03CH07-HY)
Preamplifier	COM-POWER	PA-103A	161241	10MHz-1000MHz	Mar. 12, 2015	Feb. 22, 2016 ~ Mar. 02, 2016	Mar. 11, 2016	Radiation (03CH07-HY)
Preamplifier	Agilent	8449B	3008A02362	1GHz~ 26.5GHz	Oct. 19, 2015	Feb. 22, 2016 ~ Mar. 02, 2016	Oct. 18, 2016	Radiation (03CH07-HY)
EMI Test Receiver	Agilent	N9038A(MXE)	MY53290053	20Hz ~ 26.5GHz	Jan. 20, 2016	Feb. 22, 2016 ~ Mar. 02, 2016	Jan. 19, 2017	Radiation (03CH07-HY)
Spectrum Analyzer	Agilent	N9010A	MY53470118	10Hz~44GHz	Feb. 27, 2016	Feb. 28, 2016 ~ Mar. 02, 2016	Feb. 26, 2017	Radiation (03CH07-HY)
Spectrum Analyzer	Agilent	N9010A	MY53470118	10Hz~44GHz	Mar. 03, 2015	Feb. 22, 2016 ~ Feb. 26, 2016	Mar. 02, 2016	Radiation (03CH07-HY)
Antenna Mast	Max-Full	MFA520BS	N/A	1m~4m	N/A	Feb. 22, 2016 ~ Mar. 02, 2016	N/A	Radiation (03CH07-HY)
Turn Table	ChainTek	Chaintek 3000	N/A	0~360 degree	N/A	Feb. 22, 2016 ~ Mar. 02, 2016	N/A	Radiation (03CH07-HY)
SHF-EHF Horn Antenna	SCHWARZBECK	BBHA 9170	BBHA9170251	18GHz- 40GHz	Oct. 12, 2015	Feb. 22, 2016 ~ Mar. 02, 2016	Oct. 11, 2016	Radiation (03CH07-HY)
Preamplifier	MITEQ	JS44-180040 00-33-8P	1840917	18GHz ~ 40GHz	Jun. 02, 2015	Feb. 22, 2016 ~ Mar. 02, 2016	Jun. 01, 2016	Radiation (03CH07-HY)
AC Power Source	ChainTek	APC-1000W	N/A	N/A	N/A	Feb. 12, 2016	N/A	Conduction (CO05-HY)
EMI Test Receiver	Rohde & Schwarz	ESCI 7	100724	9kHz~7GHz	Aug. 26, 2015	Feb. 12, 2016	Aug. 25, 2016	Conduction (CO05-HY)
LISN	Rohde & Schwarz	ENV216	100080	9kHz~30MHz	Dec. 02, 2015	Feb. 12, 2016	Dec. 01, 2016	Conduction (CO05-HY)



## 5 Uncertainty of Evaluation

### Uncertainty of Conducted Emission Measurement (150 kHz ~ 30 MHz)

Measuring Uncertainty for a Level of Confidence of 95% ( $U = 2Uc(y)$ )	2.26
---	------

### Uncertainty of Radiated Emission Measurement (30 MHz ~ 1000 MHz)

Measuring Uncertainty for a Level of Confidence of 95% ( $U = 2Uc(y)$ )	4.80
---	------





## Appendix A. Radiated Spurious Emission

Test Engineer :	James Chiu, Jesse Wang, and Ken Wu	Temperature :	21~24°C
		Relative Humidity :	50~54%

2.4GHz 2400~2483.5MHz

BT (Band Edge @ 3m)

BT	Note	Frequency	Level	Over	Limit	Read	Antenna	Cable	Preamp	Ant	Table	Peak	Pol.	
		( MHz )	( dBμV/m )	( dB )	Limit Line ( dBμV/m )	( dBμV )	( dB/m )	( dB )	( dB )	( cm )	( deg )	Avg. (P/A)	(H/V)	
BT CH00 2402MHz		2381.5	46.11	-27.89	74	41	32.16	7.31	34.36	380	45	P	H	
		2381.5	21.32	-32.68	54	-	-	-	-	-	-	A	H	
	*	2402	102.03	-	-	96.86	32.18	7.31	34.32	380	45	P	H	
	*	2402	77.24	-	-	-	-	-	-	-	-	A	H	
													H	
														H
			2382.8	46.55	-27.45	74	41.44	32.16	7.31	34.36	112	271	P	V
			2382.8	21.76	-32.24	54	-	-	-	-	-	-	A	V
	*		2402	106.26	-	-	101.09	32.18	7.31	34.32	112	271	P	V
	*		2402	81.47	-	-	-	-	-	-	-	-	A	V
														V
														V
BT CH 39 2441MHz		2323.49	46.74	-27.26	74	41.91	32.09	7.18	34.44	375	140	P	H	
		2323.49	21.95	-32.05	54	-	-	-	-	-	-	A	H	
	*	2441	106.56	-	-	101.19	32.24	7.36	34.23	375	140	P	H	
	*	2441	81.77	-	-	-	-	-	-	-	-	A	H	
			2483.66	46.34	-27.66	74	40.85	32.28	7.4	34.19	375	140	P	H
			2483.66	21.55	-32.45	54	-	-	-	-	-	-	A	H
			2345.91	45.87	-28.13	74	40.92	32.11	7.24	34.4	119	271	P	V
			2345.91	21.08	-32.92	54	-	-	-	-	-	-	A	V
	*		2441	108.18	-	-	102.81	32.24	7.36	34.23	119	271	P	V
	*		2441	83.39	-	-	-	-	-	-	-	-	A	V
			2483.47	47.53	-26.47	74	42.04	32.28	7.4	34.19	119	271	P	V
			2483.47	22.74	-31.26	54	-	-	-	-	-	-	A	V



<b>BT CH 78 2480MHz</b>	*	2479.98	104.73	-	-	99.24	32.28	7.4	34.19	365	139	P	H
	*	2479.98	79.94	-	-	-	-	-	-	-	-	A	H
		2483.97	49.89	-24.11	74	44.4	32.28	7.4	34.19	365	139	P	H
		2483.97	25.1	-28.9	54	-	-	-	-	-	-	A	H
													H
													H
	*	2480	107.43	-	-	101.94	32.28	7.4	34.19	102	274	P	V
	*	2480	82.64	-	-	-	-	-	-	-	-	A	V
		2483.48	49.01	-24.99	74	43.52	32.28	7.4	34.19	102	274	P	V
		2483.48	24.22	-29.78	54	-	-	-	-	-	-	A	V
													V
													V
<b>Remark</b>	1. No other spurious found. 2. All results are PASS against Peak and Average limit line.												



2.4GHz 2400~2483.5MHz

BT (Harmonic @ 3m)

BT	Note	Frequency ( MHz )	Level ( dBµV/m )	Over Limit ( dB )	Limit Line ( dBµV/m )	Read Level ( dBµV )	Antenna Factor ( dB/m )	Cable Loss ( dB )	Preamp Factor ( dB )	Ant Pos ( cm )	Table Pos ( deg )	Peak Avg. ( P/A )	Pol. ( H/V )
BT CH 00 2402MHz		4806	41.52	-32.48	74	55.11	34.25	11.83	59.67	100	0	P	H
		4806	16.73	-37.27	54	-	-	-	-	-	-	A	H
													H
													H
		4806	40.46	-33.54	74	54.05	34.25	11.83	59.67	100	0	P	V
		4806	15.67	-38.33	54	-	-	-	-	-	-	A	V
													V
													V
BT CH 39 2441MHz		4884	40.39	-33.61	74	54.13	34.3	11.53	59.57	100	0	P	H
		4884	15.6	-38.4	54	-	-	-	-	-	-	A	H
		7320	41.15	-32.85	74	50.23	35.6	13.81	58.49	100	0	P	H
		7320	16.36	-37.64	54	-	-	-	-	-	-	A	H
		4884	38.6	-35.4	74	52.34	34.3	11.53	59.57	100	0	P	V
		4884	13.81	-40.19	54	-	-	-	-	-	-	A	V
		7320	40.51	-33.49	74	49.59	35.6	13.81	58.49	100	0	P	V
		7320	15.72	-38.28	54	-	-	-	-	-	-	A	V
BT CH 78 2480MHz		4962	40.42	-33.58	74	54.28	34.37	11.22	59.45	100	0	P	H
		4962	15.63	-38.37	54	-	-	-	-	-	-	A	H
		7440	40.45	-33.55	74	49.44	35.6	14.05	58.64	100	0	P	H
		7440	15.66	-38.34	54	-	-	-	-	-	-	A	H
		4962	39.49	-34.51	74	53.35	34.37	11.22	59.45	100	0	P	V
		4962	14.7	-39.3	54	-	-	-	-	-	-	A	V
		7440	40.39	-33.61	74	49.38	35.6	14.05	58.64	100	0	P	V
		7440	15.6	-38.4	54	-	-	-	-	-	-	A	V
Remark	1. No other spurious found. 2. All results are PASS against Peak and Average limit line.												



Emission below 1GHz

2.4GHz BT (LF)

BT	Note	Frequency	Level	Over	Limit	Read	Antenna	Cable	Preamp	Ant	Table	Peak	Pol.	
		( MHz )	( dBμV/m )	( dB )	( dBμV/m )	( dBμV )	( dB/m )	( dB )	( dB )	( cm )	( deg )	( P/A )	( H/V )	
2.4GHz BT LF		30	27.41	-12.59	40	31.84	26	1.07	31.5			P	H	
		100.74	34.98	-8.52	43.5	48.05	16.49	1.55	31.11			P	H	
		197.94	36.2	-7.3	43.5	49.53	15.9	1.87	31.1	100	0	P	H	
		427.4	24.98	-21.02	46	30.06	22.79	2.89	30.76			P	H	
		697.6	30.26	-15.74	46	30.64	26.37	3.65	30.4			P	H	
		903.4	32.54	-13.46	46	29.66	29.07	4.12	30.31			P	H	
													H	
													H	
													H	
													H	
													H	
													H	
			36.21	30.61	-9.39	40	38.1	22.72	1.07	31.28	100	0	P	V
			98.58	30.87	-12.63	43.5	44.42	16.27	1.28	31.1			P	V
			196.86	30.23	-13.27	43.5	43.61	15.85	1.87	31.1			P	V
			415.5	24.5	-21.5	46	30.03	22.62	2.67	30.82			P	V
			638.8	29.22	-16.78	46	30.38	25.79	3.57	30.52			P	V
			946.1	33.88	-12.12	46	30.09	30.11	4.07	30.39			P	V
													V	
													V	
												V		
												V		
												V		
												V		
Remark	1. No other spurious found. 2. All results are PASS against limit line.													



**Note symbol**

*	<b>Fundamental Frequency</b> which can be ignored. However, the level of any unwanted emissions shall not exceed the level of the fundamental frequency.
!	Test result is <b>over limit</b> line.
P/A	<b>Peak</b> or <b>Average</b>
H/V	<b>Horizontal</b> or <b>Vertical</b>



A calculation example for radiated spurious emission is shown as below:

WIFI	Note	Frequency	Level	Over	Limit	Read	Antenna	Cable	Preamp	Ant	Table	Peak	Pol.
Ant.				Limit	Line	Level	Factor	Loss	Factor	Pos	Pos	Avg.	
1+2		( MHz )	( dBμV/m )	( dB )	( dBμV/m )	( dBμV )	( dB/m )	( dB )	( dB )	( cm )	( deg )	( P/A )	( H/V )
802.11b		2390	55.45	-18.55	74	54.51	32.22	4.58	35.86	103	308	P	H
CH 01													
2412MHz		2390	43.54	-10.46	54	42.6	32.22	4.58	35.86	103	308	A	H

- Level(dBμV/m) =  
Antenna Factor(dB/m) + Cable Loss(dB) + Read Level(dBμV) - Preamp Factor(dB)
- Over Limit(dB) = Level(dBμV/m) – Limit Line(dBμV/m)

**For Peak Limit @ 2390MHz:**

- Level(dBμV/m)  
= Antenna Factor(dB/m) + Cable Loss(dB) + Read Level(dBμV) - Preamp Factor(dB)  
= 32.22(dB/m) + 4.58(dB) + 54.51(dBμV) – 35.86 (dB)  
= 55.45 (dBμV/m)
- Over Limit(dB)  
= Level(dBμV/m) – Limit Line(dBμV/m)  
= 55.45(dBμV/m) – 74(dBμV/m)  
= -18.55(dB)

**For Average Limit @ 2390MHz:**

- Level(dBμV/m)  
= Antenna Factor(dB/m) + Cable Loss(dB) + Read Level(dBμV) - Preamp Factor(dB)  
= 32.22(dB/m) + 4.58(dB) + 42.6(dBμV) – 35.86 (dB)  
= 43.54 (dBμV/m)
- Over Limit(dB)  
= Level(dBμV/m) – Limit Line(dBμV/m)  
= 43.54(dBμV/m) – 54(dBμV/m)  
= -10.46(dB)

**Both peak and average measured complies with the limit line, so test result is “PASS”.**



## Appendix B. Radiated Spurious Emission Plots

Test Engineer :	James Chiu, Jesse Wang, and Ken Wu	Temperature :	21~24°C
		Relative Humidity :	50~54%

2.4GHz 2400~2483.5MHz

BT (Band Edge @ 3m)

BT	2.4GHz 2400~2483.5MHz Band Edge @ 3m	
ANT	BT CH00 2402MHz	
1	Horizontal	Vertical
Peak	<p>Site : 03CH07.HY            Condition : FCC CLASS-B 3m HF-ANT, 138829 HORIZONTAL            : RBW:1000.000kHz VSW:3000.000kHz SWT:Auto            Detector : Peak</p>	<p>Site : 03CH07.HY            Condition : FCC CLASS-B 3m HF-ANT, 138829 VERTICAL            : RBW:1000.000kHz VSW:3000.000kHz SWT:Auto            Detector : Peak</p>

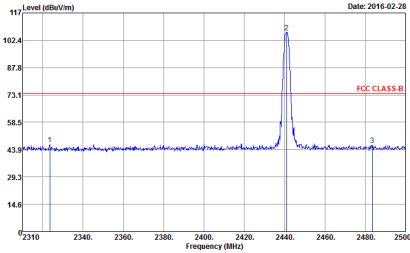
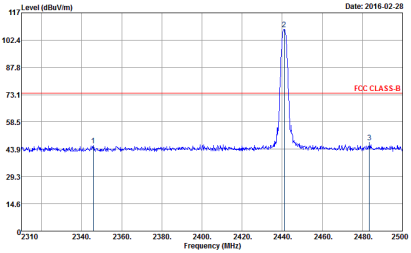

BT	2.4GHz 2400~2483.5MHz Band Edge @ 3m	
ANT	BT CH39 2441MHz	
1	Horizontal	Vertical
Peak	 <p data-bbox="347 904 592 949">Site : 03CH07-HY Condition : FCC CLASS-B 3m HF-ANT_130829 HORIZONTAL RBW: 1000.000kHz VBW: 3000.000kHz SWT: Auto Detector : Peak</p>	 <p data-bbox="944 904 1189 949">Site : 03CH07-HY Condition : FCC CLASS-B 3m HF-ANT_130829 VERTICAL RBW: 1000.000kHz VBW: 3000.000kHz SWT: Auto Detector : Peak</p>

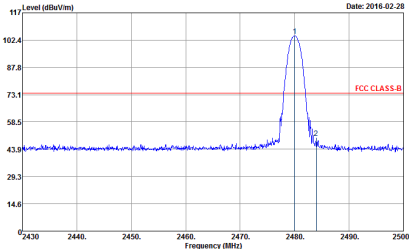
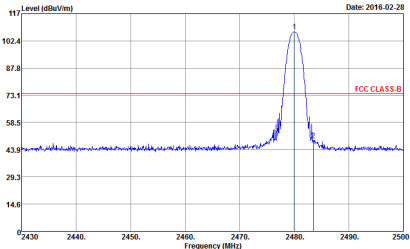

BT	2.4GHz 2400~2483.5MHz Band Edge @ 3m	
ANT	BT CH78 2480MHz	
1	Horizontal	Vertical
Peak	 <p data-bbox="347 902 592 947">Site : 03CH07-HY Condition : FCC CLASS-B 3m HF-ANT_130829 HORIZONTAL RBW:1000.000kHz VBW:3000.000kHz SVWT:Auto Detector : Peak</p>	 <p data-bbox="944 902 1189 947">Site : 03CH07-HY Condition : FCC CLASS-B 3m HF-ANT_130829 VERTICAL RBW:1000.000kHz VBW:3000.000kHz SVWT:Auto Detector : Peak</p>



2.4GHz 2400~2483.5MHz

BT (Harmonic @ 3m)

BT	2.4GHz 2400~2483.5MHz Harmonic @ 3m	
ANT	BT CH00 2402MHz	
1	Horizontal	Vertical
Peak Avg.	<p>Site : 03CH074Y Condition : FCC CLASS-B 3m SHF-EHF_131029 HORIZONTAL Detector : Peak</p>	<p>Site : 03CH074Y Condition : FCC CLASS-B 3m SHF-EHF_131029 VERTICAL Detector : Peak</p>



BT	2.4GHz 2400~2483.5MHz Harmonic @ 3m	
ANT	BT CH39 2441MHz	
1	Horizontal	Vertical
<p><b>Peak</b> <b>Avg.</b></p>	<p>Site : 03CM7-HY Condition : FCC CLASS-B 3m SHF-EHF_131029 HORIZONTAL Detector : Peak</p>	<p>Site : 03CM7-HY Condition : FCC CLASS-B 3m SHF-EHF_131029 VERTICAL Detector : Peak</p>



BT	2.4GHz 2400~2483.5MHz Harmonic @ 3m	
ANT	BT CH78 2480MHz	
1	Horizontal	Vertical
<p>Peak Avg.</p>	<p>Site : 03CH07-HY Condition : FCC CLASS-B 3m SHF-EHF_131029 HORIZONTAL Detector : Peak</p>	<p>Site : 03CH07-HY Condition : FCC CLASS-B 3m SHF-EHF_131029 VERTICAL Detector : Peak</p>



Emission below 1GHz

2.4GHz BT (LF)

BT	2.4GHz 2400~2483.5MHz	
ANT	BT LF	
1	Horizontal	Vertical
QP / Peak	<p>Horizontal plot details: Date: 2016-03-02 Site: 03CH074V Condition: FCC CLASS-B 3m LF-ANT:35419(6) HORIZONTAL Detector: Peak</p>	<p>Vertical plot details: Date: 2016-03-02 Site: 03CH074V Condition: FCC CLASS-B 3m LF-ANT:35419(6) VERTICAL Detector: Peak</p>