

Permanent Confidentiality Requested**Exhibit 5. Schematic Diagrams of the Transmitter Block – 47 CFR 2.1003(c)(10), and RSP100, Section 5.**

The transmitter schematics below illustrate the circuitry for frequency generation, determination, and stabilization, as well as modulation limiting, power control, and suppression of spurious emissions. To view text and component values zoom.

Key Content

Top level	Page 2
Main RF front end, Diversity RF front end, GPS antenna, Bluetooth/WiFi antenna	Page 4
Main antenna & tuner, Diversity antenna & tuner	Page 5
Bluetooth and WiFi transceiver front end	Page 10
Power Management, including RF clock generation	Page 36
3GPP transceiver RF connections	Page 43
GSM, WCDMA, LTE Main TX/RX RF Front End Switch	Page 47
GSM, WCDMA B1/B5/B8, LTE B1/B3/B5/B8 amplification	Page 48
LTE B40 amplification	Page 49
WCDMA B1/B5/B8, LTE B1/B3/B5/B8/B40 diversity/MIMO antenna front end	Page 52
GPS RF front end	Page 53

REVISIONS				
ZONE	LTR	DESCRIPTION	DATE	APPROVED

D

D

C

C

B

B

A

A

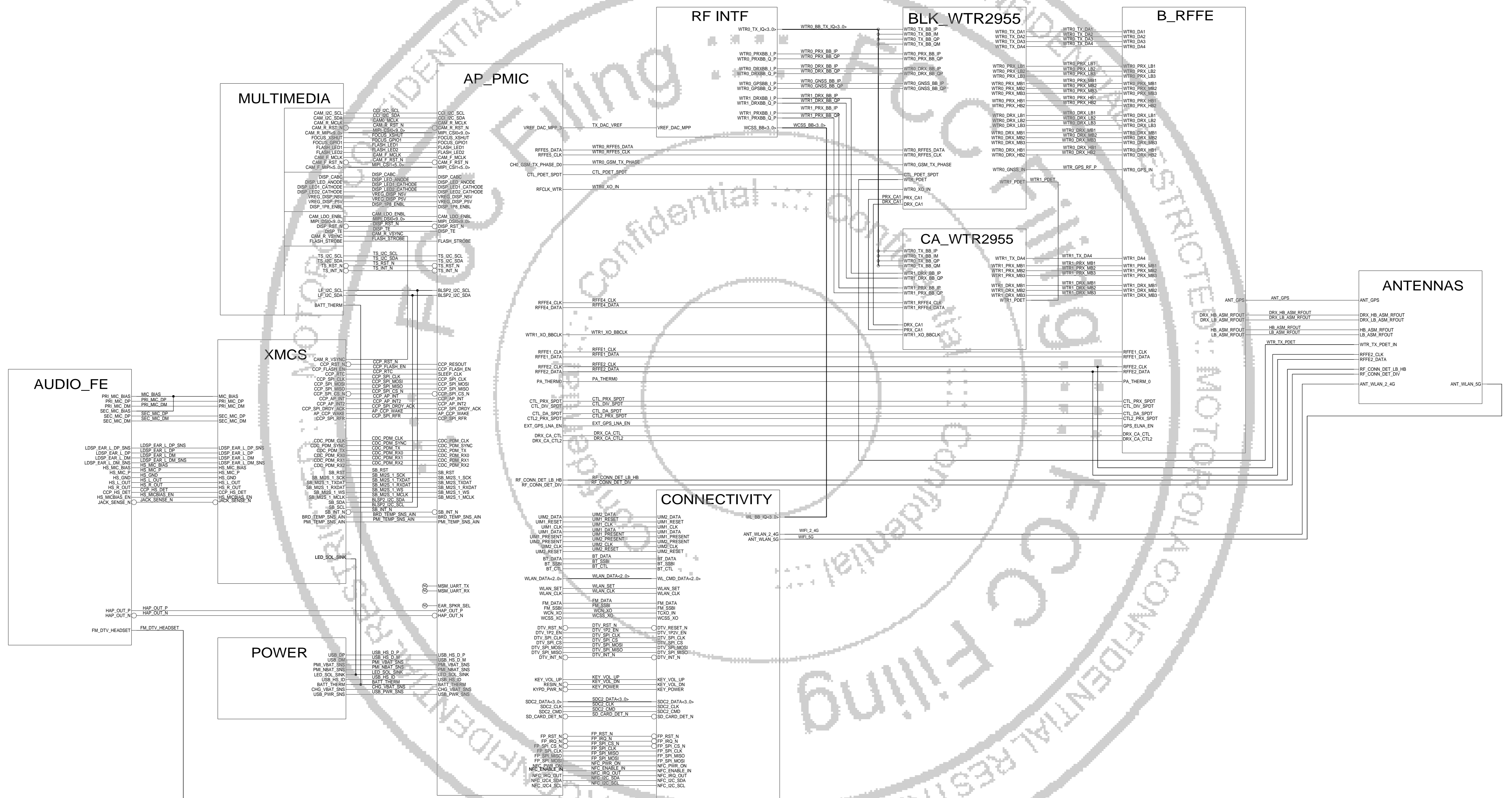

APPROVALS		MOTOROLA MOBILE DEVICES	
ENGINEER:		BLOCK TITLE:	
LAST MODIFIED BY:		PROJECT NAME:	
MOTOROLA CONFIDENTIAL RESTRICTED		D	REV
THE DRAWING ON THIS PRINT AND INFORMATION THEREON ARE PROPERTY OF MOTOROLA AND SHALL NOT BE USED OR DISCLOSED IN WHOLE OR IN PART WITHOUT MOTOROLA'S CONSENT. © COPYRIGHT, MOTOROLA, THIS DOES NOT APPLY TO PUBLICATIONS.		CAD FILE NAME:	

8 7 6 5 4 3 2 1

D

D

C

C

B

B

A

A

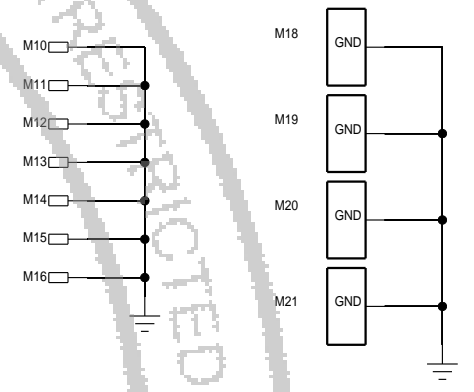
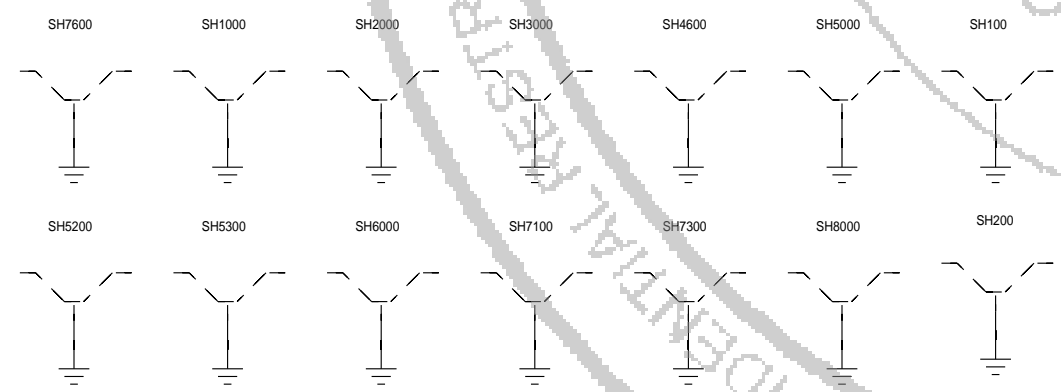

MOTOROLA CONFIDENTIAL RESTRICTED :: MOTOROLA CONFIDENTIAL RESTRICTED :: MOTOROLA CONFIDENTIAL RESTRICTED :: MOTOROLA CONFIDENTIAL RESTRICTED :: MOTOROLA CONFIDENTIAL RESTRICTED
 *** FCC Filing ***
 Confidential :: Confidential :: Confidential :: Confidential :: Confidential
 *** FCC Filing ***
 Confidential :: Confidential :: Confidential :: Confidential :: Confidential
 MOTOROLA CONFIDENTIAL RESTRICTED :: MOTOROLA CONFIDENTIAL RESTRICTED :: MOTOROLA CONFIDENTIAL RESTRICTED :: MOTOROLA CONFIDENTIAL RESTRICTED :: MOTOROLA CONFIDENTIAL RESTRICTED

APPROVALS		MOTOROLA MOBILE DEVICES	
ENGINEER:		BLOCK TITLE:	
LAST MODIFIED BY:			
MOTOROLA CONFIDENTIAL RESTRICTED <small>THE DRAWING ON THIS PRINT AND INFORMATION THEREWITH ARE PROPRIETARY TO MOTOROLA AND SHALL NOT BE USED OR DISCUSSED IN WHOLE OR IN PART WITHOUT MOTOROLA'S CONSENT. © COPYRIGHT, MOTOROLA. THIS DOES NOT IMPLY PUBLICATION</small>		PROJECT NAME	REV
		CAD FILE NAME:	

8 7 6 5 4 3 2 1

REVISIONS				
ZONE	LTR	DESCRIPTION	DATE	APPR.

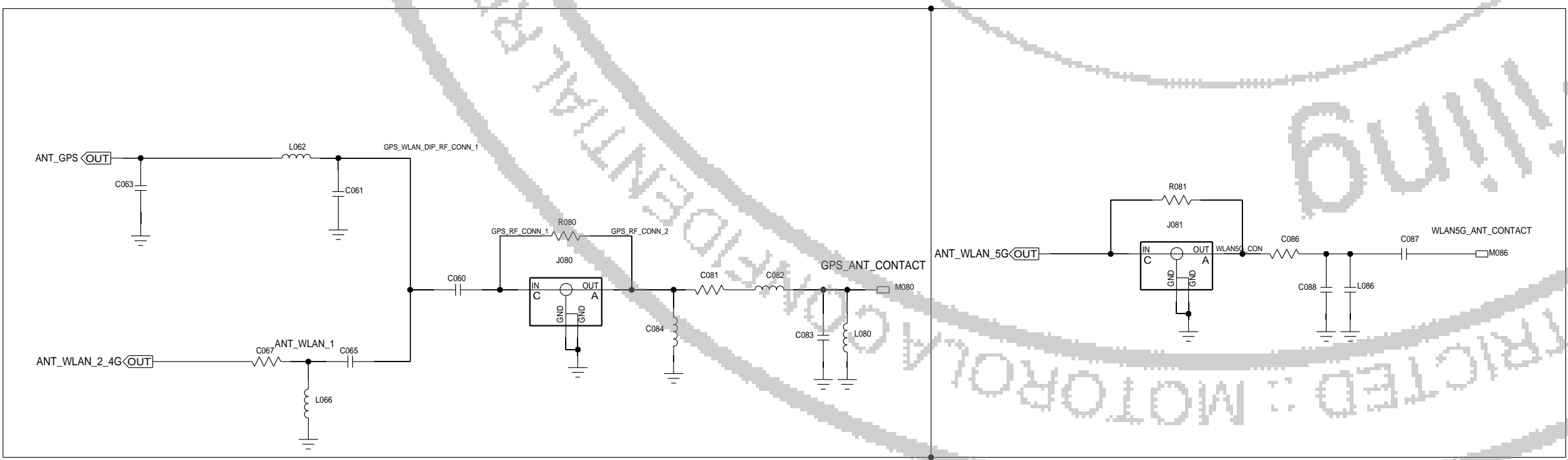
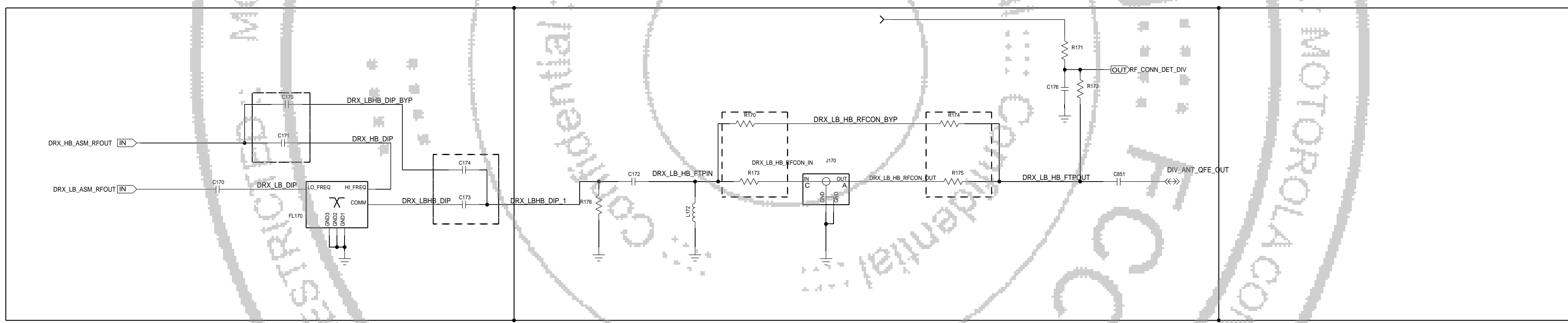
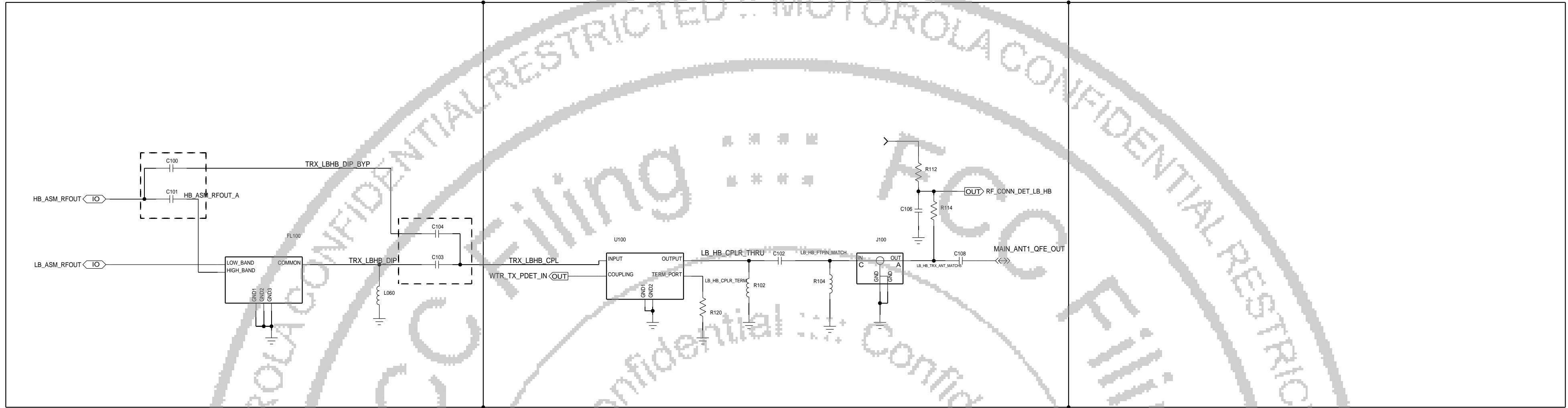

APPROVALS		MOTOROLA MOBILE DEVICES	
ENGINEER:	BLOCK TITLE:		
LAST MODIFIED BY:	PROJECT NAME		
MOTOROLA CONFIDENTIAL RESTRICTED THE DRAWING ON THIS PRINT AND INFORMATION THEREWITH ARE PROPRIETARY TO MOTOROLA AND SHALL NOT BE USED OR DISCUSSED IN WHOLE OR IN PART WITHOUT MOTOROLA'S CONSENT. © COPYRIGHT, MOTOROLA. THIS DOES NOT IMPLY PUBLICATION		CAD FILE NAME:	REV

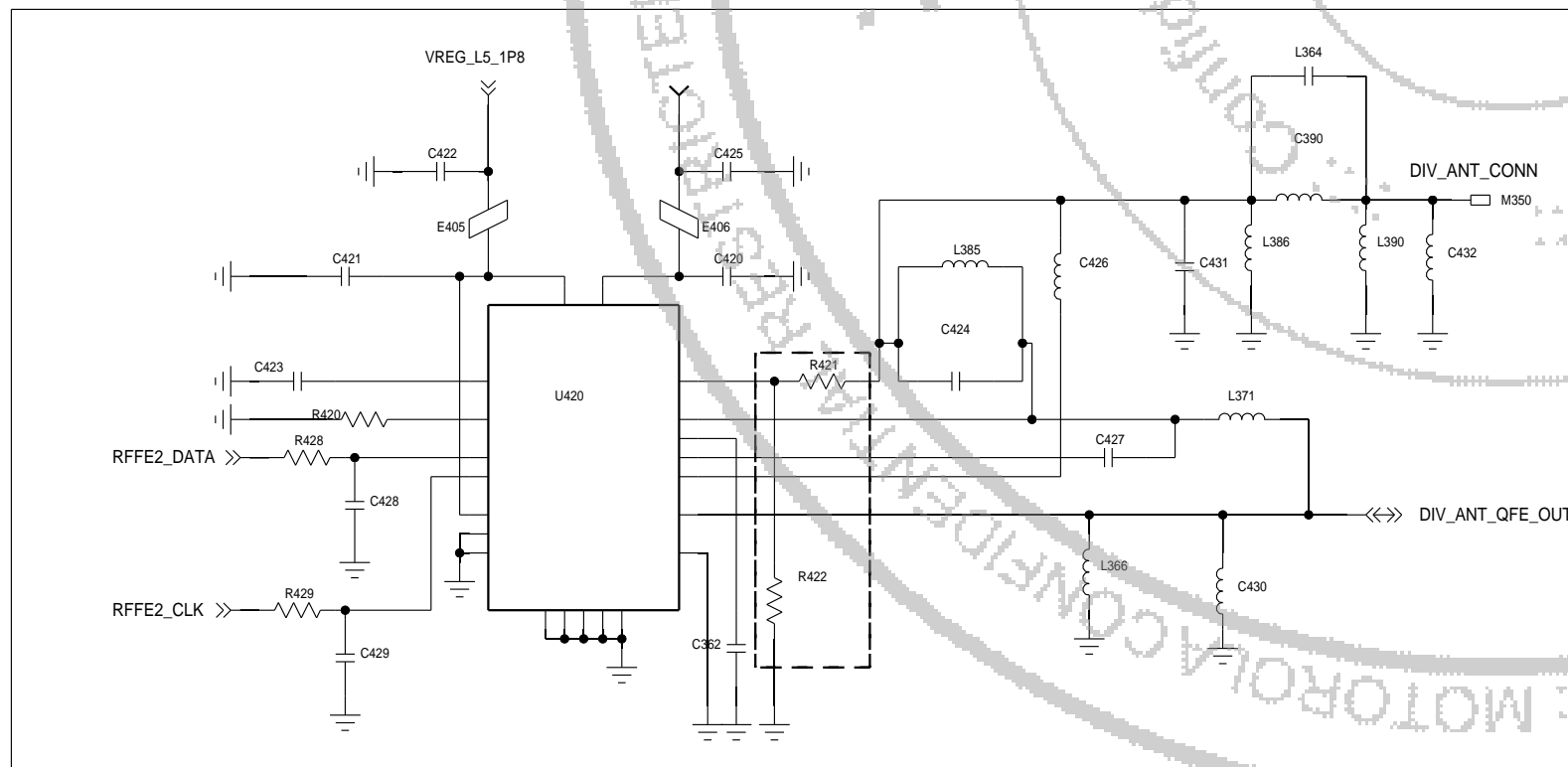
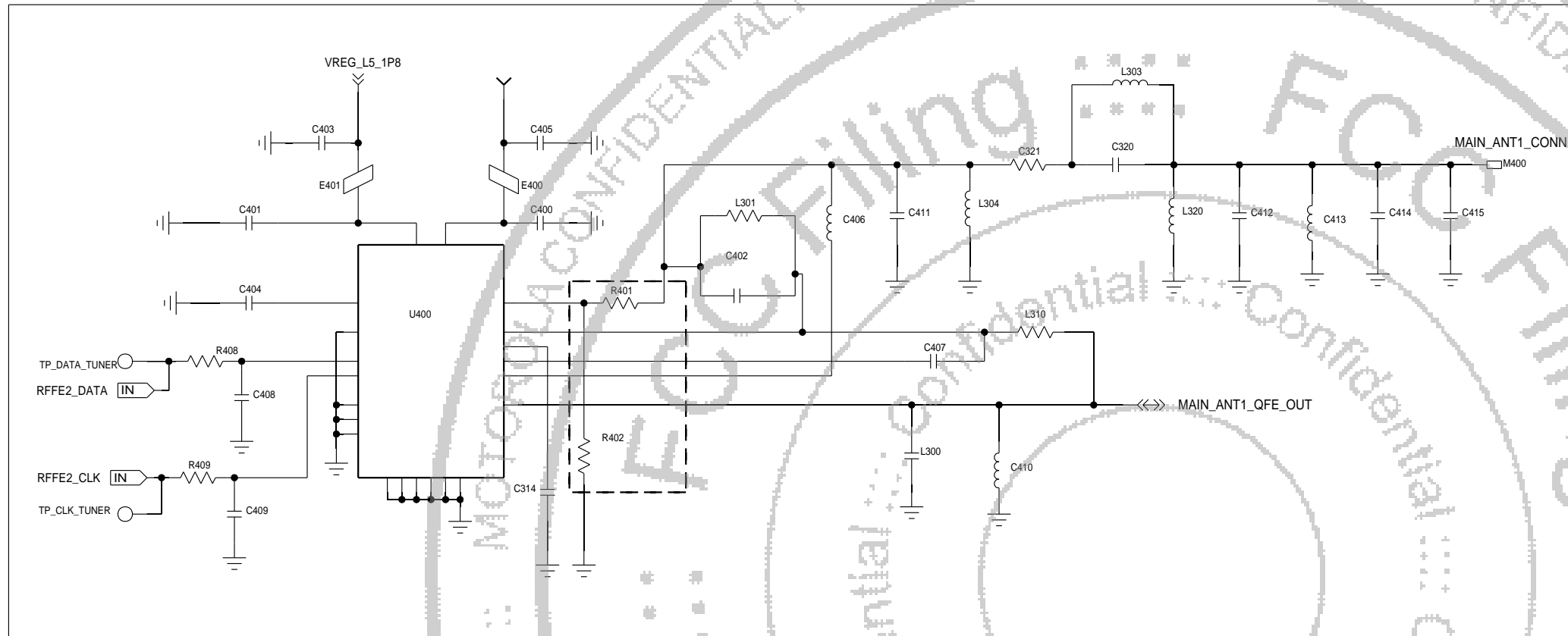

APPROVALS		MOTOROLA MOBILE DEVICES	
ENGINEER:		BLOCK TITLE:	
LAST MODIFIED BY:			
MOTOROLA CONFIDENTIAL RESTRICTED <small>THE DRAWING ON THIS PRINT AND INFORMATION THEREWITH ARE PROPRIETARY TO MOTOROLA AND SHALL NOT BE USED OR DISCUSSED IN WHOLE OR IN PART WITHOUT MOTOROLA'S CONSENT. © COPYRIGHT, MOTOROLA. THIS DOES NOT IMPLY PUBLICATION</small>		PROJECT NAME	REV
		CAD FILE NAME:	

8 7 6 5 4 3 2 1

D

C

B

A

D

C

B

A

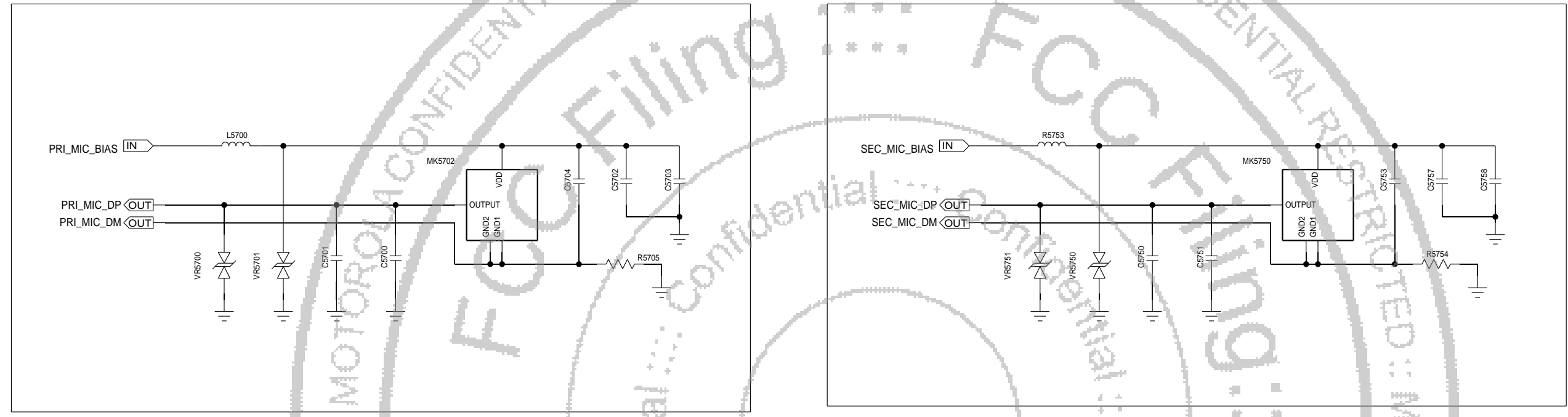

APPROVALS		MOTOROLA MOBILE DEVICES	
ENGINEER:		BLOCK TITLE:	
LAST MODIFIED BY:			
MOTOROLA CONFIDENTIAL RESTRICTED <small>THE DRAWING ON THIS PRINT AND INFORMATION THEREWITH ARE PROPRIETARY TO MOTOROLA AND SHALL NOT BE USED OR DISCUSSED IN WHOLE OR IN PART WITHOUT MOTOROLA'S CONSENT. © COPYRIGHT, MOTOROLA. THIS DOES NOT IMPLY PUBLICATION</small>		PROJECT NAME	REV
		CAD FILE NAME:	

8 7 6 5 4 3 2 1

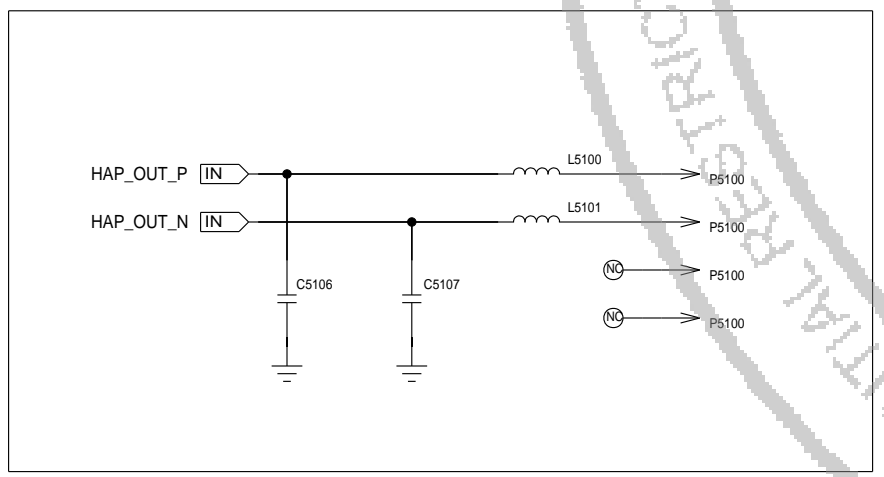
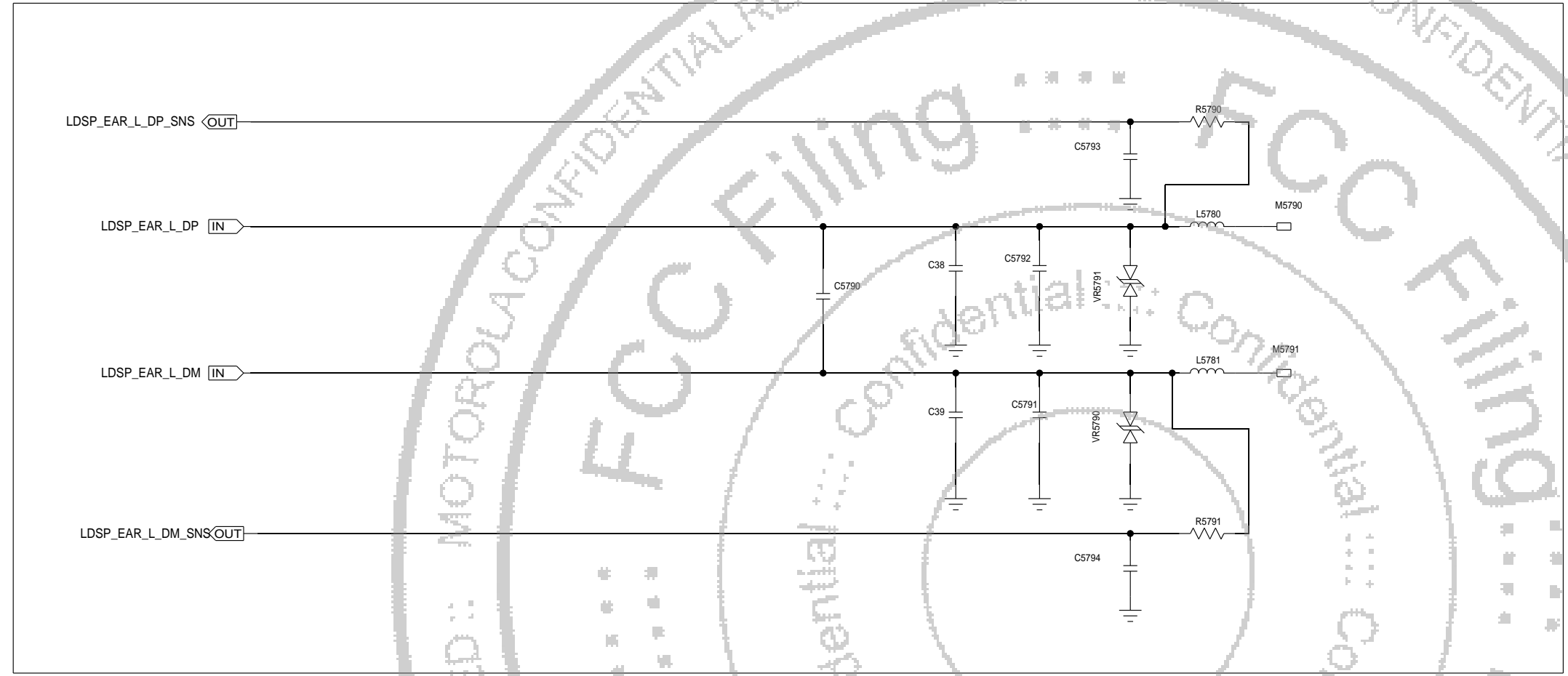

APPROVALS		MOTOROLA MOBILE DEVICES	
ENGINEER:		BLOCK TITLE:	
LAST MODIFIED BY:			
MOTOROLA CONFIDENTIAL RESTRICTED THE DRAWING ON THIS PRINT AND INFORMATION THEREWITH ARE PROPRIETARY TO MOTOROLA AND SHALL NOT BE USED OR DISCUSSED IN WHOLE OR IN PART WITHOUT MOTOROLA'S CONSENT. © COPYRIGHT, MOTOROLA. THIS DOES NOT IMPLY PUBLICATION		PROJECT NAME	REV
		CAD FILE NAME:	

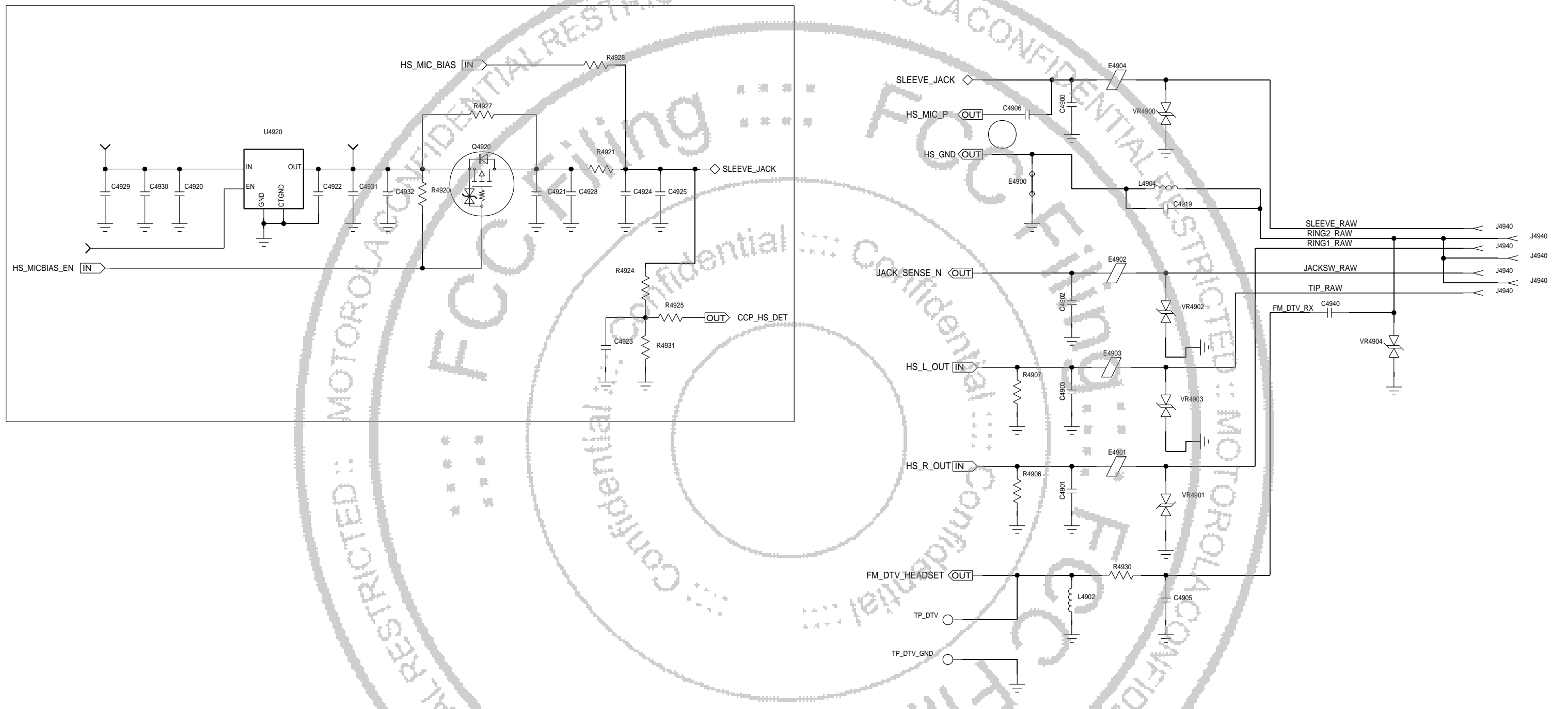

APPROVALS		MOTOROLA MOBILE DEVICES	
ENGINEER:		BLOCK TITLE:	
LAST MODIFIED BY:			
MOTOROLA CONFIDENTIAL RESTRICTED <small>THE DRAWING ON THIS PRINT AND INFORMATION THEREWITH ARE PROPRIETARY TO MOTOROLA AND SHALL NOT BE USED OR DISCUSSED IN WHOLE OR IN PART WITHOUT MOTOROLA'S CONSENT. © COPYRIGHT, MOTOROLA. THIS DOES NOT IMPLY PUBLICATION</small>		PROJECT NAME	REV
		CAD FILE NAME:	

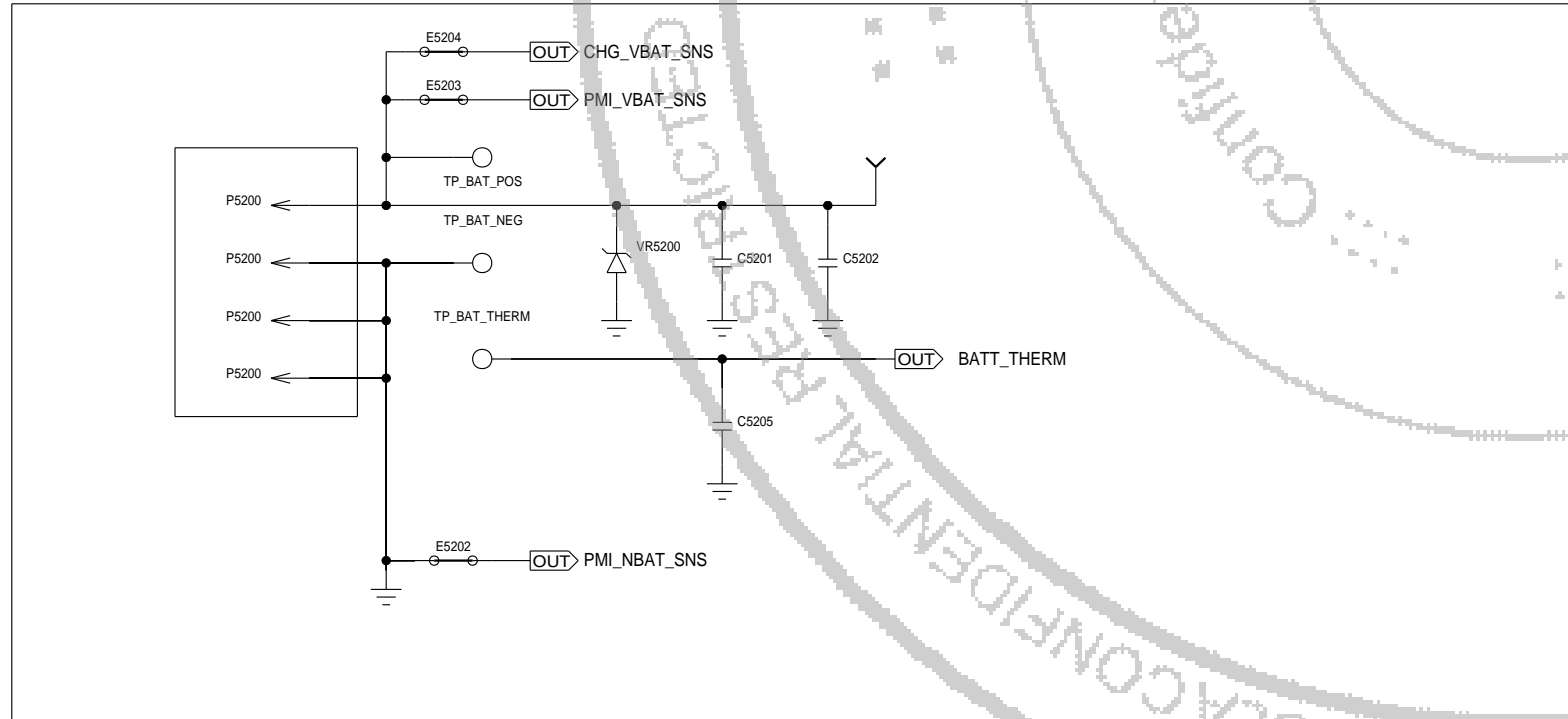
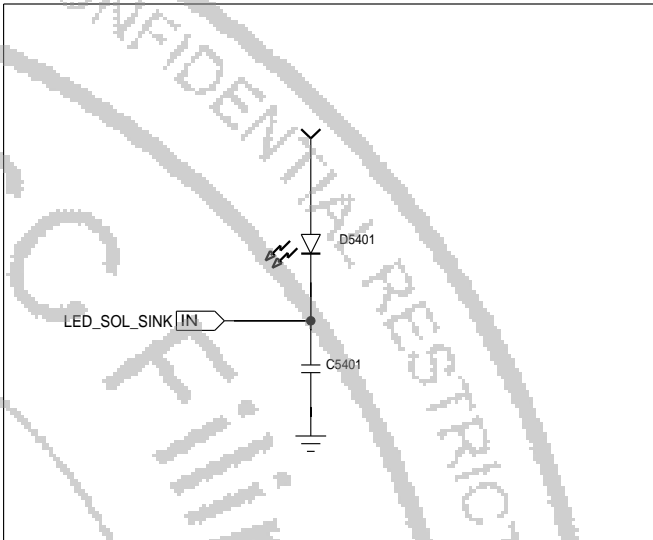
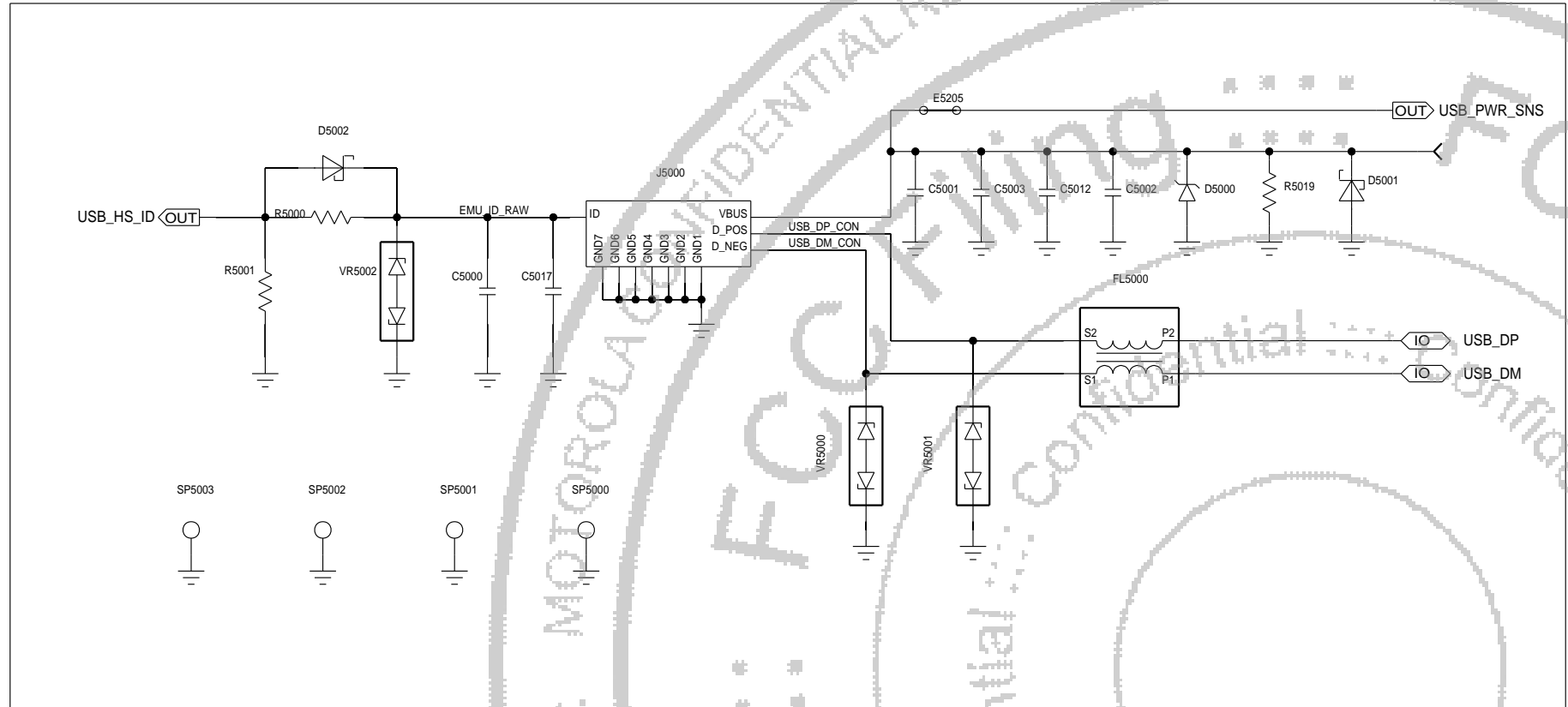

APPROVALS		MOTOROLA MOBILE DEVICES	
ENGINEER:		BLOCK TITLE:	
LAST MODIFIED BY:			
MOTOROLA CONFIDENTIAL RESTRICTED <small>THE DRAWING ON THIS PRINT AND INFORMATION THEREWITH ARE PROPRIETARY TO MOTOROLA AND SHALL NOT BE USED OR DISCUSSED IN WHOLE OR IN PART WITHOUT MOTOROLA'S CONSENT. © COPYRIGHT, MOTOROLA. THIS DOES NOT IMPLY PUBLICATION</small>		PROJECT NAME	REV
		CAD FILE NAME:	

D

C

B

A

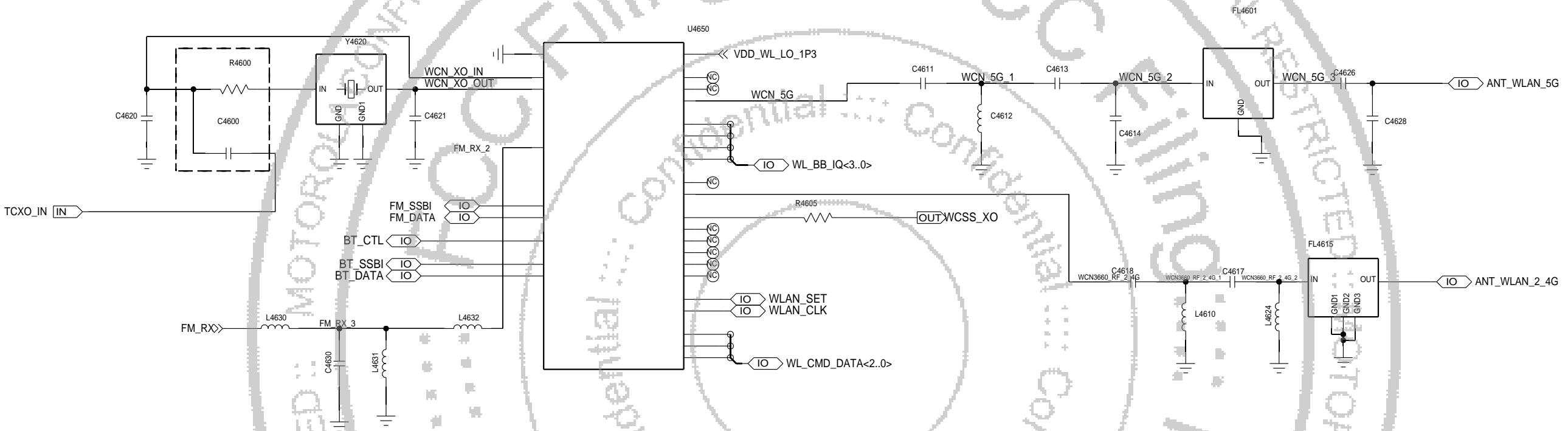

APPROVALS		MOTOROLA MOBILE DEVICES	
ENGINEER:		BLOCK TITLE:	
LAST MODIFIED BY:			
MOTOROLA CONFIDENTIAL RESTRICTED <small>THE DRAWING ON THIS PRINT AND INFORMATION THEREWITH ARE PROPRIETARY TO MOTOROLA AND SHALL NOT BE USED OR DISCUSSED IN WHOLE OR IN PART WITHOUT MOTOROLA'S CONSENT. © COPYRIGHT, MOTOROLA. THIS DOES NOT IMPLY PUBLICATION</small>		PROJECT NAME	REV
		CAD FILE NAME:	

8 7 6 5 4 3 2 1

D

D

C

C

B

B

A

A

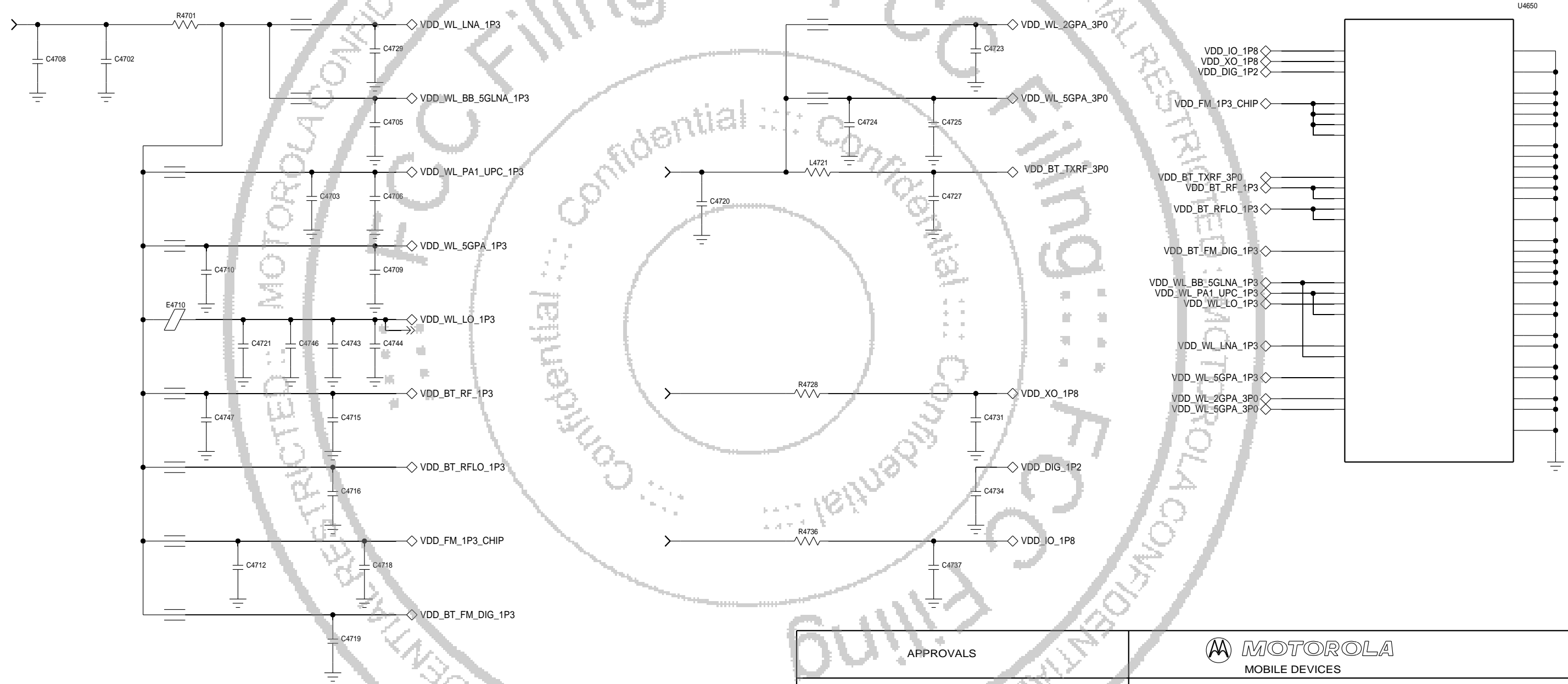

APPROVALS		MOTOROLA MOBILE DEVICES	
ENGINEER:		BLOCK TITLE:	
LAST MODIFIED BY:			
MOTOROLA CONFIDENTIAL RESTRICTED <small>THE DRAWING ON THIS PRINT AND INFORMATION THEREWITH ARE PROPRIETARY TO MOTOROLA AND SHALL NOT BE USED OR DISCUSSED IN WHOLE OR IN PART WITHOUT MOTOROLA'S CONSENT. © COPYRIGHT, MOTOROLA. THIS DOES NOT IMPLY PUBLICATION</small>		PROJECT NAME	REV
		CAD FILE NAME:	

8 7 6 5 4 3 2 1

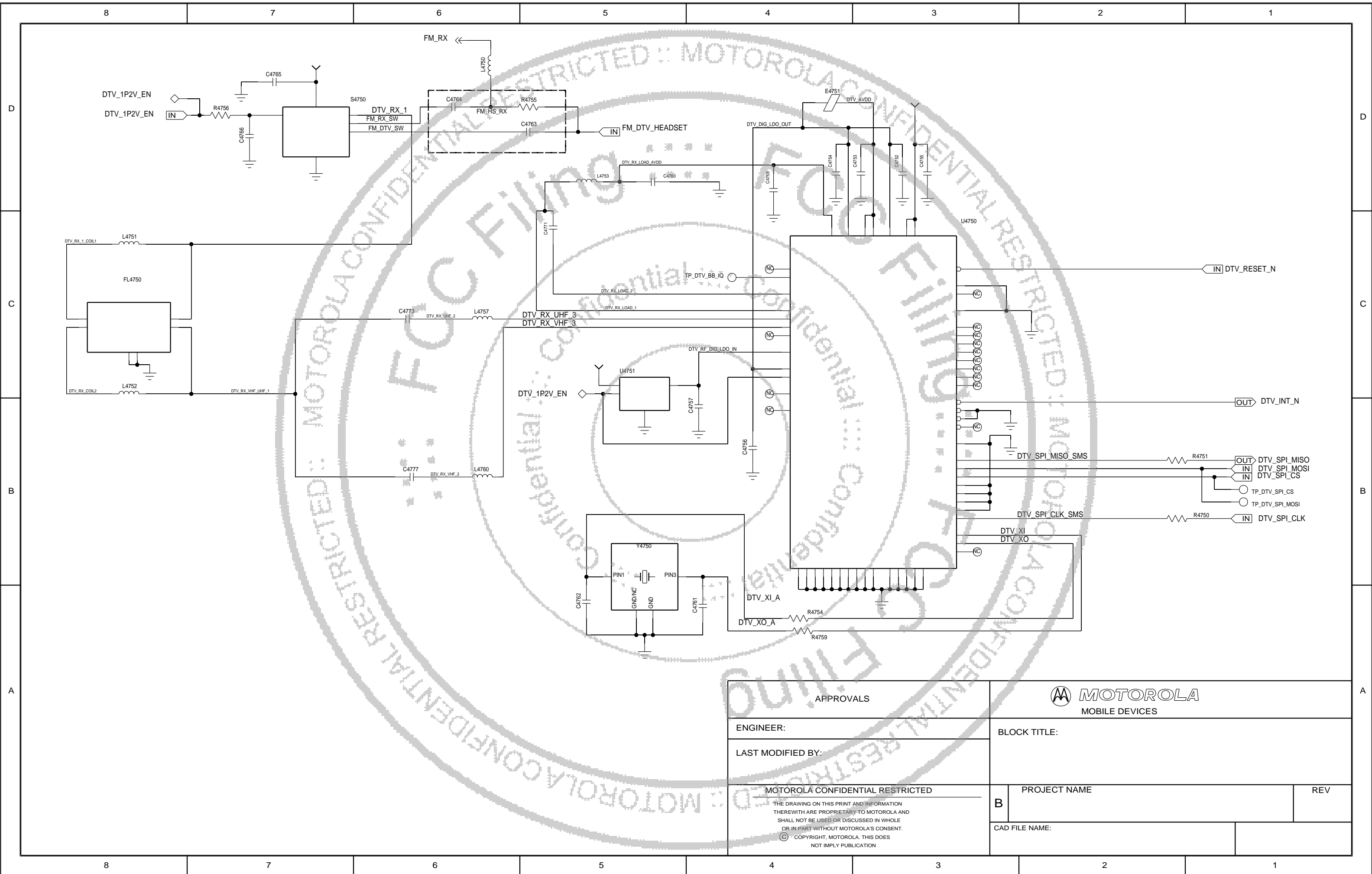

APPROVALS

ENGINEER:

LAST MODIFIED BY:

MOTOROLA CONFIDENTIAL RESTRICTED

THE DRAWING ON THIS PRINT AND INFORMATION THEREWITH ARE PROPRIETARY TO MOTOROLA AND SHALL NOT BE USED OR DISCUSSED IN WHOLE OR IN PART WITHOUT MOTOROLA'S CONSENT.
 © COPYRIGHT, MOTOROLA. THIS DOES NOT IMPLY PUBLICATION

MOTOROLA MOBILE DEVICES	
BLOCK TITLE:	
PROJECT NAME	REV
CAD FILE NAME:	

8 7 6 5 4 3 2 1

D

D

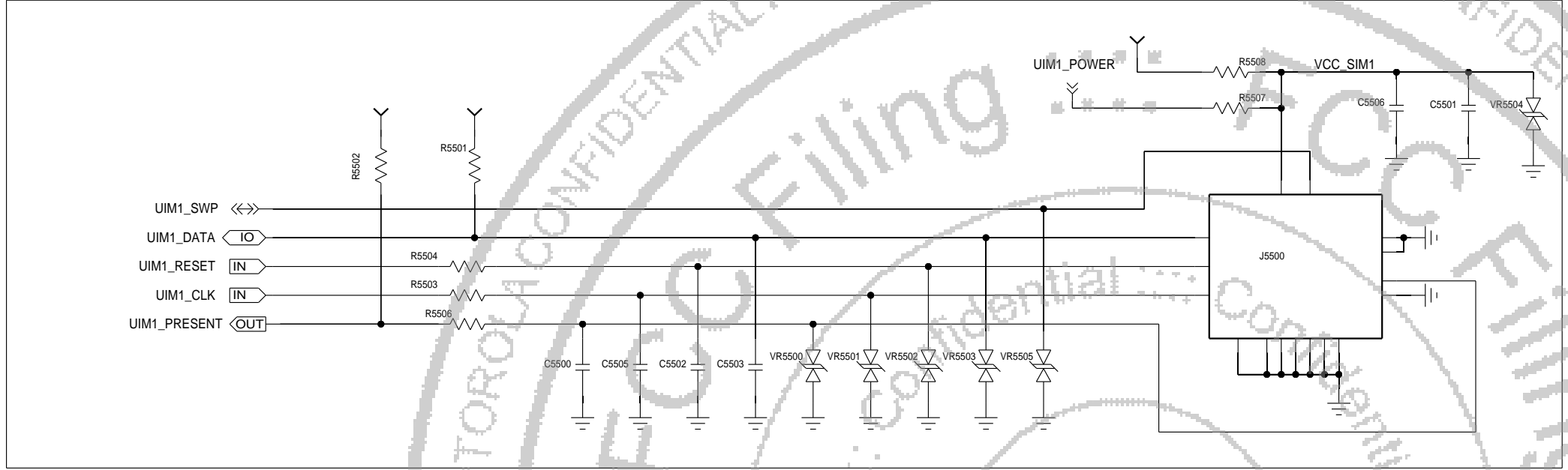

C

C

B

B

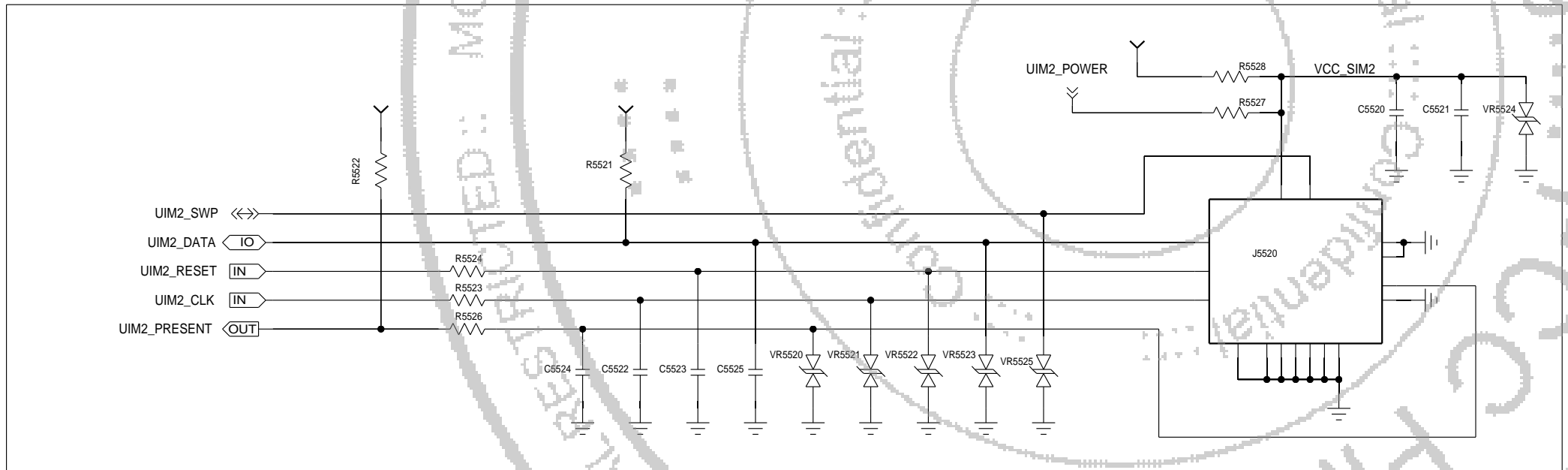

A

A

APPROVALS		MOTOROLA MOBILE DEVICES	
ENGINEER:		BLOCK TITLE:	
LAST MODIFIED BY:		PROJECT NAME	
MOTOROLA CONFIDENTIAL RESTRICTED THE DRAWING ON THIS PRINT AND INFORMATION THEREWITH ARE PROPRIETARY TO MOTOROLA AND SHALL NOT BE USED OR DISCUSSED IN WHOLE OR IN PART WITHOUT MOTOROLA'S CONSENT. © COPYRIGHT, MOTOROLA. THIS DOES NOT IMPLY PUBLICATION		B	REV
		CAD FILE NAME:	

8 7 6 5 4 3 2 1

D

C

B

A

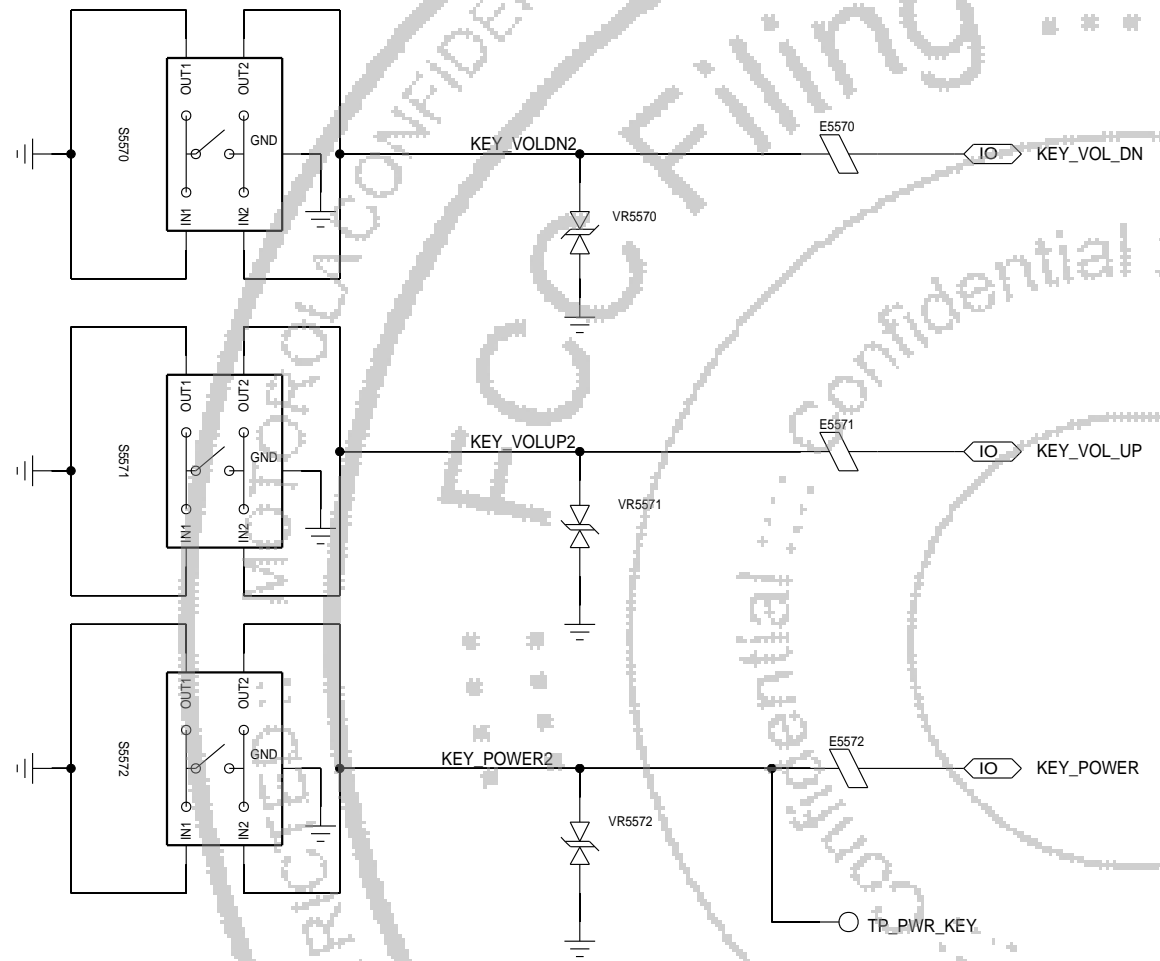

APPROVALS		MOTOROLA MOBILE DEVICES	
ENGINEER:		BLOCK TITLE:	
LAST MODIFIED BY:			
MOTOROLA CONFIDENTIAL RESTRICTED THE DRAWING ON THIS PRINT AND INFORMATION THEREWITH ARE PROPRIETARY TO MOTOROLA AND SHALL NOT BE USED OR DISCUSSED IN WHOLE OR IN PART WITHOUT MOTOROLA'S CONSENT. © COPYRIGHT, MOTOROLA. THIS DOES NOT IMPLY PUBLICATION		PROJECT NAME	REV
		CAD FILE NAME:	

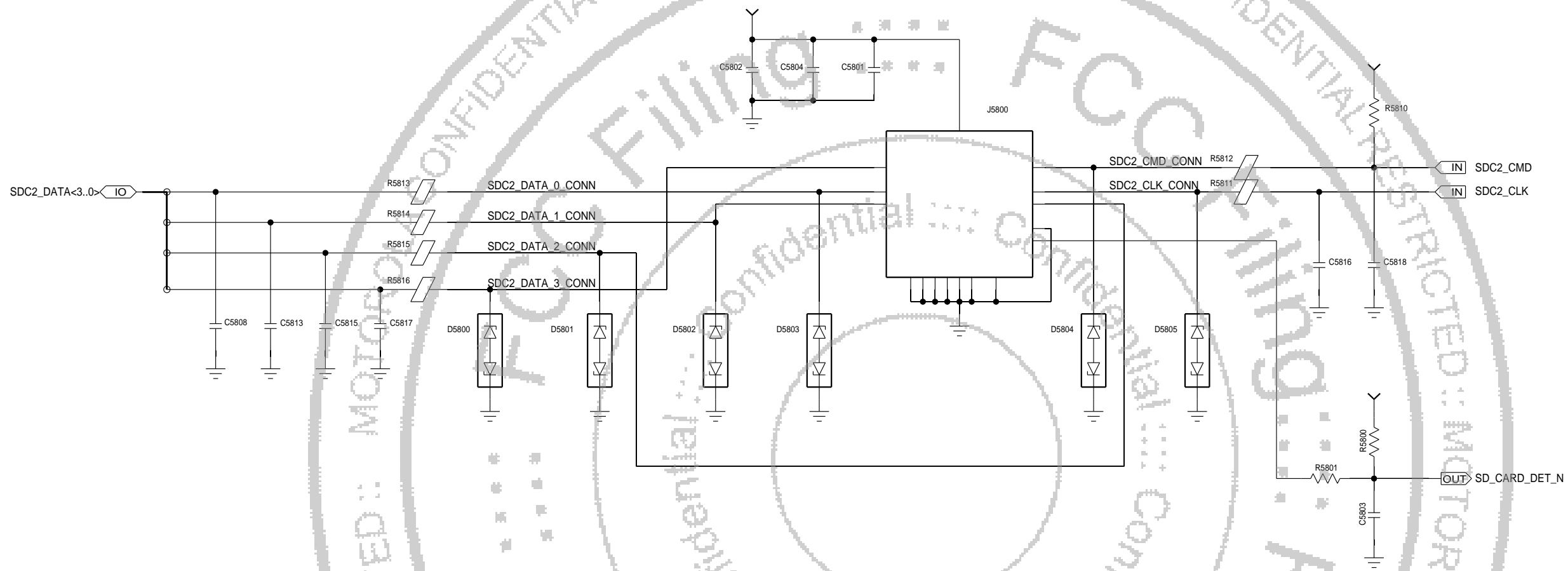

APPROVALS		 MOTOROLA MOBILE DEVICES	
ENGINEER:		BLOCK TITLE:	
LAST MODIFIED BY:			
MOTOROLA CONFIDENTIAL RESTRICTED <small>THE DRAWING ON THIS PRINT AND INFORMATION THEREWITH ARE PROPRIETARY TO MOTOROLA AND SHALL NOT BE USED OR DISCUSSED IN WHOLE OR IN PART WITHOUT MOTOROLA'S CONSENT. © COPYRIGHT, MOTOROLA. THIS DOES NOT IMPLY PUBLICATION</small>		PROJECT NAME	REV
		CAD FILE NAME:	

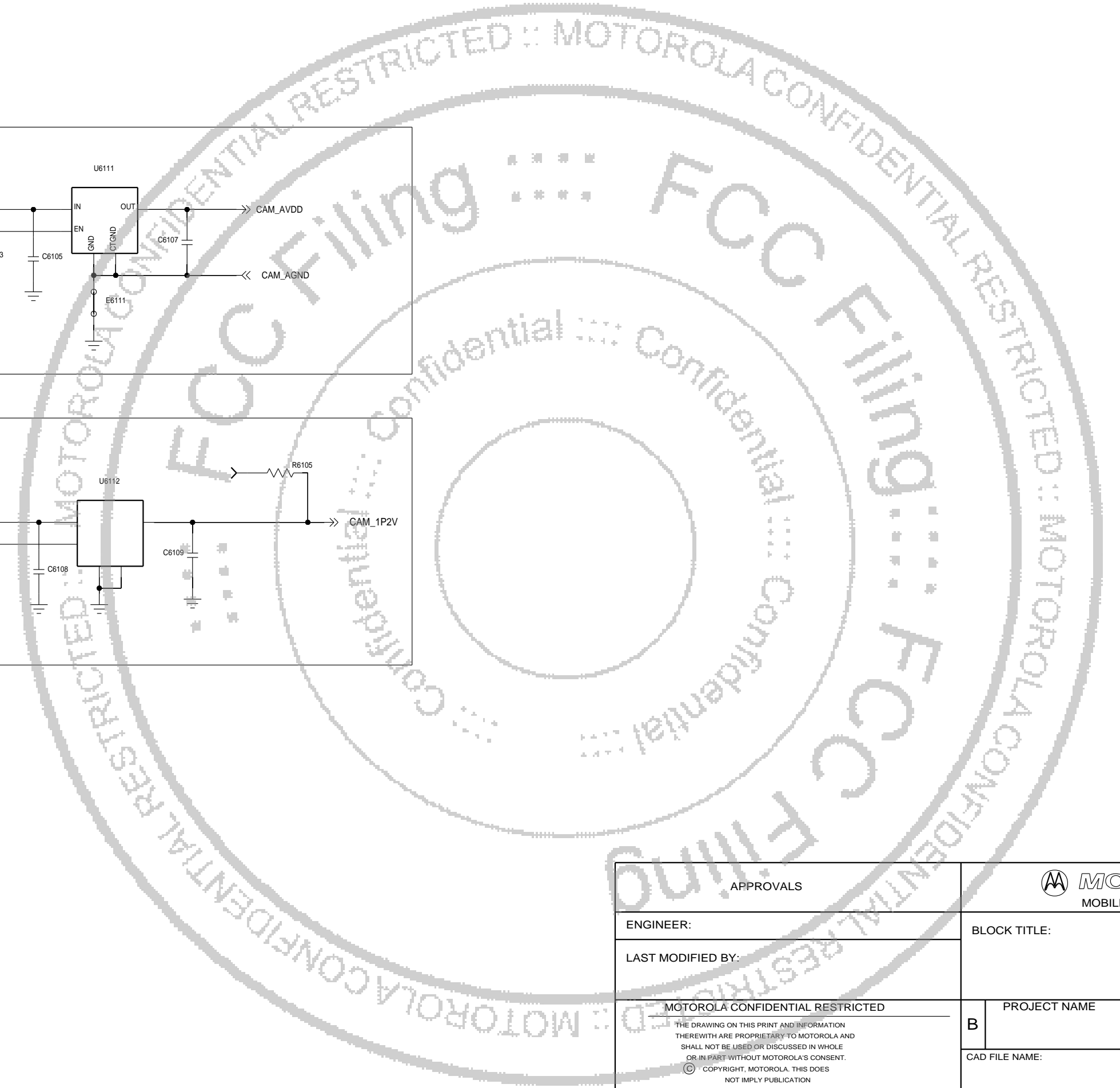
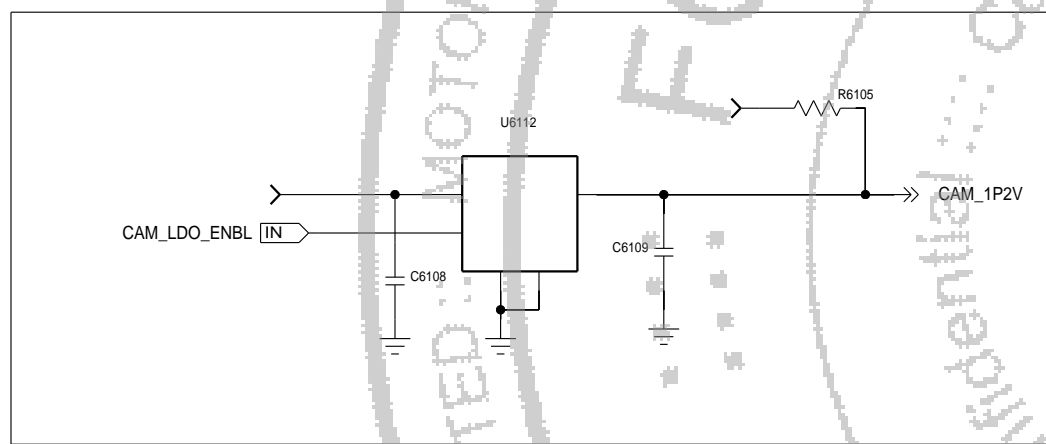
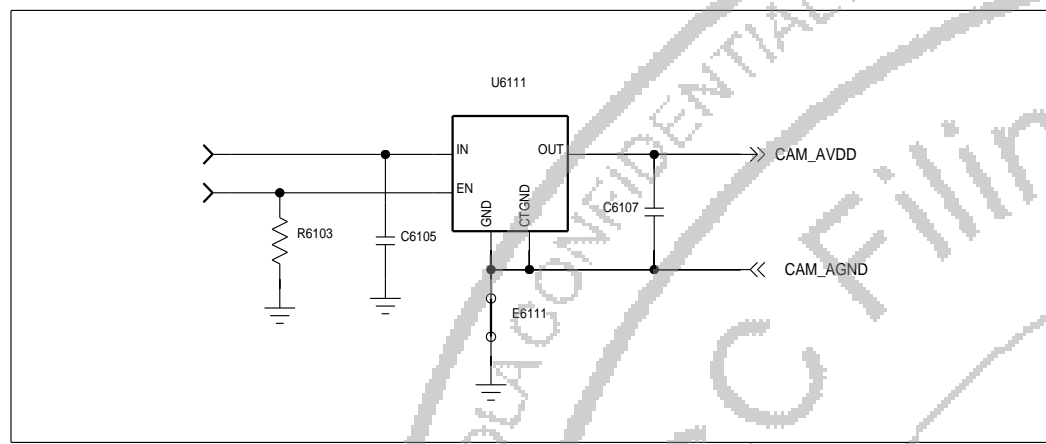

APPROVALS		MOTOROLA MOBILE DEVICES	
ENGINEER:	BLOCK TITLE:		
LAST MODIFIED BY:			
MOTOROLA CONFIDENTIAL RESTRICTED <small>THE DRAWING ON THIS PRINT AND INFORMATION THEREWITH ARE PROPRIETARY TO MOTOROLA AND SHALL NOT BE USED OR DISCUSSED IN WHOLE OR IN PART WITHOUT MOTOROLA'S CONSENT. © COPYRIGHT, MOTOROLA. THIS DOES NOT IMPLY PUBLICATION</small>	PROJECT NAME		REV
	CAD FILE NAME:		

D

C

B

A

D

C

B

A

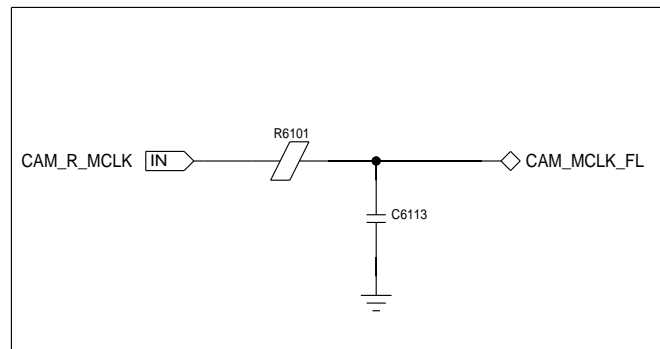
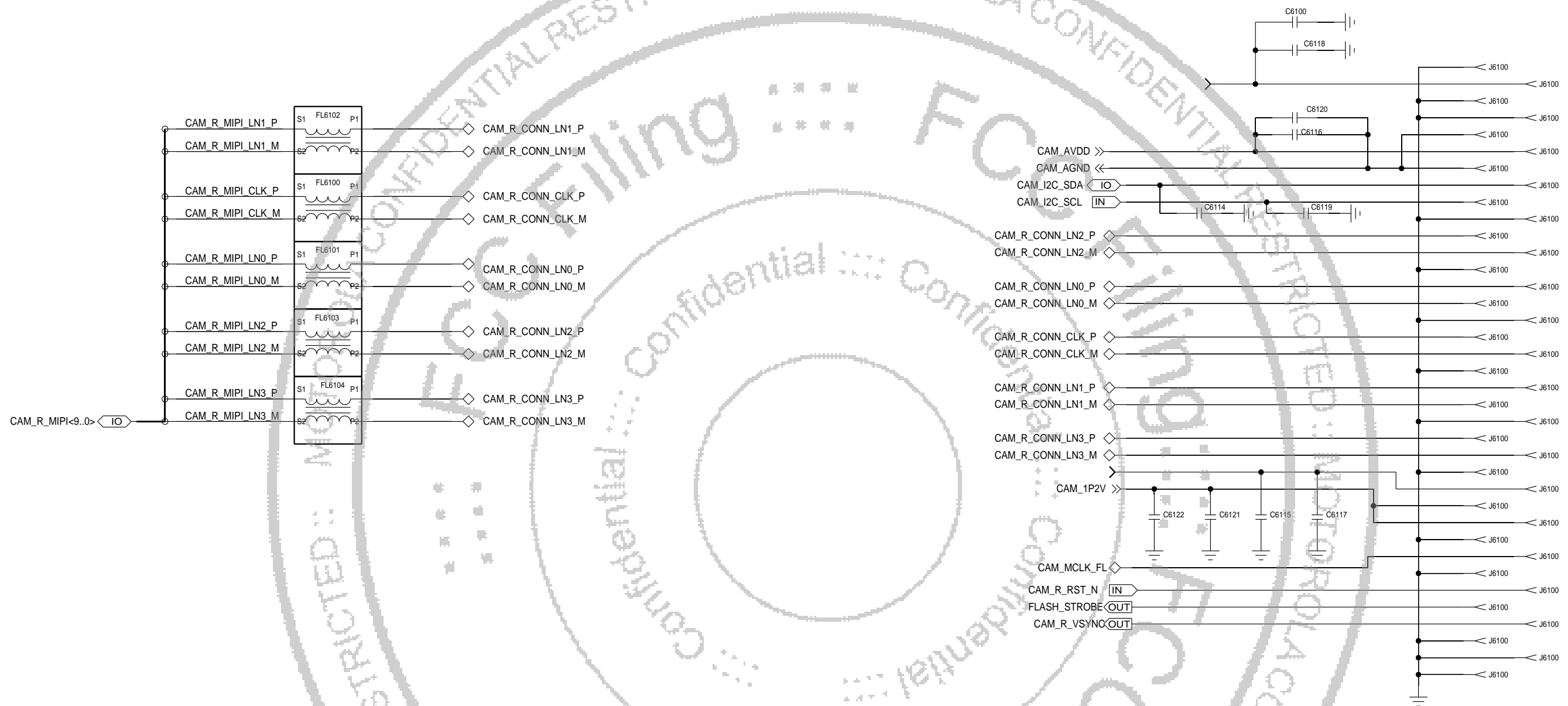

CAM_R_MIPI_LN1_P	R6110	CAM_R_CONN_LN1_P
CAM_R_MIPI_LN1_M	R6111	CAM_R_CONN_LN1_M
CAM_R_MIPI_CLK_P	R6112	CAM_R_CONN_CLK_P
CAM_R_MIPI_CLK_M	R6113	CAM_R_CONN_CLK_M
CAM_R_MIPI_LN0_P	R6114	CAM_R_CONN_LN0_P
CAM_R_MIPI_LN0_M	R6115	CAM_R_CONN_LN0_M
CAM_R_MIPI_LN2_P	R6116	CAM_R_CONN_LN2_P
CAM_R_MIPI_LN2_M	R6117	CAM_R_CONN_LN2_M
CAM_R_MIPI_LN3_P	R6118	CAM_R_CONN_LN3_P
CAM_R_MIPI_LN3_M	R6119	CAM_R_CONN_LN3_M

APPROVALS	
ENGINEER:	
LAST MODIFIED BY:	
MOTOROLA CONFIDENTIAL RESTRICTED	
<small>THE DRAWING ON THIS PRINT AND INFORMATION THEREWITH ARE PROPRIETARY TO MOTOROLA AND SHALL NOT BE USED OR DISCUSSED IN WHOLE OR IN PART WITHOUT MOTOROLA'S CONSENT. © COPYRIGHT, MOTOROLA. THIS DOES NOT IMPLY PUBLICATION</small>	

MOTOROLA MOBILE DEVICES	
BLOCK TITLE:	
PROJECT NAME	REV
CAD FILE NAME:	

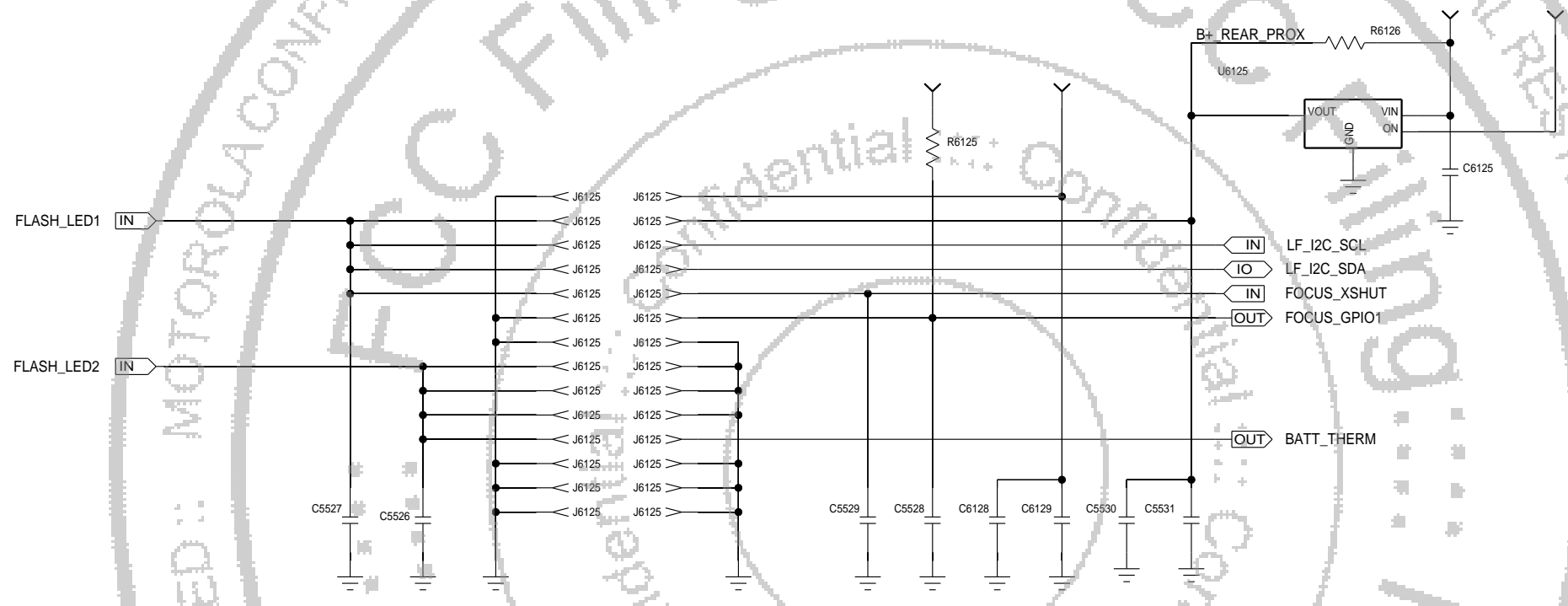

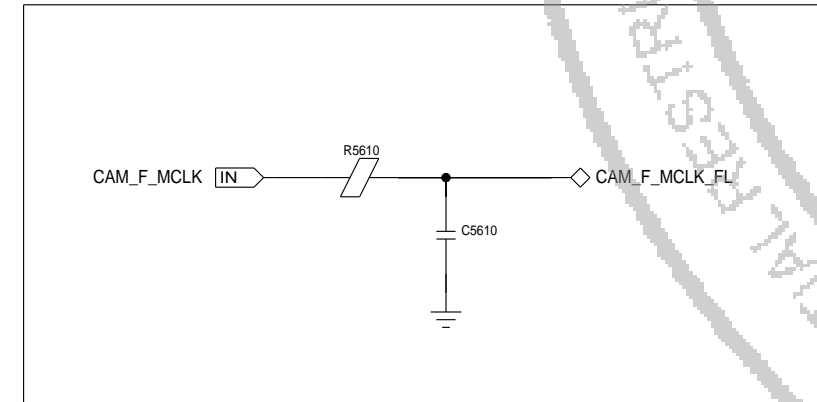
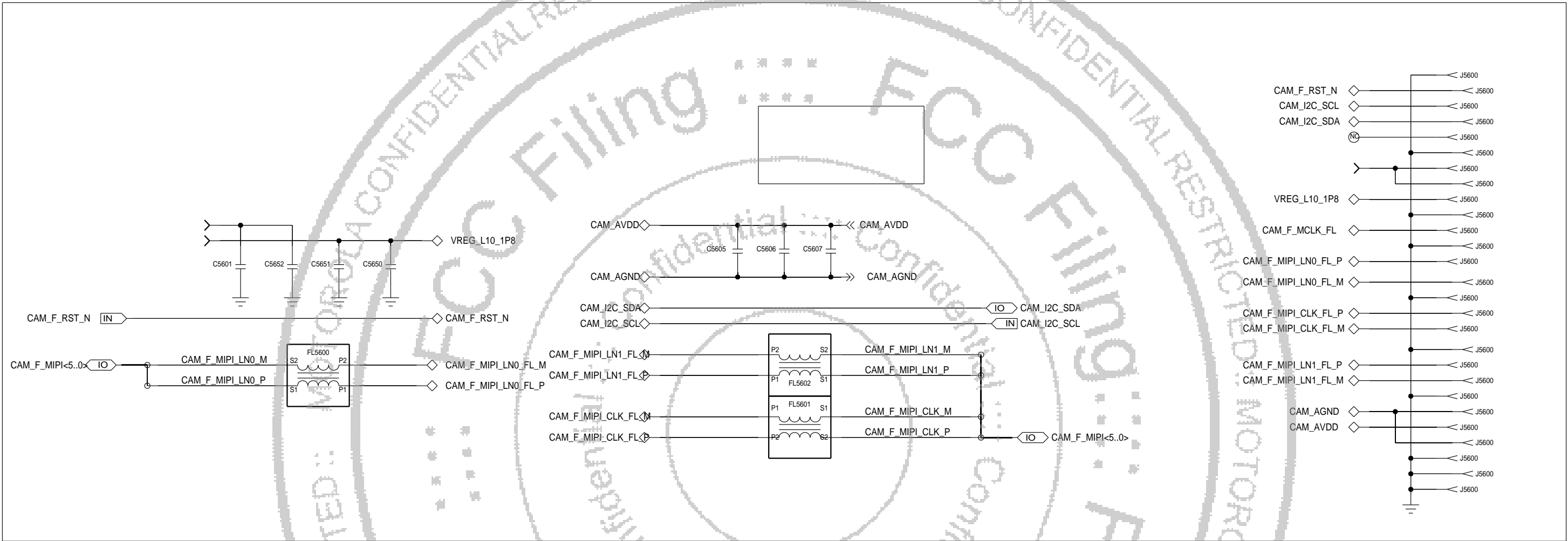

APPROVALS		MOTOROLA MOBILE DEVICES	
ENGINEER:		BLOCK TITLE:	
LAST MODIFIED BY:			
MOTOROLA CONFIDENTIAL RESTRICTED <small>THE DRAWING ON THIS PRINT AND INFORMATION THEREWITH ARE PROPRIETARY TO MOTOROLA AND SHALL NOT BE USED OR DISCUSSED IN WHOLE OR IN PART WITHOUT MOTOROLA'S CONSENT. © COPYRIGHT, MOTOROLA. THIS DOES NOT IMPLY PUBLICATION</small>		PROJECT NAME	REV
		CAD FILE NAME:	

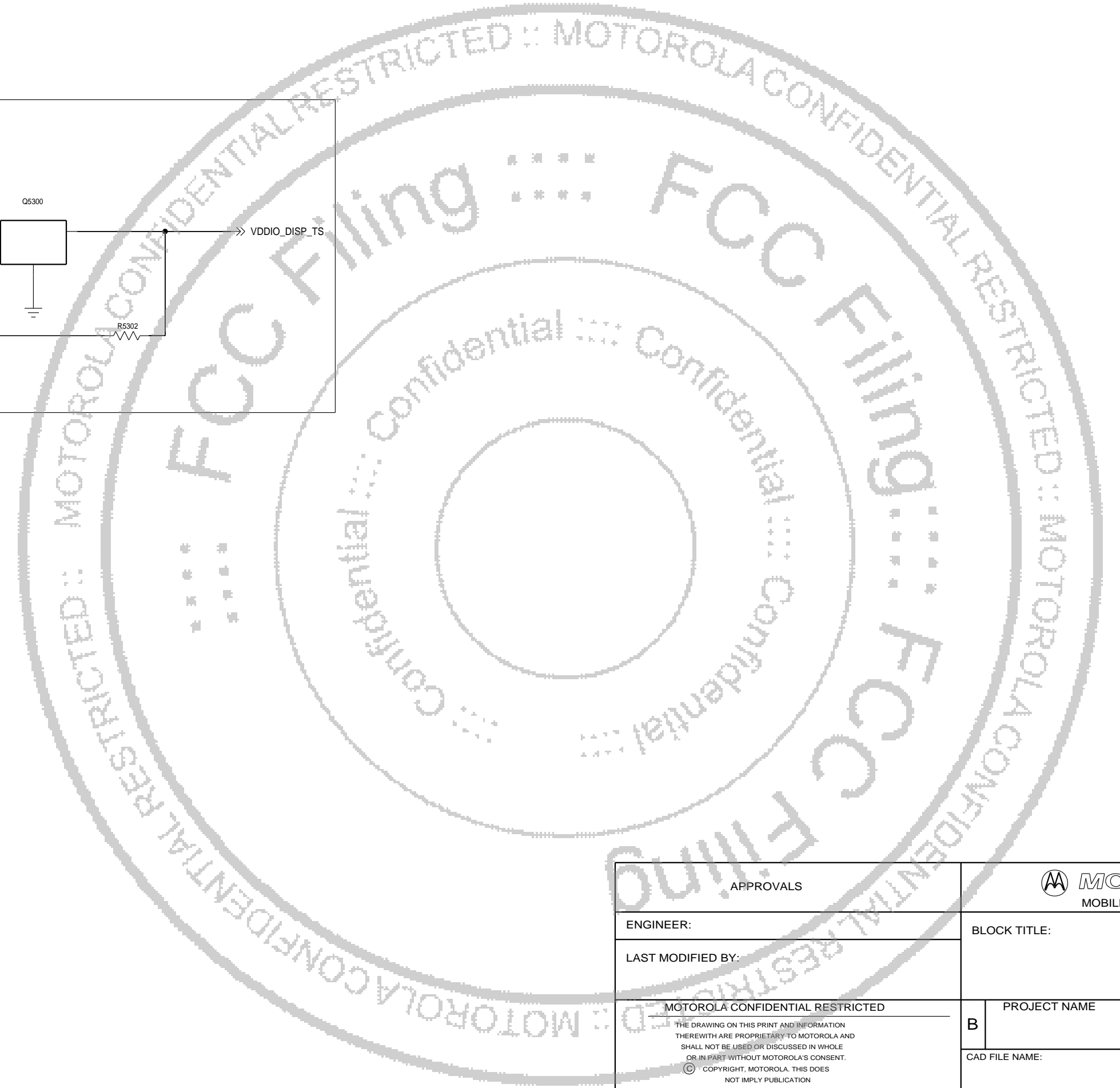
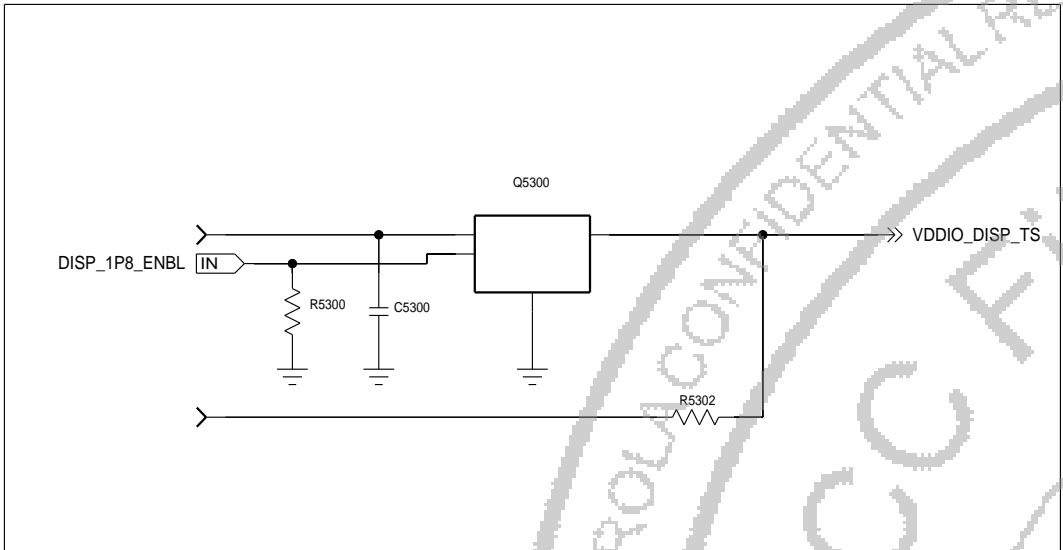

- CAM_F_MIPI_LN0_FL_M — R5600 — CAM_F_MIPI_LN0_M
- CAM_F_MIPI_LN0_FL_P — R5601 — CAM_F_MIPI_LN0_P
- CAM_F_MIPI_CLK_FL_M — R5602 — CAM_F_MIPI_CLK_M
- CAM_F_MIPI_CLK_FL_P — R5603 — CAM_F_MIPI_CLK_P
- CAM_F_MIPI_LN1_FL_M — R5604 — CAM_F_MIPI_LN1_M
- CAM_F_MIPI_LN1_FL_P — R5605 — CAM_F_MIPI_LN1_P

APPROVALS		MOTOROLA MOBILE DEVICES	
ENGINEER:		BLOCK TITLE:	
LAST MODIFIED BY:			
MOTOROLA CONFIDENTIAL RESTRICTED <small>THE DRAWING ON THIS PRINT AND INFORMATION THEREWITH ARE PROPRIETARY TO MOTOROLA AND SHALL NOT BE USED OR DISCUSSED IN WHOLE OR IN PART WITHOUT MOTOROLA'S CONSENT. © COPYRIGHT, MOTOROLA. THIS DOES NOT IMPLY PUBLICATION</small>		PROJECT NAME	REV
		CAD FILE NAME:	



APPROVALS		 MOTOROLA MOBILE DEVICES	
ENGINEER:		BLOCK TITLE:	
LAST MODIFIED BY:			
MOTOROLA CONFIDENTIAL RESTRICTED <small>THE DRAWING ON THIS PRINT AND INFORMATION THEREWITH ARE PROPRIETARY TO MOTOROLA AND SHALL NOT BE USED OR DISCUSSED IN WHOLE OR IN PART WITHOUT MOTOROLA'S CONSENT. © COPYRIGHT, MOTOROLA. THIS DOES NOT IMPLY PUBLICATION</small>		PROJECT NAME	REV
		CAD FILE NAME:	

D

C

B

A

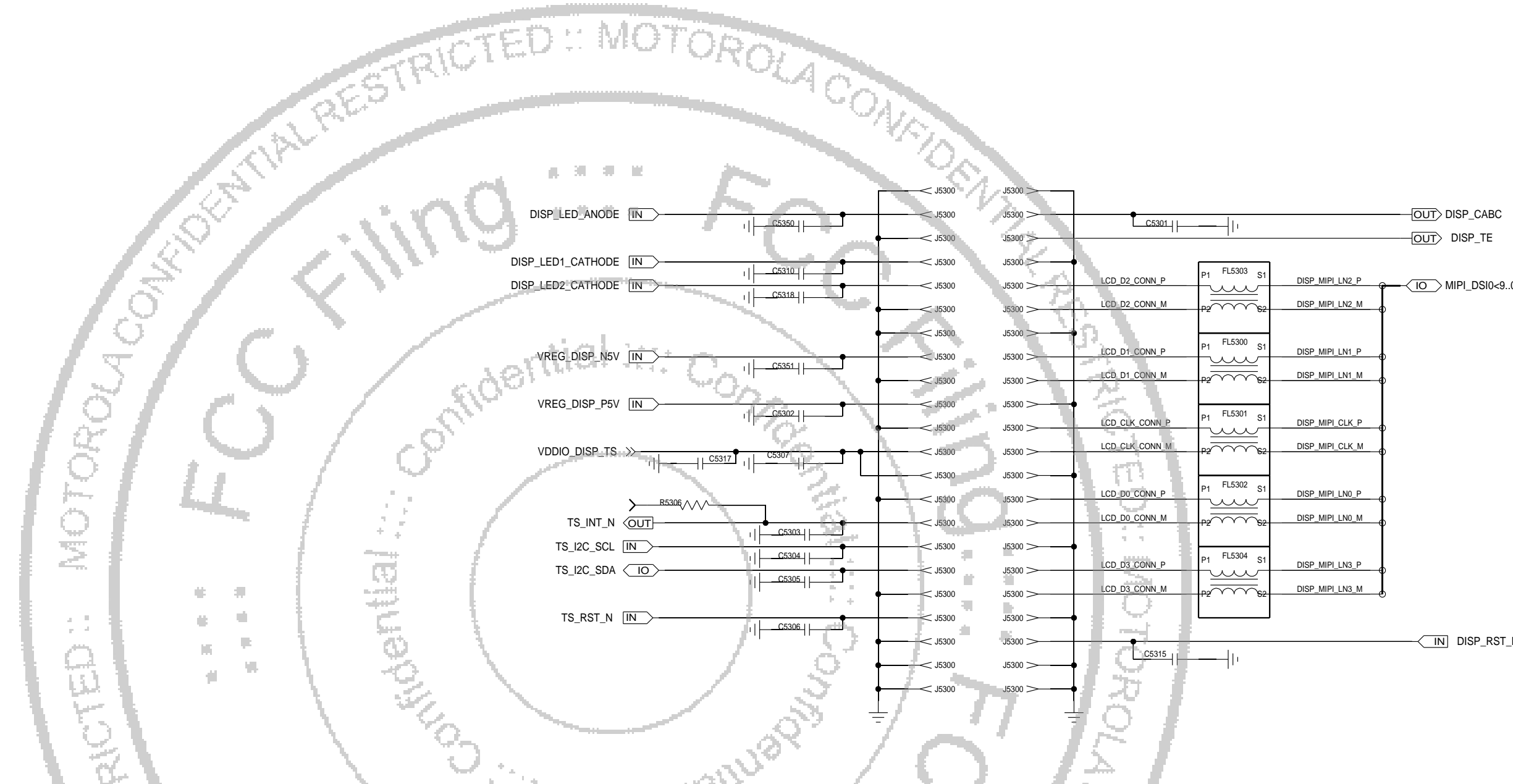

LCD_D2_CONN_P	R5400	DISP_MIPI_LN2_P
LCD_D2_CONN_M	R5401	DISP_MIPI_LN2_M
LCD_D1_CONN_P	R5402	DISP_MIPI_LN1_P
LCD_D1_CONN_M	R5403	DISP_MIPI_LN1_M
LCD_CLK_CONN_P	R5404	DISP_MIPI_CLK_P
LCD_CLK_CONN_M	R5405	DISP_MIPI_CLK_M
LCD_D0_CONN_P	R5406	DISP_MIPI_LN0_P
LCD_D0_CONN_M	R5407	DISP_MIPI_LN0_M
LCD_D3_CONN_P	R5408	DISP_MIPI_LN3_P
LCD_D3_CONN_M	R5409	DISP_MIPI_LN3_M

APPROVALS		MOTOROLA MOBILE DEVICES	
ENGINEER:		BLOCK TITLE:	
LAST MODIFIED BY:			
MOTOROLA CONFIDENTIAL RESTRICTED <small>THE DRAWING ON THIS PRINT AND INFORMATION THEREWITH ARE PROPRIETARY TO MOTOROLA AND SHALL NOT BE USED OR DISCUSSED IN WHOLE OR IN PART WITHOUT MOTOROLA'S CONSENT. © COPYRIGHT, MOTOROLA. THIS DOES NOT IMPLY PUBLICATION</small>		PROJECT NAME	
		REV	
		CAD FILE NAME:	

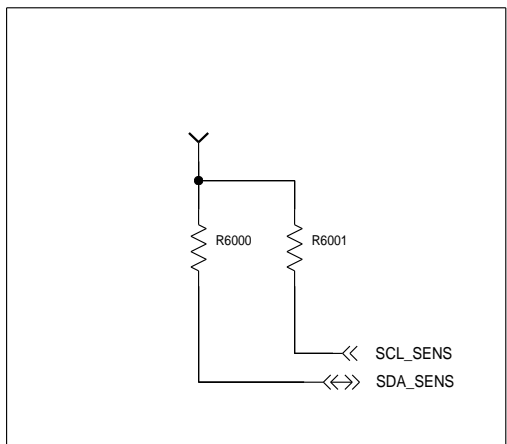
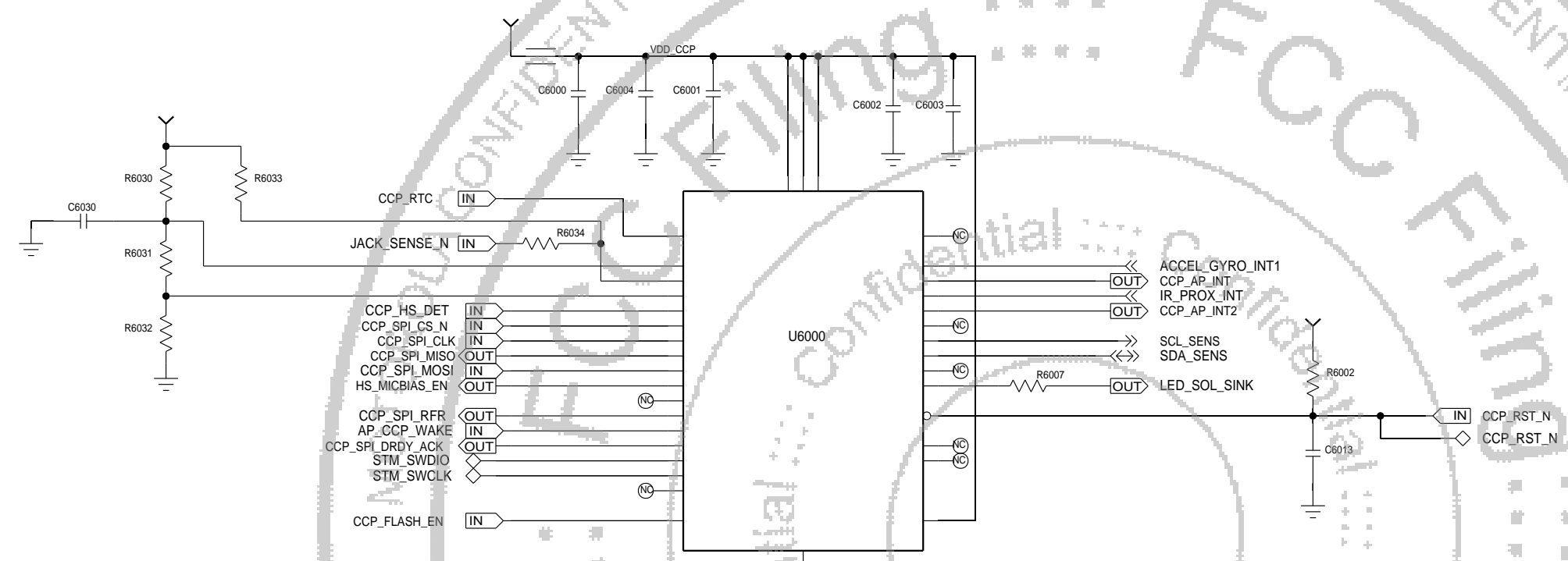

CCP_RST_N	TP_STM_Nrst
CCP_FLASH_EN	TP_STM_BOOT0
CCP_AP_INT	TP_CCP_AP_INT
CCP_SPI_CLK	TP_SCK_CCP
CCP_SPI_MOSI	TP_MOSI_CCP
CCP_SPI_MISO	TP_MISO_CCP
CCP_SPI_CS_N	TP_CS_CCP
STM_SWDIO	TP_SWDIO
STM_SWCLK	TP_SWCLK

APPROVALS	
ENGINEER:	
LAST MODIFIED BY:	
MOTOROLA CONFIDENTIAL RESTRICTED	
<small>THE DRAWING ON THIS PRINT AND INFORMATION THEREWITH ARE PROPRIETARY TO MOTOROLA AND SHALL NOT BE USED OR DISCUSSED IN WHOLE OR IN PART WITHOUT MOTOROLA'S CONSENT. © COPYRIGHT, MOTOROLA. THIS DOES NOT IMPLY PUBLICATION</small>	

MOTOROLA MOBILE DEVICES	
BLOCK TITLE:	
PROJECT NAME	REV
CAD FILE NAME:	

8 7 6 5 4 3 2 1

D
C
B
A

D
C
B
A

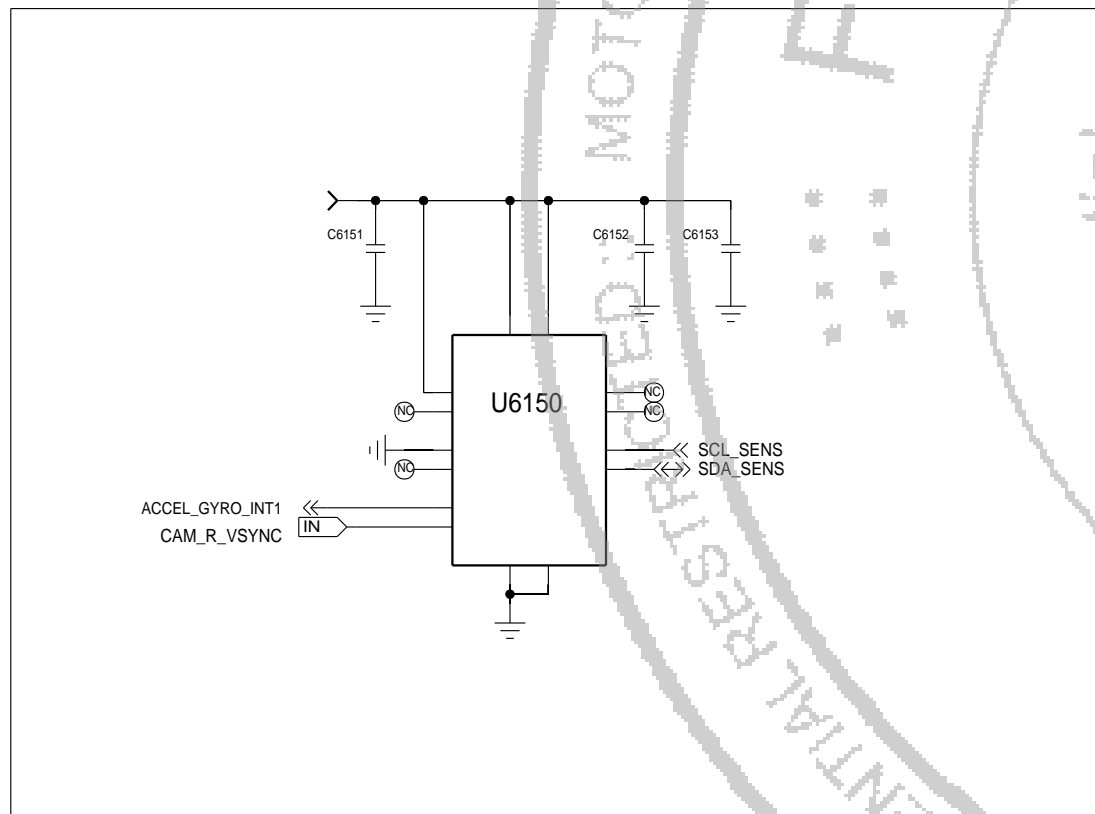
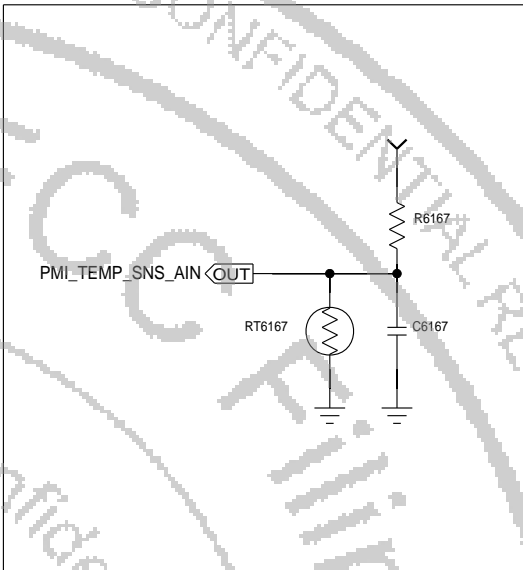
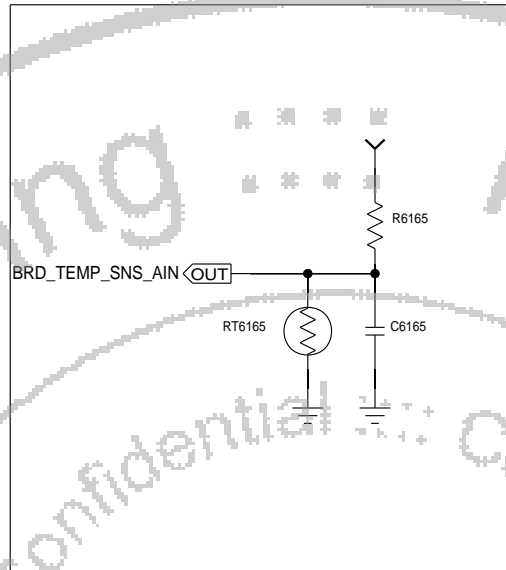
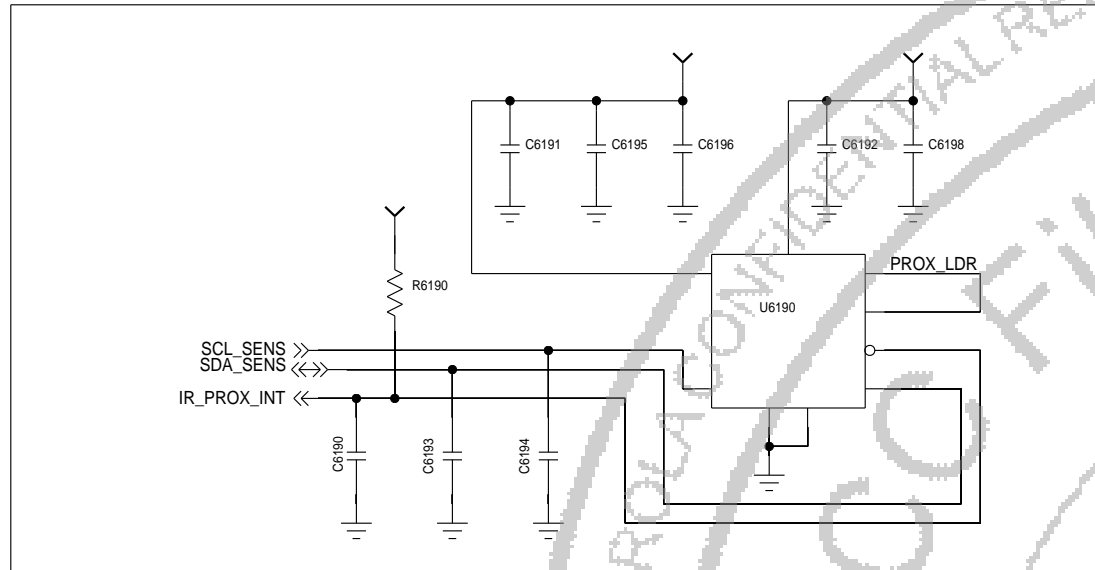

APPROVALS		MOTOROLA MOBILE DEVICES	
ENGINEER:		BLOCK TITLE:	
LAST MODIFIED BY:			
MOTOROLA CONFIDENTIAL RESTRICTED <small>THE DRAWING ON THIS PRINT AND INFORMATION THEREWITH ARE PROPRIETARY TO MOTOROLA AND SHALL NOT BE USED OR DISCUSSED IN WHOLE OR IN PART WITHOUT MOTOROLA'S CONSENT. © COPYRIGHT, MOTOROLA. THIS DOES NOT IMPLY PUBLICATION</small>		PROJECT NAME	REV
B		CAD FILE NAME:	

8 7 6 5 4 3 2 1

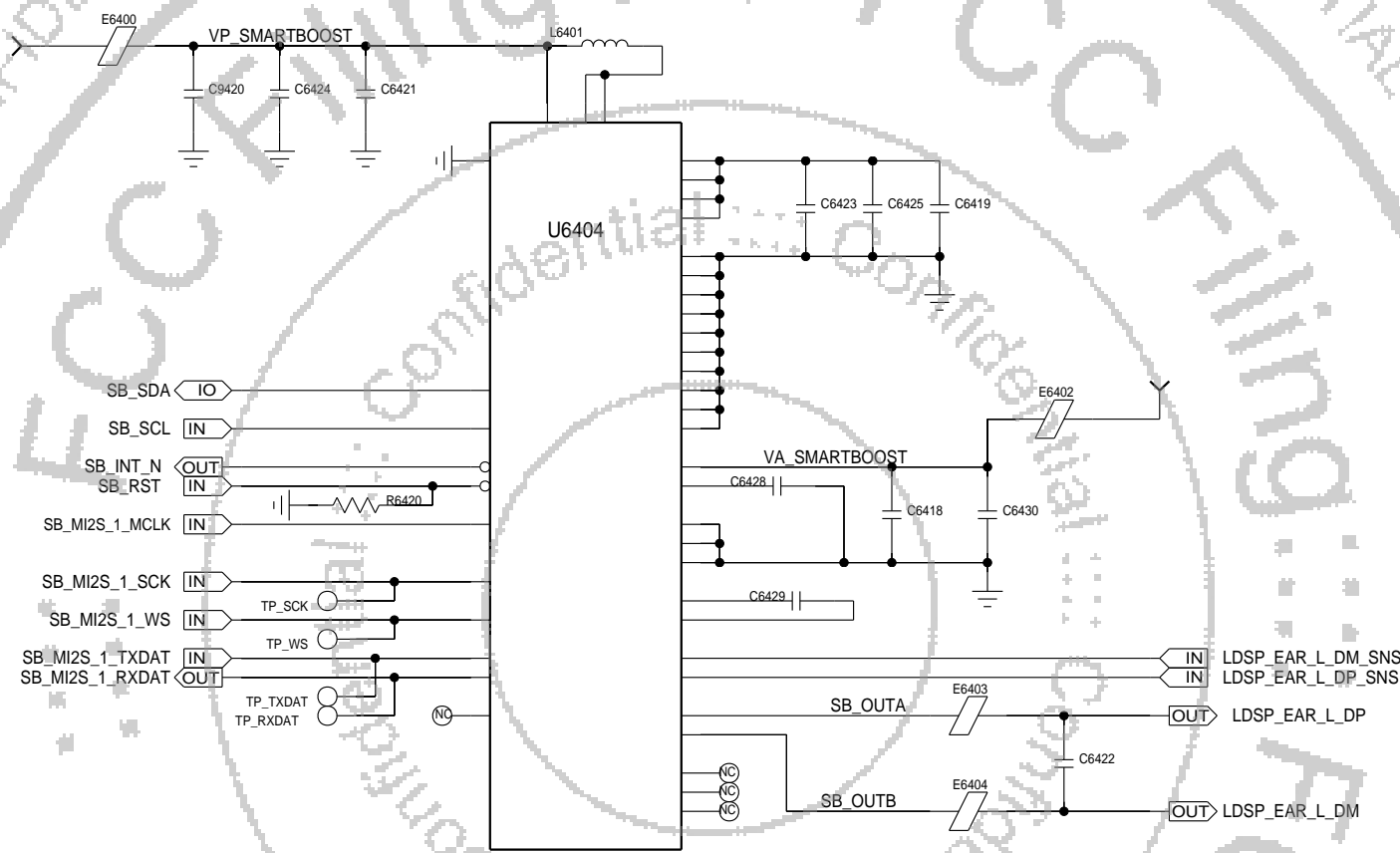

APPROVALS		MOTOROLA MOBILE DEVICES	
ENGINEER:		BLOCK TITLE:	
LAST MODIFIED BY:			
MOTOROLA CONFIDENTIAL RESTRICTED <small>THE DRAWING ON THIS PRINT AND INFORMATION THEREWITH ARE PROPRIETARY TO MOTOROLA AND SHALL NOT BE USED OR DISCUSSED IN WHOLE OR IN PART WITHOUT MOTOROLA'S CONSENT. © COPYRIGHT, MOTOROLA. THIS DOES NOT IMPLY PUBLICATION</small>		PROJECT NAME	REV
		CAD FILE NAME:	

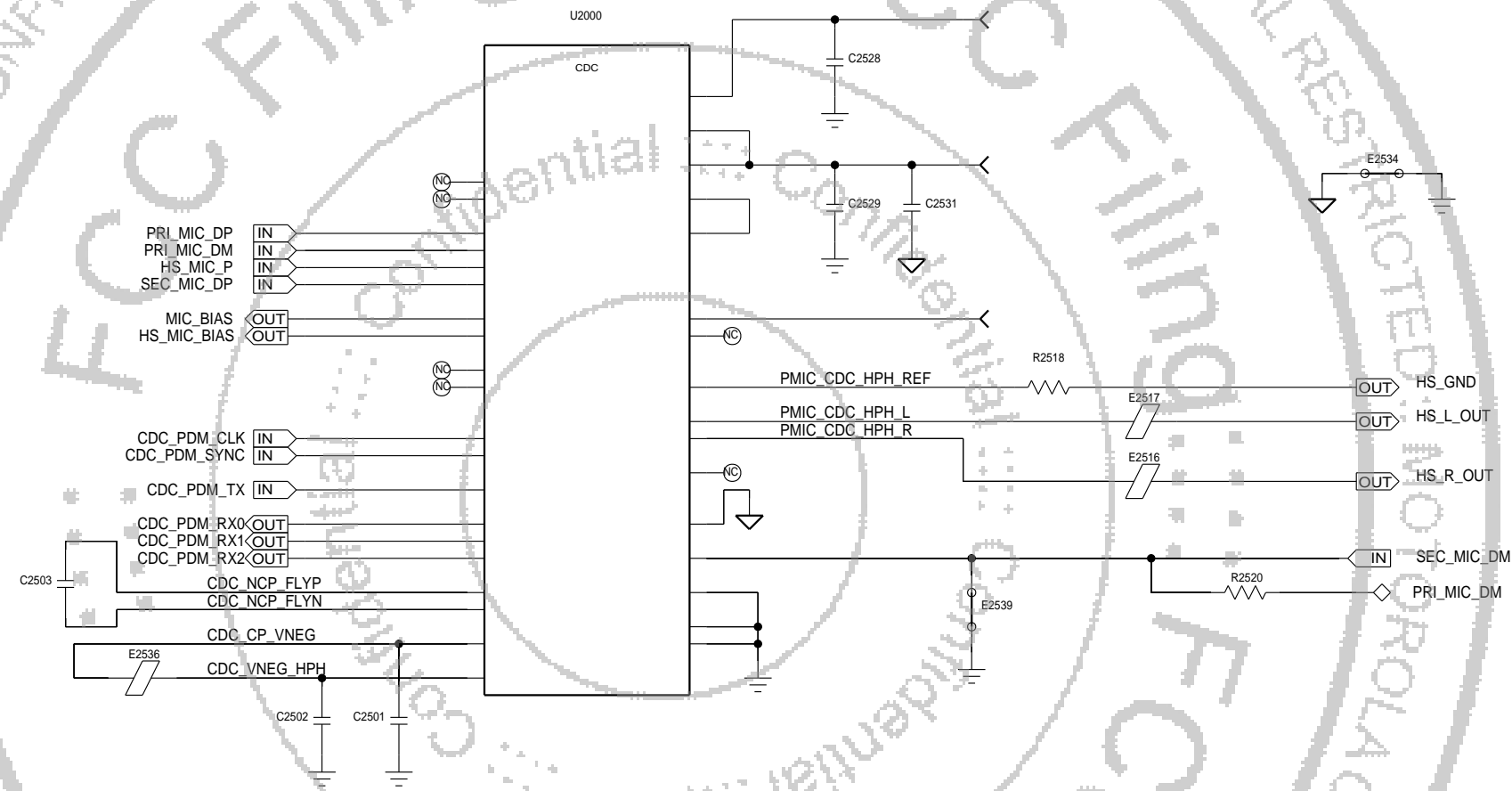

APPROVALS		MOTOROLA MOBILE DEVICES	
ENGINEER:		BLOCK TITLE:	
LAST MODIFIED BY:			
MOTOROLA CONFIDENTIAL RESTRICTED <small>THE DRAWING ON THIS PRINT AND INFORMATION THEREWITH ARE PROPRIETARY TO MOTOROLA AND SHALL NOT BE USED OR DISCUSSED IN WHOLE OR IN PART WITHOUT MOTOROLA'S CONSENT. © COPYRIGHT, MOTOROLA. THIS DOES NOT IMPLY PUBLICATION</small>		PROJECT NAME	REV
		CAD FILE NAME:	

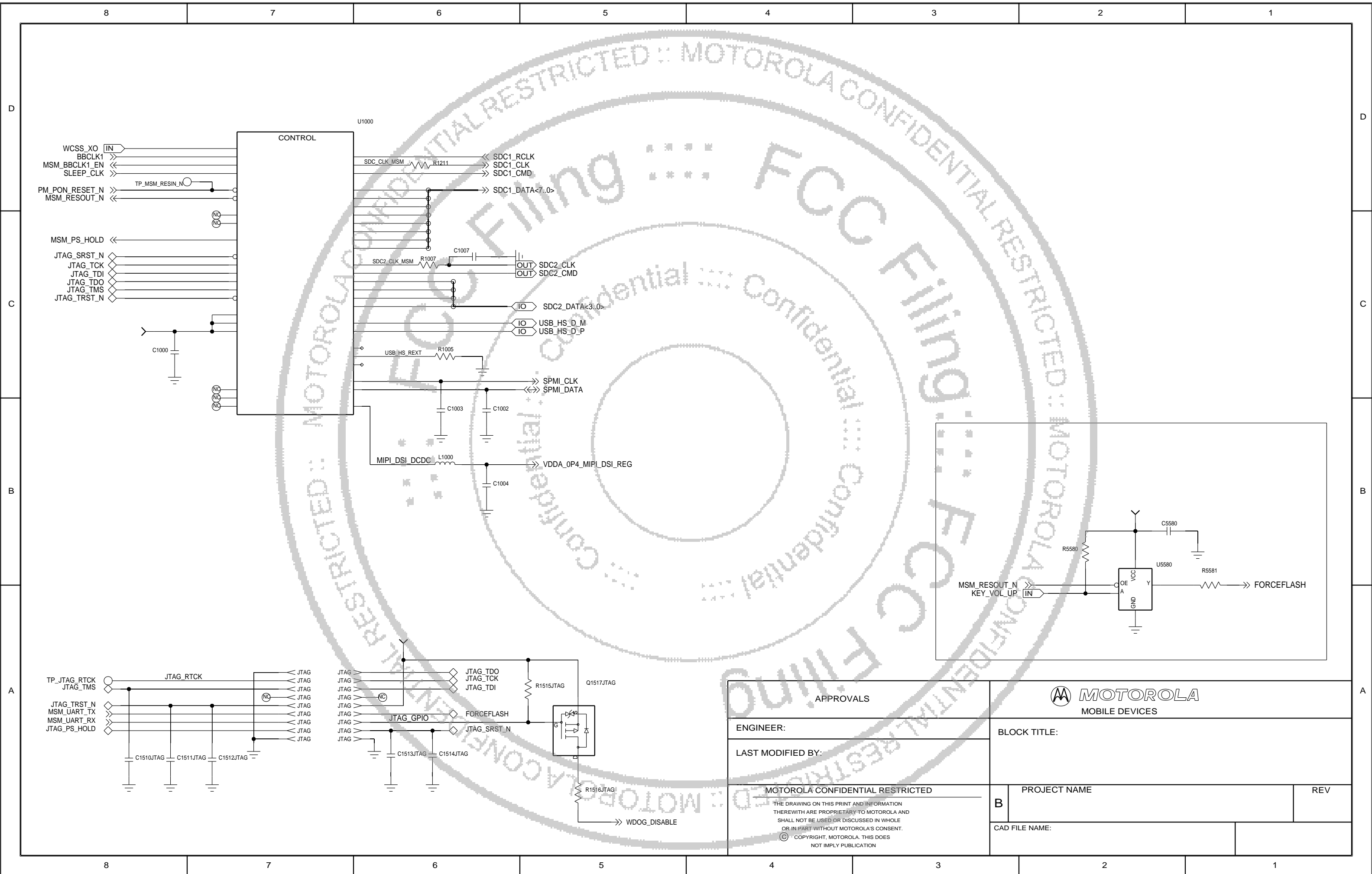

APPROVALS

ENGINEER:

LAST MODIFIED BY:

MOTOROLA CONFIDENTIAL RESTRICTED

THE DRAWING ON THIS PRINT AND INFORMATION THEREWITH ARE PROPRIETARY TO MOTOROLA AND SHALL NOT BE USED OR DISCUSSED IN WHOLE OR IN PART WITHOUT MOTOROLA'S CONSENT.

© COPYRIGHT, MOTOROLA. THIS DOES NOT IMPLY PUBLICATION

MOTOROLA
MOBILE DEVICES

BLOCK TITLE:

PROJECT NAME

REV

CAD FILE NAME:

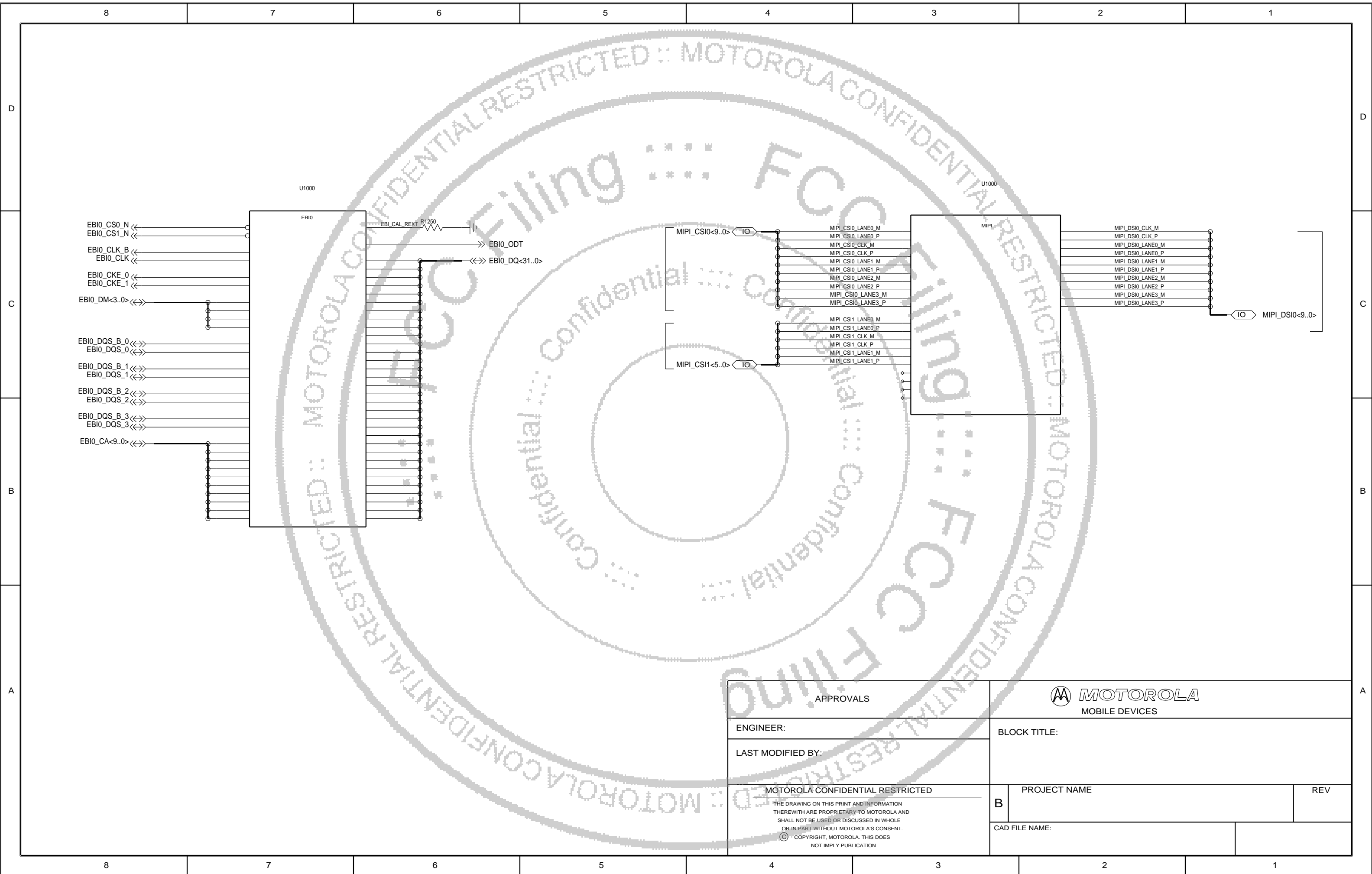

APPROVALS		MOTOROLA MOBILE DEVICES	
ENGINEER:		BLOCK TITLE:	
LAST MODIFIED BY:			
MOTOROLA CONFIDENTIAL RESTRICTED <small>THE DRAWING ON THIS PRINT AND INFORMATION THEREWITH ARE PROPRIETARY TO MOTOROLA AND SHALL NOT BE USED OR DISCUSSED IN WHOLE OR IN PART WITHOUT MOTOROLA'S CONSENT. © COPYRIGHT, MOTOROLA. THIS DOES NOT IMPLY PUBLICATION</small>		PROJECT NAME	REV
		CAD FILE NAME:	

D

C

B

A

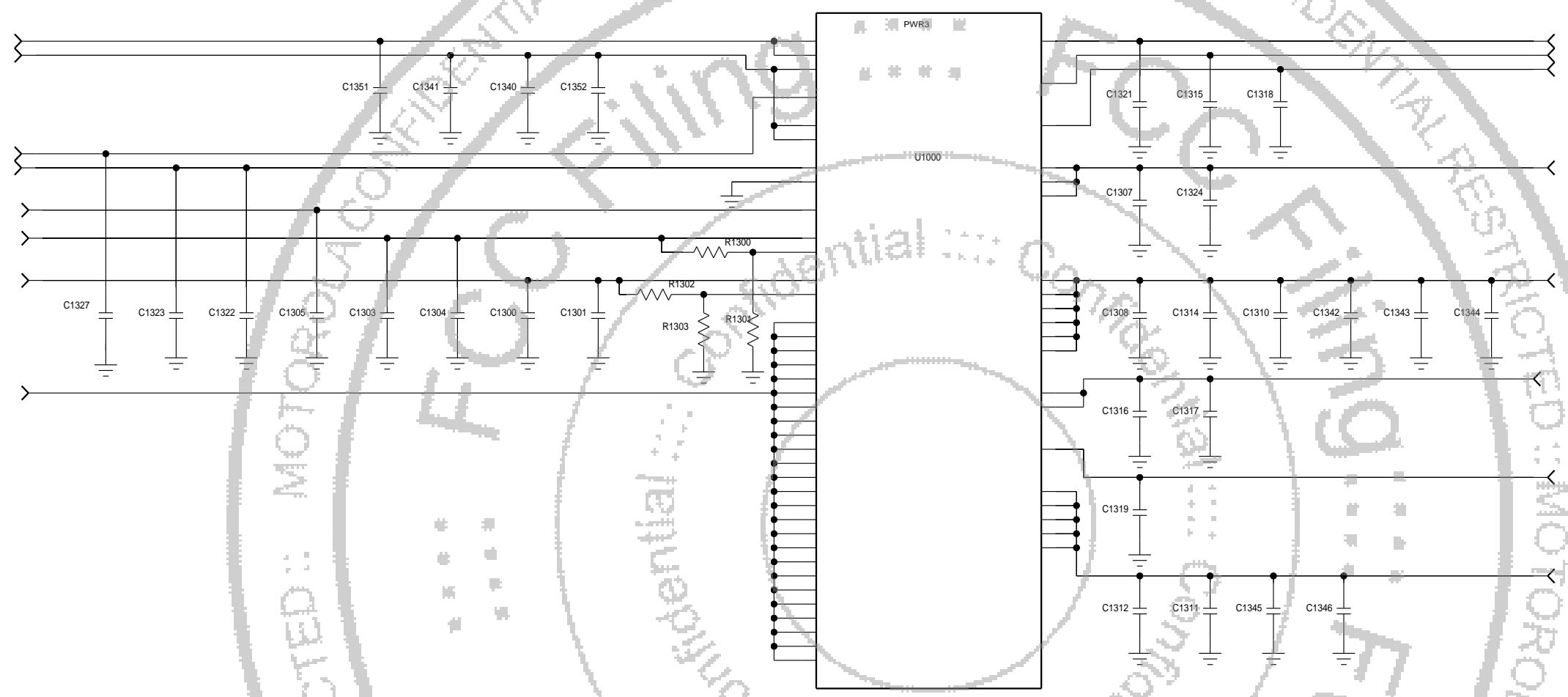

APPROVALS		MOTOROLA MOBILE DEVICES	
ENGINEER:		BLOCK TITLE:	
LAST MODIFIED BY:			
MOTOROLA CONFIDENTIAL RESTRICTED <small>THE DRAWING ON THIS PRINT AND INFORMATION THEREWITH ARE PROPRIETARY TO MOTOROLA AND SHALL NOT BE USED OR DISCUSSED IN WHOLE OR IN PART WITHOUT MOTOROLA'S CONSENT. © COPYRIGHT, MOTOROLA. THIS DOES NOT IMPLY PUBLICATION</small>		PROJECT NAME	REV
		CAD FILE NAME:	

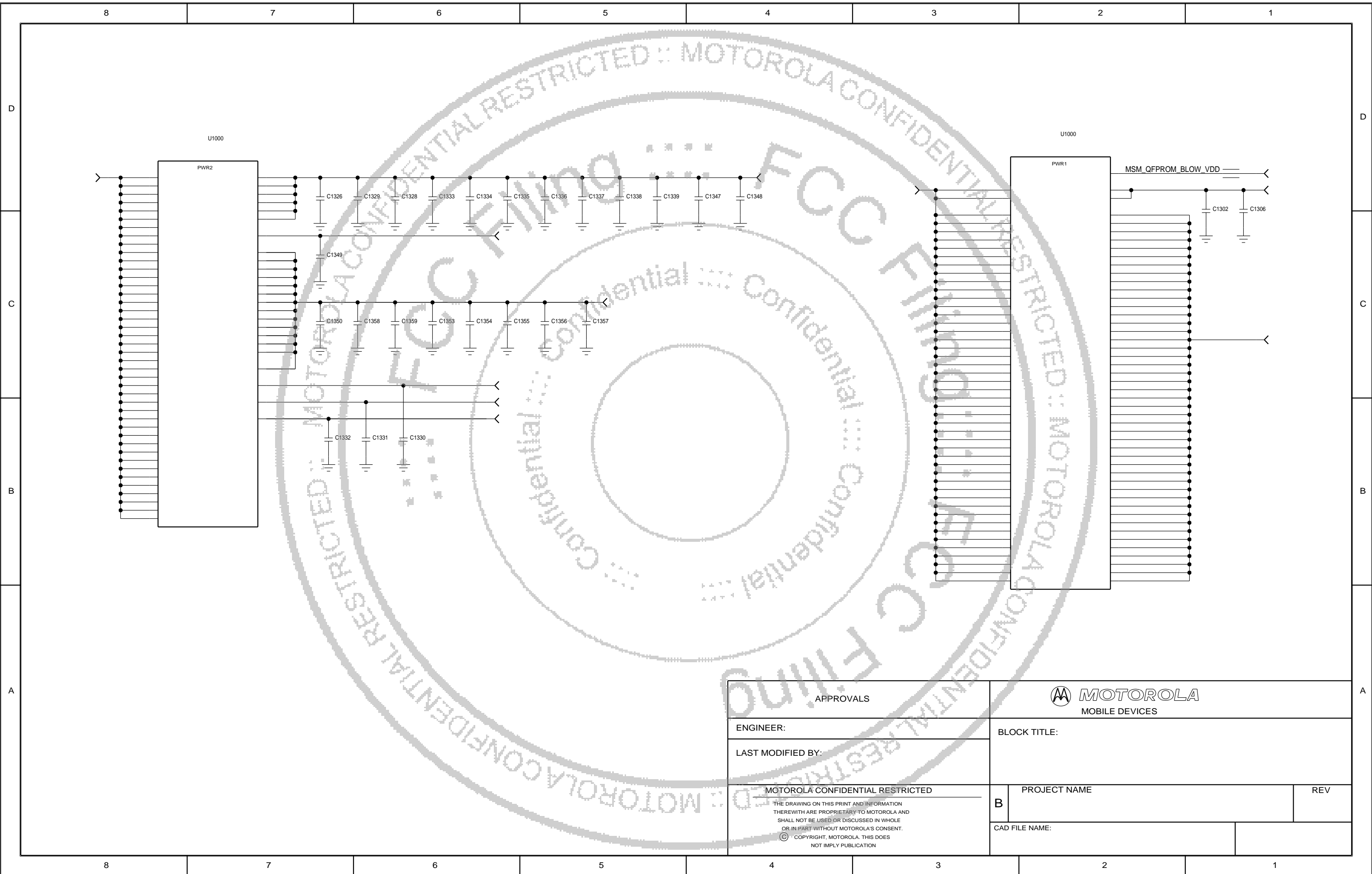

APPROVALS		 MOTOROLA MOBILE DEVICES	
ENGINEER:		BLOCK TITLE:	
LAST MODIFIED BY:			
MOTOROLA CONFIDENTIAL RESTRICTED <small>THE DRAWING ON THIS PRINT AND INFORMATION THEREWITH ARE PROPRIETARY TO MOTOROLA AND SHALL NOT BE USED OR DISCUSSED IN WHOLE OR IN PART WITHOUT MOTOROLA'S CONSENT. © COPYRIGHT, MOTOROLA. THIS DOES NOT IMPLY PUBLICATION</small>		PROJECT NAME	REV
		CAD FILE NAME:	

8 7 6 5 4 3 2 1

D

D

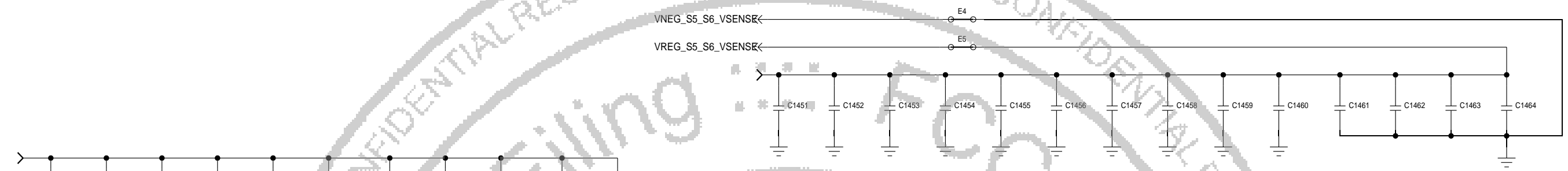

C

C

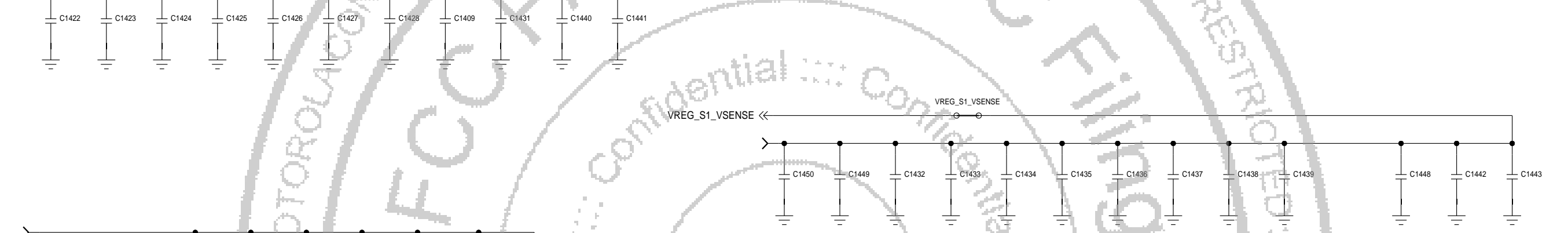

B

B

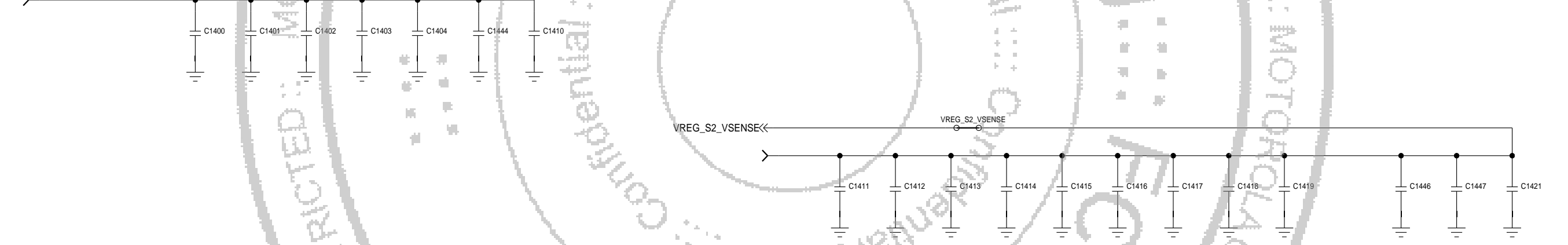

A

A

APPROVALS		MOTOROLA MOBILE DEVICES	
ENGINEER:		BLOCK TITLE:	
LAST MODIFIED BY:			
MOTOROLA CONFIDENTIAL RESTRICTED THE DRAWING ON THIS PRINT AND INFORMATION THEREWITH ARE PROPRIETARY TO MOTOROLA AND SHALL NOT BE USED OR DISCUSSED IN WHOLE OR IN PART WITHOUT MOTOROLA'S CONSENT. © COPYRIGHT, MOTOROLA. THIS DOES NOT IMPLY PUBLICATION		PROJECT NAME	REV
		CAD FILE NAME:	

8 7 6 5 4 3 2 1

8 7 6 5 4 3 2 1

D

C

B

A

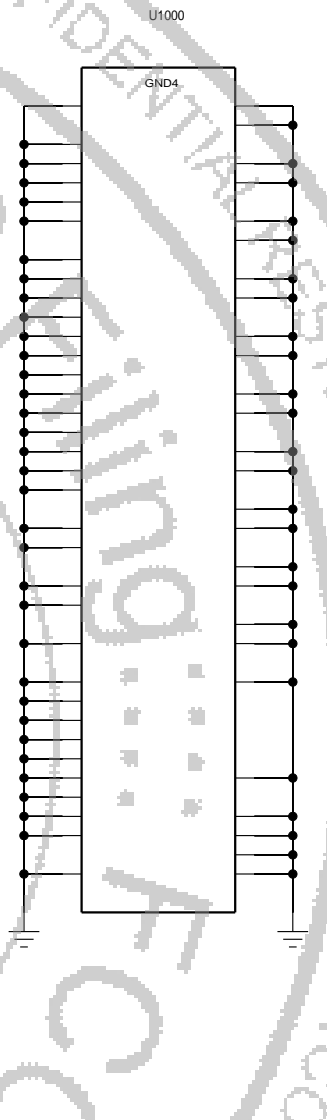
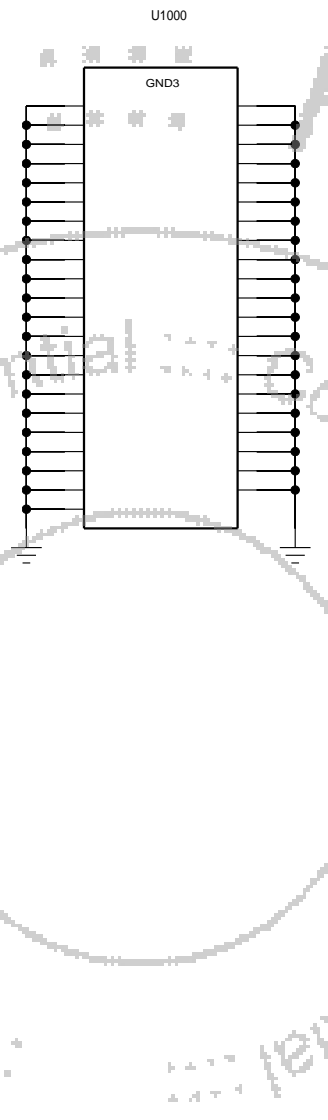
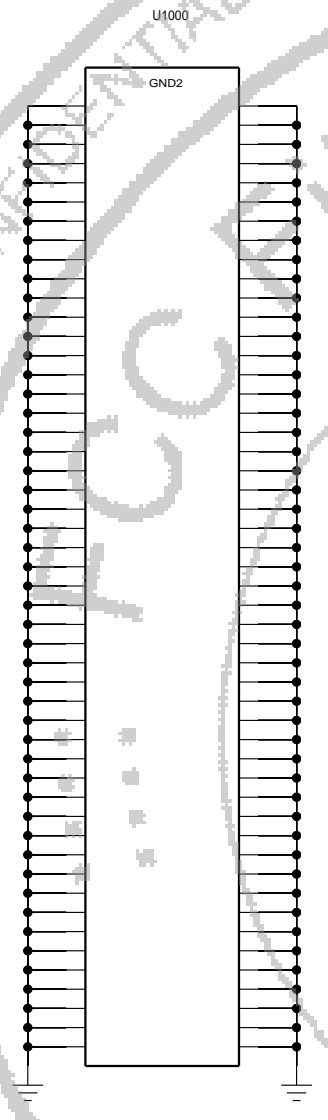
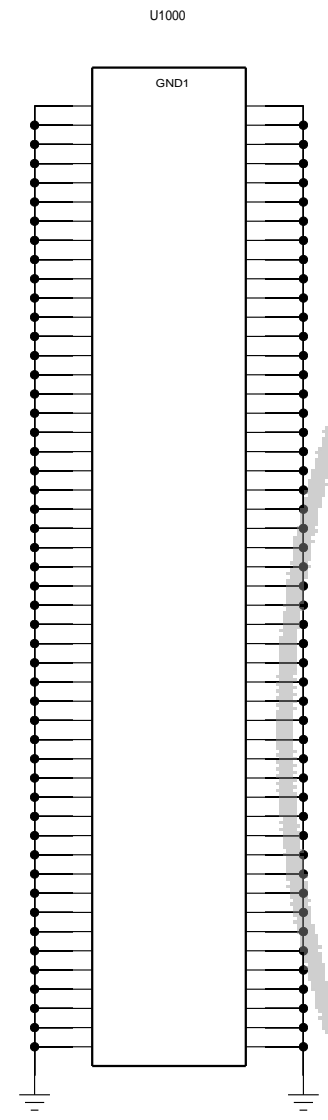

D

C

B

A

8 7 6 5 4 3 2 1

APPROVALS		 MOTOROLA MOBILE DEVICES	
ENGINEER:		BLOCK TITLE:	
LAST MODIFIED BY:			
MOTOROLA CONFIDENTIAL RESTRICTED <small>THE DRAWING ON THIS PRINT AND INFORMATION THEREWITH ARE PROPRIETARY TO MOTOROLA AND SHALL NOT BE USED OR DISCUSSED IN WHOLE OR IN PART WITHOUT MOTOROLA'S CONSENT. © COPYRIGHT, MOTOROLA. THIS DOES NOT IMPLY PUBLICATION</small>		PROJECT NAME	REV
		CAD FILE NAME:	

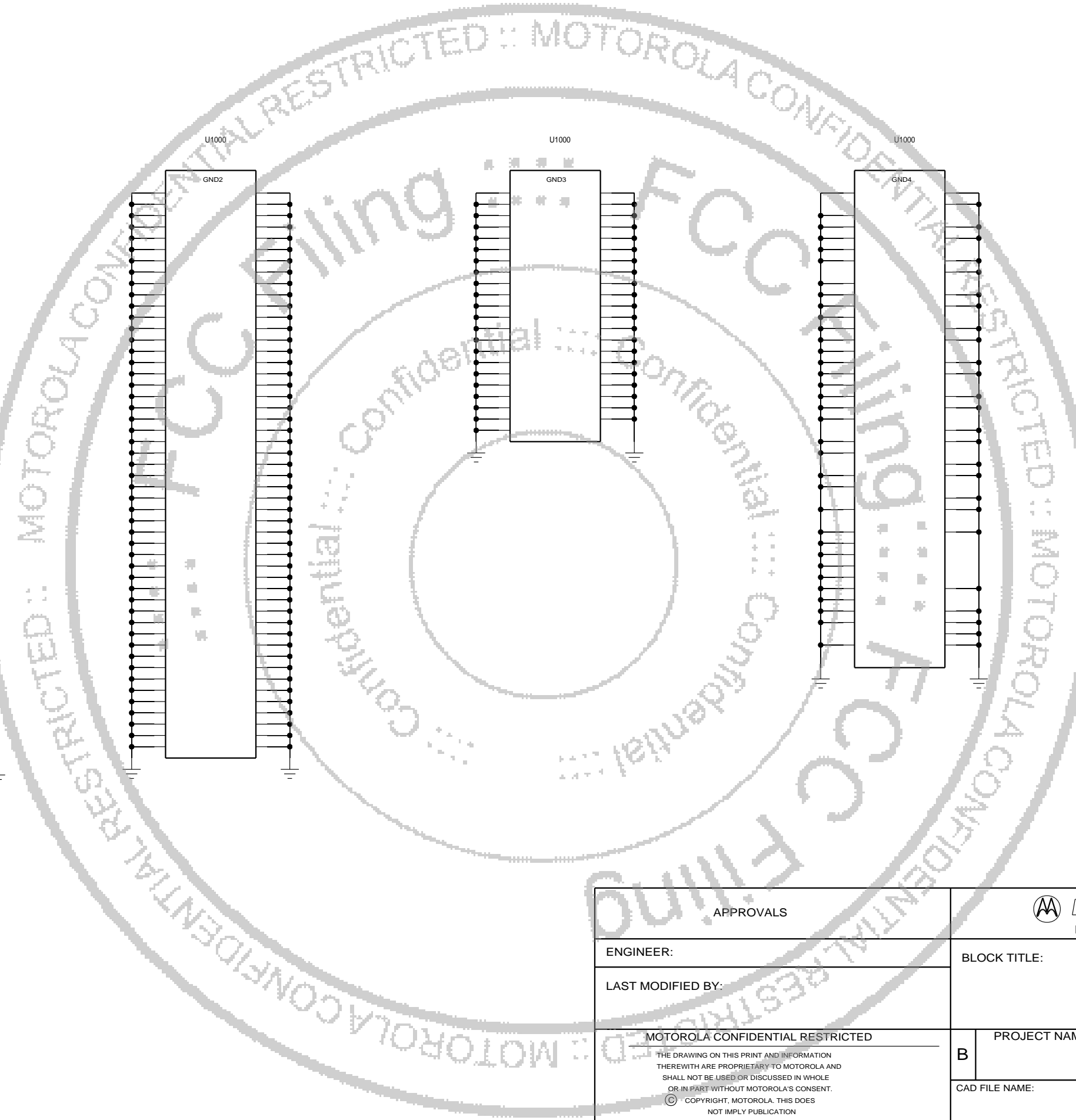

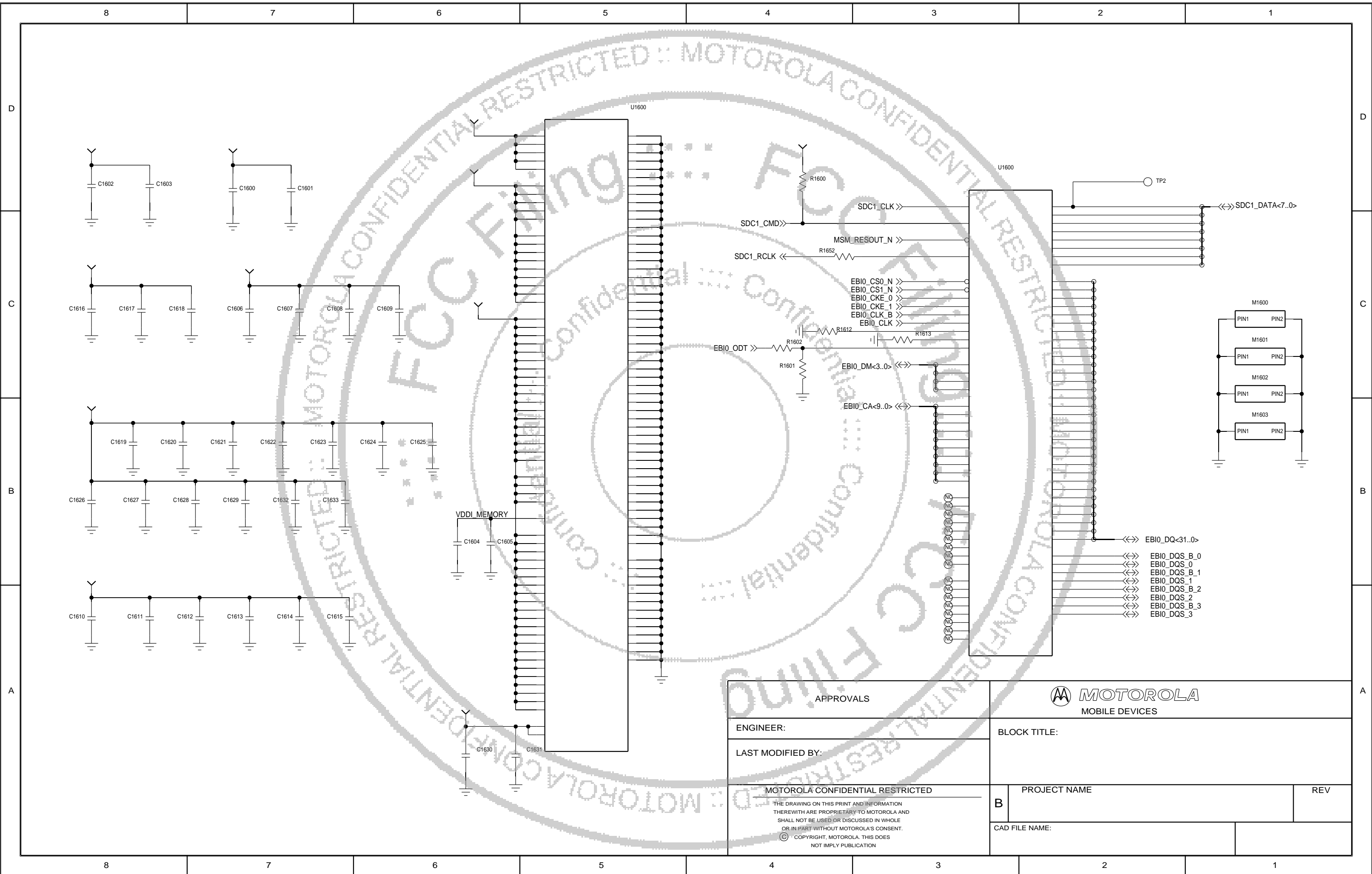

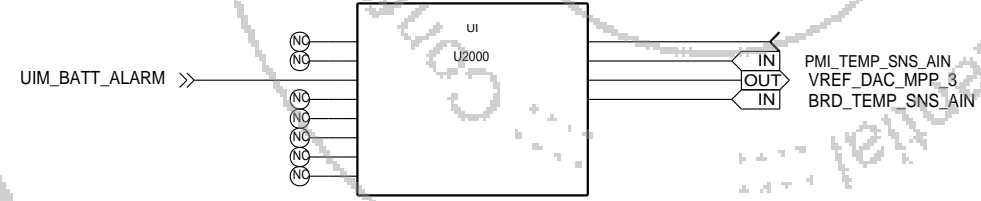
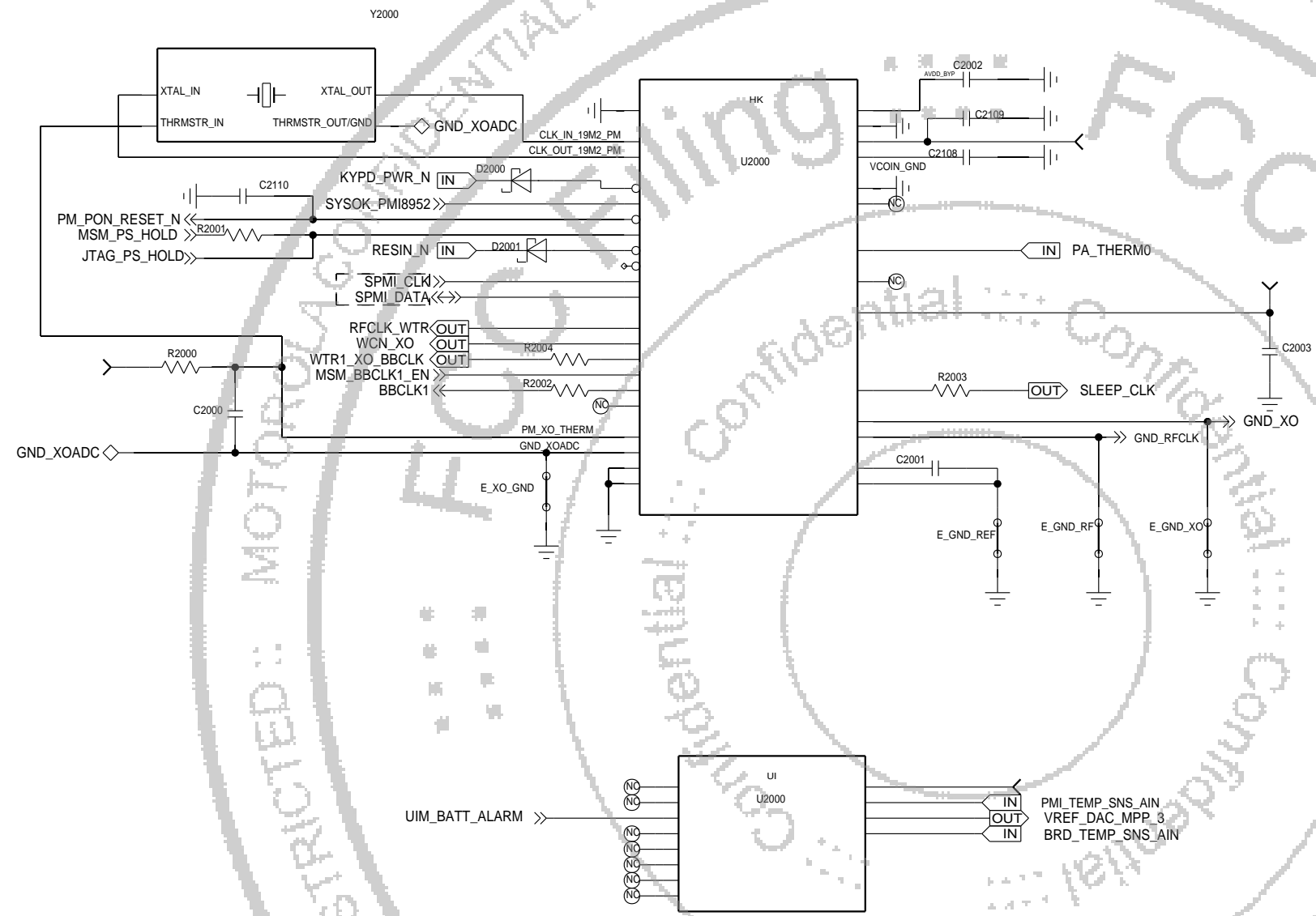

APPROVALS		MOTOROLA MOBILE DEVICES	
ENGINEER:		BLOCK TITLE:	
LAST MODIFIED BY:			
MOTOROLA CONFIDENTIAL RESTRICTED <small>THE DRAWING ON THIS PRINT AND INFORMATION THEREWITH ARE PROPRIETARY TO MOTOROLA AND SHALL NOT BE USED OR DISCUSSED IN WHOLE OR IN PART WITHOUT MOTOROLA'S CONSENT. © COPYRIGHT, MOTOROLA. THIS DOES NOT IMPLY PUBLICATION</small>		PROJECT NAME	REV
		CAD FILE NAME:	

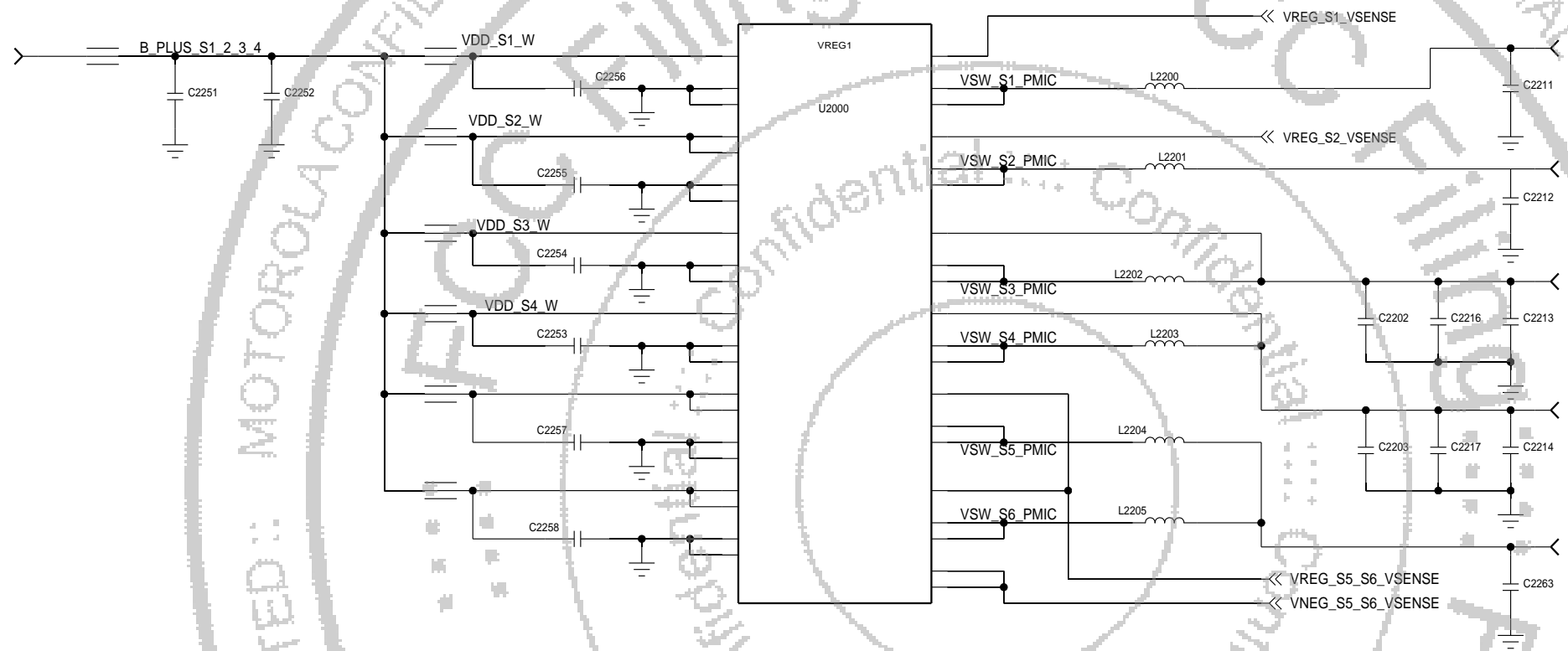

APPROVALS		MOTOROLA MOBILE DEVICES	
ENGINEER:		BLOCK TITLE:	
LAST MODIFIED BY:			
MOTOROLA CONFIDENTIAL RESTRICTED <small>THE DRAWING ON THIS PRINT AND INFORMATION THEREWITH ARE PROPRIETARY TO MOTOROLA AND SHALL NOT BE USED OR DISCUSSED IN WHOLE OR IN PART WITHOUT MOTOROLA'S CONSENT.</small> <small>© COPYRIGHT, MOTOROLA. THIS DOES NOT IMPLY PUBLICATION</small>		PROJECT NAME	REV
		CAD FILE NAME:	



APPROVALS		 MOTOROLA MOBILE DEVICES	
ENGINEER:		BLOCK TITLE:	
LAST MODIFIED BY:			
MOTOROLA CONFIDENTIAL RESTRICTED <small>THE DRAWING ON THIS PRINT AND INFORMATION THEREWITH ARE PROPRIETARY TO MOTOROLA AND SHALL NOT BE USED OR DISCUSSED IN WHOLE OR IN PART WITHOUT MOTOROLA'S CONSENT. © COPYRIGHT, MOTOROLA. THIS DOES NOT IMPLY PUBLICATION</small>		PROJECT NAME	REV
		CAD FILE NAME:	

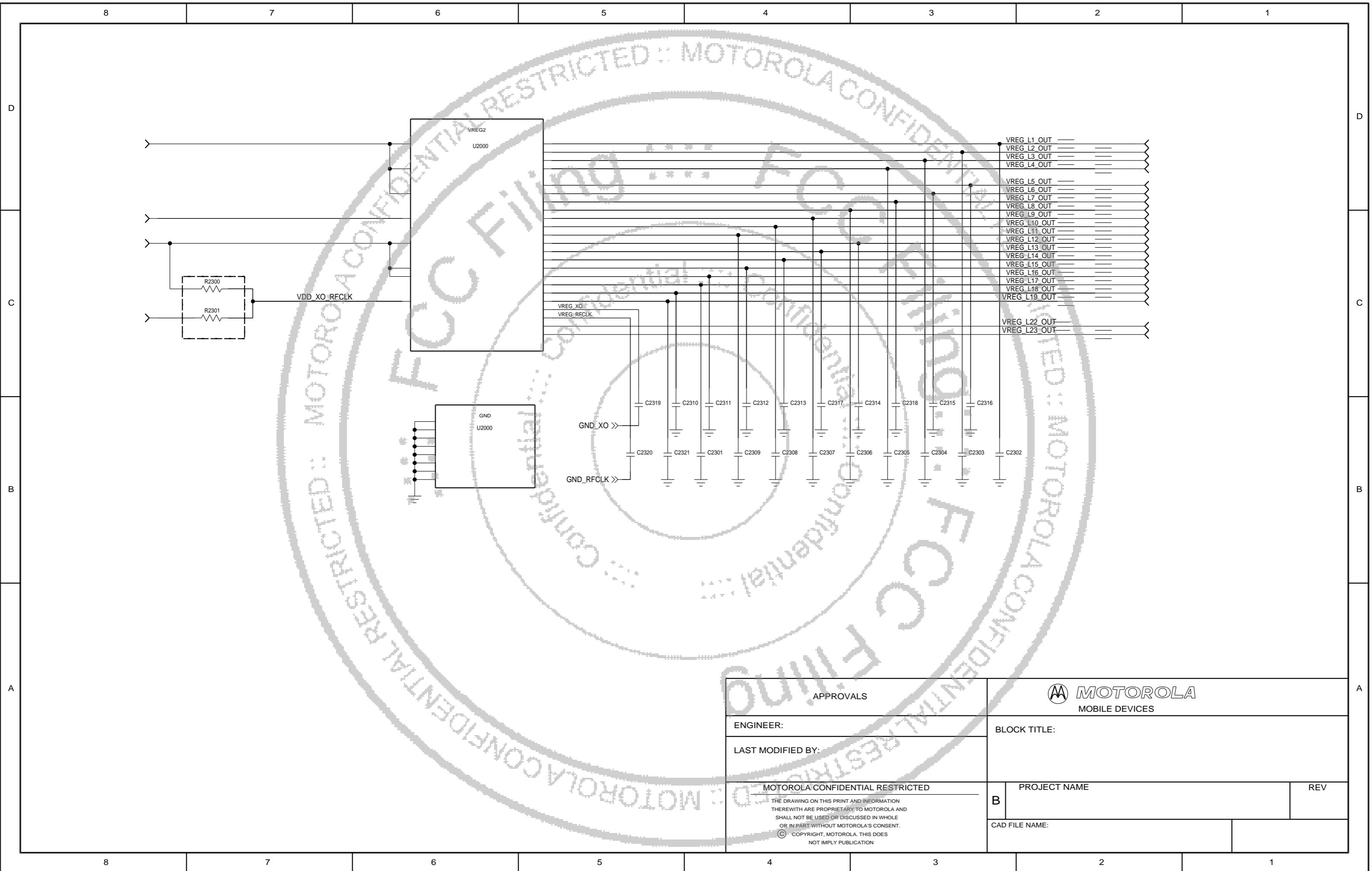

APPROVALS



ENGINEER:

BLOCK TITLE:

LAST MODIFIED BY:

PROJECT NAME REV

MOTOROLA CONFIDENTIAL RESTRICTED
 THE DRAWING ON THIS PRINT AND INFORMATION THEREWITH ARE PROPRIETARY TO MOTOROLA AND SHALL NOT BE USED OR DISCUSSED IN WHOLE OR IN PART WITHOUT MOTOROLA'S CONSENT.
 © COPYRIGHT, MOTOROLA. THIS DOES NOT IMPLY PUBLICATION

CAD FILE NAME:

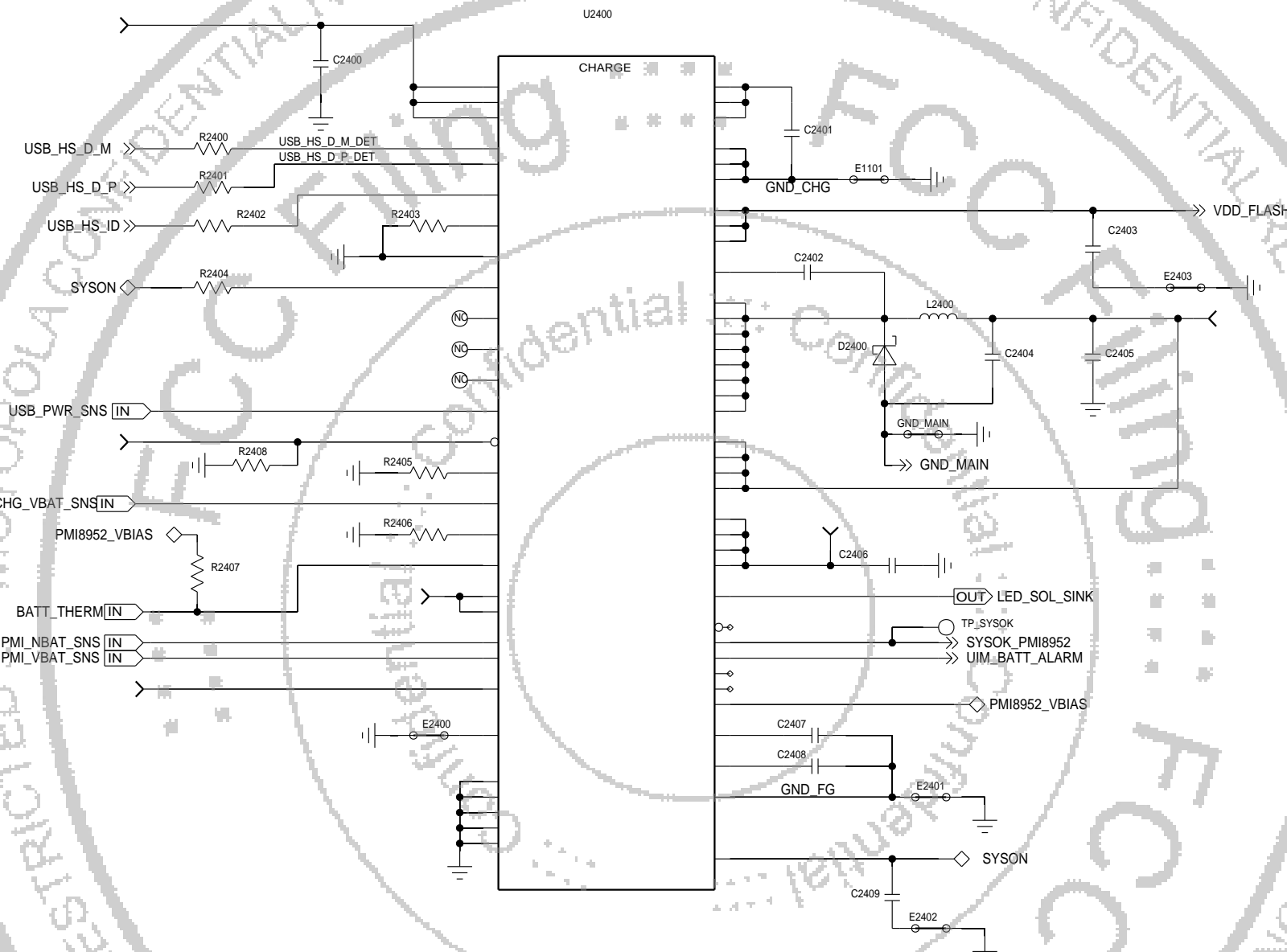

APPROVALS		MOTOROLA MOBILE DEVICES	
ENGINEER:		BLOCK TITLE:	
LAST MODIFIED BY:			
MOTOROLA CONFIDENTIAL RESTRICTED <small>THE DRAWING ON THIS PRINT AND INFORMATION THEREWITH ARE PROPRIETARY TO MOTOROLA AND SHALL NOT BE USED OR DISCUSSED IN WHOLE OR IN PART WITHOUT MOTOROLA'S CONSENT. © COPYRIGHT, MOTOROLA. THIS DOES NOT IMPLY PUBLICATION</small>		PROJECT NAME	REV
		CAD FILE NAME:	

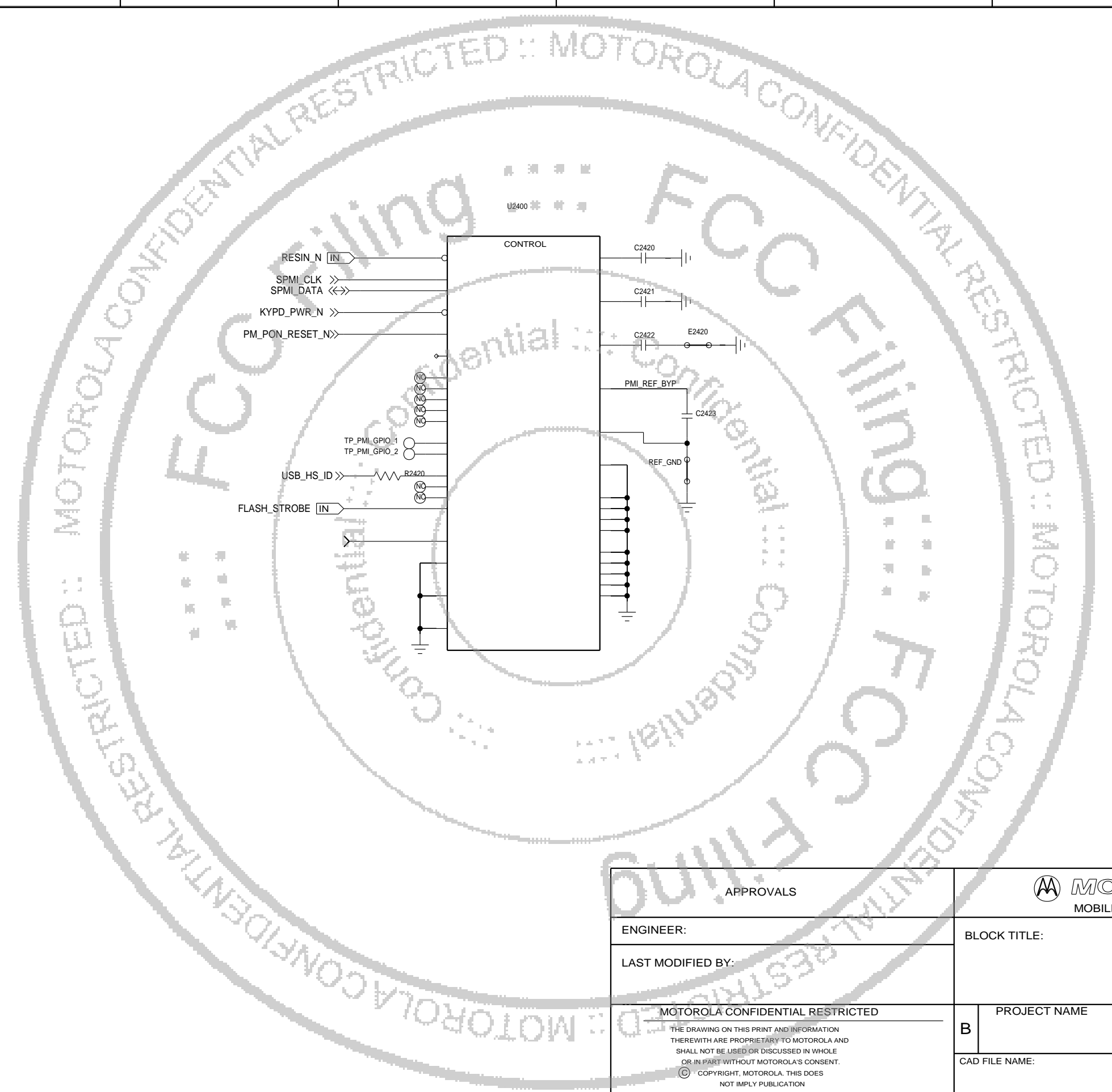

APPROVALS		MOTOROLA MOBILE DEVICES	
ENGINEER:		BLOCK TITLE:	
LAST MODIFIED BY:			
MOTOROLA CONFIDENTIAL RESTRICTED <small>THE DRAWING ON THIS PRINT AND INFORMATION THEREWITH ARE PROPRIETARY TO MOTOROLA AND SHALL NOT BE USED OR DISCUSSED IN WHOLE OR IN PART WITHOUT MOTOROLA'S CONSENT. © COPYRIGHT, MOTOROLA. THIS DOES NOT IMPLY PUBLICATION</small>		PROJECT NAME	REV
		CAD FILE NAME:	

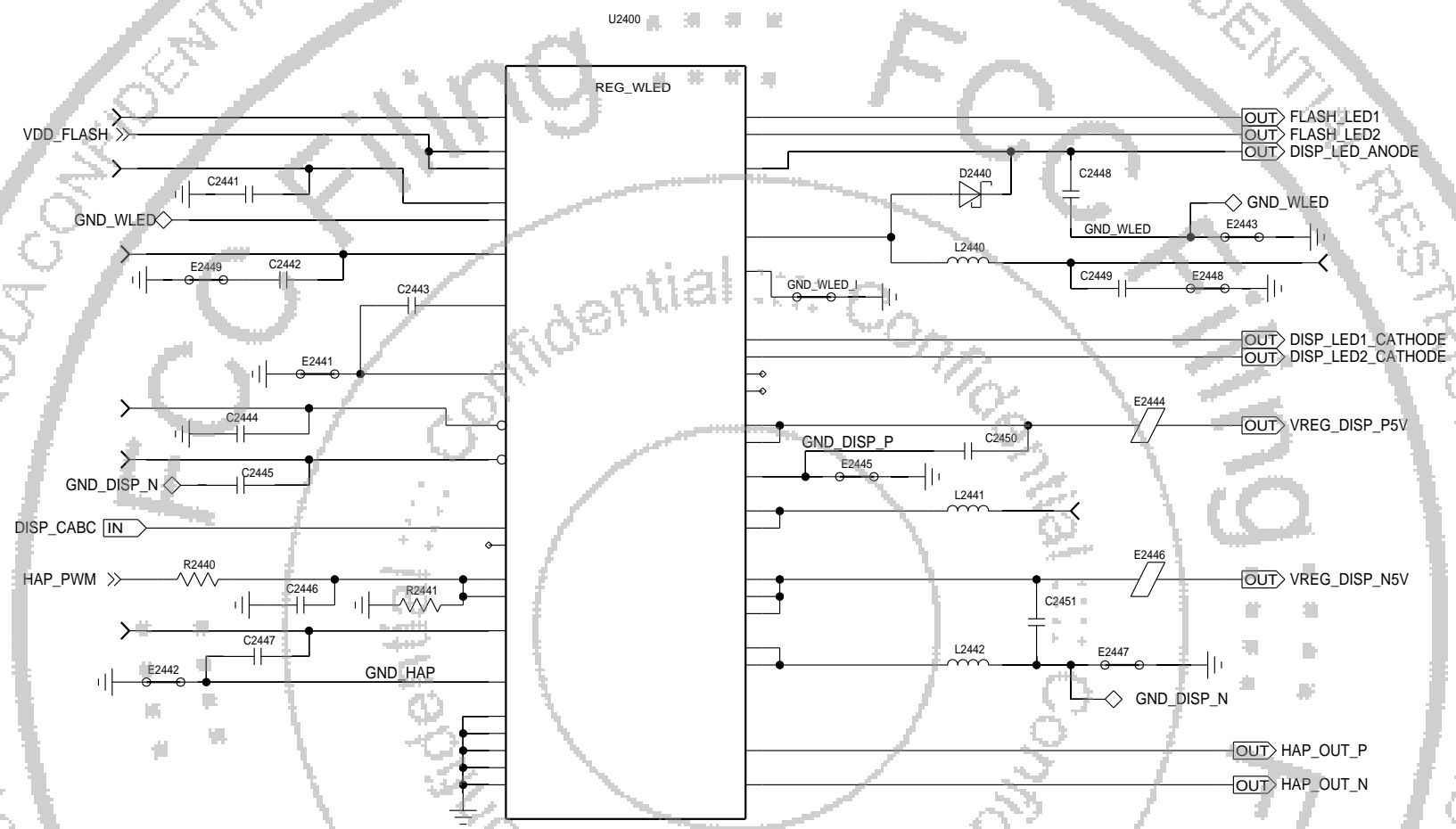

APPROVALS		MOTOROLA MOBILE DEVICES	
ENGINEER:		BLOCK TITLE:	
LAST MODIFIED BY:			
MOTOROLA CONFIDENTIAL RESTRICTED <small>THE DRAWING ON THIS PRINT AND INFORMATION THEREWITH ARE PROPRIETARY TO MOTOROLA AND SHALL NOT BE USED OR DISCUSSED IN WHOLE OR IN PART WITHOUT MOTOROLA'S CONSENT. © COPYRIGHT, MOTOROLA. THIS DOES NOT IMPLY PUBLICATION</small>		PROJECT NAME	REV
		CAD FILE NAME:	

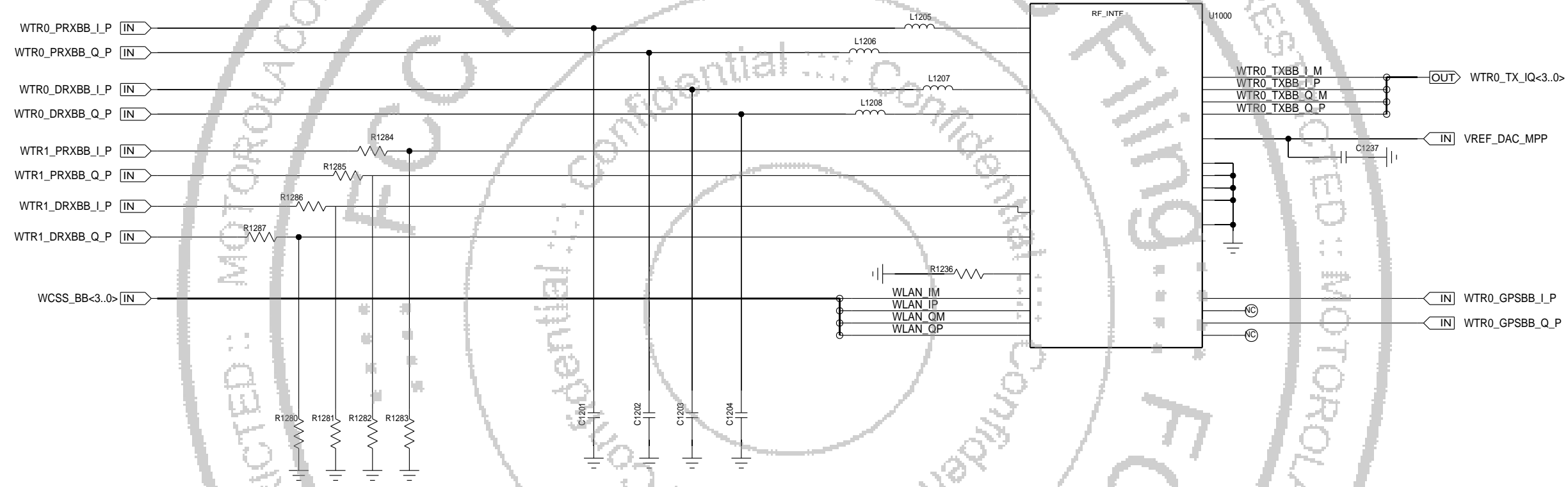

APPROVALS		MOTOROLA MOBILE DEVICES	
ENGINEER:		BLOCK TITLE:	
LAST MODIFIED BY:			
MOTOROLA CONFIDENTIAL RESTRICTED <small>THE DRAWING ON THIS PRINT AND INFORMATION THEREWITH ARE PROPRIETARY TO MOTOROLA AND SHALL NOT BE USED OR DISCUSSED IN WHOLE OR IN PART WITHOUT MOTOROLA'S CONSENT. © COPYRIGHT, MOTOROLA. THIS DOES NOT IMPLY PUBLICATION</small>		PROJECT NAME	REV
		CAD FILE NAME:	

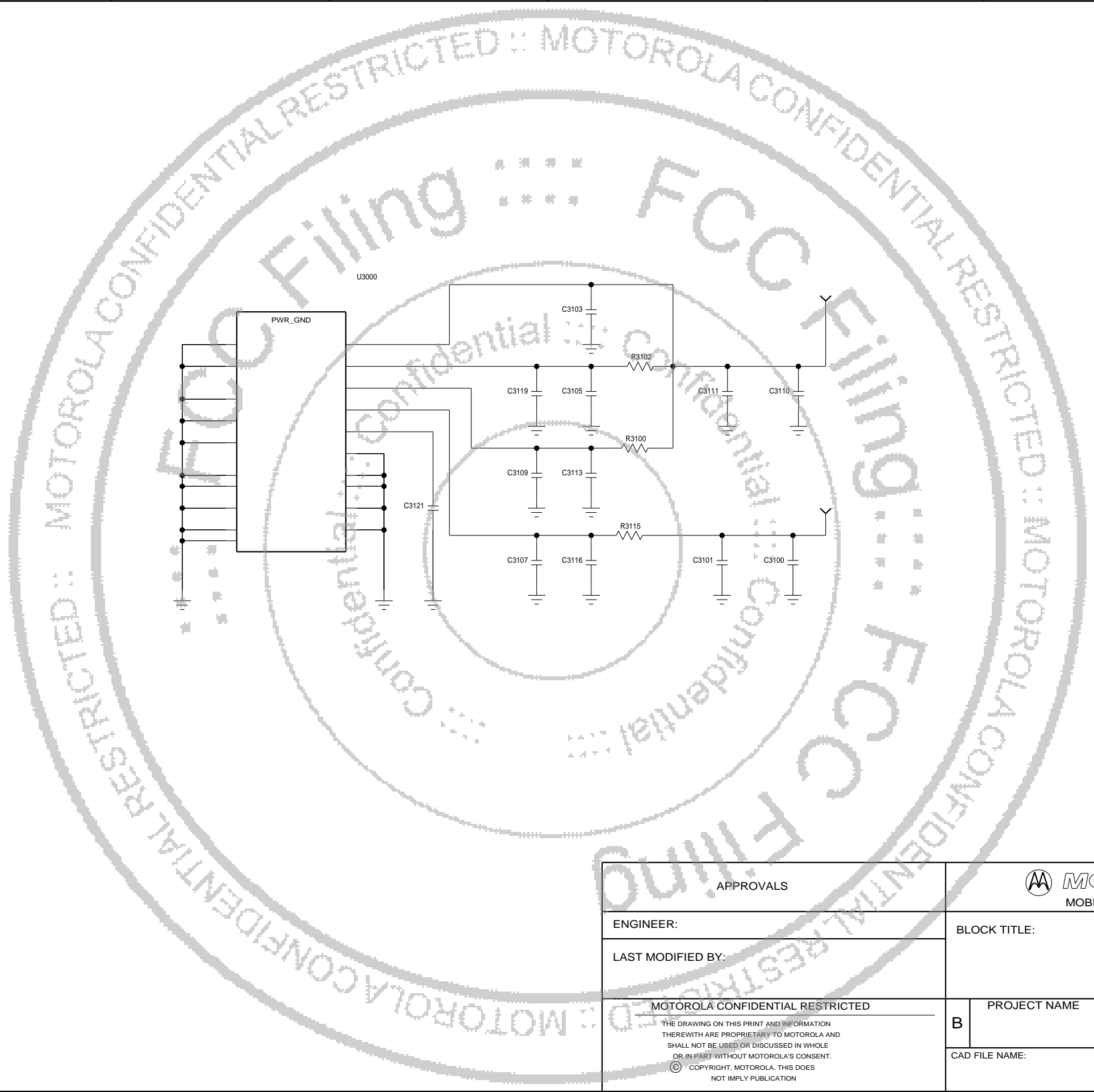

APPROVALS		MOTOROLA MOBILE DEVICES	
ENGINEER:		BLOCK TITLE:	
LAST MODIFIED BY:			
MOTOROLA CONFIDENTIAL RESTRICTED THE DRAWING ON THIS PRINT AND INFORMATION THEREWITH ARE PROPRIETARY TO MOTOROLA AND SHALL NOT BE USED OR DISCUSSED IN WHOLE OR IN PART WITHOUT MOTOROLA'S CONSENT. © COPYRIGHT, MOTOROLA. THIS DOES NOT IMPLY PUBLICATION		PROJECT NAME	REV
		CAD FILE NAME:	

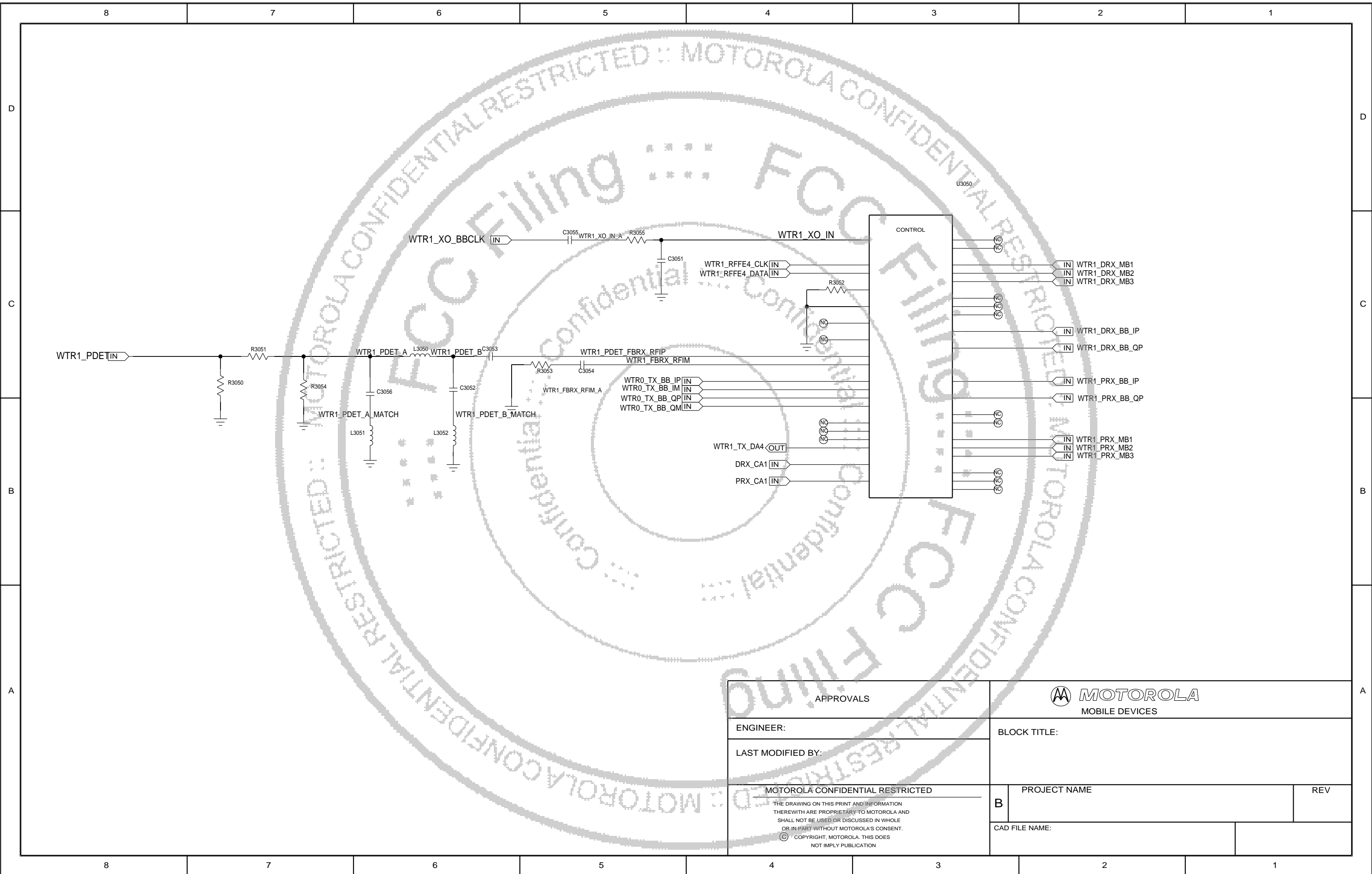

APPROVALS		MOTOROLA MOBILE DEVICES	
ENGINEER:		BLOCK TITLE:	
LAST MODIFIED BY:			
MOTOROLA CONFIDENTIAL RESTRICTED <small>THE DRAWING ON THIS PRINT AND INFORMATION THEREWITH ARE PROPRIETARY TO MOTOROLA AND SHALL NOT BE USED OR DISCUSSED IN WHOLE OR IN PART WITHOUT MOTOROLA'S CONSENT. © COPYRIGHT, MOTOROLA. THIS DOES NOT IMPLY PUBLICATION</small>		PROJECT NAME	REV
		CAD FILE NAME:	

8 7 6 5 4 3 2 1

D

C

B

A

D

C

B

A

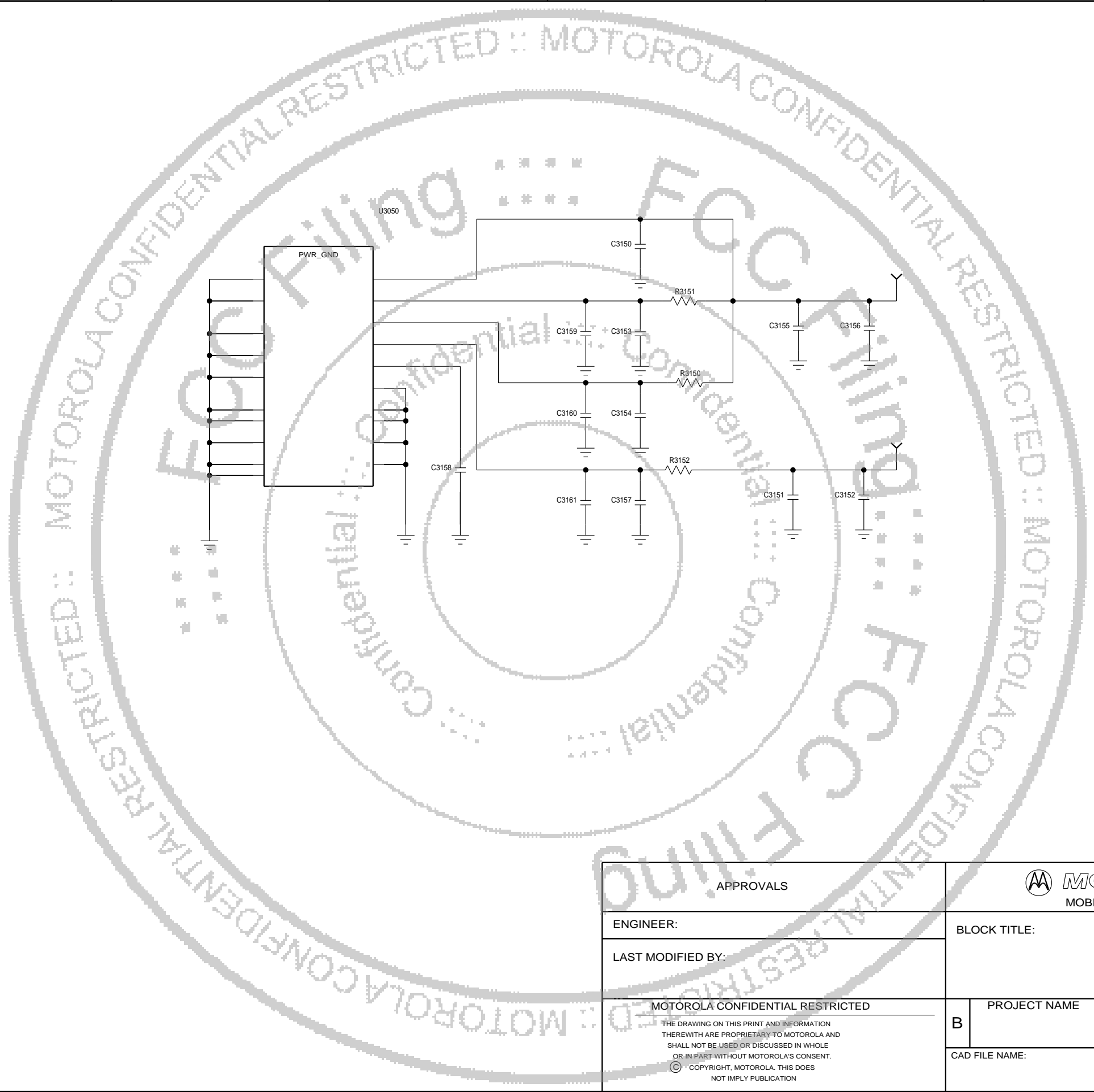

APPROVALS		 MOTOROLA MOBILE DEVICES	
ENGINEER:		BLOCK TITLE:	
LAST MODIFIED BY:			
MOTOROLA CONFIDENTIAL RESTRICTED <small>THE DRAWING ON THIS PRINT AND INFORMATION THEREWITH ARE PROPRIETARY TO MOTOROLA AND SHALL NOT BE USED OR DISCUSSED IN WHOLE OR IN PART WITHOUT MOTOROLA'S CONSENT. © COPYRIGHT, MOTOROLA. THIS DOES NOT IMPLY PUBLICATION</small>		PROJECT NAME	REV
		CAD FILE NAME:	

8 7 6 5 4 3 2 1

REVISIONS				
ZONE	LTR	DESCRIPTION	DATE	APPR.

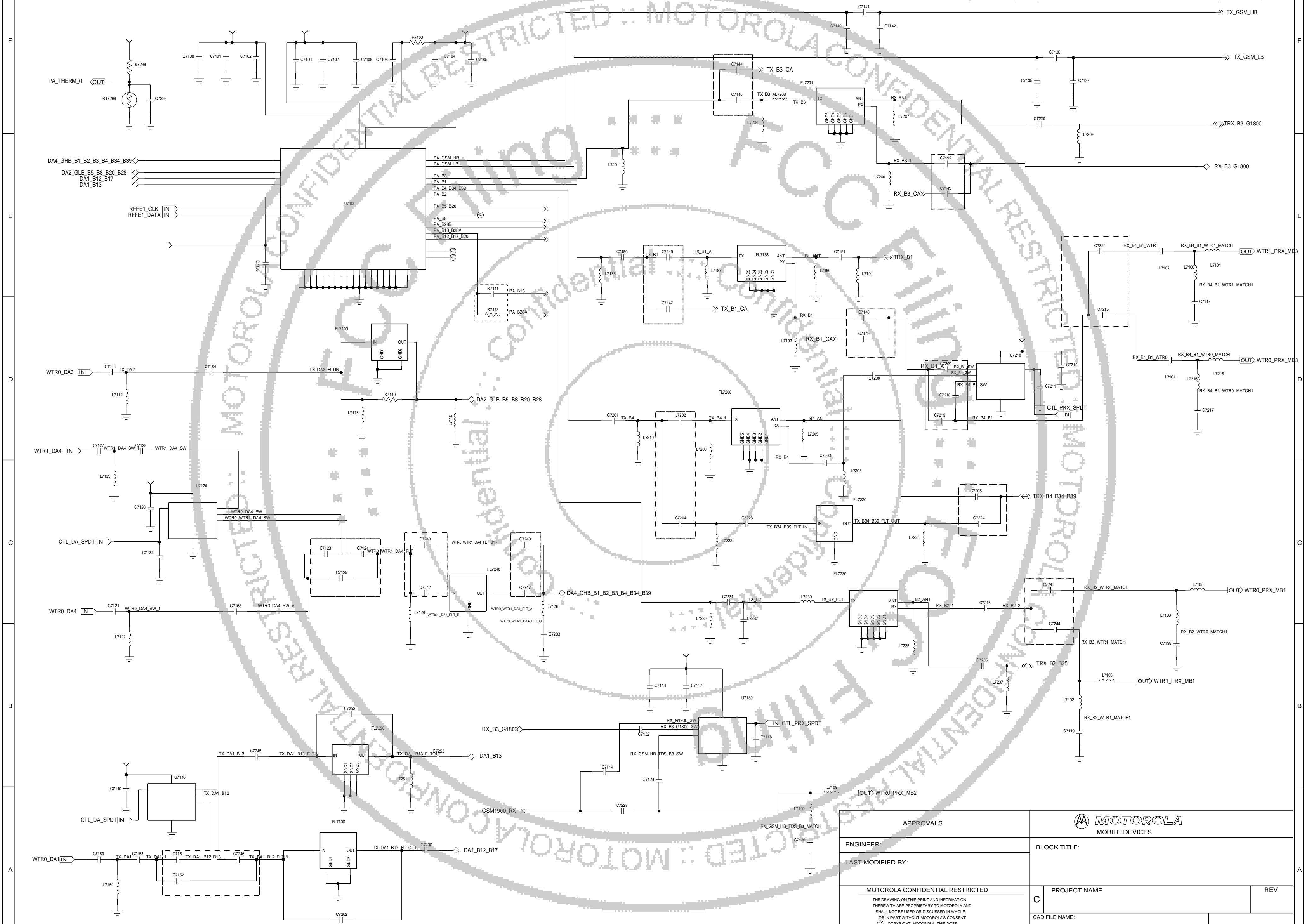

APPROVALS		MOTOROLA MOBILE DEVICES	
ENGINEER:	BLOCK TITLE:		
LAST MODIFIED BY:	PROJECT NAME		
MOTOROLA CONFIDENTIAL RESTRICTED		CAD FILE NAME:	REV
<small>THE DRAWING ON THIS PRINT AND INFORMATION THEREWITH ARE PROPRIETARY TO MOTOROLA AND SHALL NOT BE USED OR DISCUSSED IN WHOLE OR IN PART WITHOUT MOTOROLA'S CONSENT. © COPYRIGHT, MOTOROLA, THIS DOES NOT IMPLY PUBLICATION.</small>			

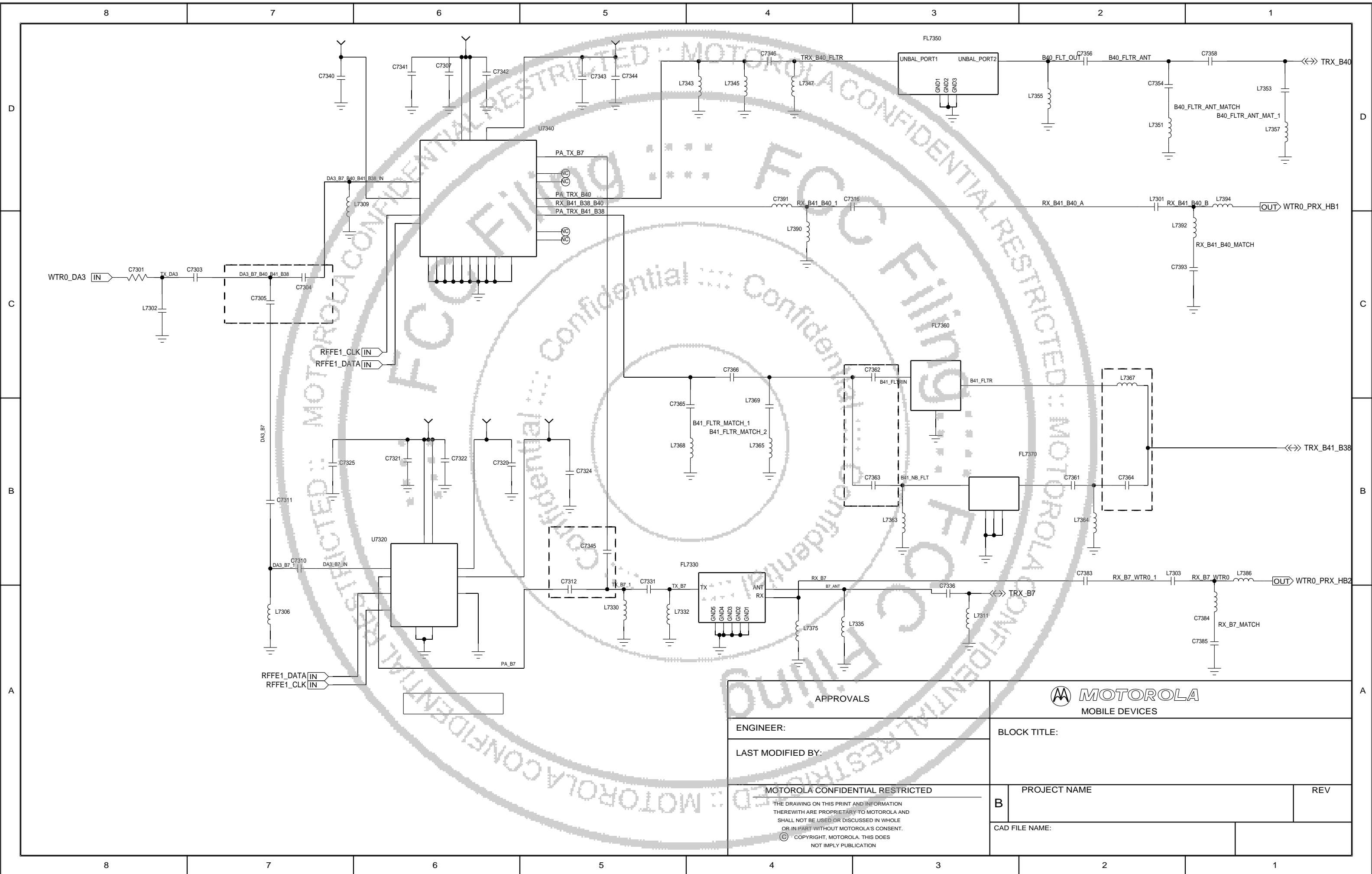

APPROVALS		MOTOROLA MOBILE DEVICES	
ENGINEER:		BLOCK TITLE:	
LAST MODIFIED BY:			
MOTOROLA CONFIDENTIAL RESTRICTED <small>THE DRAWING ON THIS PRINT AND INFORMATION THEREWITH ARE PROPRIETARY TO MOTOROLA AND SHALL NOT BE USED OR DISCUSSED IN WHOLE OR IN PART WITHOUT MOTOROLA'S CONSENT. © COPYRIGHT, MOTOROLA. THIS DOES NOT IMPLY PUBLICATION</small>		PROJECT NAME	REV
		CAD FILE NAME:	

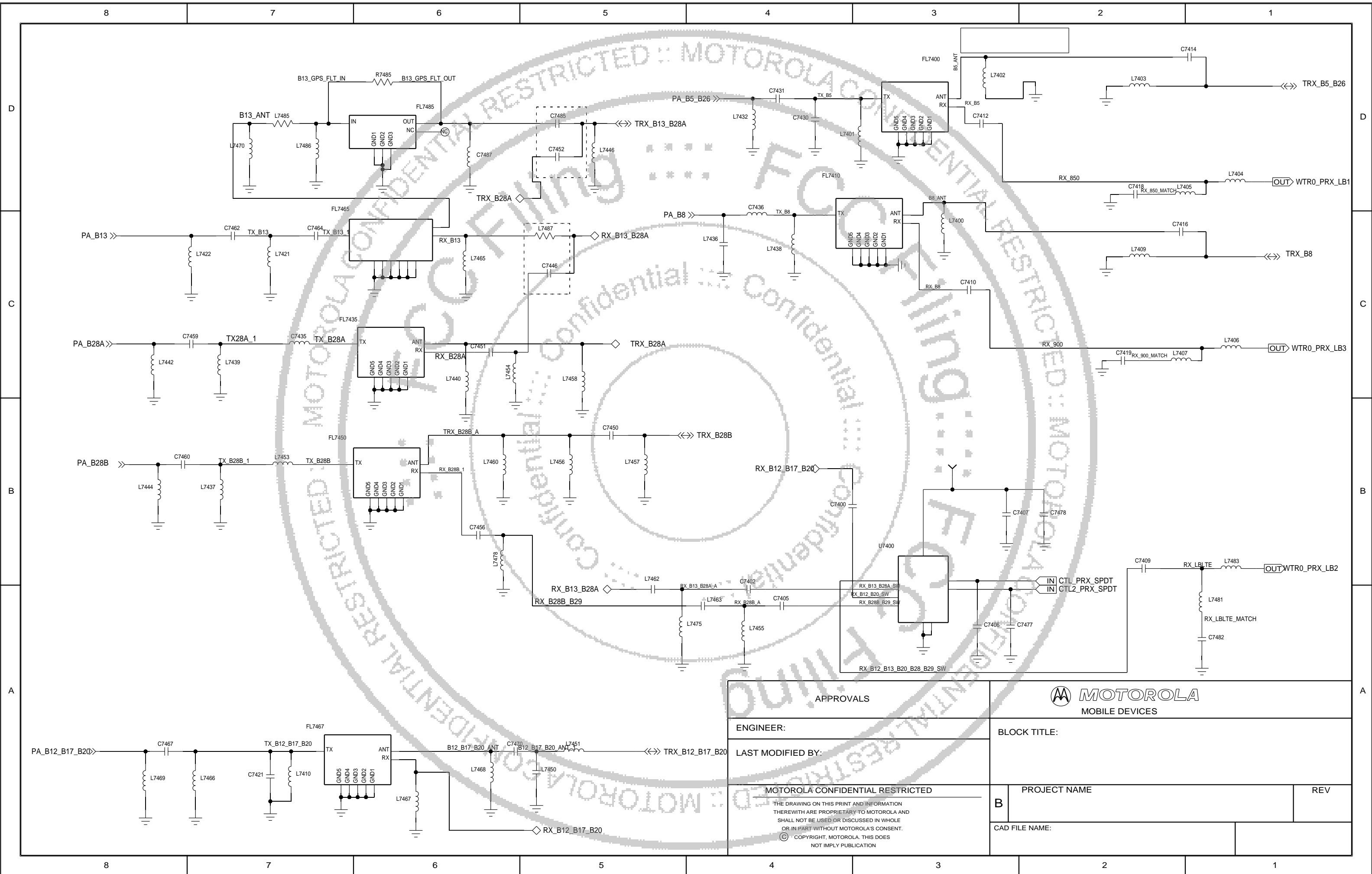

APPROVALS		MOTOROLA MOBILE DEVICES	
ENGINEER:		BLOCK TITLE:	
LAST MODIFIED BY:		PROJECT NAME	
MOTOROLA CONFIDENTIAL RESTRICTED <small>THE DRAWING ON THIS PRINT AND INFORMATION THEREWITH ARE PROPRIETARY TO MOTOROLA AND SHALL NOT BE USED OR DISCUSSED IN WHOLE OR IN PART WITHOUT MOTOROLA'S CONSENT. © COPYRIGHT, MOTOROLA. THIS DOES NOT IMPLY PUBLICATION</small>		B	REV
		CAD FILE NAME:	

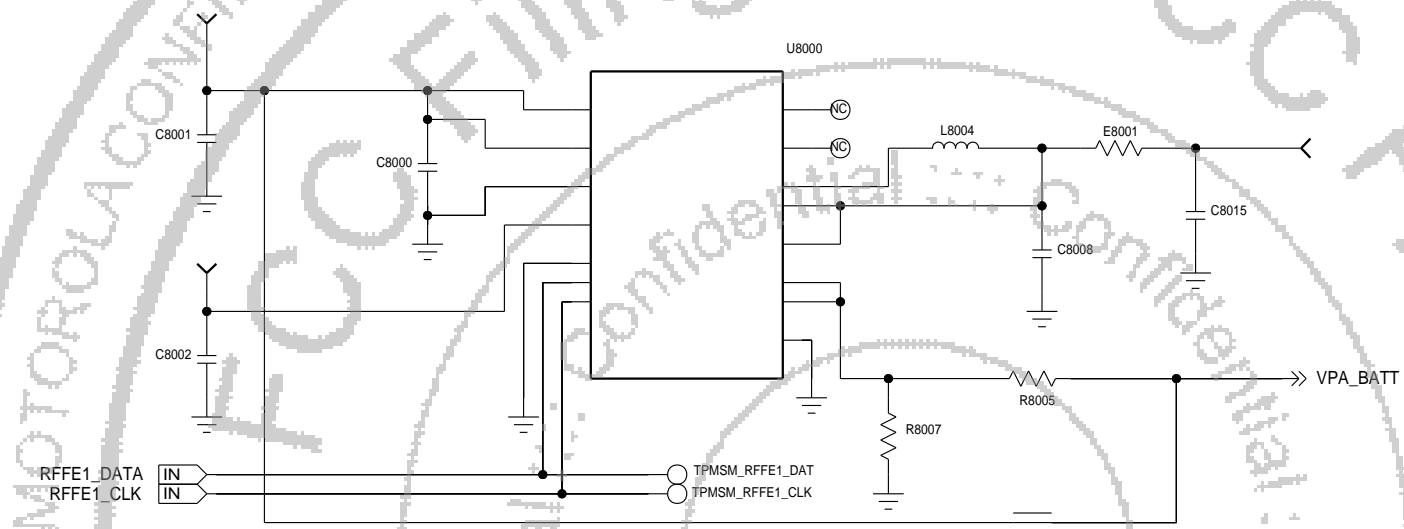

APPROVALS		MOTOROLA MOBILE DEVICES	
ENGINEER:		BLOCK TITLE:	
LAST MODIFIED BY:			
MOTOROLA CONFIDENTIAL RESTRICTED <small>THE DRAWING ON THIS PRINT AND INFORMATION THEREWITH ARE PROPRIETARY TO MOTOROLA AND SHALL NOT BE USED OR DISCUSSED IN WHOLE OR IN PART WITHOUT MOTOROLA'S CONSENT. © COPYRIGHT, MOTOROLA. THIS DOES NOT IMPLY PUBLICATION</small>		PROJECT NAME	REV
		CAD FILE NAME:	

REVISIONS			
ZONE	LTR	DESCRIPTION	DATE

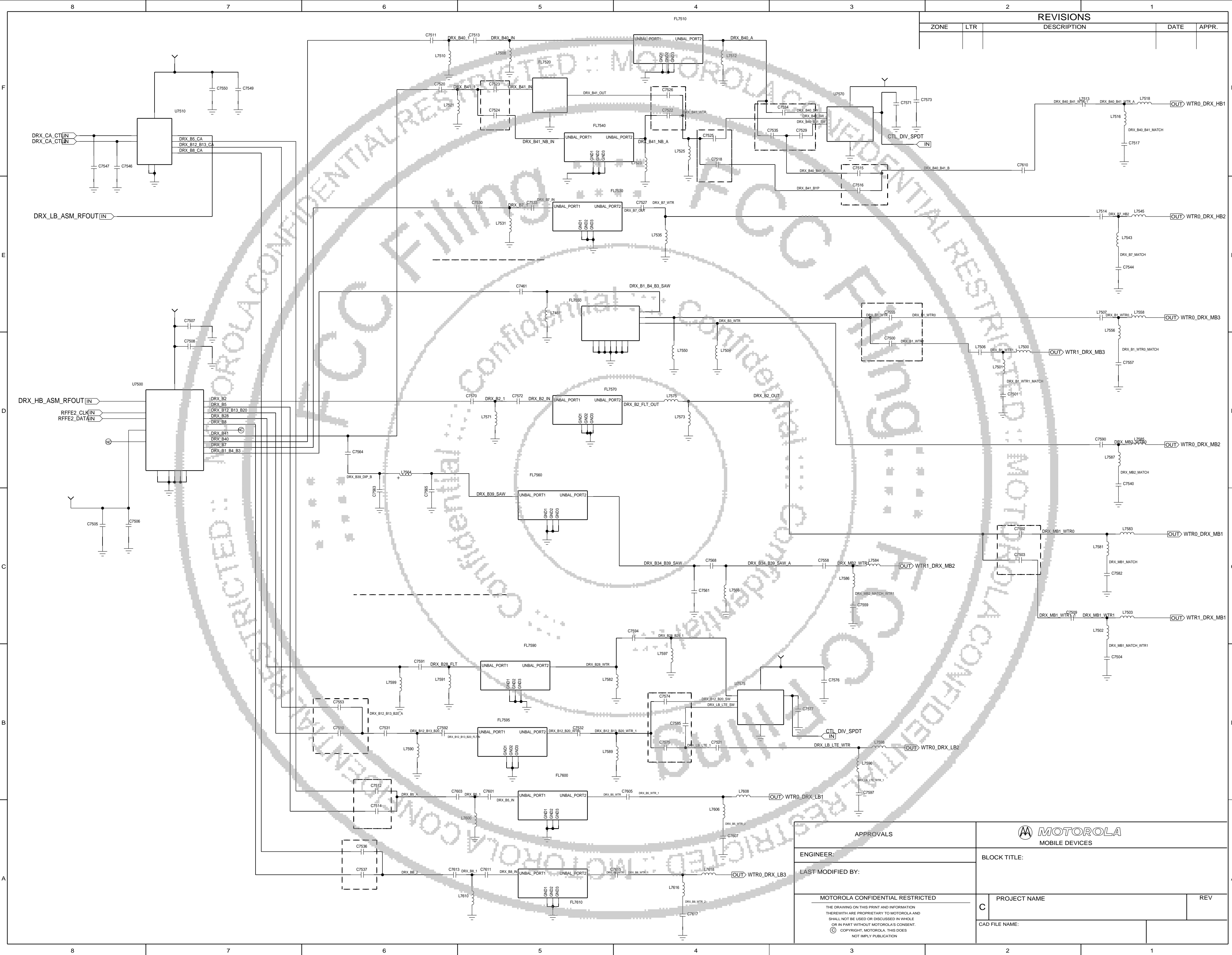

APPROVALS		MOTOROLA MOBILE DEVICES	
ENGINEER:		BLOCK TITLE:	
LAST MODIFIED BY:		PROJECT NAME	
MOTOROLA CONFIDENTIAL RESTRICTED <small>THE DRAWING ON THIS PRINT AND INFORMATION THEREWITH ARE PROPRIETARY TO MOTOROLA AND SHALL NOT BE USED OR DISCUSSED IN WHOLE OR IN PART WITHOUT MOTOROLA'S CONSENT. © COPYRIGHT, MOTOROLA. THIS DOES NOT IMPLY PUBLICATION.</small>		CAD FILE NAME:	REV

