



FCC RF Test Report

APPLICANT : Motorola Mobility, LLC
EQUIPMENT : Mobile Cellular Phone
BRAND NAME : Motorola
MODEL NAME : 7050
FCC ID : IHDT56VA1
STANDARD : FCC 47 CFR Part 2, 22(H), 24(E)
CLASSIFICATION : PCS Licensed Transmitter Held to Ear (PCE)

This is a variant report which is only valid together with the original test report. The product was received on Feb. 03, 2016. We, SPORTON INTERNATIONAL INC., would like to declare that the tested sample has been evaluated in accordance with the test procedures given in ANSI / TIA / EIA-603-D-2010 and has been in compliance with the applicable technical standards.

The test results in this report apply exclusively to the tested model / sample. Without written approval of SPORTON INTERNATIONAL INC., the test report shall not be reproduced except in full.

Reviewed by: Joseph Lin / Supervisor

Approved by: Jones Tsai / Manager



SPORTON INTERNATIONAL INC.

No. 52, Hwa Ya 1st Rd., Hwa Ya Technology Park, Kwei-Shan District, Tao Yuan City, Taiwan, R.O.C.



TABLE OF CONTENTS

REVISION HISTORY..... 3

1 GENERAL DESCRIPTION 4

 1.1 Applicant..... 4

 1.2 Manufacturer 4

 1.3 Product Feature of Equipment Under Test 4

 1.4 Re-use of Measured Data 5

 1.5 Modification of EUT 5

APPENDIX A. ORIGINAL REPORT



1 General Description

1.1 Applicant

Motorola Mobility, LLC
222 W. Merchandise Mart Plaza, Chicago IL 60654 USA

1.2 Manufacturer

Motorola Mobility, LLC
222 W. Merchandise Mart Plaza, Chicago IL 60654 USA

1.3 Product Feature of Equipment Under Test

Product Feature	
Equipment	Mobile Cellular Phone
Brand Name	Motorola
Model Name	7050
FCC ID	IHDT56VA1
EUT supports Radios application	GSM/EGPRS/WCDMA/HSPA/LTE/FM WLAN 11b/g/n HT20 WLAN 11a/n HT20/HT40 Bluetooth v3.0 EDR Bluetooth v4.0 LE
HW Version	DVT2
EUT Stage	Identical Prototype



1.4 Re-use of Measured Data

This application re-uses data collected on a similar device. The subject device of this application (Model 7050, FCC ID IHDT56VA1) is electrically identical to the reference device (Model 8028, FCC ID IHDT56VA2) for the portions of the circuitry corresponding to the data being re-used, as treated by KDB Publication 178919 D01.

For details concerning the similarity with respect to component placement, mechanical/electrical design etc., please refer to the Operational Description.

The re-used RF data includes the following bands provided in Appendix A (Sporton RF Report No. FG620325A for the reference device Model 8028, FCC ID IHDT56VA2):

- GSM850
- GSM1900
- WCDMA Band V

The following bands from the reference device report in Appendix A are not applicable to the Model 7050 (FCC ID IHDT56VA1) subject device of this application:

- WCDMA Band II

In order to confirm hardware similarity of the subject device with the reference device, spot check measurements were performed on the subject device for the individual cases as the table below this paragraph.

Assertions concerning the similarity of these devices are based on representations by the applicant. The applicant accepts full responsibility for the validity of the similarity claim, and for the determination that verification test data are sufficient to support it.

Standard	Item	Bands
Part22/24	RSE	GPRS 850
		GPRS 1900

Result within one uncertainty of reference device

Note: The device from which these reference data are taken is currently in the process of FCC certification, and may not yet be visible on the FCC web system. However, these data are representative of the reference device, and are valid for this purpose.

1.5 Modification of EUT

No modifications are made to the EUT during all test items.



Appendix A. Original Report

Please refer to Sporton report number FG620325A as below.



FCC RF Test Report

APPLICANT : Motorola Mobility, LLC
EQUIPMENT : Mobile Cellular Phone
BRAND NAME : Motorola
MODEL NAME : 8028
FCC ID : IHDT56VA2
STANDARD : FCC 47 CFR Part 2, 22(H), 24(E)
CLASSIFICATION : PCS Licensed Transmitter Held to Ear (PCE)

The product was received on Feb. 03, 2016 and testing was completed on Mar. 04, 2016. We, SPORTON INTERNATIONAL INC., would like to declare that the tested sample has been evaluated in accordance with the test procedures given in ANSI / TIA / EIA-603-D-2010 and has been in compliance with the applicable technical standards.

The test results in this report apply exclusively to the tested model / sample. Without written approval of SPORTON INTERNATIONAL INC., the test report shall not be reproduced except in full.

Reviewed by: Joseph Lin / Supervisor

Approved by: Jones Tsai / Manager



SPORTON INTERNATIONAL INC.

No. 52, Hwa Ya 1st Rd., Hwa Ya Technology Park, Kwei-Shan District, Tao Yuan City, Taiwan, R.O.C.



TABLE OF CONTENTS

REVISION HISTORY..... 3

SUMMARY OF TEST RESULT 4

1 GENERAL DESCRIPTION 5

 1.1 Applicant..... 5

 1.2 Manufacturer 5

 1.3 Product Feature of Equipment Under Test 5

 1.4 Product Specification of Equipment Under Test 6

 1.5 Modification of EUT 6

 1.6 Maximum ERP/EIRP Power, Frequency Tolerance, and Emission Designator 7

 1.7 Testing Location 8

 1.8 Applicable Standards 8

2 TEST CONFIGURATION OF EQUIPMENT UNDER TEST 9

 2.1 Test Mode..... 9

 2.2 Connection Diagram of Test System 10

 2.3 Support Unit used in test configuration 10

 2.4 Measurement Results Explanation Example 10

3 CONDUCTED TEST RESULT..... 11

 3.1 Measuring Instruments..... 11

 3.2 Test Setup 11

 3.3 Test Result of Conducted Test..... 11

 3.4 Conducted Output Power 12

 3.5 Peak-to-Average Ratio 13

 3.6 99% Occupied Bandwidth and 26dB Bandwidth Measurement..... 14

 3.7 Conducted Band Edge 15

 3.8 Conducted Spurious Emission 16

 3.9 Frequency Stability..... 17

4 RADIATED TEST ITEMS 18

 4.1 Measuring Instruments..... 18

 4.2 Test Setup 18

 4.3 Test Result of Radiated Test..... 18

 4.4 Effective Radiated Power and Effective Isotropic Radiated Power Measurement 19

 4.5 Field Strength of Spurious Radiation Measurement 21

5 LIST OF MEASURING EQUIPMENT 22

6 UNCERTAINTY OF EVALUATION 23

APPENDIX A. TEST RESULTS OF CONDUCTED TEST

APPENDIX B. TEST RESULTS OF RADIATED TEST



SUMMARY OF TEST RESULT

Report Section	FCC Rule	Description	Limit	Result	Remark
3.4	§2.1046	Conducted Output Power	Reporting Only	PASS	-
3.5	§24.232(d)	Peak-to-Average Ratio	< 13 dB	PASS	-
3.6	§2.1049 §22.917(b) §24.238(b)	Occupied Bandwidth	Reporting Only	PASS	-
3.7	§2.1051 §22.917(a) §24.238(a)	Band Edge Measurement	< 43+10log10(P[Watts])	PASS	-
3.8	§2.1051 §22.917(a) §24.238(a)	Conducted Emission	< 43+10log10(P[Watts])	PASS	-
3.9	§2.1055 §22.355	Frequency Stability for Temperature & Voltage	< 2.5 ppm for Part 22	PASS	-
	§2.1055 §24.235		Within Authorized Band		
4.4	§22.913(a)(2)	Effective Radiated Power	< 7 Watts	PASS	-
	§24.232(c)	Equivalent Isotropic Radiated Power	< 2 Watts	PASS	-
4.5	§2.1053 §22.917(a) §24.238(a)	Field Strength of Spurious Radiation	< 43+10log10(P[Watts])	PASS	Under limit 12.73 dB at 5730.000 MHz



1 General Description

1.1 Applicant

Motorola Mobility, LLC
222 W. Merchandise Mart Plaza, Chicago IL 60654 USA

1.2 Manufacturer

Motorola Mobility, LLC
222 W. Merchandise Mart Plaza, Chicago IL 60654 USA

1.3 Product Feature of Equipment Under Test

Product Feature	
Equipment	Mobile Cellular Phone
Brand Name	Motorola
Model Name	8028
FCC ID	IHDT56VA2
IMEI Code	354117070006170
EUT supports Radios application	GSM/EGPRS/WCDMA/HSPA/LTE/FM WLAN 11b/g/n HT20 WLAN 11a/n HT20/HT40 Bluetooth v3.0 EDR Bluetooth v4.0 LE
HW Version	DVT2
EUT Stage	Identical Prototype

Remark: The above EUT's information was declared by manufacturer. Please refer to the specifications or user's manual for more detailed description.

Accessory List	
AC Adapter	Brand Name : Motorola
	Model Name : SPN5866A
Earphone	Brand Name : Motorola
	Model Name : SJYN1181B
USB Cable	Brand Name : Motorola
	Model Name : SKN6462A



1.4 Product Specification of Equipment Under Test

Standards-related Product Specification	
Tx Frequency	GSM/GPRS/EDGE: 850: 824.2 MHz ~ 848.8 MHz 1900: 1850.2 MHz ~ 1909.8MHz WCDMA: Band V: 826.4 MHz ~ 846.6 MHz Band II: 1852.4 MHz ~ 1907.6 MHz
Rx Frequency	GSM/GPRS/EDGE: 850: 869.2 MHz ~ 893.8 MHz 1900: 1930.2 MHz ~ 1989.8 MHz WCDMA: Band V: 871.4 MHz ~ 891.6 MHz Band II: 1932.4 MHz ~ 1987.6 MHz
Maximum Output Power to Antenna	GSM/GPRS/EDGE: 850: 33.06 dBm 1900: 29.57 dBm WCDMA: Band V: 22.97 dBm Band II: 22.92 dBm
Antenna Type	Fixed Internal Antenna (The antenna peak gain of EUT is less than 6 dBi)
Type of Modulation	GSM: GMSK GPRS: GMSK EDGE: GMSK / 8PSK WCDMA: QPSK (Uplink) HSDPA: QPSK (Uplink) HSUPA: QPSK (Uplink)

1.5 Modification of EUT

No modifications are made to the EUT during all test items.



1.6 Maximum ERP/EIRP Power, Frequency Tolerance, and Emission Designator

FCC Rule	System	Type of Modulation	Maximum ERP/EIRP (W)	Frequency Tolerance (ppm)	Emission Designator
Part 22	GSM850 GPRS class 8	GMSK	1.0093	0.0072 ppm	245KGXW
Part 22	GSM850 EDGE class 8	8PSK	0.2401	0.0108 ppm	247KG7W
Part 22	WCDMA Band V RMC 12.2Kbps	QPSK	0.1202	0.0120 ppm	4M12F9W
Part 24	GSM1900 GPRS class 8	GMSK	1.4655	0.0064 ppm	245KGXW
Part 24	GSM1900 EDGE class 8	8PSK	0.6295	0.0287 ppm	247KG7W
Part 24	WCDMA Band II RMC 12.2Kbps	QPSK	0.4159	0.0021 ppm	4M14F9W



1.7 Testing Location

Sporton Lab is accredited to ISO 17025 by Taiwan Accreditation Foundation (TAF code : 1190) and the FCC designation No. TW1022 under the FCC 2.948(e) by Mutual Recognition Agreement (MRA) in FCC Test.

Test Site	SPORTON INTERNATIONAL INC.
Test Site Location	No. 52, Hwa Ya 1 st Rd., Hwa Ya Technology Park, Kwei-Shan District, Tao Yuan City, Taiwan, R.O.C. TEL: +886-3-327-3456 FAX: +886-3-328-4978
Test Site No.	Sporton Site No.
	TH03-HY

Test Site	SPORTON INTERNATIONAL INC.
Test Site Location	No.58, Aly. 75, Ln. 564, Wenhua 3rd Rd. Guishan Dist, Taoyuan City, Taiwan (R.O.C.) TEL: +886-3-327-0868 FAX: +886-3-327-0855
Test Site No.	Sporton Site No.
	03CH11-HY

1.8 Applicable Standards

According to the specifications of the manufacturer, the EUT must comply with the requirements of the following standards:

- 47 CFR Part 2, 22(H), 24(E)
- ANSI / TIA / EIA-603-D-2010
- FCC KDB 971168 D01 Power Meas. License Digital Systems v02r02

Remark:

1. All test items were verified and recorded according to the standards and without any deviation during the test.
2. This EUT has also been tested and complied with the requirements of FCC Part 15, Subpart B, recorded in a separate test report.



2 Test Configuration of Equipment Under Test

2.1 Test Mode

Antenna port conducted and radiated test items were performed according to KDB 971168 D01 Power Meas. License Digital Systems v02r02 with maximum output power.

Radiated measurements were performed with rotating EUT in different three orthogonal test planes to find the maximum emission.

Radiated emissions were investigated as following frequency range:

1. 30 MHz to 9000 MHz for GSM850 and WCDMA Band V.
2. 30 MHz to 19000 MHz for GSM1900 and WCDMA Band II.

All modes and data rates and positions were investigated.

Test modes are chosen to be reported as the worst case configuration below:

Test Modes		
Band	Radiated TCs	Conducted TCs
GSM 850	<ul style="list-style-type: none"> ■ GPRS class 8 Link ■ EDGE class 8 Link 	<ul style="list-style-type: none"> ■ GPRS class 8 Link ■ EDGE class 8 Link
GSM 1900	<ul style="list-style-type: none"> ■ GPRS class 8 Link ■ EDGE class 8 Link 	<ul style="list-style-type: none"> ■ GPRS class 8 Link ■ EDGE class 8 Link
WCDMA Band V	<ul style="list-style-type: none"> ■ RMC 12.2Kbps Link 	<ul style="list-style-type: none"> ■ RMC 12.2Kbps Link
WCDMA Band II	<ul style="list-style-type: none"> ■ RMC 12.2Kbps Link 	<ul style="list-style-type: none"> ■ RMC 12.2Kbps Link

Note: The maximum power levels are chosen to test as the worst case configuration as follows:

GSM or GPRS multi-slot class 8 mode for GMSK modulation,

EDGE multi-slot class 8 mode for 8PSK modulation,

RMC 12.2Kbps mode for WCDMA band V,

RMC 12.2Kbps mode for WCDMA band II,

only these modes were used for all tests. In addition to above worst-case test, below investigating on all data rates, and all modes are compliance with each FCC test case which has specific test limits. For spurious emissions at antenna port, the EUT was investigated the band edges on low and high channels, and the unwanted spurious emissions on middle channel for all modes, the results are pass, then only the worst-results were reported in the test report. The Radiated Spurious emissions for GSM/GPRS/EGPRS/WCDMA/HSDPA modes were investigated on the middle channel and the passed results were not worst than those data tested from the highest power channels.

2.2 Connection Diagram of Test System

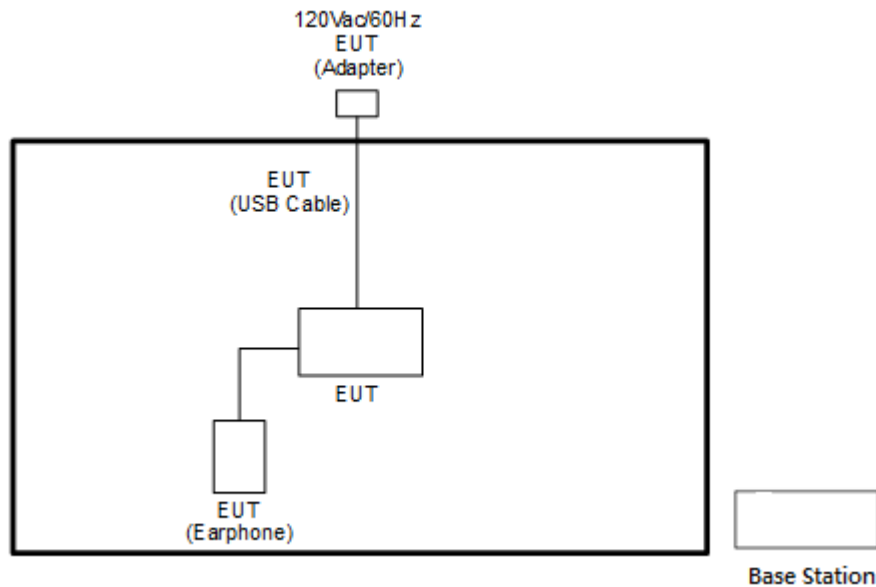

2.3 Support Unit used in test configuration

Item	Equipment	Trade Name	Model No.	FCC ID	Data Cable	Power Cord
1.	System Simulator	R&S	CMU 200	N/A	N/A	Unshielded, 1.8 m

2.4 Measurement Results Explanation Example

For all conducted test items:

The offset level is set in the spectrum analyzer to compensate the RF cable loss and attenuator factor between RF conducted output port and spectrum analyzer. With the offset compensation, the spectrum analyzer reading level will be exactly the RF output level.

The spectrum analyzer offset is derived from RF cable loss and attenuator factor.

Offset = RF cable loss + attenuator factor.

The following shows an offset computation example with RF cable loss 4.2 dB and a 10dB attenuator.

Example :

$$\begin{aligned} \text{Offset(dB)} &= \text{RF cable loss(dB)} + \text{attenuator factor(dB)} \\ &= 4.2 + 10 = 14.2 \text{ (dB)} \end{aligned}$$

3 Conducted Test Result

3.1 Measuring Instruments

See list of measuring instruments of this test report.

3.2 Test Setup

3.2.1 Conducted Output Power

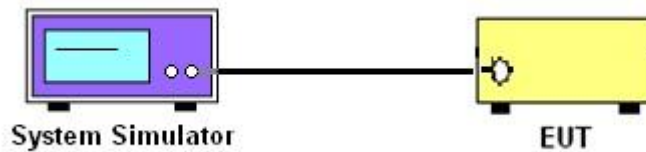

3.2.2 Peak-to-Average Ratio, Occupied Bandwidth, Conducted Band-Edge and Conducted Spurious Emission

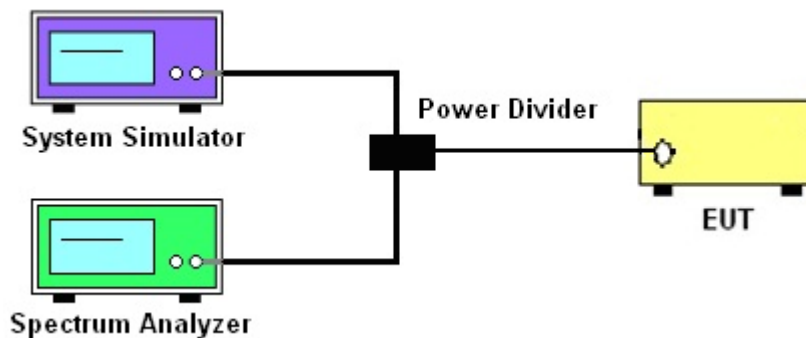

3.2.3 Frequency Stability

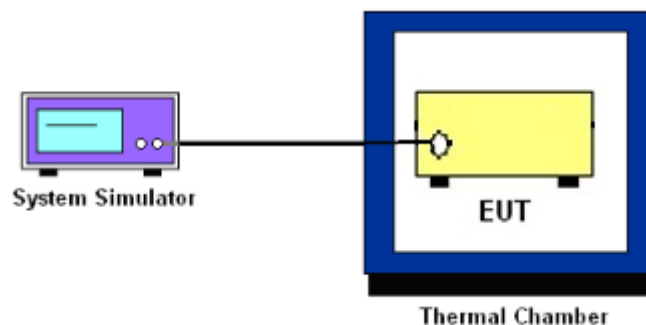

3.3 Test Result of Conducted Test

Please refer to Appendix A.



3.4 Conducted Output Power

3.4.1 Description of the Conducted Output Power

A system simulator was used to establish communication with the EUT. Its parameters were set to enforce EUT transmitting at the maximum power. The measured power in the radio frequency on the transmitter output terminals shall be reported.

3.4.2 Test Procedures

1. The transmitter output port was connected to the system simulator.
2. Set EUT at maximum power through system simulator.
3. Select lowest, middle, and highest channels for each band and different modulation.
4. Measure the maximum burst average power for GSM and maximum average power for other modulation signal.



3.5 Peak-to-Average Ratio

3.5.1 Description of the PAR Measurement

The peak-to-average ratio (PAR) of the transmission may not exceed 13 dB.

3.5.2 Test Procedures

1. The testing follows FCC KDB 971168 D01 v02r02 Section 5.7.1.
2. The EUT was connected to spectrum analyzer and system simulator via a power divider.
3. Set EUT to transmit at maximum output power.
4. When the duty cycle is less than 98%, then signal gating will be implemented on the spectrum analyzer by triggering from the system simulator.
5. Set the CCDF (Complementary Cumulative Distribution Function) option of the spectrum analyzer.
Record the maximum PAPR level associated with a probability of 0.1%.



3.6 99% Occupied Bandwidth and 26dB Bandwidth Measurement

3.6.1 Description of 99% Occupied Bandwidth and 26dB Bandwidth Measurement

The occupied bandwidth is the width of a frequency band such that, below the lower and above the upper frequency limits, the mean powers emitted are each equal to a specified percentage 0.5% of the total mean transmitted power.

The 26 dB emission bandwidth is defined as the frequency range between two points, one above and one below the carrier frequency, at which the spectral density of the emission is attenuated 26 dB below the maximum in-band spectral density of the modulated signal. Spectral density (power per unit bandwidth) is to be measured with a detector of resolution bandwidth equal to approximately 1.0% of the emission bandwidth.

3.6.2 Test Procedures

1. The testing follows FCC KDB 971168 v02r02 Section 4.2.
2. The EUT was connected to spectrum analyzer and system simulator via a power divider.
3. The spectrum analyzer center frequency is set to the nominal EUT channel center frequency. The span range for the spectrum analyzer shall be between two and five times the anticipated OBW.
4. The nominal resolution bandwidth (RBW) shall be in the range of 1 to 5 % of the anticipated OBW, and the VBW shall be at least 3 times the RBW.
5. Set the detection mode to peak, and the trace mode to max hold.
6. Determine the reference value: Set the EUT to transmit a modulated signal. Allow the trace to stabilize. Set the spectrum analyzer marker to the highest level of the displayed trace.
(this is the reference value)
7. Determine the “-26 dB down amplitude” as equal to (Reference Value – X).
8. Place two markers, one at the lowest and the other at the highest frequency of the envelope of the spectral display such that each marker is at or slightly below the “-X dB down amplitude” determined in step 6. If a marker is below this “-X dB down amplitude” value it shall be placed as close as possible to this value. The OBW is the positive frequency difference between the two markers.
9. Use the 99 % power bandwidth function of the spectrum analyzer and report the measured bandwidth.



3.7 Conducted Band Edge

3.7.1 Description of Conducted Band Edge Measurement

The power of any emission outside of the authorized operating frequency ranges must be lower than the transmitter power (P) by a factor of at least $43 + 10 \log (P)$ dB.

3.7.2 Test Procedures

1. The testing follows FCC KDB 971168 D01 v02r02 Section 6.0.
2. The EUT was connected to the spectrum analyzer and system simulator via a power divider.
3. The RF output of EUT was connected to the spectrum analyzer by an RF cable and attenuator. The path loss was compensated to the results for each measurement.
4. The band edges of low and high channels for the highest RF powers were measured.
5. The RF fundamental frequency should be excluded against the limit line in the operating frequency band.
6. The limit line is derived from $43 + 10\log(P)$ dB below the transmitter power P(Watts)
= $P(W) - [43 + 10\log(P)]$ (dB)
= $[30 + 10\log(P)]$ (dBm) - $[43 + 10\log(P)]$ (dB)
= -13dBm.



3.8 Conducted Spurious Emission

3.8.1 Description of Conducted Spurious Emission Measurement

The power of any emission outside of the authorized operating frequency ranges must be lower than the transmitter power (P) by a factor of at least $43 + 10 \log (P)$ dB.

It is measured by means of a calibrated spectrum analyzer and scanned from 30 MHz up to a frequency including its 10th harmonic.

3.8.2 Test Procedures

1. The testing follows FCC KDB 971168 D01 v02r02 Section 6.0.
2. The EUT was connected to the spectrum analyzer and system simulator via a power divider.
3. The RF output of EUT was connected to the spectrum analyzer by an RF cable and attenuator. The path loss was compensated to the results for each measurement.
4. The middle channel for the highest RF power within the transmitting frequency was measured.
5. The conducted spurious emission for the whole frequency range was taken.
6. The RF fundamental frequency should be excluded against the limit line in the operating frequency band.
7. The limit line is derived from $43 + 10\log(P)$ dB below the transmitter power P(Watts)
= $P(W) - [43 + 10\log(P)]$ (dB)
= $[30 + 10\log(P)]$ (dBm) - $[43 + 10\log(P)]$ (dB)
= -13dBm.



3.9 Frequency Stability

3.9.1 Description of Frequency Stability Measurement

The frequency stability shall be measured by variation of ambient temperature and variation of primary supply voltage to ensure that the fundamental emission stays within the authorized frequency block. The frequency stability of the transmitter shall be maintained within $\pm 0.00025\%$ ($\pm 2.5\text{ppm}$) of the center frequency.

3.9.2 Test Procedures for Temperature Variation

1. The testing follows FCC KDB 971168 D01 v02r02 Section 9.0.
2. The EUT was set up in the thermal chamber and connected with the system simulator.
3. With power OFF, the temperature was decreased to -30°C and the EUT was stabilized before testing. Power was applied and the maximum change in frequency was recorded within one minute.
4. With power OFF, the temperature was raised in 10°C steps up to 50°C . The EUT was stabilized at each step for at least half an hour. Power was applied and the maximum frequency change was recorded within one minute.

3.9.3 Test Procedures for Voltage Variation

1. The testing follows FCC KDB 971168 D01 v02r02 Section 9.0.
2. The EUT was placed in a temperature chamber at $25\pm 5^{\circ}\text{C}$ and connected with the system simulator.
3. The power supply voltage to the EUT was varied from 85% to 115% of the nominal value measured at the input to the EUT.
4. The variation in frequency was measured for the worst case.

4 Radiated Test Items

4.1 Measuring Instruments

See list of measuring instruments of this test report.

4.2 Test Setup

4.2.1 For radiated test from 30MHz to 1GHz

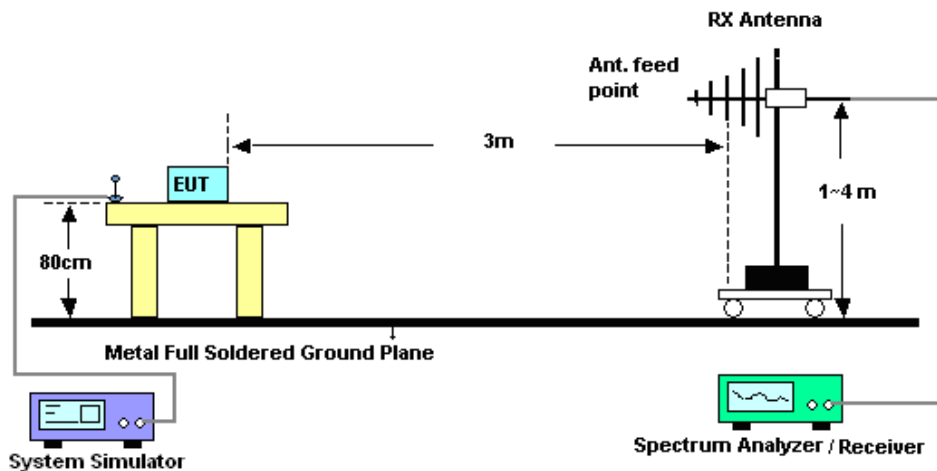

4.2.2 For radiated test above 1GHz

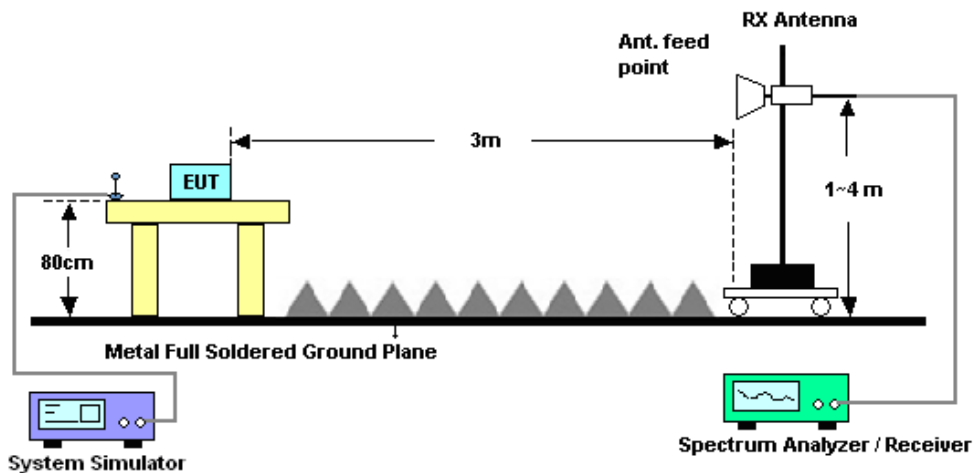

4.3 Test Result of Radiated Test

Please refer to Appendix B.



4.4 Effective Radiated Power and Effective Isotropic Radiated Power Measurement

4.4.1 Description of the ERP/EIRP Measurement

The substitution method, in ANSI / TIA / EIA-603-D-2010, was used for ERP/EIRP measurement, and the spectrum analyzer configuration follows KDB 971168 D01 Power Meas. License Digital Systems v02r02. The ERP of mobile transmitters must not exceed 7 Watts (Cellular Band) and the EIRP of mobile transmitters are limited to 2 Watts (PCS Band).

4.4.2 Test Procedures

1. The testing follows FCC KDB 971168 D01 v02r02 Section 5.2.1. (for CDMA/WCDMA), Section 5.2.2.2 (for GSM/GPRS/EDGE) and ANSI / TIA-603-D-2010 Section 2.2.17.
2. The EUT was placed on a non-conductive rotating platform 0.8 meters high in a semi-anechoic chamber. The radiated emission at the fundamental frequency was measured at 3 m with a test antenna and a spectrum analyzer with RMS detector per section 5. of KDB 971168 D01.
3. During the measurement, the system simulator parameters were set to force the EUT transmitting at maximum output power. The maximum emission was recorded from analyzer power level (LVL) from the 360 degrees rotation of the turntable and the test antenna raised and lowered over a range from 1 to 4 meters in both horizontally and vertically polarized orientations.
4. Effective Isotropic Radiated Power (EIRP) was measured by substitution method according to TIA/EIA-603-D. The EUT was replaced by the substitution antenna at same location, and then a known power from S.G. was applied into the dipole antenna through a Tx cable, and then recorded the maximum Analyzer reading through raised and lowered the test antenna. The correction factor (in dB) = S.G. - Tx Cable loss + Substitution antenna gain - Analyzer reading. Then the EUT's EIRP was calculated with the correction factor, $EIRP = LVL + \text{Correction factor}$ and $ERP = EIRP - 2.15$. Take the record of the output power at substitution antenna.



	GSM/GPRS/EDGE	WCDMA/HSPA
SPAN	500kHz	10MHz
RBW	10kHz	100kHz
VBW	30kHz	300kHz
Detector	RMS	RMS
Trace	Average	Average
Average Type	Power	Power
Sweep Count	100	100



4.5 Field Strength of Spurious Radiation Measurement

4.5.1 Description of Field Strength of Spurious Radiated Measurement

The power of any emission outside of the authorized operating frequency ranges must be attenuated below the transmitter power (P) by a factor of at least $43 + 10 \log (P)$ dB. The spectrum is scanned from 30 MHz up to a frequency including its 10th harmonic.

4.5.2 Test Procedures

1. The testing follows FCC KDB 971168 D01 v02r02 Section 5.8 and ANSI / TIA-603-D-2010 Section 2.2.12.
2. The EUT was placed on a rotatable wooden table 0.8 meters above the ground.
3. The EUT was set 3 meters from the receiving antenna, which was mounted on the antenna tower.
4. The table was rotated 360 degrees to determine the position of the highest spurious emission.
5. The height of the receiving antenna is varied between one meter and four meters to search for the maximum spurious emission for both horizontal and vertical polarizations.
6. Make the measurement with the spectrum analyzer's RBW = 1MHz, VBW = 3MHz, taking record of maximum spurious emission.
7. A horn antenna was substituted in place of the EUT and was driven by a signal generator.
8. Tune the output power of signal generator to the same emission level with EUT maximum spurious emission.
9. Taking the record of output power at antenna port.
10. Repeat step 7 to step 8 for another polarization.
11. $EIRP \text{ (dBm)} = S.G. \text{ Power} - Tx \text{ Cable Loss} + Tx \text{ Antenna Gain}$
12. $ERP \text{ (dBm)} = EIRP - 2.15$
13. The RF fundamental frequency should be excluded against the limit line in the operating frequency band.
14. The limit line is derived from $43 + 10\log(P)$ dB below the transmitter power P(Watts)
= $P(W) - [43 + 10\log(P)] \text{ (dB)}$
= $[30 + 10\log(P)] \text{ (dBm)} - [43 + 10\log(P)] \text{ (dB)}$
= -13dBm.



5 List of Measuring Equipment

Instrument	Manufacturer	Model No.	Serial No.	Characteristics	Calibration Date	Test Date	Due Date	Remark
Spectrum Analyzer	Rohde & Schwarz	FSP30	101329	9kHz~30GHz	Jun. 24, 2015	Feb. 08, 2016 ~ Feb. 29, 2016	Jun. 23, 2016	Conducted (TH03-HY)
Temperature Chamber	ESPEC	SU-641	92013721	-30°C ~70°C	Nov. 20, 2015	Feb. 08, 2016 ~ Feb. 29, 2016	Nov. 19, 2016	Conducted (TH03-HY)
Programmable Power Supply	GW Instek	PSS-2005	EL883644	Voltage:0~20V;Current:0~5A	Nov. 26, 2015	Feb. 08, 2016 ~ Feb. 29, 2016	Nov. 25, 2016	Conducted (TH03-HY)
Base Station(Measu	Rohde & Schwarz	CMU200	117995	GSM / GPRS / WCDMA / CDMA	Jul. 26, 2015	Feb. 08, 2016 ~ Feb. 29, 2016	Jul. 25, 2016	Conducted (TH03-HY)
Amplifier	SONOMA	310N	187312	9kHz~1GHz	Nov. 20, 2015	Feb. 09, 2016 ~ Mar. 04, 2016	Nov. 19, 2016	Radiation (03CH11-HY)
Bilog Antenna	TESEQ	CBL 6111D	35414	30MHz~1GHz	Nov. 17, 2015	Feb. 09, 2016 ~ Mar. 04, 2016	Nov. 16, 2016	Radiation (03CH11-HY)
Horn Antenna	SCHWARZBECK	BBHA 9120 D	9120D-1326	1GHz ~ 18GHz	Oct. 08, 2015	Feb. 09, 2016 ~ Mar. 04, 2016	Oct. 07, 2016	Radiation (03CH11-HY)
Preamplifier	Keysight	83017A	MY53270080	1GHz~26.5GHz	Nov. 19, 2015	Feb. 09, 2016 ~ Mar. 04, 2016	Nov. 18, 2016	Radiation (03CH11-HY)
Preamplifier	MITEQ	AMF-7D-00 101800-30-1	1902247	1GHz~18GHz	Jul. 01, 2015	Feb. 09, 2016 ~ Mar. 04, 2016	Jun. 30, 2016	Radiation (03CH11-HY)
Spectrum Analyzer	Keysight	N9010A	MY54200486	10Hz ~ 44GHZ	Sep. 24, 2015	Feb. 09, 2016 ~ Mar. 04, 2016	Sep. 23, 2016	Radiation (03CH11-HY)
Antenna Mast	EMEC	AM-BS-450 0-B	N/A	1~4m	N/A	Feb. 09, 2016 ~ Mar. 04, 2016	N/A	Radiation (03CH11-HY)
Turn Table	EMEC	TT 2000	N/A	0-360 degree	N/A	Feb. 09, 2016 ~ Mar. 04, 2016	N/A	Radiation (03CH11-HY)
Horn Antenna	SCHWARZBECK	BBHA 9120D	9120D-1328	1GHz ~ 18GHz	Nov. 02, 2015	Feb. 09, 2016 ~ Mar. 04, 2016	Nov. 01, 2016	Radiation (03CH11-HY)
SHF-EHF Horn Antenna	SCHWARZBECK	BBHA 9170	BBHA917058 4	18GHz- 40GHz	Nov. 02, 2015	Feb. 09, 2016 ~ Mar. 04, 2016	Nov. 01, 2016	Radiation (03CH11-HY)
Signal Generator	Rohde & Schwarz	SMF100A	101107	100kHz~40GHz	May 22, 2015	Feb. 09, 2016 ~ Mar. 04, 2016	May 21, 2016	Radiation (03CH11-HY)
Preamplifier	MITEQ	JS44-18004 000-33-8P	1840917	18GHz ~ 40GHz	Jun. 02, 2015	Feb. 09, 2016 ~ Mar. 04, 2016	Jun. 01, 2016	Radiation (03CH11-HY)
Horn Antenna	SCHWARZBECK	BBHA 9120 D	9120D-1241	1GHz ~ 18GHz	Apr. 22, 2015	Feb. 09, 2016 ~ Mar. 04, 2016	Apr. 21, 2016	Radiation (03CH11-HY)
Horn Antenna	ESCO	3117	00066584	1GHz~18GHz	Sep. 02, 2015	Feb. 09, 2016 ~ Mar. 04, 2016	Sep. 01, 2016	Radiation (03CH11-HY)



6 Uncertainty of Evaluation

Uncertainty of Radiated Emission Measurement (30 MHz ~ 1000 MHz)

Measuring Uncertainty for a Level of Confidence of 95% ($U = 2Uc(y)$)	4.90
---	------



Appendix A. Test Results of Conducted Test

Conducted Output Power(Average power)

Conducted Power (*Unit: dBm)						
Band	GSM850			GSM1900		
Channel	128	189	251	512	661	810
Frequency	824.2	836.4	848.8	1850.2	1880.0	1909.8
GSM	32.90	33.04	33.02	29.55	29.30	29.44
GPRS class 8	32.90	33.06	33.05	29.57	29.32	29.47
GPRS class 10	29.49	29.54	29.50	26.53	26.34	26.62
GPRS class 11	27.38	27.48	27.40	24.68	24.39	24.67
GPRS class 12	26.10	26.07	26.11	23.28	23.02	23.35
EGPRS class 8	26.70	26.79	26.77	25.74	25.54	25.76
EGPRS class 10	25.50	25.61	25.61	22.68	22.50	22.71
EGPRS class 11	22.44	22.52	22.42	20.89	20.79	20.94
EGPRS class 12	21.11	21.26	21.00	19.63	19.51	19.67

Conducted Power (*Unit: dBm)						
Band	WCDMA Band V			WCDMA Band II		
Channel	4132	4182	4233	9262	9400	9538
Frequency	826.4	836.4	846.6	1852.4	1880	1907.6
RMC 12.2K	22.97	22.66	22.64	22.87	22.92	22.72
HSDPA Subtest-1	22.11	21.96	21.85	22.04	22.11	21.82
HSDPA Subtest-2	22.13	21.99	21.89	22.03	22.16	21.88
HSDPA Subtest-3	21.62	21.51	21.38	21.45	21.58	21.21
HSDPA Subtest-4	21.62	21.41	21.38	21.42	21.55	21.27
HSUPA Subtest-1	22.15	21.98	21.84	21.93	22.08	21.88
HSUPA Subtest-2	20.17	19.93	19.89	20.01	20.07	19.91
HSUPA Subtest-3	21.15	20.93	20.80	20.98	21.05	20.76
HSUPA Subtest-4	20.19	20.02	19.91	19.93	20.04	19.88
HSUPA Subtest-5	22.10	21.91	21.87	22.02	22.06	21.83



A1. GSM

Peak-to-Average Ratio

Mode	GSM850		Limit: 13dB
Mod.	GPRS class 8	EDGE class 8	Result
Lowest CH	0.28	3.28	PASS
Middle CH	0.24	3.36	
Highest CH	0.24	3.20	

Mode	GSM1900		Limit: 13dB
Mod.	GPRS class 8	EDGE class 8	Result
Lowest CH	0.24	3.36	PASS
Middle CH	0.32	3.28	
Highest CH	0.24	3.36	

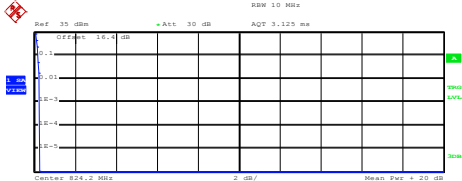
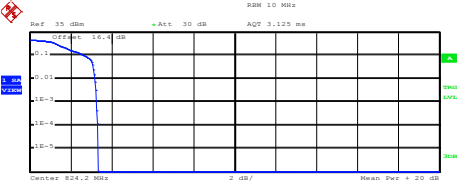
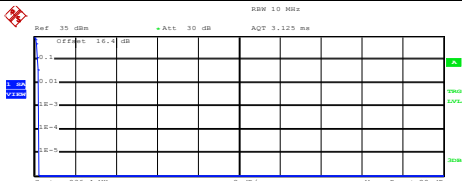
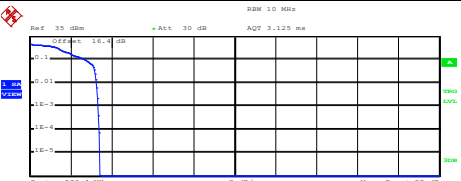
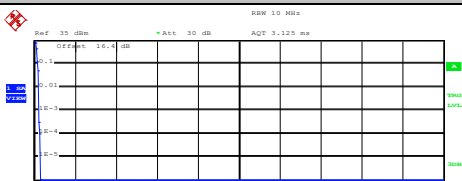
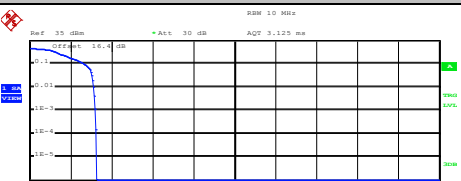

GSM850 (GPRS class 8)	GSM850 (EDGE class 8)
<p style="text-align: center;">Lowest Channel</p>  <p style="text-align: center;">Complementary Cumulative Distribution Function (100000 samples) Trace 1</p> <p>Mean 33.58 dBm Peak 33.84 dBm Crest 0.26 dB</p> <p>10 % 0.20 dB 1 % 0.24 dB .1 % 0.28 dB .01 % 0.28 dB</p> <p>Date: 8.FEB.2016 15:05:22</p>	<p style="text-align: center;">Lowest Channel</p>  <p style="text-align: center;">Complementary Cumulative Distribution Function (100000 samples) Trace 1</p> <p>Mean 26.33 dBm Peak 29.68 dBm Crest 3.35 dB</p> <p>10 % 2.68 dB 1 % 3.20 dB .1 % 3.28 dB .01 % 3.32 dB</p> <p>Date: 8.FEB.2016 15:35:19</p>
<p style="text-align: center;">Middle Channel</p>  <p style="text-align: center;">Complementary Cumulative Distribution Function (100000 samples) Trace 1</p> <p>Mean 33.46 dBm Peak 33.70 dBm Crest 0.24 dB</p> <p>10 % 0.16 dB 1 % 0.24 dB .1 % 0.24 dB .01 % 0.24 dB</p> <p>Date: 8.FEB.2016 15:06:03</p>	<p style="text-align: center;">Middle Channel</p>  <p style="text-align: center;">Complementary Cumulative Distribution Function (100000 samples) Trace 1</p> <p>Mean 26.53 dBm Peak 29.96 dBm Crest 3.43 dB</p> <p>10 % 2.72 dB 1 % 3.28 dB .1 % 3.36 dB .01 % 3.40 dB</p> <p>Date: 8.FEB.2016 15:35:42</p>
<p style="text-align: center;">Highest Channel</p>  <p style="text-align: center;">Complementary Cumulative Distribution Function (100000 samples) Trace 1</p> <p>Mean 33.54 dBm Peak 33.84 dBm Crest 0.30 dB</p> <p>10 % 0.16 dB 1 % 0.24 dB .1 % 0.24 dB .01 % 0.28 dB</p> <p>Date: 8.FEB.2016 15:06:28</p>	<p style="text-align: center;">Highest Channel</p>  <p style="text-align: center;">Complementary Cumulative Distribution Function (100000 samples) Trace 1</p> <p>Mean 26.58 dBm Peak 29.82 dBm Crest 3.24 dB</p> <p>10 % 2.68 dB 1 % 3.12 dB .1 % 3.20 dB .01 % 3.24 dB</p> <p>Date: 8.FEB.2016 15:36:03</p>



GSM1900 (GPRS class 8)	GSM1900 (EDGE class 8)
<p align="center">Lowest Channel</p> <p align="center">Complementary Cumulative Distribution Function (100000 samples) Trace 1</p> <p>Mean 28.82 dBm Peak 29.11 dBm Crest 0.29 dB</p> <p>10 % 0.20 dB 1 % 0.24 dB .1 % 0.24 dB .01 % 0.28 dB</p> <p>Date: 8.FEB.2016 16:02:52</p>	<p align="center">Lowest Channel</p> <p align="center">Complementary Cumulative Distribution Function (100000 samples) Trace 1</p> <p>Mean 24.61 dBm Peak 28.05 dBm Crest 3.44 dB</p> <p>10 % 2.68 dB 1 % 3.24 dB .1 % 3.36 dB .01 % 3.40 dB</p> <p>Date: 8.FEB.2016 16:25:57</p>
<p align="center">Middle Channel</p> <p align="center">Complementary Cumulative Distribution Function (100000 samples) Trace 1</p> <p>Mean 28.02 dBm Peak 28.34 dBm Crest 0.31 dB</p> <p>10 % 0.20 dB 1 % 0.28 dB .1 % 0.32 dB .01 % 0.32 dB</p> <p>Date: 8.FEB.2016 16:03:13</p>	<p align="center">Middle Channel</p> <p align="center">Complementary Cumulative Distribution Function (100000 samples) Trace 1</p> <p>Mean 23.86 dBm Peak 27.21 dBm Crest 3.35 dB</p> <p>10 % 2.72 dB 1 % 3.20 dB .1 % 3.28 dB .01 % 3.36 dB</p> <p>Date: 8.FEB.2016 16:26:21</p>
<p align="center">Highest Channel</p> <p align="center">Complementary Cumulative Distribution Function (100000 samples) Trace 1</p> <p>Mean 28.80 dBm Peak 29.11 dBm Crest 0.31 dB</p> <p>10 % 0.20 dB 1 % 0.24 dB .1 % 0.24 dB .01 % 0.32 dB</p> <p>Date: 8.FEB.2016 16:03:41</p>	<p align="center">Highest Channel</p> <p align="center">Complementary Cumulative Distribution Function (100000 samples) Trace 1</p> <p>Mean 24.47 dBm Peak 27.84 dBm Crest 3.37 dB</p> <p>10 % 2.68 dB 1 % 3.24 dB .1 % 3.36 dB .01 % 3.40 dB</p> <p>Date: 8.FEB.2016 16:26:43</p>



26dB Bandwidth

Mode	GSM850	
Mod.	GPRS class 8	EDGE class 8
Lowest CH	0.299	0.302
Middle CH	0.301	0.303
Highest CH	0.296	0.299

Mode	GSM1900	
Mod.	GPRS class 8	EDGE class 8
Lowest CH	0.311	0.294
Middle CH	0.300	0.300
Highest CH	0.299	0.307

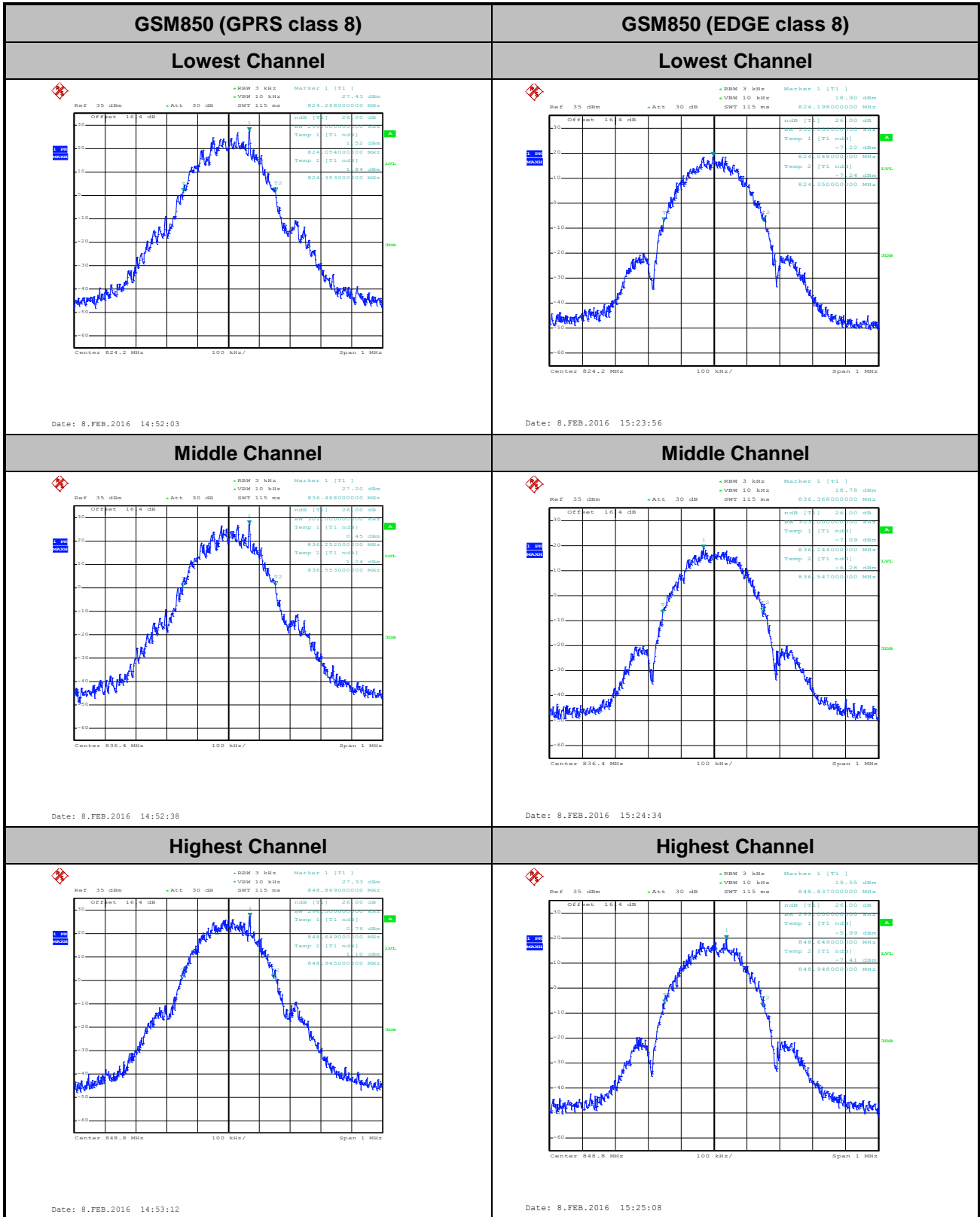

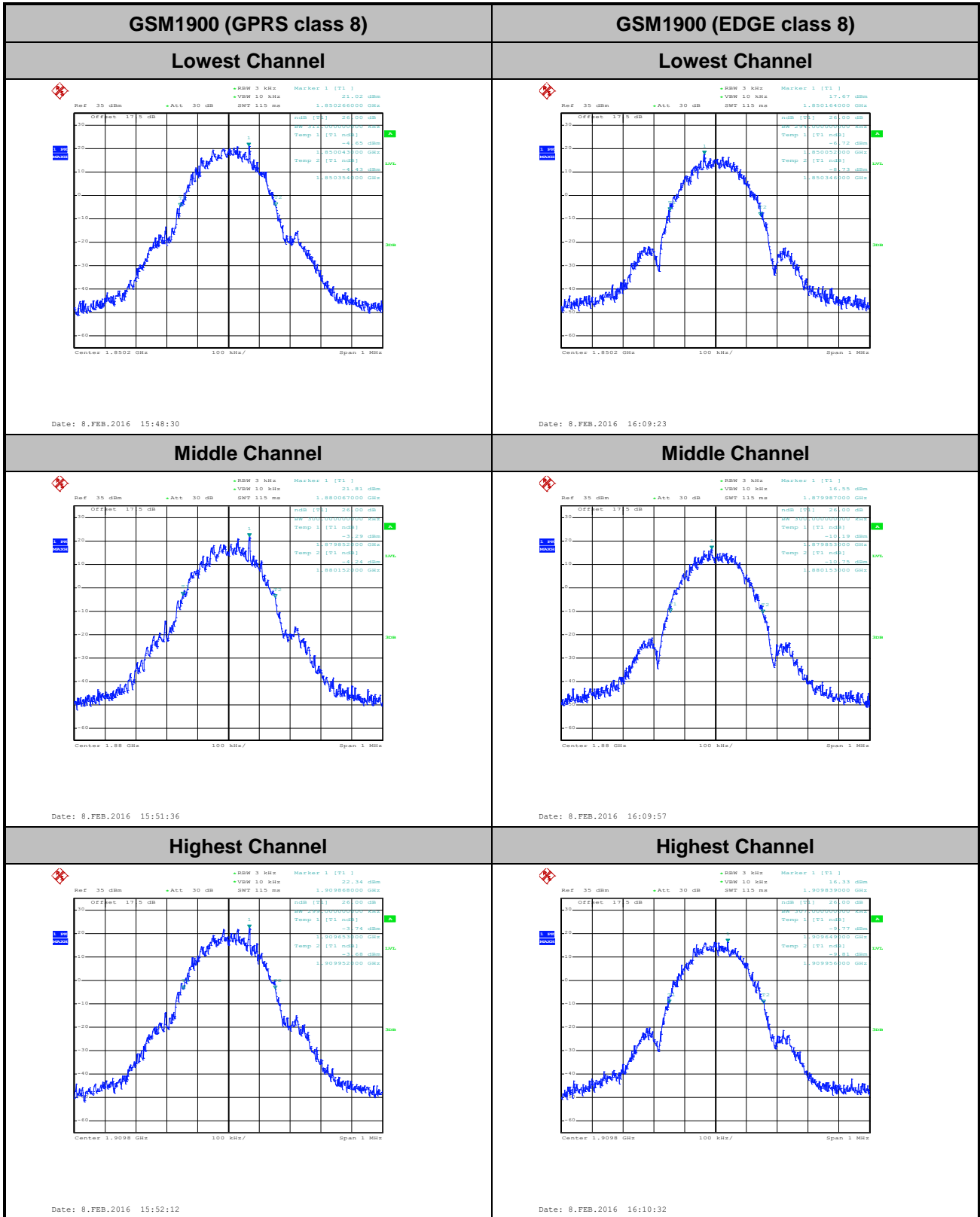



Occupied Bandwidth

Mode	GSM850	
Mod.	GPRS class 8	EDGE class 8
Lowest CH	0.243	0.242
Middle CH	0.245	0.247
Highest CH	0.244	0.246

Mode	GSM1900	
Mod.	GPRS class 8	EDGE class 8
Lowest CH	0.245	0.246
Middle CH	0.244	0.243
Highest CH	0.245	0.247

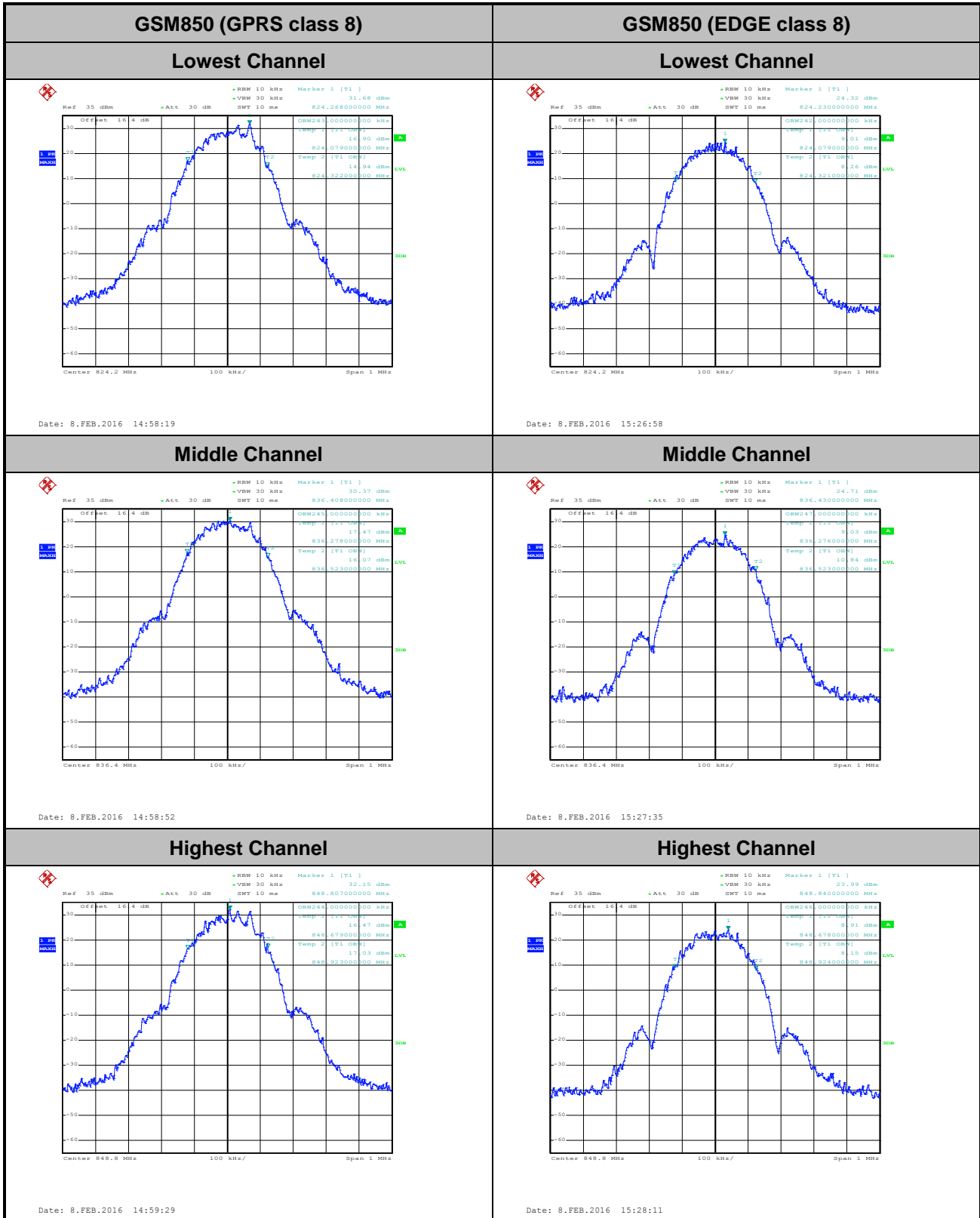



GSM1900 (GPRS class 8)

Lowest Channel

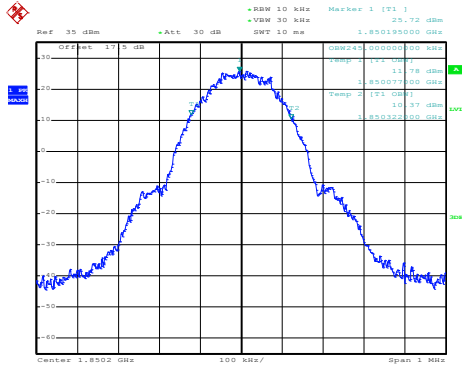

Date: 8.FEB.2016 15:53:50

GSM1900 (EDGE class 8)

Lowest Channel

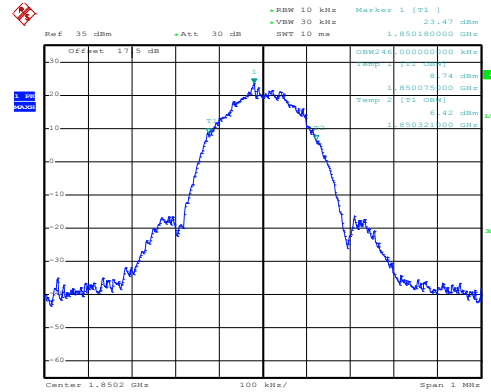

Date: 8.FEB.2016 16:20:38

Middle Channel

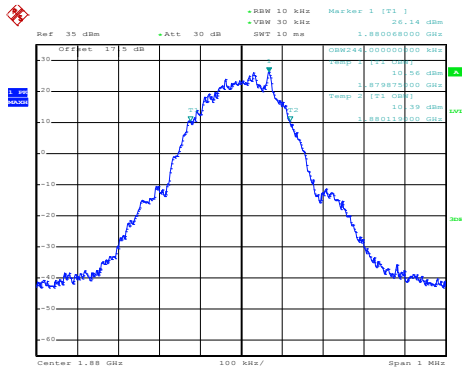

Date: 8.FEB.2016 15:54:25

Middle Channel

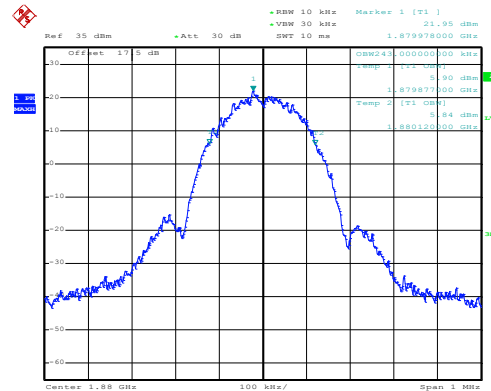

Date: 8.FEB.2016 16:21:12

Highest Channel

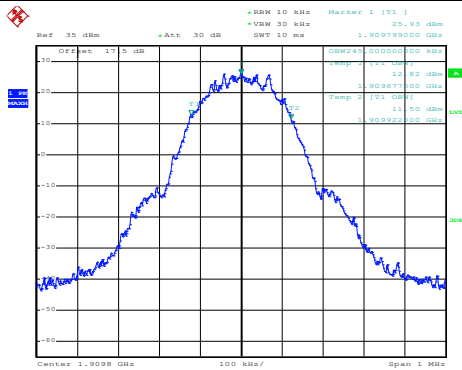

Date: 8.FEB.2016 15:55:02

Highest Channel

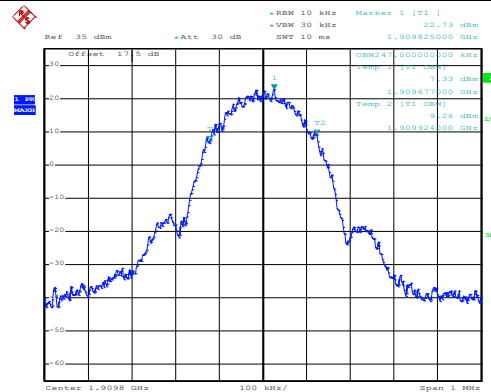

Date: 8.FEB.2016 16:21:45



Conducted Band Edge

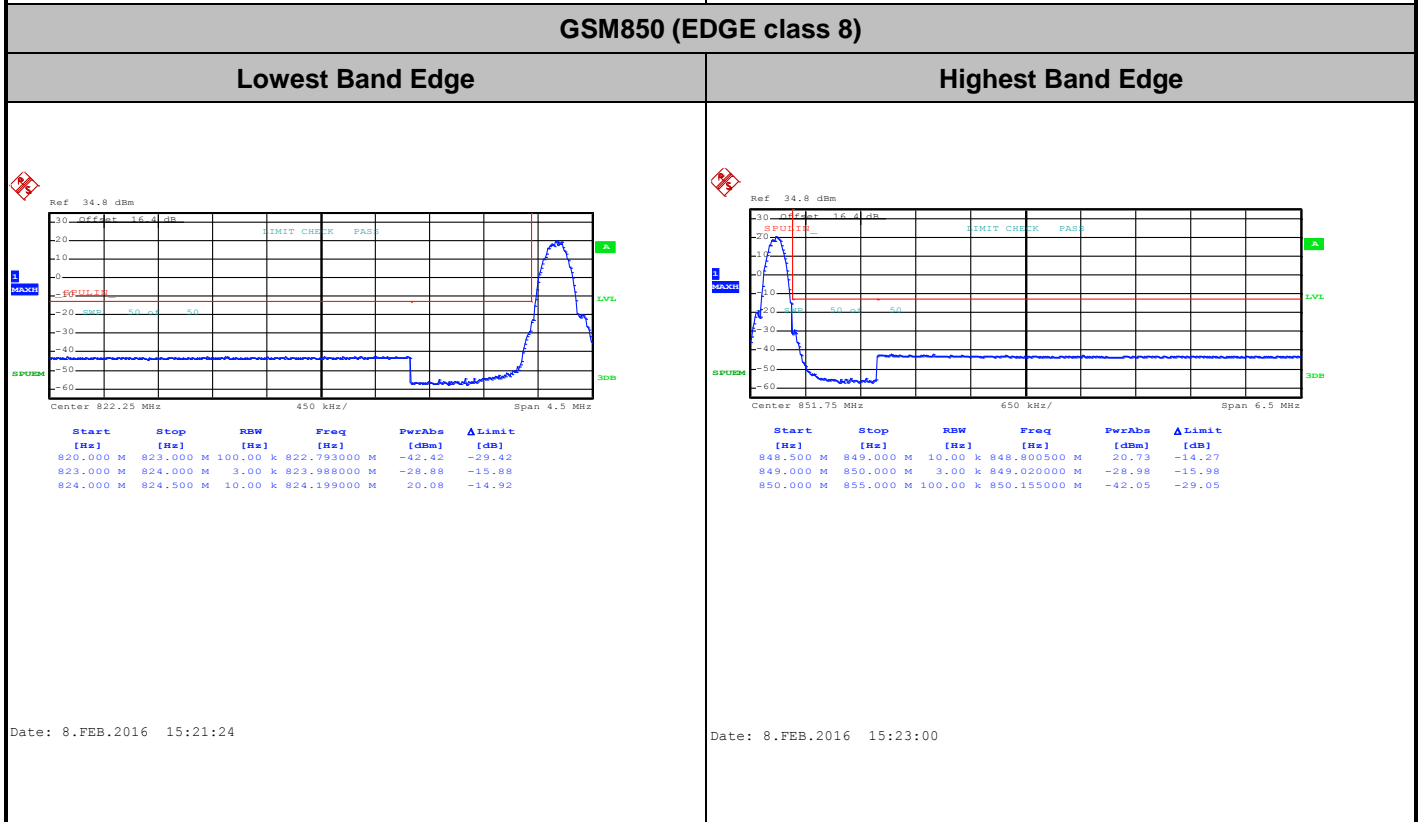
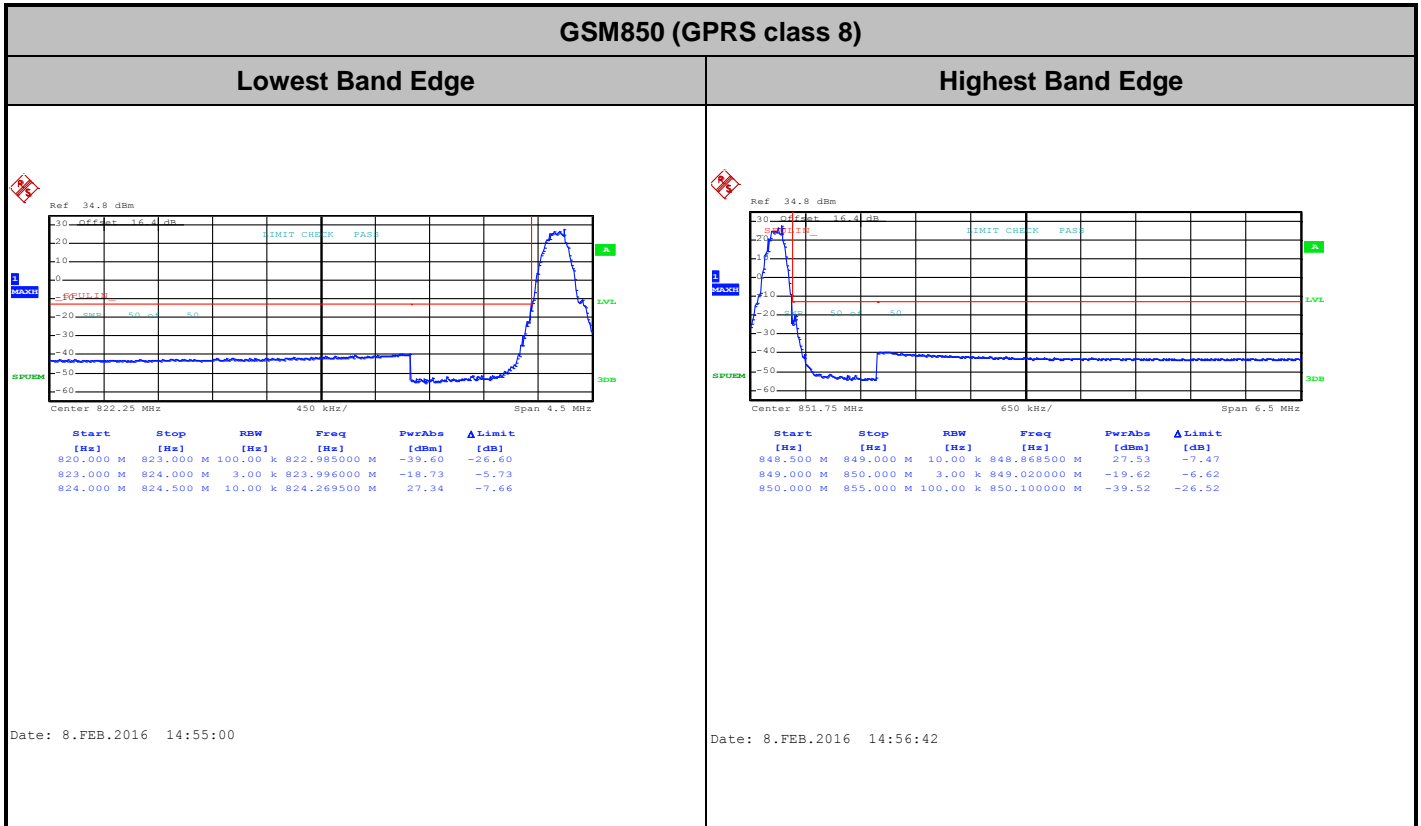



GSM1900 (GPRS class 8)

Lowest Band Edge

Highest Band Edge

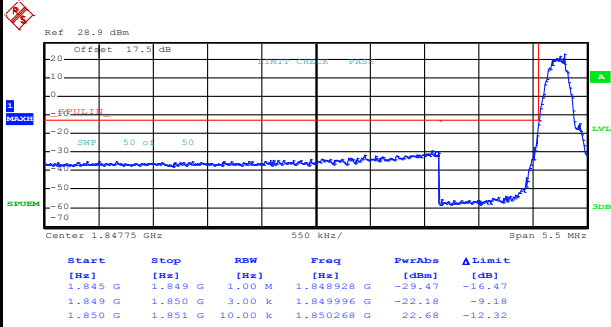

Date: 8.FEB.2016 15:56:44

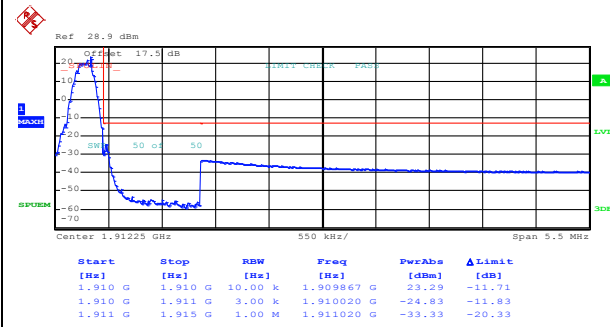

Date: 8.FEB.2016 15:58:49

GSM1900 (EDGE class 8)

Lowest Band Edge

Highest Band Edge

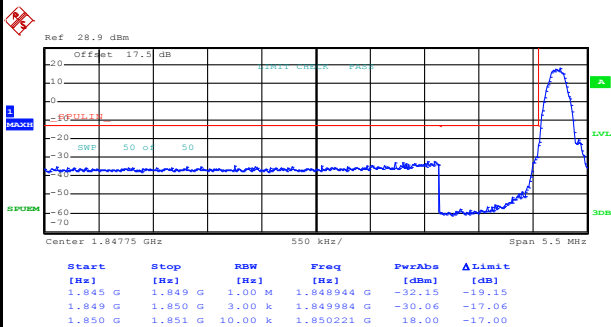

Date: 8.FEB.2016 16:12:22

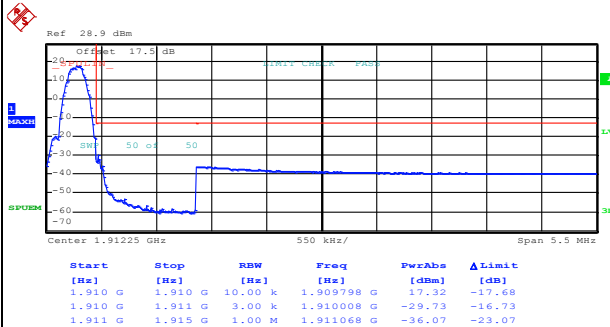

Date: 8.FEB.2016 16:13:56

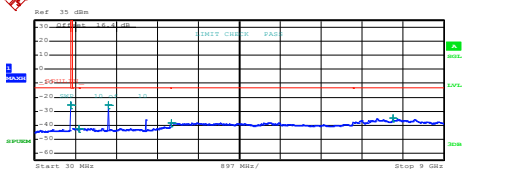
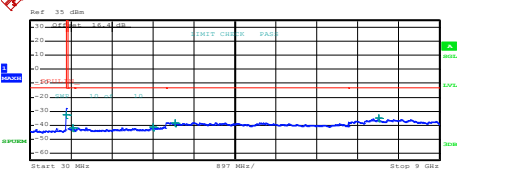
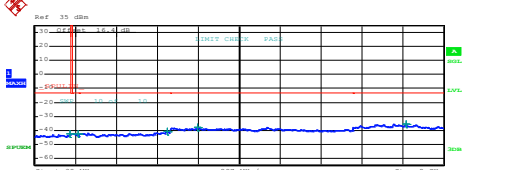
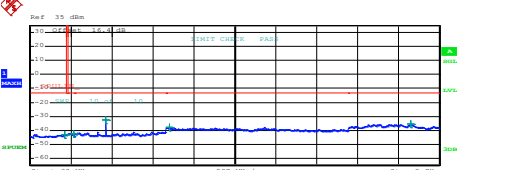
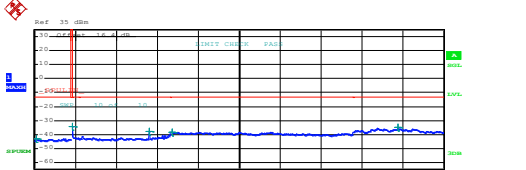
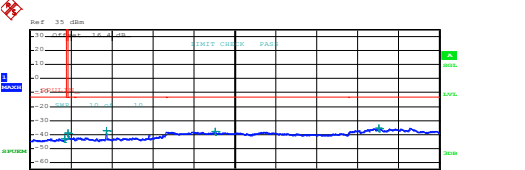

Conducted Spurious Emission

GSM850 (GPRS class 8)	GSM850 (EDGE class 8)																																																																								
Lowest Channel	Lowest Channel																																																																								
 <table border="1" data-bbox="239 622 702 705"> <thead> <tr> <th>Start [Hz]</th> <th>Stop [Hz]</th> <th>RBW [Hz]</th> <th>Freq [Hz]</th> <th>PwrAbs [dBm]</th> <th>ΔLimit [dB]</th> </tr> </thead> <tbody> <tr> <td>30,000 M</td> <td>820,000 M</td> <td>1,000 M</td> <td>819,802500 M</td> <td>-23.49</td> <td>-22.49</td> </tr> <tr> <td>855,000 M</td> <td>1,000 G</td> <td>1,000 M</td> <td>997,063760 M</td> <td>-42.25</td> <td>-29.25</td> </tr> <tr> <td>1,000 G</td> <td>3,000 G</td> <td>1,000 M</td> <td>1,6489000 G</td> <td>-23.35</td> <td>-22.35</td> </tr> <tr> <td>3,000 G</td> <td>7,000 G</td> <td>1,000 M</td> <td>3,0220000 G</td> <td>-38.27</td> <td>-25.27</td> </tr> <tr> <td>7,000 G</td> <td>9,000 G</td> <td>1,000 M</td> <td>7,8930000 G</td> <td>-34.88</td> <td>-21.88</td> </tr> </tbody> </table> <p>Date: 8.FEB.2016 15:01:23</p>	Start [Hz]	Stop [Hz]	RBW [Hz]	Freq [Hz]	PwrAbs [dBm]	ΔLimit [dB]	30,000 M	820,000 M	1,000 M	819,802500 M	-23.49	-22.49	855,000 M	1,000 G	1,000 M	997,063760 M	-42.25	-29.25	1,000 G	3,000 G	1,000 M	1,6489000 G	-23.35	-22.35	3,000 G	7,000 G	1,000 M	3,0220000 G	-38.27	-25.27	7,000 G	9,000 G	1,000 M	7,8930000 G	-34.88	-21.88	 <table border="1" data-bbox="893 622 1356 705"> <thead> <tr> <th>Start [Hz]</th> <th>Stop [Hz]</th> <th>RBW [Hz]</th> <th>Freq [Hz]</th> <th>PwrAbs [dBm]</th> <th>ΔLimit [dB]</th> </tr> </thead> <tbody> <tr> <td>30,000 M</td> <td>820,000 M</td> <td>1,000 M</td> <td>819,802500 M</td> <td>-23.57</td> <td>-19.57</td> </tr> <tr> <td>855,000 M</td> <td>1,000 G</td> <td>1,000 M</td> <td>961,393757 M</td> <td>-42.06</td> <td>-29.06</td> </tr> <tr> <td>1,000 G</td> <td>3,000 G</td> <td>1,000 M</td> <td>2,7320000 G</td> <td>-41.31</td> <td>-28.31</td> </tr> <tr> <td>3,000 G</td> <td>7,000 G</td> <td>1,000 M</td> <td>3,2140000 G</td> <td>-38.22</td> <td>-25.22</td> </tr> <tr> <td>7,000 G</td> <td>9,000 G</td> <td>1,000 M</td> <td>7,6720000 G</td> <td>-34.94</td> <td>-21.94</td> </tr> </tbody> </table> <p>Date: 8.FEB.2016 15:30:01</p>	Start [Hz]	Stop [Hz]	RBW [Hz]	Freq [Hz]	PwrAbs [dBm]	ΔLimit [dB]	30,000 M	820,000 M	1,000 M	819,802500 M	-23.57	-19.57	855,000 M	1,000 G	1,000 M	961,393757 M	-42.06	-29.06	1,000 G	3,000 G	1,000 M	2,7320000 G	-41.31	-28.31	3,000 G	7,000 G	1,000 M	3,2140000 G	-38.22	-25.22	7,000 G	9,000 G	1,000 M	7,6720000 G	-34.94	-21.94
Start [Hz]	Stop [Hz]	RBW [Hz]	Freq [Hz]	PwrAbs [dBm]	ΔLimit [dB]																																																																				
30,000 M	820,000 M	1,000 M	819,802500 M	-23.49	-22.49																																																																				
855,000 M	1,000 G	1,000 M	997,063760 M	-42.25	-29.25																																																																				
1,000 G	3,000 G	1,000 M	1,6489000 G	-23.35	-22.35																																																																				
3,000 G	7,000 G	1,000 M	3,0220000 G	-38.27	-25.27																																																																				
7,000 G	9,000 G	1,000 M	7,8930000 G	-34.88	-21.88																																																																				
Start [Hz]	Stop [Hz]	RBW [Hz]	Freq [Hz]	PwrAbs [dBm]	ΔLimit [dB]																																																																				
30,000 M	820,000 M	1,000 M	819,802500 M	-23.57	-19.57																																																																				
855,000 M	1,000 G	1,000 M	961,393757 M	-42.06	-29.06																																																																				
1,000 G	3,000 G	1,000 M	2,7320000 G	-41.31	-28.31																																																																				
3,000 G	7,000 G	1,000 M	3,2140000 G	-38.22	-25.22																																																																				
7,000 G	9,000 G	1,000 M	7,6720000 G	-34.94	-21.94																																																																				
Middle Channel	Middle Channel																																																																								
 <table border="1" data-bbox="239 1137 702 1220"> <thead> <tr> <th>Start [Hz]</th> <th>Stop [Hz]</th> <th>RBW [Hz]</th> <th>Freq [Hz]</th> <th>PwrAbs [dBm]</th> <th>ΔLimit [dB]</th> </tr> </thead> <tbody> <tr> <td>30,000 M</td> <td>820,000 M</td> <td>1,000 M</td> <td>809,385000 M</td> <td>-42.75</td> <td>-29.75</td> </tr> <tr> <td>855,000 M</td> <td>1,000 G</td> <td>1,000 M</td> <td>989,415000 M</td> <td>-42.27</td> <td>-29.27</td> </tr> <tr> <td>1,000 G</td> <td>3,000 G</td> <td>1,000 M</td> <td>2,9390000 G</td> <td>-40.55</td> <td>-27.55</td> </tr> <tr> <td>3,000 G</td> <td>7,000 G</td> <td>1,000 M</td> <td>3,0920000 G</td> <td>-37.84</td> <td>-24.84</td> </tr> <tr> <td>7,000 G</td> <td>9,000 G</td> <td>1,000 M</td> <td>8,1790000 G</td> <td>-35.32</td> <td>-22.32</td> </tr> </tbody> </table> <p>Date: 8.FEB.2016 15:02:16</p>	Start [Hz]	Stop [Hz]	RBW [Hz]	Freq [Hz]	PwrAbs [dBm]	ΔLimit [dB]	30,000 M	820,000 M	1,000 M	809,385000 M	-42.75	-29.75	855,000 M	1,000 G	1,000 M	989,415000 M	-42.27	-29.27	1,000 G	3,000 G	1,000 M	2,9390000 G	-40.55	-27.55	3,000 G	7,000 G	1,000 M	3,0920000 G	-37.84	-24.84	7,000 G	9,000 G	1,000 M	8,1790000 G	-35.32	-22.32	 <table border="1" data-bbox="893 1137 1356 1220"> <thead> <tr> <th>Start [Hz]</th> <th>Stop [Hz]</th> <th>RBW [Hz]</th> <th>Freq [Hz]</th> <th>PwrAbs [dBm]</th> <th>ΔLimit [dB]</th> </tr> </thead> <tbody> <tr> <td>30,000 M</td> <td>820,000 M</td> <td>1,000 M</td> <td>774,772500 M</td> <td>-42.83</td> <td>-29.83</td> </tr> <tr> <td>855,000 M</td> <td>1,000 G</td> <td>1,000 M</td> <td>986,478759 M</td> <td>-42.54</td> <td>-29.54</td> </tr> <tr> <td>1,000 G</td> <td>3,000 G</td> <td>1,000 M</td> <td>1,6730000 G</td> <td>-32.36</td> <td>-19.36</td> </tr> <tr> <td>3,000 G</td> <td>7,000 G</td> <td>1,000 M</td> <td>3,0770000 G</td> <td>-37.96</td> <td>-24.96</td> </tr> <tr> <td>7,000 G</td> <td>9,000 G</td> <td>1,000 M</td> <td>8,3725000 G</td> <td>-35.67</td> <td>-22.67</td> </tr> </tbody> </table> <p>Date: 8.FEB.2016 15:31:01</p>	Start [Hz]	Stop [Hz]	RBW [Hz]	Freq [Hz]	PwrAbs [dBm]	ΔLimit [dB]	30,000 M	820,000 M	1,000 M	774,772500 M	-42.83	-29.83	855,000 M	1,000 G	1,000 M	986,478759 M	-42.54	-29.54	1,000 G	3,000 G	1,000 M	1,6730000 G	-32.36	-19.36	3,000 G	7,000 G	1,000 M	3,0770000 G	-37.96	-24.96	7,000 G	9,000 G	1,000 M	8,3725000 G	-35.67	-22.67
Start [Hz]	Stop [Hz]	RBW [Hz]	Freq [Hz]	PwrAbs [dBm]	ΔLimit [dB]																																																																				
30,000 M	820,000 M	1,000 M	809,385000 M	-42.75	-29.75																																																																				
855,000 M	1,000 G	1,000 M	989,415000 M	-42.27	-29.27																																																																				
1,000 G	3,000 G	1,000 M	2,9390000 G	-40.55	-27.55																																																																				
3,000 G	7,000 G	1,000 M	3,0920000 G	-37.84	-24.84																																																																				
7,000 G	9,000 G	1,000 M	8,1790000 G	-35.32	-22.32																																																																				
Start [Hz]	Stop [Hz]	RBW [Hz]	Freq [Hz]	PwrAbs [dBm]	ΔLimit [dB]																																																																				
30,000 M	820,000 M	1,000 M	774,772500 M	-42.83	-29.83																																																																				
855,000 M	1,000 G	1,000 M	986,478759 M	-42.54	-29.54																																																																				
1,000 G	3,000 G	1,000 M	1,6730000 G	-32.36	-19.36																																																																				
3,000 G	7,000 G	1,000 M	3,0770000 G	-37.96	-24.96																																																																				
7,000 G	9,000 G	1,000 M	8,3725000 G	-35.67	-22.67																																																																				
Highest Channel	Highest Channel																																																																								
 <table border="1" data-bbox="239 1653 702 1736"> <thead> <tr> <th>Start [Hz]</th> <th>Stop [Hz]</th> <th>RBW [Hz]</th> <th>Freq [Hz]</th> <th>PwrAbs [dBm]</th> <th>ΔLimit [dB]</th> </tr> </thead> <tbody> <tr> <td>30,000 M</td> <td>820,000 M</td> <td>1,000 M</td> <td>60,217500 M</td> <td>-43.00</td> <td>-30.00</td> </tr> <tr> <td>855,000 M</td> <td>1,000 G</td> <td>1,000 M</td> <td>850,072500 M</td> <td>-34.14</td> <td>-21.14</td> </tr> <tr> <td>1,000 G</td> <td>3,000 G</td> <td>1,000 M</td> <td>2,2470000 G</td> <td>-37.76</td> <td>-24.76</td> </tr> <tr> <td>3,000 G</td> <td>7,000 G</td> <td>1,000 M</td> <td>3,0360000 G</td> <td>-38.17</td> <td>-25.17</td> </tr> <tr> <td>7,000 G</td> <td>9,000 G</td> <td>1,000 M</td> <td>8,0000000 G</td> <td>-35.09</td> <td>-22.09</td> </tr> </tbody> </table> <p>Date: 8.FEB.2016 15:03:10</p>	Start [Hz]	Stop [Hz]	RBW [Hz]	Freq [Hz]	PwrAbs [dBm]	ΔLimit [dB]	30,000 M	820,000 M	1,000 M	60,217500 M	-43.00	-30.00	855,000 M	1,000 G	1,000 M	850,072500 M	-34.14	-21.14	1,000 G	3,000 G	1,000 M	2,2470000 G	-37.76	-24.76	3,000 G	7,000 G	1,000 M	3,0360000 G	-38.17	-25.17	7,000 G	9,000 G	1,000 M	8,0000000 G	-35.09	-22.09	 <table border="1" data-bbox="893 1653 1356 1736"> <thead> <tr> <th>Start [Hz]</th> <th>Stop [Hz]</th> <th>RBW [Hz]</th> <th>Freq [Hz]</th> <th>PwrAbs [dBm]</th> <th>ΔLimit [dB]</th> </tr> </thead> <tbody> <tr> <td>30,000 M</td> <td>820,000 M</td> <td>1,000 M</td> <td>785,437500 M</td> <td>-42.83</td> <td>-29.83</td> </tr> <tr> <td>855,000 M</td> <td>1,000 G</td> <td>1,000 M</td> <td>853,072500 M</td> <td>-38.86</td> <td>-25.86</td> </tr> <tr> <td>1,000 G</td> <td>3,000 G</td> <td>1,000 M</td> <td>1,6975000 G</td> <td>-36.98</td> <td>-23.98</td> </tr> <tr> <td>3,000 G</td> <td>7,000 G</td> <td>1,000 M</td> <td>4,0890000 G</td> <td>-37.83</td> <td>-24.83</td> </tr> <tr> <td>7,000 G</td> <td>9,000 G</td> <td>1,000 M</td> <td>7,6705000 G</td> <td>-35.55</td> <td>-22.55</td> </tr> </tbody> </table> <p>Date: 8.FEB.2016 15:31:54</p>	Start [Hz]	Stop [Hz]	RBW [Hz]	Freq [Hz]	PwrAbs [dBm]	ΔLimit [dB]	30,000 M	820,000 M	1,000 M	785,437500 M	-42.83	-29.83	855,000 M	1,000 G	1,000 M	853,072500 M	-38.86	-25.86	1,000 G	3,000 G	1,000 M	1,6975000 G	-36.98	-23.98	3,000 G	7,000 G	1,000 M	4,0890000 G	-37.83	-24.83	7,000 G	9,000 G	1,000 M	7,6705000 G	-35.55	-22.55
Start [Hz]	Stop [Hz]	RBW [Hz]	Freq [Hz]	PwrAbs [dBm]	ΔLimit [dB]																																																																				
30,000 M	820,000 M	1,000 M	60,217500 M	-43.00	-30.00																																																																				
855,000 M	1,000 G	1,000 M	850,072500 M	-34.14	-21.14																																																																				
1,000 G	3,000 G	1,000 M	2,2470000 G	-37.76	-24.76																																																																				
3,000 G	7,000 G	1,000 M	3,0360000 G	-38.17	-25.17																																																																				
7,000 G	9,000 G	1,000 M	8,0000000 G	-35.09	-22.09																																																																				
Start [Hz]	Stop [Hz]	RBW [Hz]	Freq [Hz]	PwrAbs [dBm]	ΔLimit [dB]																																																																				
30,000 M	820,000 M	1,000 M	785,437500 M	-42.83	-29.83																																																																				
855,000 M	1,000 G	1,000 M	853,072500 M	-38.86	-25.86																																																																				
1,000 G	3,000 G	1,000 M	1,6975000 G	-36.98	-23.98																																																																				
3,000 G	7,000 G	1,000 M	4,0890000 G	-37.83	-24.83																																																																				
7,000 G	9,000 G	1,000 M	7,6705000 G	-35.55	-22.55																																																																				

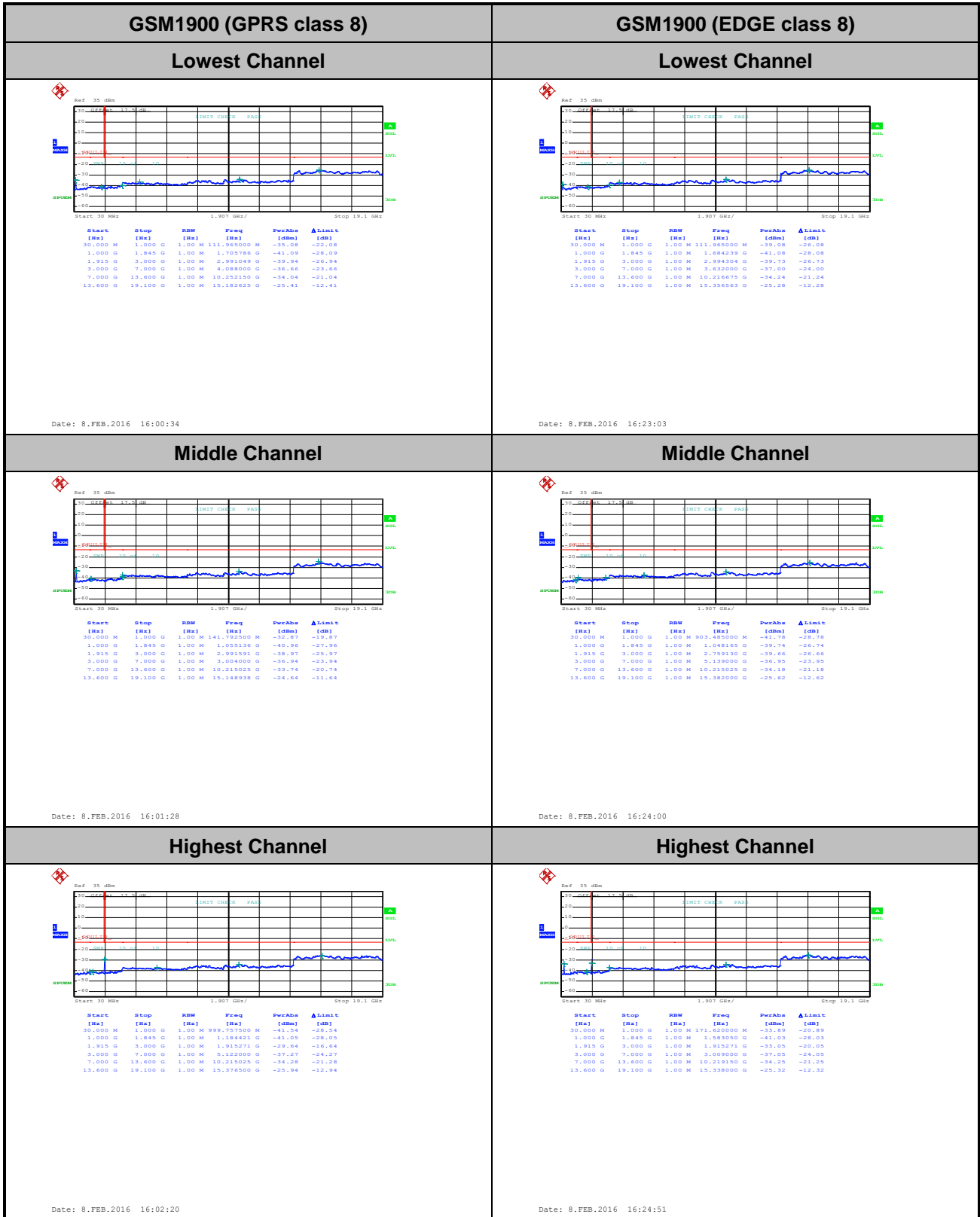



Frequency Stability

Test Conditions Temperature (°C)	Middle Channel Voltage (Volt)	GSM850 (GPRS class 8)	GSM850 (EDGE class 8)	Limit 2.5ppm
		Deviation (ppm)		Result
50	Normal Voltage	0.0072	0.0024	PASS
40	Normal Voltage	0.0060	0.0012	
30	Normal Voltage	0.0024	0.0084	
20(Ref.)	Normal Voltage	0.0000	0.0000	
10	Normal Voltage	0.0048	0.0096	
0	Normal Voltage	0.0012	0.0072	
-10	Normal Voltage	0.0036	0.0036	
-20	Normal Voltage	0.0024	0.0048	
-30	Normal Voltage	0.0012	0.0024	
20	Maximum Voltage	0.0024	0.0060	
20	Normal Voltage	0.0012	0.0012	
20	Battery End Point	0.0036	0.0108	

Note:

1. Normal Voltage = 3.8V. ; Battery End Point (BEP) = 3.2 V. ; Maximum Voltage =4.35 V
2. The frequency fundamental emissions stay within the authorized frequency block.



Test Conditions Temperature (°C)	Middle Channel Voltage (Volt)	GSM1900 (GPRS class 8)	GSM1900 (EDGE class 8)	Limit Note 2.
		Deviation (ppm)		Result
50	Normal Voltage	0.0064	0.0053	PASS
40	Normal Voltage	0.0059	0.0213	
30	Normal Voltage	0.0021	0.0005	
20(Ref.)	Normal Voltage	0.0000	0.0000	
10	Normal Voltage	0.0005	0.0011	
0	Normal Voltage	0.0011	0.0016	
-10	Normal Voltage	0.0016	0.0027	
-20	Normal Voltage	0.0043	0.0234	
-30	Normal Voltage	0.0037	0.0074	
20	Maximum Voltage	0.0037	0.0223	
20	Normal Voltage	0.0005	0.0207	
20	Battery End Point	0.0021	0.0287	

Note:

1. Normal Voltage = 3.8V. ; Battery End Point (BEP) = 3.2 V. ; Maximum Voltage =4.35 V
2. The frequency fundamental emissions stay within the authorized frequency block.



A2. WCDMA

Peak-to-Average Ratio

Mode	WCDMA Band V	WCDMA Band II	Limit: 13dB
Mod.	RMC 12.2Kbps	RMC 12.2Kbps	Result
Lowest CH	3.28	3.32	PASS
Middle CH	3.32	3.36	
Highest CH	3.36	3.36	

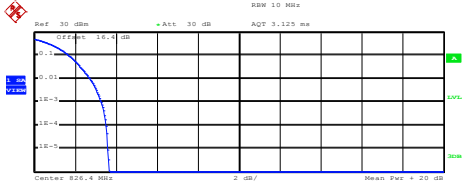
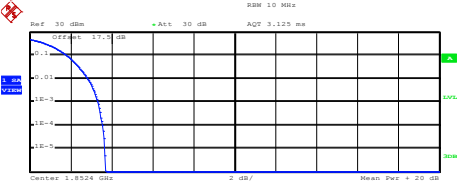
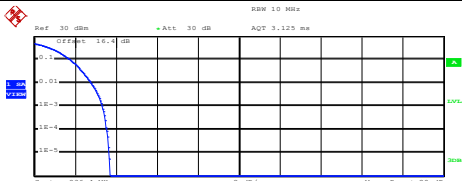
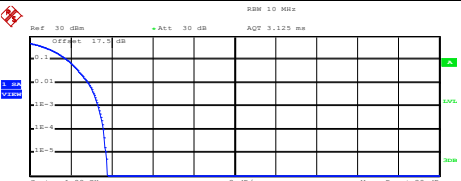
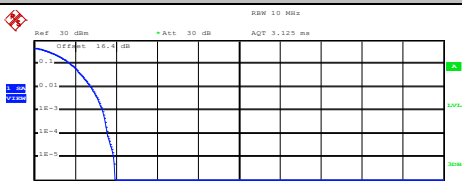
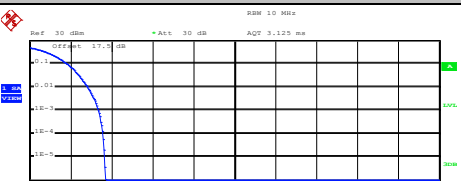

WCDMA Band V (RMC 12.2Kbps)	WCDMA Band II (RMC 12.2Kbps)																												
<p align="center">Lowest Channel</p>  <p>Center 826.4 MHz 2 dB/ Mean Pwr + 20 dB</p> <p>Complementary Cumulative Distribution Function (100000 samples) Trace 1</p> <table border="0"> <tr><td>Mean</td><td>23.84 dBm</td></tr> <tr><td>Peak</td><td>27.50 dBm</td></tr> <tr><td>Crest</td><td>3.66 dB</td></tr> </table> <table border="0"> <tr><td>10 %</td><td>1.72 dB</td></tr> <tr><td>1 %</td><td>2.72 dB</td></tr> <tr><td>.1 %</td><td>3.28 dB</td></tr> <tr><td>.01 %</td><td>3.52 dB</td></tr> </table> <p>Date: 8.FEB.2016 17:19:47</p>	Mean	23.84 dBm	Peak	27.50 dBm	Crest	3.66 dB	10 %	1.72 dB	1 %	2.72 dB	.1 %	3.28 dB	.01 %	3.52 dB	<p align="center">Lowest Channel</p>  <p>Center 1.8524 GHz 2 dB/ Mean Pwr + 20 dB</p> <p>Complementary Cumulative Distribution Function (100000 samples) Trace 1</p> <table border="0"> <tr><td>Mean</td><td>22.33 dBm</td></tr> <tr><td>Peak</td><td>26.02 dBm</td></tr> <tr><td>Crest</td><td>3.68 dB</td></tr> </table> <table border="0"> <tr><td>10 %</td><td>1.80 dB</td></tr> <tr><td>1 %</td><td>2.84 dB</td></tr> <tr><td>.1 %</td><td>3.32 dB</td></tr> <tr><td>.01 %</td><td>3.56 dB</td></tr> </table> <p>Date: 8.FEB.2016 16:49:45</p>	Mean	22.33 dBm	Peak	26.02 dBm	Crest	3.68 dB	10 %	1.80 dB	1 %	2.84 dB	.1 %	3.32 dB	.01 %	3.56 dB
Mean	23.84 dBm																												
Peak	27.50 dBm																												
Crest	3.66 dB																												
10 %	1.72 dB																												
1 %	2.72 dB																												
.1 %	3.28 dB																												
.01 %	3.52 dB																												
Mean	22.33 dBm																												
Peak	26.02 dBm																												
Crest	3.68 dB																												
10 %	1.80 dB																												
1 %	2.84 dB																												
.1 %	3.32 dB																												
.01 %	3.56 dB																												
<p align="center">Middle Channel</p>  <p>Center 836.4 MHz 2 dB/ Mean Pwr + 20 dB</p> <p>Complementary Cumulative Distribution Function (100000 samples) Trace 1</p> <table border="0"> <tr><td>Mean</td><td>23.58 dBm</td></tr> <tr><td>Peak</td><td>27.29 dBm</td></tr> <tr><td>Crest</td><td>3.71 dB</td></tr> </table> <table border="0"> <tr><td>10 %</td><td>1.76 dB</td></tr> <tr><td>1 %</td><td>2.76 dB</td></tr> <tr><td>.1 %</td><td>3.32 dB</td></tr> <tr><td>.01 %</td><td>3.56 dB</td></tr> </table> <p>Date: 8.FEB.2016 17:20:05</p>	Mean	23.58 dBm	Peak	27.29 dBm	Crest	3.71 dB	10 %	1.76 dB	1 %	2.76 dB	.1 %	3.32 dB	.01 %	3.56 dB	<p align="center">Middle Channel</p>  <p>Center 1.88 GHz 2 dB/ Mean Pwr + 20 dB</p> <p>Complementary Cumulative Distribution Function (100000 samples) Trace 1</p> <table border="0"> <tr><td>Mean</td><td>22.93 dBm</td></tr> <tr><td>Peak</td><td>26.72 dBm</td></tr> <tr><td>Crest</td><td>3.79 dB</td></tr> </table> <table border="0"> <tr><td>10 %</td><td>1.80 dB</td></tr> <tr><td>1 %</td><td>2.84 dB</td></tr> <tr><td>.1 %</td><td>3.36 dB</td></tr> <tr><td>.01 %</td><td>3.60 dB</td></tr> </table> <p>Date: 8.FEB.2016 16:50:05</p>	Mean	22.93 dBm	Peak	26.72 dBm	Crest	3.79 dB	10 %	1.80 dB	1 %	2.84 dB	.1 %	3.36 dB	.01 %	3.60 dB
Mean	23.58 dBm																												
Peak	27.29 dBm																												
Crest	3.71 dB																												
10 %	1.76 dB																												
1 %	2.76 dB																												
.1 %	3.32 dB																												
.01 %	3.56 dB																												
Mean	22.93 dBm																												
Peak	26.72 dBm																												
Crest	3.79 dB																												
10 %	1.80 dB																												
1 %	2.84 dB																												
.1 %	3.36 dB																												
.01 %	3.60 dB																												
<p align="center">Highest Channel</p>  <p>Center 846.6 MHz 2 dB/ Mean Pwr + 20 dB</p> <p>Complementary Cumulative Distribution Function (100000 samples) Trace 1</p> <table border="0"> <tr><td>Mean</td><td>22.21 dBm</td></tr> <tr><td>Peak</td><td>26.16 dBm</td></tr> <tr><td>Crest</td><td>3.95 dB</td></tr> </table> <table border="0"> <tr><td>10 %</td><td>1.76 dB</td></tr> <tr><td>1 %</td><td>2.76 dB</td></tr> <tr><td>.1 %</td><td>3.36 dB</td></tr> <tr><td>.01 %</td><td>3.60 dB</td></tr> </table> <p>Date: 8.FEB.2016 17:20:23</p>	Mean	22.21 dBm	Peak	26.16 dBm	Crest	3.95 dB	10 %	1.76 dB	1 %	2.76 dB	.1 %	3.36 dB	.01 %	3.60 dB	<p align="center">Highest Channel</p>  <p>Center 1.9076 GHz 2 dB/ Mean Pwr + 20 dB</p> <p>Complementary Cumulative Distribution Function (100000 samples) Trace 1</p> <table border="0"> <tr><td>Mean</td><td>22.62 dBm</td></tr> <tr><td>Peak</td><td>26.30 dBm</td></tr> <tr><td>Crest</td><td>3.68 dB</td></tr> </table> <table border="0"> <tr><td>10 %</td><td>1.84 dB</td></tr> <tr><td>1 %</td><td>2.84 dB</td></tr> <tr><td>.1 %</td><td>3.36 dB</td></tr> <tr><td>.01 %</td><td>3.56 dB</td></tr> </table> <p>Date: 8.FEB.2016 16:50:22</p>	Mean	22.62 dBm	Peak	26.30 dBm	Crest	3.68 dB	10 %	1.84 dB	1 %	2.84 dB	.1 %	3.36 dB	.01 %	3.56 dB
Mean	22.21 dBm																												
Peak	26.16 dBm																												
Crest	3.95 dB																												
10 %	1.76 dB																												
1 %	2.76 dB																												
.1 %	3.36 dB																												
.01 %	3.60 dB																												
Mean	22.62 dBm																												
Peak	26.30 dBm																												
Crest	3.68 dB																												
10 %	1.84 dB																												
1 %	2.84 dB																												
.1 %	3.36 dB																												
.01 %	3.56 dB																												



26dB Bandwidth

Mode	WCDMA Band V	WCDMA Band II
Mod.	RMC 12.2Kbps	RMC 12.2Kbps
Lowest CH	4.70	4.68
Middle CH	4.69	4.68
Highest CH	4.70	4.68



WCDMA Band V (RMC 12.2Kbps)

WCDMA Band II (RMC 12.2Kbps)

Lowest Channel

Lowest Channel

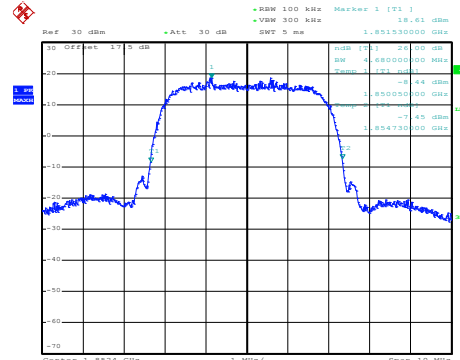
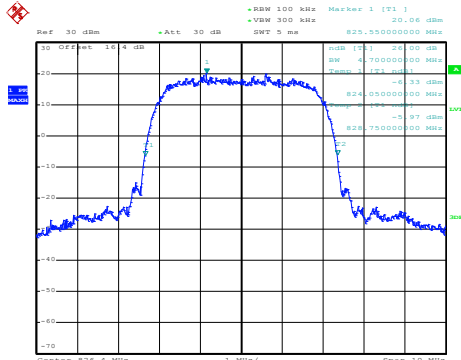

Date: 8.FEB.2016 16:55:06

Date: 8.FEB.2016 16:34:05

Middle Channel

Middle Channel

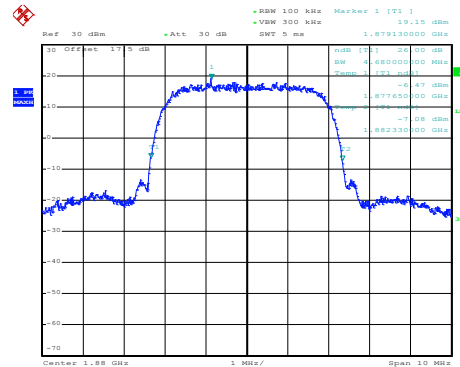
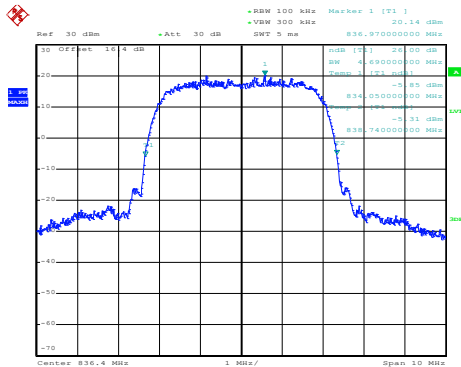

Date: 8.FEB.2016 16:56:03

Date: 8.FEB.2016 16:34:43

Highest Channel

Highest Channel

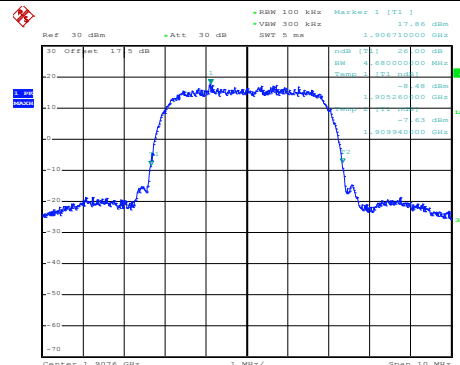
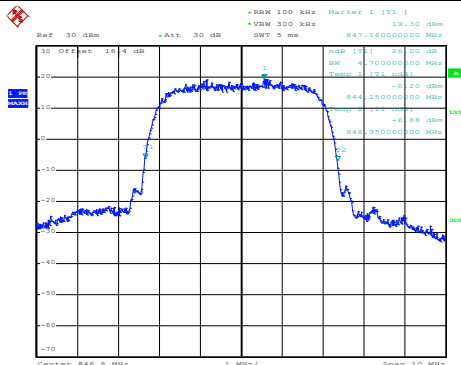

Date: 8.FEB.2016 16:56:39

Date: 8.FEB.2016 16:35:20



Occupied Bandwidth

Mode	WCDMA Band V	WCDMA Band II
Mod.	RMC 12.2Kbps	RMC 12.2Kbps
Lowest CH	4.11	4.13
Middle CH	4.12	4.11
Highest CH	4.12	4.14



WCDMA Band V (RMC 12.2Kbps)

Lowest Channel

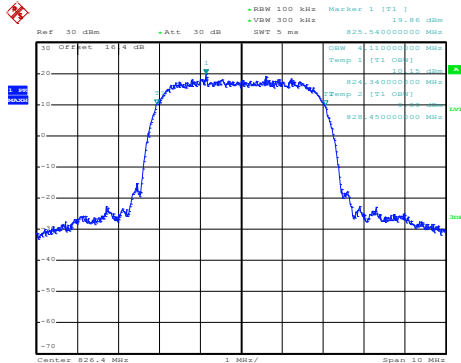

Date: 8.FEB.2016 17:21:29

WCDMA Band II (RMC 12.2Kbps)

Lowest Channel

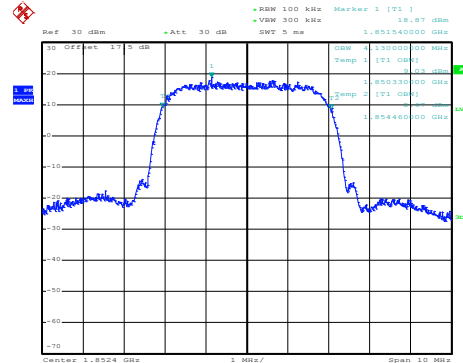

Date: 8.FEB.2016 16:36:08

Middle Channel

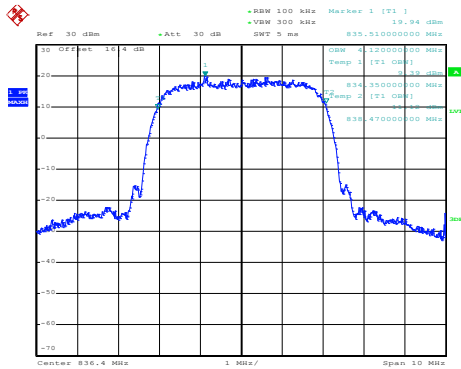

Date: 8.FEB.2016 17:22:03

Middle Channel

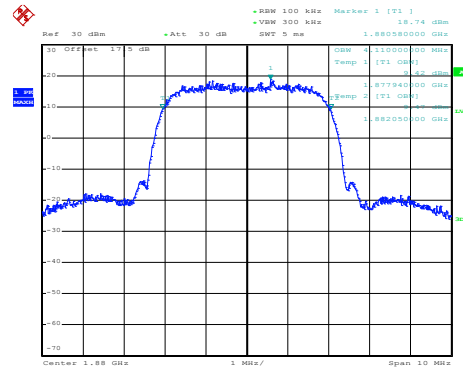

Date: 8.FEB.2016 16:36:51

Highest Channel

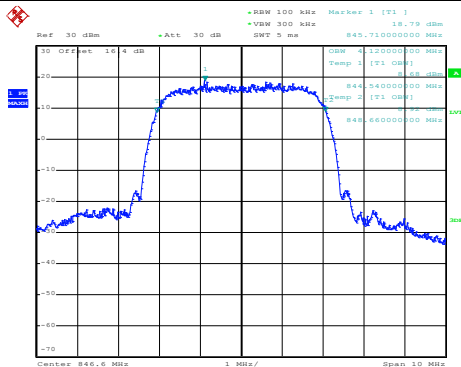

Date: 8.FEB.2016 17:22:38

Highest Channel

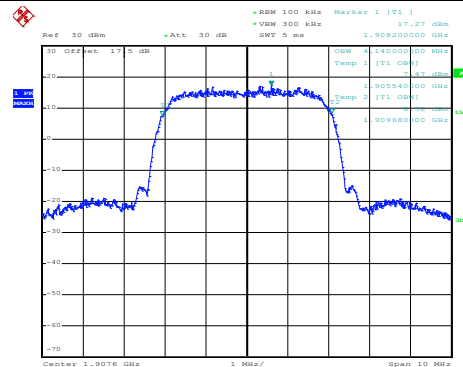

Date: 8.FEB.2016 16:37:28



Conducted Band Edge

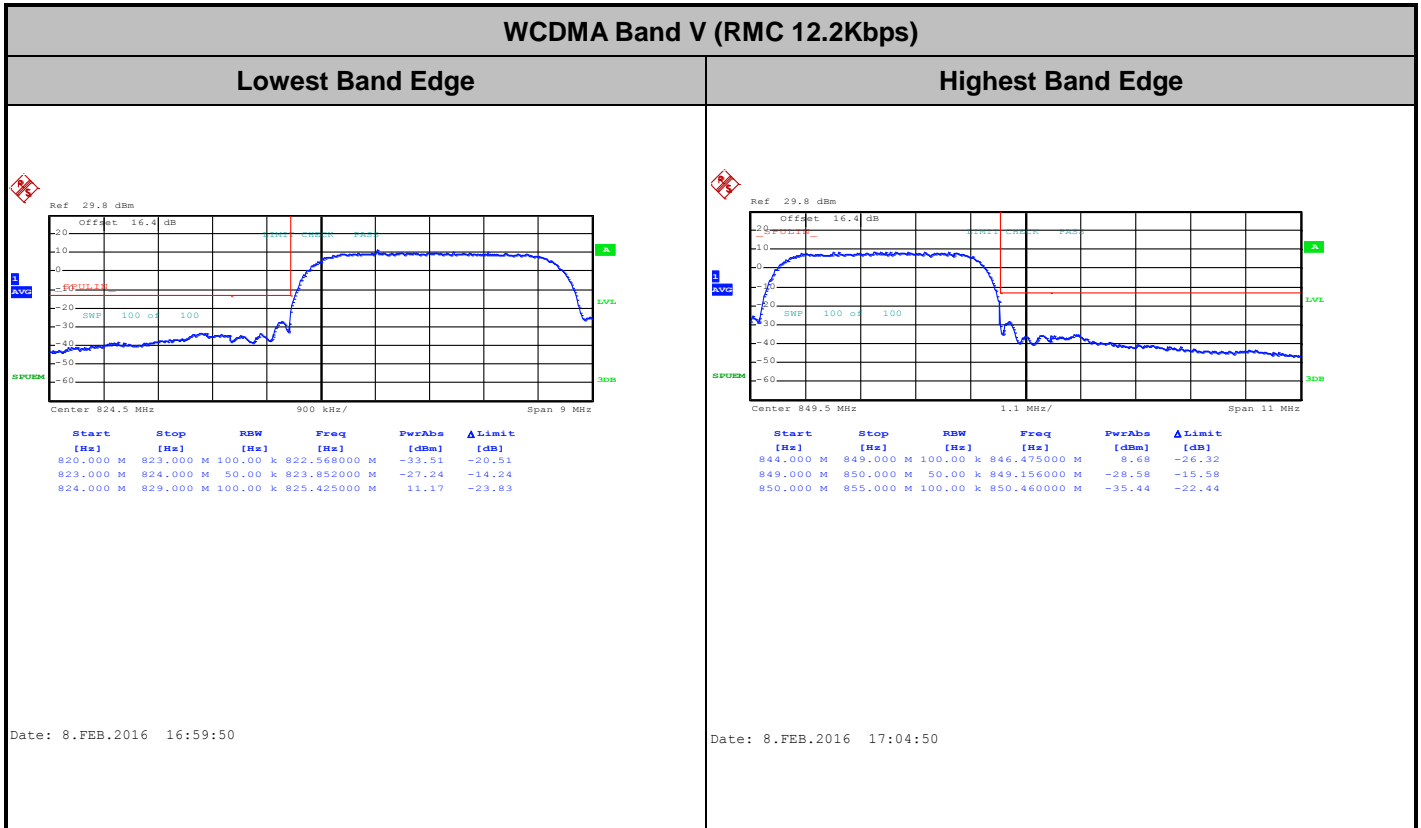



WCDMA Band II (RMC 12.2Kbps)

Lowest Band Edge

Highest Band Edge

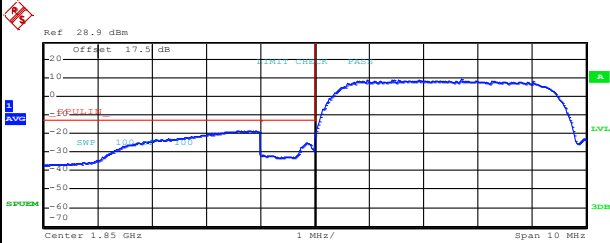

Start [Hz]	Stop [Hz]	RBW [Hz]	Freq [Hz]	PwrAbs [dBm]	ΔLimit [dB]
1.845 G	1.849 G	1.00 M	1.848560 G	-19.78	-5.78
1.849 G	1.850 G	50.00 k	1.849844 G	-25.39	-12.39
1.850 G	1.855 G	100.00 k	1.852690 G	9.26	-25.74

Date: 8.FEB.2016 16:40:33

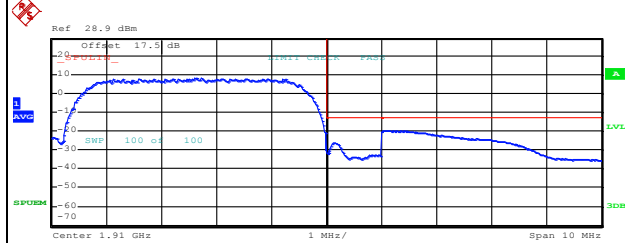

Start [Hz]	Stop [Hz]	RBW [Hz]	Freq [Hz]	PwrAbs [dBm]	ΔLimit [dB]
1.905 G	1.910 G	100.00 k	1.907605 G	8.15	-26.85
1.910 G	1.911 G	50.00 k	1.910116 G	-26.30	-13.30
1.911 G	1.915 G	1.00 M	1.911448 G	-19.94	-6.94

Date: 8.FEB.2016 16:43:35

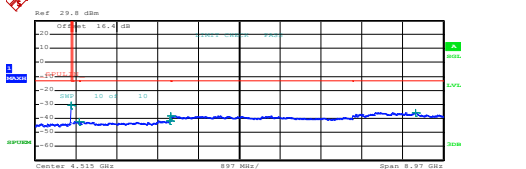
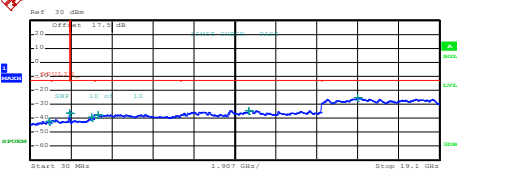
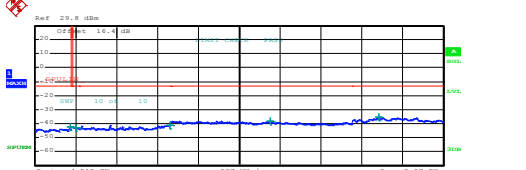
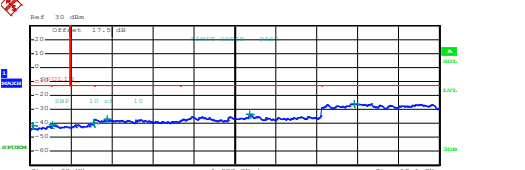
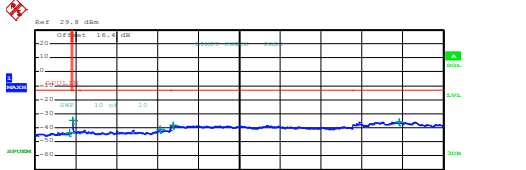
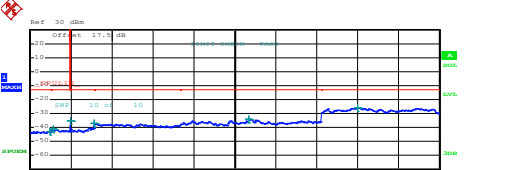

Conducted Spurious Emission

WCDMA Band V (RMC 12.2Kbps)	WCDMA Band II (RMC 12.2Kbps)																																																																														
Lowest Channel	Lowest Channel																																																																														
 <p>Ref: 29.8 dBm Offset: 16.4 dB Center: 4.515 GHz Span: 8.97 GHz</p> <table border="1"> <thead> <tr> <th>Start [Hz]</th> <th>Stop [Hz]</th> <th>RBW [Hz]</th> <th>Freq [Hz]</th> <th>PwrAbs [dBm]</th> <th>ΔLimit [dB]</th> </tr> </thead> <tbody> <tr> <td>30,000 M</td> <td>820,000 M</td> <td>1,000 M</td> <td>810,012500 M</td> <td>-30.87</td> <td>-27.87</td> </tr> <tr> <td>835,000 M</td> <td>1,000 G</td> <td>1,000 M</td> <td>999,565010 M</td> <td>-42.39</td> <td>-29.39</td> </tr> <tr> <td>1,000 G</td> <td>3,000 G</td> <td>1,000 M</td> <td>2,098500 G</td> <td>-42.27</td> <td>-28.27</td> </tr> <tr> <td>3,000 G</td> <td>7,000 G</td> <td>1,000 M</td> <td>3,014000 G</td> <td>-38.40</td> <td>-25.40</td> </tr> <tr> <td>7,000 G</td> <td>9,000 G</td> <td>1,000 M</td> <td>8,399000 G</td> <td>-35.96</td> <td>-22.96</td> </tr> </tbody> </table> <p>Date: 8.FEB.2016 17:12:10</p>	Start [Hz]	Stop [Hz]	RBW [Hz]	Freq [Hz]	PwrAbs [dBm]	ΔLimit [dB]	30,000 M	820,000 M	1,000 M	810,012500 M	-30.87	-27.87	835,000 M	1,000 G	1,000 M	999,565010 M	-42.39	-29.39	1,000 G	3,000 G	1,000 M	2,098500 G	-42.27	-28.27	3,000 G	7,000 G	1,000 M	3,014000 G	-38.40	-25.40	7,000 G	9,000 G	1,000 M	8,399000 G	-35.96	-22.96	 <p>Ref: 30 dBm Offset: 17.1 dB Start: 30 MHz Stop: 19.1 GHz</p> <table border="1"> <thead> <tr> <th>Start [Hz]</th> <th>Stop [Hz]</th> <th>RBW [Hz]</th> <th>Freq [Hz]</th> <th>PwrAbs [dBm]</th> <th>ΔLimit [dB]</th> </tr> </thead> <tbody> <tr> <td>30,000 M</td> <td>1,000 G</td> <td>1,000 M</td> <td>900,039500 M</td> <td>-41.94</td> <td>-28.94</td> </tr> <tr> <td>1,000 G</td> <td>1,845 G</td> <td>1,000 M</td> <td>1,844789 G</td> <td>-36.16</td> <td>-23.16</td> </tr> <tr> <td>1,915 G</td> <td>3,000 G</td> <td>1,000 M</td> <td>2,899010 G</td> <td>-39.18</td> <td>-26.18</td> </tr> <tr> <td>3,000 G</td> <td>7,000 G</td> <td>1,000 M</td> <td>3,196000 G</td> <td>-37.36</td> <td>-24.36</td> </tr> <tr> <td>7,000 G</td> <td>13,600 G</td> <td>1,000 M</td> <td>10,215025 G</td> <td>-34.40</td> <td>-21.40</td> </tr> <tr> <td>13,600 G</td> <td>19,100 G</td> <td>1,000 M</td> <td>15,303625 G</td> <td>-25.42</td> <td>-12.42</td> </tr> </tbody> </table> <p>Date: 8.FEB.2016 16:46:45</p>	Start [Hz]	Stop [Hz]	RBW [Hz]	Freq [Hz]	PwrAbs [dBm]	ΔLimit [dB]	30,000 M	1,000 G	1,000 M	900,039500 M	-41.94	-28.94	1,000 G	1,845 G	1,000 M	1,844789 G	-36.16	-23.16	1,915 G	3,000 G	1,000 M	2,899010 G	-39.18	-26.18	3,000 G	7,000 G	1,000 M	3,196000 G	-37.36	-24.36	7,000 G	13,600 G	1,000 M	10,215025 G	-34.40	-21.40	13,600 G	19,100 G	1,000 M	15,303625 G	-25.42	-12.42
Start [Hz]	Stop [Hz]	RBW [Hz]	Freq [Hz]	PwrAbs [dBm]	ΔLimit [dB]																																																																										
30,000 M	820,000 M	1,000 M	810,012500 M	-30.87	-27.87																																																																										
835,000 M	1,000 G	1,000 M	999,565010 M	-42.39	-29.39																																																																										
1,000 G	3,000 G	1,000 M	2,098500 G	-42.27	-28.27																																																																										
3,000 G	7,000 G	1,000 M	3,014000 G	-38.40	-25.40																																																																										
7,000 G	9,000 G	1,000 M	8,399000 G	-35.96	-22.96																																																																										
Start [Hz]	Stop [Hz]	RBW [Hz]	Freq [Hz]	PwrAbs [dBm]	ΔLimit [dB]																																																																										
30,000 M	1,000 G	1,000 M	900,039500 M	-41.94	-28.94																																																																										
1,000 G	1,845 G	1,000 M	1,844789 G	-36.16	-23.16																																																																										
1,915 G	3,000 G	1,000 M	2,899010 G	-39.18	-26.18																																																																										
3,000 G	7,000 G	1,000 M	3,196000 G	-37.36	-24.36																																																																										
7,000 G	13,600 G	1,000 M	10,215025 G	-34.40	-21.40																																																																										
13,600 G	19,100 G	1,000 M	15,303625 G	-25.42	-12.42																																																																										
Middle Channel	Middle Channel																																																																														
 <p>Ref: 29.8 dBm Offset: 16.4 dB Center: 4.515 GHz Span: 8.97 GHz</p> <table border="1"> <thead> <tr> <th>Start [Hz]</th> <th>Stop [Hz]</th> <th>RBW [Hz]</th> <th>Freq [Hz]</th> <th>PwrAbs [dBm]</th> <th>ΔLimit [dB]</th> </tr> </thead> <tbody> <tr> <td>30,000 M</td> <td>820,000 M</td> <td>1,000 M</td> <td>809,137500 M</td> <td>-42.53</td> <td>-29.53</td> </tr> <tr> <td>835,000 M</td> <td>1,000 G</td> <td>1,000 M</td> <td>934,097500 M</td> <td>-42.90</td> <td>-29.90</td> </tr> <tr> <td>1,000 G</td> <td>3,000 G</td> <td>1,000 M</td> <td>2,086500 G</td> <td>-41.20</td> <td>-28.20</td> </tr> <tr> <td>3,000 G</td> <td>7,000 G</td> <td>1,000 M</td> <td>3,188000 G</td> <td>-38.10</td> <td>-25.10</td> </tr> <tr> <td>7,000 G</td> <td>9,000 G</td> <td>1,000 M</td> <td>7,283500 G</td> <td>-35.31</td> <td>-22.31</td> </tr> </tbody> </table> <p>Date: 8.FEB.2016 17:13:03</p>	Start [Hz]	Stop [Hz]	RBW [Hz]	Freq [Hz]	PwrAbs [dBm]	ΔLimit [dB]	30,000 M	820,000 M	1,000 M	809,137500 M	-42.53	-29.53	835,000 M	1,000 G	1,000 M	934,097500 M	-42.90	-29.90	1,000 G	3,000 G	1,000 M	2,086500 G	-41.20	-28.20	3,000 G	7,000 G	1,000 M	3,188000 G	-38.10	-25.10	7,000 G	9,000 G	1,000 M	7,283500 G	-35.31	-22.31	 <p>Ref: 30 dBm Offset: 17.1 dB Start: 30 MHz Stop: 19.1 GHz</p> <table border="1"> <thead> <tr> <th>Start [Hz]</th> <th>Stop [Hz]</th> <th>RBW [Hz]</th> <th>Freq [Hz]</th> <th>PwrAbs [dBm]</th> <th>ΔLimit [dB]</th> </tr> </thead> <tbody> <tr> <td>30,000 M</td> <td>1,000 G</td> <td>1,000 M</td> <td>140,827500 M</td> <td>-41.89</td> <td>-28.89</td> </tr> <tr> <td>1,000 G</td> <td>1,845 G</td> <td>1,000 M</td> <td>3,043500 G</td> <td>-43.23</td> <td>-28.23</td> </tr> <tr> <td>1,915 G</td> <td>3,000 G</td> <td>1,000 M</td> <td>3,000000 G</td> <td>-40.17</td> <td>-27.17</td> </tr> <tr> <td>3,000 G</td> <td>7,000 G</td> <td>1,000 M</td> <td>3,597000 G</td> <td>-37.14</td> <td>-24.14</td> </tr> <tr> <td>7,000 G</td> <td>13,600 G</td> <td>1,000 M</td> <td>10,243500 G</td> <td>-33.52</td> <td>-20.52</td> </tr> <tr> <td>13,600 G</td> <td>19,100 G</td> <td>1,000 M</td> <td>15,136500 G</td> <td>-25.98</td> <td>-12.98</td> </tr> </tbody> </table> <p>Date: 8.FEB.2016 16:47:55</p>	Start [Hz]	Stop [Hz]	RBW [Hz]	Freq [Hz]	PwrAbs [dBm]	ΔLimit [dB]	30,000 M	1,000 G	1,000 M	140,827500 M	-41.89	-28.89	1,000 G	1,845 G	1,000 M	3,043500 G	-43.23	-28.23	1,915 G	3,000 G	1,000 M	3,000000 G	-40.17	-27.17	3,000 G	7,000 G	1,000 M	3,597000 G	-37.14	-24.14	7,000 G	13,600 G	1,000 M	10,243500 G	-33.52	-20.52	13,600 G	19,100 G	1,000 M	15,136500 G	-25.98	-12.98
Start [Hz]	Stop [Hz]	RBW [Hz]	Freq [Hz]	PwrAbs [dBm]	ΔLimit [dB]																																																																										
30,000 M	820,000 M	1,000 M	809,137500 M	-42.53	-29.53																																																																										
835,000 M	1,000 G	1,000 M	934,097500 M	-42.90	-29.90																																																																										
1,000 G	3,000 G	1,000 M	2,086500 G	-41.20	-28.20																																																																										
3,000 G	7,000 G	1,000 M	3,188000 G	-38.10	-25.10																																																																										
7,000 G	9,000 G	1,000 M	7,283500 G	-35.31	-22.31																																																																										
Start [Hz]	Stop [Hz]	RBW [Hz]	Freq [Hz]	PwrAbs [dBm]	ΔLimit [dB]																																																																										
30,000 M	1,000 G	1,000 M	140,827500 M	-41.89	-28.89																																																																										
1,000 G	1,845 G	1,000 M	3,043500 G	-43.23	-28.23																																																																										
1,915 G	3,000 G	1,000 M	3,000000 G	-40.17	-27.17																																																																										
3,000 G	7,000 G	1,000 M	3,597000 G	-37.14	-24.14																																																																										
7,000 G	13,600 G	1,000 M	10,243500 G	-33.52	-20.52																																																																										
13,600 G	19,100 G	1,000 M	15,136500 G	-25.98	-12.98																																																																										
Highest Channel	Highest Channel																																																																														
 <p>Ref: 29.8 dBm Offset: 16.4 dB Center: 4.515 GHz Span: 8.97 GHz</p> <table border="1"> <thead> <tr> <th>Start [Hz]</th> <th>Stop [Hz]</th> <th>RBW [Hz]</th> <th>Freq [Hz]</th> <th>PwrAbs [dBm]</th> <th>ΔLimit [dB]</th> </tr> </thead> <tbody> <tr> <td>30,000 M</td> <td>820,000 M</td> <td>1,000 M</td> <td>786,030000 M</td> <td>-43.00</td> <td>-30.00</td> </tr> <tr> <td>835,000 M</td> <td>1,000 G</td> <td>1,000 M</td> <td>850,036250 M</td> <td>-34.57</td> <td>-21.57</td> </tr> <tr> <td>1,000 G</td> <td>3,000 G</td> <td>1,000 M</td> <td>2,708000 G</td> <td>-42.43</td> <td>-28.43</td> </tr> <tr> <td>3,000 G</td> <td>7,000 G</td> <td>1,000 M</td> <td>3,056000 G</td> <td>-38.10</td> <td>-25.10</td> </tr> <tr> <td>7,000 G</td> <td>9,000 G</td> <td>1,000 M</td> <td>8,039500 G</td> <td>-35.97</td> <td>-22.97</td> </tr> </tbody> </table> <p>Date: 8.FEB.2016 17:13:36</p>	Start [Hz]	Stop [Hz]	RBW [Hz]	Freq [Hz]	PwrAbs [dBm]	ΔLimit [dB]	30,000 M	820,000 M	1,000 M	786,030000 M	-43.00	-30.00	835,000 M	1,000 G	1,000 M	850,036250 M	-34.57	-21.57	1,000 G	3,000 G	1,000 M	2,708000 G	-42.43	-28.43	3,000 G	7,000 G	1,000 M	3,056000 G	-38.10	-25.10	7,000 G	9,000 G	1,000 M	8,039500 G	-35.97	-22.97	 <p>Ref: 30 dBm Offset: 17.1 dB Start: 30 MHz Stop: 19.1 GHz</p> <table border="1"> <thead> <tr> <th>Start [Hz]</th> <th>Stop [Hz]</th> <th>RBW [Hz]</th> <th>Freq [Hz]</th> <th>PwrAbs [dBm]</th> <th>ΔLimit [dB]</th> </tr> </thead> <tbody> <tr> <td>30,000 M</td> <td>1,000 G</td> <td>1,000 M</td> <td>943,037500 M</td> <td>-42.69</td> <td>-29.69</td> </tr> <tr> <td>1,000 G</td> <td>1,845 G</td> <td>1,000 M</td> <td>1,080275 G</td> <td>-40.91</td> <td>-27.91</td> </tr> <tr> <td>1,915 G</td> <td>3,000 G</td> <td>1,000 M</td> <td>2,93271 G</td> <td>-34.88</td> <td>-21.88</td> </tr> <tr> <td>3,000 G</td> <td>7,000 G</td> <td>1,000 M</td> <td>3,017000 G</td> <td>-37.16</td> <td>-24.16</td> </tr> <tr> <td>7,000 G</td> <td>13,600 G</td> <td>1,000 M</td> <td>10,216675 G</td> <td>-34.18</td> <td>-21.18</td> </tr> <tr> <td>13,600 G</td> <td>19,100 G</td> <td>1,000 M</td> <td>15,298125 G</td> <td>-25.61</td> <td>-12.61</td> </tr> </tbody> </table> <p>Date: 8.FEB.2016 16:49:12</p>	Start [Hz]	Stop [Hz]	RBW [Hz]	Freq [Hz]	PwrAbs [dBm]	ΔLimit [dB]	30,000 M	1,000 G	1,000 M	943,037500 M	-42.69	-29.69	1,000 G	1,845 G	1,000 M	1,080275 G	-40.91	-27.91	1,915 G	3,000 G	1,000 M	2,93271 G	-34.88	-21.88	3,000 G	7,000 G	1,000 M	3,017000 G	-37.16	-24.16	7,000 G	13,600 G	1,000 M	10,216675 G	-34.18	-21.18	13,600 G	19,100 G	1,000 M	15,298125 G	-25.61	-12.61
Start [Hz]	Stop [Hz]	RBW [Hz]	Freq [Hz]	PwrAbs [dBm]	ΔLimit [dB]																																																																										
30,000 M	820,000 M	1,000 M	786,030000 M	-43.00	-30.00																																																																										
835,000 M	1,000 G	1,000 M	850,036250 M	-34.57	-21.57																																																																										
1,000 G	3,000 G	1,000 M	2,708000 G	-42.43	-28.43																																																																										
3,000 G	7,000 G	1,000 M	3,056000 G	-38.10	-25.10																																																																										
7,000 G	9,000 G	1,000 M	8,039500 G	-35.97	-22.97																																																																										
Start [Hz]	Stop [Hz]	RBW [Hz]	Freq [Hz]	PwrAbs [dBm]	ΔLimit [dB]																																																																										
30,000 M	1,000 G	1,000 M	943,037500 M	-42.69	-29.69																																																																										
1,000 G	1,845 G	1,000 M	1,080275 G	-40.91	-27.91																																																																										
1,915 G	3,000 G	1,000 M	2,93271 G	-34.88	-21.88																																																																										
3,000 G	7,000 G	1,000 M	3,017000 G	-37.16	-24.16																																																																										
7,000 G	13,600 G	1,000 M	10,216675 G	-34.18	-21.18																																																																										
13,600 G	19,100 G	1,000 M	15,298125 G	-25.61	-12.61																																																																										



Frequency Stability

Test Conditions	Middle Channel	WCDMA Band V (RMC 12.2Kbps)	Limit
Temperature (°C)	Voltage (Volt)	Deviation (ppm)	2.5ppm Result
50	Normal Voltage	0.0048	PASS
40	Normal Voltage	0.0024	
30	Normal Voltage	0.0096	
20(Ref.)	Normal Voltage	0.0000	
10	Normal Voltage	0.0012	
0	Normal Voltage	0.0000	
-10	Normal Voltage	0.0036	
-20	Normal Voltage	0.0120	
-30	Normal Voltage	0.0060	
20	Maximum Voltage	0.0000	
20	Normal Voltage	0.0012	
20	Battery End Point	0.0120	

Note:

- 1. Normal Voltage = 3.8V. ; Battery End Point (BEP) = 3.2 V. ; Maximum Voltage =4.35 V
- 2. The frequency fundamental emissions stay within the authorized frequency block.



Test Conditions Temperature (°C)	Middle Channel Voltage (Volt)	WCDMA Band II (RMC 12.2Kbps)	Limit Note 2.
		Deviation (ppm)	Result
50	Normal Voltage	0.0016	PASS
40	Normal Voltage	0.0005	
30	Normal Voltage	0.0005	
20(Ref.)	Normal Voltage	0.0000	
10	Normal Voltage	0.0011	
0	Normal Voltage	0.0005	
-10	Normal Voltage	0.0021	
-20	Normal Voltage	0.0011	
-30	Normal Voltage	0.0016	
20	Maximum Voltage	0.0005	
20	Normal Voltage	0.0005	
20	Battery End Point	0.0011	

Note:

- 1. Normal Voltage = 3.8V. ; Battery End Point (BEP) = 3.2 V. ; Maximum Voltage =4.35 V
- 2. The frequency fundamental emissions stay within the authorized frequency block.



Appendix B. Test Results of Radiated Test

ERP/EIRP

GSM850 (GPRS class 8) Radiated Power ERP							
Horizontal Polarization							
Frequency (MHz)	LVL (dBm)	Tx Cable Loss (dB)	Tx ANT Gain (dBi)	SA Reading (dB)	Correction Factor (dB)	ERP (dBm)	ERP (W)
824.2	-16.90	7.65	0.48	-38.72	31.56	12.51	0.0178
836.4	-17.18	7.69	0.49	-38.81	31.61	12.28	0.0169
848.8	-17.52	7.73	0.50	-38.83	31.60	11.93	0.0156
Vertical Polarization							
Frequency (MHz)	LVL (dBm)	Tx Cable Loss (dB)	Tx ANT Gain (dBi)	SA Reading (dB)	Correction Factor (dB)	ERP (dBm)	ERP (W)
824.2	-1.17	7.65	0.48	-40.20	33.04	29.72	0.9376
836.4	-1.43	7.69	0.49	-40.63	33.43	29.85	0.9661
848.8	-1.03	7.73	0.50	-40.45	33.22	30.04	1.0093

* ERP = LVL (dBm) + Correction Factor (dB) - 2.15

S.G. power = 0 (dBm)

GSM850 (EDGE class 8) Radiated Power ERP							
Horizontal Polarization							
Frequency (MHz)	LVL (dBm)	Tx Cable Loss (dB)	Tx ANT Gain (dBi)	SA Reading (dB)	Correction Factor (dB)	ERP (dBm)	ERP (W)
824.2	-23.28	7.65	0.48	-38.87	31.71	6.28	0.0042
836.4	-22.94	7.69	0.49	-38.56	31.36	6.27	0.0042
848.8	-23.34	7.73	0.50	-37.87	30.64	5.15	0.0033
Vertical Polarization							
Frequency (MHz)	LVL (dBm)	Tx Cable Loss (dB)	Tx ANT Gain (dBi)	SA Reading (dB)	Correction Factor (dB)	ERP (dBm)	ERP (W)
824.2	-6.57	7.65	0.48	-39.30	32.14	23.42	0.2196
836.4	-7.35	7.69	0.49	-40.50	33.30	23.80	0.2401
848.8	-7.88	7.73	0.50	-40.90	33.67	23.64	0.2312

* ERP = LVL (dBm) + Correction Factor (dB) - 2.15

S.G. power = 0 (dBm)



WCDMA Band V (RMC 12.2Kbps) Radiated Power ERP							
Horizontal Polarization							
Frequency (MHz)	LVL (dBm)	Tx Cable Loss (dB)	Tx ANT Gain (dBi)	SA Reading (dB)	Correction Factor (dB)	ERP (dBm)	ERP (W)
826.4	-25.02	7.65	0.49	-38.20	31.03	3.86	0.0024
836.4	-25.69	7.69	0.49	-38.98	31.78	3.94	0.0025
846.6	-27.14	7.72	0.50	-39.33	32.10	2.81	0.0019
Vertical Polarization							
Frequency (MHz)	LVL (dBm)	Tx Cable Loss (dB)	Tx ANT Gain (dBi)	SA Reading (dB)	Correction Factor (dB)	ERP (dBm)	ERP (W)
826.4	-10.86	7.65	0.49	-40.56	33.39	20.38	0.1092
836.4	-9.70	7.69	0.49	-39.85	32.65	20.80	0.1202
846.6	-11.10	7.72	0.50	-40.61	33.38	20.13	0.1031

* ERP = LVL (dBm) + Correction Factor (dB) - 2.15

S.G. power = 0 (dBm)



GSM1900 (GPRS class 8) Radiated Power EIRP							
Horizontal Polarization							
Frequency (MHz)	LVL (dBm)	Tx Cable Loss (dB)	Tx ANT Gain (dBi)	SA Reading (dB)	Correction Factor (dB)	EIRP (dBm)	EIRP (W)
1850.2	-16.06	6.35	9.53	-32.47	45.65	29.59	0.9099
1880.0	-15.17	6.40	9.64	-32.59	45.83	30.66	1.1641
1909.8	-15.04	6.46	9.75	-32.61	45.91	30.87	1.2218
Vertical Polarization							
Frequency (MHz)	LVL (dBm)	Tx Cable Loss (dB)	Tx ANT Gain (dBi)	SA Reading (dB)	Correction Factor (dB)	EIRP (dBm)	EIRP (W)
1850.2	-13.14	6.35	9.53	-30.89	44.07	30.93	1.2388
1880.0	-12.96	6.40	9.64	-31.15	44.39	31.43	1.3900
1909.8	-13.27	6.46	9.75	-31.63	44.93	31.66	1.4655

S.G. power = 10 (dBm)

GSM1900 (EDGE class 8) Radiated Power EIRP							
Horizontal Polarization							
Frequency (MHz)	LVL (dBm)	Tx Cable Loss (dB)	Tx ANT Gain (dBi)	SA Reading (dB)	Correction Factor (dB)	EIRP (dBm)	EIRP (W)
1850.2	-20.05	6.35	9.53	-32.42	45.60	25.55	0.3589
1880.0	-19.38	6.40	9.64	-32.62	45.86	26.48	0.4446
1909.8	-18.01	6.46	9.75	-32.69	45.99	27.98	0.6281
Vertical Polarization							
Frequency (MHz)	LVL (dBm)	Tx Cable Loss (dB)	Tx ANT Gain (dBi)	SA Reading (dB)	Correction Factor (dB)	EIRP (dBm)	EIRP (W)
1850.2	-17.45	6.35	9.53	-30.93	44.11	26.66	0.4634
1880.0	-18.21	6.40	9.64	-31.24	44.48	26.27	0.4236
1909.8	-16.70	6.46	9.75	-31.39	44.69	27.99	0.6295

S.G. power = 10 (dBm)



WCDMA Band II (RMC 12.2Kbps) Radiated Power EIRP							
Horizontal Polarization							
Frequency (MHz)	LVL (dBm)	Tx Cable Loss (dB)	Tx ANT Gain (dBi)	SA Reading (dB)	Correction Factor (dB)	EIRP (dBm)	EIRP (W)
1852.4	-21.67	6.35	9.54	-32.51	45.69	24.02	0.2523
1880.0	-20.87	6.40	9.64	-32.69	45.93	25.06	0.3206
1907.6	-20.81	6.45	9.75	-32.74	46.03	25.22	0.3327
Vertical Polarization							
Frequency (MHz)	LVL (dBm)	Tx Cable Loss (dB)	Tx ANT Gain (dBi)	SA Reading (dB)	Correction Factor (dB)	EIRP (dBm)	EIRP (W)
1852.4	-18.25	6.35	9.54	-31.03	44.21	25.96	0.3945
1880.0	-18.42	6.40	9.64	-31.35	44.59	26.17	0.4140
1907.6	-18.58	6.45	9.75	-31.48	44.77	26.19	0.4159

S.G. power = 10 (dBm)



Radiated Spurious Emission

GSM850 (GPRS class 8)									
Channel	Frequency (MHz)	ERP (dBm)	Limit (dBm)	Over Limit (dB)	SPA Reading (dBm)	S.G. Power (dBm)	TX Cable loss (dB)	TX Antenna Gain (dBi)	Polarization (H/V)
Lowest	1648	-46.77	-13	-33.77	-27.19	-48.53	0.98	4.89	H
	2472	-61.23	-13	-48.23	-45.6	-63.11	1.28	5.32	H
	3296	-68.53	-13	-55.53	-55.5	-71.94	1.54	7.10	H
	1648	-50.05	-13	-37.05	-31.39	-51.81	0.98	4.89	V
	2472	-59.71	-13	-46.71	-43.67	-61.59	1.28	5.32	V
	3296	-68.47	-13	-55.47	-54.77	-71.88	1.54	7.10	V
Middle	1672	-41.14	-13	-28.14	-21.69	-42.82	0.99	4.82	H
	2512	-51.84	-13	-38.84	-35.48	-53.81	1.29	5.41	H
	3344	-68.98	-13	-55.98	-55.67	-72.59	1.56	7.31	H
	1672	-46.39	-13	-33.39	-6.88	-48.07	0.99	4.82	V
	2512	-52.28	-13	-39.28	-37.28	-54.25	1.29	5.41	V
	3344	-68.30	-13	-55.30	-55.22	-71.91	1.56	7.31	V
Highest	1696	-42.42	-13	-29.42	-23.16	-44.02	1.00	4.75	H
	2544	-56.16	-13	-43.16	-40.77	-58.14	1.30	5.44	H
	3392	-68.71	-13	-55.71	-55.5	-72.51	1.57	7.52	H
	1696	-48.68	-13	-35.68	-29.13	-50.28	1.00	4.75	V
	2544	-53.51	-13	-40.51	-38.2	-55.49	1.30	5.44	V
	3392	-68.03	-13	-55.03	-55.16	-71.83	1.57	7.52	V

Remark: Spurious emissions within 30-1000MHz were found more than 20dB below limit line.



GSM850 (EDGE class 8)									
Channel	Frequency (MHz)	ERP (dBm)	Limit (dBm)	Over Limit (dB)	SPA Reading (dBm)	S.G. Power (dBm)	TX Cable loss (dB)	TX Antenna Gain (dBi)	Polarization (H/V)
Lowest	1648	-46.29	-13	-33.29	-26.86	-48.05	0.98	4.89	H
	2472	-59.67	-13	-46.67	-43.38	-61.55	1.28	5.32	H
	3296	-67.23	-13	-54.23	-54.03	-70.64	1.54	7.10	H
	1648	-49.48	-13	-36.48	-30.37	-51.24	0.98	4.89	V
	2472	-58.99	-13	-45.99	-42.36	-60.87	1.28	5.32	V
	3296	-67.68	-13	-54.68	-54.07	-71.09	1.54	7.10	V
Middle	1672	-44.61	-13	-31.61	-25.34	-46.29	0.99	4.82	H
	2512	-55.04	-13	-42.04	-39.27	-57.01	1.29	5.41	H
	3344	-68.25	-13	-55.25	-55.34	-71.86	1.56	7.31	H
	1672	-49.15	-13	-36.15	-30.14	-50.83	0.99	4.82	V
	2512	-56.65	-13	-43.65	-41.2	-58.62	1.29	5.41	V
	3344	-67.86	-13	-54.86	-54.69	-71.47	1.56	7.31	V
Highest	1696	-44.21	-13	-31.21	-24.69	-45.81	1.00	4.75	H
	2544	-57.24	-13	-44.24	-41.38	-59.22	1.30	5.44	H
	3392	-66.54	-13	-53.54	-53.76	-70.34	1.57	7.52	H
	1696	-49.83	-13	-36.83	-30.48	-51.43	1.00	4.75	V
	2544	-58.42	-13	-45.42	-41.02	-60.4	1.30	5.44	V
	3392	-68.82	-13	-55.82	-53.18	-72.62	1.57	7.52	V

Remark: Spurious emissions within 30-1000MHz were found more than 20dB below limit line.



GSM1900 (GPRS class 8)									
Channel	Frequency (MHz)	EIRP (dBm)	Limit (dBm)	Over Limit (dB)	SPA Reading (dBm)	S.G. Power (dBm)	TX Cable loss (dB)	TX Antenna Gain (dBi)	Polarization (H/V)
Lowest	3700	-61.37	-13	-48.37	-49.54	-67.94	1.67	8.24	H
	5548	-41.80	-13	-28.80	-37.4	-48.87	2.65	9.72	H
	9251	-58.71	-13	-45.71	-60.3	-68.77	2.54	12.60	H
	3700	-62.29	-13	-49.29	-50.34	-68.86	1.67	8.24	V
	5548	-41.62	-13	-28.62	-36.22	-48.69	2.65	9.72	V
	7400	-53.94	-13	-40.94	-54.63	-63.08	2.46	11.60	V
Middle	3763	-61.08	-13	-48.08	-49.59	-67.71	1.69	8.32	H
	5639	-30.00	-13	-17.00	-25.79	-37.05	2.71	9.76	H
	9398	-54.80	-13	-41.80	-56.62	-64.77	2.57	12.54	H
	3763	-62.14	-13	-49.14	-50.53	-68.77	1.69	8.32	V
	5639	-40.32	-13	-27.32	-35.09	-47.37	2.71	9.76	V
	9398	-52.53	-13	-39.53	-53.21	-62.5	2.57	12.54	V
Highest	3819	-61.10	-13	-48.10	-49.75	-67.78	1.70	8.38	H
	5730	-25.73	-13	-12.73	-21.71	-32.76	2.76	9.79	H
	9552	-41.03	-13	-28.03	-42.9	-50.9	2.60	12.47	H
	11463	-54.83	-13	-41.83	-59.89	-64.46	2.68	12.31	H
	3819	-60.63	-13	-47.63	-49.26	-67.31	1.70	8.38	V
	5730	-27.32	-13	-14.32	-22.26	-34.35	2.76	9.79	V
	9552	-43.37	-13	-30.37	-44.03	-53.24	2.60	12.47	V
	11463	-57.61	-13	-44.61	-63.06	-67.24	2.68	12.31	V

Remark: Spurious emissions within 30-1000MHz were found more than 20dB below limit line.



GSM1900 (EDGE class 8)									
Channel	Frequency (MHz)	EIRP (dBm)	Limit (dBm)	Over Limit (dB)	SPA Reading (dBm)	S.G. Power (dBm)	TX Cable loss (dB)	TX Antenna Gain (dBi)	Polarization (H/V)
Lowest	3700	-61.49	-13	-48.49	-49.66	-68.06	1.67	8.24	H
	5548	-32.59	-13	-19.59	-28.19	-39.66	2.65	9.72	H
	9251	-54.50	-13	-41.50	-56.19	-64.56	2.54	12.60	H
	3700	-60.26	-13	-47.26	-48.31	-66.83	1.67	8.24	V
	5548	-34.34	-13	-21.34	-28.94	-41.41	2.65	9.72	V
	9251	-53.10	-13	-40.10	-53.81	-63.16	2.54	12.60	V
Middle	3763	-60.52	-13	-47.52	-49.03	-67.15	1.69	8.32	H
	5639	-31.91	-13	-18.91	-27.7	-38.96	2.71	9.76	H
	9398	-52.84	-13	-39.84	-54.66	-62.81	2.57	12.54	H
	3763	-63.72	-13	-50.72	-52.11	-70.35	1.69	8.32	V
	5639	-34.28	-13	-21.28	-29.05	-41.33	2.71	9.76	V
	9398	-53.08	-13	-40.08	-53.76	-63.05	2.57	12.54	V
Highest	3819	-62.38	-13	-49.38	-51.43	-69.06	1.70	8.38	H
	5730	-36.44	-13	-23.44	-32.41	-43.47	2.76	9.79	H
	9552	-55.92	-13	-42.92	-57.79	-65.79	2.60	12.47	H
	3819	-65.59	-13	-52.59	-54.22	-72.27	1.70	8.38	V
	5730	-36.48	-13	-23.48	-31.42	-43.51	2.76	9.79	V
	9552	-51.03	-13	-38.03	-51.69	-60.9	2.60	12.47	V

Remark: Spurious emissions within 30-1000MHz were found more than 20dB below limit line.



WCDMA Band V(RMC 12.2Kbps)									
Channel	Frequency (MHz)	ERP (dBm)	Limit (dBm)	Over Limit (dB)	SPA Reading (dBm)	S.G. Power (dBm)	TX Cable loss (dB)	TX Antenna Gain (dBi)	Polarization (H/V)
Lowest	1652	-59.49	-13	-46.49	-40.13	-61.23	0.98	4.87	H
	2478	-68.62	-13	-55.62	-52.44	-70.52	1.28	5.33	H
	3304	-69.87	-13	-56.87	-55.94	-73.31	1.54	7.14	H
	1652	-62.74	-13	-49.74	-43.06	-64.48	0.98	4.87	V
	2478	-68.23	-13	-55.23	-52.37	-70.13	1.28	5.33	V
	3304	-68.15	-13	-55.15	-55.25	-71.59	1.54	7.14	V
Middle	1672	-54.45	-13	-41.45	-34.99	-56.13	0.99	4.82	H
	2512	-70.11	-13	-57.11	-54.13	-72.08	1.29	5.41	H
	3344	-69.90	-13	-56.90	-56	-73.51	1.56	7.31	H
	1672	-57.58	-13	-44.58	-38.58	-59.26	0.99	4.82	V
	2512	-68.08	-13	-55.08	-53.17	-70.05	1.29	5.41	V
	3344	-68.23	-13	-55.23	-55.26	-71.84	1.56	7.31	V
Highest	1696	-55.56	-13	-42.56	-36.3	-57.16	1.00	4.75	H
	2544	-70.11	-13	-57.11	-54.39	-72.09	1.30	5.44	H
	3392	-68.43	-13	-55.43	-55.86	-72.23	1.57	7.52	H
	1696	-57.87	-13	-44.87	-38.64	-59.47	1.00	4.75	V
	2544	-68.06	-13	-55.06	-53.42	-70.04	1.30	5.44	V
	3392	-68.75	-13	-55.75	-55.03	-72.55	1.57	7.52	V

Remark: Spurious emissions within 30-1000MHz were found more than 20dB below limit line.



WCDMA Band II(RMC 12.2Kbps)									
Channel	Frequency (MHz)	EIRP (dBm)	Limit (dBm)	Over Limit (dB)	SPA Reading (dBm)	S.G. Power (dBm)	TX Cable loss (dB)	TX Antenna Gain (dBi)	Polarization (H/V)
Lowest	3700	-65.00	-13	-52.00	-53.17	-71.57	1.67	8.24	H
	5562	-42.07	-13	-29.07	-37.67	-49.13	2.66	9.72	H
	7417	-60.82	-13	-47.82	-60.55	-70	2.46	11.63	H
	3700	-65.74	-13	-52.74	-53.79	-72.31	1.67	8.24	V
	5562	-45.59	-13	-32.59	-40.19	-52.65	2.66	9.72	V
	7417	-61.40	-13	-48.40	-60.52	-70.58	2.46	11.63	V
Middle	3763	-65.48	-13	-52.48	-53.91	-72.11	1.69	8.32	H
	5646	-48.01	-13	-35.01	-43.8	-55.06	2.71	9.76	H
	7529	-61.04	-13	-48.04	-61	-70.44	2.42	11.82	H
	3763	-67.04	-13	-54.04	-55.43	-73.67	1.69	8.32	V
	5646	-51.96	-13	-38.96	-46.73	-59.01	2.71	9.76	V
	7529	-61.85	-13	-48.85	-61.2	-71.25	2.42	11.82	V
Highest	3812	-63.65	-13	-50.65	-52.32	-70.32	1.70	8.37	H
	5723	-50.01	-13	-37.01	-45.99	-57.05	2.75	9.79	H
	9545	-58.69	-13	-45.69	-60.56	-68.56	2.60	12.47	H
	3812	-63.47	-13	-50.47	-52.02	-70.14	1.70	8.37	V
	5723	-54.20	-13	-41.20	-49.14	-61.24	2.75	9.79	V
	9545	-57.41	-13	-44.41	-57.97	-67.28	2.60	12.47	V

Remark: Spurious emissions within 30-1000MHz were found more than 20dB below limit line.